



FCC Parts 22 and 24 Test Report

For

850/900/1800/1900 MHz GSM/EDGE PC CARD
WIRELESS MODEM

Model: AIRCARD 775

FCC ID: N7NAC775

**Prepared by
SIERRA WIRELESS INC.
13811 WIRELESS WAY
RICHMOND, BC V6V 3A4
CANADA**

Test Date(s): May 20, 2004

© 2004 Sierra Wireless, Inc.

This document contains information which is proprietary and confidential to Sierra Wireless, Inc. Disclosure to persons other than the officers, employees, agents, or subcontractors of the Company or licensee of this document without the prior written permission of Sierra Wireless, Inc. is strictly prohibited.

SIERRA WIRELESS, INC.

FCC Part 22 & 24 Test Report	AC775	May 20, 2004	Page 2 of 60
------------------------------	-------	--------------	--------------

Table of Contents

1	Introduction and Purpose	3
2	Test Summary	3
3	Description of Equipment Under Test	4
4	RF Power Output	5
4.1	<i>Test Procedure</i>	5
4.2	<i>Test Equipment</i>	5
4.3	<i>Test Results</i>	6
5	Occupied Bandwidth	7
5.1	<i>Test Procedure</i>	7
5.2	<i>Test Results</i>	7
5.3	<i>Test Plots</i>	8
6	Out of Band Emissions at Antenna Terminals	20
6.1	<i>Test Procedure</i>	20
6.2	<i>Test Equipment</i>	20
6.3	<i>Test Results</i>	21
6.4	<i>Test Plots</i>	22
7	Block Edge Compliance	49
7.1	<i>Test Procedure</i>	49
7.2	<i>Test Equipment</i>	49
7.3	<i>Test Results</i>	50
7.4	<i>Test Plots</i>	51
8	Frequency Stability Versus Temperature	55
8.1	<i>Summary of Results</i>	55
8.2	<i>Test Procedure</i>	55
8.3	<i>Test Equipment</i>	55
8.4	<i>Test Results</i>	56
9	Frequency Stability Versus Voltage	58
9.1	<i>Summary of Results</i>	58
9.2	<i>Test Procedure</i>	58
9.3	<i>Test Equipment</i>	58
9.4	<i>Test Results</i>	59

SIERRA WIRELESS, INC.

FCC Part 22 & 24 Test Report	AC775	May 20, 2004	Page 3 of 60
------------------------------	-------	--------------	--------------

1 Introduction and Purpose

This document provides the FCC test data for the AC755 wireless modem. The tests included in this report are limited to all conducted tests required. The radiated tests were performed at an external test facility.

2 Test Summary

FCC RULE	DESCRIPTION OF TEST	RESULT	PAGE
2.1046	RF Power Output	Complies	5
2.1049	Occupied Bandwidth	Complies	7
2.1051, 22.901(d) 22.917, 24.238(a)	Out of Band Emissions at Antenna Terminals	Complies	20
FCC part 22H/24E	Block Edge Requirements	Complies	49
2.1053	Field Strength of Spurious Radiation	Complies	See CCS Report
2.1055	Frequency Stability versus Temperature	Complies	55
2.1055	Frequency Stability versus Voltage	Complies	58

The tests described in this report were performed by Mr. Darryl Simpson at:

Sierra Wireless, Inc.
13811 Wireless Way
Richmond, B.C. V6V 3A4
Canada

SIERRA WIRELESS, INC.

FCC Part 22 & 24 Test Report	AC775	May 20, 2004	Page 4 of 60
------------------------------	-------	--------------	--------------

3 Description of Equipment Under Test

The Sierra Wireless Inc. model AirCard 775 is a quad-band PCMCIA card wireless modem operating on the GSM/GPRS/EDGE network. In the US and Canada, only cellular and PCS bands are used for GSM/GPRS operation, so this test report only contains data for these two bands (850MHz and 1900MHz). The EUT was tested in both modes of operation: GMSK modulation and 8-PSK modulation. The EUT is a production sample and the serial number is:

S040405000700E3



© 2004 Sierra Wireless, Inc.

The contents of this page are subject to the confidentiality information on page one.

4 RF Power Output

FCC 2.1046

4.1 Test Procedure

The transmitter output was connected to a Rohde & Schwarz CMU200 Test Set and configured to operate at maximum power. The power was measured at three equally spaced operating frequencies in each band and the RBW was set at 300 KHz.

Test Setup

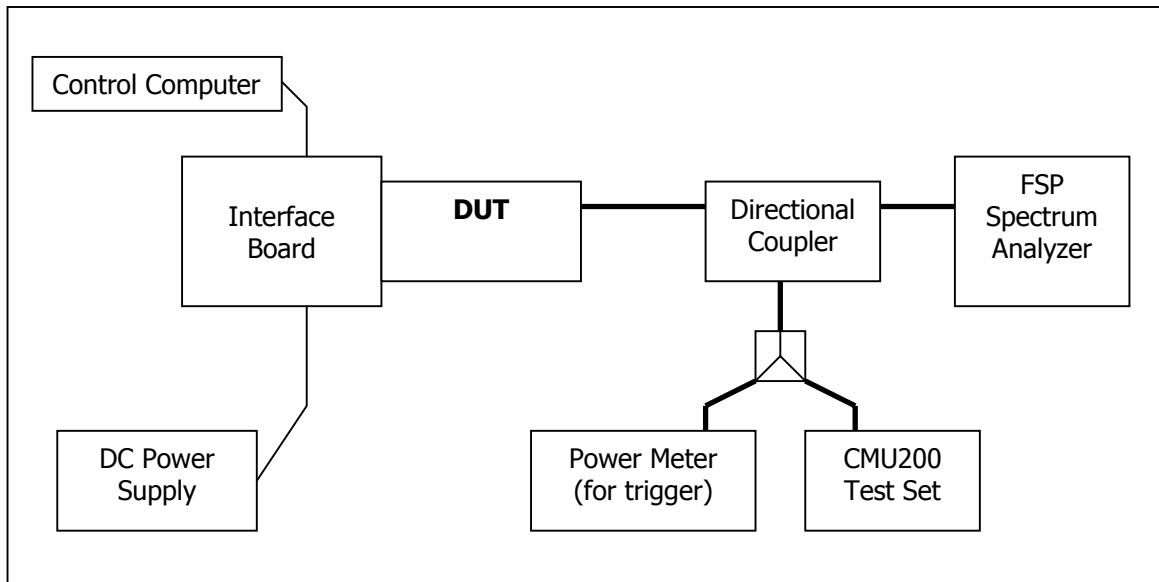

4.2 Test Equipment

Instrument List

EQUIPMENT	MANUFACTURER	MODEL NO.	SERIAL NO.	CAL. DATE
Control Computer	TC	Generic PC	100488	N/A
Wireless Test Set	Rohde & Schwarz	CMU200	836766/030	N/A
Spectrum Analyzer	Rohde & Schwarz	FSP 30GHz	US41421268	Sept. 12, 2003
DC Power Supply	HP	E3631A	100060	N/A
Interface Board	Shop built	Minnow	N/A	N/A
Directional Coupler	Pasternack	PE2209-10	N/A	N/A

SIERRA WIRELESS, INC.

4.3 Test Results

Frequency (MHz)	Channel	Power (dBm)	
		GMSK Mode	8-PSK Mode
824.2	128	31.43	26.84
836.6	190	31.44	26.89
848.8	251	31.38	26.79
1850.2	512	28.35	25.83
1880.0	661	28.41	25.94
1909.8	810	28.37	25.81

5 Occupied Bandwidth

FCC 2.1049

5.1 Test Procedure

The transmitter output was connected to a calibrated coaxial cable, the other end of which was connected to a spectrum analyzer. The occupied bandwidth (defined as the 99% Power Bandwidth) was measured with the Spectrum Analyzer at the center frequency of each band. The -26dB bandwidth was also measured and recorded.

Test Setup

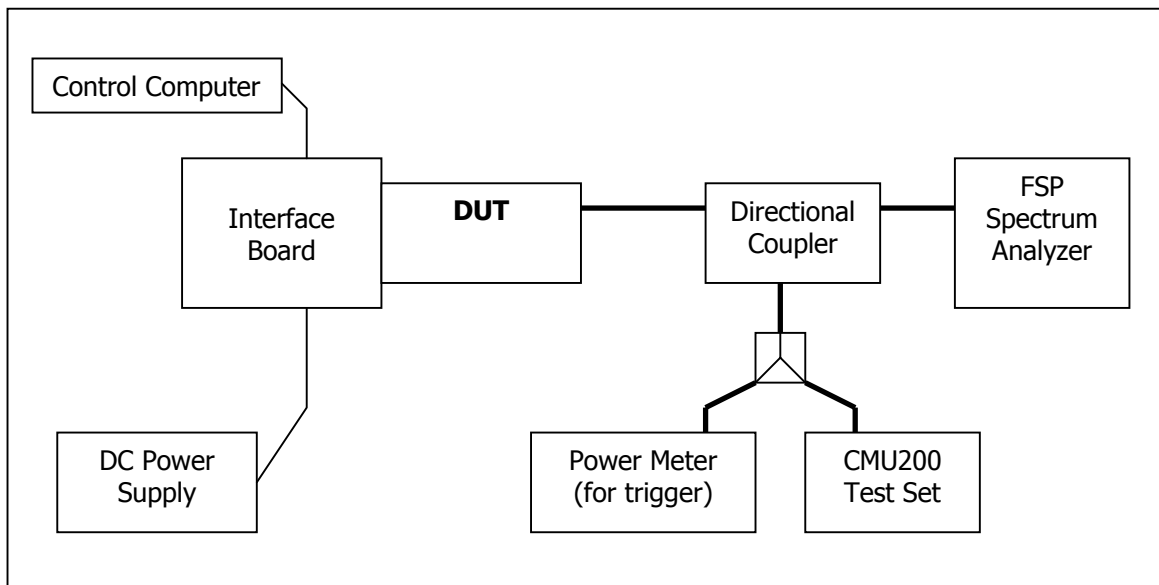

5.2 Test Results

The performance of 800 MHz cellular band is shown in plots 5.3.1 to 5.3.12.

Performance of 1900 MHz PCS band is shown in plots 5.3.13 to 5.3.24.

Frequency (MHz)	Channel	99% Occupied Bandwidth (kHz)		-26dBc Occupied Bandwidth (kHz)	
		GMSK Mode	8-PSK Mode	GMSK Mode	8-PSK Mode
824.2	128	238	232	318	314
836.6	190	242	240	312	298
848.8	251	240	240	324	308
1850.2	512	238	242	326	310
1880.0	661	238	238	314	304
1909.8	810	238	238	318	306

5.3 Test Plots

5.3.1) GSMK Occupied Bandwidth, Cellular Low channel, 824.2 MHz, 99% bandwidth

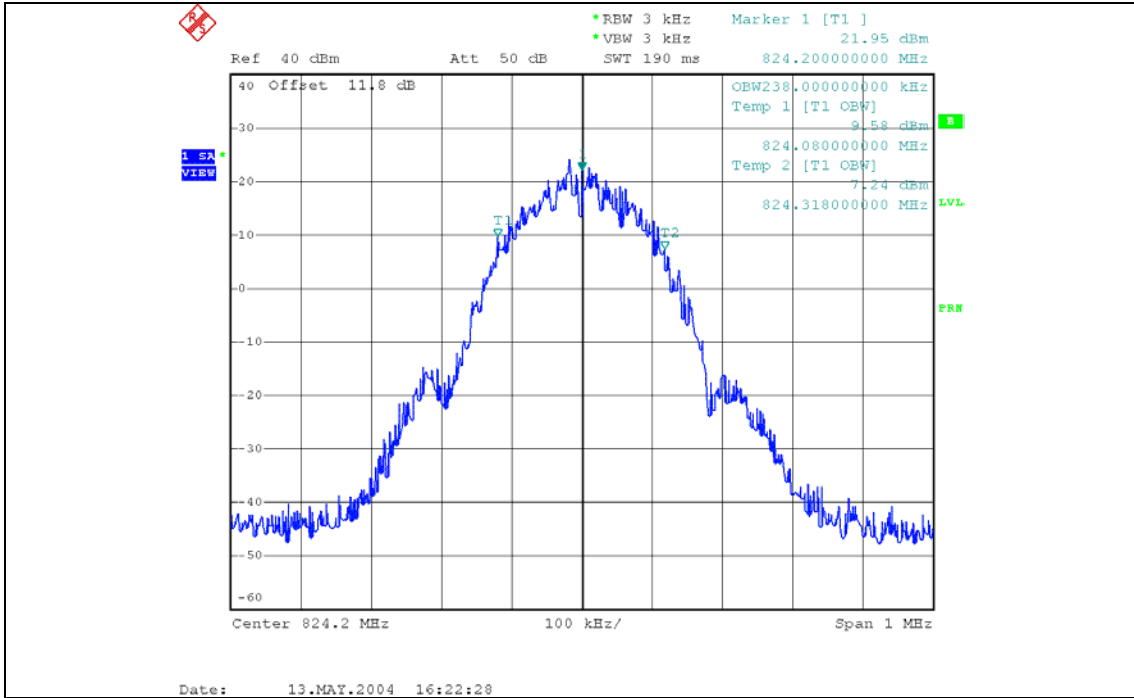

5.3.2) GSMK Occupied Bandwidth, Low channel, 824.2 MHz, -26dBc bandwidth

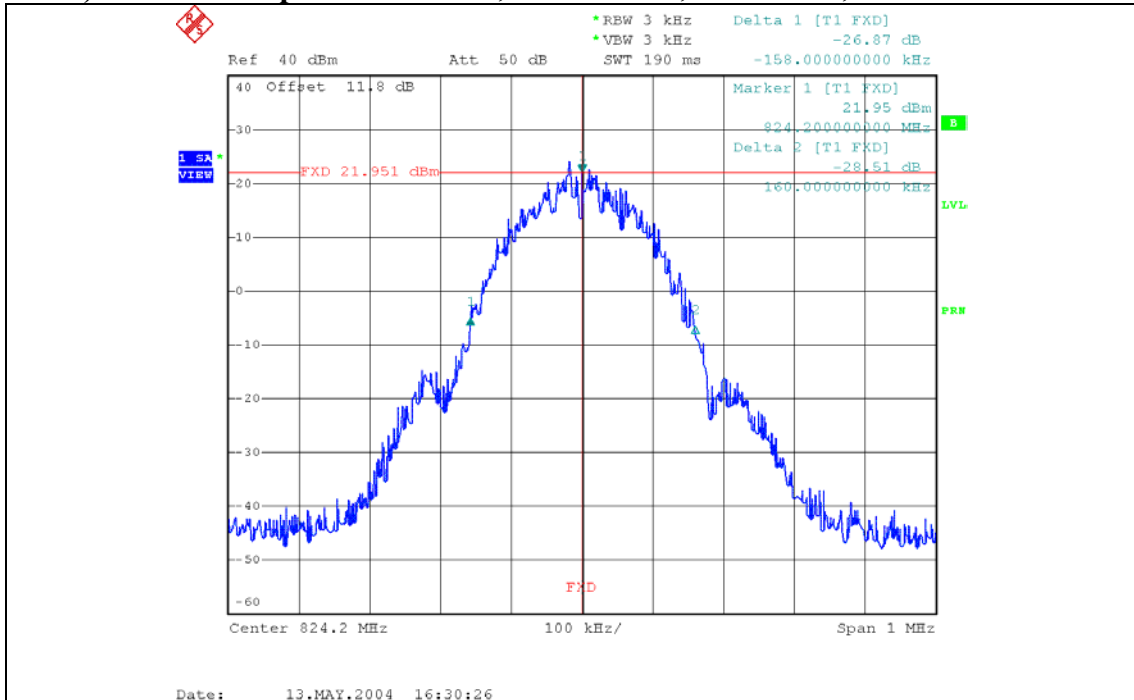

5.3.3) GMSK Occupied Bandwidth, Middle channel, 836.6 MHz, 99% bandwidth

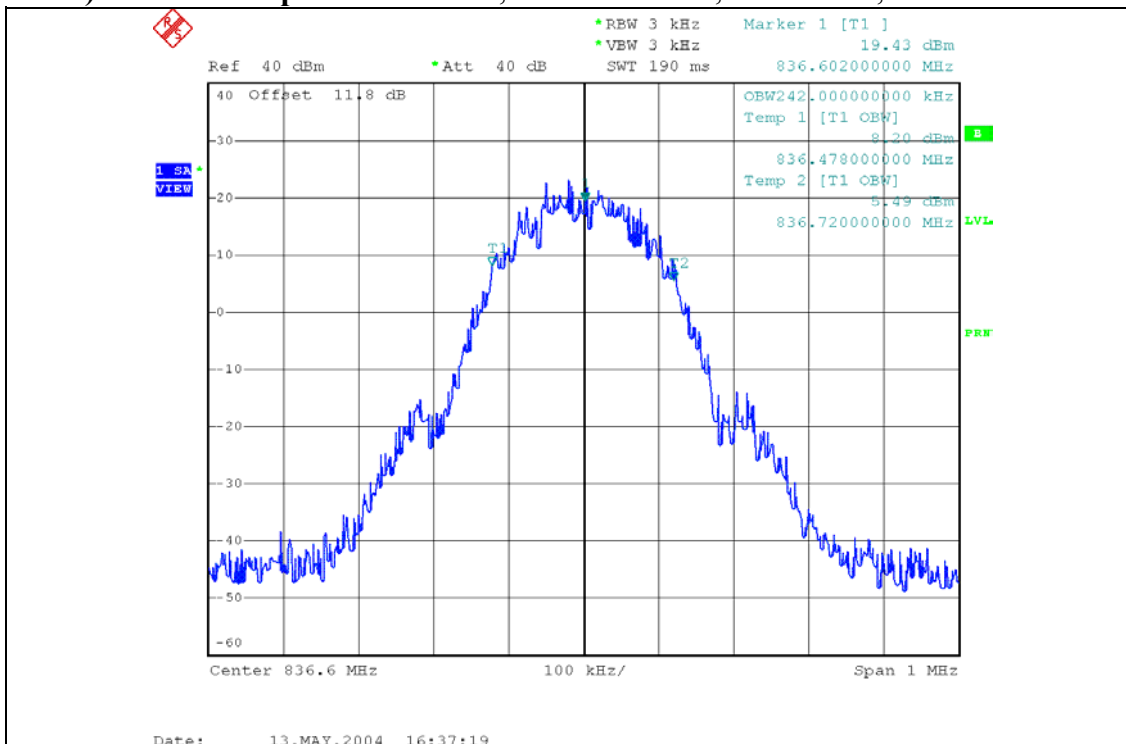

5.3.4) GMSK Occupied Bandwidth, Middle channel, 836.6 MHz, -26dBc bandwidth

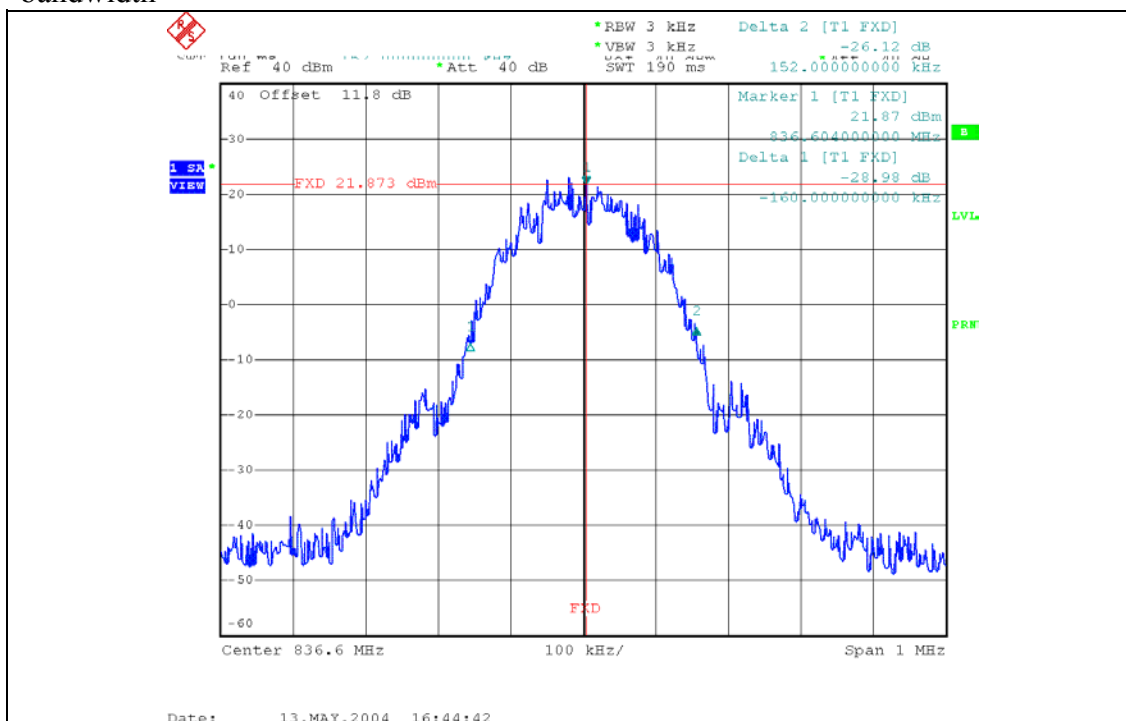

5.3.5) GMSK Occupied Bandwidth, High channel, 848.8 MHz, 99% bandwidth

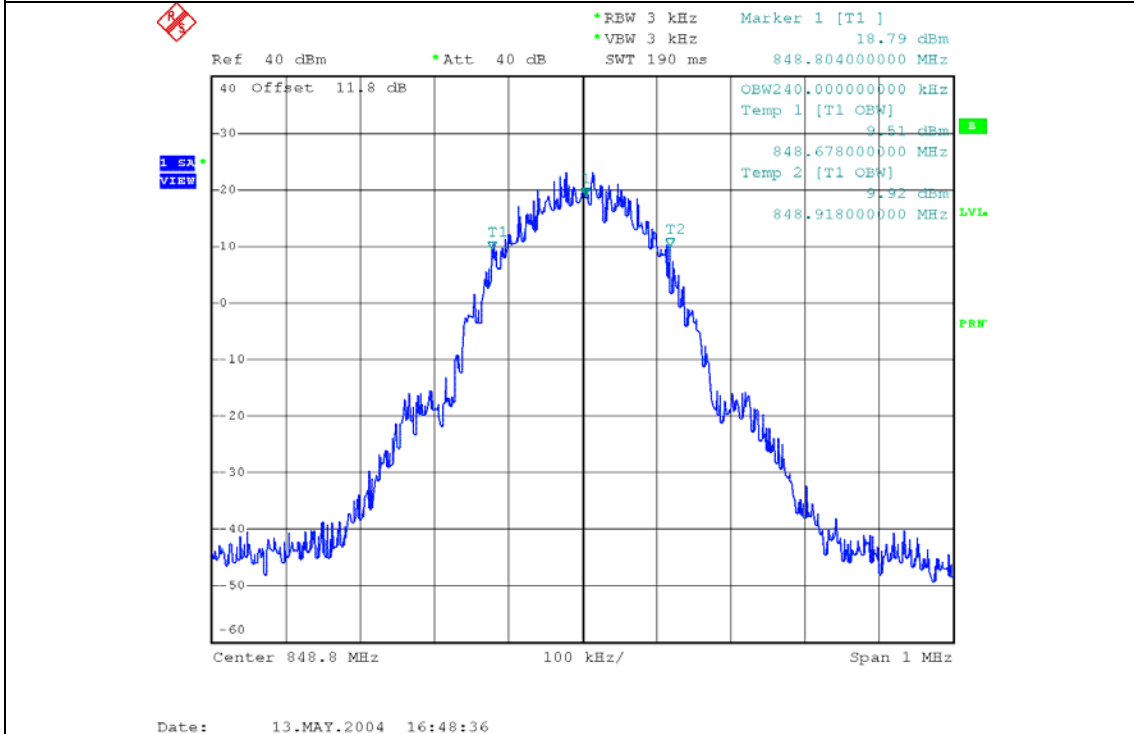

5.3.6) GMSK Occupied Bandwidth, High channel, 848.8 MHz, -26dBc bandwidth

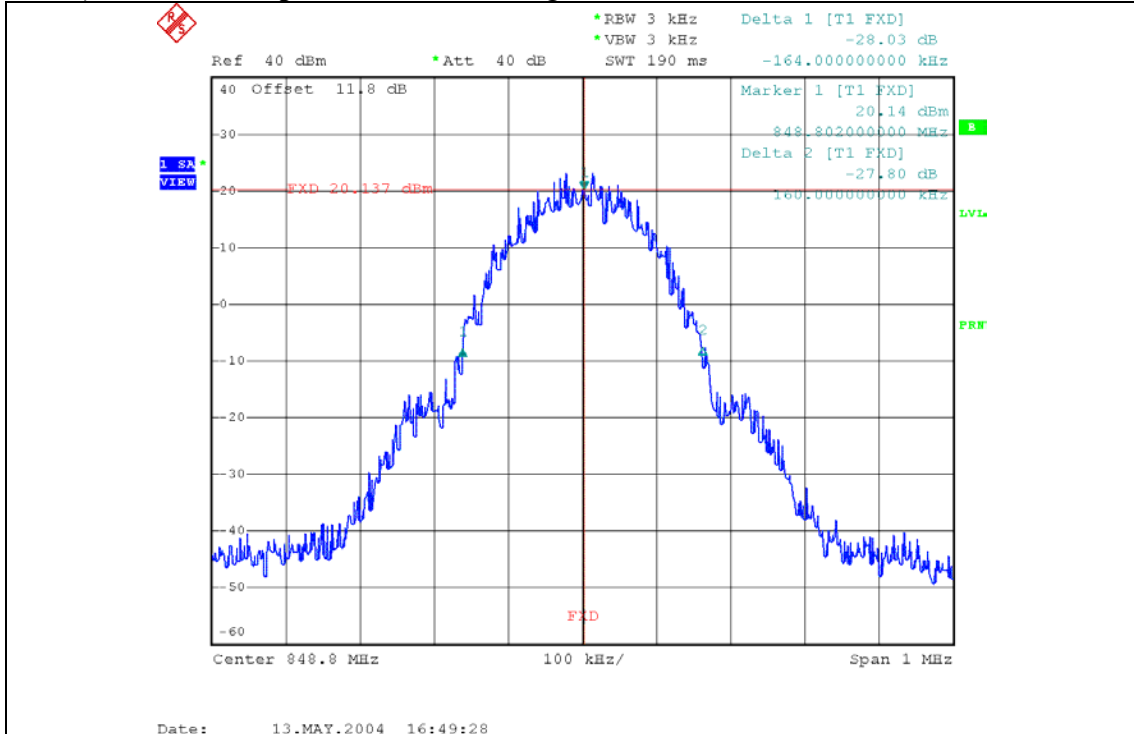

SIERRA WIRELESS, INC.

5.3.7) 8-PSK Occupied Bandwidth, Cellular Low channel, 824.2 MHz, 99% bandwidth

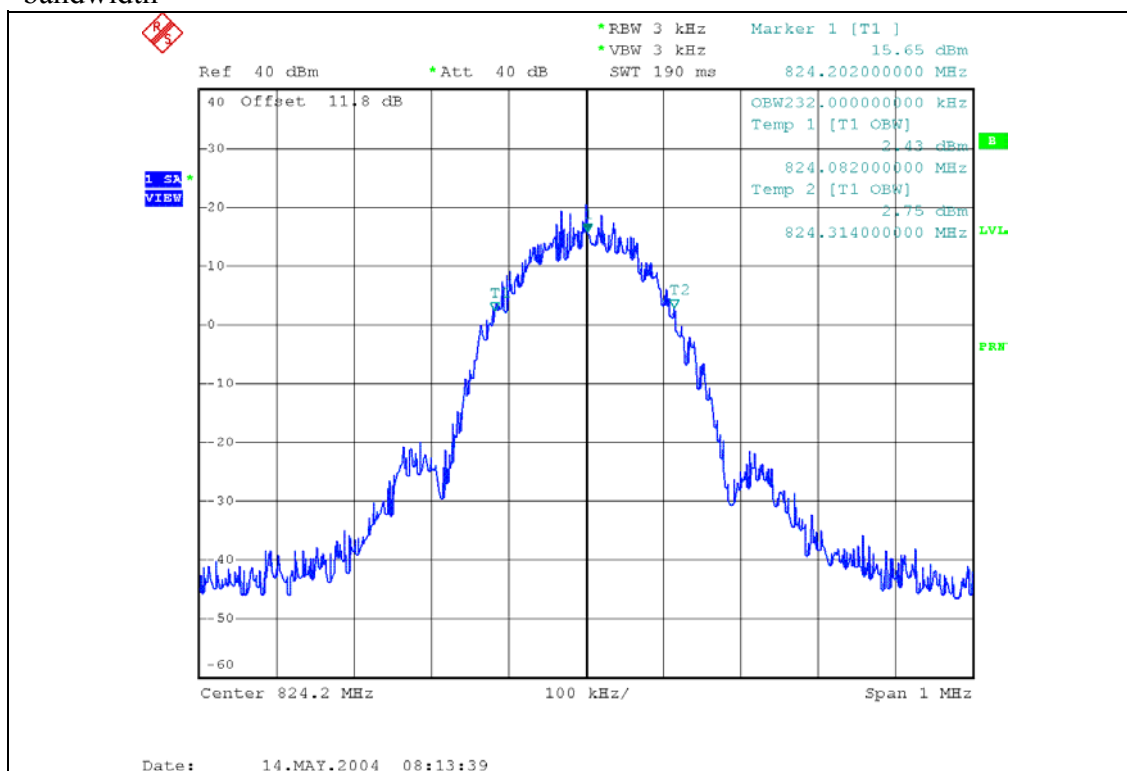

5.3.8) 8-PSK Occupied Bandwidth, Low channel, 824.2 MHz, -26dBc bandwidth

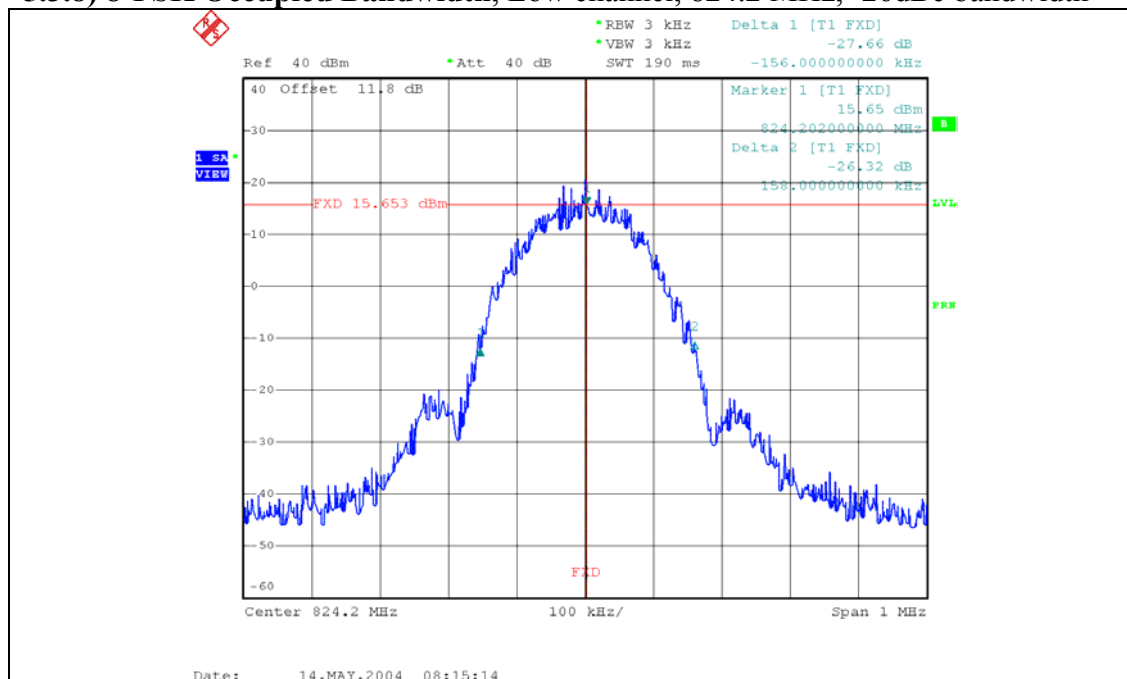

5.3.9) 8-PSK Occupied Bandwidth, Middle channel, 836.6 MHz, 99% bandwidth

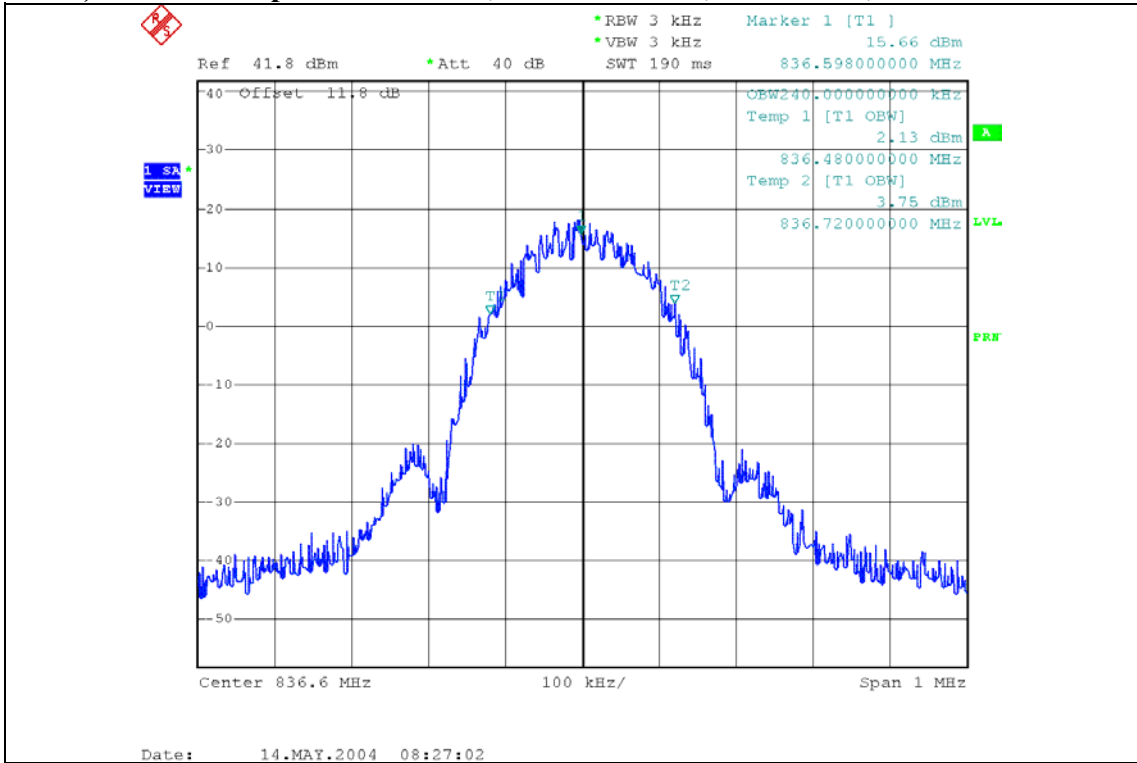

5.3.10) 8-PSK Occupied Bandwidth, Middle channel, 836.6 MHz, -26dBc bandwidth

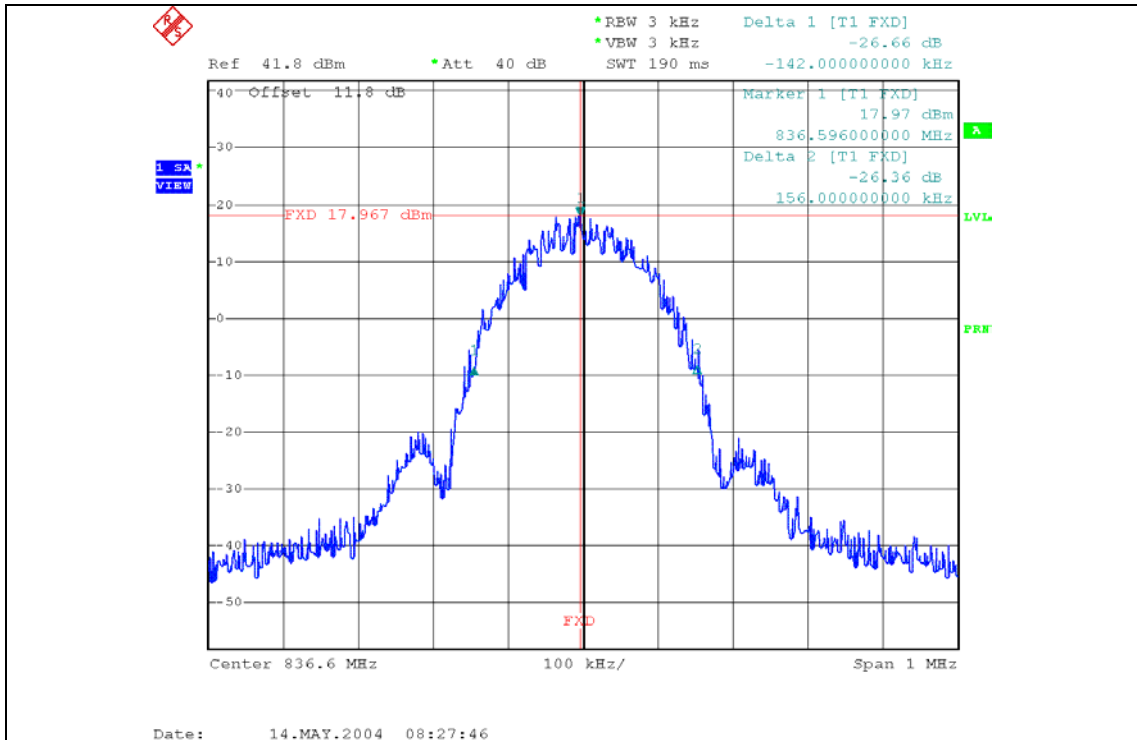

5.3.11) 8-PSK Occupied Bandwidth, High channel, 848.8 MHz, 99% bandwidth

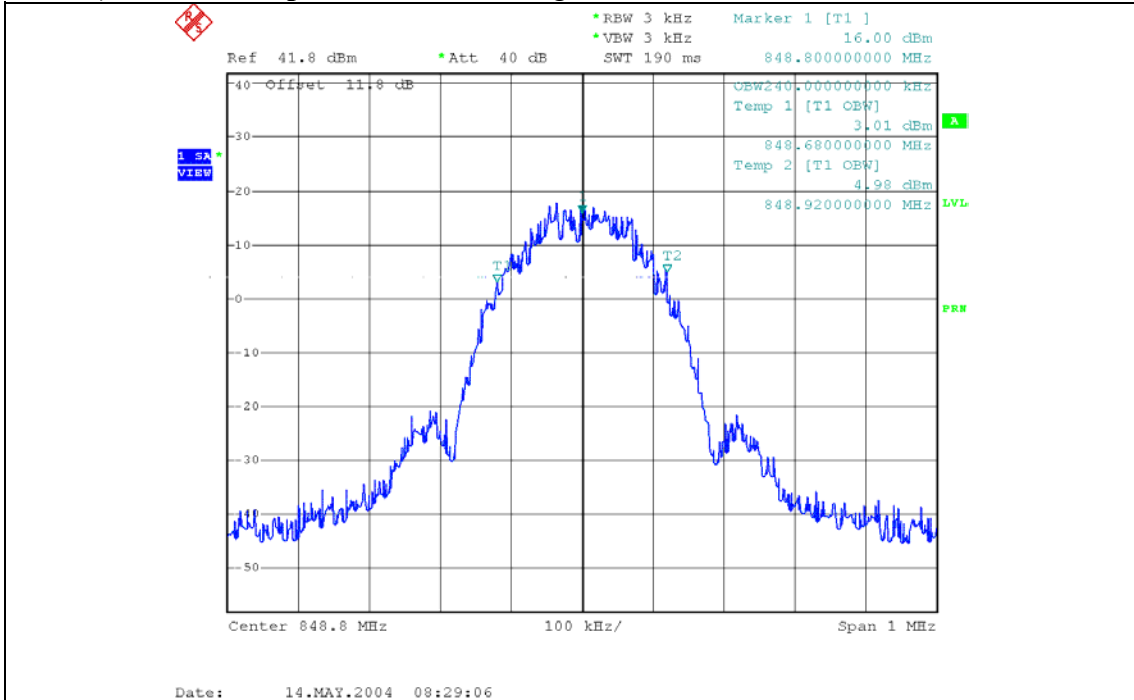

5.3.12) 8-PSK Occupied Bandwidth, High channel, 848.8 MHz, -26dBc bandwidth

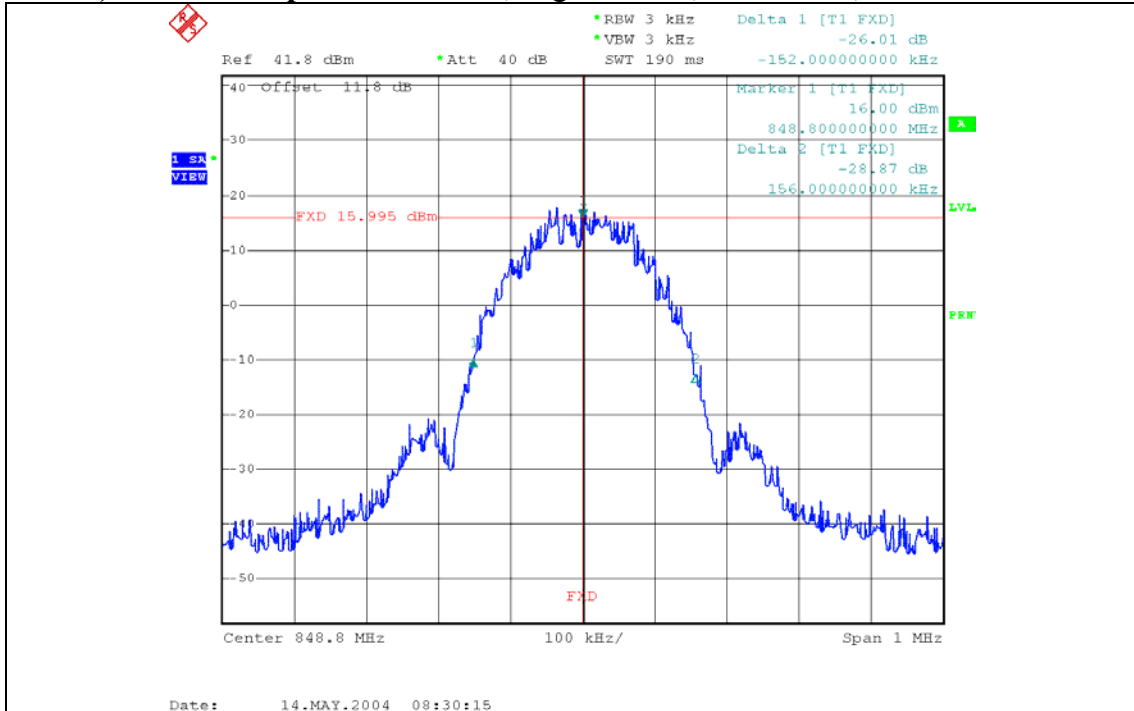

5.3.13) GSMK Occupied Bandwidth, PCS Low channel, 1850.2 MHz, 99% bandwidth

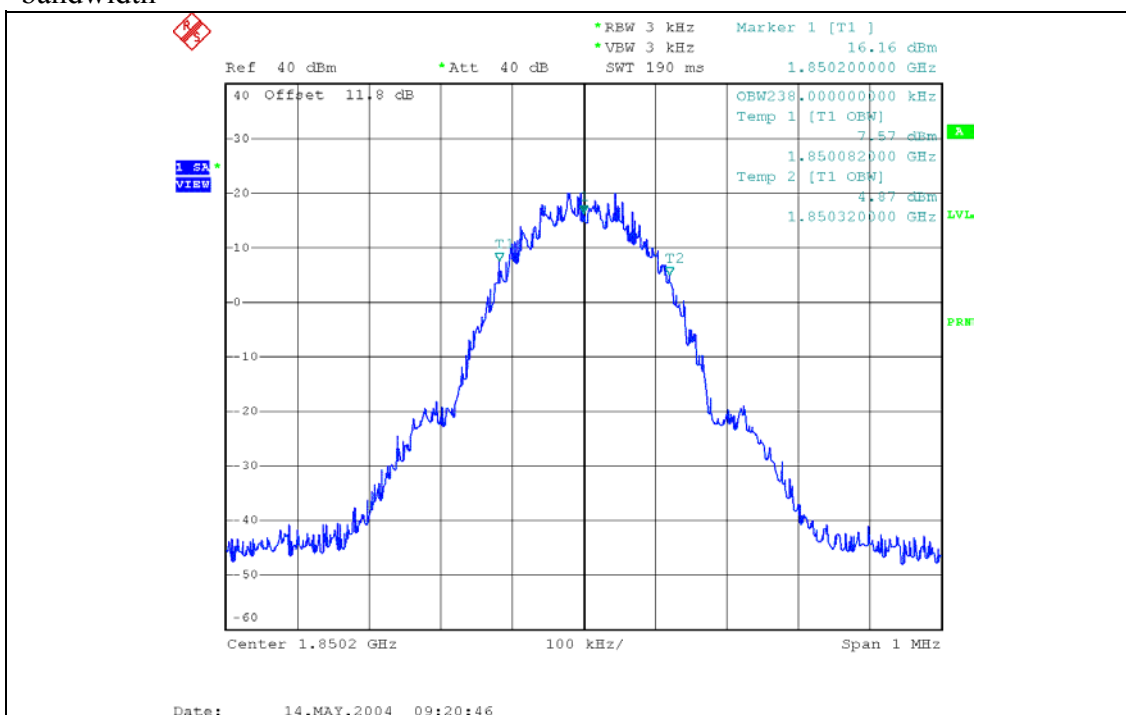

5.3.14) GSMK Occupied Bandwidth, PCS Low channel, 1850.2 MHz, -26dBc bandwidth

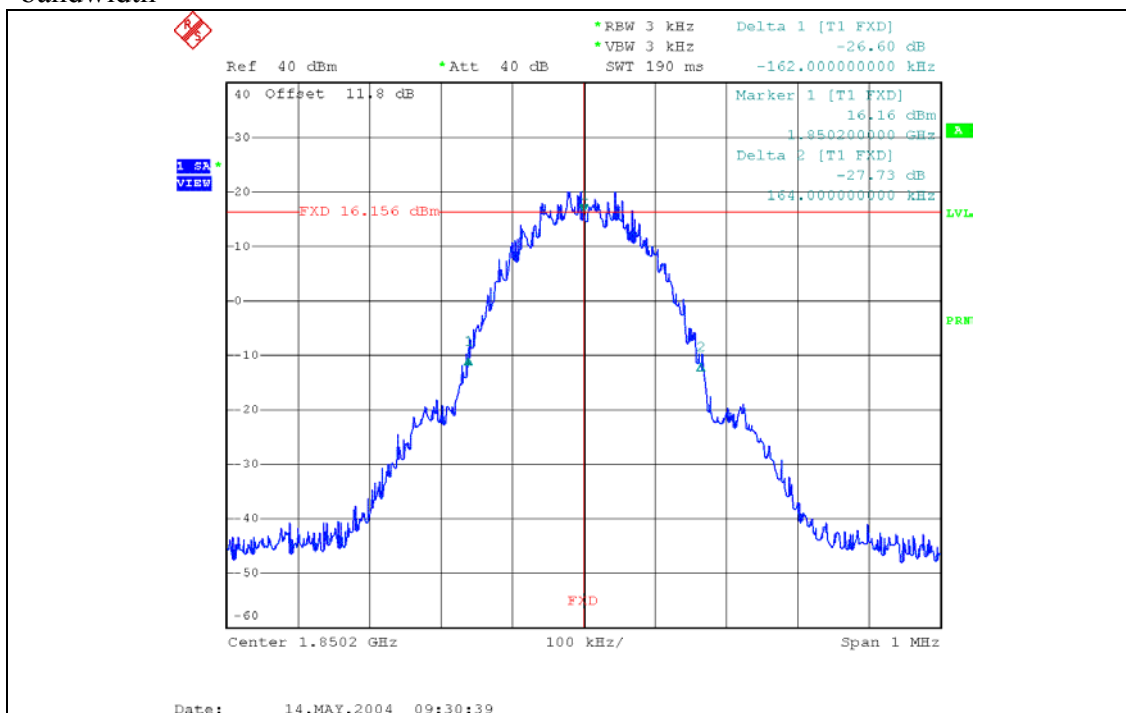

5.3.15) GMSK Occupied Bandwidth, PCS Middle channel, 1880.0 MHz, 99% bandwidth

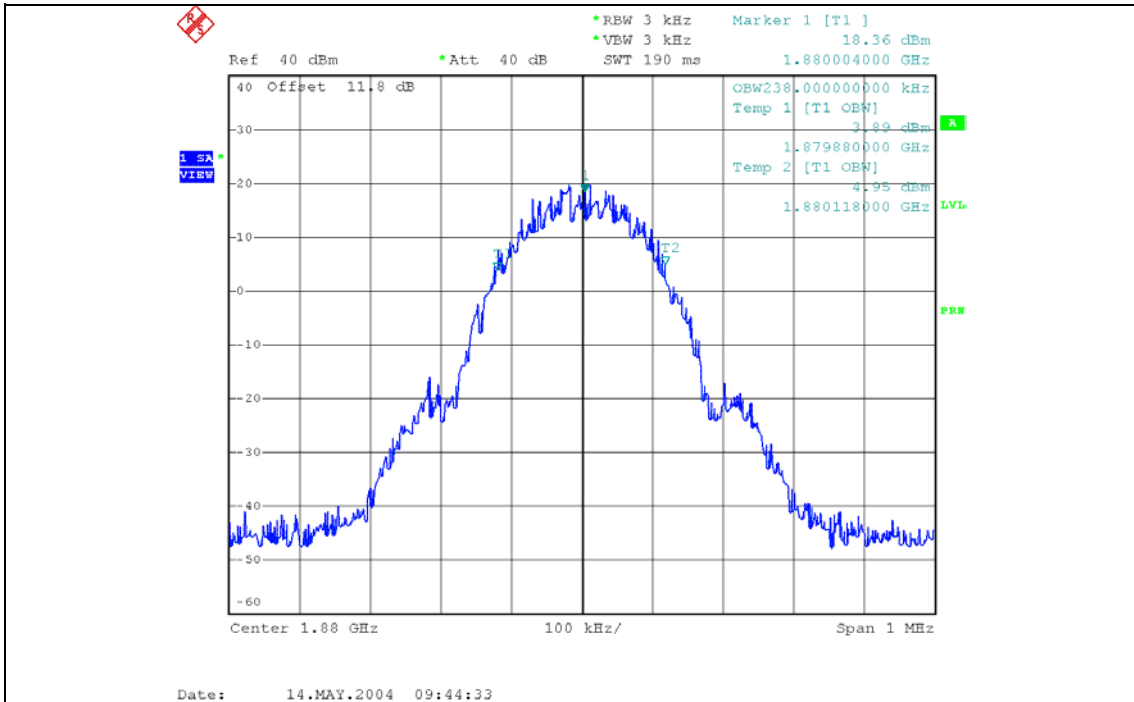

5.3.16) GMSK Occupied Bandwidth, PCS Middle channel, 1880.0 MHz, -26dBc bandwidth

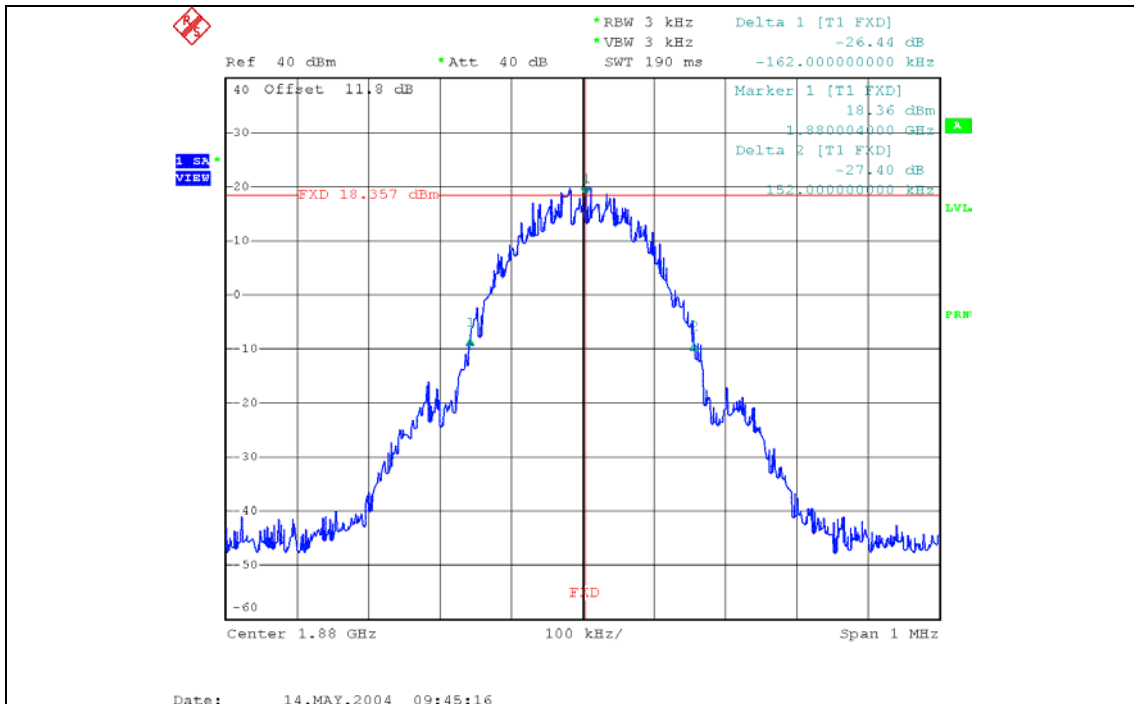

5.3.17) GMSK Occupied Bandwidth, PCS High channel, 1909.8 MHz, 99% bandwidth

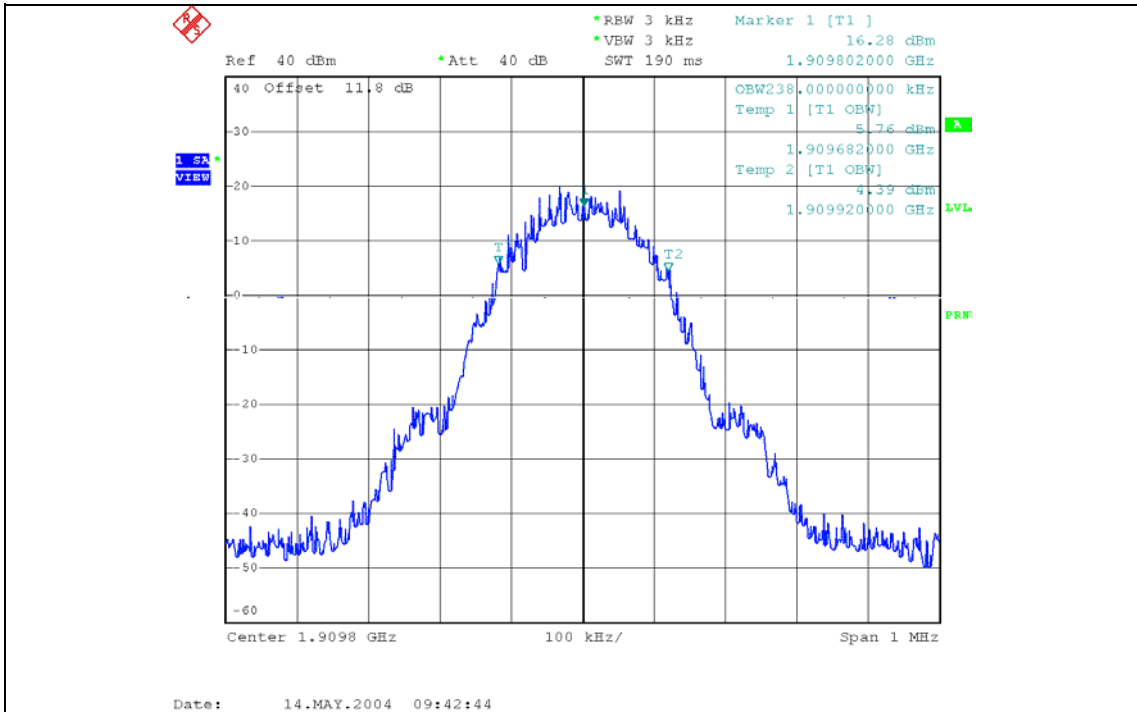

5.3.18) GMSK Occupied Bandwidth, PCS High channel, 1909.8 MHz, -26dBc bandwidth

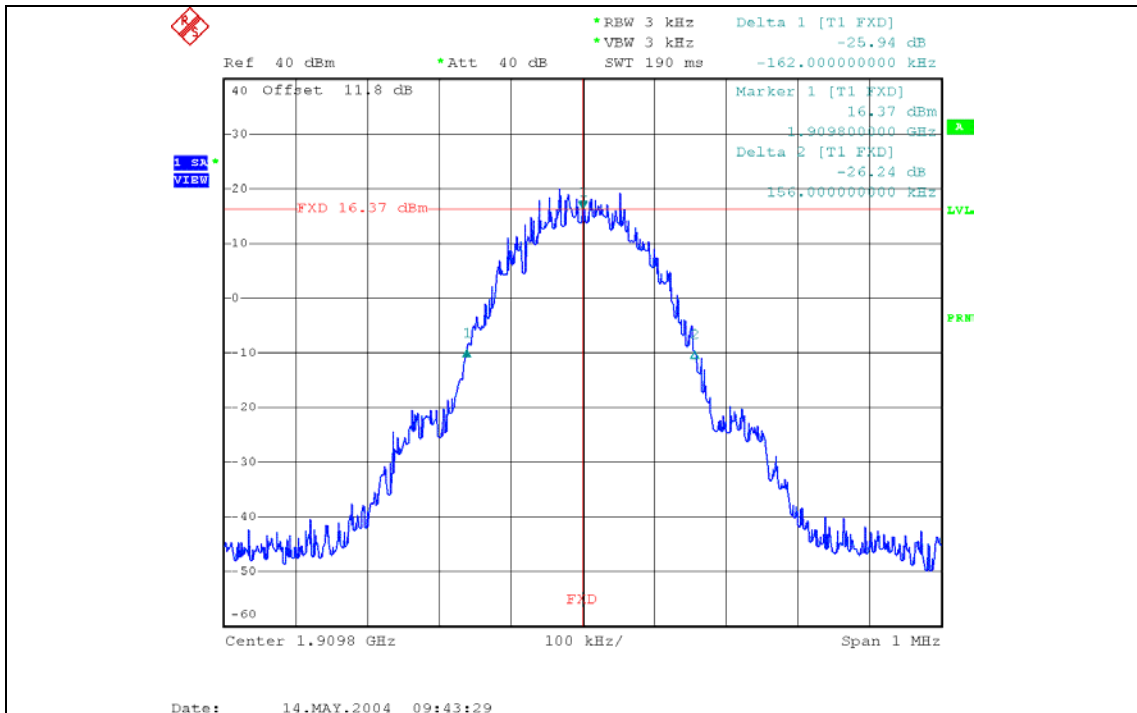

5.3.19) 8-PSK Occupied Bandwidth, PCS Low channel, 1850.2 MHz, 99% bandwidth

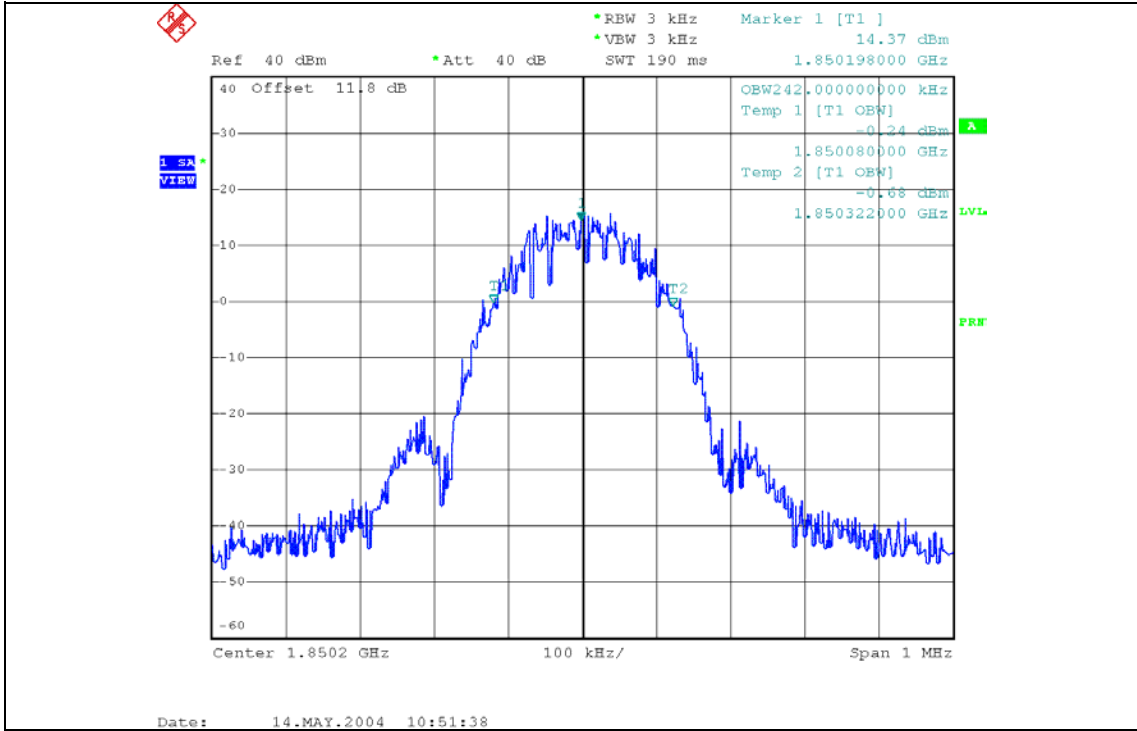

5.3.20) 8-PSK Occupied Bandwidth, PCS Low channel, 1850.2 MHz, -26dBc bandwidth

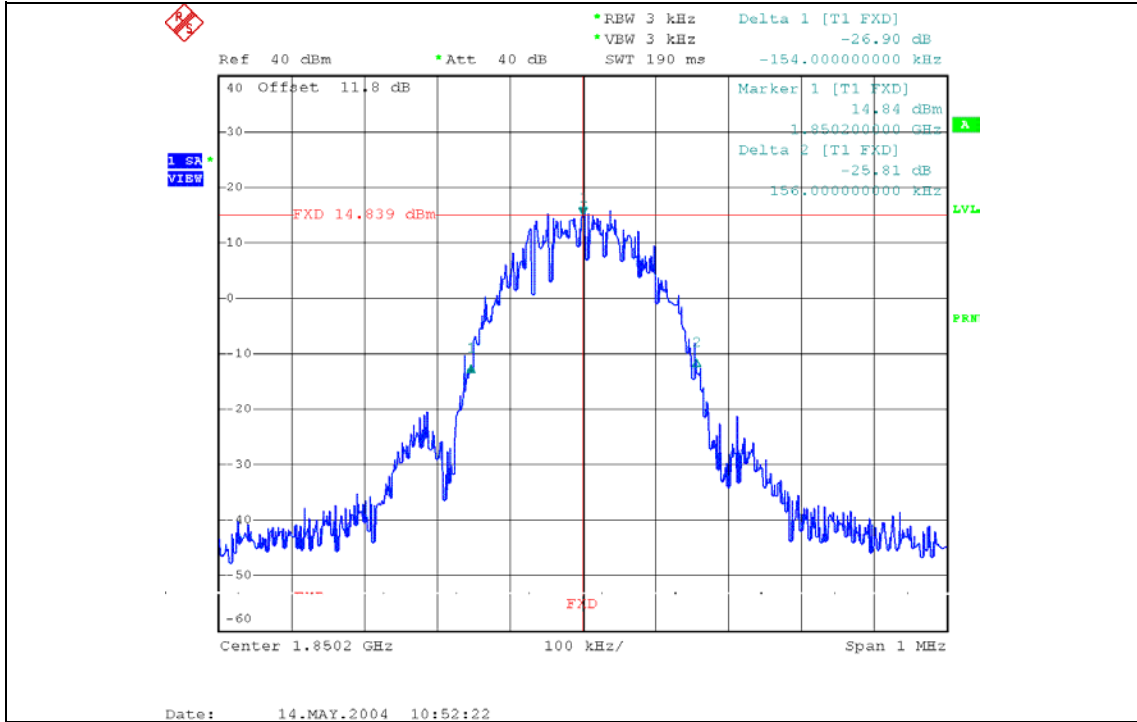

5.3.21) 8-PSK Occupied Bandwidth, PCS Middle channel, 1880.0 MHz, 99% bandwidth

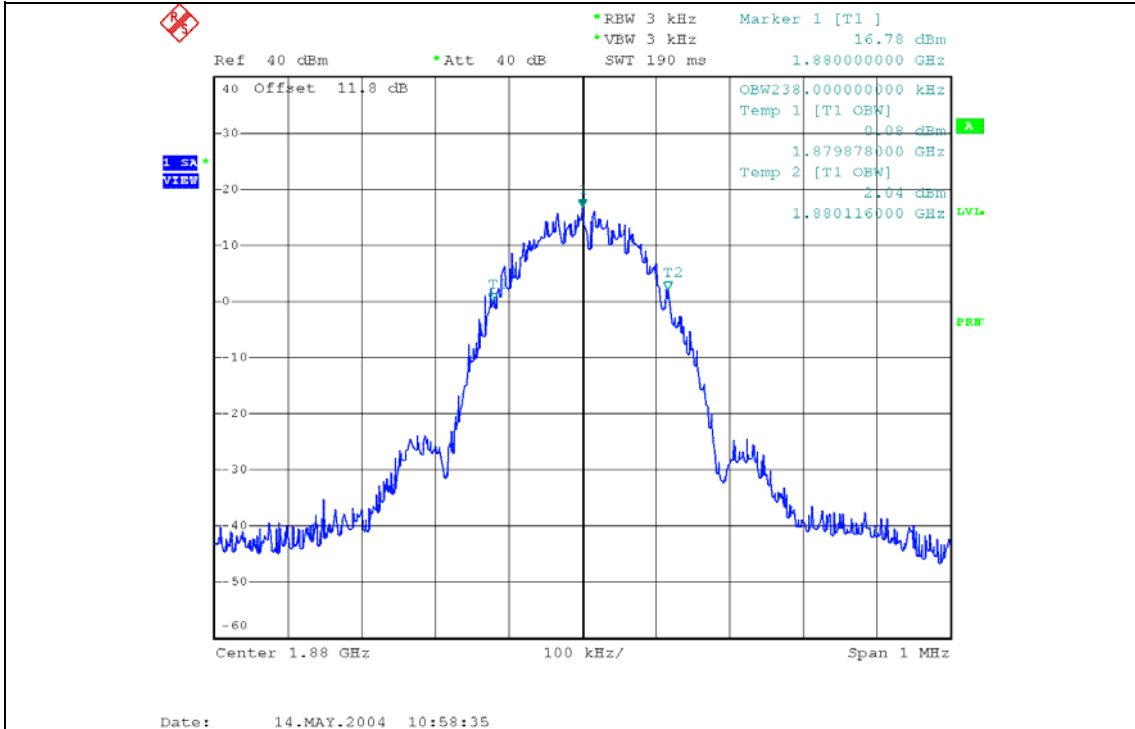

5.3.22) 8-PSK Occupied Bandwidth, PCS Middle channel, 1880.0 MHz, -26dBc bandwidth

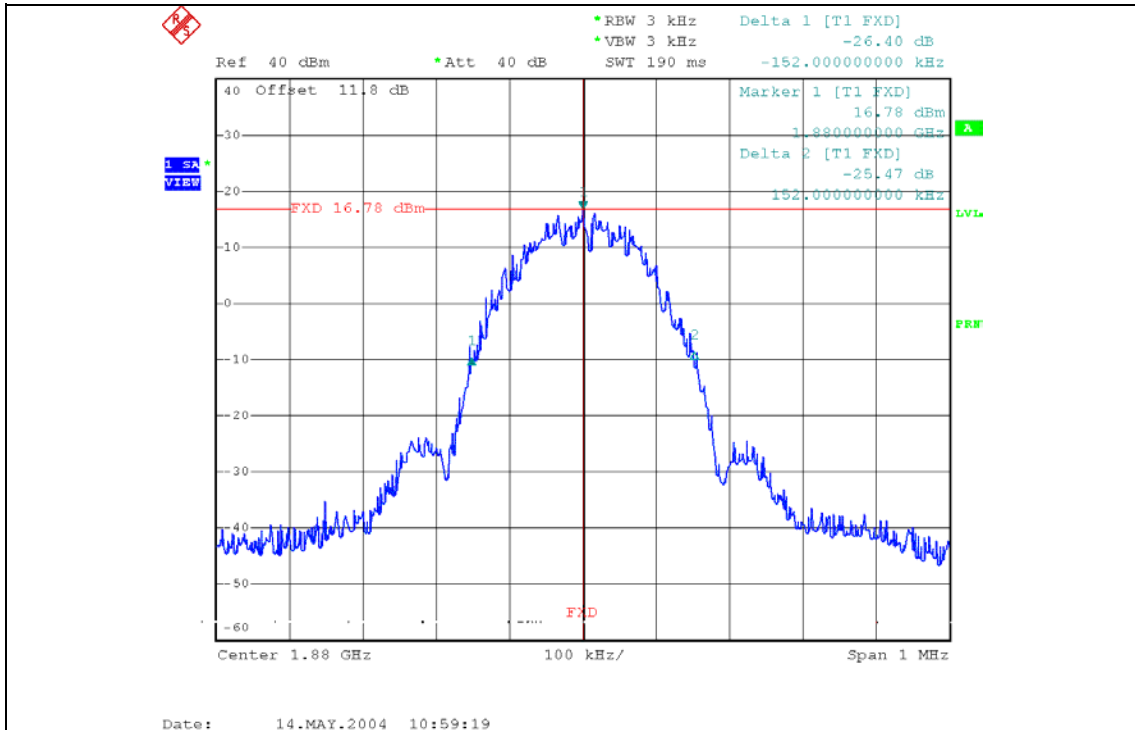

5.3.23) 8-PSK Occupied Bandwidth, PCS High channel, 1909.8 MHz, 99% bandwidth

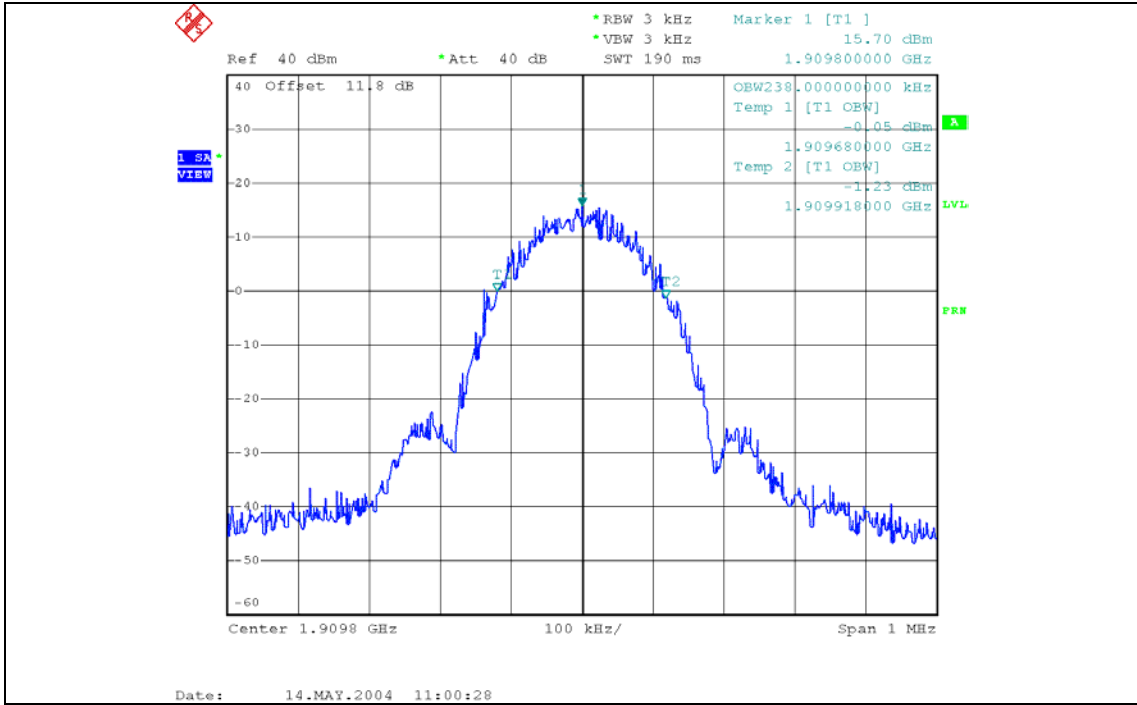

5.3.24) 8-PSK Occupied Bandwidth, PCS High channel, 1909.8 MHz, -26dBc bandwidth

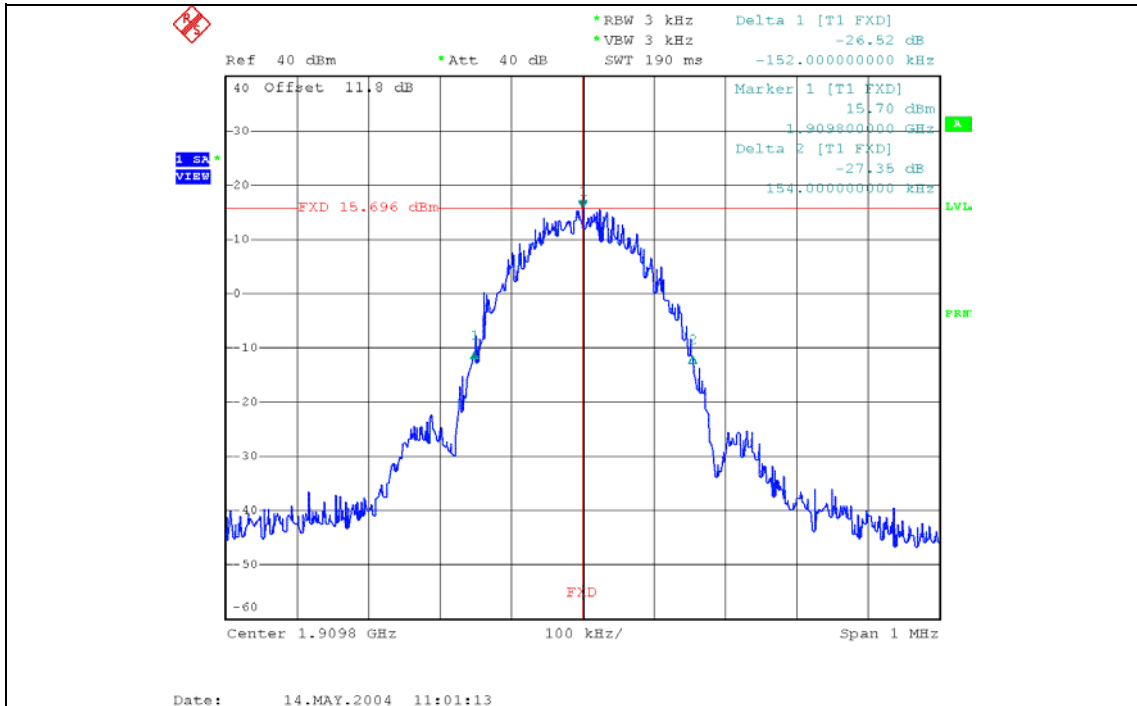

6 Out of Band Emissions at Antenna Terminals

FCC 22.901(d), 22.917, 24.238(a)

Out of Band Emissions:

The mean power of emissions must be attenuated below the mean power of the unmodulated carrier (P) on any frequency outside the frequency band by at least $(43 + 10 \log P)$ dB, in this case, -13dBm.

6.1 Test Procedure

The RF output of the transmitter was connected to a spectrum analyzer through a calibrated coaxial cable. Sufficient scans were taken to show the out-of-band Emissions, if any, up to 10th harmonic. The EUT was scanned for spurious emissions from 1MHz to 20GHz with sufficient bandwidth and video resolution. Data plots are included. The measurement cable path loss at 20GHz (including an attenuator) was 13dB (11dB at lower frequencies). To larger path loss of 13dB was used for all measurements to be conservative.

Test Setup

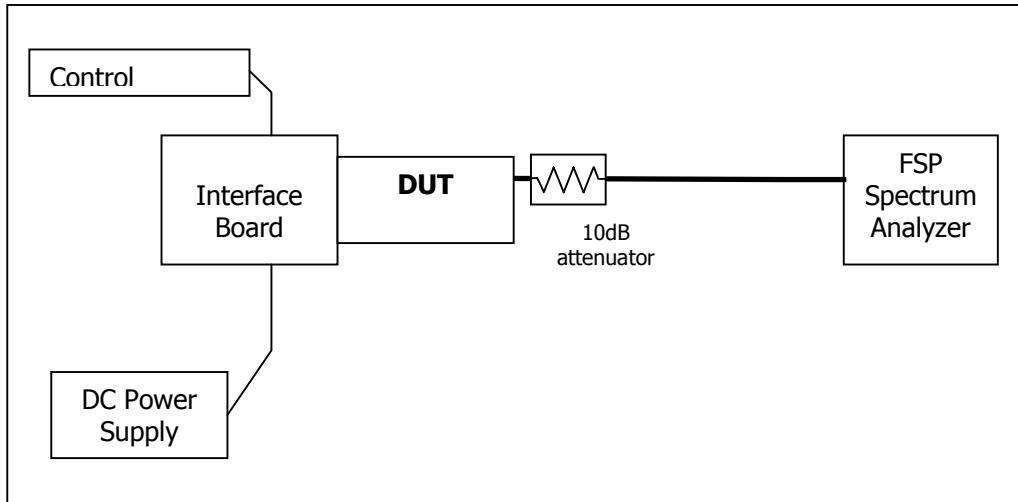

6.2 Test Equipment

EQUIPMENT	MANUFACTURER	MODEL NO.	SERIAL NO.	CAL. DATE
Control Computer	TC	Generic PC	100488	N/A
Wireless Test Set	Rohde & Schwarz	CMU200	836766/030	N/A
Spectrum Analyzer	Rohde & Schwarz	FSP 30GHz	US41421268	Sept. 12, 2003
DC Power Supply	HP	E3631A	100060	N/A
Interface Board	Shop built	Minnow	N/A	N/A
Directional Coupler	Pasternack	PE2209-10	N/A	N/A

SIERRA WIRELESS, INC.

6.3 Test Results

Refer to the following plots.

- **Cellular Band**

Plot Number	Description
6.4.1 – 6.4.3	GMSK Mode, Low channel, 824.20 MHz
6.4.4 – 6.4.6	GMSK Mode, Middle Channel, 836.6 MHz
6.4.7 – 6.4.9	GMSK Mode, High Channel, 848.8 MHz
6.4.10 – 6.4.12	8-PSK Mode, Low channel, 824.20 MHz
6.4.13 – 6.4.15	8-PSK Mode, Middle Channel, 836.6 MHz
6.4.16 – 6.4.18	8-PSK Mode, High Channel, 848.8 MHz

- **PCS Band**

Plot Number	Description
6.4.19 – 6.4.21	GMSK Mode, Low Channel, 1850.2 MHz
6.4.22 – 6.4.24	GMSK Mode, Middle Channel, 1880.0 MHz
6.4.25 – 6.4.27	GMSK Mode, High Channel, 1909.8 MHz
6.4.28 – 6.4.30	8-PSK, Mode, Low Channel, 1850.2 MHz
6.4.31 – 6.4.33	8-PSK Mode, Middle Channel, 1880.0 MHz
6.4.34 – 6.4.36	8-PSK Mode, High Channel, 1909.8 MHz

- **Emissions in Base Station Frequency Range, Cellular band**

Plot Number	Description
6.4.37	GMSK, Low channel, 824.20 MHz
6.4.38	GMSK, Middle Channel, 836.6 MHz
6.4.39	GMSK, High Channel, 848.8 MHz
6.4.40	8-PSK, Low channel, 824.20 MHz
6.4.41	8-PSK, Middle Channel, 836.6 MHz
6.4.42	8-PSK, High Channel, 848.8 MHz

These plots show that the conducted emission limits requirements are met.

6.4 Test Plots

Plot 6.4.1) Out of Band Emissions at Antenna Terminals
 GSMK, Low channel, 824.200 MHz, 1 MHz to 1 GHz

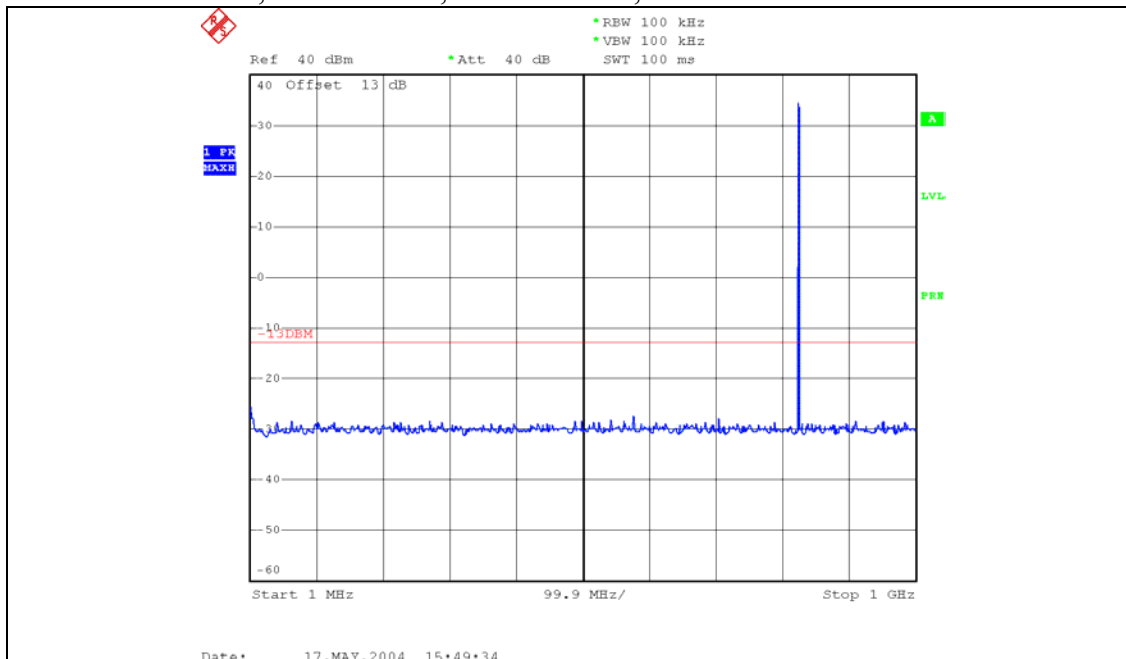

Plot 6.4.2) Out of Band Emissions at Antenna Terminals
 GSMK, Low channel, 824.200 MHz, TX signal +/- 20 MHz

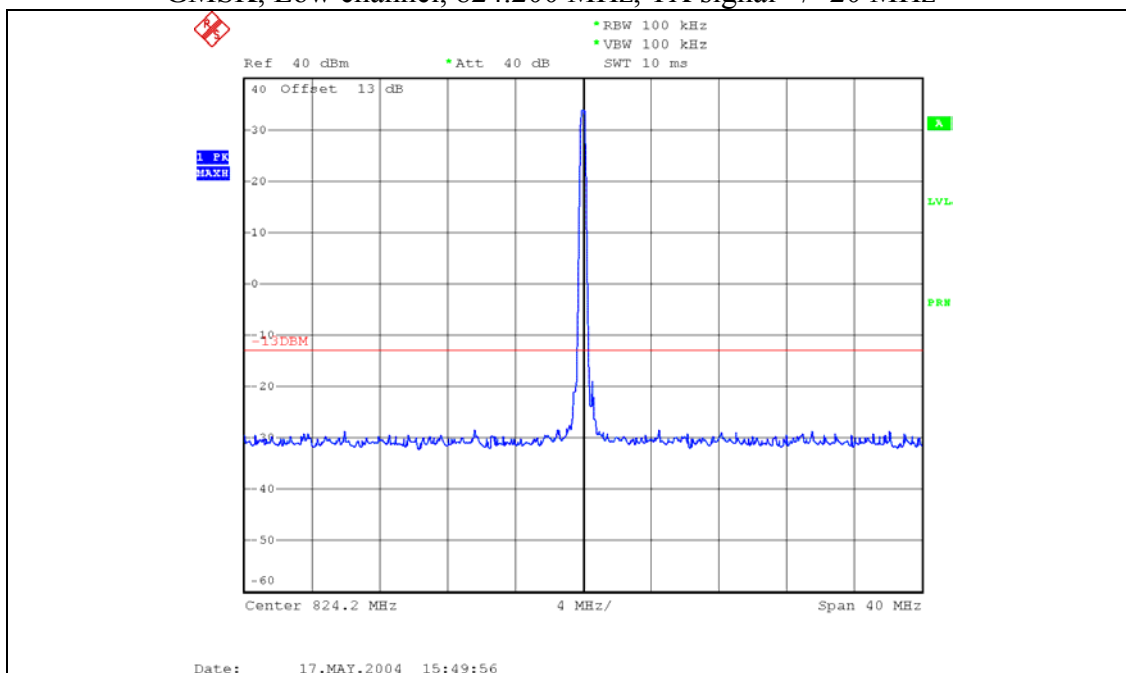

Strong emission shown in each case is the carrier signal.

Plot 6.4.4) Out of Band Emissions at Antenna Terminals
GMSK, Mid Channel, 836.6 MHz, 1 MHz to 1 GHz

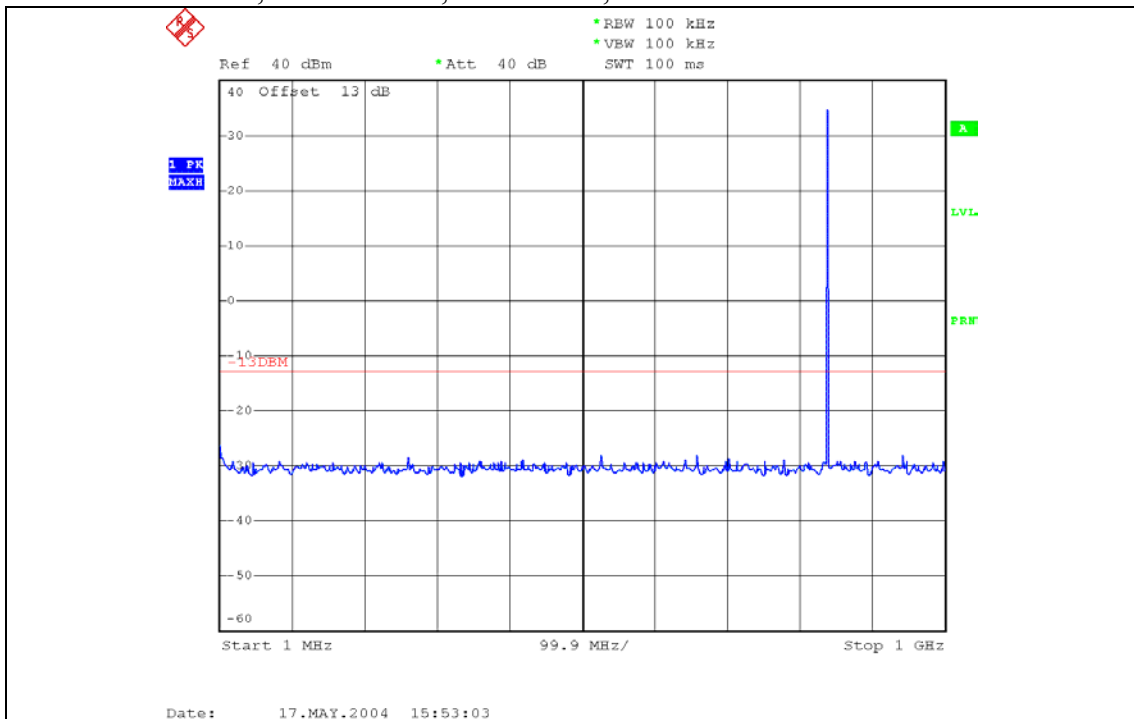

Plot 6.4.5) Out of Band Emissions at Antenna Terminals
GMSK, Mid Channel, 836.6 MHz, TX signal +/- 20 MHz

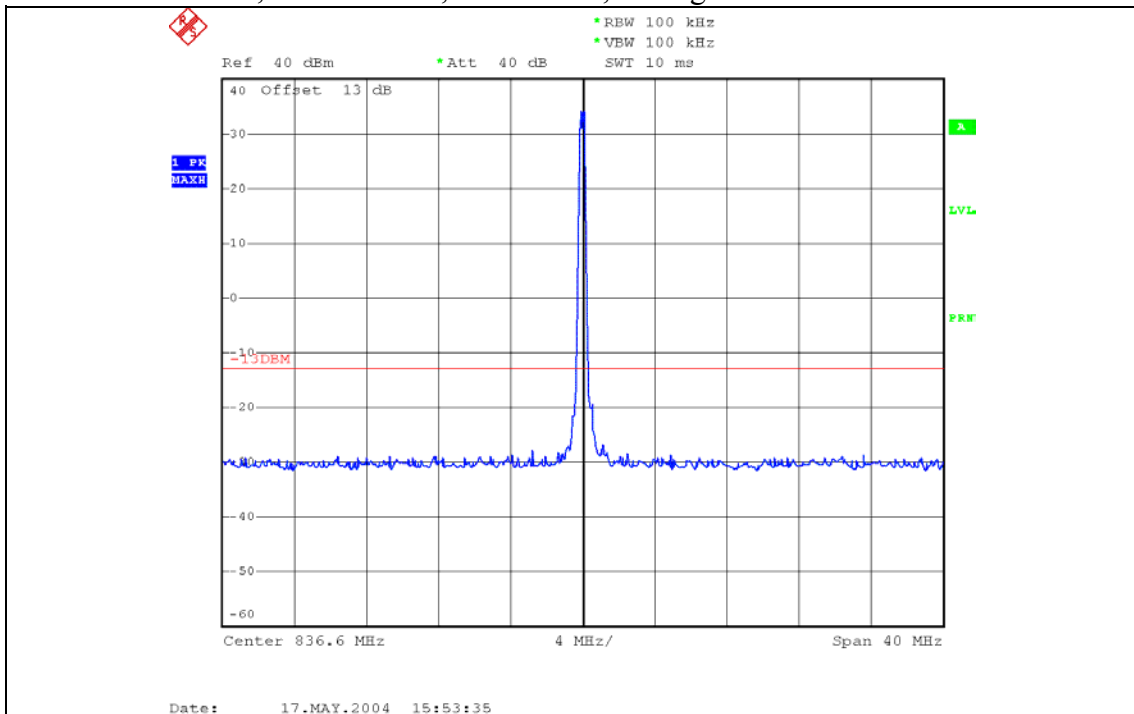

Strong emission shown in each case is the carrier signal.

© 2004 Sierra Wireless, Inc.

The contents of this page are subject to the confidentiality information on page one.

SIERRA WIRELESS, INC.

Plot 6.4.6) Out of Band Emissions at Antenna Terminals
 GSMK, Mid Channel, 836.6 MHz, 1 GHz to 20 GHz

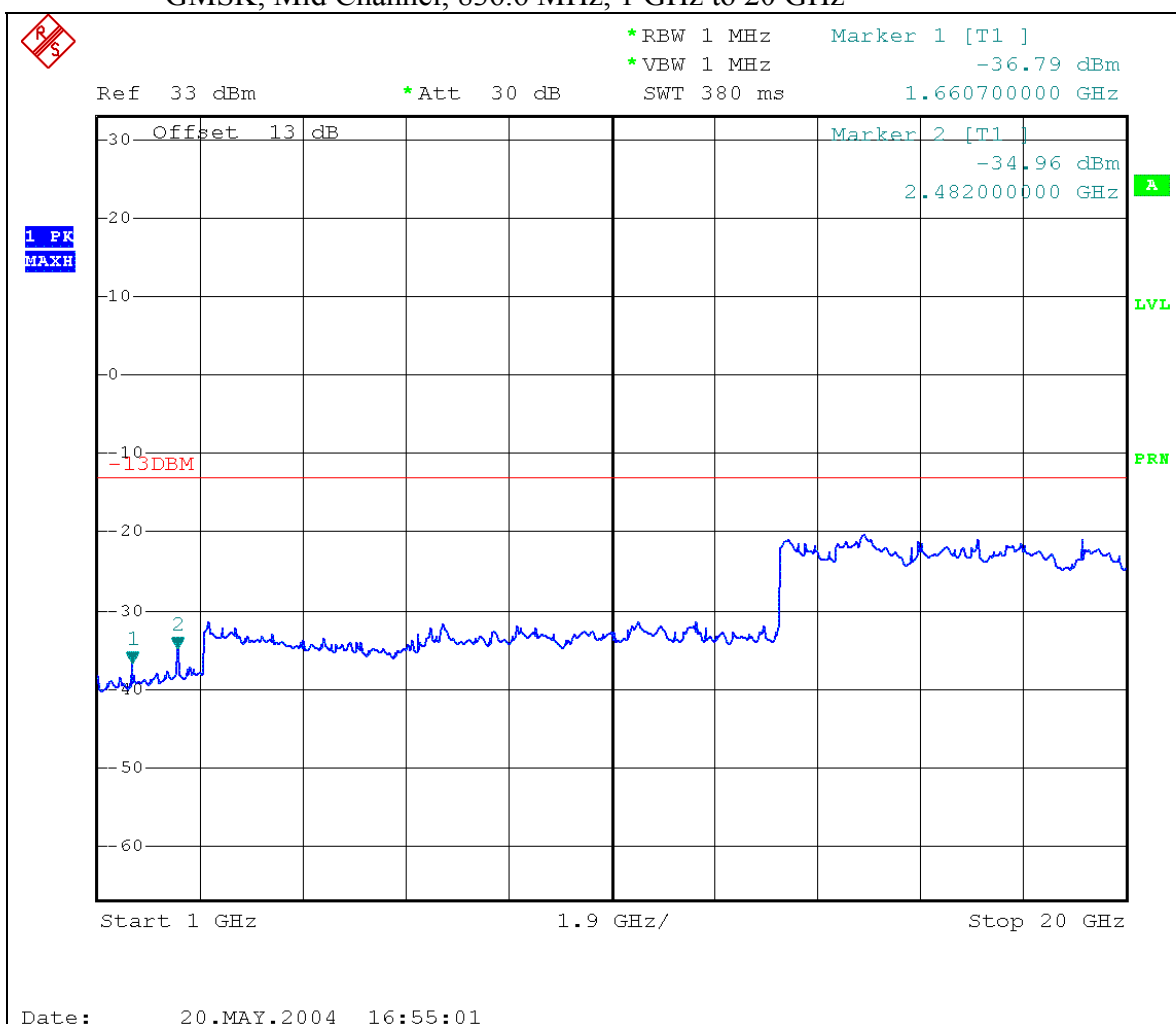

Cellular Harmonics for Ch. 190 (836.6 MHz)	Level (dBm)
Second	-36 dBm
Third	-34 dBm
All others	< -30dBm up to 20GHz

Plot 6.4.7) Out of Band Emissions at Antenna Terminals
 GMSK, High Channel, 848.8 MHz, 1 MHz to 1 GHz

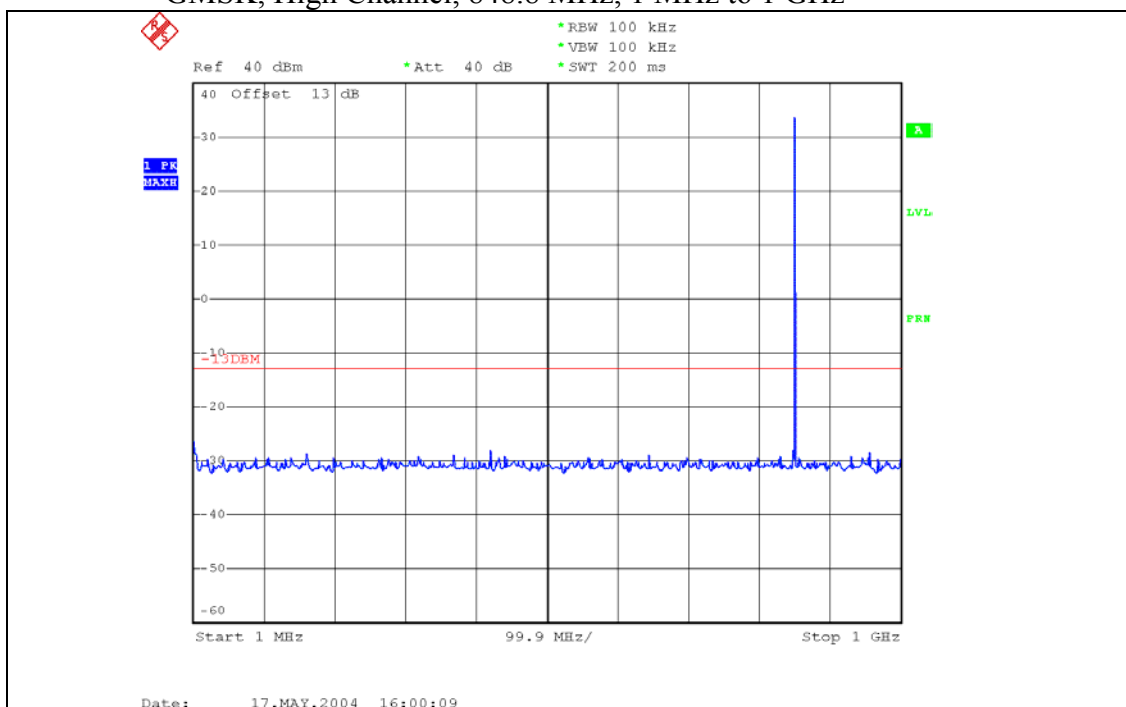

Plot 6.4.8) Out of Band Emissions at Antenna Terminals
 GMSK, High Channel, 848.8 MHz, TX signal +/- 20 MHz

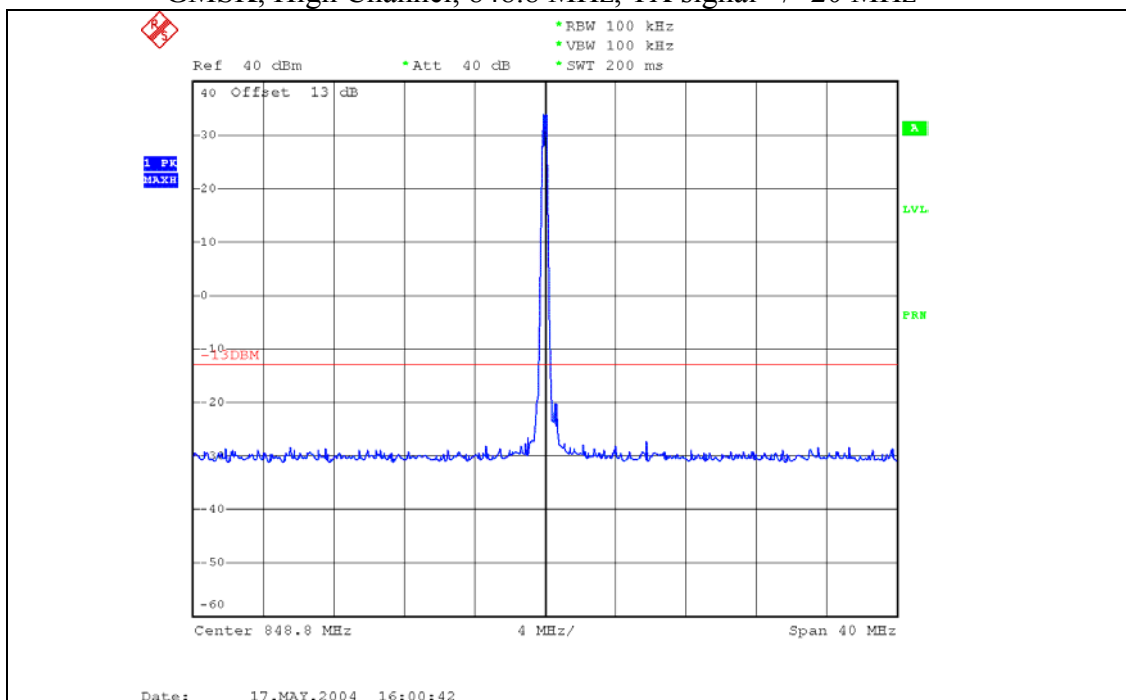

Strong emission shown in each case is the carrier signal.

Plot 6.4.10) Out of Band Emissions at Antenna Terminals
 8-PSK, Low channel, 824.200 MHz, 1 MHz to 1 GHz

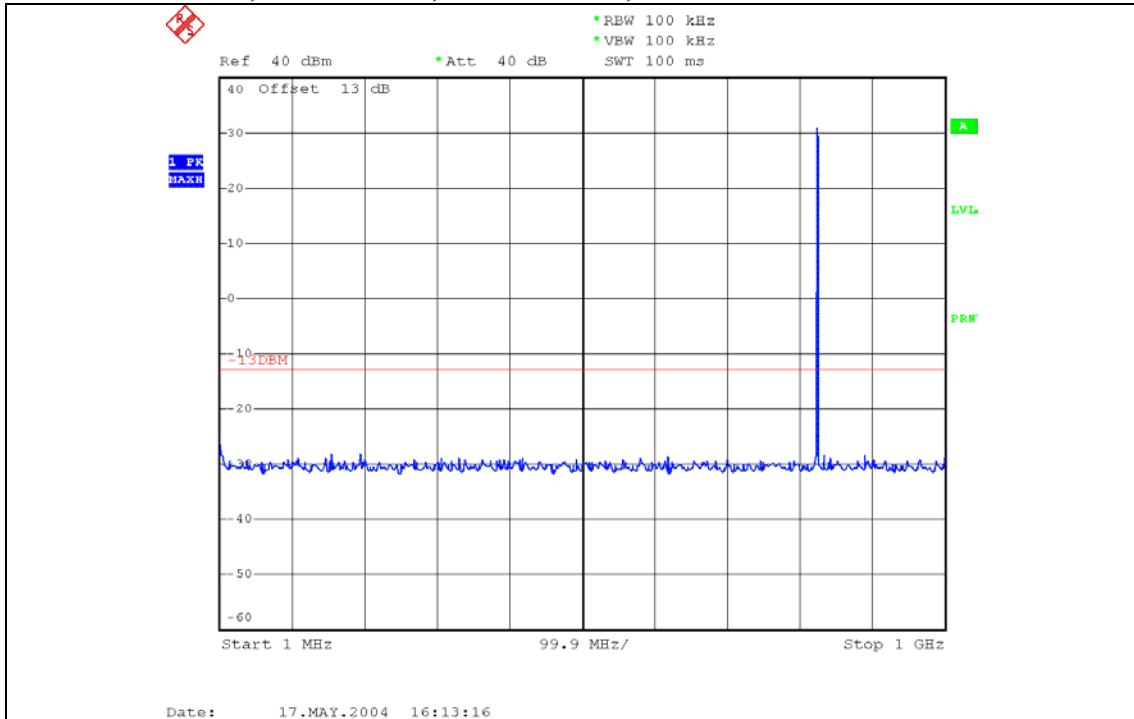

Plot 6.4.11) Out of Band Emissions at Antenna Terminals
 8-PSK, Low channel, 824.200 MHz, TX signal +/- 20 MHz

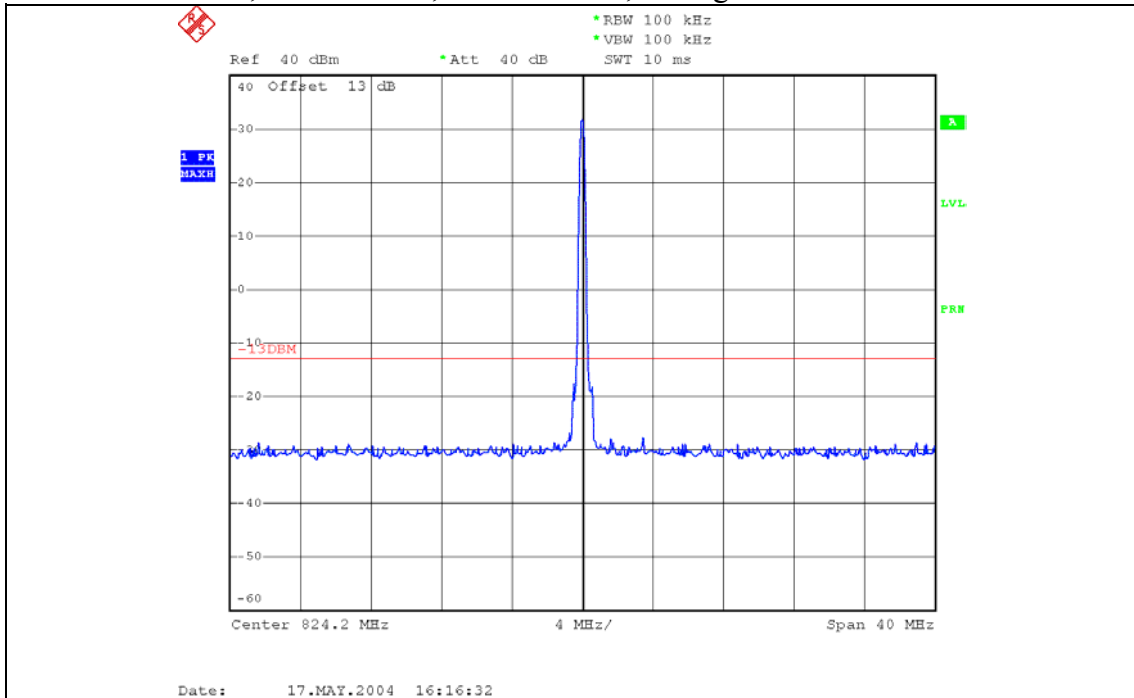

Strong emission shown in each case is the carrier signal.

Plot 6.4.13) Out of Band Emissions at Antenna Terminals
 8-PSK, Mid Channel, 836.6 MHz, 1 MHz to 1 GHz

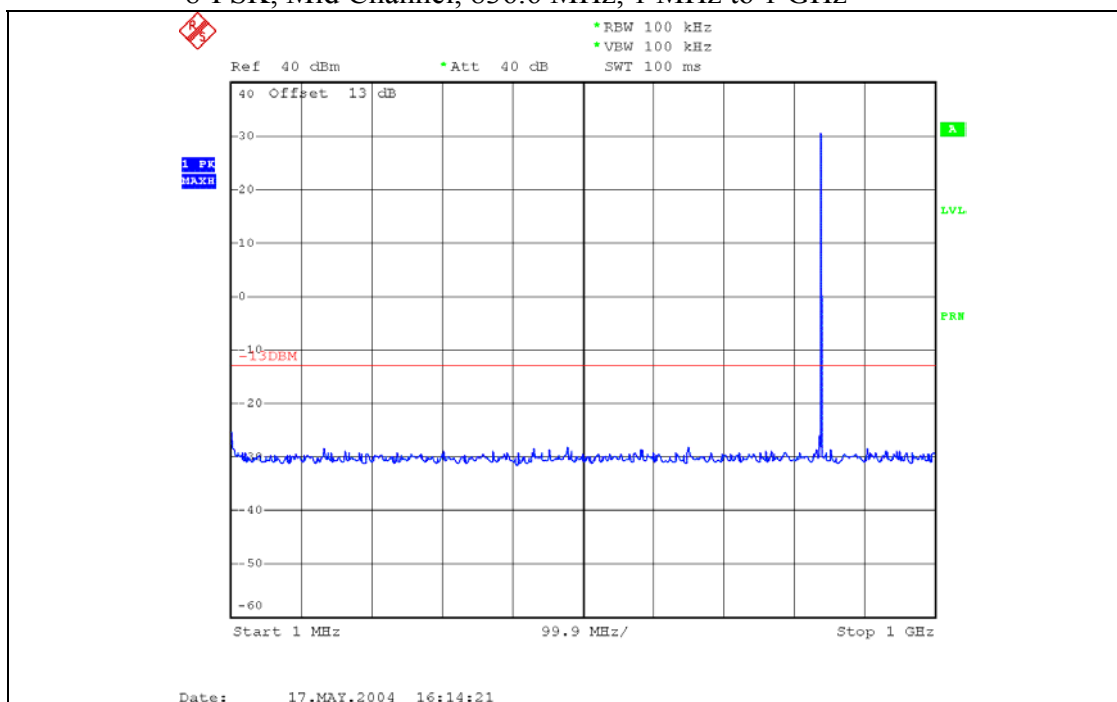

Plot 6.4.14) Out of Band Emissions at Antenna Terminals
 8-PSK, Mid Channel, 836.6 MHz, TX signal +/- 20 MHz

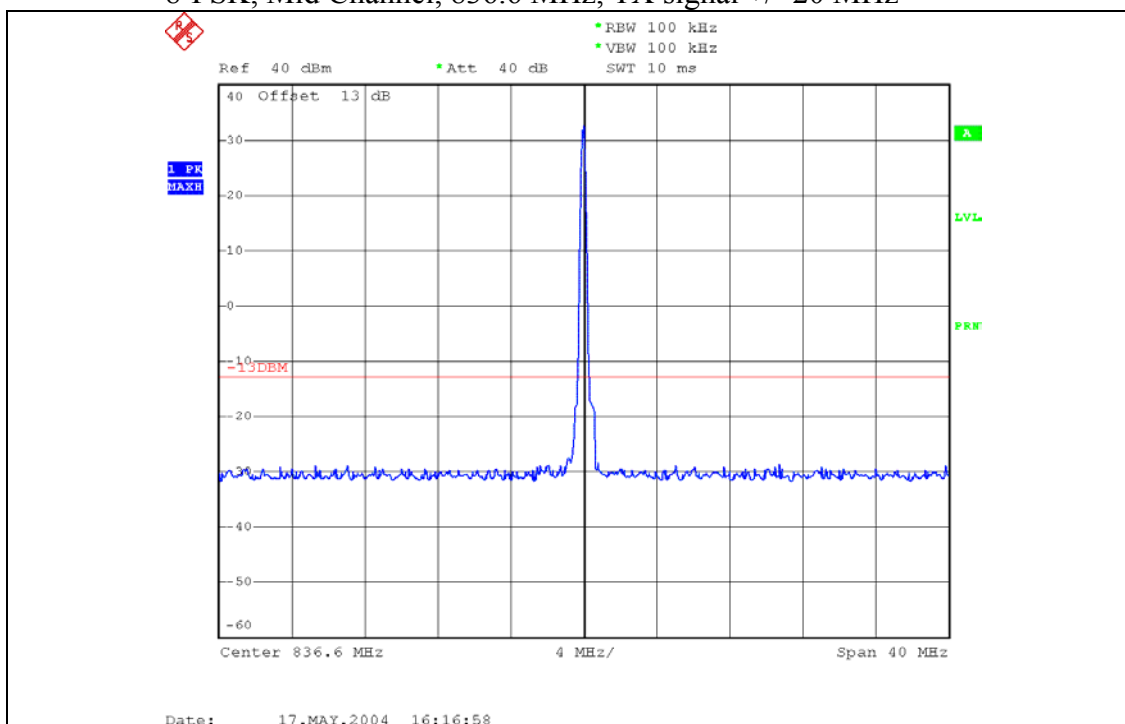

Strong emission shown in each case is the carrier signal.

Plot 6.4.15) Out of Band Emissions at Antenna Terminals
 8-PSK, Mid Channel, 836.6 MHz, 1 GHz to 20 GHz

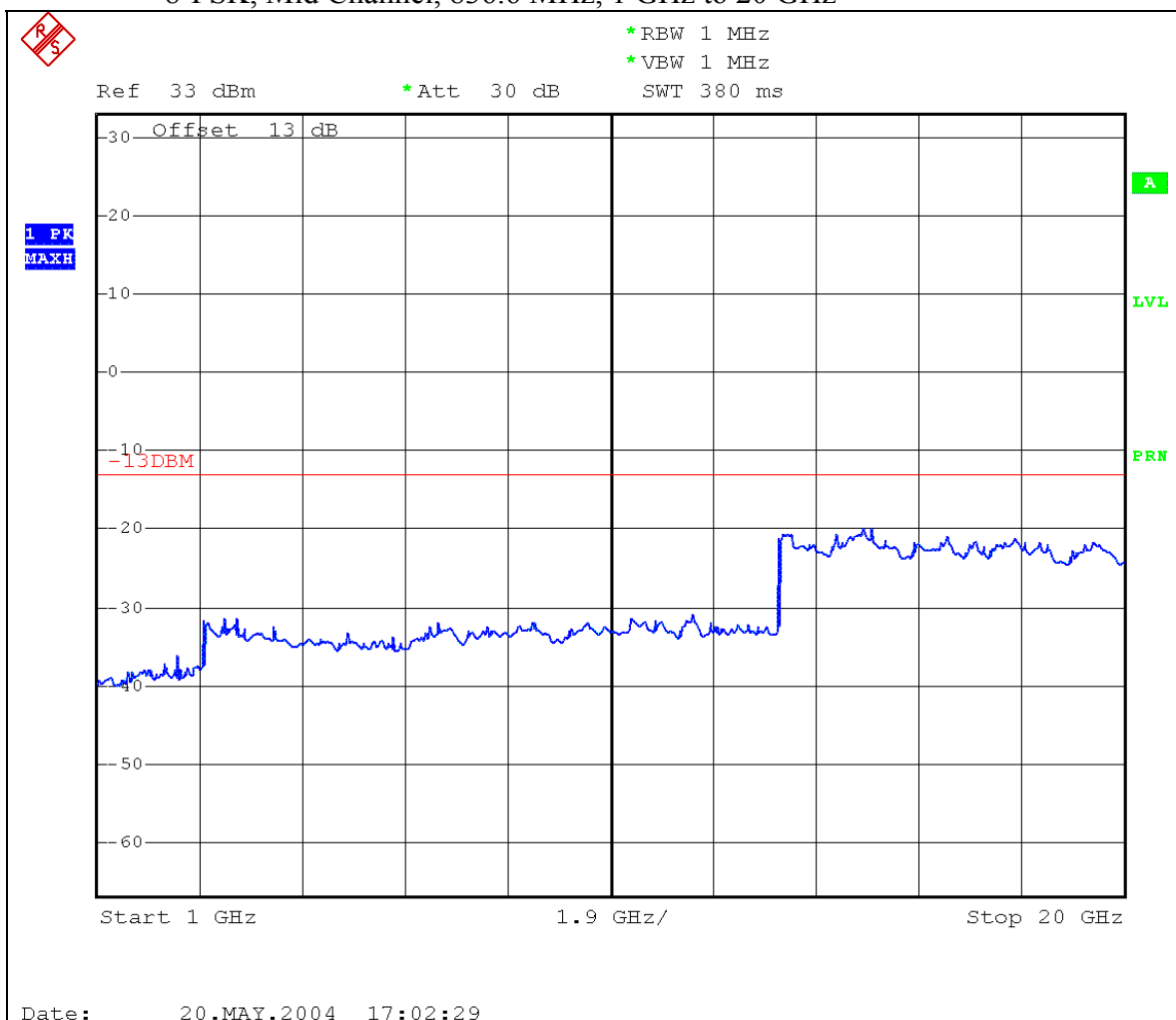

Cellular Harmonics for Ch. 190 (836.6 MHz)	Level (dBm)
Second	--
Third	--
All others	< -30dBm up to 20GHz

Plot 6.4.16) Out of Band Emissions at Antenna Terminals
 8-PSK, High Channel, 848.8 MHz, 1 MHz to 1 GHz

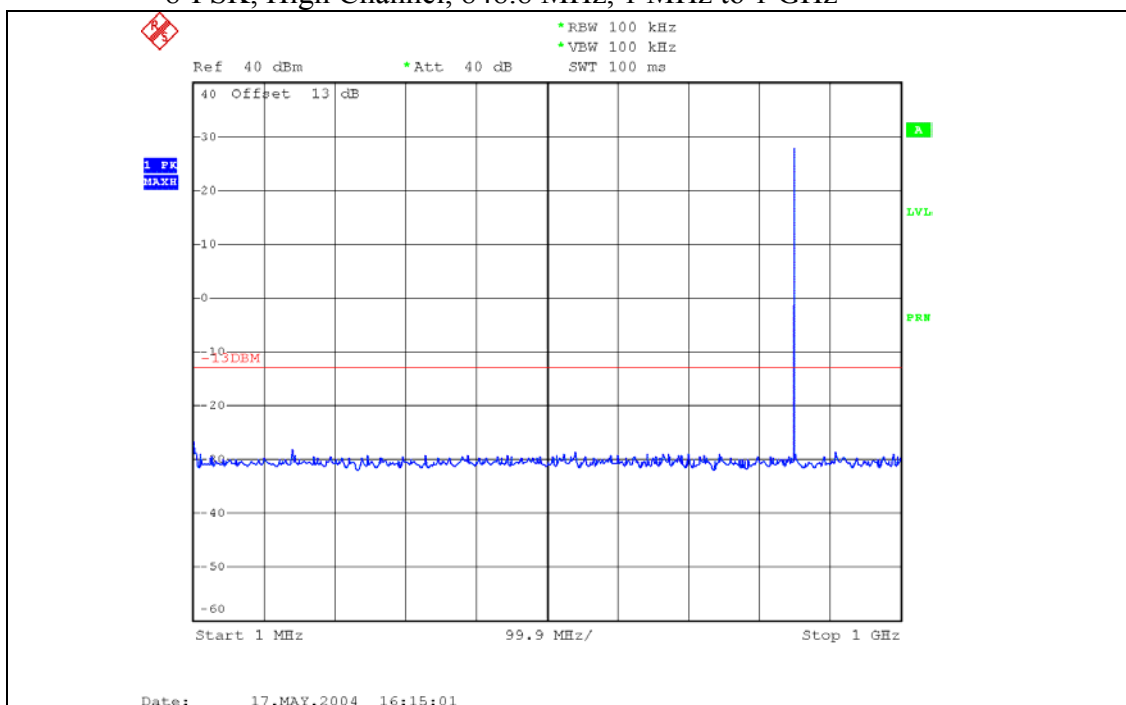

Plot 6.4.17) Out of Band Emissions at Antenna Terminals
 8-PSK, High Channel, 848.8 MHz, TX signal +/- 20 MHz

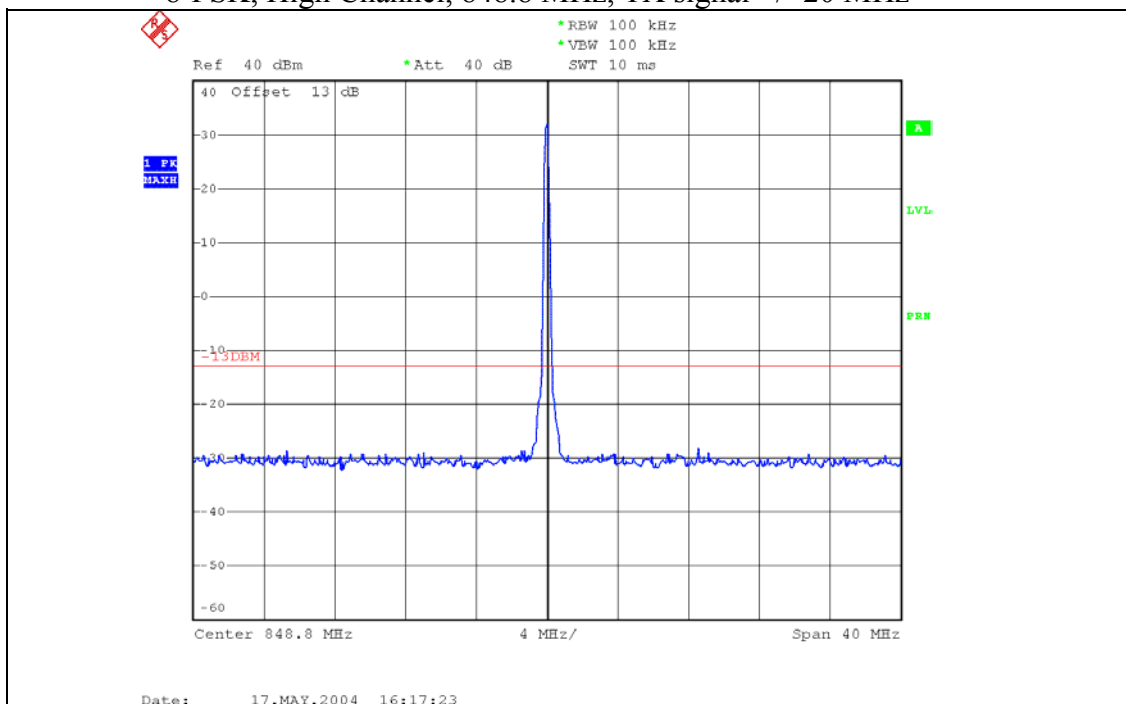

Strong emission shown in each case is the carrier signal.

Plot 6.4.18) Out of Band Emissions at Antenna Terminals
 8-PSK, High Channel, 848.8 MHz, 1 GHz to 20 GHz

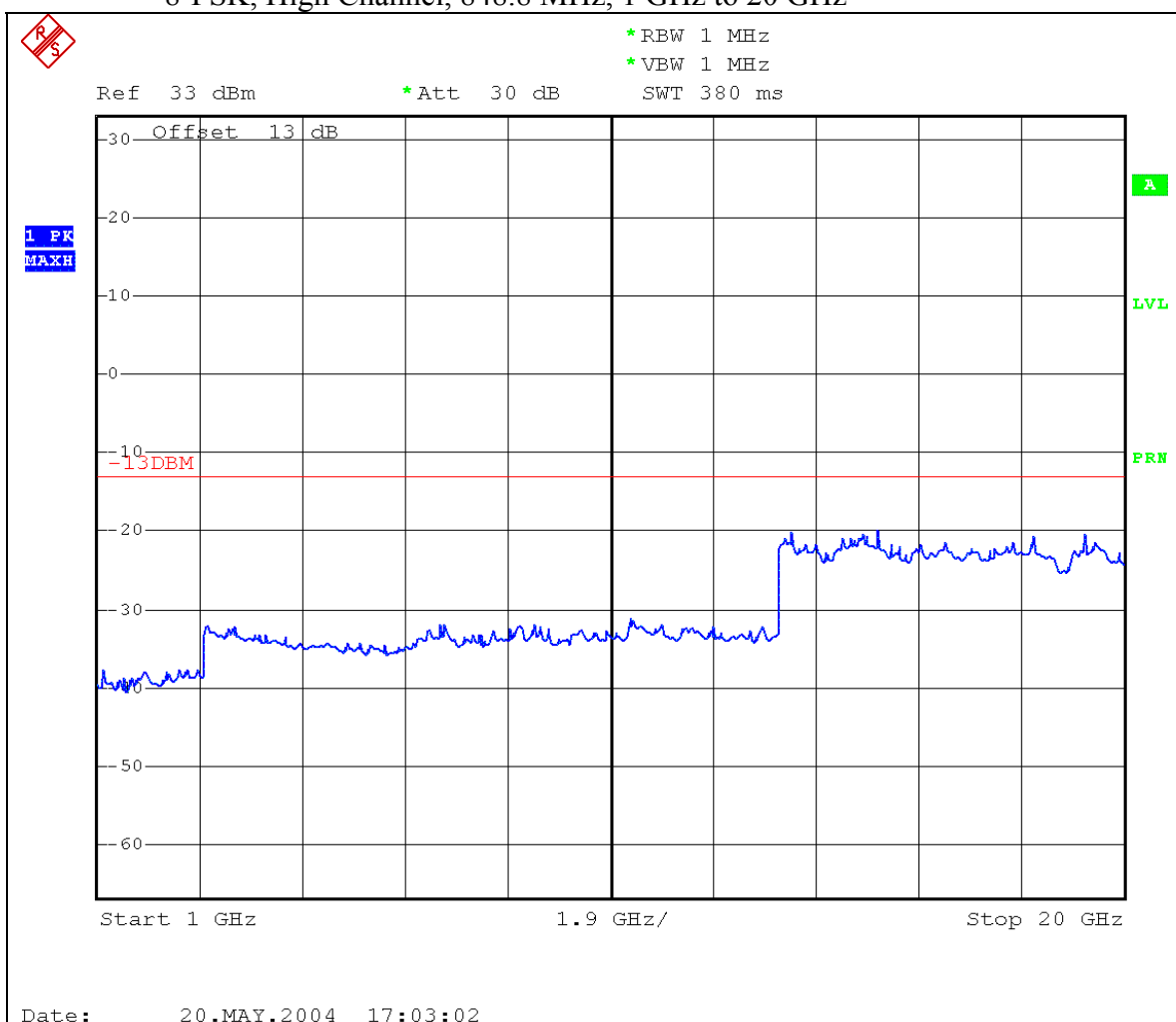

Cellular Harmonics for Ch. 251 (848.8 MHz)	Level (dBm)
Second	--
Third	--
All others	< -30dBm up to 20GHz

Plot 6.4.21) Out of Band Emissions at Antenna Terminals
GMSK, Low channel, 1850.2 MHz, 1 GHz to 20 GHz

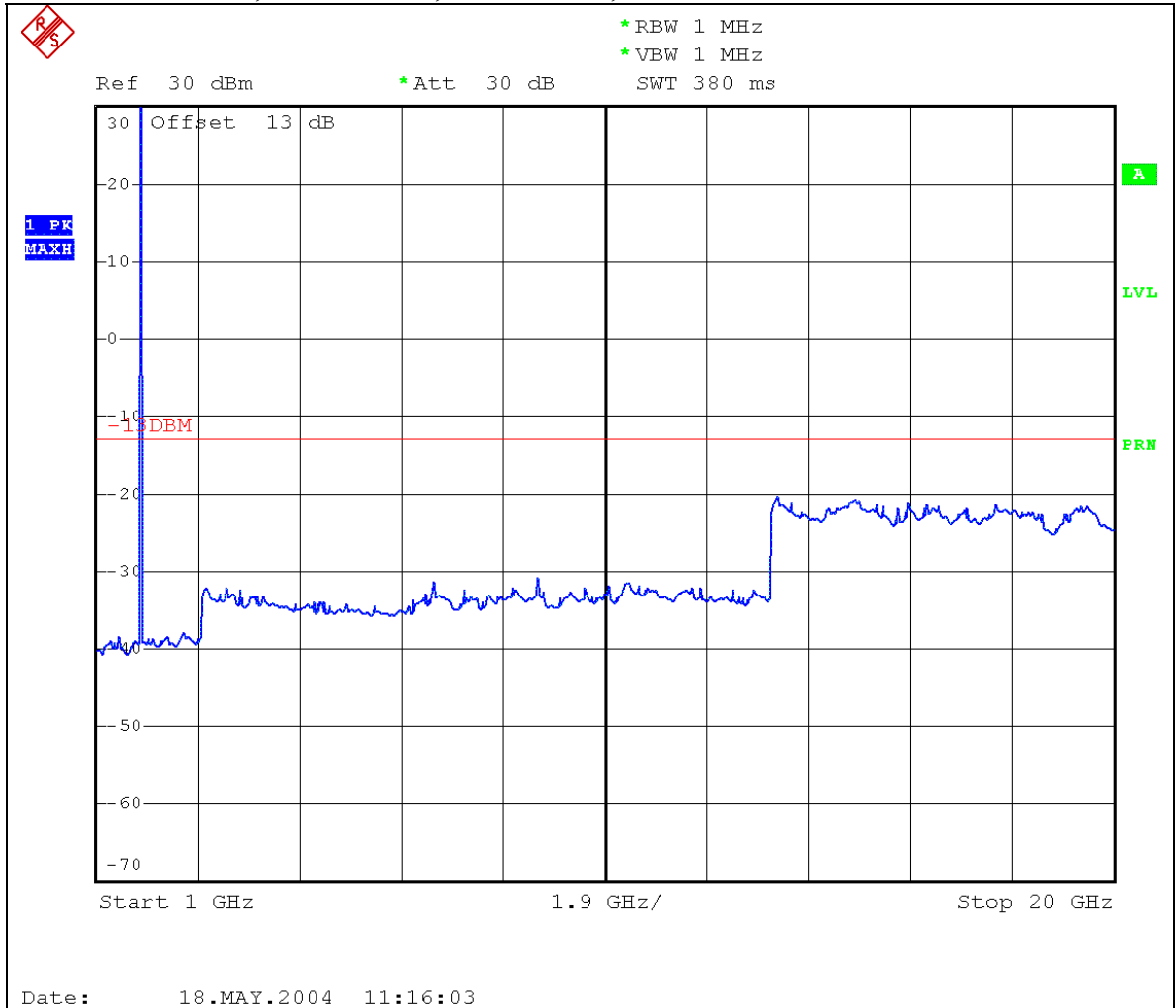

Strong emission shown is the carrier signal.

Plot 6.4.22) Out of Band Emissions at Antenna Terminals
 GSMK, Middle channel, 1880.0 MHz, 1 MHz to 1 GHz

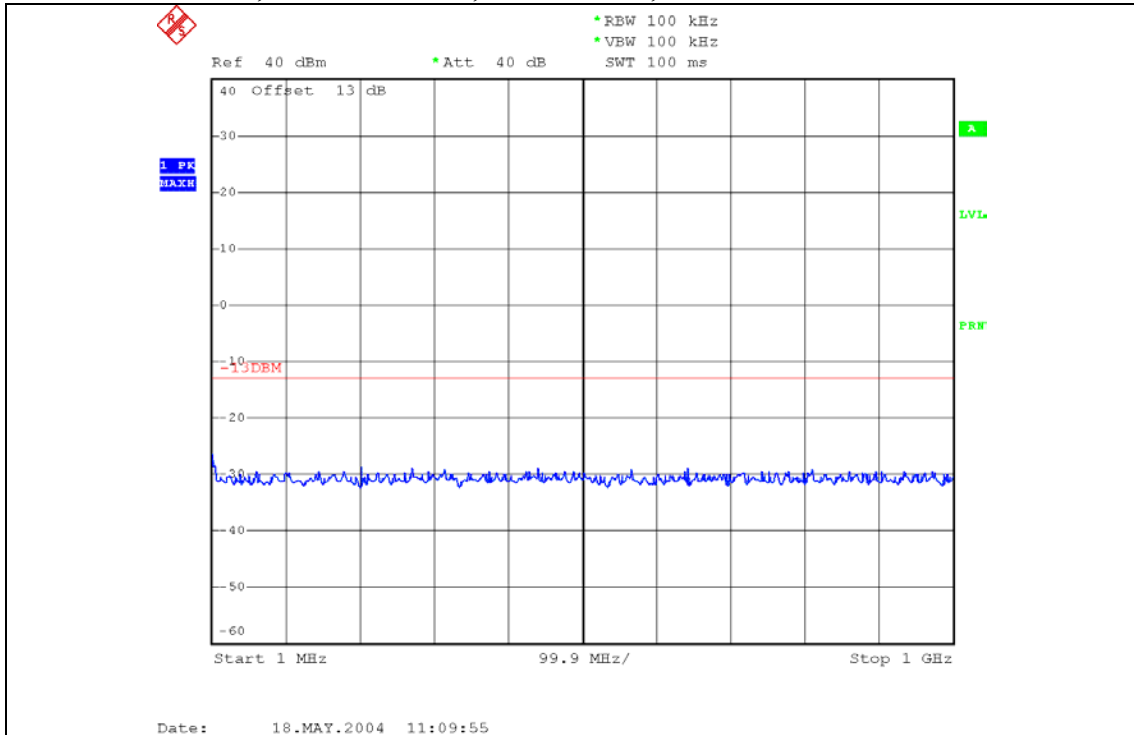

Plot 6.4.23) Out of Band Emissions at Antenna Terminals
 GSMK, Middle channel, 1880.0 MHz, TX signal +/- 20 MHz

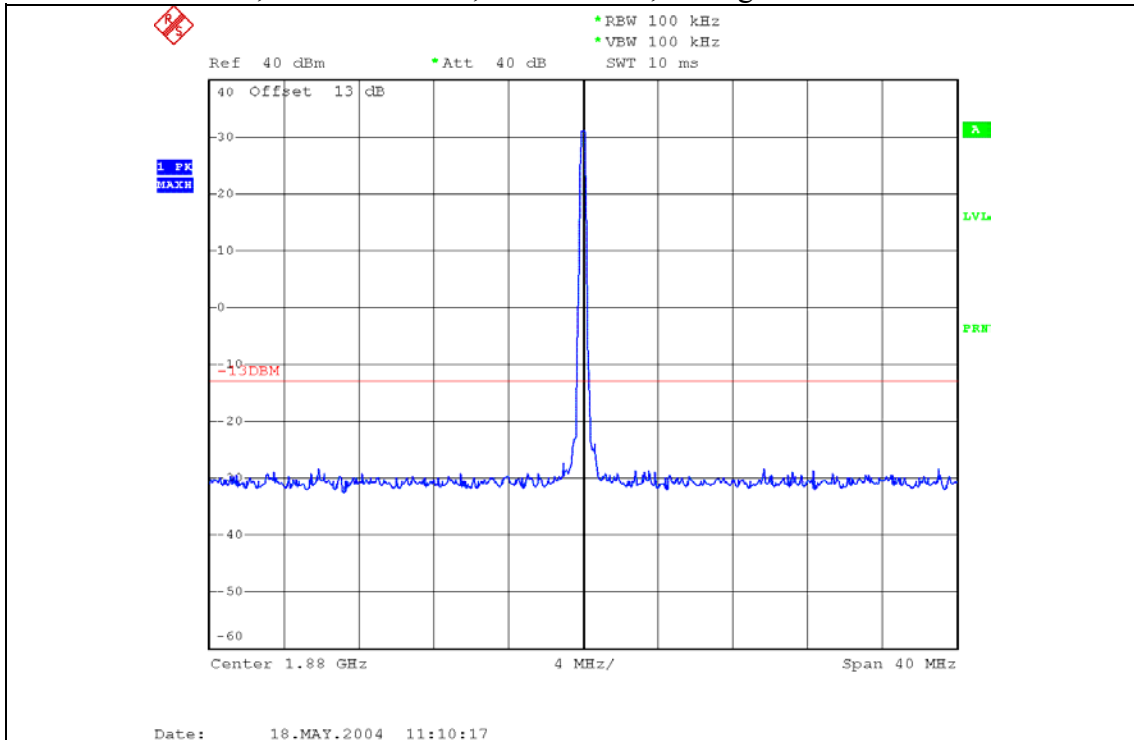

SIERRA WIRELESS, INC.

Plot 6.4.24) Out of Band Emissions at Antenna Terminals
GMSK, Middle channel, 1880.0 MHz, 1 GHz to 20 GHz

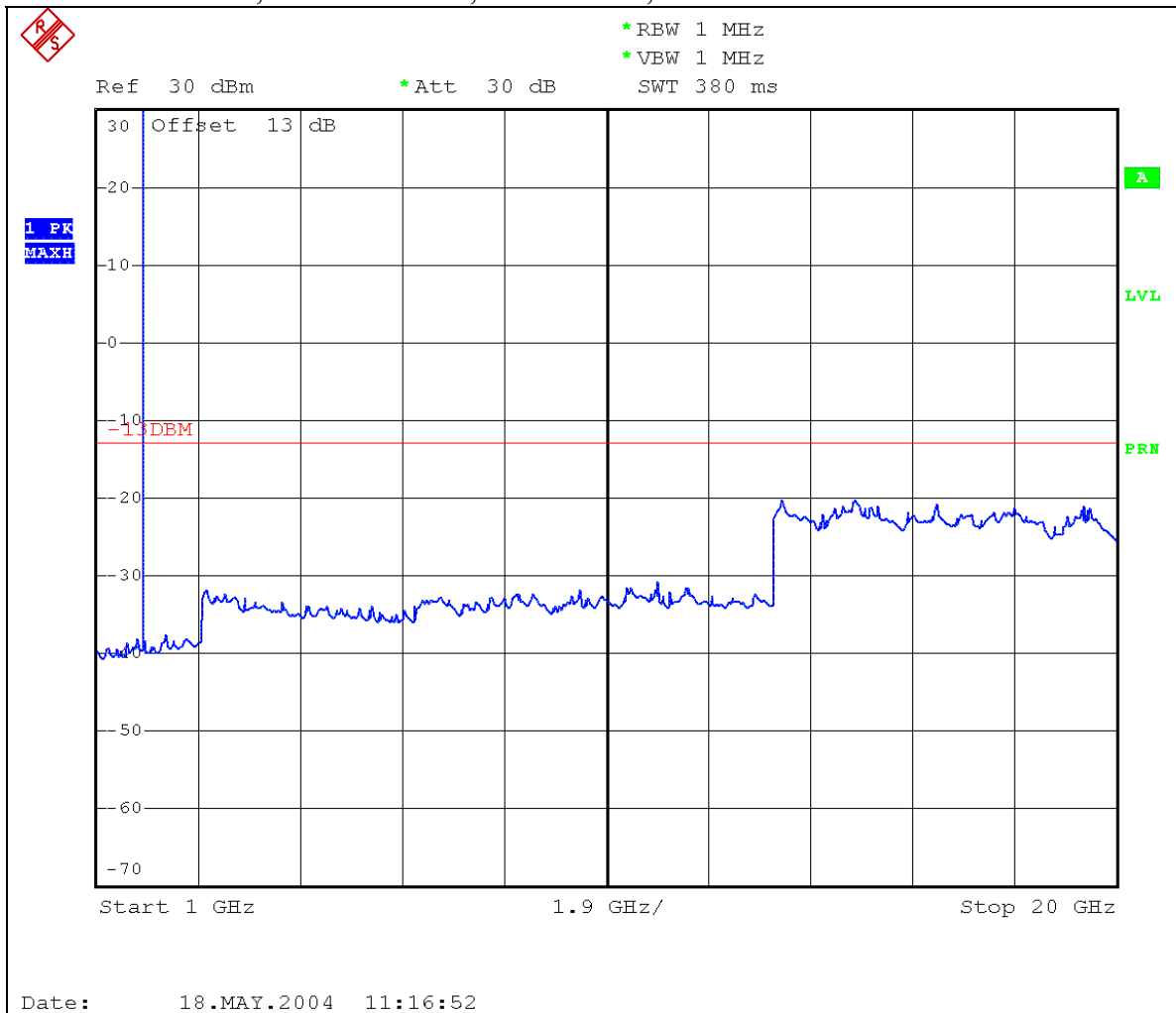

Strong emission shown is the carrier signal.

Plot 6.4.25) Out of Band Emissions at Antenna Terminals
 GSMK, High channel, 1909.8 MHz, 1 MHz to 1 GHz

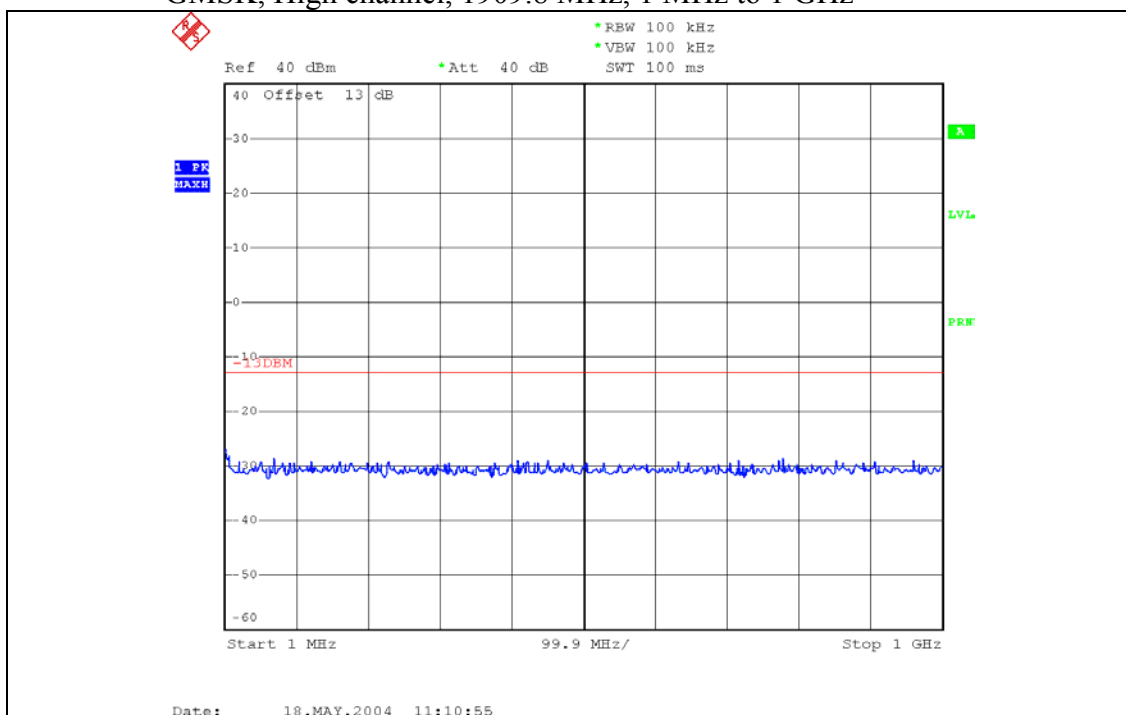

Plot 6.4.26) Out of Band Emissions at Antenna Terminals
 GSMK, High channel, 1909.8 MHz, TX signal +/- 20 MHz

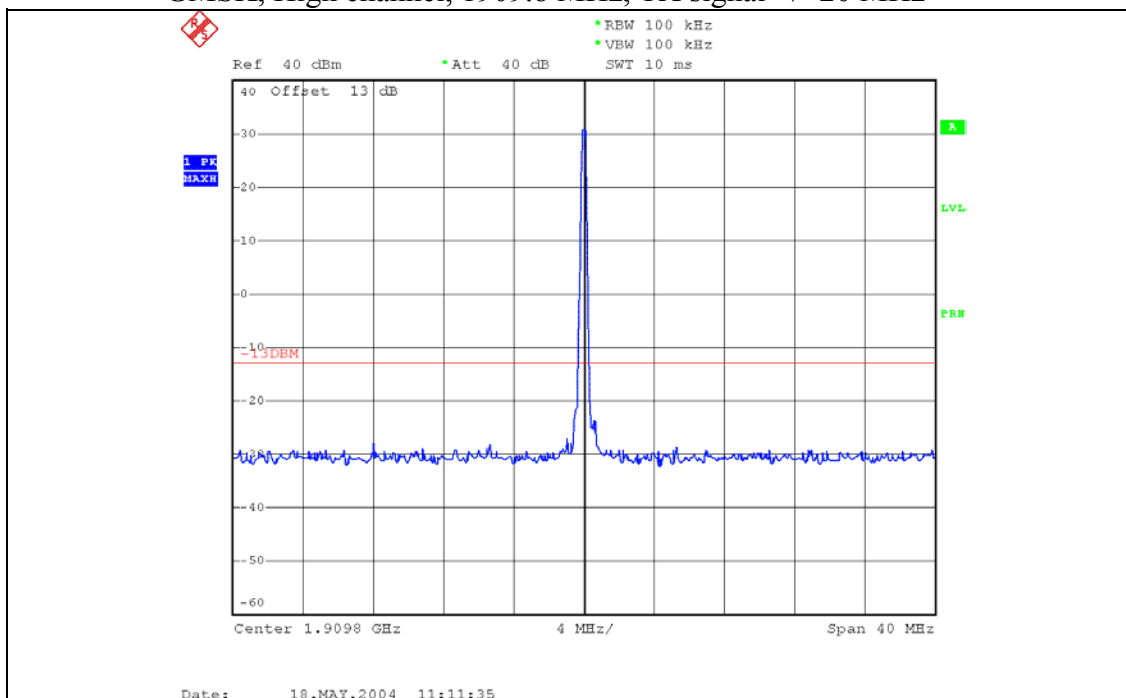

SIERRA WIRELESS, INC.

Plot 6.4.27) Out of Band Emissions at Antenna Terminals
GMSK, High channel, 1909.8 MHz, 1 GHz to 20 GHz

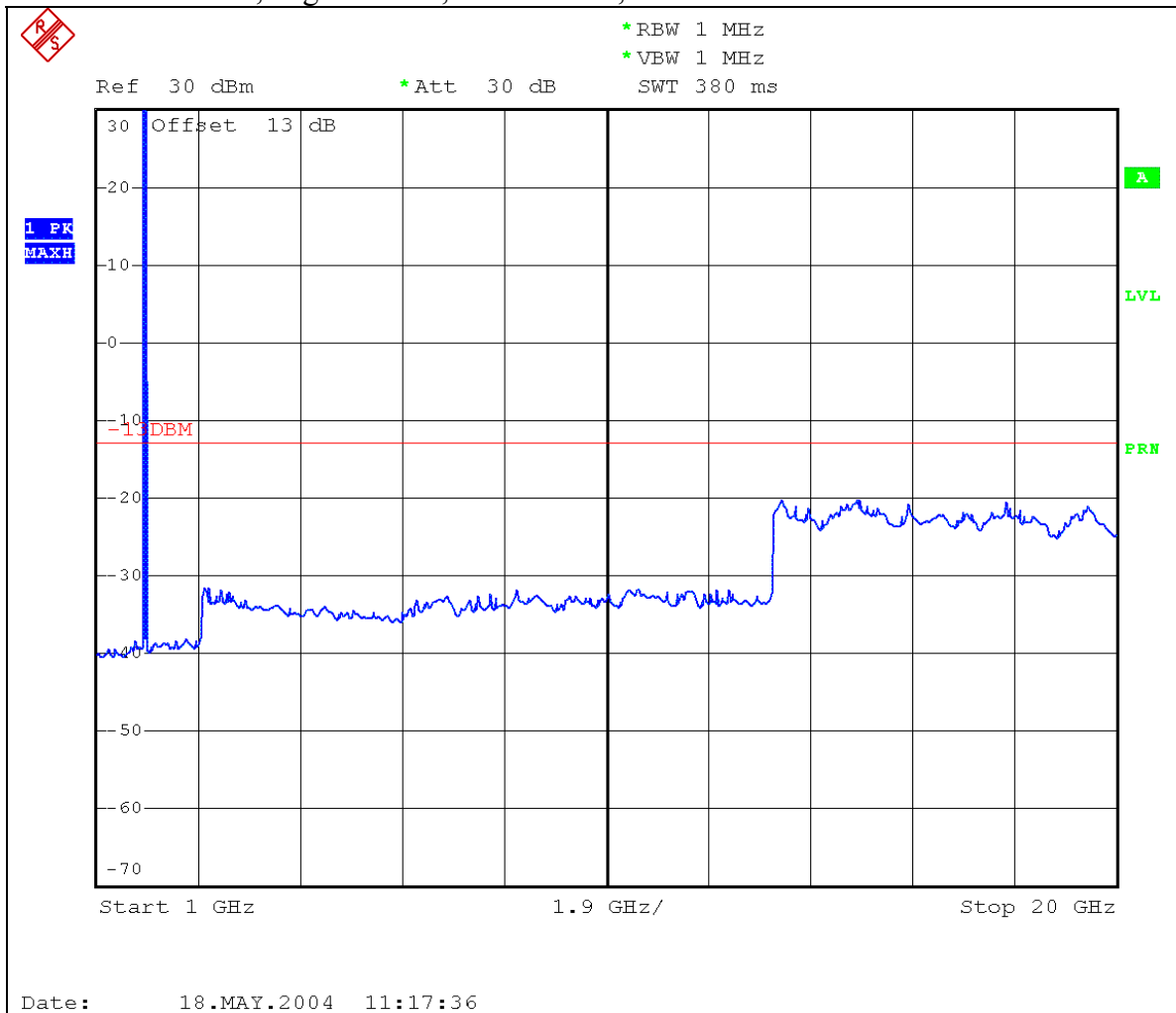

Strong emission shown is the carrier signal.

Plot 6.4.28) Out of Band Emissions at Antenna Terminals
 8-PSK, Low channel, 1851.2 MHz, 1 MHz to 1 GHz

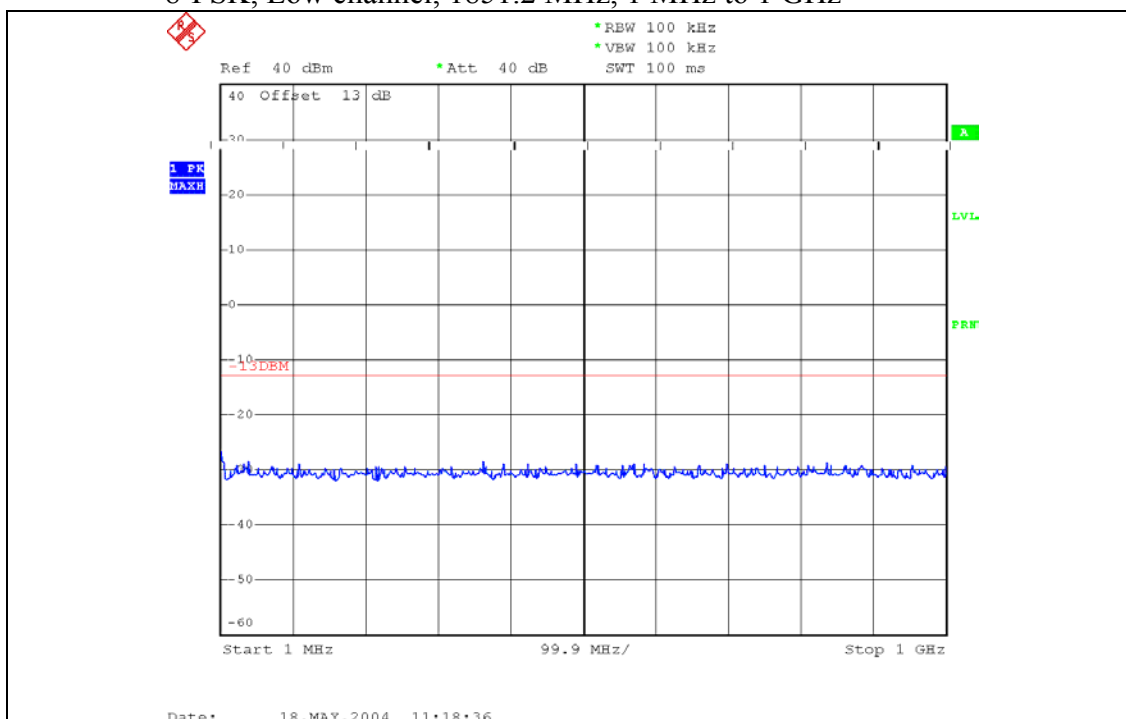

Plot 6.4.29) Out of Band Emissions at Antenna Terminals
 8-PSK, Low channel, 1851.2 MHz, TX signal +/- 20 MHz

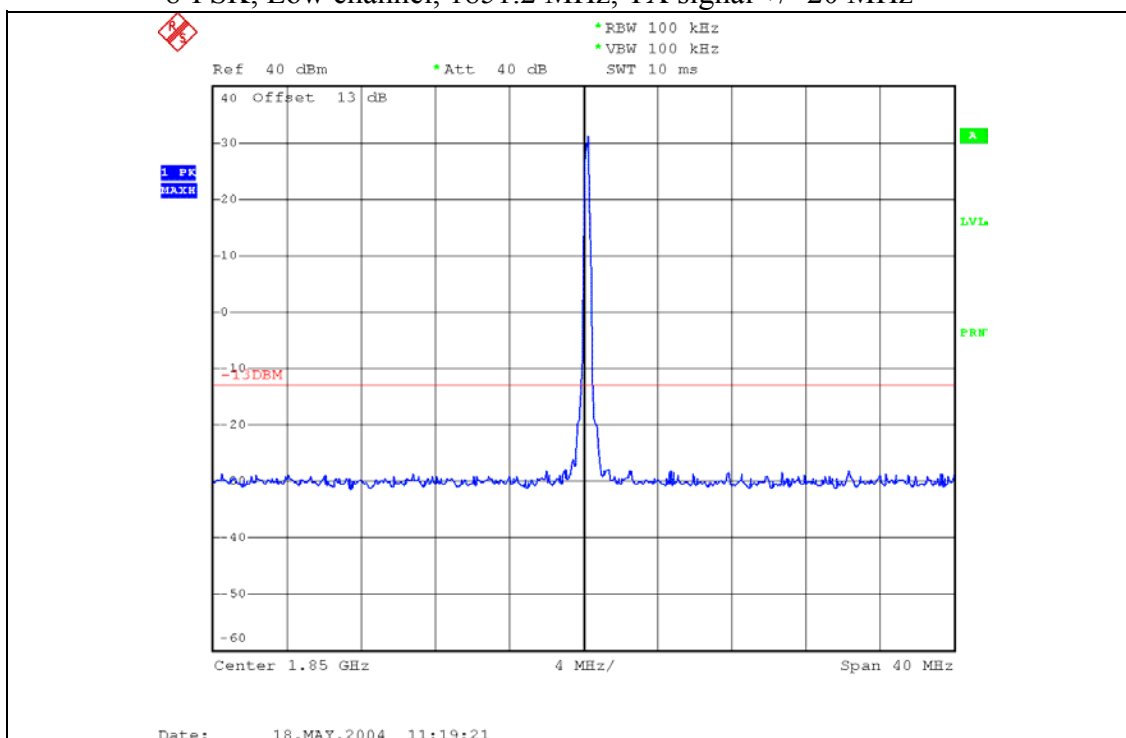

SIERRA WIRELESS, INC.

Plot 6.4.30) Out of Band Emissions at Antenna Terminals
8-PSK, Low channel, 1851.2 MHz, 1 GHz to 20 GHz

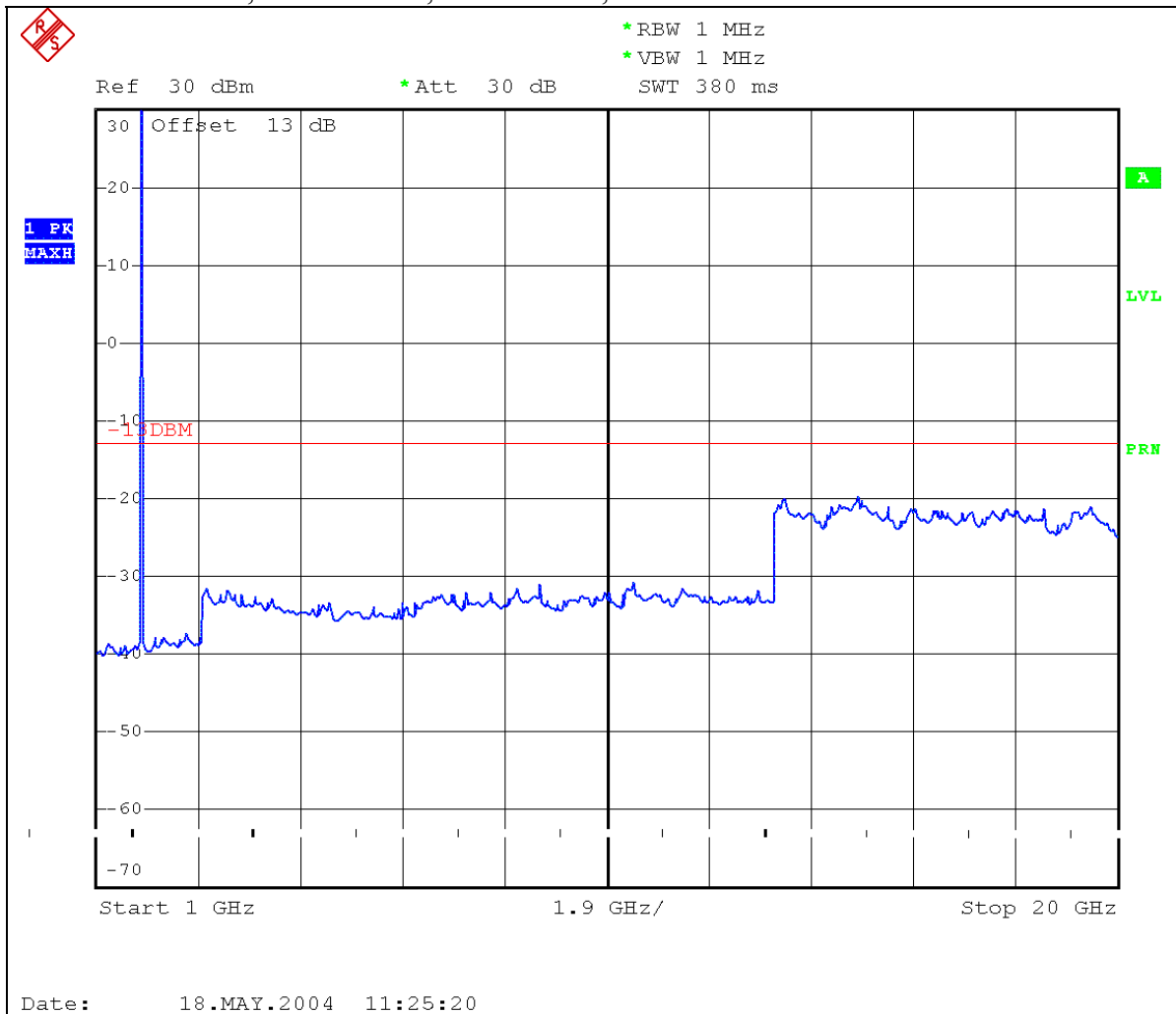

Strong emission shown is the carrier signal.

Plot 6.4.31) Out of Band Emissions at Antenna Terminals
8-PSK, Middle channel, 1880.0 MHz, 1 MHz to 1 GHz

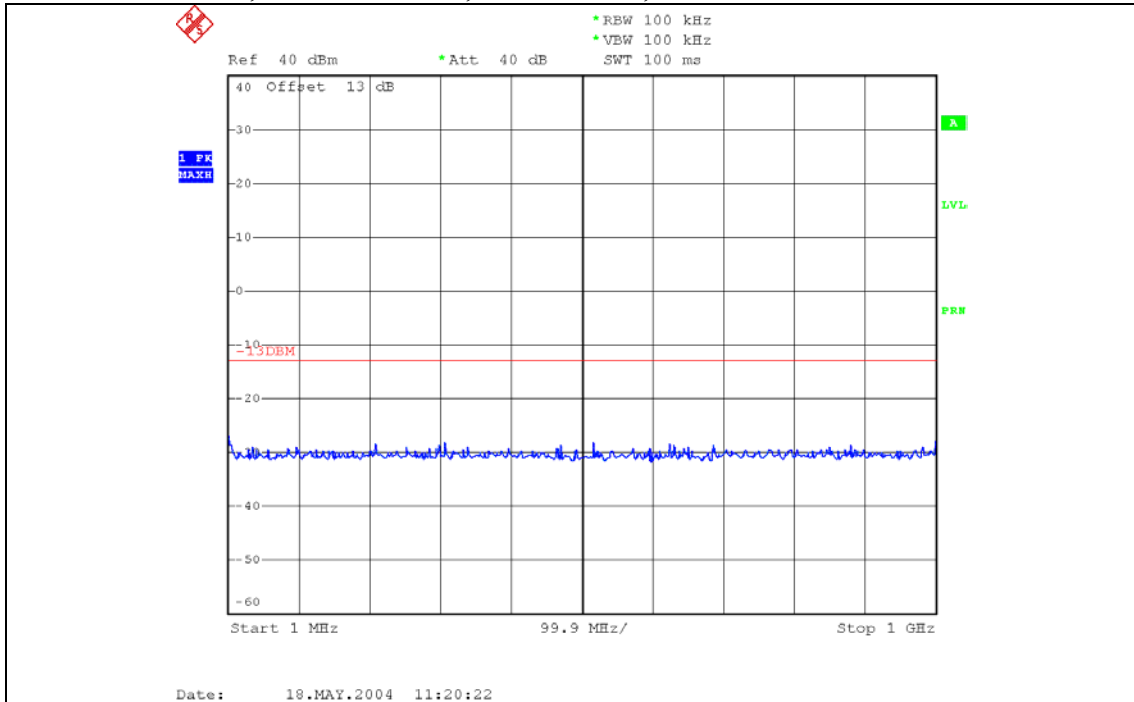

Plot 6.4.32) Out of Band Emissions at Antenna Terminals
8-PSK, Middle channel, 1880.0 MHz, TX signal +/- 20 MHz

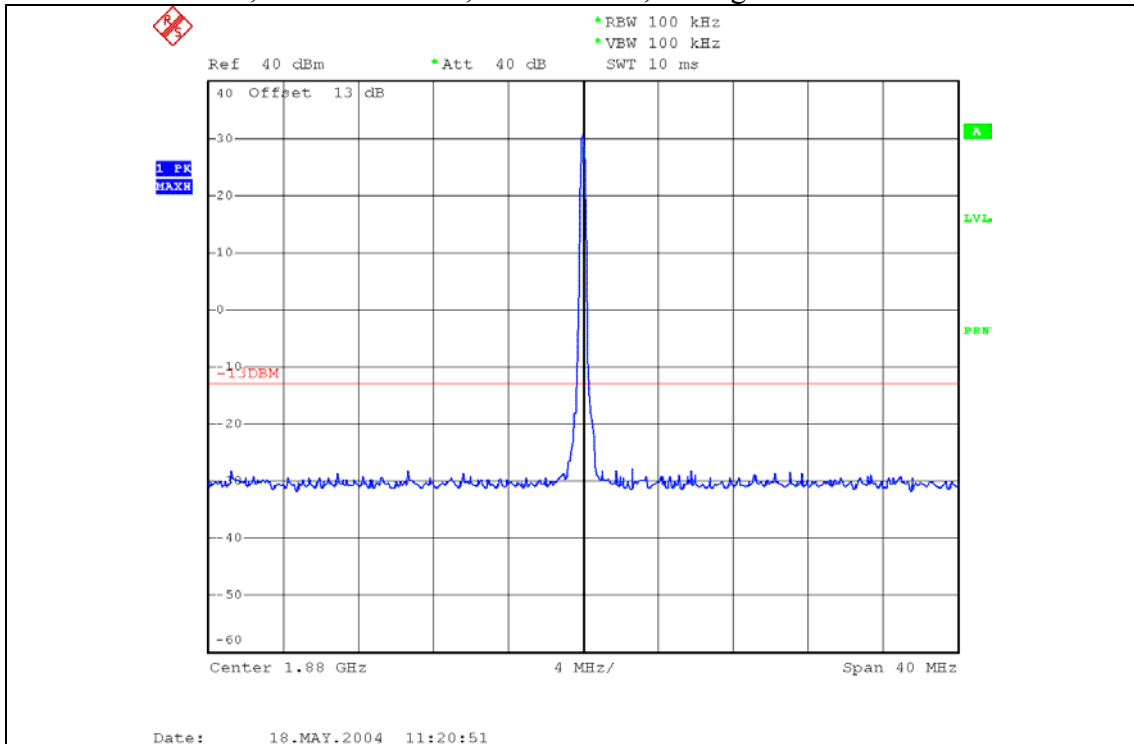

SIERRA WIRELESS, INC.

Plot 6.4.33) Out of Band Emissions at Antenna Terminals
8-PSK, Middle channel, 1880.0 MHz, 1 GHz to 20 GHz

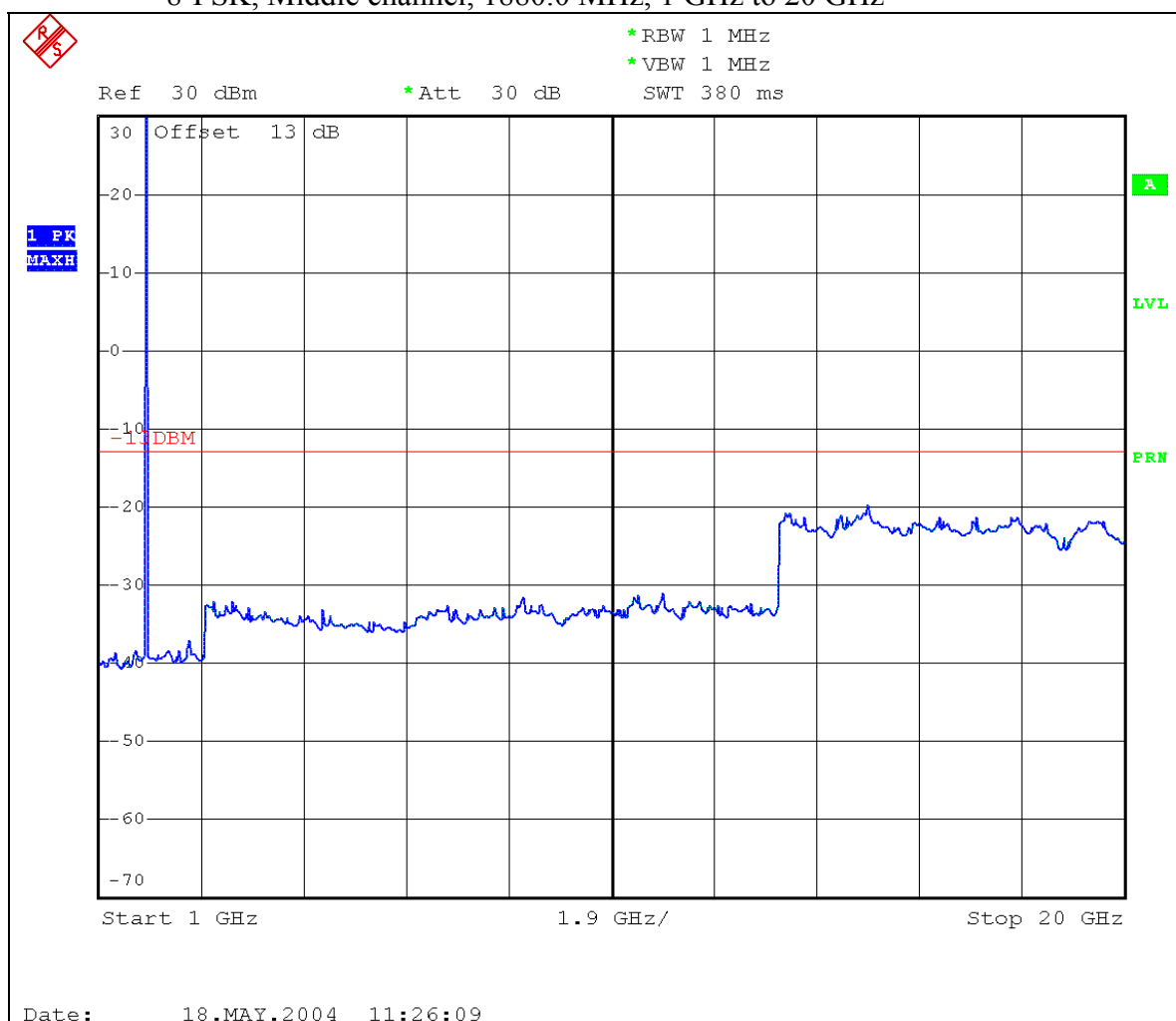

Strong emission shown is the carrier signal.

Plot 6.4.34) Out of Band Emissions at Antenna Terminals
 8-PSK, High channel, 1909.8 MHz, 1 MHz to 1 GHz

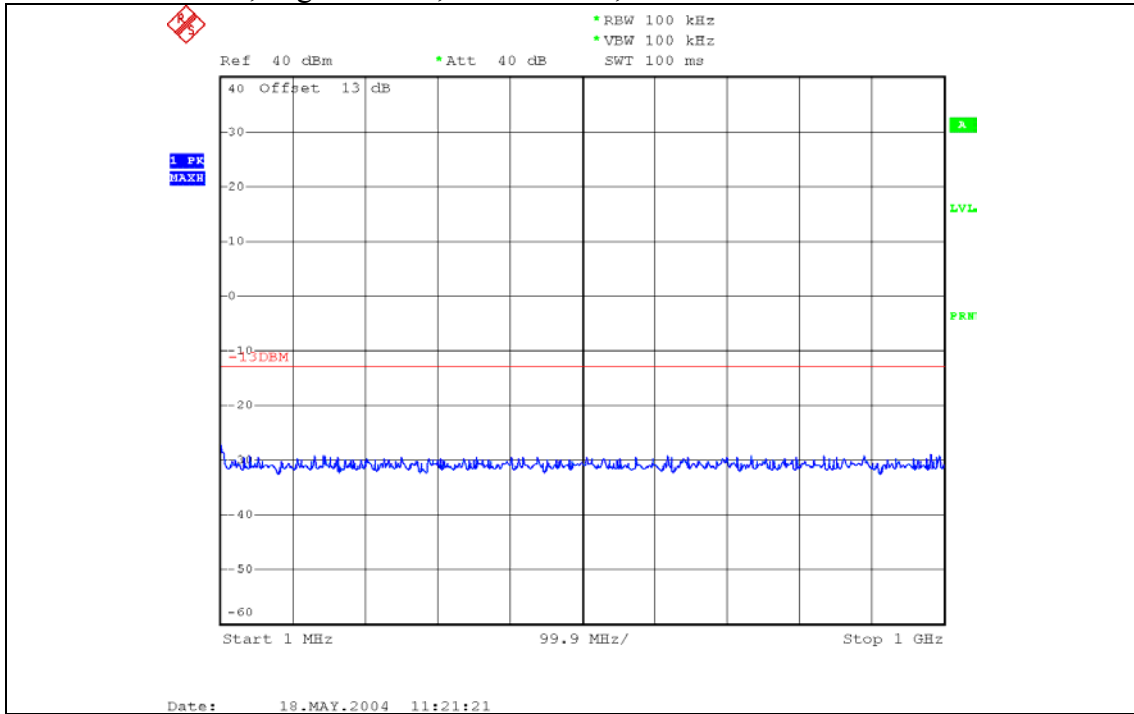

Plot 6.4.35) Out of Band Emissions at Antenna Terminals
 8-PSK, High channel, 1909.8 MHz, TX signal +/- 20 MHz

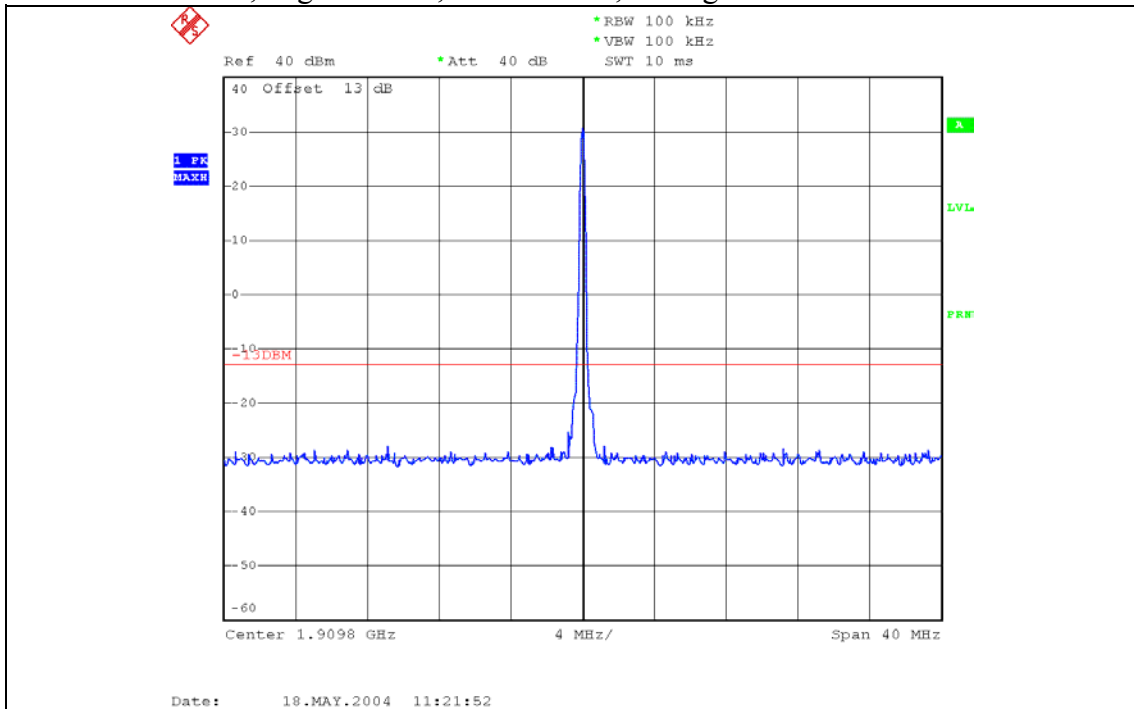

**Plot 6.4.37) Emissions in Base Station Frequency Range, Cellular band
GMSK, Low channel, 824.200 MHz**

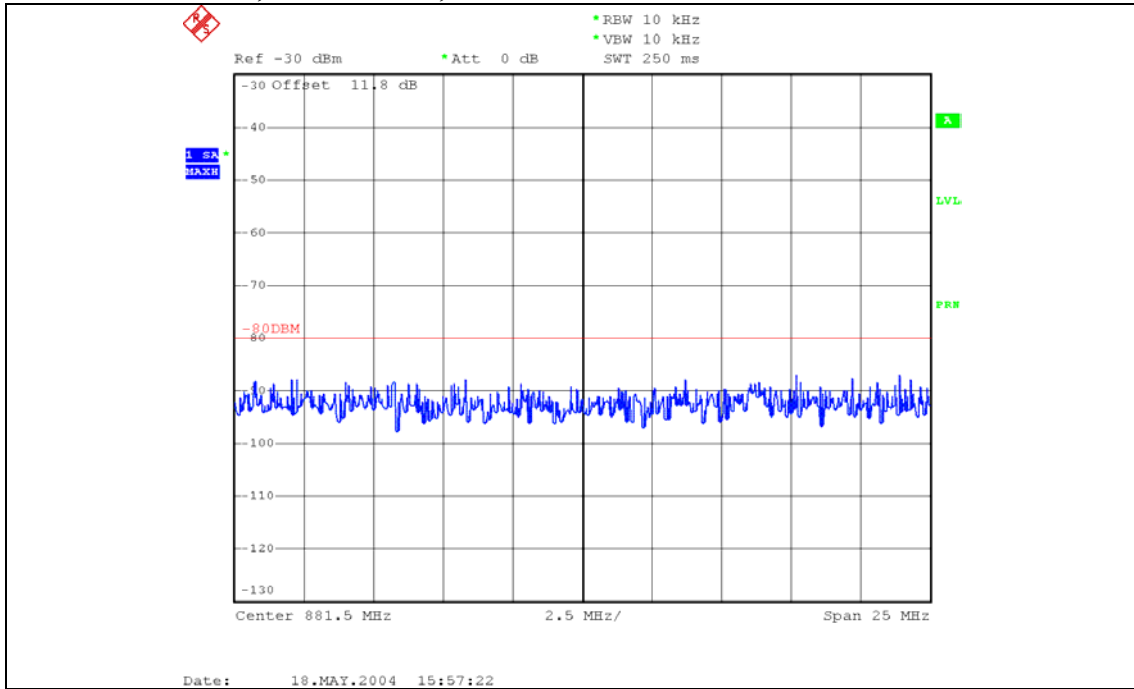

**Plot 6.4.38) Emissions in Base Station Frequency Range, Cellular band
GMSK, Middle channel, 836.600 MHz**

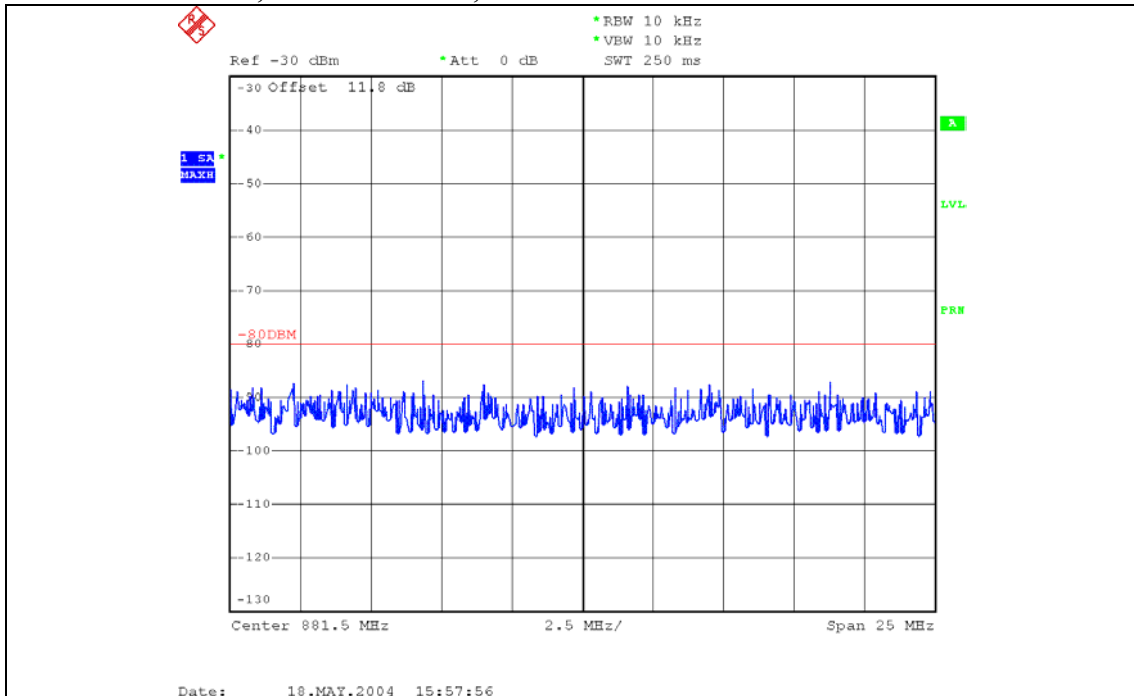

**Plot 6.4.39) Emissions in Base Station Frequency Range, Cellular band
GMSK, High channel, 848.800 MHz**

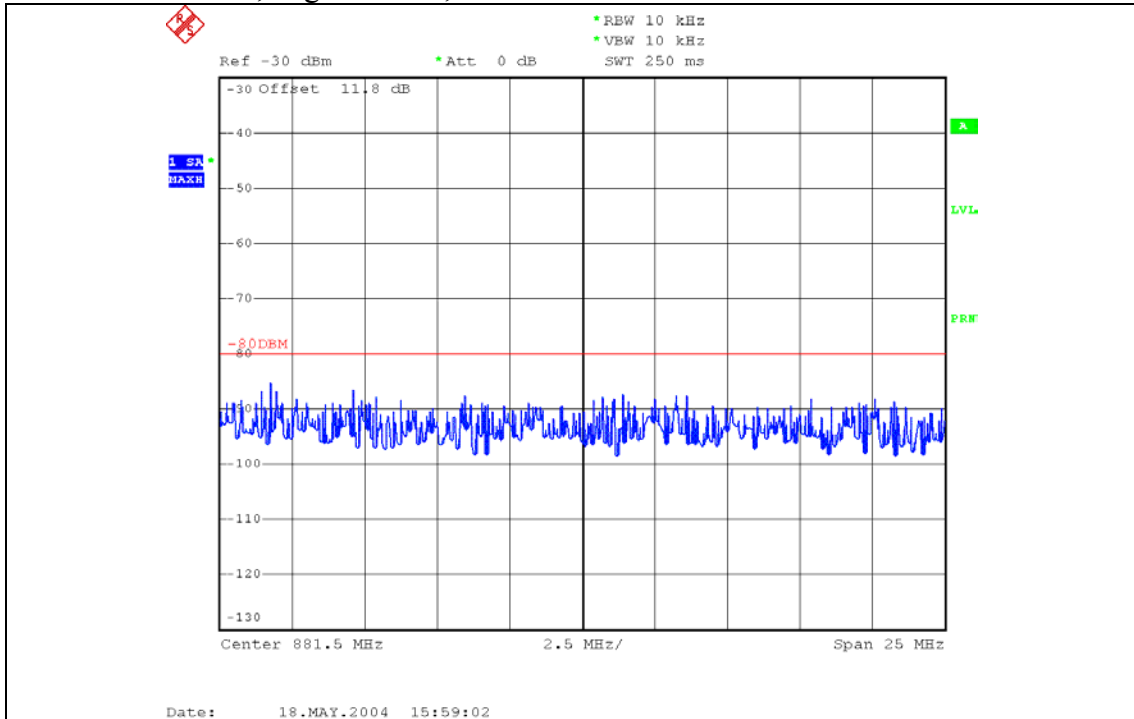

**Plot 6.4.40) Emissions in Base Station Frequency Range, Cellular band
8-PSK, Low channel, 824.200 MHz**

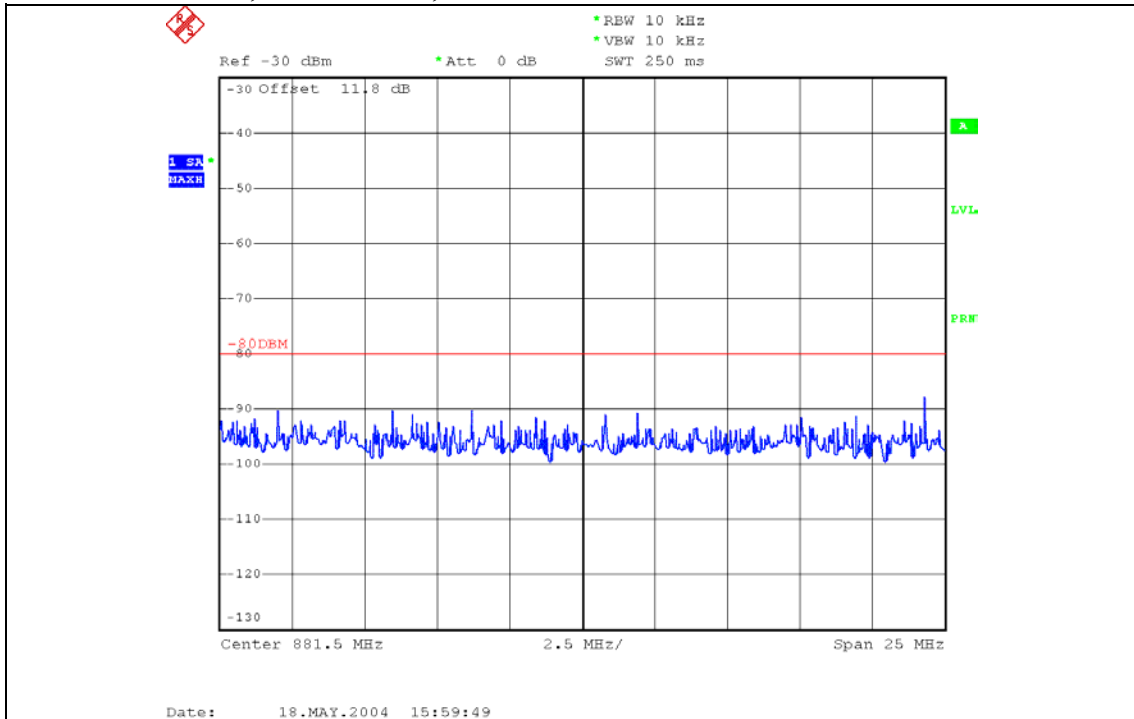

SIERRA WIRELESS, INC.

**Plot 6.4.41) Emissions in Base Station Frequency Range, Cellular band
8-PSK, Middle channel, 836.600 MHz**

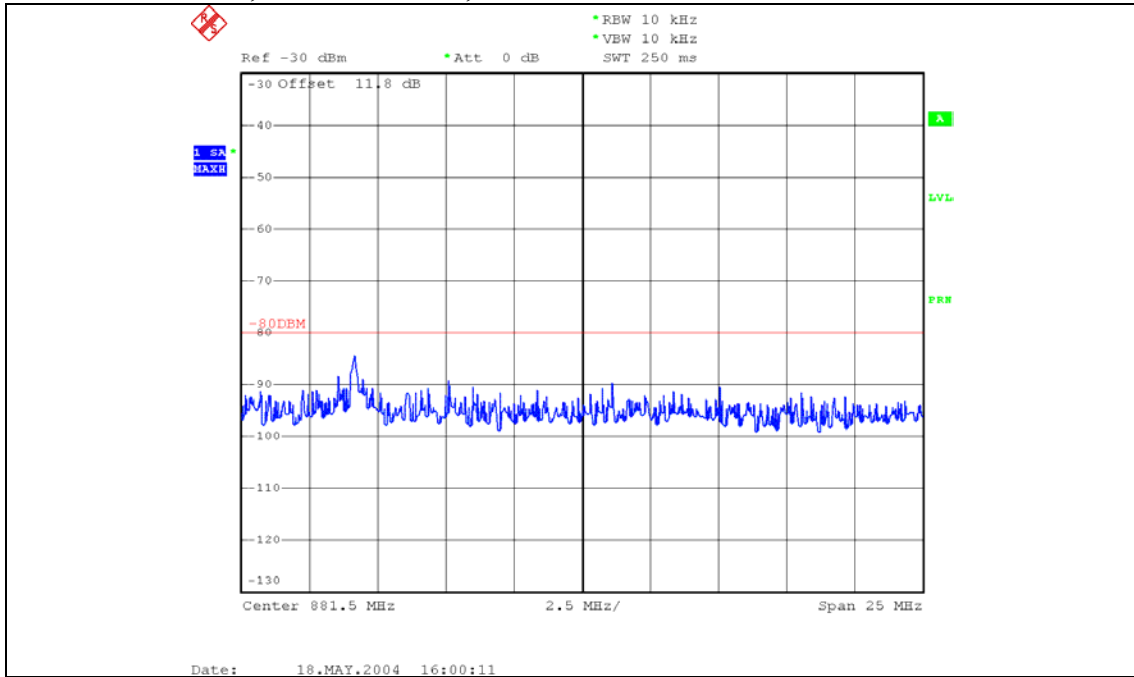

**Plot 6.4.42) Emissions in Base Station Frequency Range, Cellular band
8-PSK, High channel, 848.800 MHz**

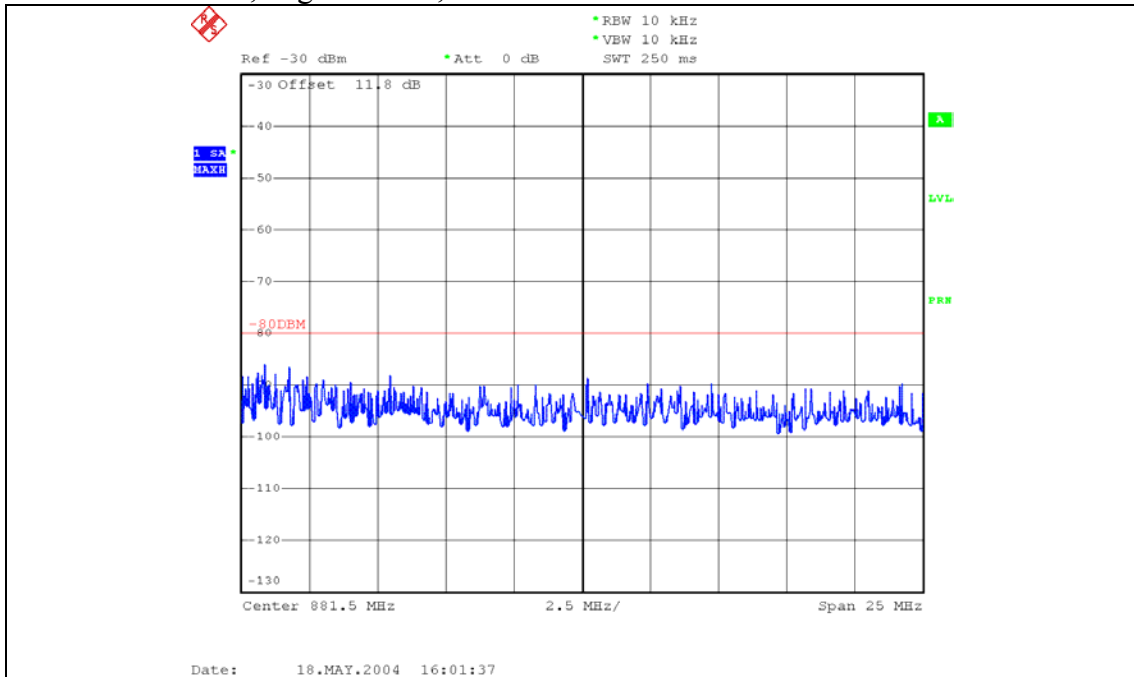

7 Block Edge Compliance

FCC part 22H/24E

7.1 Test Procedure

The transmitter output was connected to a Rohde & Schwarz CMU200 Test Set and configured to operate at maximum power. The block edge emissions were measured at the required operating frequencies in each band on the Spectrum Analyzer.

Test Setup

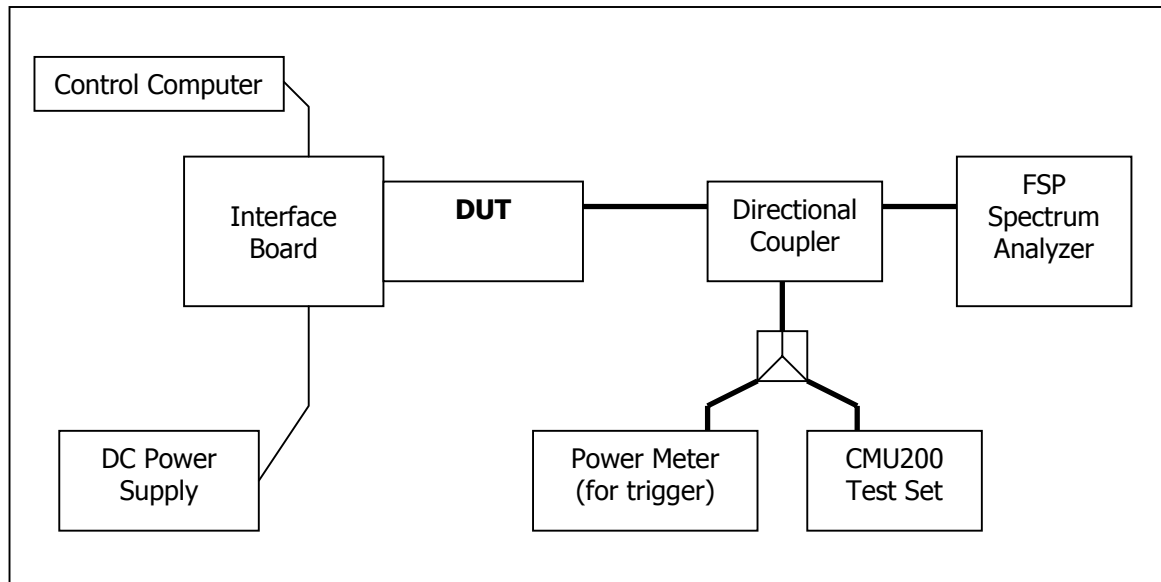

7.2 Test Equipment

Instrument List

EQUIPMENT	MANUFACTURER	MODEL NO.	SERIAL NO.	CAL. DATE
Control Computer	TC	Generic PC	100488	N/A
Wireless Test Set	Rohde & Schwarz	CMU200	836766/030	N/A
Spectrum Analyzer	Rohde & Schwarz	FSP 30GHz	US41421268	Sept. 12, 2003
DC Power Supply	HP	E3631A	100060	N/A
Interface Board	Shop built	Minnow	N/A	N/A
Directional Coupler	Pasternack	PE2209-10	N/A	N/A

SIERRA WIRELESS, INC.

FCC Part 22 & 24 Test Report	AC775	May 20, 2004	Page 50 of 60
------------------------------	-------	--------------	---------------

7.3 Test Results

Block Test	Frequency Boundaries (MHz)	Channels Tested	Corresponding Plots	Result
1	GMSK: Below 824 MHz, above 849 MHz	128, 251	7.4.1, 7.4.2	Complies
2	8PSK: Below 824 MHz, above 849 MHz	128, 251	7.4.3, 7.4.4	Complies
3	GMSK: Below 1850MHz, above 1910MHz	512, 810	7.4.5, 7.4.6	Complies
4	8PSK: Below 1850MHz, above 1910MHz	512, 810	7.4.7, 7.4.8	Complies

SIERRA WIRELESS, INC.

7.4 Test Plots

Plot 7.4.1) GSMK; Cellular low channel, below 824 MHz

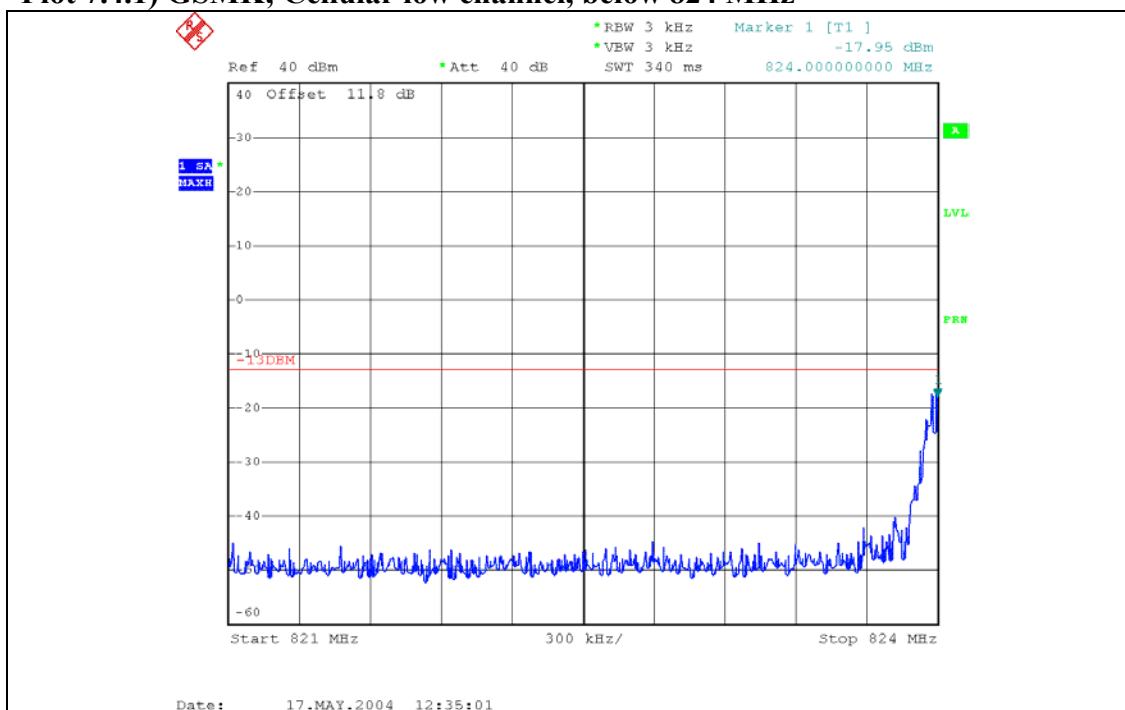

Plot 7.4.2) GSMK; Cellular high channel, above 849 MHz

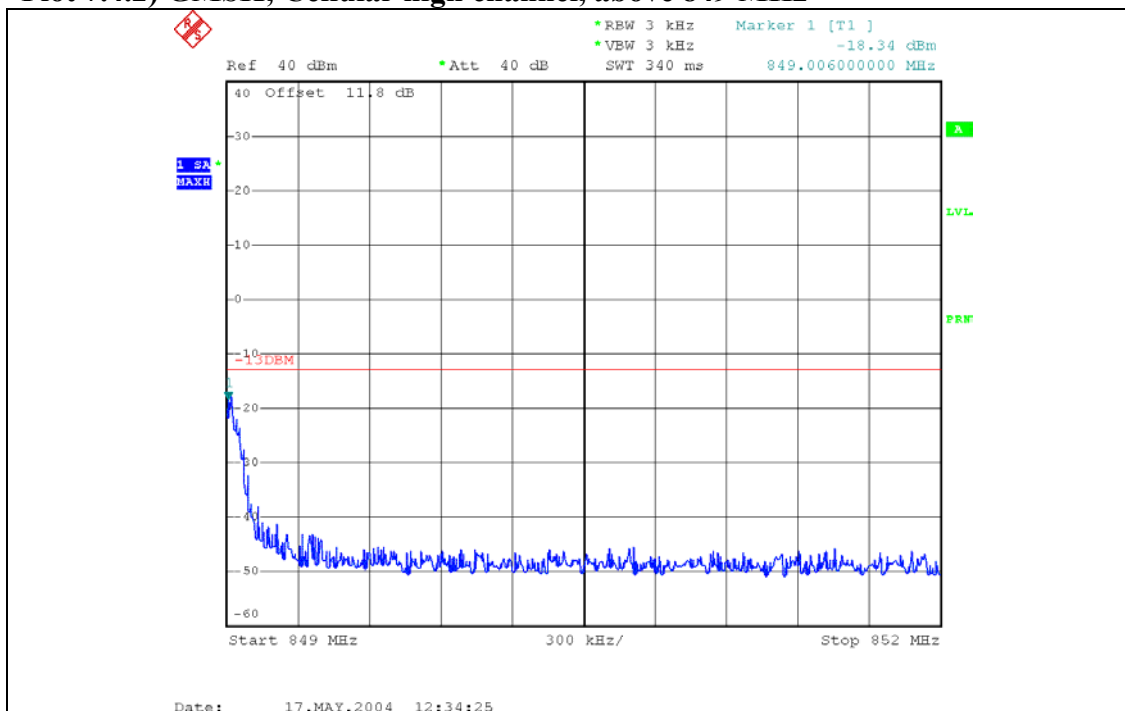

SIERRA WIRELESS, INC.

Plot 7.4.3) 8-PSK; Cellular low channel, below 824 MHz

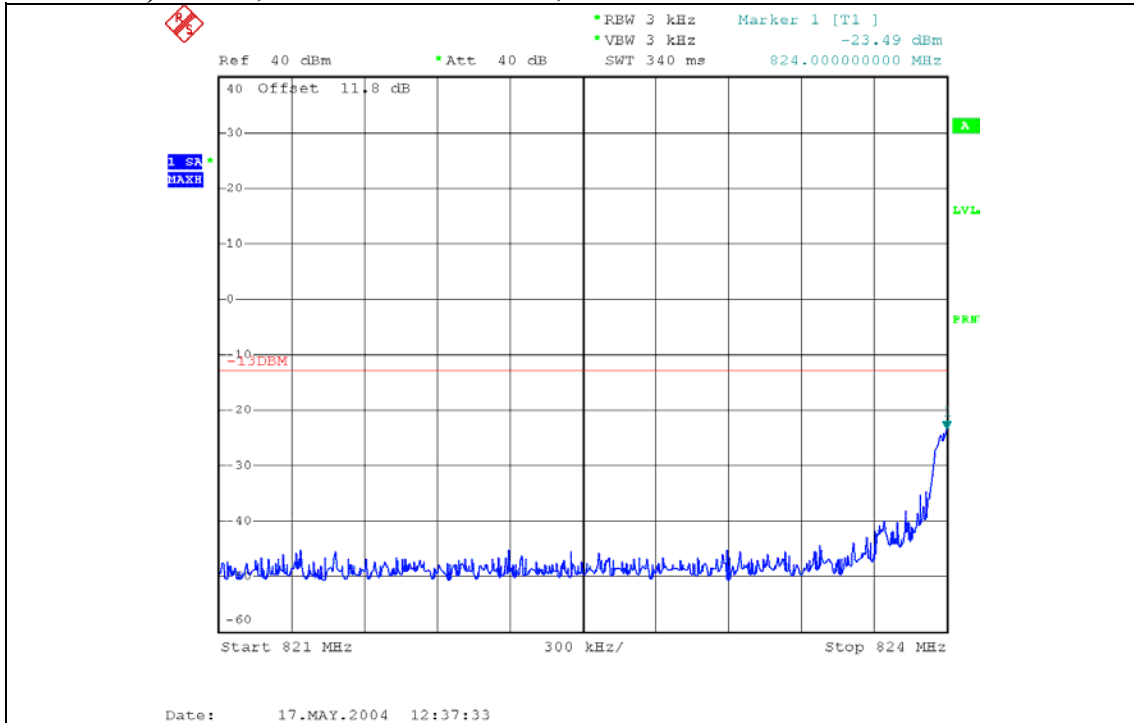

Plot 7.4.4) 8-PSK; Cellular high channel, above 849 MHz

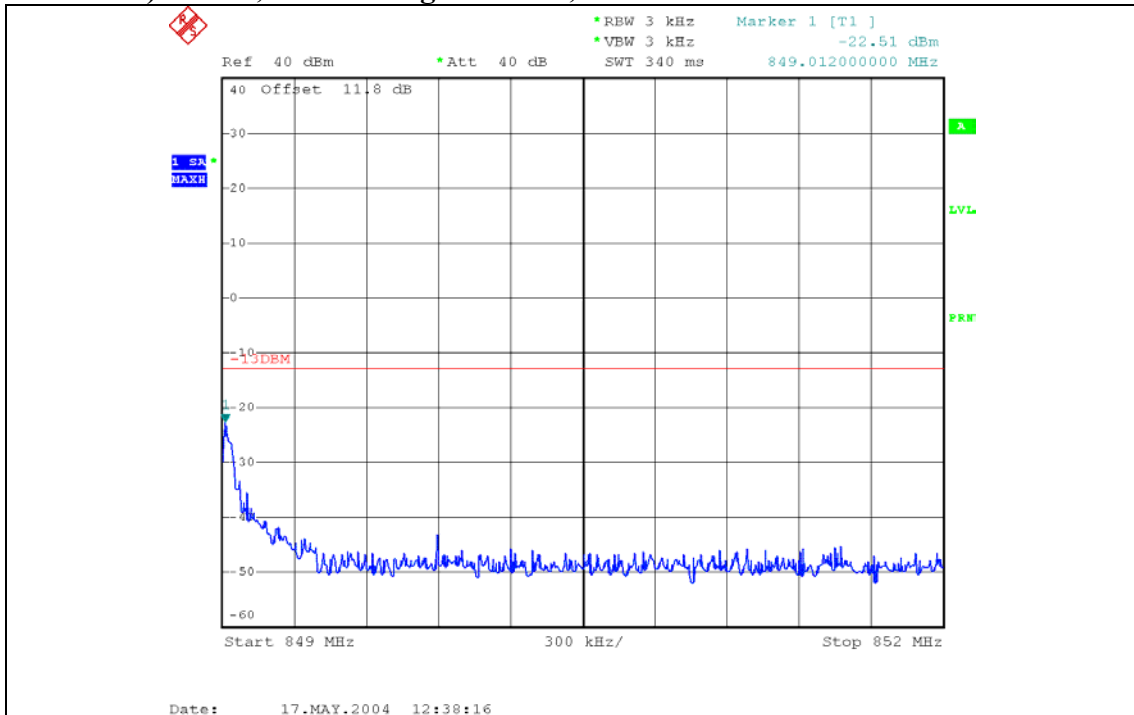

SIERRA WIRELESS, INC.

Plot 7.4.5) GMSK; PCS low channel, below 1850 MHz

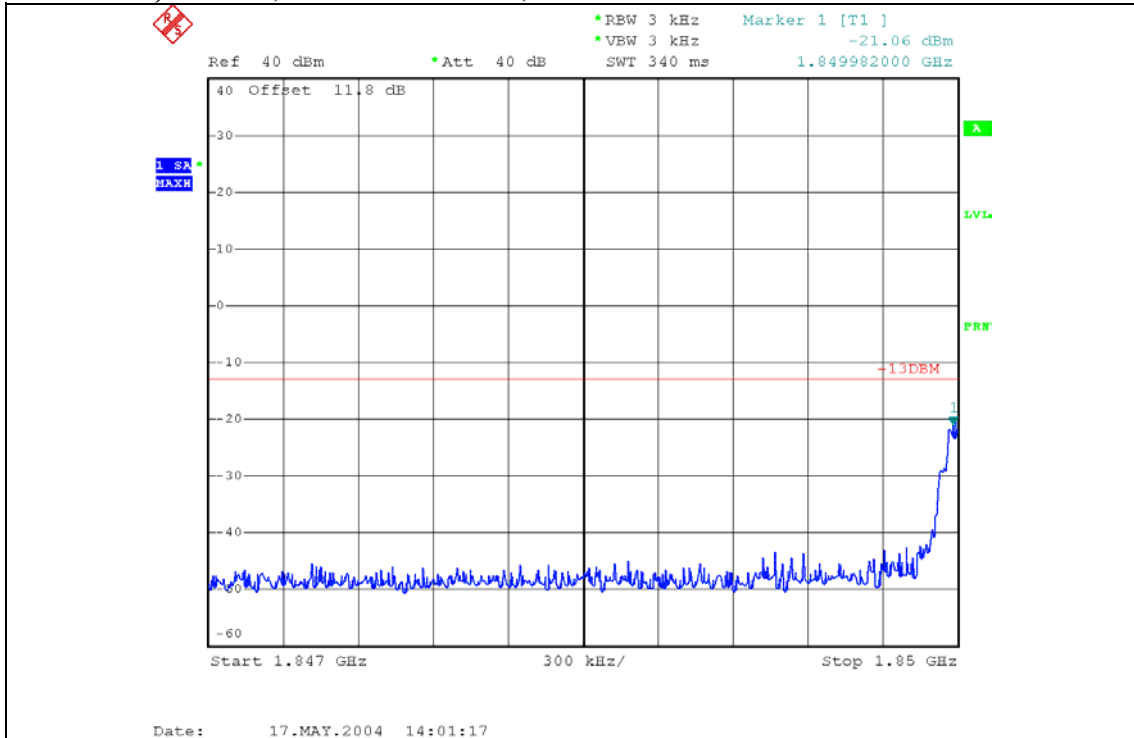

Plot 7.4.6) GMSK; PCS high channel, above 1910 MHz

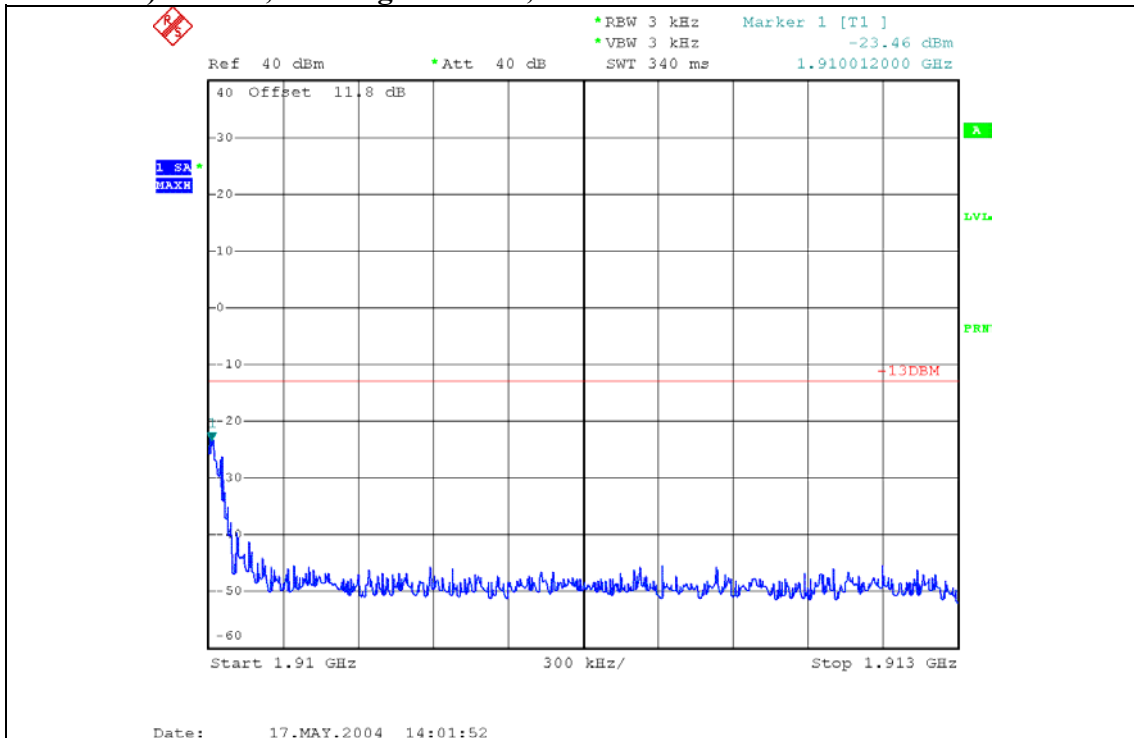

SIERRA WIRELESS, INC.

Plot 7.4.7) 8-PSK; PCS low channel, below 1850 MHz

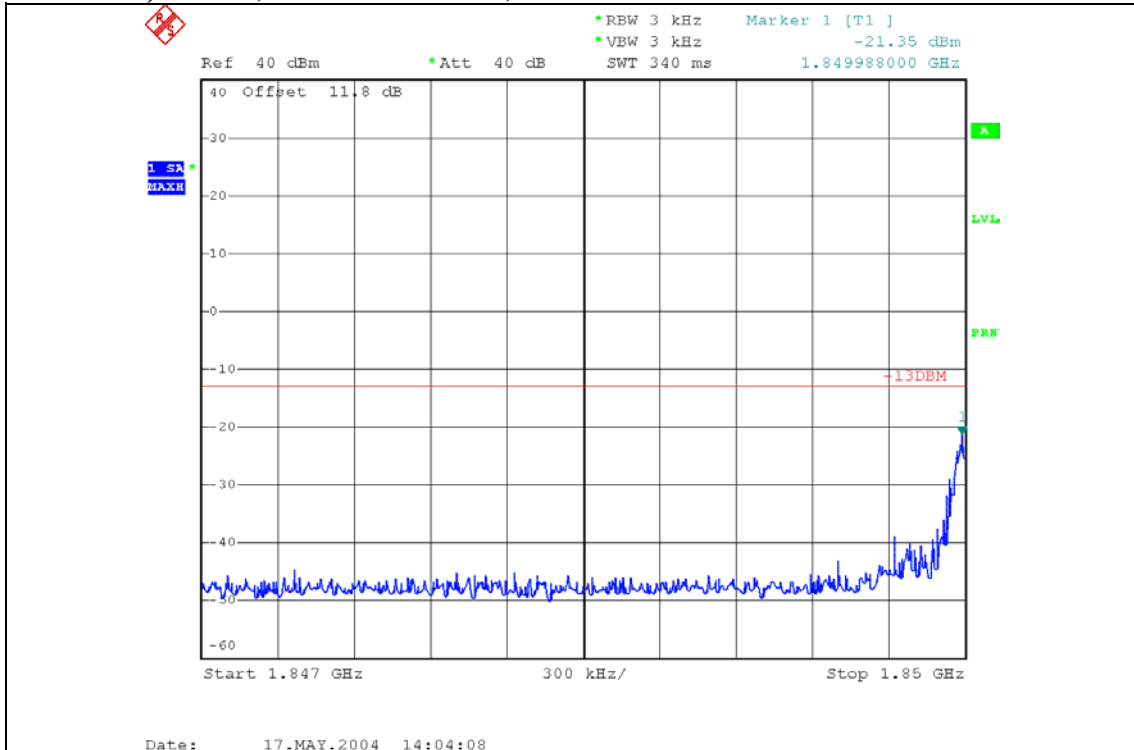

Plot 7.4.8) 8-PSK; PCS high channel, above 1910 MHz

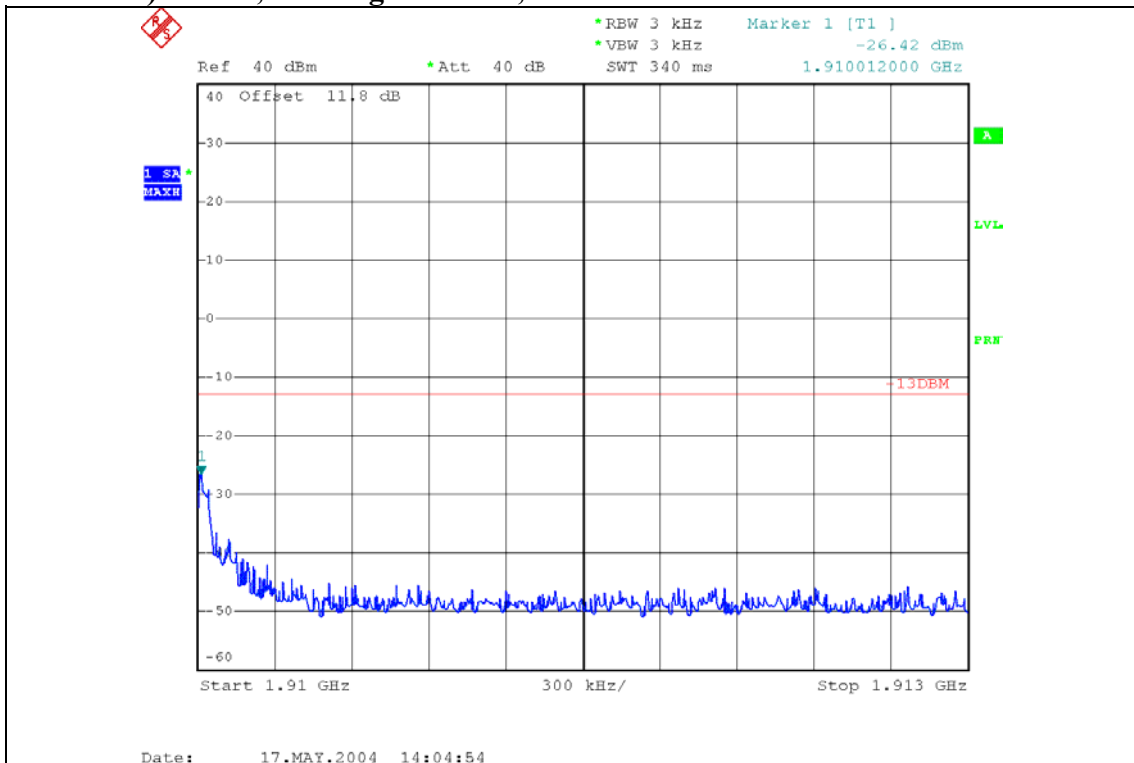

8 Frequency Stability Versus Temperature

FCC 2.1055

8.1 Summary of Results

The AC755 Frequency Stability versus temperature meets the requirement of being within ± 0.1 ppm of the received base station frequency.

8.2 Test Procedure

The AC755 was placed inside the temperature chamber. The transmitting frequency error is measured at 25 degrees C, then the temperature is set to +60 degrees C and allowed to stabilize. After sufficient soak time, the transmitting frequency error is measured. The temperature is decreased by 10 degrees, allowed to stabilize and soak, then the measurement is repeated. This is repeated until -20 degrees C is completed. The process is then repeated back up to +60 degrees C. Frequency metering included internal averaging of the CMU200 to stabilize the reading. Reference power supply voltage for these tests is 5.0 volts.

Test Setup

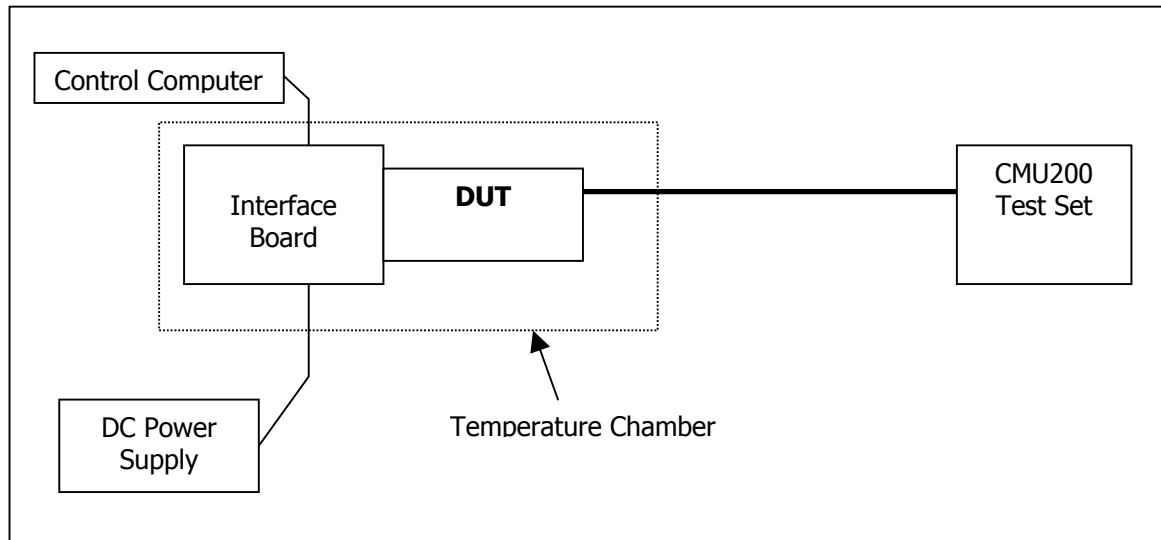

8.3 Test Equipment

EQUIPMENT	MANUFACTURER	MODEL NO.	SERIAL NO.	CAL. DATE
Control Computer	TC	Generic PC	100488	N/A
Wireless Test Set	Rohde & Schwarz	CMU200	836766/030	N/A
Spectrum Analyzer	Rohde & Schwarz	FSP 30GHz	US41421268	Sept. 12, 2003
DC Power Supply	HP	E3631A	100060	N/A
Interface Board	Shop built	Minnow	N/A	N/A

8.4 Test Results

High to Low Temperature Frequency Error

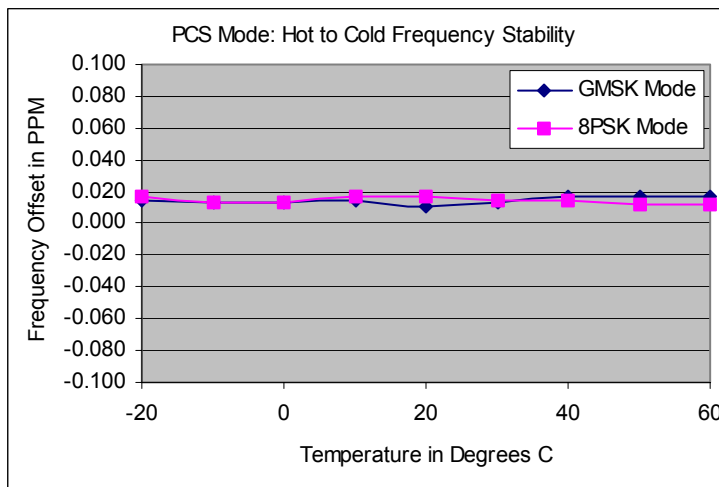
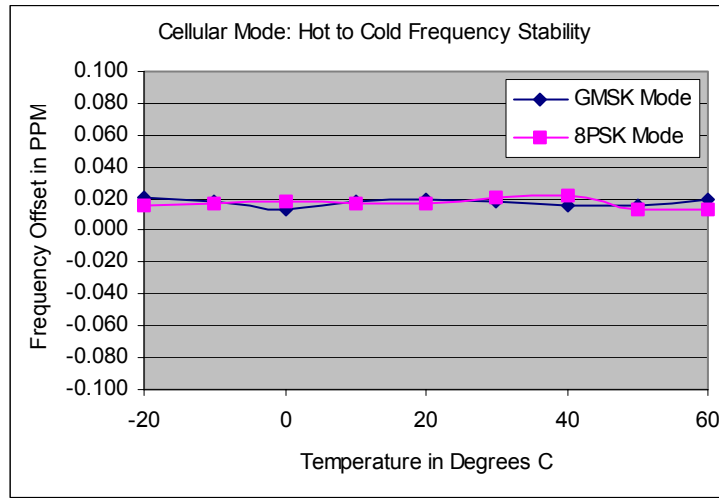

High to Low Temperature Tabular Readings

Temp.(C)	Cellular Mode: 824MHz to 848MHz				PCS Mode: 1850MHz to 1909MHz			
	GMSK Mode		8-PSK Mode		GMSK Mode		8-PSK Mode	
	Offset (Hz)	Offset (ppm)	Offset (Hz)	Offset (ppm)	Offset (Hz)	Offset (ppm)	Offset (Hz)	Offset (ppm)
60	16	0.019	11	0.013	24	0.013	27	0.014
50	13	0.016	11	0.013	21	0.011	32	0.017
40	13	0.016	18	0.022	22	0.012	21	0.011
30	15	0.018	17	0.020	30	0.016	21	0.011
20	16	0.019	14	0.017	25	0.013	23	0.012
10	15	0.018	14	0.017	26	0.014	27	0.014
0	11	0.013	15	0.018	21	0.011	26	0.014
-10	15	0.018	14	0.017	21	0.011	34	0.018
-20	17	0.020	13	0.016	28	0.015	33	0.018

SIERRA WIRELESS, INC.

Low to High Temperature Frequency Error

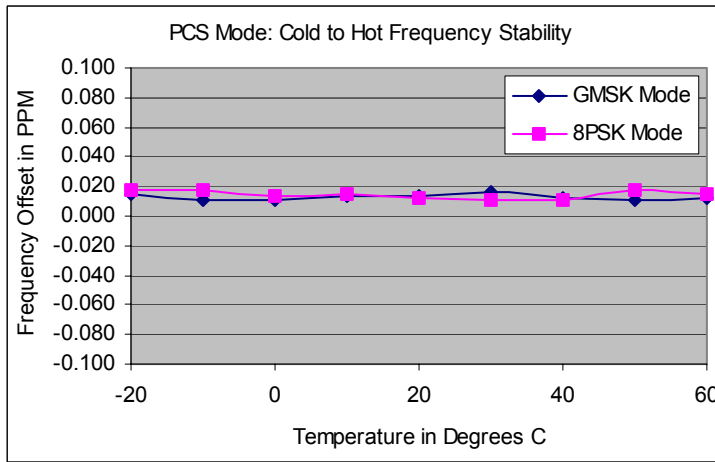
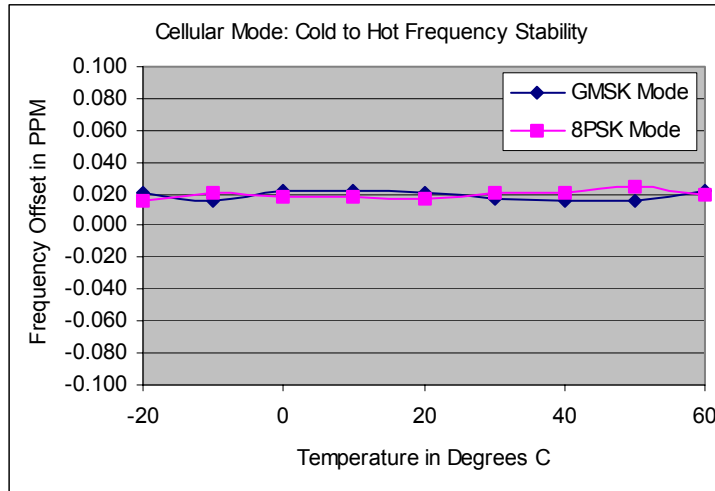

Low to High Temperature Tabular Readings

Temp.(C)	Cellular Mode: 824MHz to 848MHz				PCS Mode: 1850MHz to 1909MHz			
	GMSK Mode		8-PSK Mode		GMSK Mode		8-PSK Mode	
	Offset (Hz)	Offset (ppm)	Offset (Hz)	Offset (ppm)	Offset (Hz)	Offset (ppm)	Offset (Hz)	Offset (ppm)
-20	17	0.020	13	0.016	28	0.015	33	0.018
-10	13	0.016	17	0.020	25	0.013	24	0.013
0	18	0.022	15	0.018	25	0.013	24	0.013
10	18	0.022	15	0.018	28	0.015	33	0.018
20	17	0.020	14	0.017	20	0.011	31	0.016
30	14	0.017	17	0.020	25	0.013	28	0.015
40	13	0.016	17	0.020	33	0.018	28	0.015
50	13	0.016	21	0.025	33	0.018	23	0.012
60	18	0.022	16	0.019	31	0.016	22	0.012

9 Frequency Stability Versus Voltage

FCC 2.1055

9.1 Summary of Results

The unit meets the limit of less than 0.1ppm of frequency offset from center for 85% and 115% of the supply voltage for 5.0 volts.

9.2 Test Procedure

The AC755 was connected to a DC Power Supply and a GSM test set (CMU 200) with frequency error measurement capability. The power supply output is adjusted to the test voltage as measured at the input terminals to the module while transmitting. A voltmeter was used to confirm the terminal voltage. The peak frequency error is recorded (worst case).

The test voltages are 4.25 volts to 5.75 volts.

Test Setup

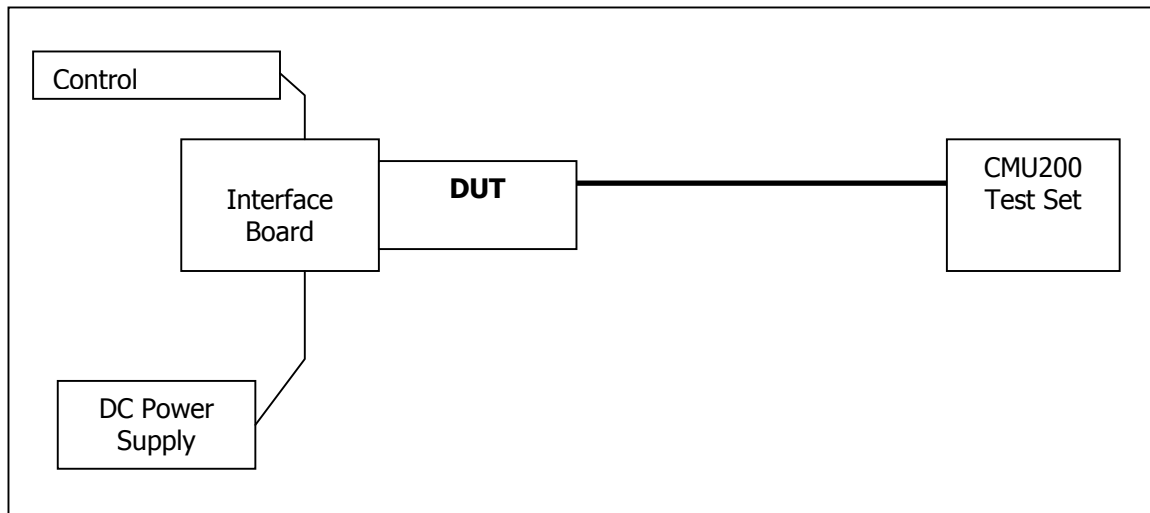

9.3 Test Equipment

EQUIPMENT	MANUFACTURER	MODEL NO.	SERIAL NO.	CAL. DATE
Control Computer	TC	Generic PC	100488	N/A
Wireless Test Set	Rohde & Schwarz	CMU200	836766/030	N/A
Spectrum Analyzer	Rohde & Schwarz	FSP 30GHz	US41421268	Sept. 12, 2003
DC Power Supply	HP	E3631A	100060	N/A
Interface Board	Shop built	Minnow	N/A	N/A

9.4 Test Results

85% to 115% of 5 Volts Frequency Error

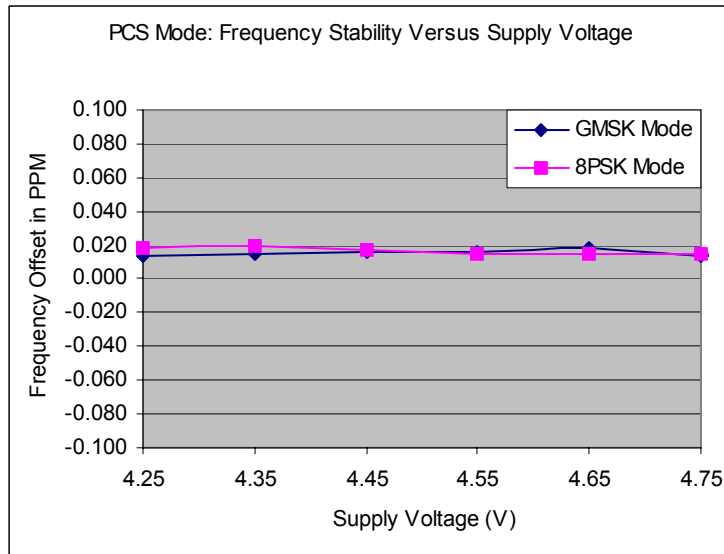
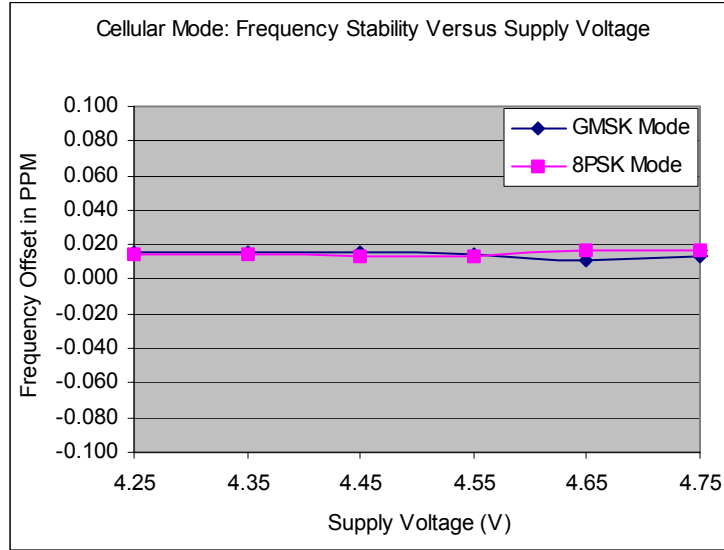

SIERRA WIRELESS, INC.

85% to 115% of 5 Volts Frequency Error, Tabular Data

Supply (V)	Cellular Mode: 824MHz to 848MHz				PCS Mode: 1850MHz to 1909MHz			
	GMSK Mode		8-PSK Mode		GMSK Mode		8-PSK Mode	
	Offset (Hz)	Offset (ppm)	Offset (Hz)	Offset (ppm)	Offset (Hz)	Offset (ppm)	Offset (Hz)	Offset (ppm)
4.25	13	0.016	12	0.014	26	0.014	34	0.018
4.35	13	0.016	12	0.014	28	0.015	37	0.020
4.45	13	0.016	11	0.013	31	0.016	33	0.018
4.55	12	0.014	11	0.013	31	0.016	28	0.015
4.65	9	0.011	14	0.017	34	0.018	27	0.014
4.75	11	0.013	14	0.017	26	0.014	27	0.014
4.85	13	0.016	13	0.016	25	0.013	28	0.015
4.95	13	0.016	13	0.016	24	0.013	29	0.015
5.05	12	0.014	13	0.016	27	0.014	31	0.016
5.15	12	0.014	10	0.012	28	0.015	31	0.016
5.25	12	0.014	9	0.011	27	0.014	30	0.016
5.35	12	0.014	9	0.011	29	0.015	31	0.016
5.45	14	0.017	12	0.014	31	0.016	31	0.016
5.55	14	0.017	13	0.016	31	0.016	24	0.013
5.65	13	0.016	11	0.013	28	0.015	25	0.013
5.75	12	0.014	11	0.013	24	0.013	27	0.014