



FCC Parts 22 and 24 Test Report

For

800/1800/1900 MHz GSM PC CARD WIRELESS
MODEM

Model: AIRCARD 755

FCC ID: N7NAC755

**Prepared by
SIERRA WIRELESS INC.
13811 WIRELESS WAY
RICHMOND, BC V6V 3A4
CANADA**

Test Date(s): October 2003

© 2003 Sierra Wireless, Inc.

This document contains information which is proprietary and confidential to Sierra Wireless, Inc. Disclosure to persons other than the officers, employees, agents, or subcontractors of the Company or licensee of this document without the prior written permission of Sierra Wireless, Inc. is strictly prohibited.

SIERRA WIRELESS, INC.

FCC Part 22 & 24 Test Report	AC755	Oct., 2003	Page 2 of 45
------------------------------	-------	------------	--------------

Table of Contents

1	Introduction and Purpose	3
2	Test Summary	3
3	Description of Equipment Under Test	4
4	RF Power Output	5
4.1	<i>Test Procedure</i>	5
4.2	<i>Test Equipment</i>	5
4.3	<i>Test Results</i>	5
5	Occupied Bandwidth	6
5.1	<i>Test Procedure</i>	6
5.2	<i>Test Results</i>	6
5.3	<i>Test Plots</i>	8
6	Out of Band Emissions at Antenna Terminals	14
6.1	<i>Test Procedure</i>	14
6.2	<i>Test Equipment</i>	14
6.3	<i>Test Results</i>	14
6.4	<i>Test Plots</i>	16
7	Block Edge Compliance	28
7.1	<i>Test Procedure</i>	28
7.2	<i>Test Equipment</i>	28
7.3	<i>Test Results</i>	29
7.4	<i>Test Plots</i>	30
8	Frequency Stability Versus Temperature	40
8.1	<i>Summary of Results</i>	40
8.2	<i>Test Procedure</i>	40
8.3	<i>Test Equipment</i>	40
8.4	<i>Test Results</i>	41
9	Frequency Stability Versus Voltage	43
9.1	<i>Summary of Results</i>	43
9.2	<i>Test Procedure</i>	43
9.3	<i>Test Equipment</i>	43
9.4	<i>Test Results</i>	44

SIERRA WIRELESS, INC.

FCC Part 22 & 24 Test Report	AC755	Oct., 2003	Page 3 of 45
------------------------------	-------	------------	--------------

1 Introduction and Purpose

This document provides the FCC test data for the AC755 wireless modem. The tests included in this report are limited to all conducted tests required. The radiated tests were performed at an external test facility.

2 Test Summary

FCC RULE	DESCRIPTION OF TEST	RESULT	PAGE
2.1046	RF Power Output	Complies	5
2.1049	Occupied Bandwidth	Complies	6
2.1051, 22.901(d) 22.917, 24.238(a)	Out of Band Emissions at Antenna Terminals	Complies	14
FCC part 22H/24E	Block Edge Requirements	Complies	28
2.1053	Field Strength of Spurious Radiation	Complies	See CCS Report
2.1055	Frequency Stability versus Temperature	Complies	40
2.1055	Frequency Stability versus Voltage	Complies	43

The tests described in this report were performed by Mr. Darryl Simpson at:

Sierra Wireless, Inc.
13811 Wireless Way
Richmond, B.C. V6V 3A4
Canada

SIERRA WIRELESS, INC.

3 Description of Equipment Under Test

The Sierra Wireless Inc. model AirCard 755 is a tri-band PCMCIA card wireless modem operating on the GSM/GPRS network. In the US and Canada, only cellular and PCS bands are used for GSM/GPRS operation, so this test report only contains data for these two bands. The EUT is a production sample and the serial number is S03073100095020.



4 RF Power Output

FCC 2.1046

4.1 Test Procedure

The transmitter output was connected to a Rohde & Schwarz CMU200 Test Set and configured to operate at maximum power. The power was measured at three equally spaced operating frequencies in each band and the RBW was set at 300 KHz.

Test Setup

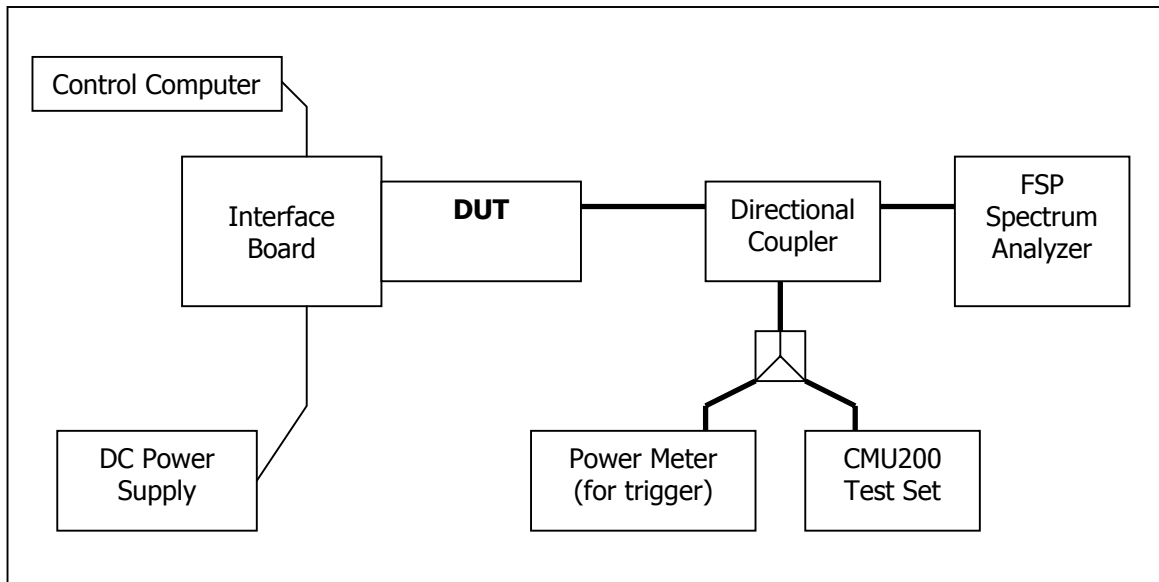

4.2 Test Equipment

Instrument List

EQUIPMENT	MANUFACTURER	MODEL NO.	SERIAL NO.	CAL. DATE
Control Computer	TC	Generic PC	100488	N/A
Wireless Test Set	Rohde & Schwarz	CMU200	836766/030	N/A
Spectrum Analyzer	Rohde & Schwarz	FSP 30GHz	US41421268	Sept. 12, 2003
DC Power Supply	HP	E3631A	100060	N/A
Interface Board	Shop built	Minnow	N/A	N/A
Directional Coupler	Pasternack	PE2209-10	N/A	N/A

4.3 Test Results

SIERRA WIRELESS, INC.

Mode	Frequency (MHz)	Channel	Peak Power (dBm)
GSM 850 MHz	824.2	128	31.5
	836.6	190	31.4
	848.8	251	31.4
GSM 1900 MHz	1850.2	512	28.5
	1880.0	661	28.4
	1909.8	810	28.5

5 Occupied Bandwidth

FCC 2.1049

5.1 Test Procedure

The transmitter output was connected to a calibrated coaxial cable, the other end of which was connected to a spectrum analyzer. The occupied Bandwidth (defined as the 99% Power Bandwidth) was measured with the Spectrum Analyzer at the center frequency of each band.

Test Setup

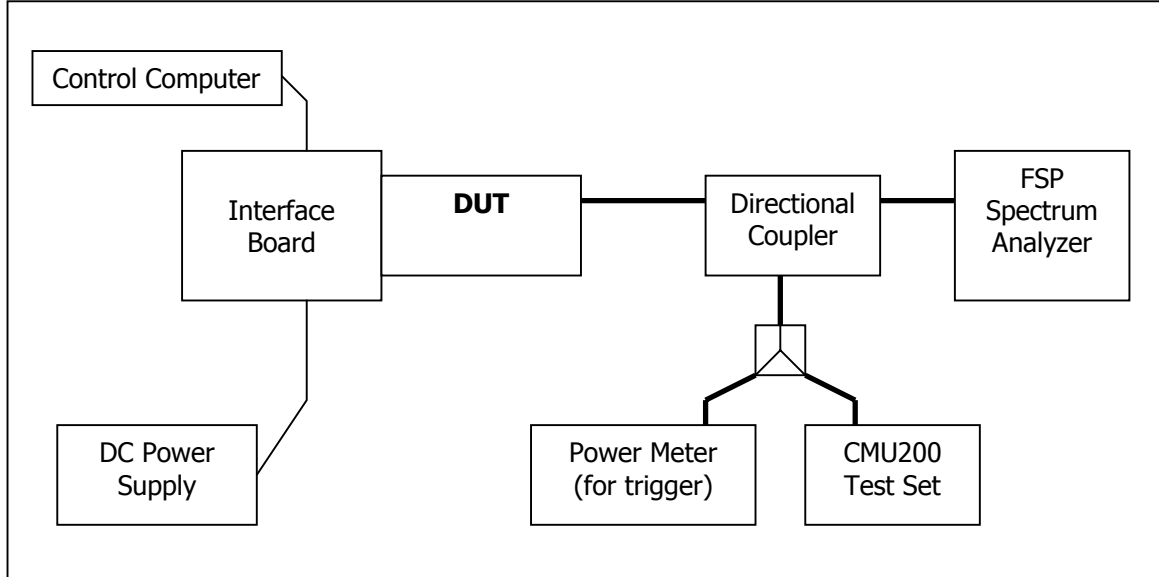

5.2 Test Results

The performance of 800 MHz cellular band is shown in plots 6.3a to 6.3e. Performance of 1900 MHz PCS band is shown in plots 6.3f to 6.3l.

Frequency (MHz)	Channel	99% Occupied Bandwidth	26dBc Occupied Bandwidth
-----------------	---------	------------------------	--------------------------

SIERRA WIRELESS, INC.

		(kHz)	(kHz)
824.2	128	246	332
836.6	190	246	324
848.8	251	246	326
1850.2	512	246	324
1880.0	661	244	328
1909.8	810	244	316

5.3 Test Plots

6.3a Occupied Bandwidth, Cellular Low channel, 824.2 MHz, 99% bandwidth

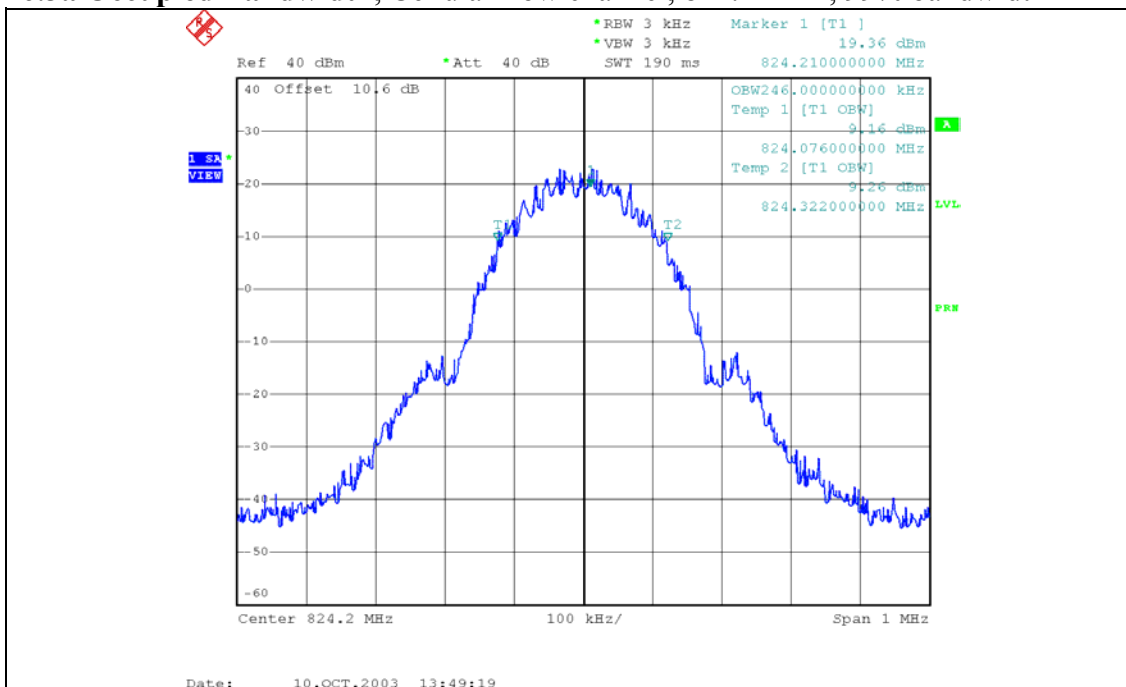

6.3b Occupied Bandwidth, Low channel, 824.2 MHz, -26dBc bandwidth

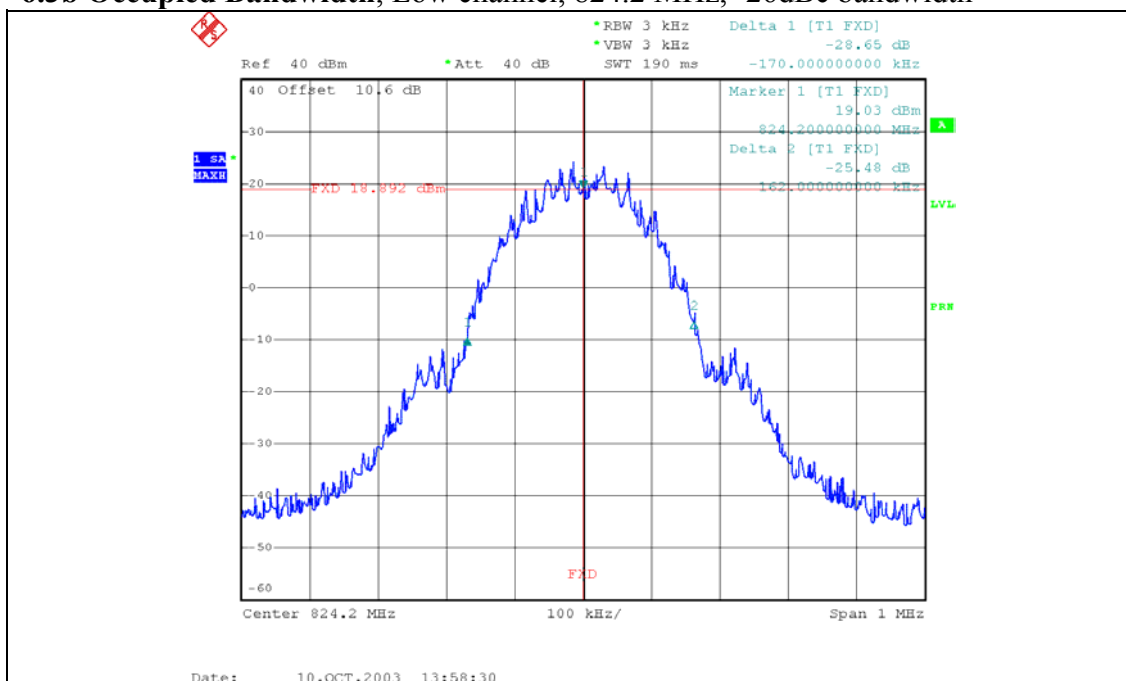

6.3e Occupied Bandwidth, High channel, 848.8 MHz, 99% bandwidth

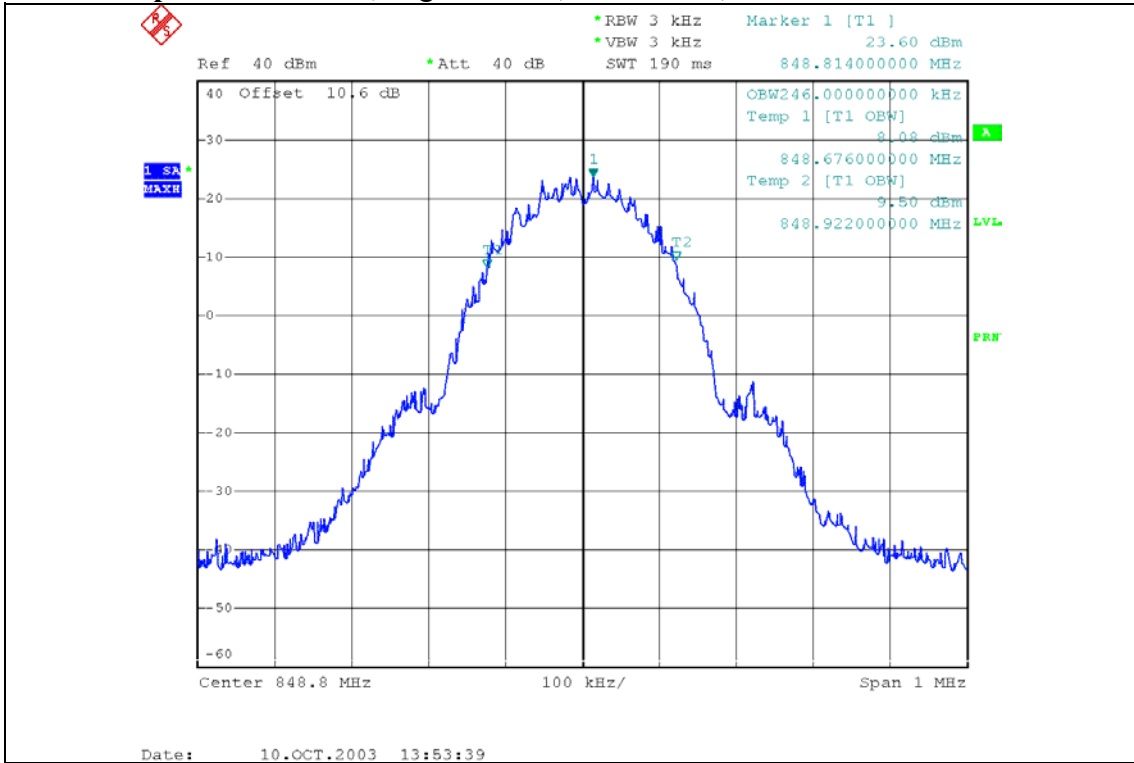

6.3f Occupied Bandwidth, High channel, 1909.8 MHz, -26dBc bandwidth

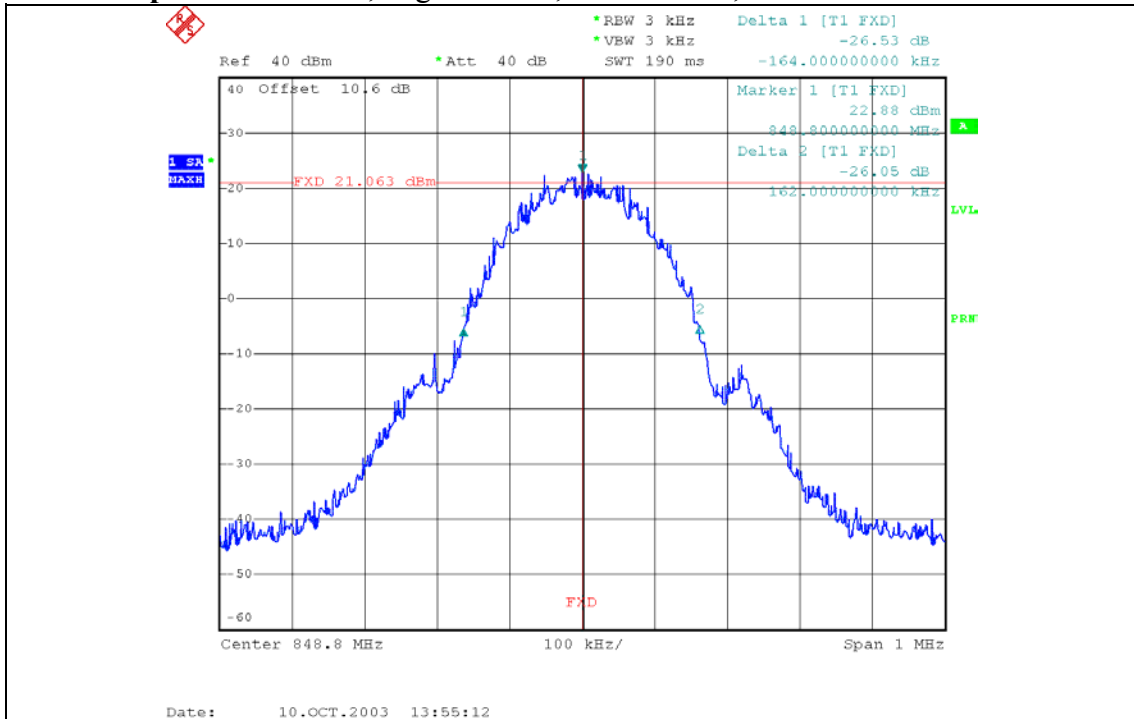

6.3g Occupied Bandwidth, PCS Low channel, 1850.2 MHz, 99% bandwidth

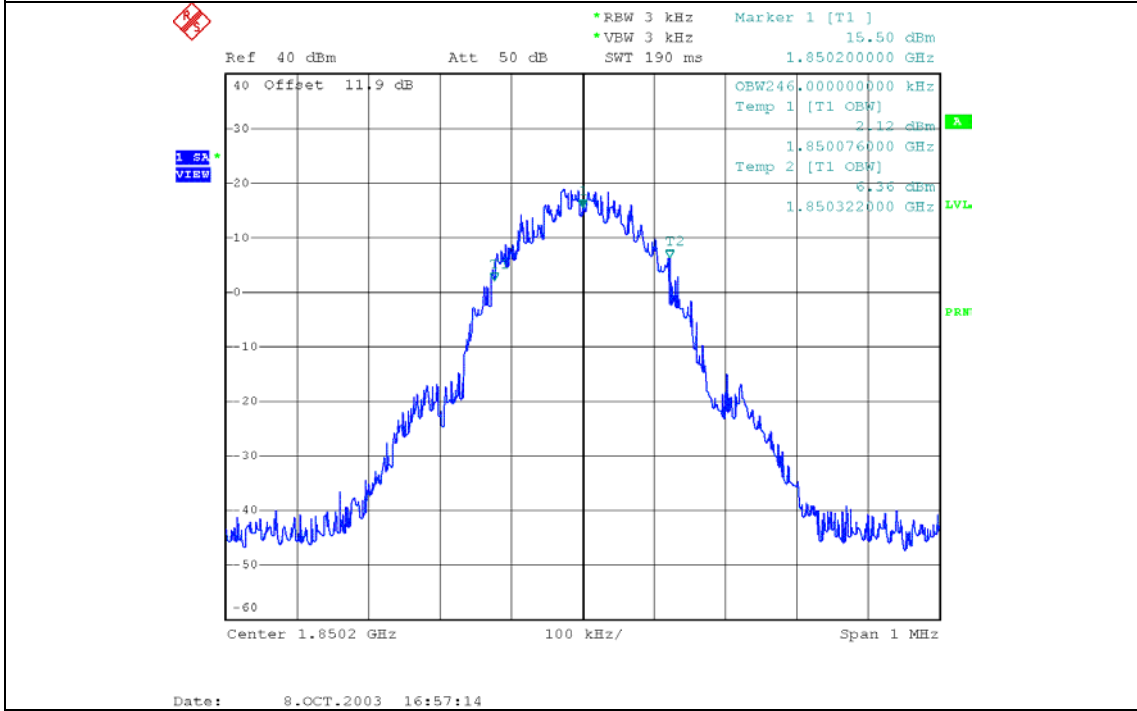

6.3h Occupied Bandwidth, PCS Low channel, 1850.2 MHz, -26dBc bandwidth

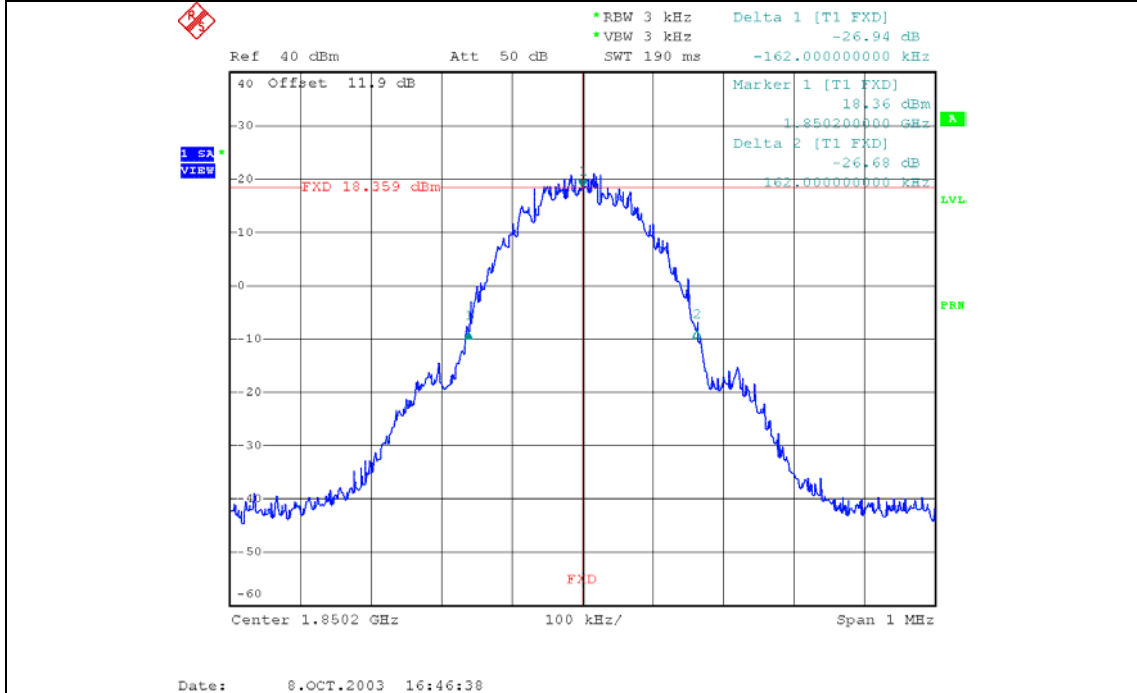

6.3i Occupied Bandwidth, PCS Middle channel, 1880.0 MHz, 99% bandwidth

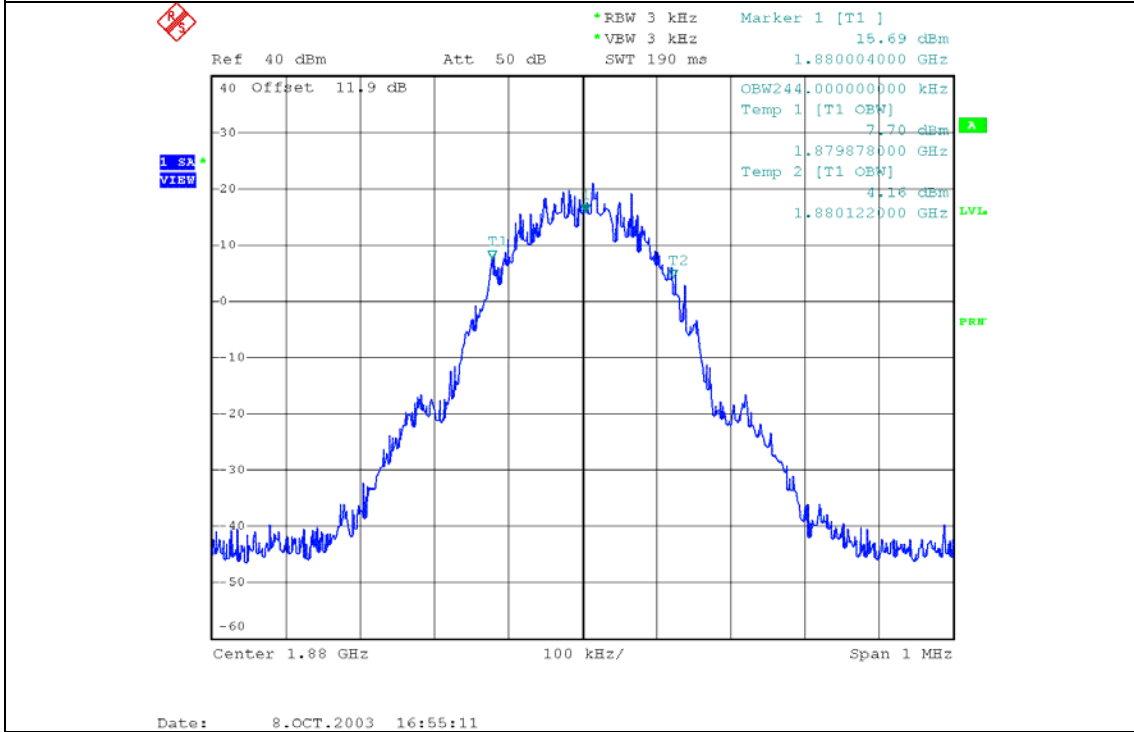

6.3j Occupied Bandwidth, PCS Middle channel, 1880.0 MHz, -26dBc bandwidth

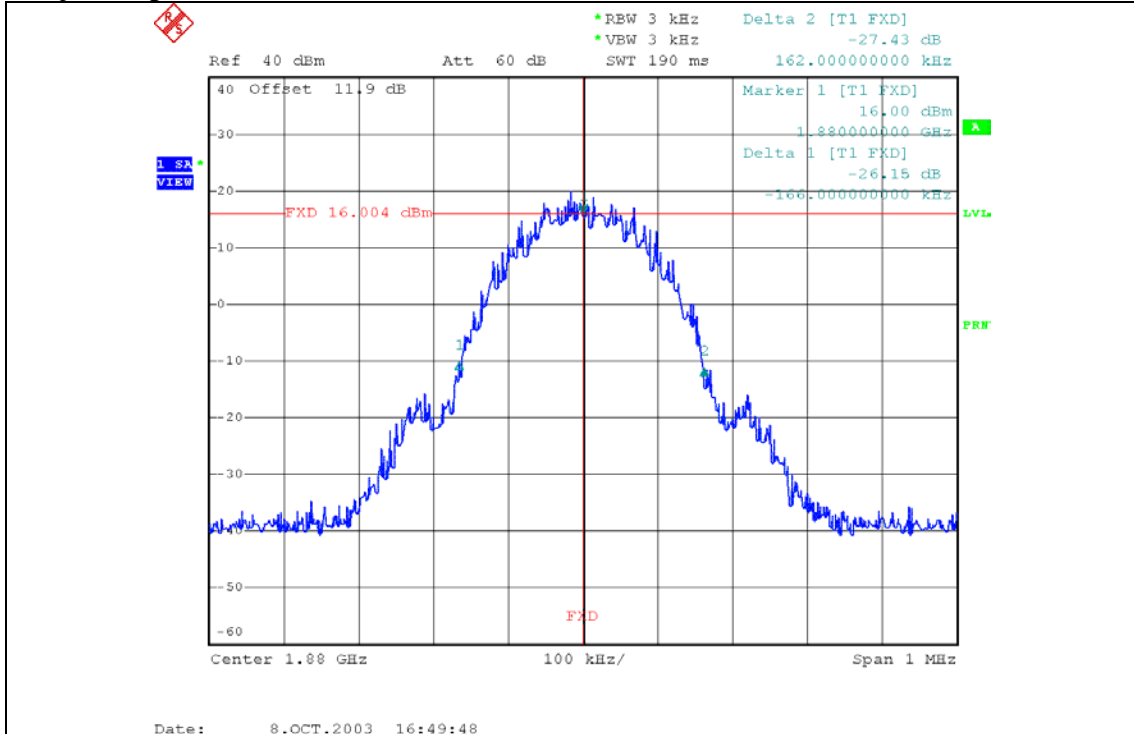

6.3k Occupied Bandwidth, PCS High channel, 1909.8 MHz, 99% bandwidth

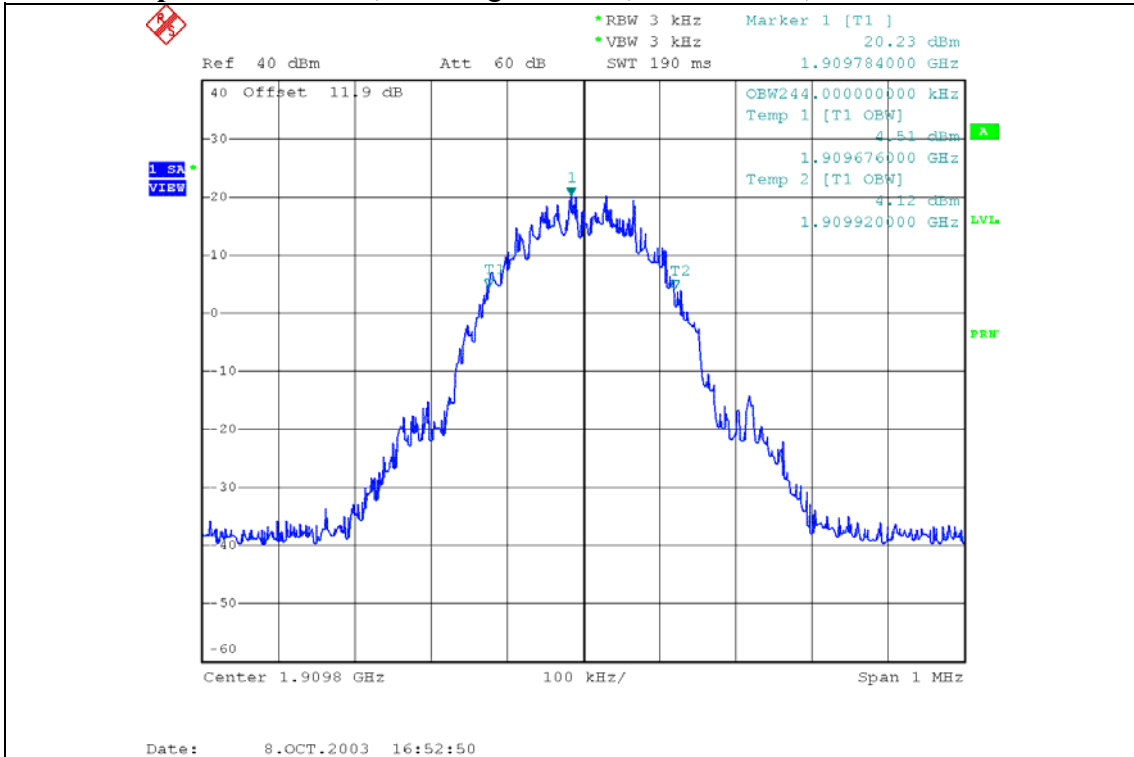

6.31 Occupied Bandwidth, PCS High channel, 1909.8 MHz, -26dBc bandwidth

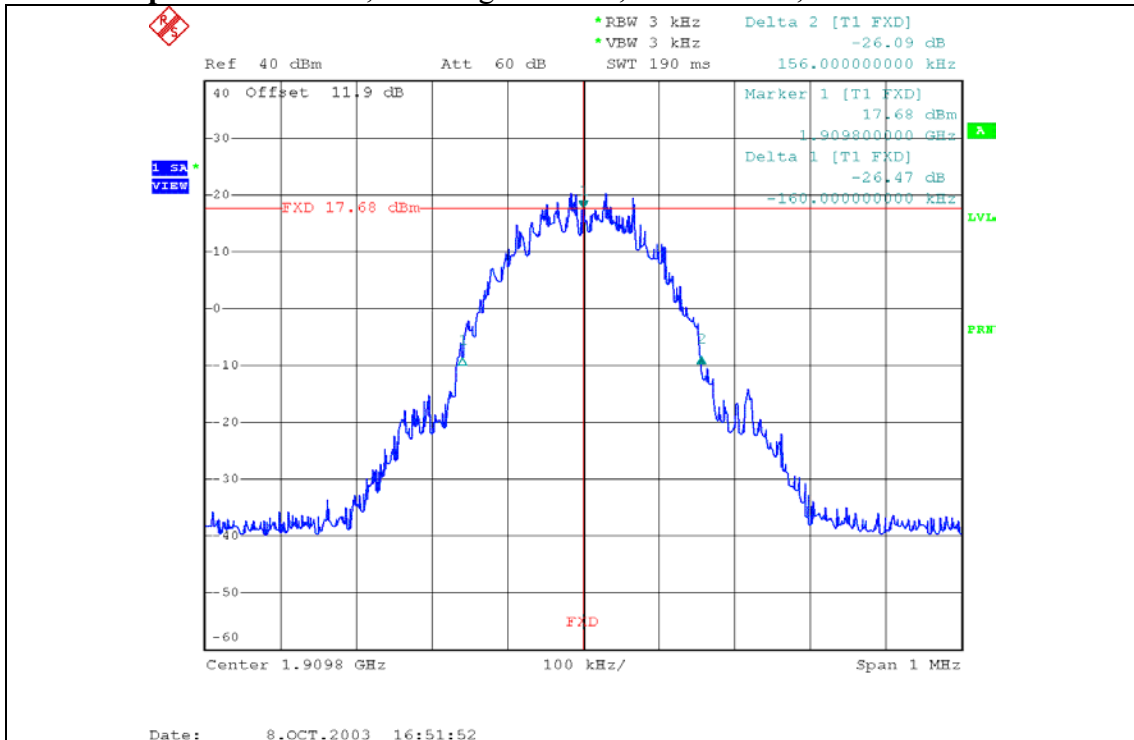

6 Out of Band Emissions at Antenna Terminals

FCC 22.901(d), 22.917, 24.238(a)

Out of Band Emissions:

The mean power of emissions must be attenuated below the mean power of the unmodulated carrier (P) on any frequency outside the frequency band by at least $(43 + 10 \log P)$ dB, in this case, -13dBm.

6.1 Test Procedure

The RF output of the transmitter was connected to a spectrum analyzer through a calibrated coaxial cable. Sufficient scans were taken to show the out-of-band Emissions, if any, up to 10th harmonic. The EUT was scanned for spurious emissions from 1MHz to 20GHz with sufficient bandwidth and video resolution. Data plots are included.

Test Setup

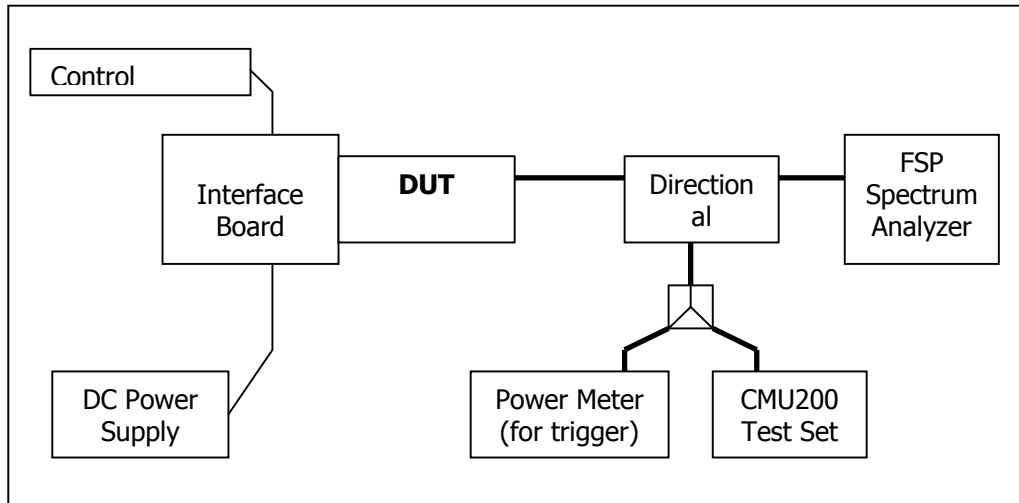

6.2 Test Equipment

EQUIPMENT	MANUFACTURER	MODEL NO.	SERIAL NO.	CAL. DATE
Control Computer	TC	Generic PC	100488	N/A
Wireless Test Set	Rohde & Schwarz	CMU200	836766/030	N/A
Spectrum Analyzer	Rohde & Schwarz	FSP 30GHz	US41421268	Sept. 12, 2003
DC Power Supply	HP	E3631A	100060	N/A
Interface Board	Shop built	Minnow	N/A	N/A
Directional Coupler	Pasternack	PE2209-10	N/A	N/A

6.3 Test Results

Refer to the following plots.

© 2003 Sierra Wireless, Inc.

The contents of this page are subject to the confidentiality information on page one.

SIERRA WIRELESS, INC.

• **Cellular Band**

Plot Number	Description
7.4a – 7.4c	Low channel, 824.20 MHz
7.4d – 7.4f	Middle Channel, 836.6 MHz
7.4g – 7.4i	High Channel, 848.8 MHz

• **PCS Band**

Plot Number	Description
7.4j – 7.4l	Low Channel, 1850.2 MHz
7.4m – 7.4o	Middle Channel, 1880.0 MHz
7.4p – 7.4r	High Channel, 1909.8 MHz

• **Emissions in Base Station Frequency Range, Cellular band**

Plot Number	Description
7.4s	Low channel, 824.20 MHz
7.4t	Middle Channel, 836.6 MHz
7.4u	High Channel, 848.8 MHz

These plots show that the conducted emission limits requirements are met.

6.4 Test Plots

Plot 7.4a Out of Band Emissions at Antenna Terminals
 Low channel, 824.200 MHz, 1 MHz to 1 GHz

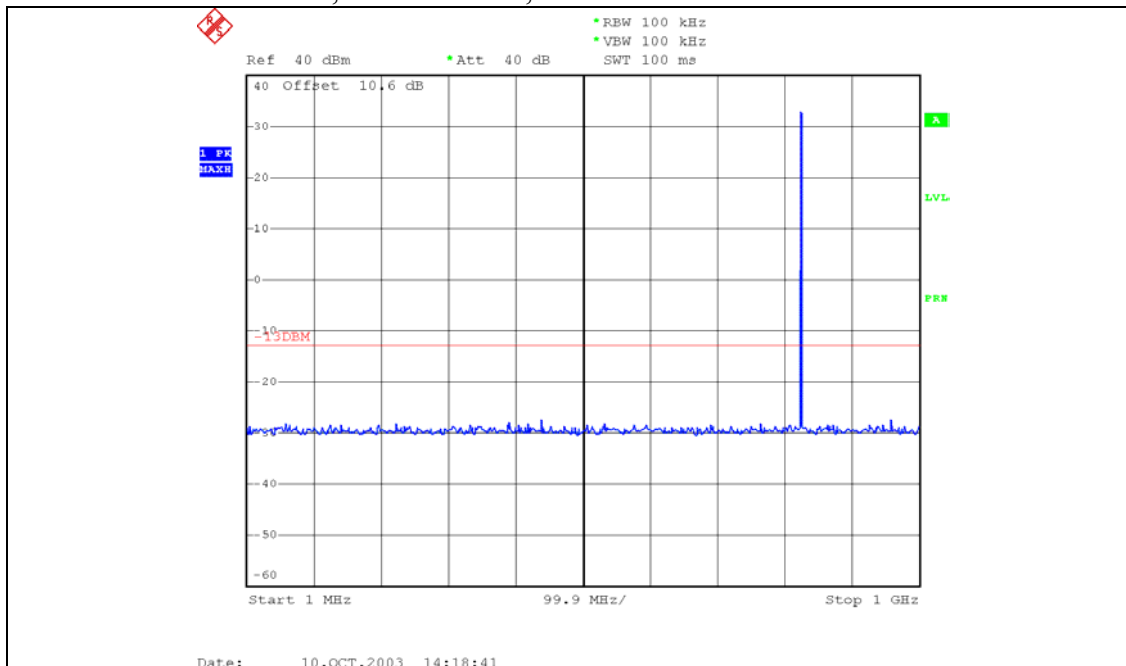

Plot 7.4b Out of Band Emissions at Antenna Terminals
 Low channel, 824.200 MHz, TX signal +/- 20 MHz

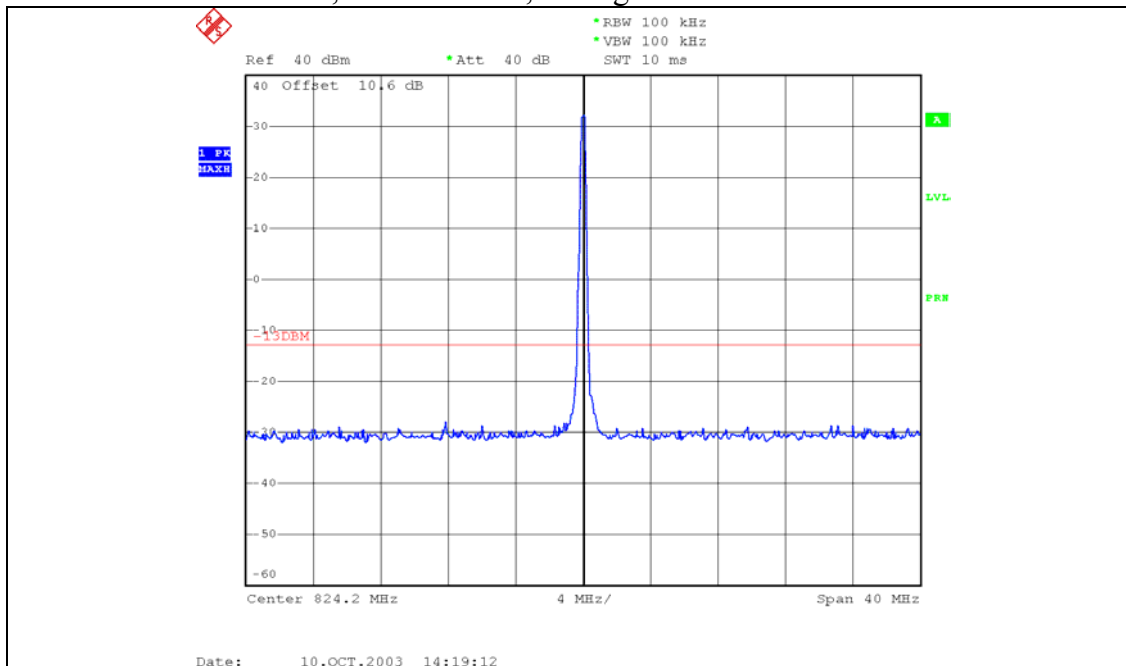

Strong emission shown in each case is the carrier signal.

SIERRA WIRELESS, INC.

Plot 7.4c Out of Band Emissions at Antenna Terminals
 Low channel, 824.200 MHz, 1 GHz to 20 GHz

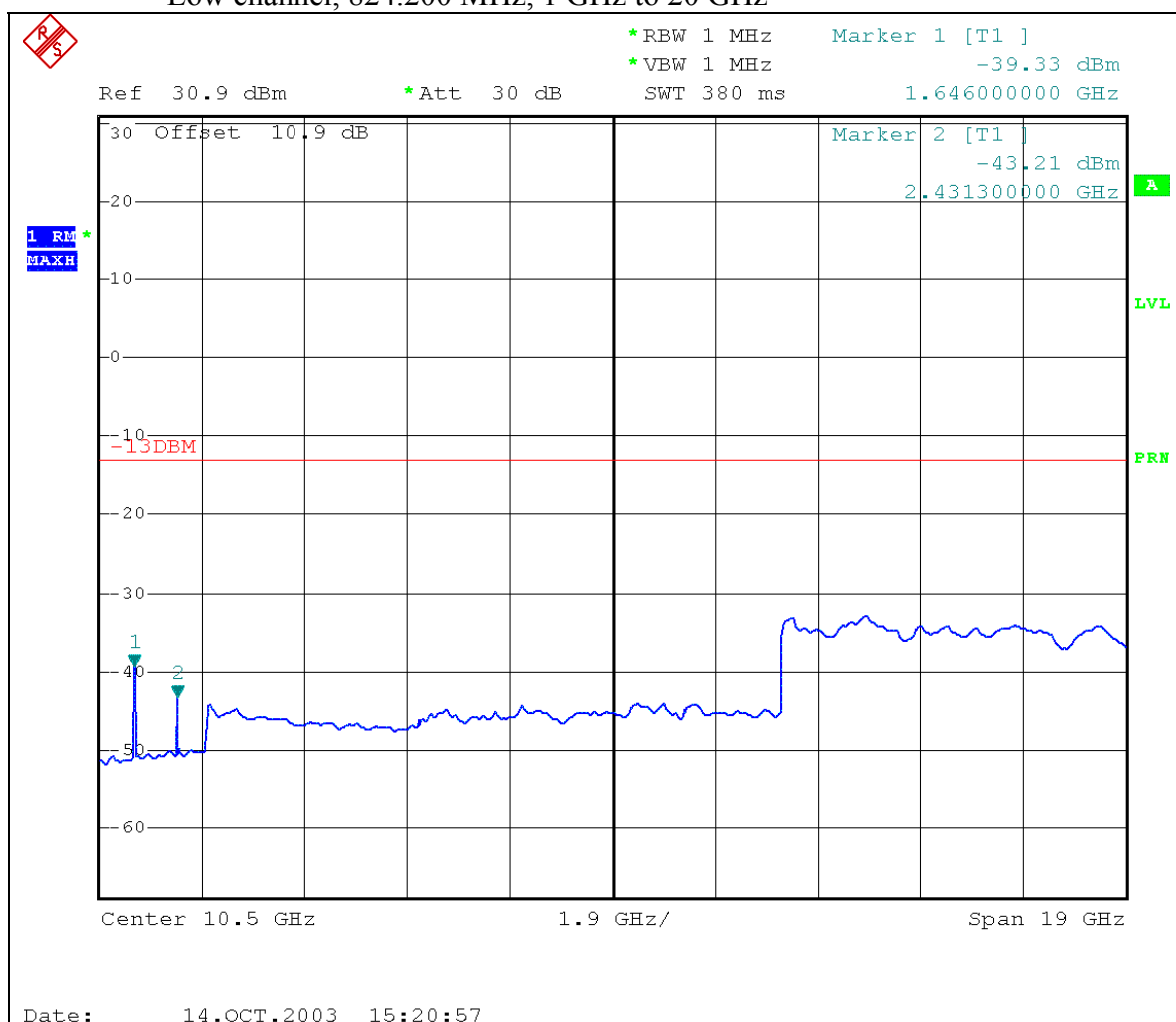

Cellular Harmonics for Ch. 128 (824.2 MHz)	Level (dBm)
Second	-39 dBm
Third	-42 dBm
All others	< -45dBm up to 13GHz; < -33dBm beyond 13GHz

Plot 7.4d Out of Band Emissions at Antenna Terminals
 Mid Channel, 836.6 MHz, 1 MHz to 1 GHz

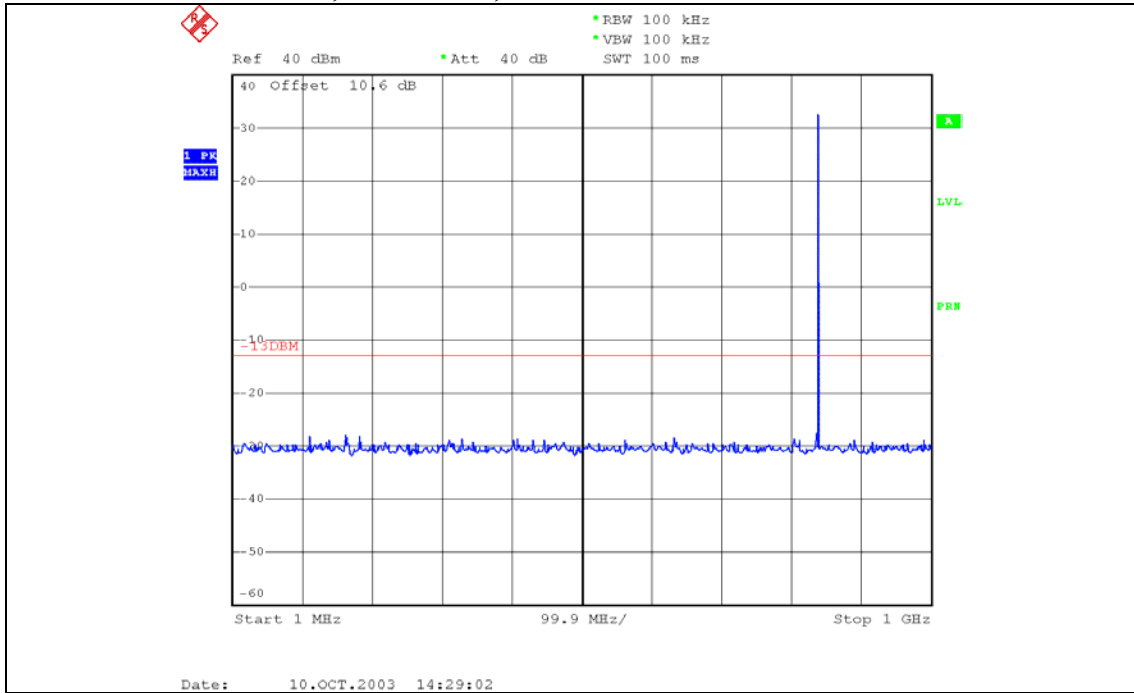

Plot 7.4e Out of Band Emissions at Antenna Terminals
 Mid Channel, 836.6 MHz, TX signal +/- 20 MHz

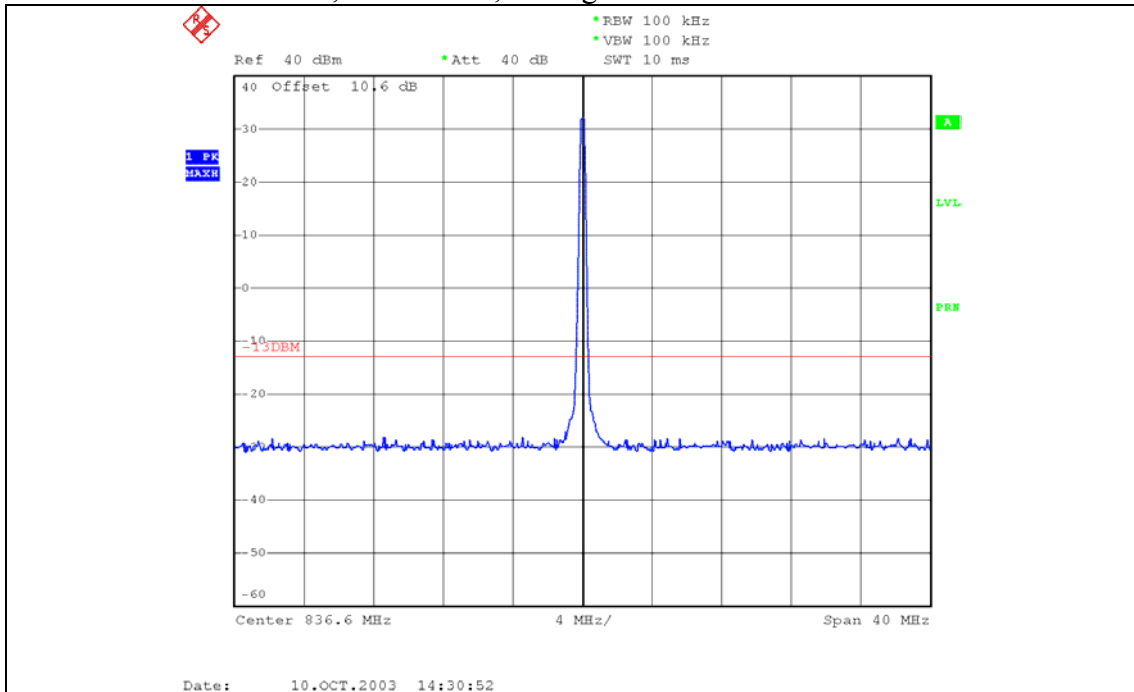

Strong emission shown in each case is the carrier signal.

SIERRA WIRELESS, INC.

Plot 7.4f Out of Band Emissions at Antenna Terminals
 Mid Channel, 836.6 MHz, 1 GHz to 20 GHz

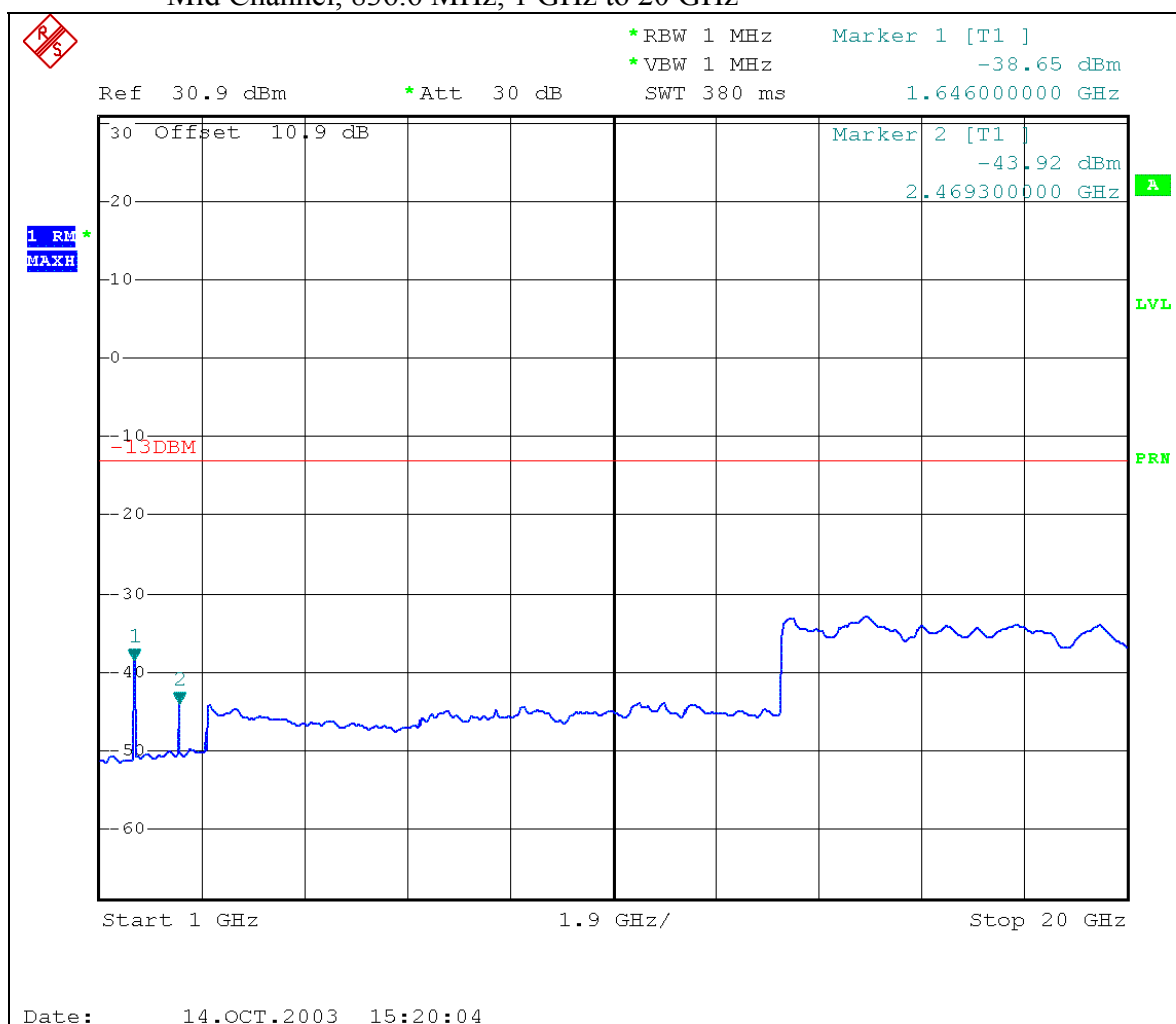

Cellular Harmonics for Ch. 190 (836.6 MHz)	Level (dBm)
Second	-38 dBm
Third	-43 dBm
All others	< -45dBm up to 13GHz; < -33dBm beyond 13GHz

SIERRA WIRELESS, INC.

Plot 7.4i Out of Band Emissions at Antenna Terminals
 High Channel, 848.8 MHz, 1 GHz to 20 GHz

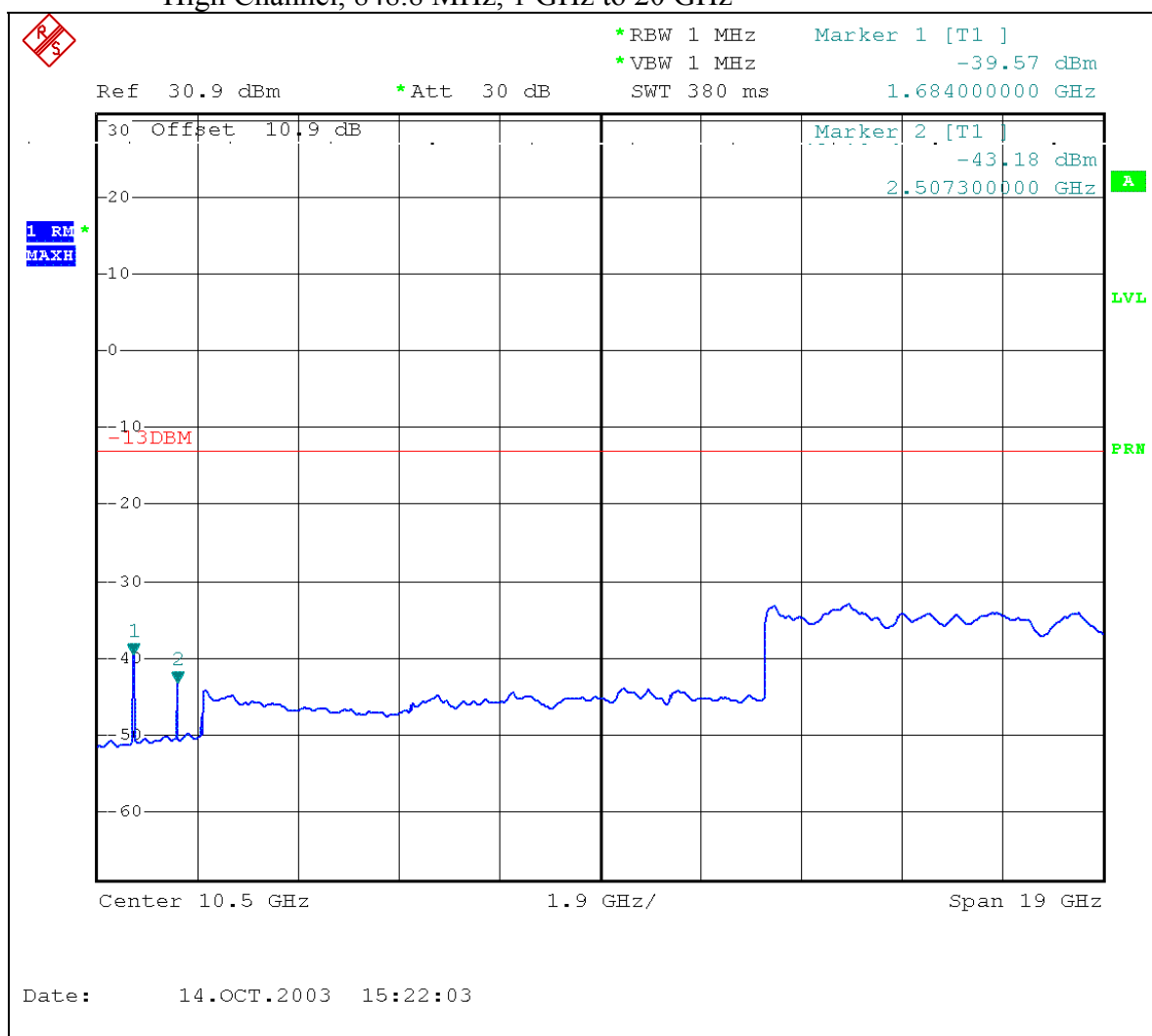

Cellular Harmonics for Ch. 251 (848.8 MHz)	Level (dBm)
Second	-39 dBm
Third	-43 dBm
All others	< -45dBm up to 13GHz; < -33dBm beyond 13GHz

SIERRA WIRELESS, INC.

Plot 7.4I Out of Band Emissions at Antenna Terminals
 Low channel, 1851.2 MHz, 1 GHz to 20 GHz

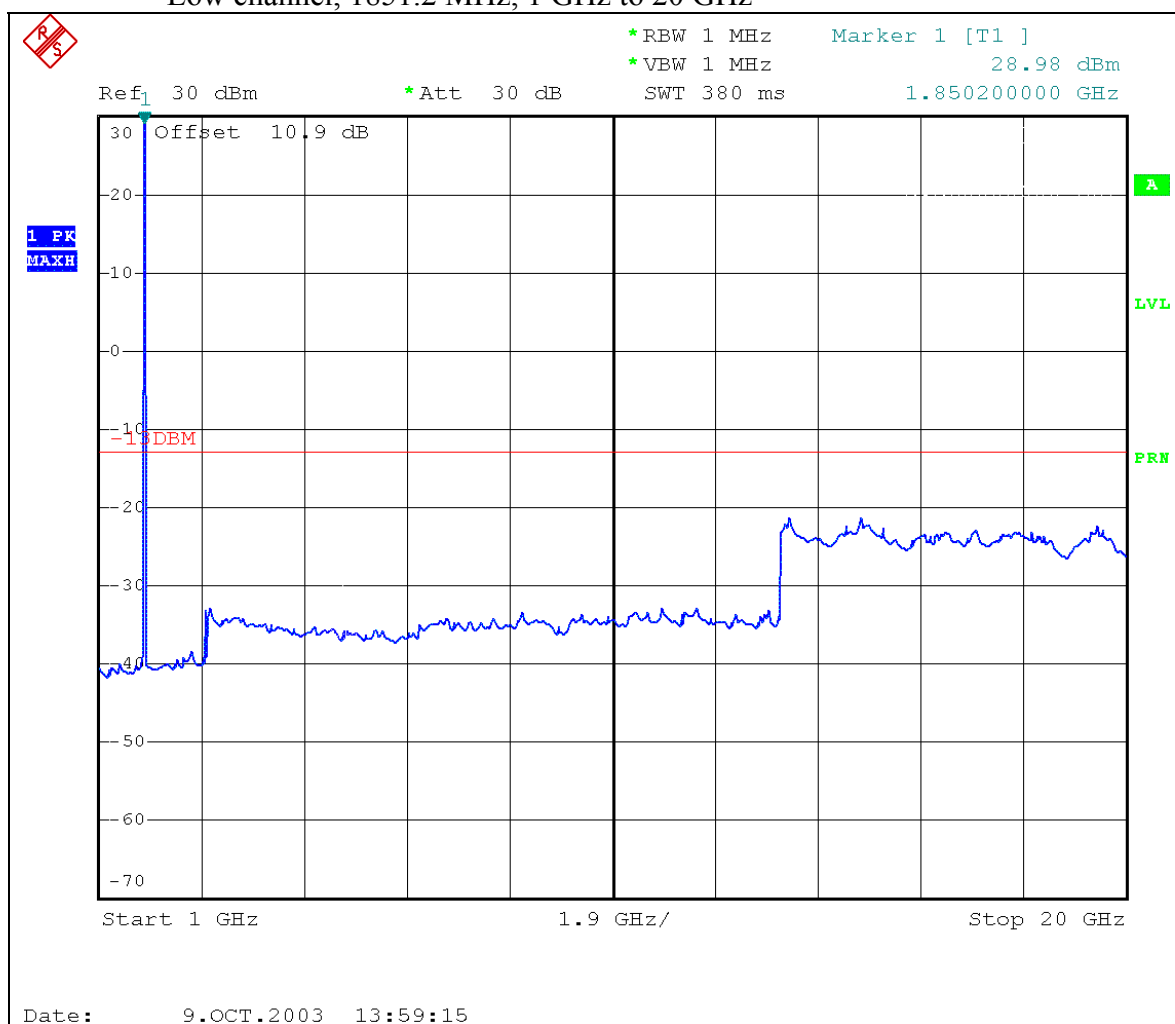

Strong emission shown is the carrier signal.

PCS Harmonics for Ch. 512 (1850.2 MHz)	Level (dBm)
Second	-41 dBm
Third	-37 dBm
All others	< -50dBm

Plot 7.4m Out of Band Emissions at Antenna Terminals
Low channel, 1880.0 MHz, 1 MHz to 1 GHz

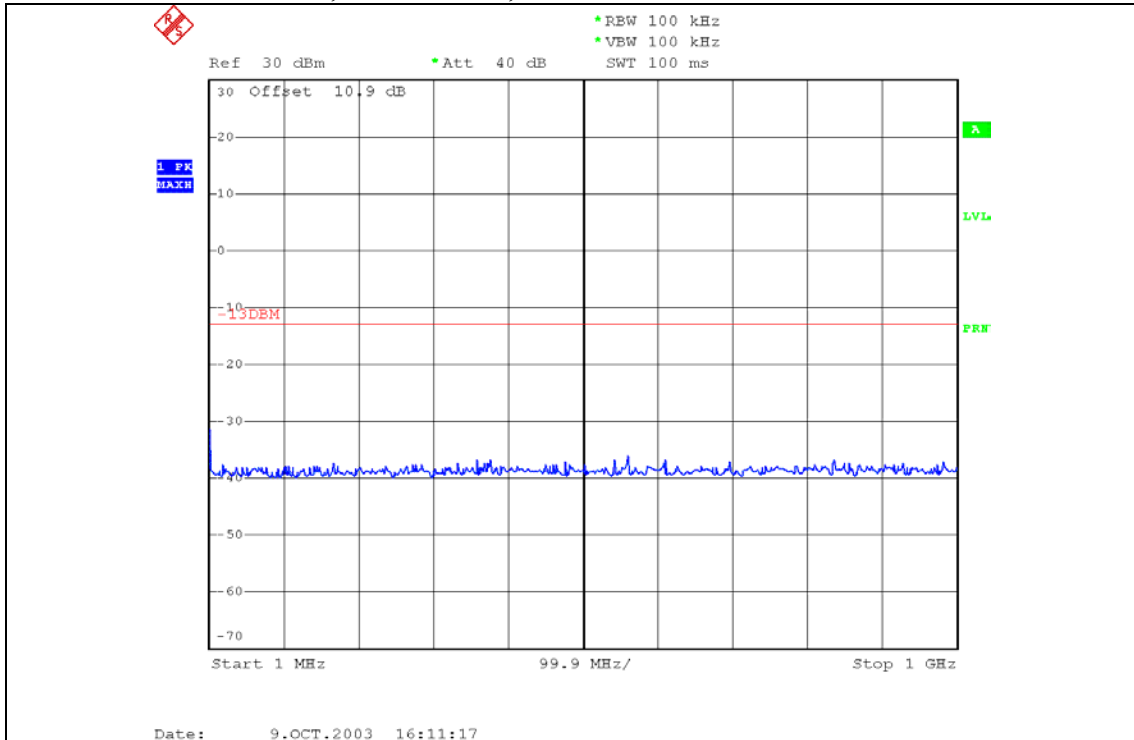

Plot 7.4n Out of Band Emissions at Antenna Terminals
Low channel, 1880.0 MHz, TX signal +/- 20 MHz

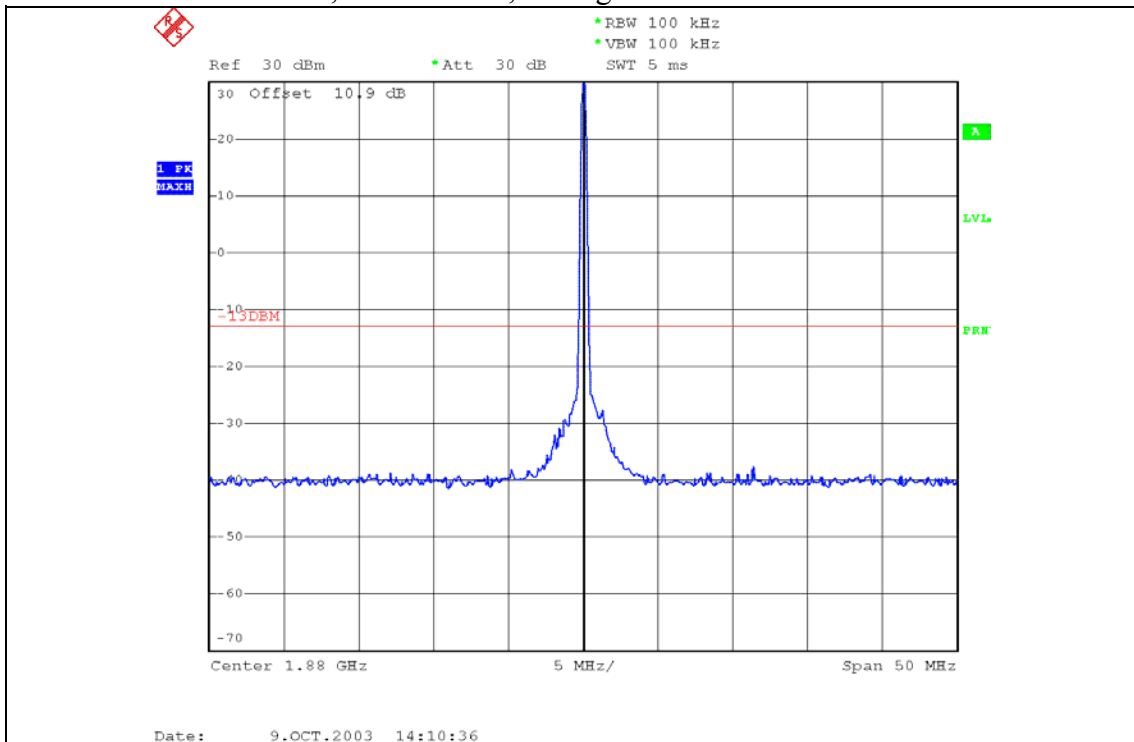

SIERRA WIRELESS, INC.

Plot 7.4o Out of Band Emissions at Antenna Terminals

Low channel, 1880.0 MHz, 1 GHz to 20 GHz

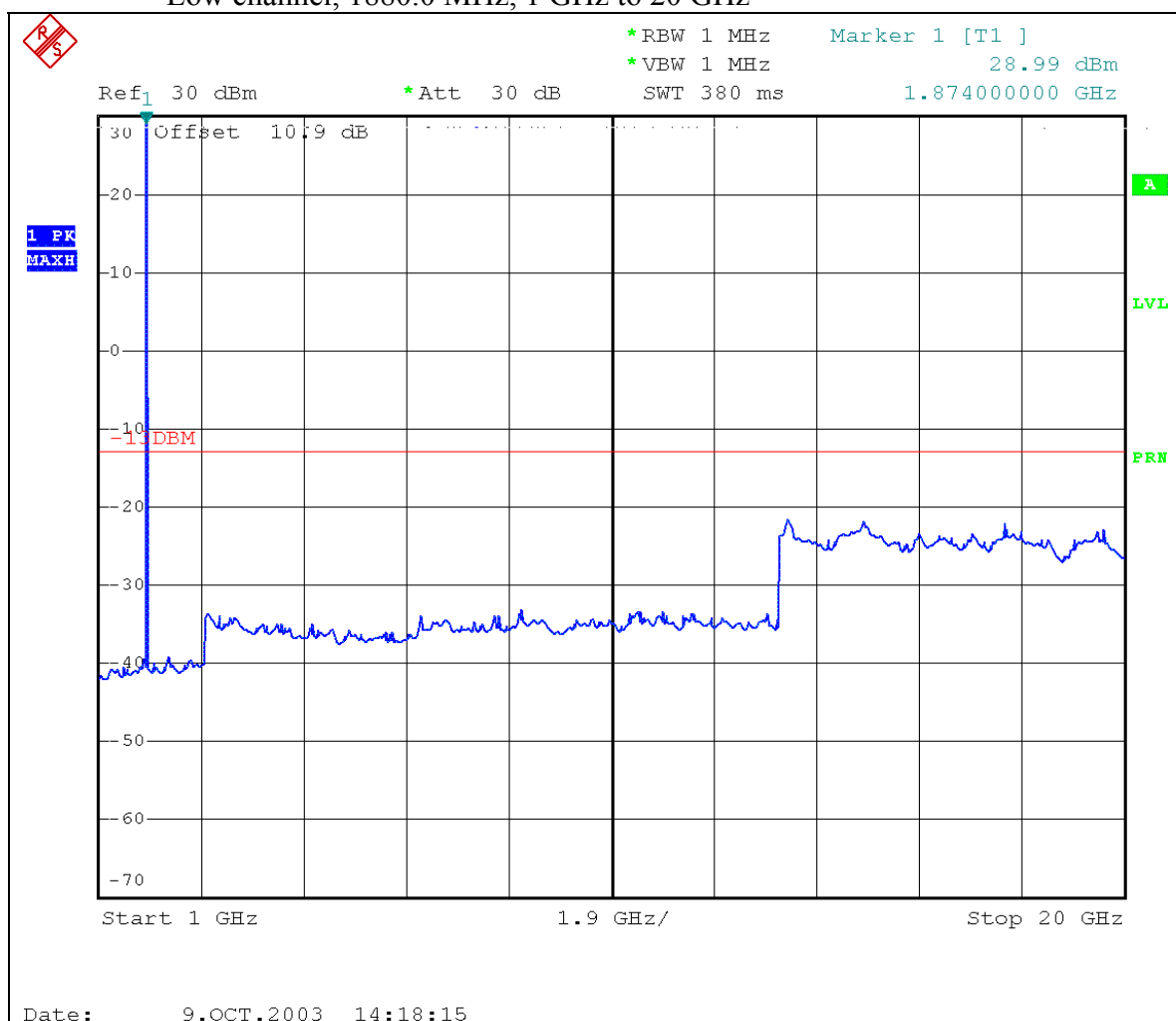

Strong emission shown is the carrier signal.

PCS Harmonics for Ch. 661 (1880.0 MHz)	Level (dBm)
Second	-43 dBm
Third	-38 dBm
All others	< -50dBm

Plot 7.4p Out of Band Emissions at Antenna Terminals
 Low channel, 1909.8 MHz, 1 MHz to 1 GHz

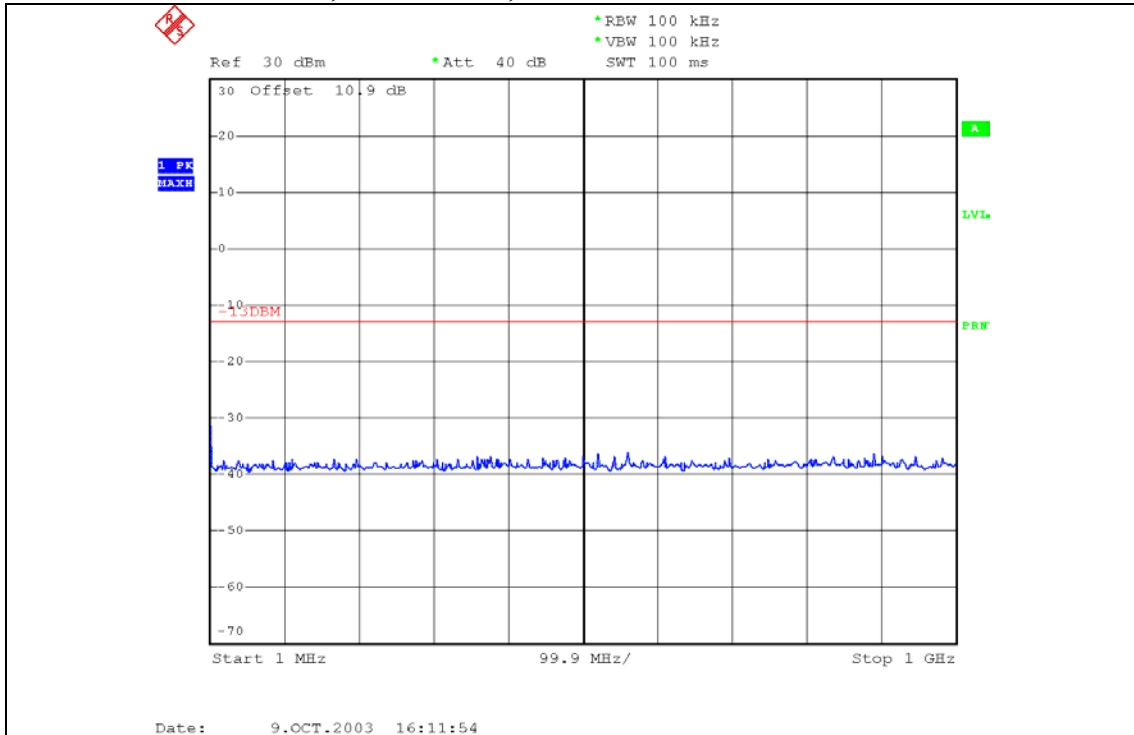

Plot 7.4q Out of Band Emissions at Antenna Terminals
 Low channel, 1909.8 MHz, TX signal +/- 20 MHz

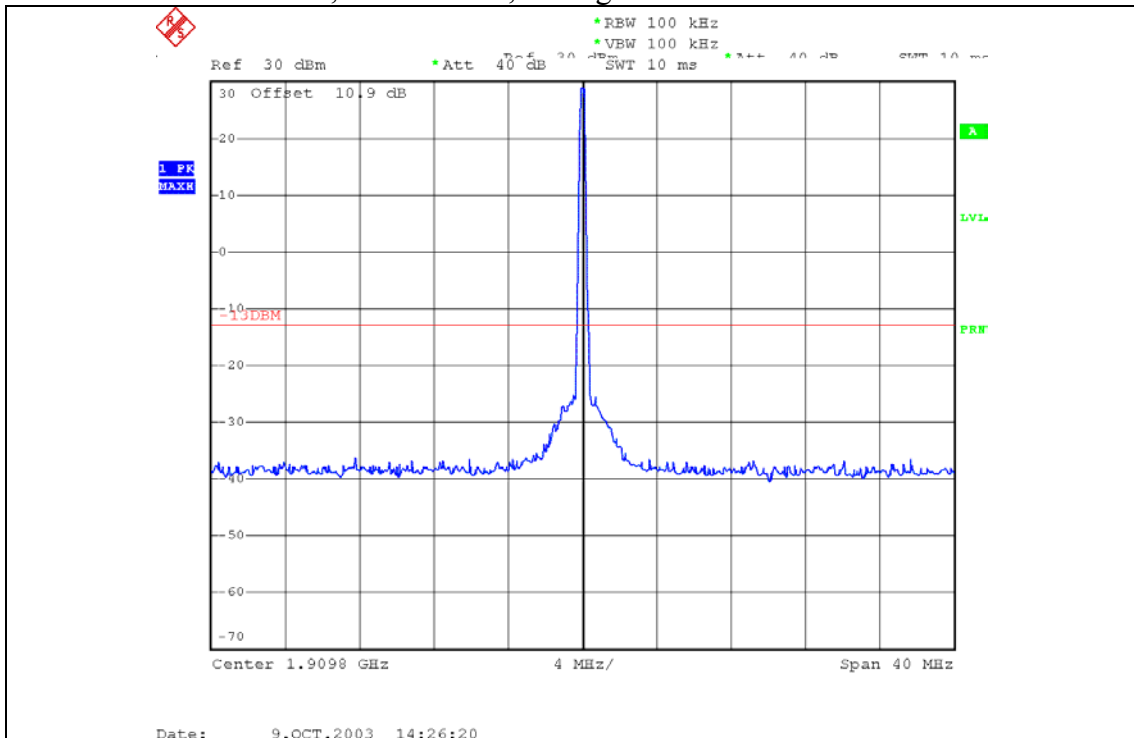

SIERRA WIRELESS, INC.

Plot 7.4r Out of Band Emissions at Antenna Terminals

Low channel, 1880.0 MHz, 1 GHz to 20 GHz

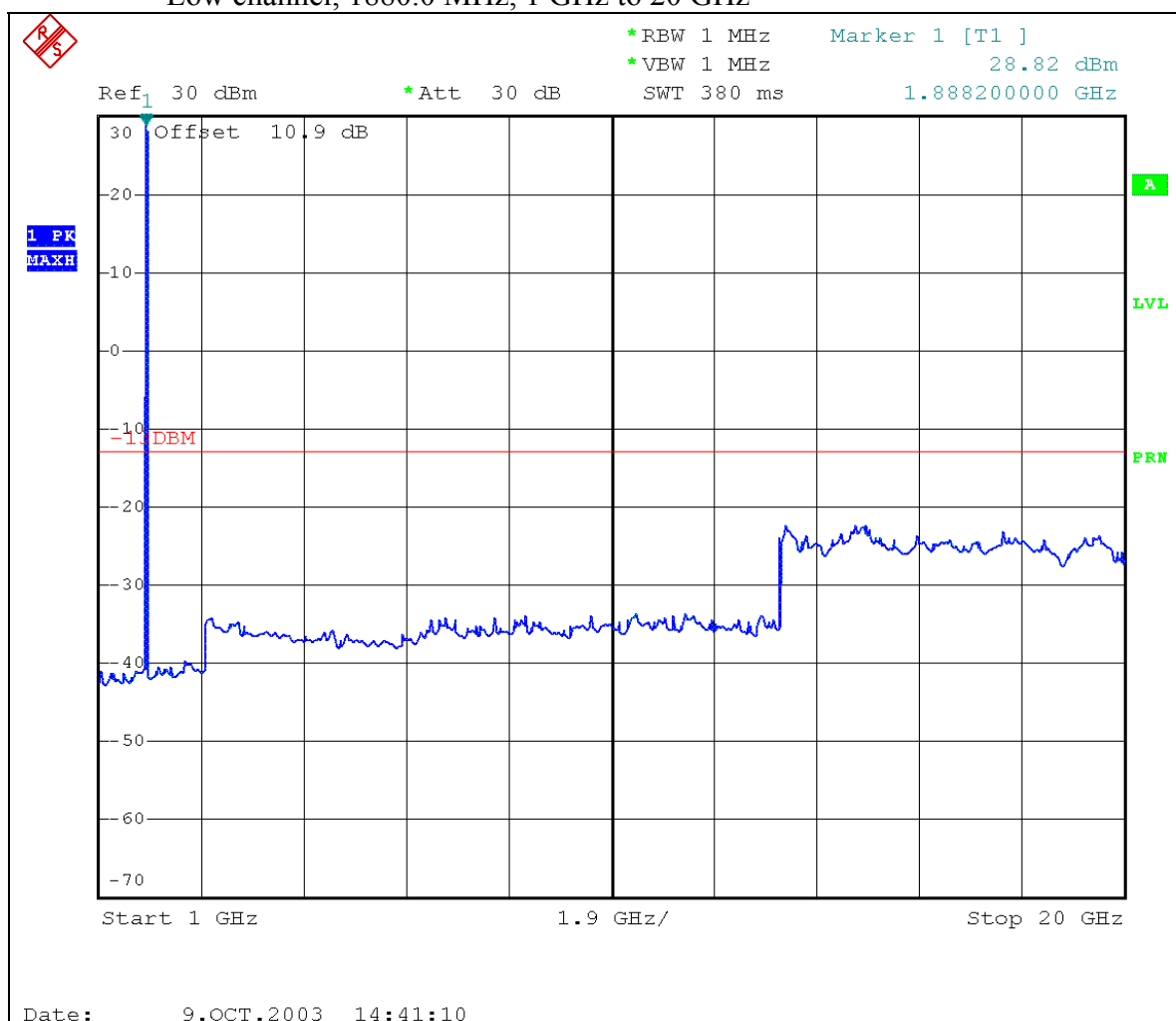

Strong emission shown is the carrier signal.

PCS Harmonics for Ch. 810 (1909.8 MHz)	Level (dBm)
Second	-43 dBm
Third	-38 dBm
All others	< -50dBm

7 Block Edge Compliance

FCC part 22H/24E

7.1 Test Procedure

The transmitter output was connected to a Rohde & Schwarz CMU200 Test Set and configured to operate at maximum power. The block edge emissions were measured at the required operating frequencies in each band on the Spectrum Analyzer.

Test Setup

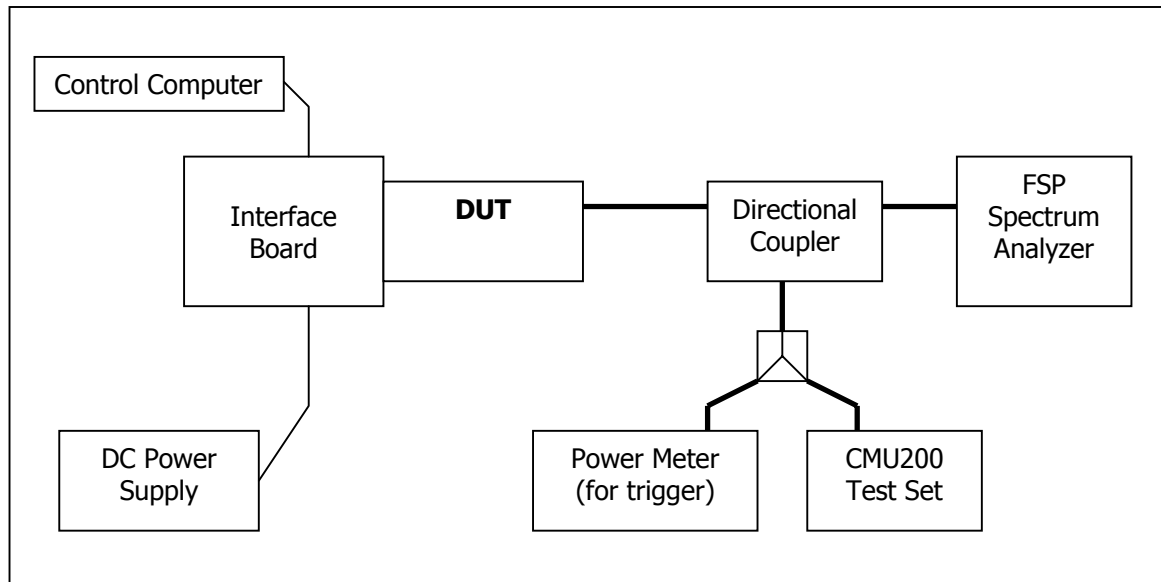

7.2 Test Equipment

Instrument List

EQUIPMENT	MANUFACTURER	MODEL NO.	SERIAL NO.	CAL. DATE
Control Computer	TC	Generic PC	100488	N/A
Wireless Test Set	Rohde & Schwarz	CMU200	836766/030	N/A
Spectrum Analyzer	Rohde & Schwarz	FSP 30GHz	US41421268	Sept. 12, 2003
DC Power Supply	HP	E3631A	100060	N/A
Interface Board	Shop built	Minnow	N/A	N/A
Directional Coupler	Pasternack	PE2209-10	N/A	N/A

SIERRA WIRELESS, INC.

7.3 Test Results

Cellular Mobile Station Block Requirements

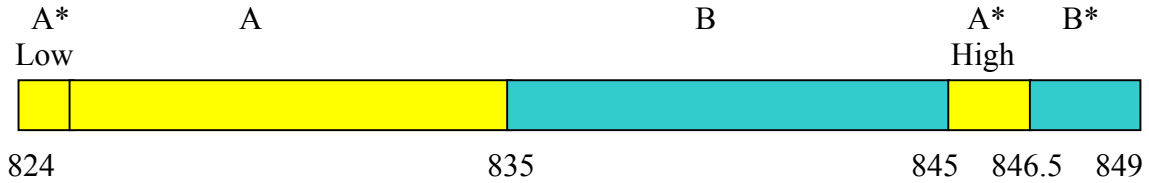

Block Number	Frequency Boundaries (MHz)	Channels Tested	Corresponding Plots	Result
1	Below 824 MHz, above 835 MHz	128, 181	8.4a, 8.4b	Complies
2	Below 835 MHz, above 845 MHz	183, 231	8.4c, 8.4d	Complies
3	Below 845 MHz, above 846.5 MHz	233, 238	8.4e, 8.4f	Complies
4	Below 846.5 MHz, above 849 MHz	241, 251	8.4g, 8.4h	Complies

PCS Mobile Station Block Requirements

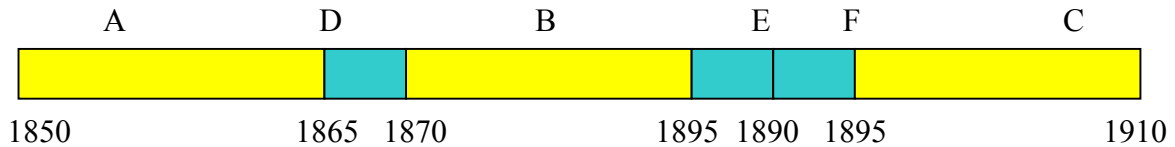

Block Number	Frequency Boundaries (MHz)	Channels Tested	Corresponding Plots	Result
1	Below 1850 MHz, above 1865 MHz	512, 585	8.4i, 8.4j	Complies
2	Below 1865 MHz, above 1870 MHz	587, 610	8.4k, 8.4l	Complies
3	Below 1870 MHz, above 1885 MHz	612, 685	8.4m, 8.4n	Complies
4	Below 1885 MHz, above 1890 MHz	687, 710	8.4o, 8.4p	Complies
5	Below 1890 MHz, above 1895 MHz	712, 735	8.4q, 8.4r	Complies
6	Below 1895 MHz, above 1910 MHz	737, 810	8.4s, 8.4t	Complies

7.4 Test Plots

Plot 8.4a Cellular Block 1, below 824 MHz

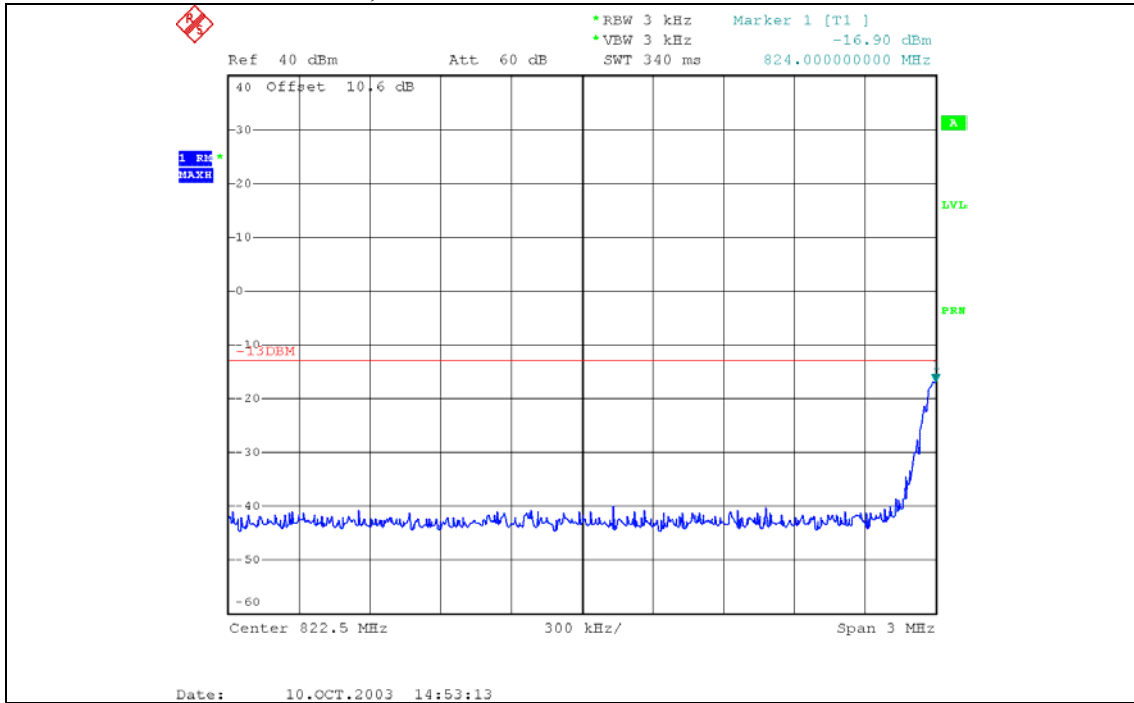

Plot 8.4b Cellular Block 1, above 835 MHz

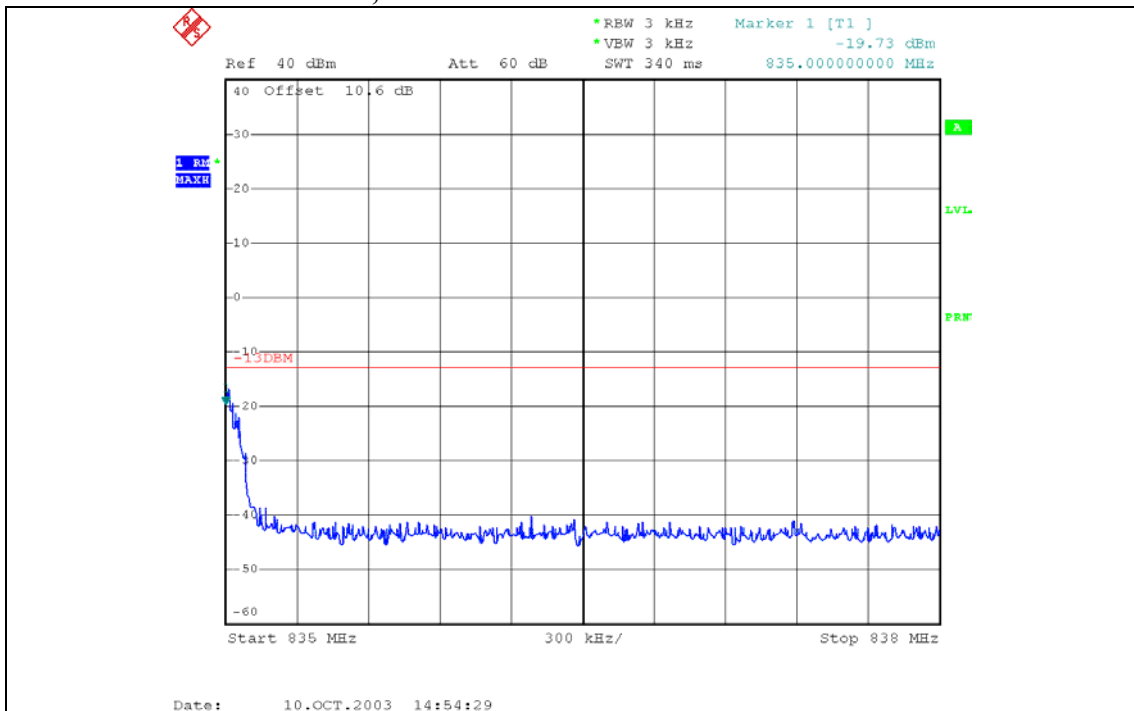

Plot 8.4c Cellular Block 2, below 835 MHz

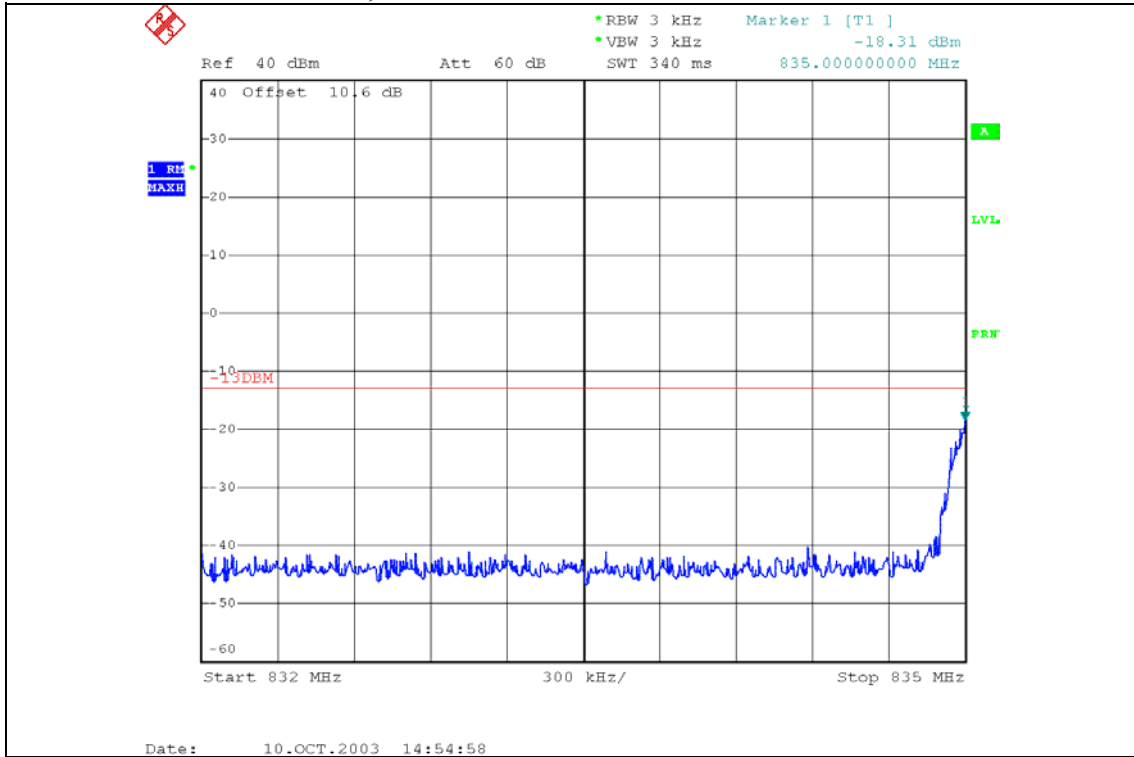

Plot 8.4d Cellular Block 2, above 845 MHz

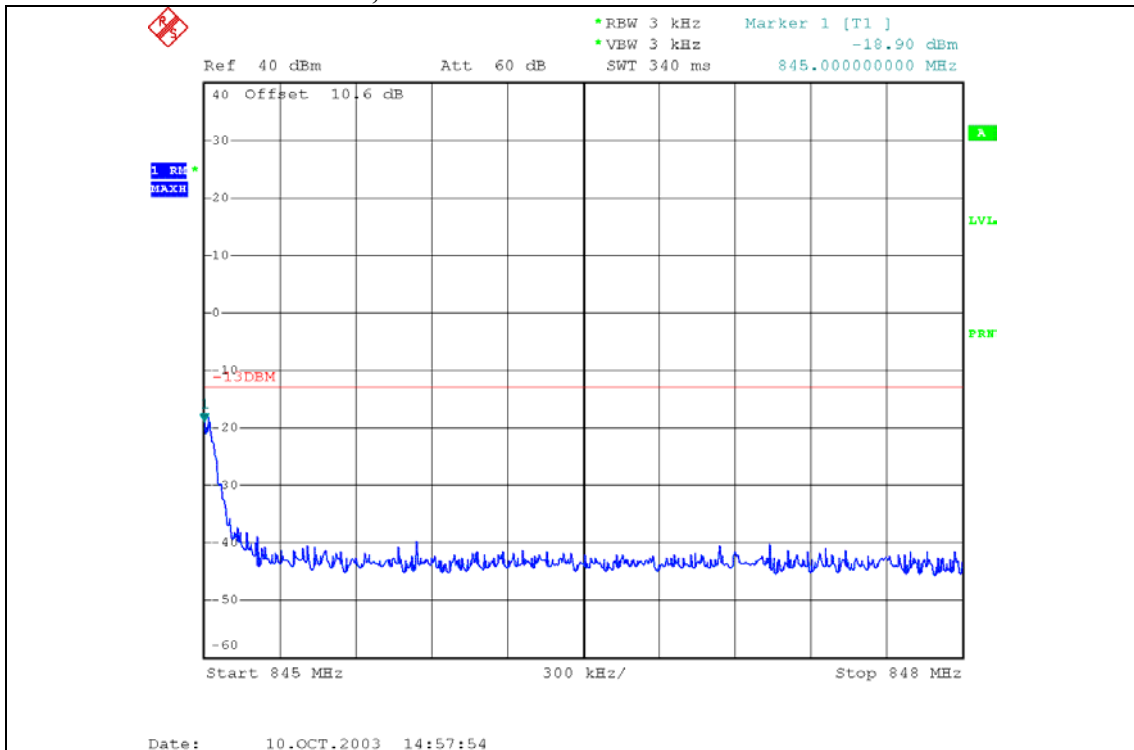

Plot 8.4e Cellular Block 3, below 845 MHz

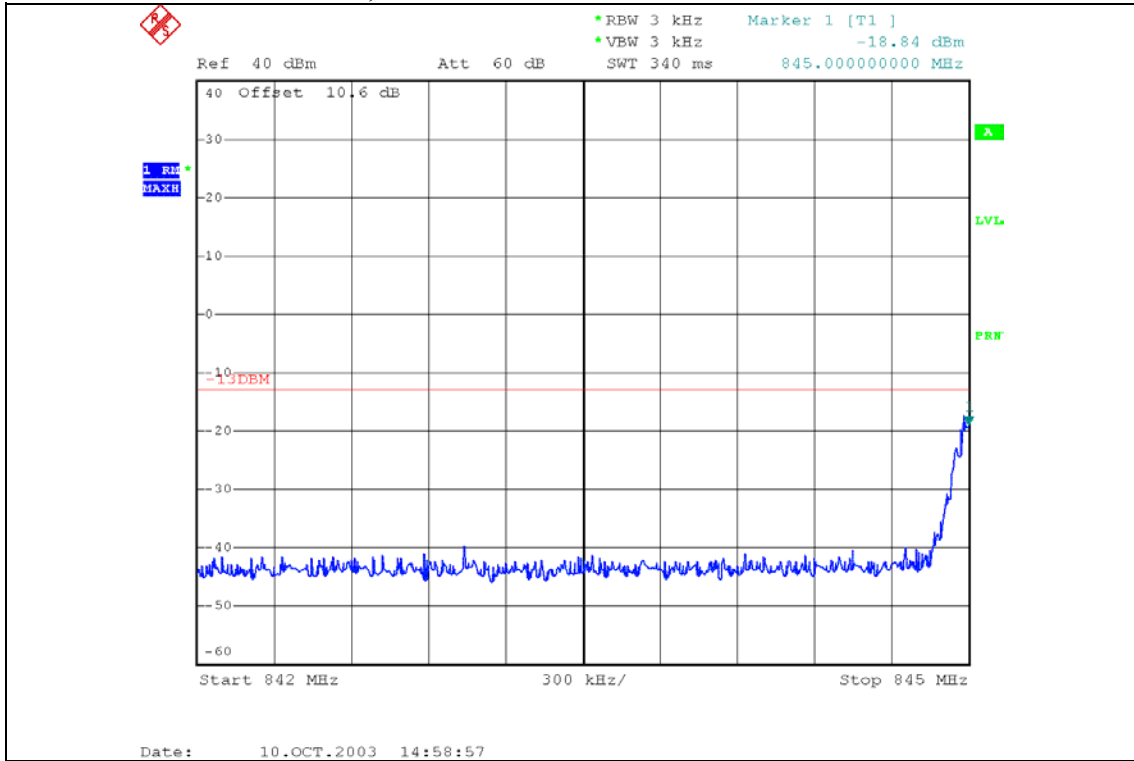

Plot 8.4f Cellular Block 3, above 846.5 MHz

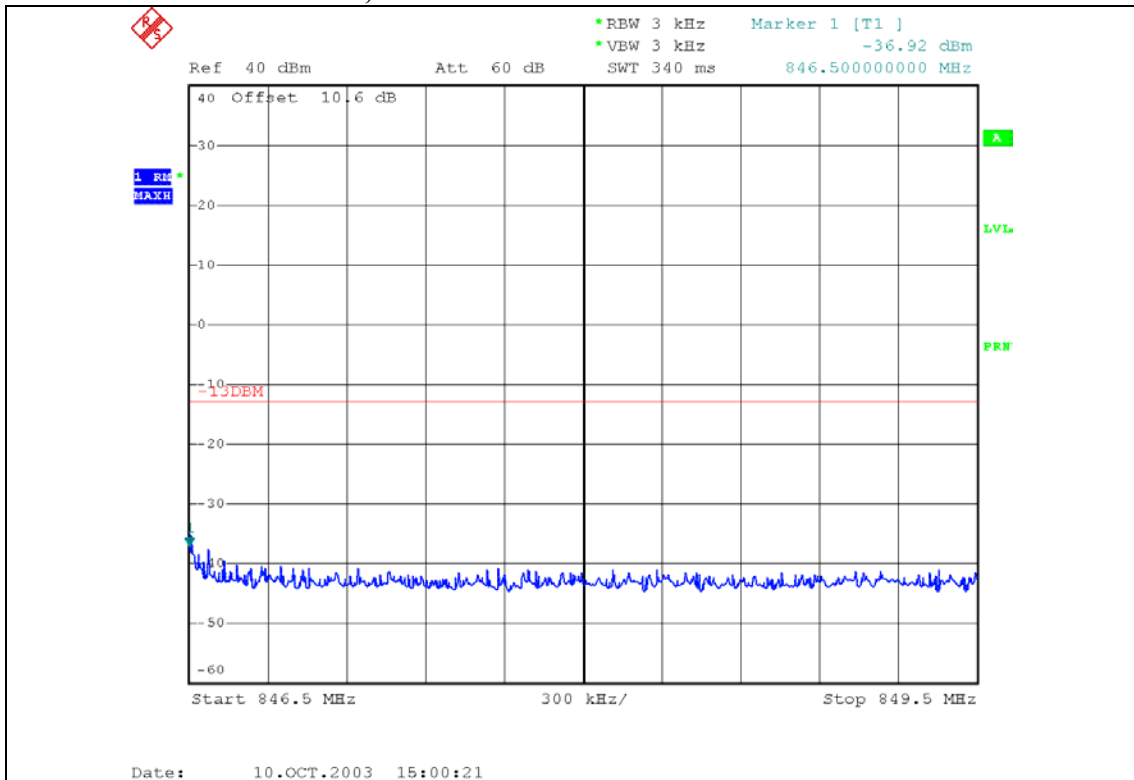

SIERRA WIRELESS, INC.

Plot 8.4g Cellular Block 4, below 846.5 MHz

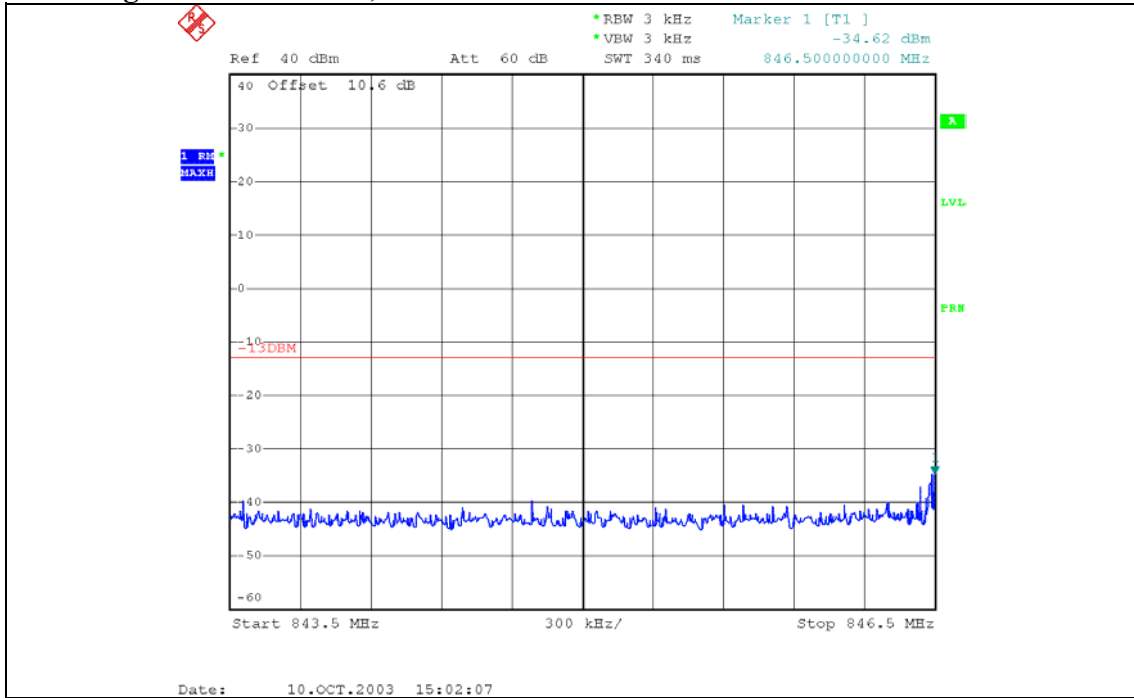

Plot 8.4h Cellular Block 4, above 849 MHz

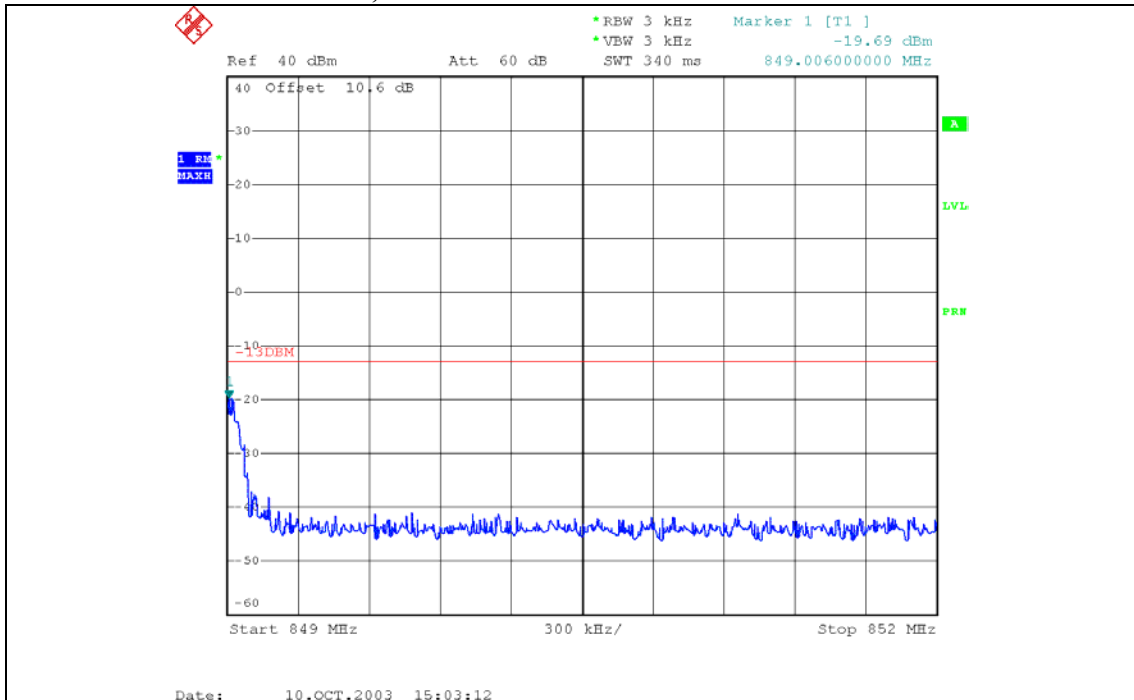

SIERRA WIRELESS, INC.

Plot 8.4i PCS Block 1, below 1850 MHz

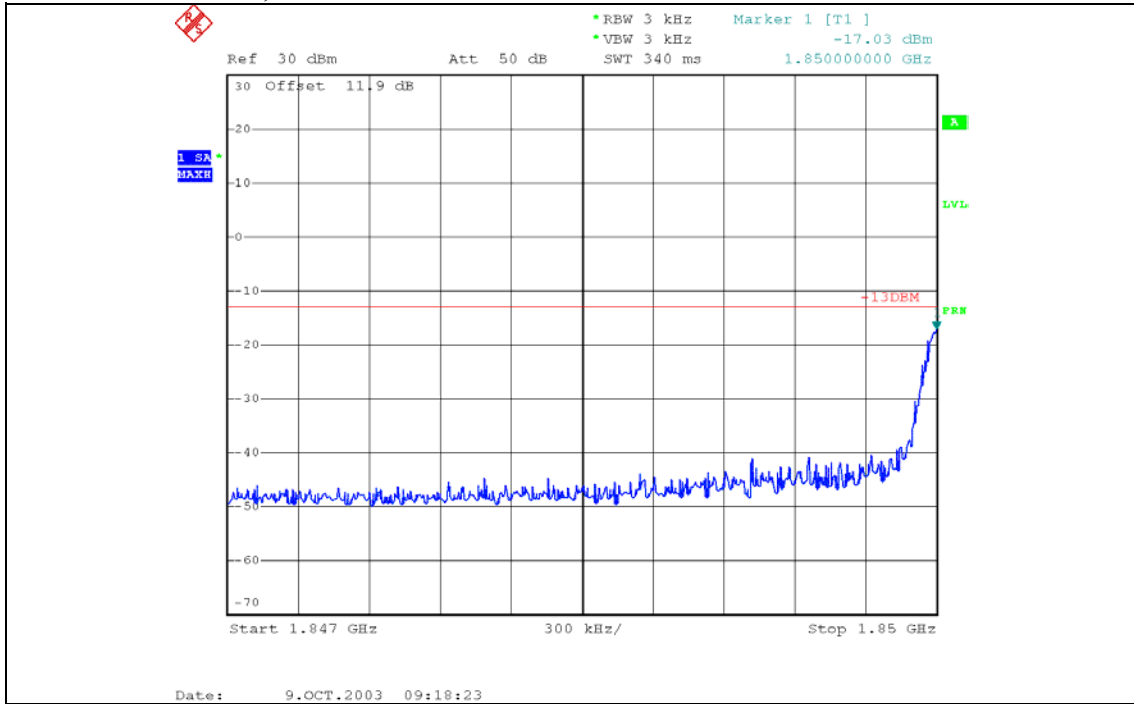

Plot 8.4j PCS Block 1, above 1865 MHz

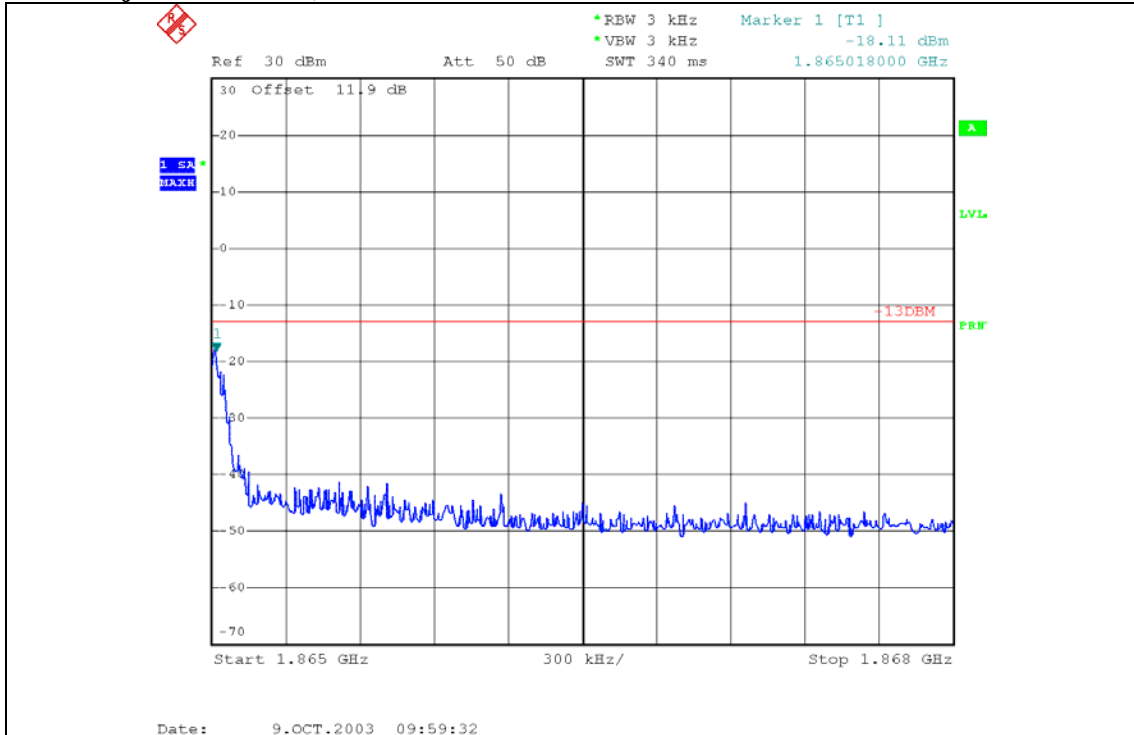

Plot 8.4k PCS Block 2, below 1865 MHz

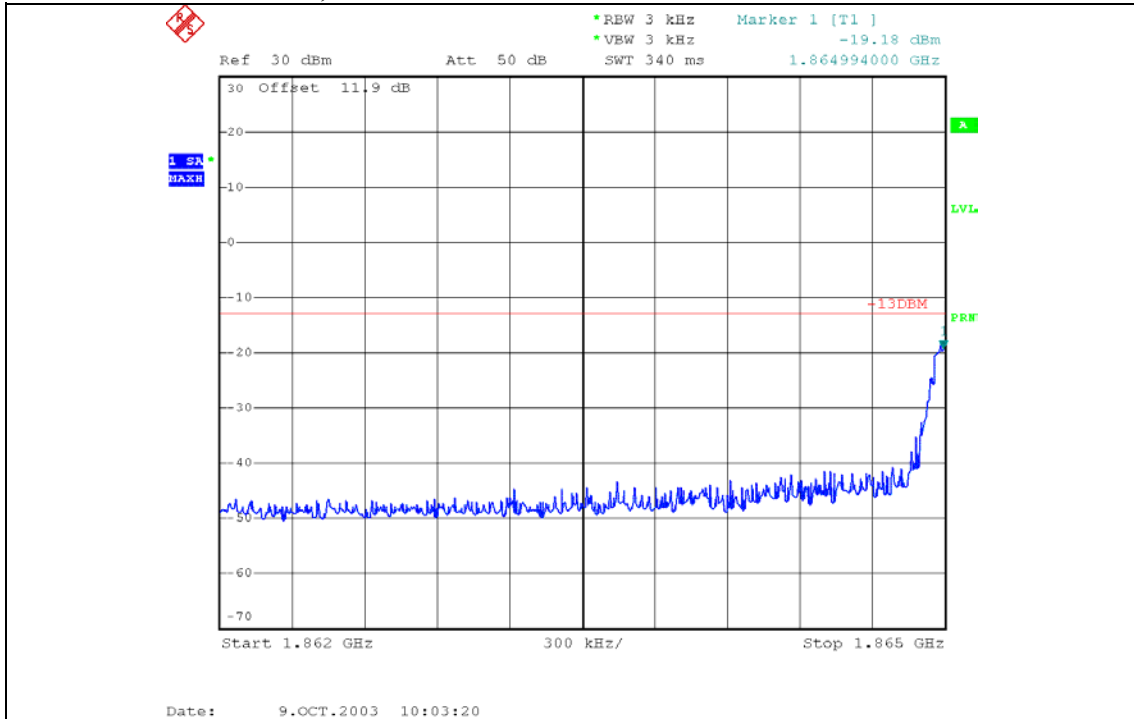

Plot 8.4l PCS Block 2, above 1870 MHz

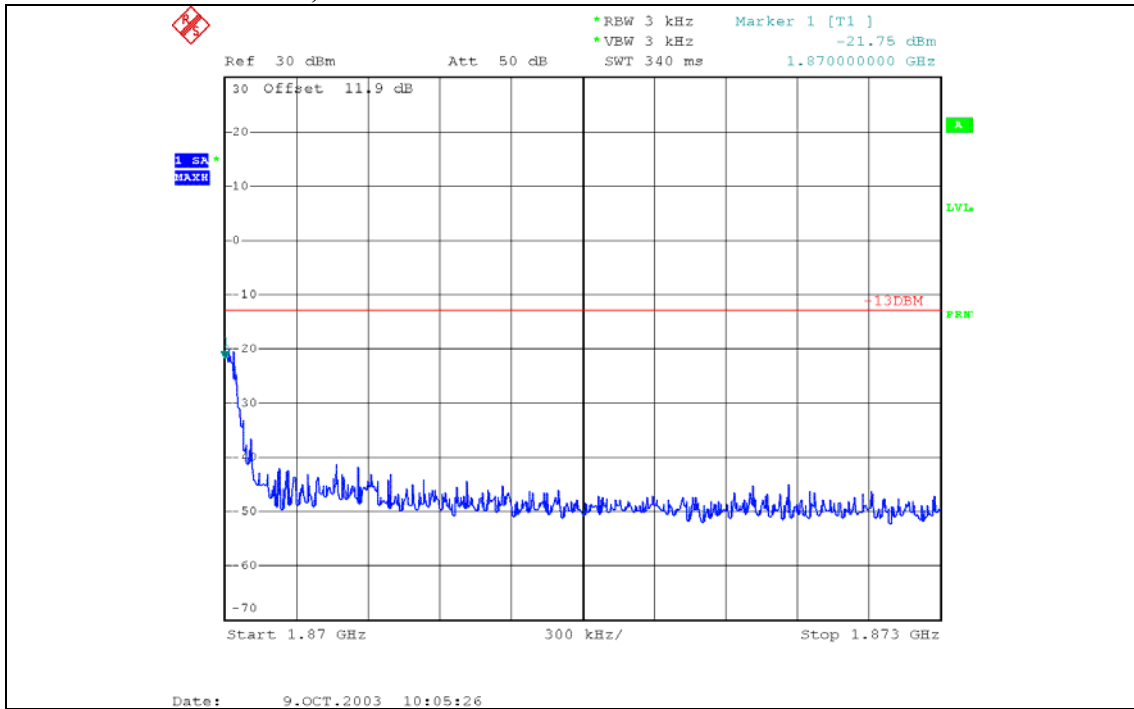

Plot 8.4m PCS Block 3, below 1870 MHz

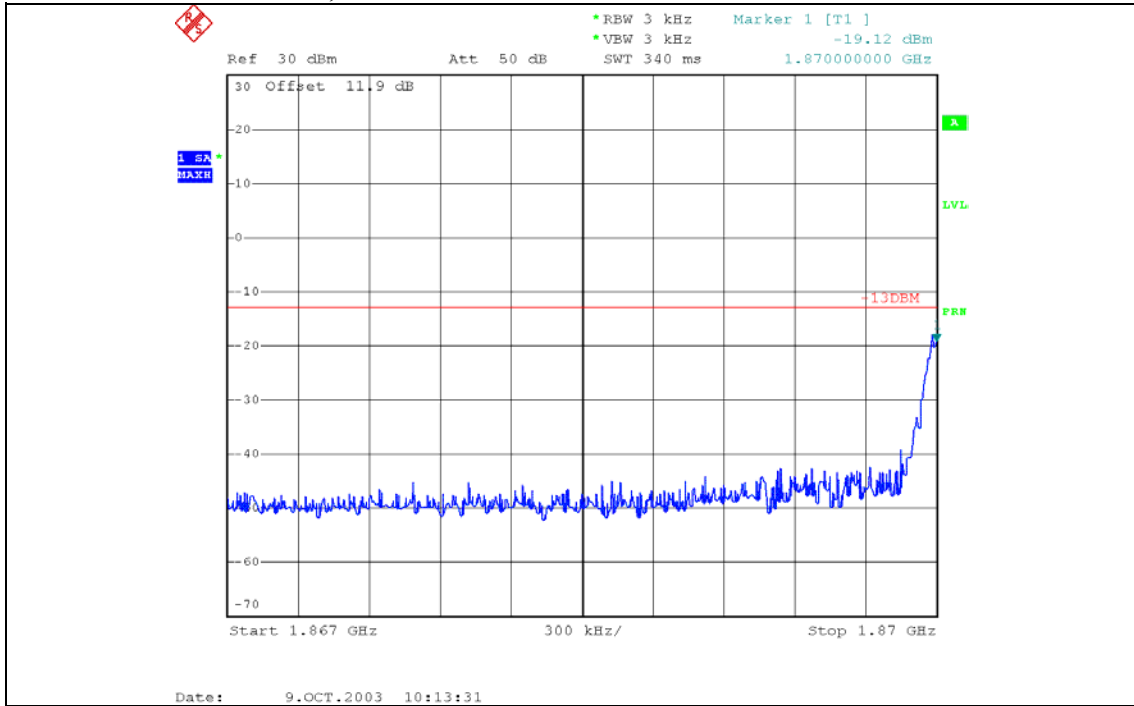

Plot 8.4n PCS Block 3, above 1885 MHz

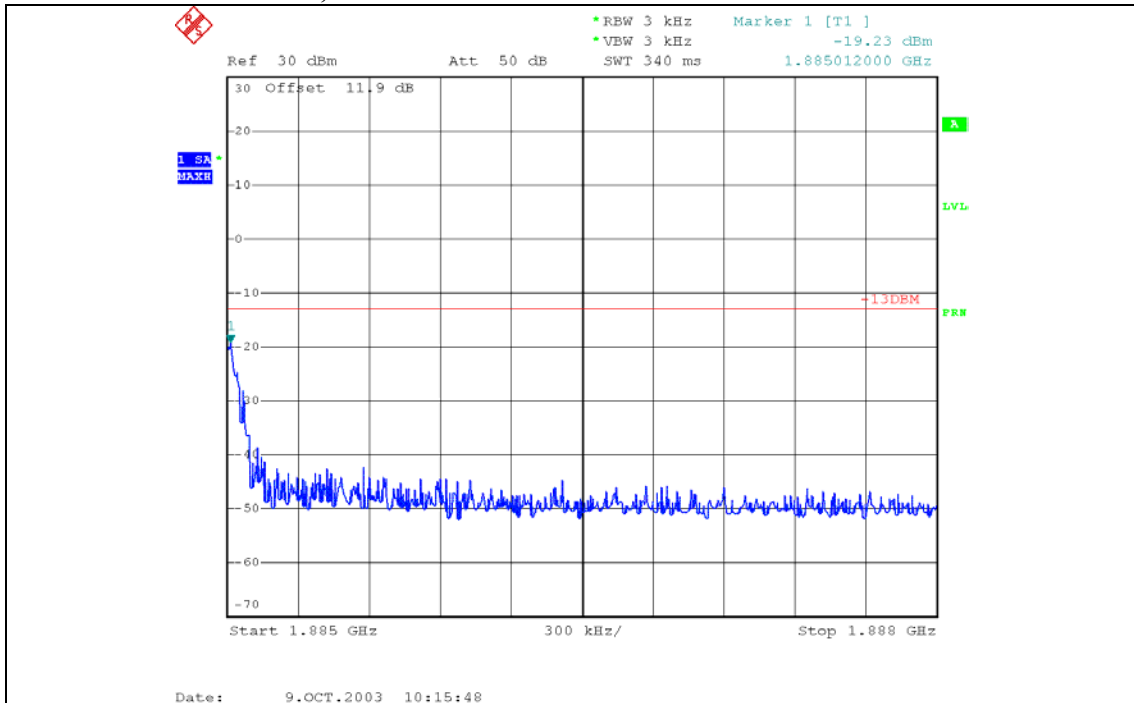

SIERRA WIRELESS, INC.

Plot 8.4o PCS Block 4, below 1885 MHz

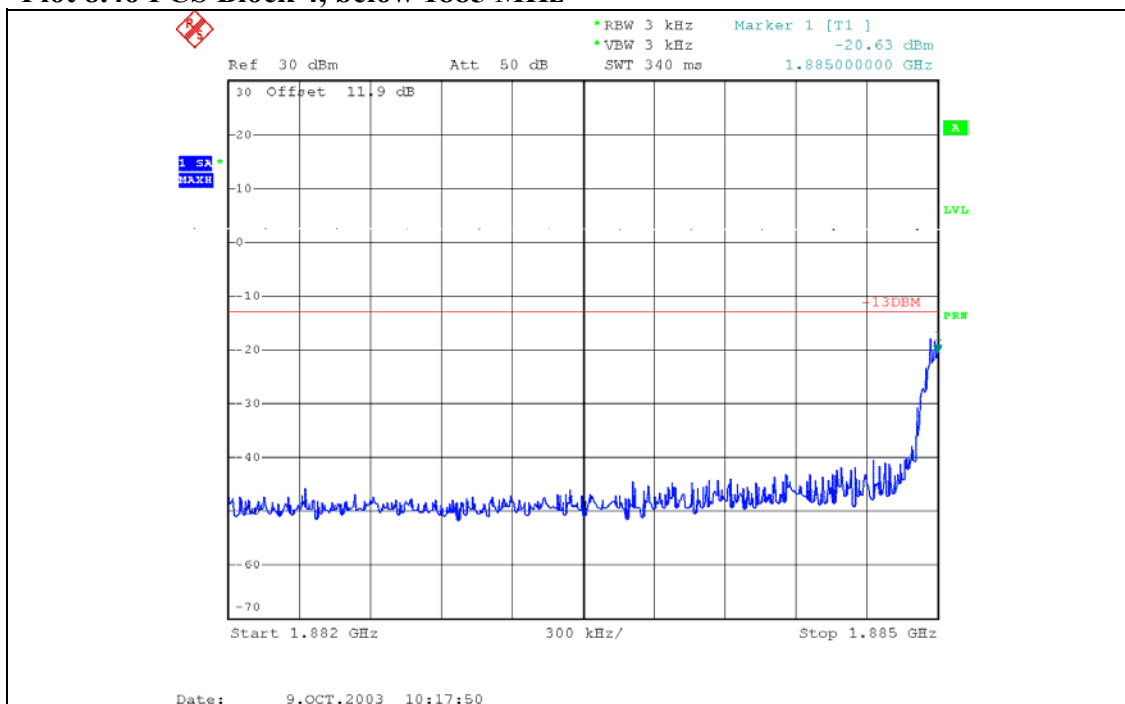

Plot 8.4p PCS Block 4, above 1890 MHz

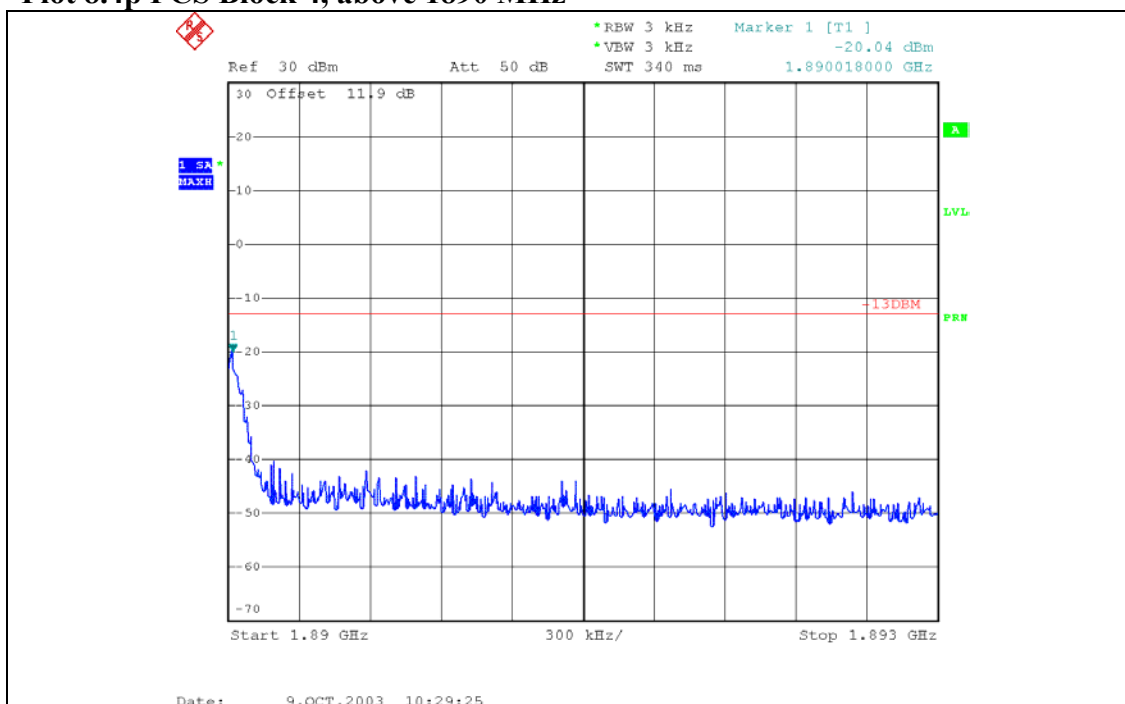

SIERRA WIRELESS, INC.

Plot 8.4q PCS Block 5, below 1890 MHz

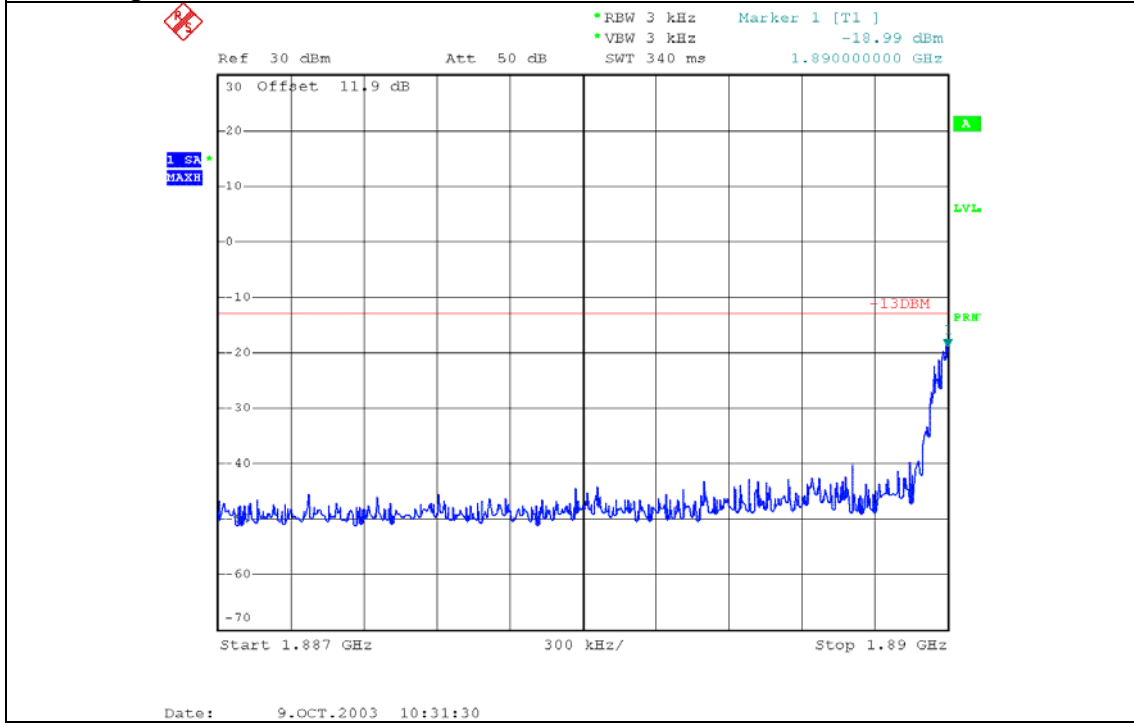

Plot 8.4r PCS Block 5, above 1895 MHz

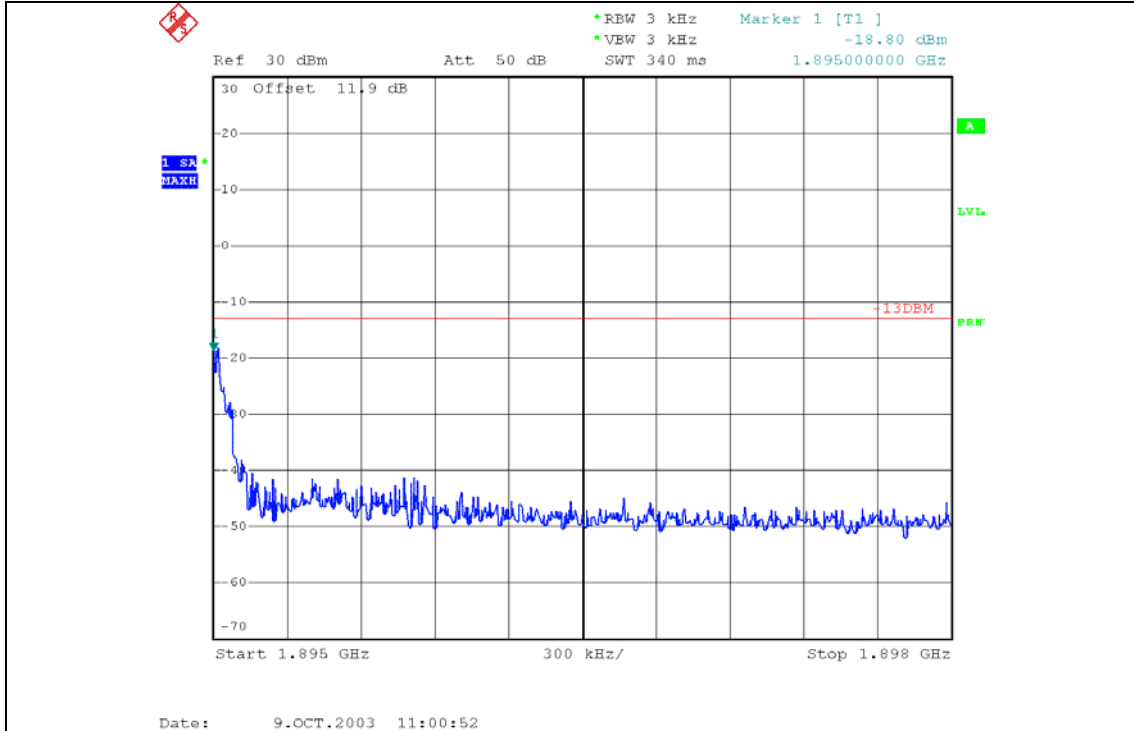

SIERRA WIRELESS, INC.

Plot 8.4s PCS Block 6, below 1895 MHz

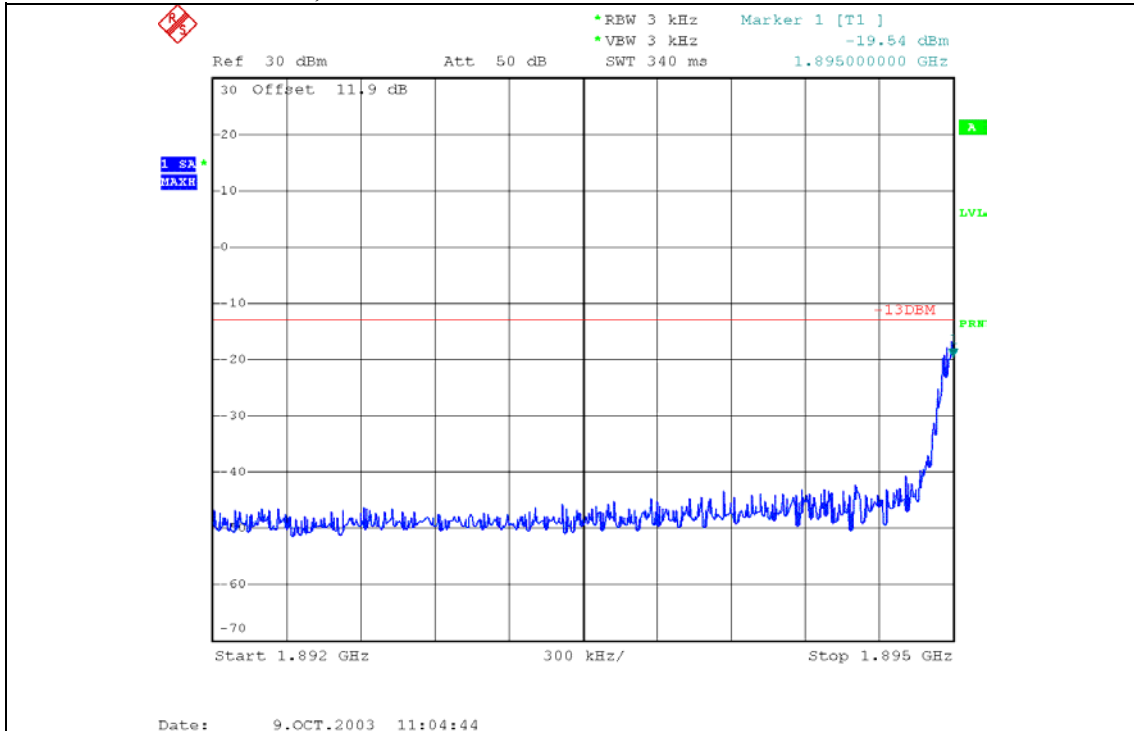

Plot 8.4t PCS Block 6, above 1910 MHz

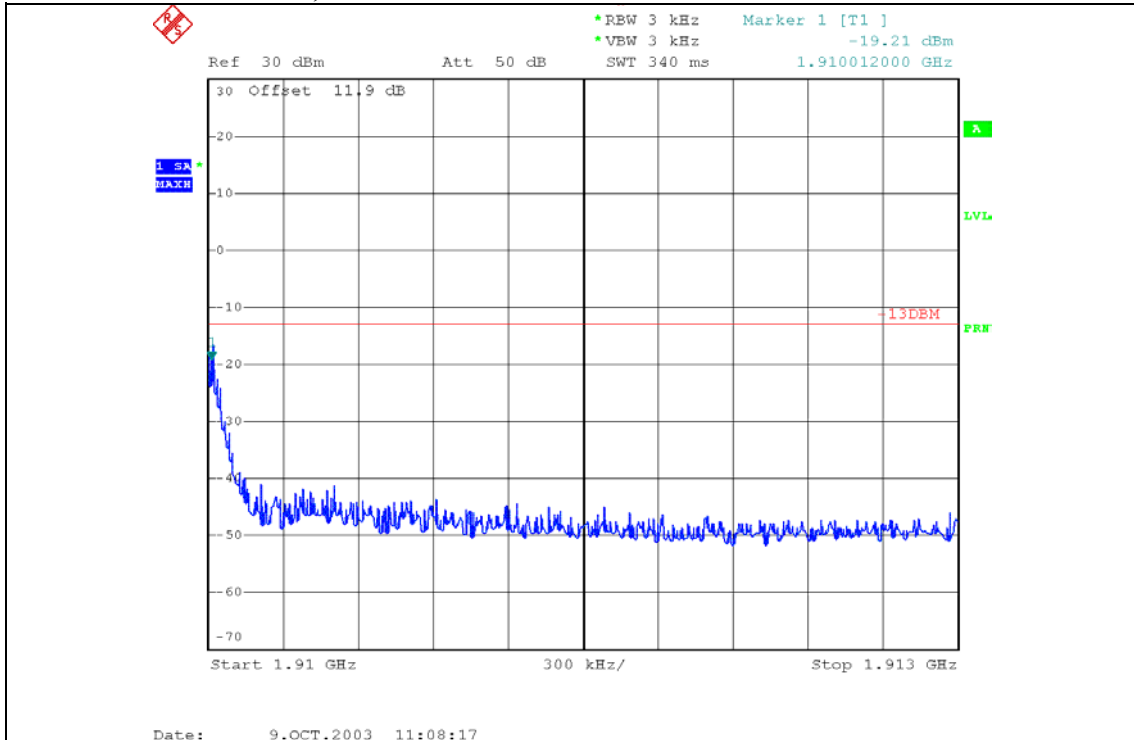

8 Frequency Stability Versus Temperature

FCC 2.1055

8.1 Summary of Results

The AC755 Frequency Stability versus temperature meets the requirement of being within ± 0.1 ppm of the received base station frequency.

8.2 Test Procedure

The AC755 was placed inside the temperature chamber. The transmitting frequency error is measured at 25 degrees C, then the temperature is set to +60 degrees C and allowed to stabilize. After sufficient soak time, the transmitting frequency error is measured. The temperature is decreased by 10 degrees, allowed to stabilize and soak, then the measurement is repeated. This is repeated until -20 degrees C is completed. The process is then repeated back up to +60 degrees C. Frequency metering included internal averaging of the CMU200 to stabilize the reading. Reference power supply voltage for these tests is 5.0 volts.

Test Setup

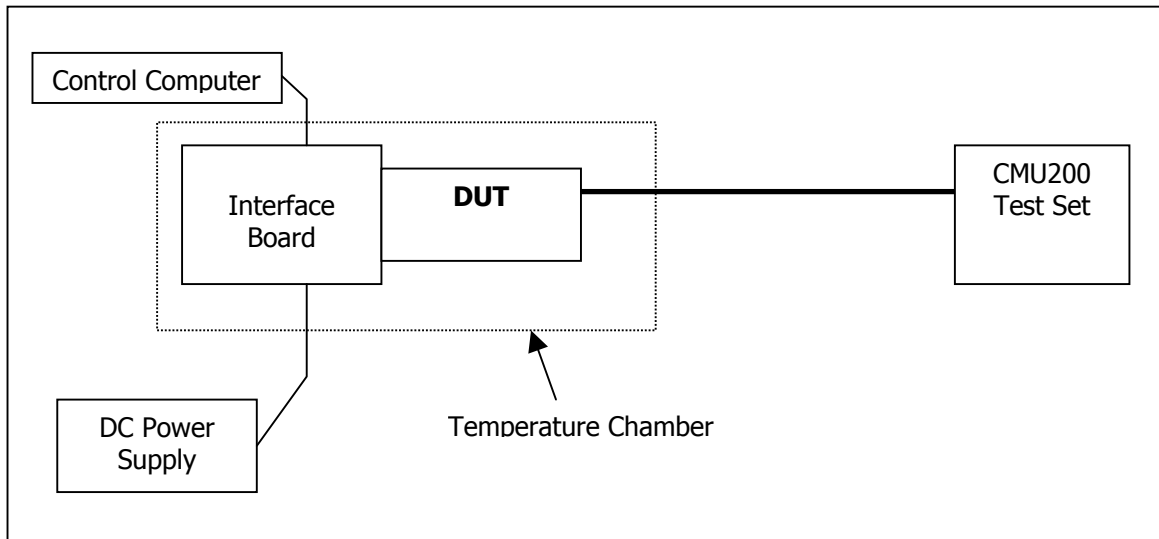

8.3 Test Equipment

EQUIPMENT	MANUFACTURER	MODEL NO.	SERIAL NO.	CAL. DATE
Control Computer	TC	Generic PC	100488	N/A
Wireless Test Set	Rohde & Schwarz	CMU200	836766/030	N/A
Spectrum Analyzer	Rohde & Schwarz	FSP 30GHz	US41421268	Sept. 12, 2003
DC Power Supply	HP	E3631A	100060	N/A
Interface Board	Shop built	Minnow	N/A	N/A

8.4 Test Results

High to Low Temperature Frequency Error

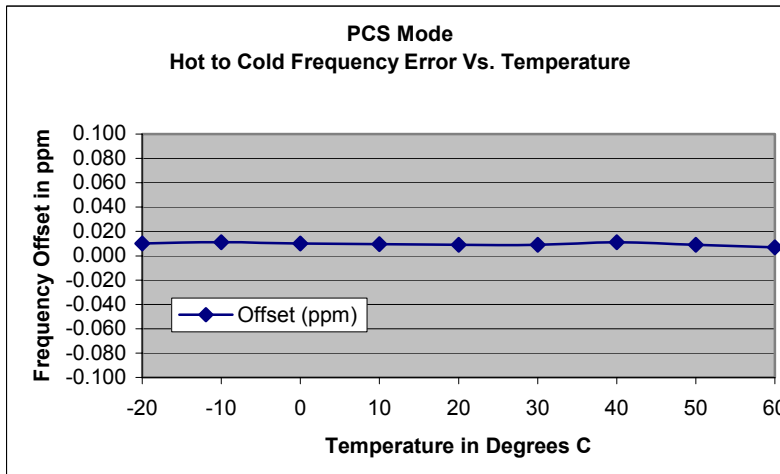
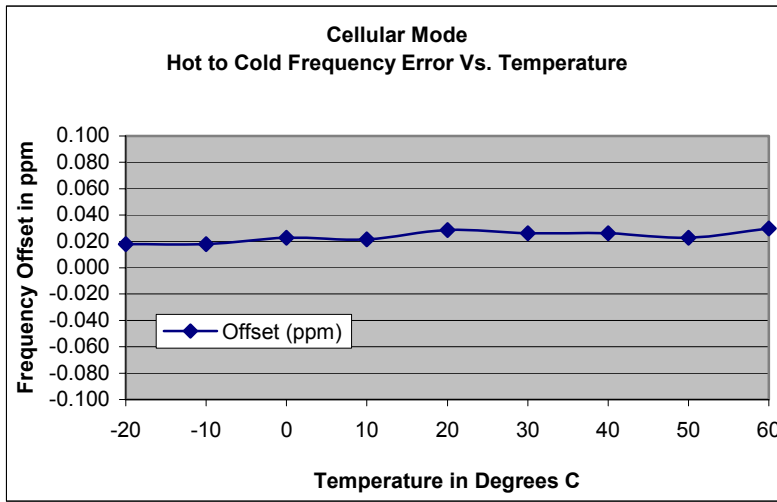

High to Low Temperature Tabular Readings

Temp (C)	Cellular Mode		PCS Mode	
	Offset (Hz)	Offset (ppm)	Offset (Hz)	Offset (ppm)
60	25	0.030	13	0.007
50	19	0.023	17	0.009
40	22	0.026	21	0.011
30	22	0.026	17	0.009
20	24	0.029	17	0.009
10	18	0.022	18	0.010
0	19	0.023	19	0.010
-10	15	0.018	21	0.011
-20	15	0.018	19	0.010

SIERRA WIRELESS, INC.

Low to High Temperature Frequency Error

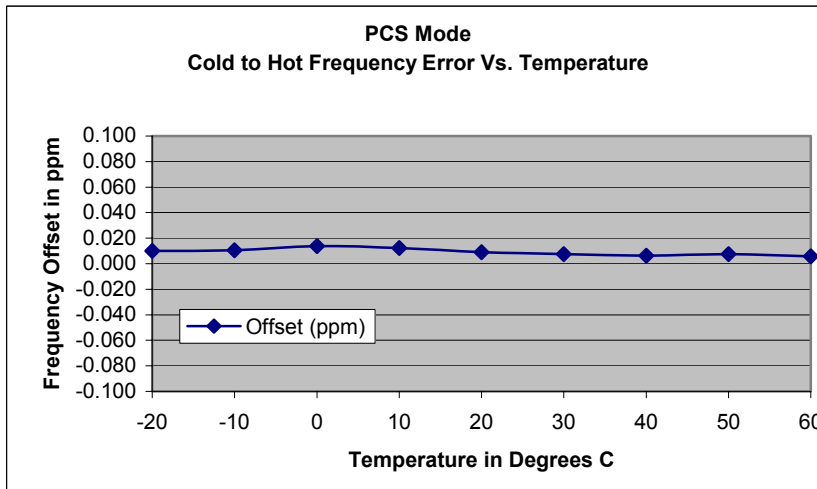
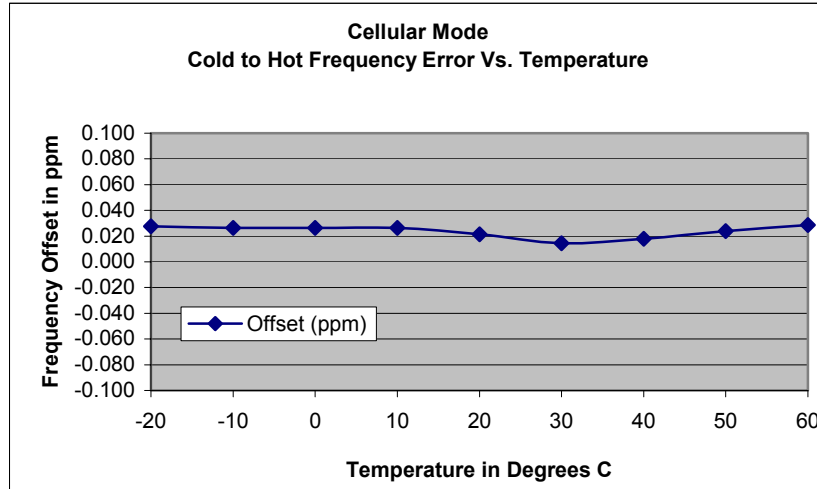

Low to High Temperature Tabular Readings

Temp (C)	Cellular Mode		PCS Mode	
	Offset (Hz)	Offset (ppm)	Offset (Hz)	Offset (ppm)
-20	23	0.027	19	0.010
-10	22	0.026	20	0.011
0	22	0.026	26	0.014
10	22	0.026	23	0.012
20	18	0.022	17	0.009
30	12	0.014	14	0.007
40	15	0.018	12	0.006
50	20	0.024	14	0.007
60	24	0.029	11	0.006

9 Frequency Stability Versus Voltage

FCC 2.1055

9.1 Summary of Results

The unit meets the limit of less than 0.1ppm of frequency offset from center for 85% and 115% of the supply voltage for 5.0 volts.

9.2 Test Procedure

The AC755 was connected to a DC Power Supply and a GSM test set (CMU 200) with frequency error measurement capability. The power supply output is adjusted to the test voltage as measured at the input terminals to the module while transmitting. A voltmeter was used to confirm the terminal voltage.

The test voltages are 4.25 volts to 5.75 volts.

Test Setup

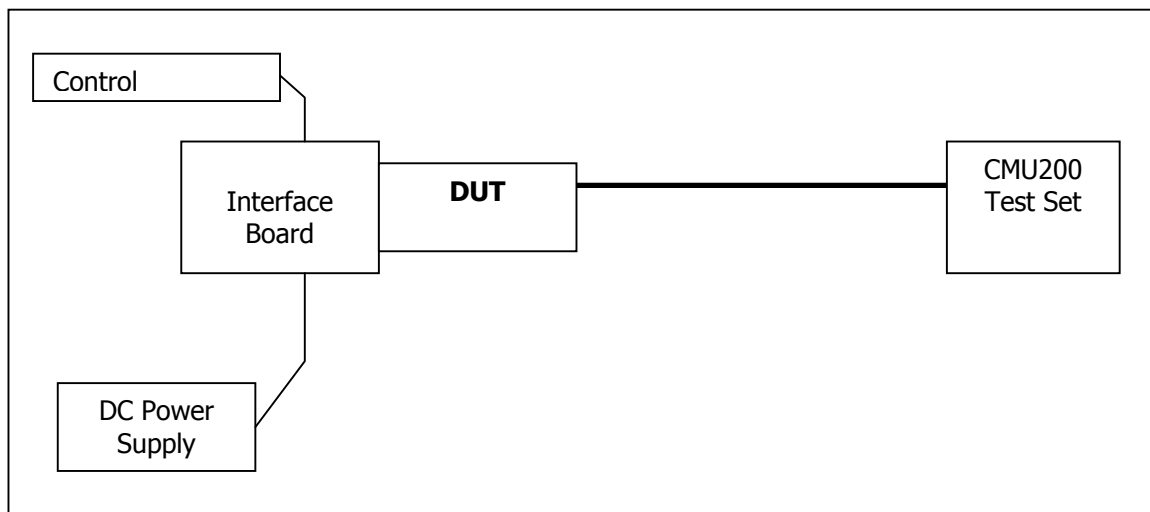

9.3 Test Equipment

EQUIPMENT	MANUFACTURER	MODEL NO.	SERIAL NO.	CAL. DATE
Control Computer	TC	Generic PC	100488	N/A
Wireless Test Set	Rohde & Schwarz	CMU200	836766/030	N/A
Spectrum Analyzer	Rohde & Schwarz	FSP 30GHz	US41421268	Sept. 12, 2003
DC Power Supply	HP	E3631A	100060	N/A
Interface Board	Shop built	Minnow	N/A	N/A

9.4 Test Results

85% to 115% of 5 Volts Frequency Error

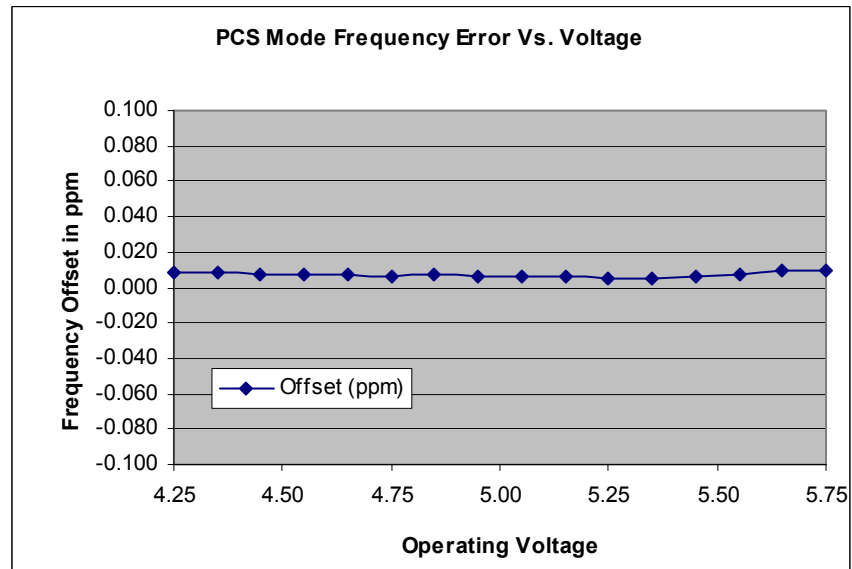
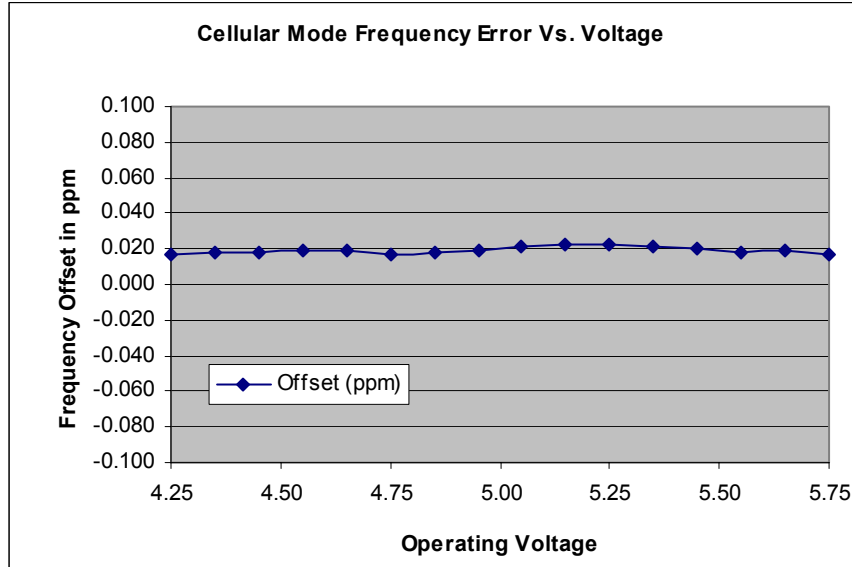

SIERRA WIRELESS, INC.

85% to 115% of 5 Volts Frequency Error, Tabular Data

Supply (V)	Cellular Mode		PCS Mode	
	Offset (Hz)	Offset (ppm)	Offset (Hz)	Offset (ppm)
4.25	14	0.017	15	0.008
4.35	15	0.018	15	0.008
4.45	15	0.018	14	0.007
4.55	16	0.019	14	0.007
4.65	16	0.019	13	0.007
4.75	14	0.017	11	0.006
4.85	15	0.018	13	0.007
4.95	16	0.019	11	0.006
5.05	18	0.022	11	0.006
5.15	19	0.023	12	0.006
5.25	19	0.023	9	0.005
5.35	18	0.022	9	0.005
5.45	17	0.020	12	0.006
5.55	15	0.018	14	0.007
5.65	16	0.019	17	0.009
5.75	14	0.017	17	0.009