

DECLARATION OF COMPLIANCE SAR RF EXPOSURE EVALUATION

Test Lab

CELLTECH LABS INC.
Testing and Engineering Services
1955 Moss Court
Kelowna, B.C.
Canada V1Y 9L3
Phone: 250-448-7047
Fax: 250-448-7046
e-mail: info@celltechlabs.com
web site: www.celltechlabs.com

Applicant Information

ITRONIX CORPORATION
801 South Stevens Street
Spokane, WA 99210-0179

Rule Part(s):	FCC 47 CFR §2.1093; IC RSS-102 Issue 1 (Provisional)
Test Procedure(s):	FCC OET Bulletin 65, Supplement C (01-01)
FCC Device Classification:	Digital Transmission System (DTS)
IC Device Classification:	Low Power License-Exempt Radiocommunication Device
FCC ID:	KBCIX260MPIA555BT
Model(s):	IX260
Device Type:	Rugged Laptop PC with Cisco Systems MPI-350 Mini-PCI DSSS WLAN Card (Co-located with Sierra Wireless AirCard 555/550 PCS/Cellular CDMA Modem & Mitsumi WML-C11 Bluetooth Transmitter)
Tx Frequency Range(s):	2412 - 2462 MHz (WLAN) 2402 - 2480 MHz (Bluetooth) 1851.25 - 1908.75 MHz (PCS CDMA) 824.70 - 848.31 MHz (Cellular CDMA)
RF Output Power Tested:	21.2 dBm - WLAN Peak Conducted (2437 MHz) 14.5 dBm - Bluetooth Peak Conducted (2441 MHz) 23.0 dBm - PCS CDMA Conducted (1880.00 MHz) 23.0 dBm - Cellular CDMA Conducted (835.89 MHz)
Antenna Type(s):	Internal - upper right edge of LCD display (WLAN) Internal - upper left edge of LCD display (Bluetooth) External Dipole (PCS/Cellular CDMA)
Battery Type:	11.1V Lithium-Ion, 6.0Ah (Model: A2121-2)
Max. SAR Measured:	1.31 W/kg (1g average)

Celltech Labs Inc. declares under its sole responsibility that this wireless portable device has demonstrated compliance with the Specific Absorption Rate (SAR) RF exposure requirements specified in FCC 47 CFR §2.1093 and Health Canada's Safety Code 6. The device was tested in accordance with the measurement standards and procedures specified in FCC OET Bulletin 65, Supplement C (Edition 01-01) and Industry Canada RSS-102 Issue 1 (Provisional) for the General Population / Uncontrolled Exposure environment.

I attest to the accuracy of data. All measurements were performed by me or were made under my supervision and are correct to the best of my knowledge and belief. I assume full responsibility for the completeness of these measurements and vouch for the qualifications of all persons taking them.

This test report shall not be reproduced partially, or in full, without the prior written approval of Celltech Labs Inc. The results and statements contained in this report pertain only to the device(s) evaluated.



Russell Pipe
Senior Compliance Technologist
Celltech Labs Inc.



TABLE OF CONTENTS		
1.0	INTRODUCTION.....	3
2.0	DESCRIPTION OF DUT.....	3
3.0	SAR MEASUREMENT SYSTEM	4
4.0	MEASUREMENT SUMMARY.....	5
5.0	DETAILS OF SAR EVALUATION.....	6
6.0	EVALUATION PROCEDURES.....	6-7
7.0	SYSTEM PERFORMANCE CHECK.....	8
8.0	EQUIVALENT TISSUES.....	9
9.0	SAR LIMITS.....	9
10.0	SYSTEM SPECIFICATIONS.....	10
11.0	PROBE SPECIFICATION.....	11
12.0	SAM PHANTOM.....	11
13.0	DEVICE HOLDER.....	11
14.0	TEST EQUIPMENT LIST.....	12
15.0	MEASUREMENT UNCERTAINTIES.....	13-14
16.0	REFERENCES.....	15
	APPENDIX A - SAR MEASUREMENT DATA.....	16
	APPENDIX B - SYSTEM PERFORMANCE CHECK DATA.....	17
	APPENDIX C - SYSTEM VALIDATION.....	18
	APPENDIX D - PROBE CALIBRATION.....	19
	APPENDIX E - MEASURED FLUID DIELECTRIC PARAMETERS.....	20
	APPENDIX F - SAM PHANTOM CERTIFICATE OF CONFORMITY.....	21
	APPENDIX G - SAR TEST SETUP PHOTOGRAPHS.....	22

1.0 INTRODUCTION

This measurement report demonstrates that the ITRONIX CORPORATION Model: IX260 Rugged Laptop PC with internal Cisco Systems MPI-350 Mini-PCI DSSS WLAN Card (co-located with Sierra Wireless AirCard 555/550 Dual-Band PCS/Cellular CDMA Modem and Mitsumi WML-C11 Bluetooth Transmitter) FCC ID: KBCIX260MPIA555BT complies with the SAR (Specific Absorption Rate) RF exposure requirements specified in FCC 47 CFR §2.1093 (see reference [1]), and Health Canada Safety Code 6 (see reference [2]) for the General Population environment. The test procedures described in FCC OET Bulletin 65, Supplement C, Edition 01-01 (see reference [3]) and IC RSS-102 Issue 1 (Provisional) (see reference [4]) were employed. A description of the product, operating configuration, detailed summary of the test results, methodology and procedures used in the evaluation, equipment used, and the various provisions of the rules are included within this test report.

2.0 DESCRIPTION of Device Under Test (DUT)

FCC Rule Part(s)	47 CFR §2.1093
IC Rule Part(s)	IC RSS-102 Issue 1 (Provisional)
Test Procedure(s)	FCC OET Bulletin 65, Supplement C (01-01)
FCC Device Classification	Digital Transmission System (DTS)
IC Device Classification	Low Power License-Exempt Radiocommunication Device
Device Type	Rugged Laptop PC with Cisco MPI-350 Mini-PCI DSSS WLAN Card (co-located with Sierra Wireless AirCard 555/550 Dual-Band PCS/Cellular CDMA Modem & Mitsumi WML-C11 Bluetooth Transmitter)
FCC ID	KBCIX260MPIA555BT
Model(s)	IX260
Serial No.	ZZGEG3135ZZ1409 (Identical Prototype)
Tx Frequency Range(s)	2412 - 2462 MHz (WLAN) 2402 - 2480 MHz (Bluetooth) 1851.25 - 1908.75 MHz (PCS CDMA) 824.70 - 848.31 MHz (Cellular CDMA)
RF Output Power Tested	21.2 dBm - WLAN Peak Conducted (2437 MHz) 14.5 dBm - Bluetooth Peak Conducted (2441 MHz) 23.0 dBm - PCS CDMA Conducted (1880.00 MHz) 23.0 dBm - Cellular CDMA Conducted (835.89 MHz)
Antenna Type(s)	Internal - upper right edge of LCD display (WLAN) Internal - upper left edge of LCD display (Bluetooth) External Dipole (PCS/Cellular CDMA)
Battery Type	11.1V Lithium-Ion, 6.0Ah (Model: A2121-2)

3.0 SAR MEASUREMENT SYSTEM

Celltech Labs SAR measurement facility utilizes the Dosimetric Assessment System (DASY™) manufactured by Schmid & Partner Engineering AG (SPEAG™) of Zurich, Switzerland. The DASY system is comprised of the robot controller, computer, near-field probe, probe alignment sensor, specific anthropomorphic mannequin (SAM) phantom, and various planar phantoms for brain and/or body SAR evaluations. The robot is a six-axis industrial robot performing precise movements to position the probe to the location (points) of maximum electromagnetic field (EMF). A cell controller system contains the power supply, robot controller, teach pendant (Joystick), and remote control, is used to drive the robot motors. The Staubli robot is connected to the cell controller to allow software manipulation of the robot. A data acquisition electronic (DAE) circuit performs the signal amplification, signal multiplexing, AD-conversion, offset measurements, mechanical surface detection, collision detection, etc. is connected to the Electro-optical coupler (EOC). The EOC performs the conversion from the optical into digital electric signal of the DAE and transfers data to the PC plug-in card. The DAE3 utilizes a highly sensitive electrometer-grade preamplifier with auto-zeroing, a channel and gain-switching multiplexer, a fast 16-bit AD-converter and a command decoder and control logic unit. Transmission to the PC-card is accomplished through an optical downlink for data and status information and an optical uplink for commands and clock lines. The mechanical probe-mounting device includes two different sensor systems for frontal and sidewise probe contacts. They are also used for mechanical surface detection and probe collision detection. The robot uses its own controller with a built in VME-bus computer.



DASY3 SAR Measurement System with SAM phantom

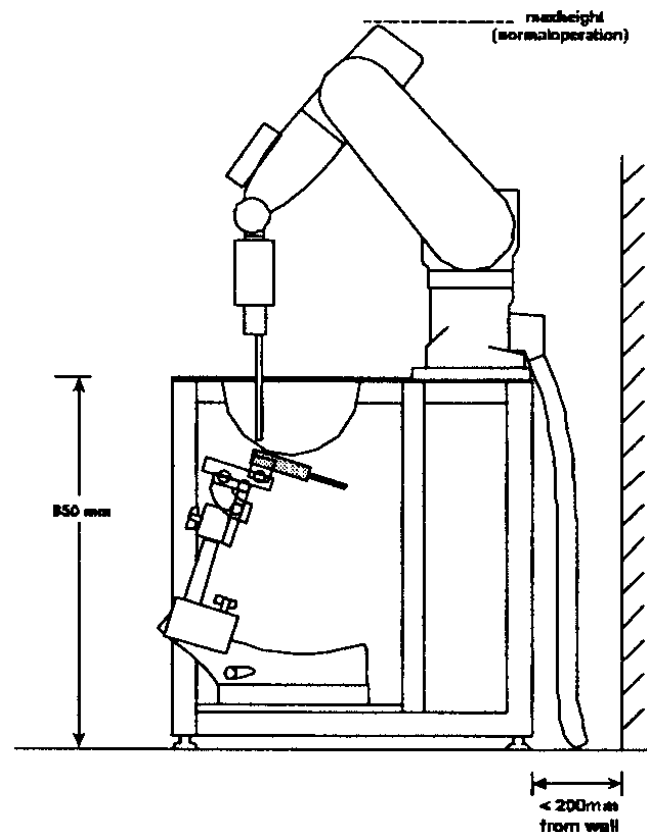

Figure 1. DASY3 Compact Version - Side View

4.0 MEASUREMENT SUMMARY

BODY SAR MEASUREMENT RESULTS										
Transmitter Mode(s)	WLAN Freq. (MHz)	WLAN Channel	WLAN Test Mode	Peak Conducted Power (dBm)		Battery Type	Antenna Tested	Laptop PC Position to Planar Phantom	Separation Distance to Planar Phantom (cm)	Measured SAR 1g (W/kg)
				Before	After					
WLAN	2437	Mid	CW	21.2	21.1	Lithium-ion	Right Side (WLAN)	Back of LCD (LCD Closed)	0.0	1.21
WLAN	2412	Low	CW	21.2	21.1	Lithium-ion	Right Side (WLAN)	Back of LCD (LCD Closed)	0.0	1.18
WLAN	2462	High	CW	21.1	21.0	Lithium-ion	Right Side (WLAN)	Back of LCD (LCD Closed)	0.0	0.980
WLAN PCS CDMA	2437	Mid	CW	21.2	21.1	Lithium-ion	Right Side (WLAN)	Back of LCD (LCD Closed)	0.0	1.29
WLAN PCS CDMA	2412	Low	CW	21.2	21.1	Lithium-ion	Right Side (WLAN)	Back of LCD (LCD Closed)	0.0	1.28
WLAN PCS CDMA	2462	High	CW	21.1	21.0	Lithium-ion	Right Side (WLAN)	Back of LCD (LCD Closed)	0.0	1.15
WLAN PCS CDMA Bluetooth	2437	Mid	CW	21.2	21.1	Lithium-ion	Right Side (WLAN)	Back of LCD (LCD Closed)	0.0	1.23
WLAN PCS CDMA Bluetooth	2412	Low	CW	21.2	21.1	Lithium-ion	Right Side (WLAN)	Back of LCD (LCD Closed)	0.0	1.31
WLAN PCS CDMA Bluetooth	2462	High	CW	21.1	21.0	Lithium-ion	Right Side (WLAN)	Back of LCD (LCD Closed)	0.0	1.11
ANSI / IEEE C95.1 1992 - SAFETY LIMIT BODY: 1.6 W/kg (averaged over 1 gram) Spatial Peak - Uncontrolled / General Population										
Test Date(s)	08/29/03		Relative Humidity		48 %					
Measured Mixture Type	2450 MHz Body		Atmospheric Pressure		102.4 kPa					
Dielectric Constant ϵ_r	IEEE Target	Measured	Ambient Temperature		23.9 °C					
	52.7 ±5%	50.3	Fluid Temperature		23.9 °C					
Conductivity σ (mho/m)	IEEE Target	Measured	Fluid Depth		≥ 15 cm					
	1.95 ±5%	1.98	ρ (Kg/m³)		1000					

Note(s):

- The measurement results were obtained with the DUT tested in the conditions described in this report. Detailed measurement data and plots showing the maximum SAR location of the DUT are reported in Appendix A.
- If the SAR measurements performed at the middle channel were ≥ 3dB below the SAR limit, SAR evaluation for the low and high channels was optional (per FCC OET Bulletin 65, Supplement C, Edition 01-01 (see reference [3])).
- The simultaneous transmit SAR evaluations were performed with the co-located dual-band CDMA Modem set to the maximum conducted power level (23.0 dBm) in the PCS band at the mid channel frequency (1880 MHz), and transmitting continuously in the “always up” power control mode with a modulated CDMA signal. The Bluetooth transmitter was tested at the maximum conducted power level (14.5 dBm) at the mid channel (2441 MHz) in modulated continuous transmit mode with the frequency hopping disabled.
- The simultaneous transmit SAR evaluations were performed with the co-located dual-band CDMA Modem in the PCS band, based on the PCS CDMA mode being the highest SAR level configuration during the Part 24 evaluation filed simultaneously with this application.
- The DUT was tested with the LCD display lid in the closed position and the external dipole antenna in the stowed position, which was determined to be the worst-case configuration based on the internal transmitters continuing to transmit with the LCD display lid closed.

5.0 DETAILS OF SAR EVALUATION

The ITRONIX CORPORATION Model: IX260 Rugged Laptop PC with internal Cisco Systems MPI-350 Mini-PCI DSSS WLAN Card (co-located with Sierra Wireless AirCard 555/550 Dual-Band PCS/Cellular CDMA Modem and Mitsumi WML-C11 Bluetooth Transmitter) FCC ID: KBCIX260MPIA555BT was found to be compliant for localized Specific Absorption Rate based on the following test provisions and conditions described below. The detailed test setup photographs are shown in Appendix G.

1. The DUT was tested for body SAR with the LCD display closed and the back of the LCD display facing parallel to the outer surface of the SAM phantom (planar section). A 0.0 cm separation distance was maintained between the back of the LCD display and the outer surface of the SAM phantom (planar section). The DUT was tested with the LCD display lid in the closed position and the external dipole antenna in the stowed position, which was determined to be the worst-case configuration based on the internal transmitters continuing to transmit with the LCD display lid closed.
2. Due to the dimensions of the DUT the initial coarse scans did not cover the entire area of the Laptop PC. Subsequently, a second coarse scan was performed for the highest SAR configurations to show there were no secondary peak SAR locations within 2 dB of the primary peak values.
3. A 1.3 dB cable offset was entered into the Gigatronics 8652A Universal Power Meter prior to the conducted power measurements. The peak conducted power levels were measured before and after each test according to the procedures described in FCC 47 CFR §2.1046.
4. The WLAN transmitter was controlled via internal software and tested at maximum power in unmodulated continuous transmit operation (Continuous Wave mode at 100% duty cycle).
5. The co-located SAR evaluations were performed with the Sierra Wireless AirCard 555/550 PCS/Cellular CDMA Modem set to the maximum conducted power level (23.0 dBm) at the PCS mid channel (1880 MHz), and transmitting continuously in the "always up" power control mode with a modulated CDMA signal. The Bluetooth transmitter was tested at the maximum conducted power level (14.5 dBm) at the mid channel (2441 MHz) in modulated continuous transmit mode with the frequency hopping disabled.
6. The simultaneous transmit SAR evaluations were performed with the co-located dual-band CDMA Modem in the PCS band, based on the PCS CDMA mode being the highest SAR level configuration during the Part 24 evaluation filed simultaneously with this application.
7. Due to the dimensions of the DUT, a stack of low-density, low-loss dielectric foamed polystyrene was used in place of the device holder.
8. The DUT was tested with a fully charged battery.
9. The ambient and fluid temperatures were measured prior to, and during, the fluid dielectric parameter check and the SAR evaluation. The temperatures listed in the test data table were consistent for all measurement periods.
10. The dielectric parameters of the simulated body fluid were measured prior to the evaluation using an 85070C Dielectric Probe Kit and an 8753E Network Analyzer (see Appendix E for measured fluid dielectric parameters).

6.0 EVALUATION PROCEDURES

- a. (i) The evaluation was performed in the applicable area of the phantom depending on the type of device being tested. For devices held to the ear during normal operation, both the left and right ear positions were evaluated in accordance with FCC OET Bulletin 65, Supplement C (Edition 01-01) using the SAM phantom.
(ii) For body-worn and face-held devices a planar phantom was used.
- b. The SAR was determined by a pre-defined procedure within the DASY3 software. Upon completion of a reference and optical surface check, the exposed region of the phantom was scanned near the inner surface with a grid spacing of 20mm x 20mm.
- c. Based on the area scan data, the area of maximum absorption was determined by spline interpolation. Around this point, a volume of 40 x 40 x 35 mm (fine resolution volume scan, zoom scan) was assessed by measuring 5 x 5 x 7 points.
- d. The 1g and 10g spatial peak SAR was determined as follows:
- e. The first step was an extrapolation to find the points between the dipole center of the probe and the surface of the phantom. This data cannot be measured, since the center of the dipoles is 2.7 mm away from the tip of the probe and the distance between the surface and the lowest measuring point is 1.4 mm (see probe calibration document in Appendix D). The extrapolation was based on a least square algorithm [W. Gander, Computermathematik, p.168-180] (see reference [6]). Through the points in the first 3 cm in all z-axis, polynomials of the fourth order were calculated. This polynomial was then used to evaluate the points between the surface and the probe tip.
- f. The next step used 3D-spline interpolation to get all points within the measured volume in a 1mm grid (35000 points). The 3D-spline is composed of three one-dimensional splines with the "Not a knot" condition [W. Gander, Computermathematik, p.141-150] (x, y and z -direction) [Numerical Recipes in C, Second Edition, p.123ff] (see reference [6]).
3. The maximal interpolated value was searched with a straightforward algorithm. Around this maximum the SAR values averaged over the spatial volumes (1g or 10g) were computed using the 3D-spline interpolation algorithm. 8000 points (20x20x20) were interpolated to calculate the average.

EVALUATION PROCEDURES (Cont.)

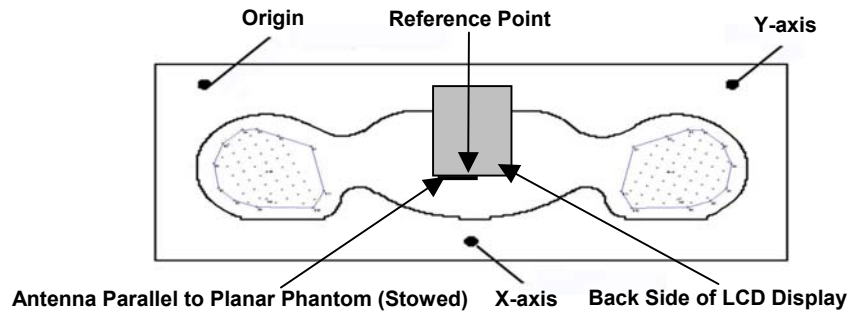

**Figure 2. Phantom Reference Point & DUT Positioning
Back Side of LCD Display (Closed) - Cube Scan**

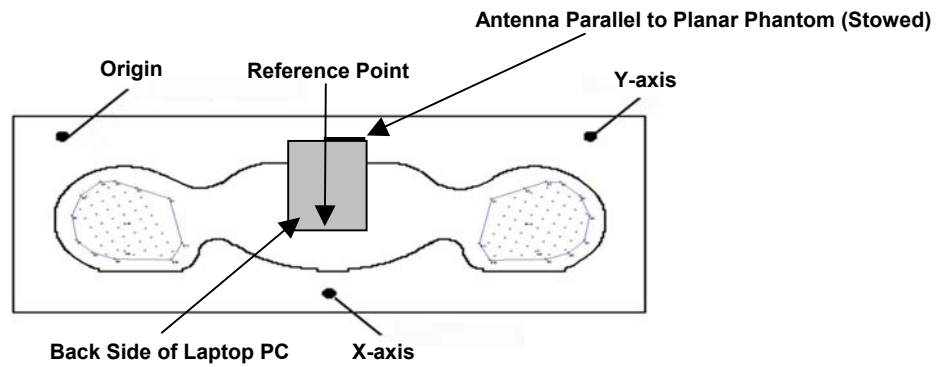

**Figure 3. Phantom Reference Point & DUT Positioning
2nd Half of the Back Side LCD Display (Closed) - Coarse Scan**

7.0 SYSTEM PERFORMANCE CHECK

Prior to the evaluation a system check was performed in the planar section of the SAM phantom with a 2450MHz dipole (see Appendix C for system validation procedures). The dielectric parameters of the simulated brain tissue mixture were measured using an 85070C Dielectric Probe Kit and an 8753E Network Analyzer prior to the system performance check (see Appendix E for printout of measured fluid dielectric parameters). A forward power of 250 mW was applied to the dipole and the measurement system was verified to a tolerance of $\pm 10\%$ (see Appendix B for system performance check test plot).

SYSTEM PERFORMANCE CHECK											
Test Date	2450MHz Equiv. Tissue	SAR 1g (W/kg)		Dielectric Constant ϵ_r		Conductivity σ (mho/m)		ρ (Kg/m ³)	Ambient Temp.	Fluid Temp.	Fluid Depth
		IEEE Target	Measured	IEEE Target	Measured	IEEE Target	Measured				
08/29/03	Brain	13.1 $\pm 10\%$	14.0 +6.9%	39.2 $\pm 5\%$	37.4	1.80 $\pm 5\%$	1.85	1000	25.5 °C	23.8 °C	≥ 15 cm

Note(s):

1. The ambient and fluid temperatures were measured prior to, and during, the fluid dielectric parameter check and the system performance check. The temperatures listed in the table above were consistent for all measurement periods.

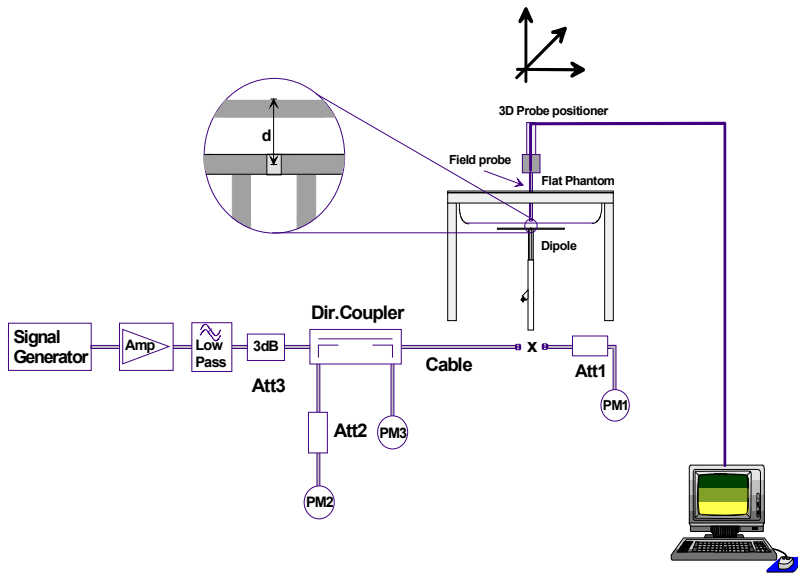

Figure 4. System Performance Check Setup Diagram



2450MHz Dipole Setup

8.0 EQUIVALENT TISSUES

The 2450MHz brain and body simulated tissue mixtures consist of Glycol-monobutyl, water, and salt (body mixture only). The fluid was prepared according to standardized procedures and measured for dielectric parameters (permittivity and conductivity).

SIMULATED TISSUE MIXTURES		
INGREDIENT	2450MHz Brain (System Check)	2450MHz Body (DUT Evaluation)
Water	55.20 %	69.95 %
Glycol Monobutyl	44.80 %	30.00 %
Salt	-	0.05 %

9.0 SAR SAFETY LIMITS

EXPOSURE LIMITS	SAR (W/kg)	
	(General Population / Uncontrolled Exposure Environment)	(Occupational / Controlled Exposure Environment)
Spatial Average (averaged over the whole body)	0.08	0.4
Spatial Peak (averaged over any 1 g of tissue)	1.60	8.0
Spatial Peak (hands/wrists/feet/ankles averaged over 10 g)	4.0	20.0

Notes:

1. Uncontrolled environments are defined as locations where there is potential exposure of individuals who have no knowledge or control of their potential exposure.
2. Controlled environments are defined as locations where there is potential exposure of individuals who have knowledge of their potential exposure and can exercise control over their exposure.

10.0 ROBOT SYSTEM SPECIFICATIONS

Specifications

POSITIONER: Stäubli Unimation Corp. Robot Model: RX60L
Repeatability: 0.02 mm
No. of axis: 6

Data Acquisition Electronic (DAE) System

Cell Controller

Processor: Pentium III
Clock Speed: 450 MHz
Operating System: Windows NT
Data Card: DASY3 PC-Board

Data Converter

Features: Signal Amplifier, multiplexer, A/D converter, and control logic
Software: DASY3 software
Connecting Lines: Optical downlink for data and status info.
Optical uplink for commands and clock

PC Interface Card

Function: 24 bit (64 MHz) DSP for real time processing
Link to DAE3
16-bit A/D converter for surface detection system
serial link to robot
direct emergency stop output for robot

E-Field Probe

Model: ET3DV6
Serial No.: 1387
Construction: Triangular core fiber optic detection system
Frequency: 10 MHz to 6 GHz
Linearity: ± 0.2 dB (30 MHz to 3 GHz)

Phantom

Type: SAM V4.0C
Shell Material: Fiberglass
Thickness: 2.0 ± 0.1 mm
Volume: Approx. 20 liters

11.0 PROBE SPECIFICATION (ET3DV6)

Construction:	Symmetrical design with triangular core Built-in shielding against static charges PEEK enclosure material (resistant to organic solvents, e.g. glycol)
Calibration:	In air from 10 MHz to 2.5 GHz In brain simulating tissue at frequencies of 900 MHz and 1.8 GHz (accuracy $\pm 8\%$)
Frequency:	10 MHz to >6 GHz; Linearity: ± 0.2 dB (30 MHz to 3 GHz)
Directivity:	± 0.2 dB in brain tissue (rotation around probe axis) ± 0.4 dB in brain tissue (rotation normal to probe axis)
Dynamic Range:	5 μ W/g to >100 mW/g; Linearity: ± 0.2 dB
Surface Detection:	± 0.2 mm repeatability in air and clear liquids over diffuse reflecting surfaces
Dimensions:	Overall length: 330 mm Tip length: 16 mm Body diameter: 12 mm Tip diameter: 6.8 mm Distance from probe tip to dipole centers: 2.7 mm
Application:	General dosimetry up to 3 GHz Compliance tests of mobile phone



ET3DV6 E-Field Probe

12.0 SAM PHANTOM V4.0C

The SAM phantom V4.0C is a fiberglass shell phantom with a 2.0 mm shell thickness for left and right head and flat planar area integrated in a wooden table. The shape of the fiberglass shell corresponds to the phantom defined by SCC34-SC2. The device holder positions are adjusted to the standard measurement positions in the three sections.

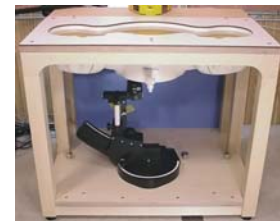

SAM Phantom

13.0 DEVICE HOLDER

The DASY3 device holder has two scales for device rotation (with respect to the body axis) and the device inclination (with respect to the line between the ear openings). The plane between the ear openings and the mouth tip has a rotation angle of 65° . The bottom plate contains three pair of bolts for locking the device holder. The device holder positions are adjusted to the standard measurement positions in the three sections.



Device Holder

14.0 TEST EQUIPMENT LIST

SAR MEASUREMENT SYSTEM		
EQUIPMENT	SERIAL NO.	CALIBRATION DATE
DASY3 System -Robot -ET3DV6 E-Field Probe -300MHz Validation Dipole -450MHz Validation Dipole -900MHz Validation Dipole -1800MHz Validation Dipole -2450MHz Validation Dipole -SAM Phantom V4.0C	599396-01 1387 135 136 054 247 150 1033	N/A Feb 2003 Oct 2002 Oct 2002 June 2003 June 2003 Oct 2002 N/A
85070C Dielectric Probe Kit	N/A	N/A
Gigatronics 8652A Power Meter -Power Sensor 80701A -Power Sensor 80701A	1835272 1833535 1833542	Feb 2003 Feb 2003 Feb 2003
Pasternack Attenuator (30dB, 2W)	PE7014-30	N/A
E4408B Spectrum Analyzer	US39240170	Dec 2002
8594E Spectrum Analyzer	3543A02721	Feb 2003
8753E Network Analyzer	US38433013	Feb 2003
8648D Signal Generator	3847A00611	Feb 2003
5S1G4 Amplifier Research Power Amplifier	26235	N/A

15.0 MEASUREMENT UNCERTAINTIES

UNCERTAINTY BUDGET FOR DEVICE EVALUATION						
Error Description	Uncertainty Value ±%	Probability Distribution	Divisor	C _i 1g	Standard Uncertainty ±% (1g)	v _i or v _{eff}
Measurement System						
Probe calibration	± 4.8	Normal	1	1	± 4.8	∞
Axial isotropy of the probe	± 4.7	Rectangular	√3	(1-c _p)	± 1.9	∞
Spherical isotropy of the probe	± 9.6	Rectangular	√3	(c _p)	± 3.9	∞
Spatial resolution	± 0.0	Rectangular	√3	1	± 0.0	∞
Boundary effects	± 5.5	Rectangular	√3	1	± 3.2	∞
Probe linearity	± 4.7	Rectangular	√3	1	± 2.7	∞
Detection limit	± 1.0	Rectangular	√3	1	± 0.6	∞
Readout electronics	± 1.0	Normal	1	1	± 1.0	∞
Response time	± 0.8	Rectangular	√3	1	± 0.5	∞
Integration time	± 1.4	Rectangular	√3	1	± 0.8	∞
RF ambient conditions	± 3.0	Rectangular	√3	1	± 1.7	∞
Mech. constraints of robot	± 0.4	Rectangular	√3	1	± 0.2	∞
Probe positioning	± 2.9	Rectangular	√3	1	± 1.7	∞
Extrapolation & integration	± 3.9	Rectangular	√3	1	± 2.3	∞
Test Sample Related						
Device positioning	± 6.0	Normal	√3	1	± 6.7	12
Device holder uncertainty	± 5.0	Normal	√3	1	± 5.9	8
Power drift	± 5.0	Rectangular	√3		± 2.9	∞
Phantom and Setup						
Phantom uncertainty	± 4.0	Rectangular	√3	1	± 2.3	∞
Liquid conductivity (target)	± 5.0	Rectangular	√3	0.6	± 1.7	∞
Liquid conductivity (measured)	± 5.0	Rectangular	√3	0.6	± 1.7	∞
Liquid permittivity (target)	± 5.0	Rectangular	√3	0.6	± 1.7	∞
Liquid permittivity (measured)	± 5.0	Rectangular	√3	0.6	± 1.7	∞
Combined Standard Uncertainty					± 13.3	
Expanded Uncertainty (k=2)					± 26.6	

Measurement Uncertainty Table in accordance with IEEE Std 1528-200X (Draft - see Reference [5])

MEASUREMENT UNCERTAINTIES (Cont.)

UNCERTAINTY BUDGET FOR SYSTEM VALIDATION						
Error Description	Uncertainty Value ±%	Probability Distribution	Divisor	C_i 1g	Standard Uncertainty ±% (1g)	v_i or v_{eff}
Measurement System						
Probe calibration	± 4.8	Normal	1	1	± 4.8	∞
Axial isotropy of the probe	± 4.7	Rectangular	√3	(1- c_p)	± 1.9	∞
Spherical isotropy of the probe	± 9.6	Rectangular	√3	(c_p)	± 3.9	∞
Spatial resolution	± 0.0	Rectangular	√3	1	± 0.0	∞
Boundary effects	± 5.5	Rectangular	√3	1	± 3.2	∞
Probe linearity	± 4.7	Rectangular	√3	1	± 2.7	∞
Detection limit	± 1.0	Rectangular	√3	1	± 0.6	∞
Readout electronics	± 1.0	Normal	1	1	± 1.0	∞
Response time	± 0.8	Rectangular	√3	1	± 0.5	∞
Integration time	± 1.4	Rectangular	√3	1	± 0.8	∞
RF ambient conditions	± 3.0	Rectangular	√3	1	± 1.7	∞
Mech. constraints of robot	± 0.4	Rectangular	√3	1	± 0.2	∞
Probe positioning	± 2.9	Rectangular	√3	1	± 1.7	∞
Extrapolation & integration	± 3.9	Rectangular	√3	1	± 2.3	∞
Dipole						
Dipole Axis to Liquid Distance	± 2.0	Rectangular	√3	1	± 1.2	∞
Input Power	± 4.7	Rectangular	√3	1	± 2.7	∞
Phantom and Setup						
Phantom uncertainty	± 4.0	Rectangular	√3	1	± 2.3	∞
Liquid conductivity (target)	± 5.0	Rectangular	√3	0.6	± 1.7	∞
Liquid conductivity (measured)	± 5.0	Rectangular	√3	0.6	± 1.7	∞
Liquid permittivity (target)	± 5.0	Rectangular	√3	0.6	± 1.7	∞
Liquid permittivity (measured)	± 5.0	Rectangular	√3	0.6	± 1.7	∞
Combined Standard Uncertainty					± 9.9	
Expanded Uncertainty (k=2)					± 19.8	

Measurement Uncertainty Table in accordance with IEEE Std 1528-200X (Draft - see Reference [5])

16.0 REFERENCES

- [1] Federal Communications Commission, "Radiofrequency radiation exposure evaluation: portable devices", Rule Part 47 CFR §2.1093: 1999.
- [2] Health Canada, "Limits of Human Exposure to Radiofrequency Electromagnetic Fields in the Frequency Range from 3 kHz to 300 GHz", Safety Code 6.
- [3] Federal Communications Commission, "Evaluating Compliance with FCC Guidelines for Human Exposure to Radio frequency Electromagnetic Fields", OET Bulletin 65, Supplement C (Edition 01-01), FCC, Washington, D.C.: June 2001.
- [4] Industry Canada, "Evaluation Procedure for Mobile and Portable Radio Transmitters with respect to Health Canada's Safety Code 6 for Exposure of Humans to Radio Frequency Fields", Radio Standards Specification RSS-102 Issue 1 (Provisional): September 1999.
- [5] IEEE Standards Coordinating Committee 34, Std 1528-200X, "DRAFT Recommended Practice for Determining the Spatial-Peak Specific Absorption Rate (SAR) in the Human Body Due to Wireless Communications Devices: Experimental Techniques".
- [6] W. Gander, *Computermathematick*, Birkhaeuser, Basel: 1992.

APPENDIX B - SYSTEM PERFORMANCE CHECK DATA

08/29/03

System Performance Check - 2450 MHz Dipole

SAM Phantom; Flat Section

Probe: ET3DV6 - SN1387; ConvF(5.00,5.00,5.00); Crest factor: 1.0; Brain 2450 MHz: $\sigma = 1.85$ mho/m $\epsilon_r = 37.4$ $\rho = 1.00$ g/cm³

Cube 5x5x7: Peak: 27.2 mW/g, SAR (1g): 14.0 mW/g, SAR (10g): 6.55 mW/g, (Worst-case extrapolation)

Penetration depth: 7.2 (7.1, 7.4) [mm]; Powerdrift: 0.00 dB

Ambient Temp. 25.5°C; Fluid Temp. 23.8°C

Conducted Power: 250mW

Date Tested: August 29, 2003

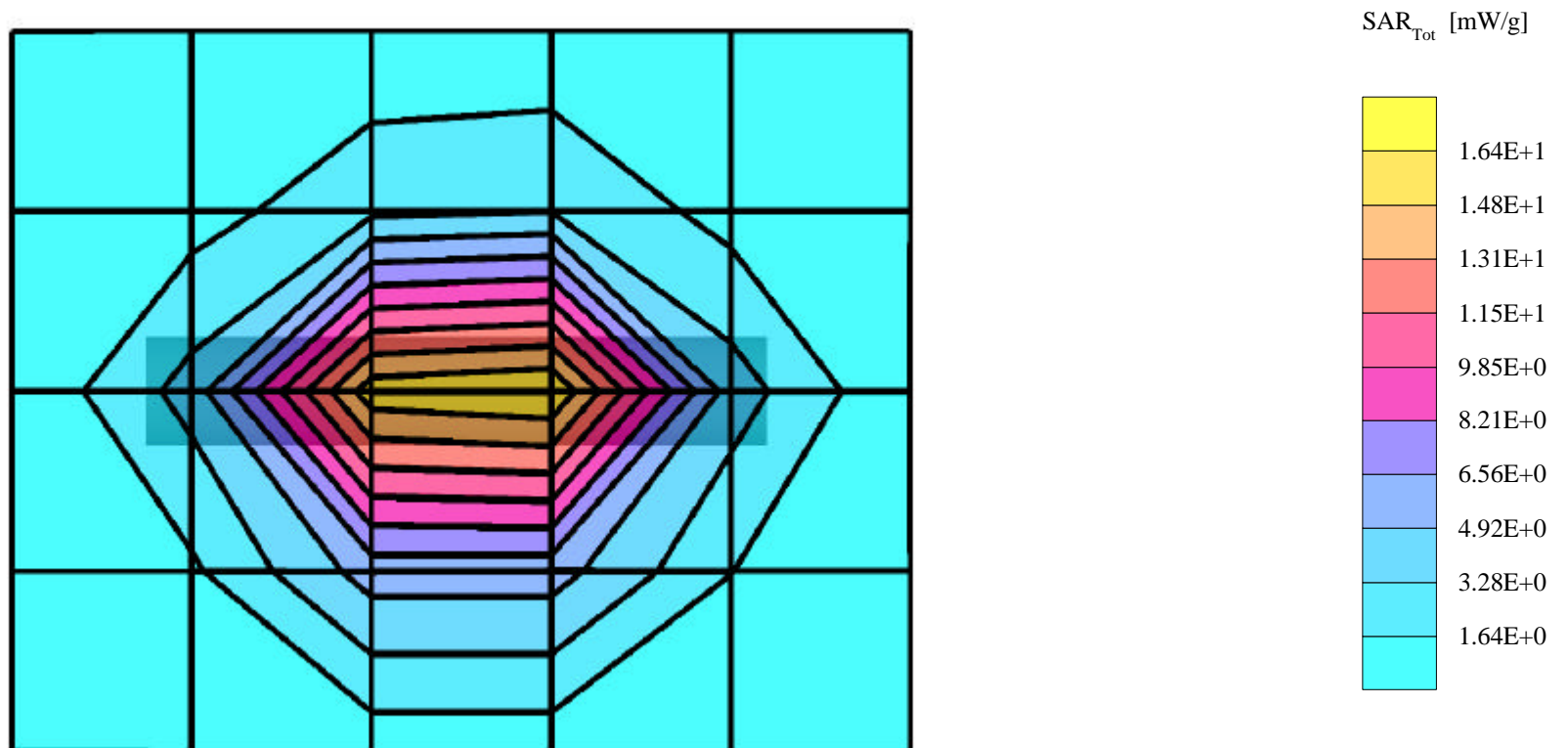

System Performance Check - 2450 MHz Dipole

SAM Phantom

Probe: ET3DV6 - SN1387; ConvF(5.00,5.00,5.00); Crest factor: 1.0

Brain 2450 MHz: $\sigma = 1.85$ mho/m $\epsilon_r = 37.4$ $\rho = 1.00$ g/cm³

Ambient Temp. 25.5°C; Fluid Temp. 23.8°C

Z-Axis Extrapolation at Peak SAR Location

Conducted Power: 250mW

Date Tested: August 29, 2003

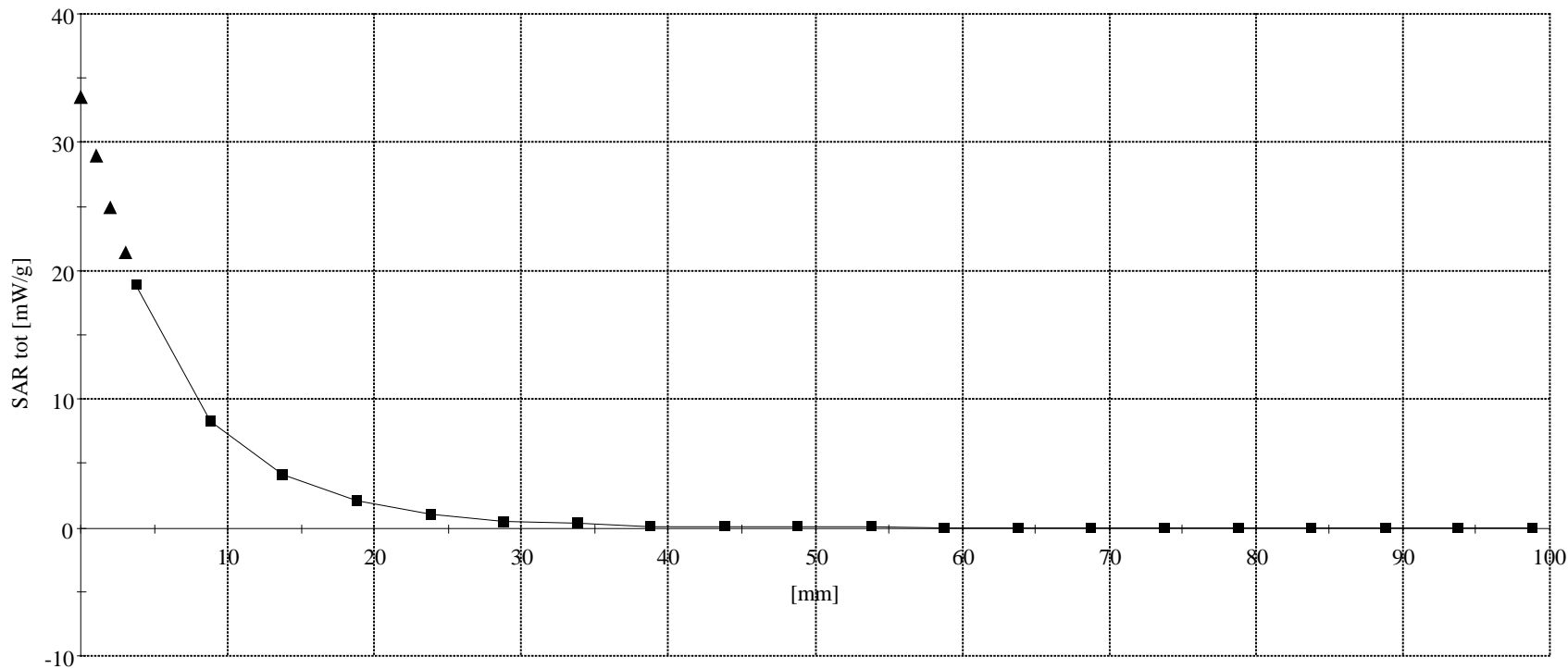

APPENDIX C - SYSTEM VALIDATION

2450MHz SYSTEM VALIDATION DIPOLE

Type:

2450MHz Validation Dipole

Serial Number:

150

Place of Calibration:

Celltech Research Inc.

Date of Calibration:

October 24, 2002

Celltech Research Inc. hereby certifies that this device has been calibrated on the date indicated above.

Calibrated by:

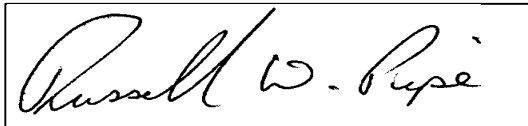

Approved by:

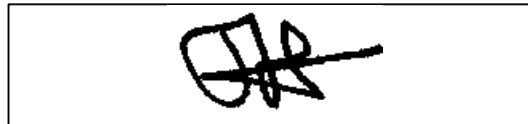

1. Dipole Construction & Electrical Characteristics

The validation dipole was constructed in accordance with the IEEE Std “Recommended Practice for Determining the Spatial-Peak Specific Absorption Rate (SAR) in the Human Body Due to Wireless Communications Devices: Experimental Techniques”. The electrical properties were measured using an HP 8753E Network Analyzer. The network analyzer was calibrated to the validation dipole N-type connector feed point using an HP85032E Type N calibration kit. The dipole was placed parallel to a planar phantom at a separation distance of 10.0mm from the simulating fluid using a loss-less dielectric spacer. The measured input impedance is:

Feed point impedance at 2450MHz

$$\text{Re}\{Z\} = 49.838\Omega$$

$$\text{Im}\{Z\} = 0.2207\Omega$$

Return Loss at 2450MHz

$$-49.398 \text{ dB}$$

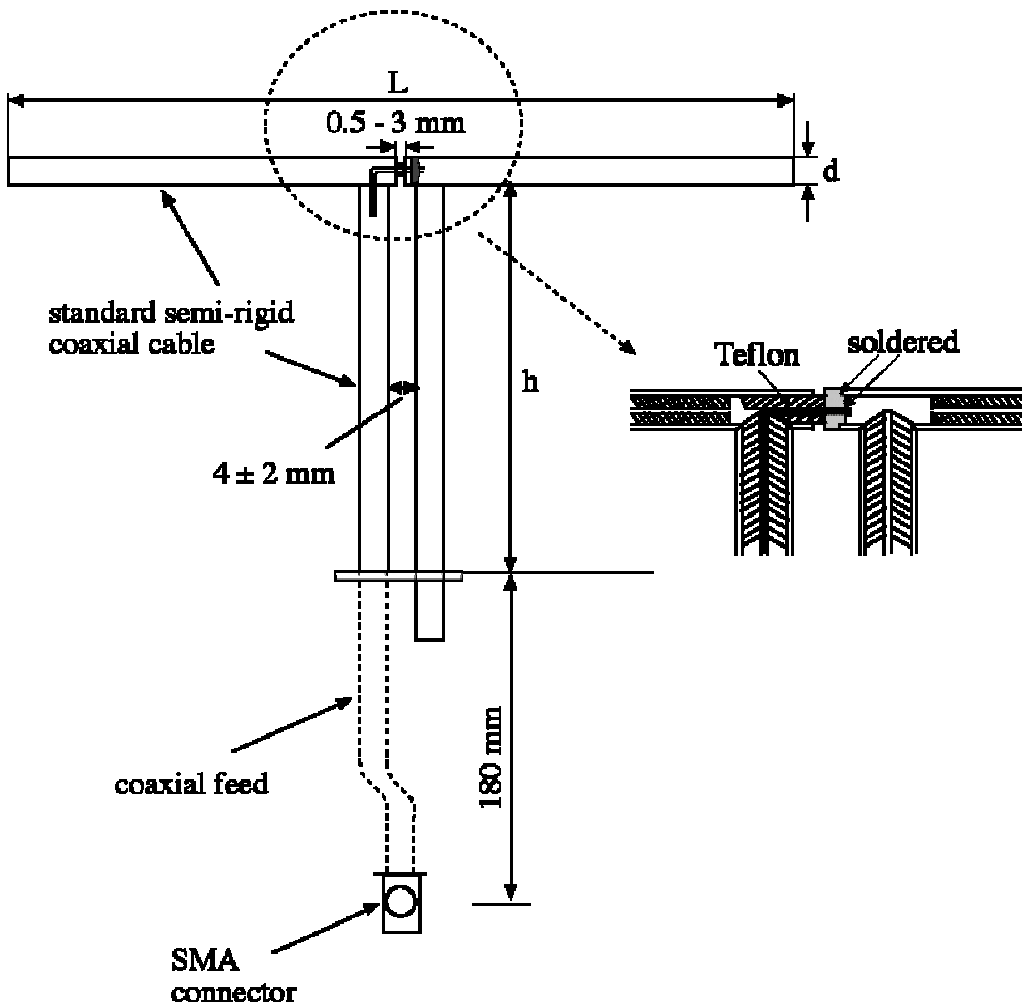

Validation Dipole Dimensions

Frequency (MHz)	L (mm)	h (mm)	d (mm)
300	420.0	250.0	6.2
450	288.0	167.0	6.2
835	161.0	89.8	3.6
900	149.0	83.3	3.6
1450	89.1	51.7	3.6
1800	72.0	41.7	3.6
1900	68.0	39.5	3.6
2000	64.5	37.5	3.6
2450	51.8	30.6	3.6
3000	41.5	25.0	3.6

2. Validation Phantom

The validation phantom is the SAM (Specific Anthropomorphic Mannequin) phantom manufactured by Schmid & Partner Engineering AG. The SAM phantom is a Fiberglass shell integrated in a wooden table. The shape of the shell corresponds to the phantom defined by SCC34-SC2. It enables the dosimetric evaluation of left and right hand phone usage as well as body mounted usage at the flat phantom region. A cover prevents evaporation of the liquid. Reference markings on the phantom allow the complete setup of all predefined phantom positions and measurement grids by manually teaching three points in the robot.

Shell Thickness: 2.0 ± 0.1 mm
Filling Volume: Approx. 20 liters
Dimensions: 50 cm (W) x 100 cm (L)

SAM Twin-Phantom

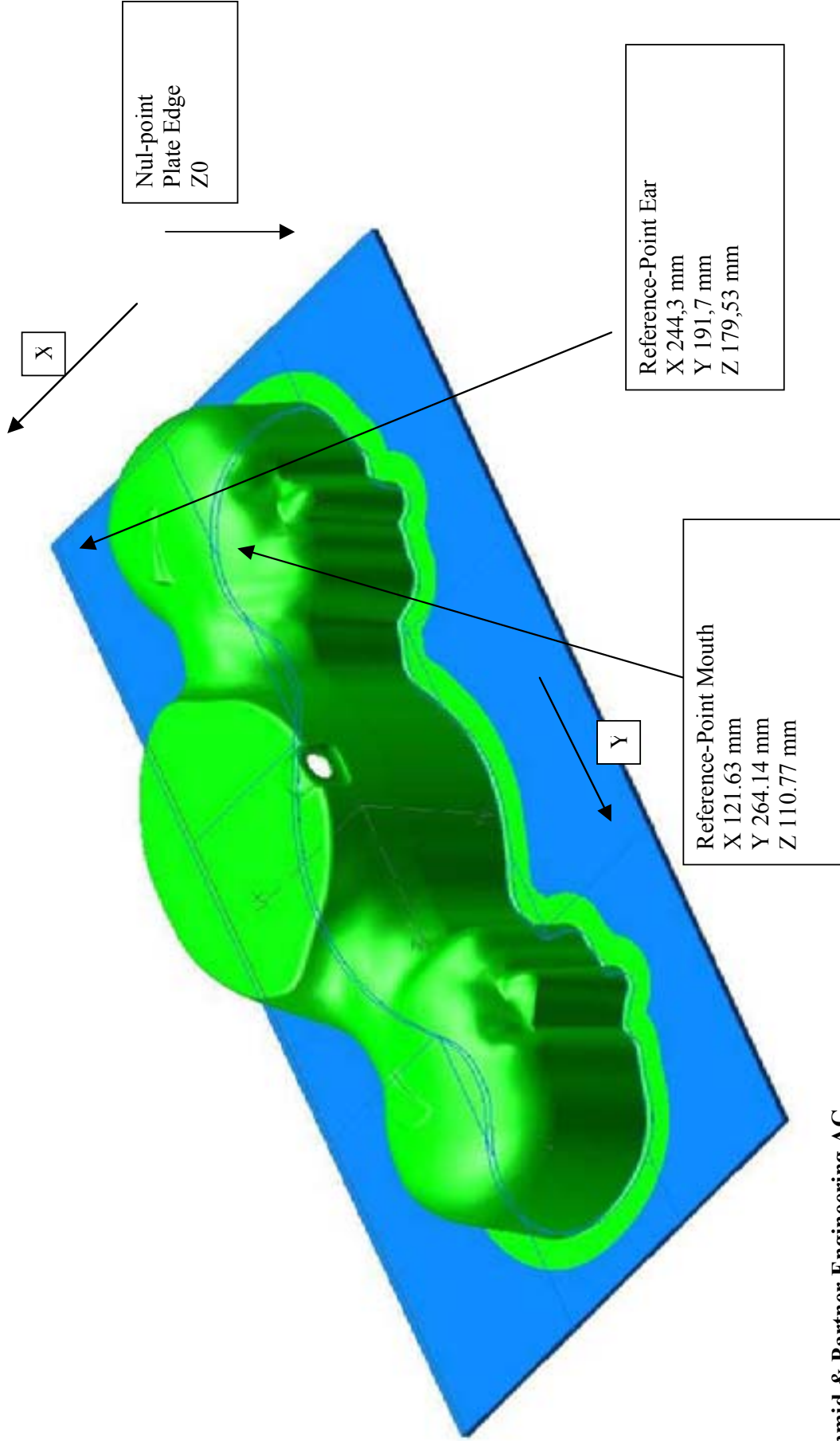

2450MHz Dipole Calibration



2450MHz Dipole Calibration



3. Measurement Conditions

The planar phantom was filled with brain simulating tissue having the following electrical parameters at 2450MHz:

Relative Permittivity:	36.8
Conductivity:	1.79 mho/m
Ambient Temperature:	23.6°C
Fluid Temperature:	23.8°C
Fluid Depth:	≥ 15cm

The 2450MHz simulating tissue consists of the following ingredients:

Ingredient	Percentage by weight
Water	55.20%
Glycol Monobutyl	44.80%
Target Dielectric Parameters at 22°C	$\epsilon_r = 39.2$ (+/-10%) $\sigma = 1.80$ S/m (+/-5%)

4. SAR Measurement

The SAR measurement was performed with the E-field probe in mechanical detection mode only. The setup and determination of the forward power into the dipole was performed using the following procedures.

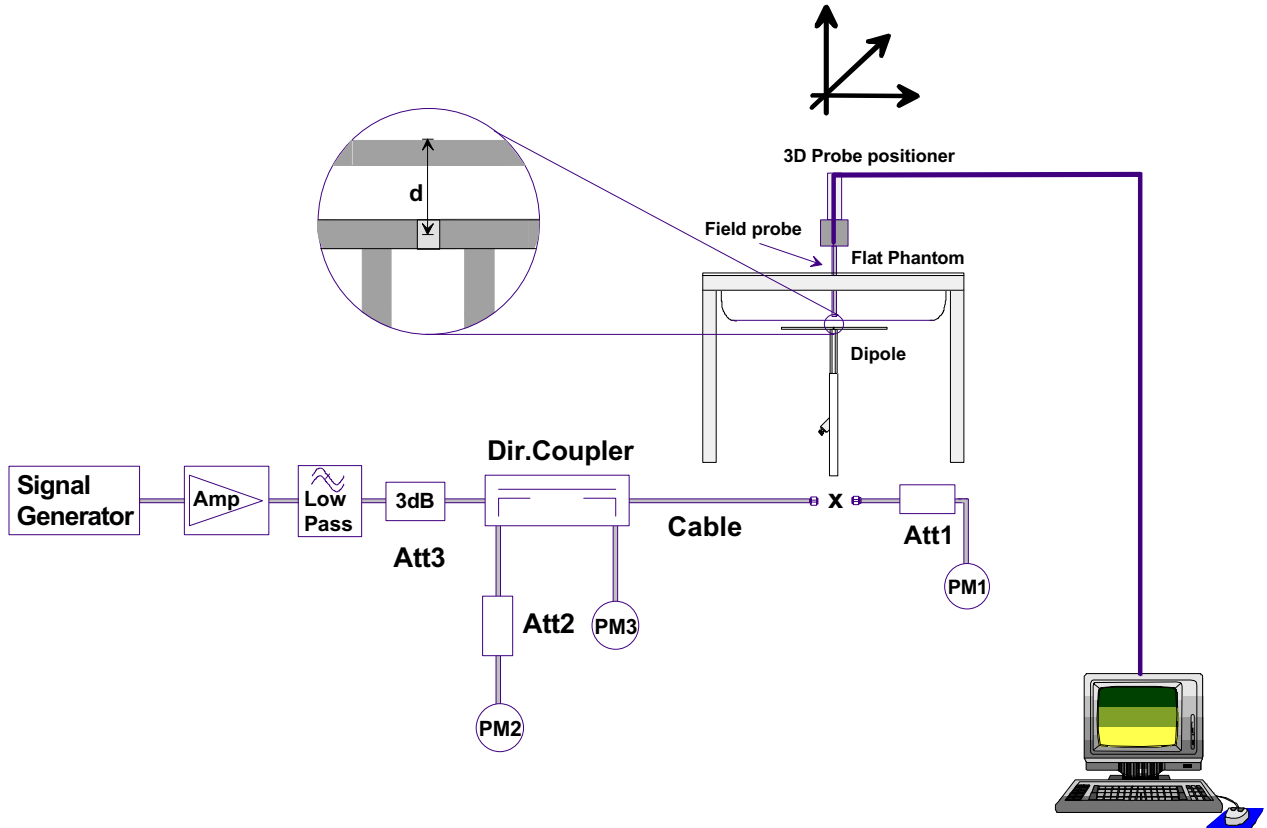

First, the power meter **PM1** (including attenuator **Att1**) is connected to the cable to measure the forward power at the location of the dipole connector (**X**). The signal generator is adjusted for the desired forward power at the dipole connector (taking into account the attenuation of **Att1**) as read by power meter **PM2**. After connecting the cable to the dipole, the signal generator is readjusted for the same reading at power meter **PM2**. If the signal generator does not allow adjustment in 0.01dB steps, the remaining difference at **PM2** must be taken into consideration. **PM3** records the reflected power from the dipole to ensure that the value is not changed from the previous value. The reflected power should be 20dB below the forward power.

Ten SAR measurements were performed in order to achieve repeatability and to establish an average target value.

Validation Dipole SAR Test Results

Validation Measurement	SAR @ 0.25W Input averaged over 1g	SAR @ 1W Input averaged over 1g	SAR @ 0.25W Input averaged over 10g	SAR @ 1W Input averaged over 10g	Peak SAR @ 0.25W Input
Test 1	14.4	57.6	6.55	26.20	30.5
Test 2	14.2	56.8	6.44	25.76	30.0
Test 3	14.0	56.0	6.35	25.40	29.7
Test 4	13.9	55.6	6.32	25.28	29.5
Test 5	14.0	56.0	6.33	25.32	29.7
Test 6	14.0	56.0	6.33	25.32	29.7
Test 7	13.9	55.6	6.31	25.24	29.5
Test 8	13.8	55.2	6.28	25.12	29.3
Test 9	13.8	55.2	6.28	25.12	29.4
Test10	14.0	56.0	6.33	25.32	29.7
Average Value	14.0	56.0	6.35	25.41	29.7

The results have been normalized to 1W (forward power) into the dipole.

Averaged over 1cm (1g) of tissue: 56.00 mW/g

Averaged over 10cm (10g) of tissue: 25.41 mW/g

24 Oct 2002 09:28:50

CH1 S11 1 U FS 1: 49.838 Ω 0.2207 Ω 14.337 pH 2 450.000 000 MHz

PRm

MARKER 1
2.45 GHz

Cor

↑

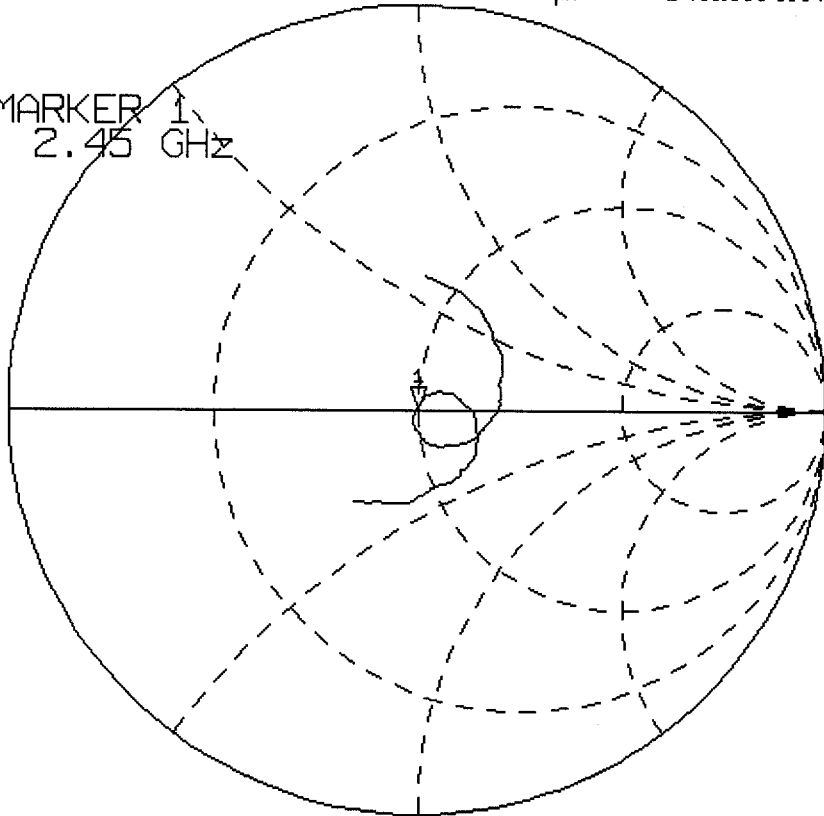

START 2 250.000 000 MHz

STOP 2 650.000 000 MHz

24 Oct 2002 09:28:12

CH1 S11 LOG 10 dB/REF 0 dB 11-49.398 dB 2 450.000 000 MHz

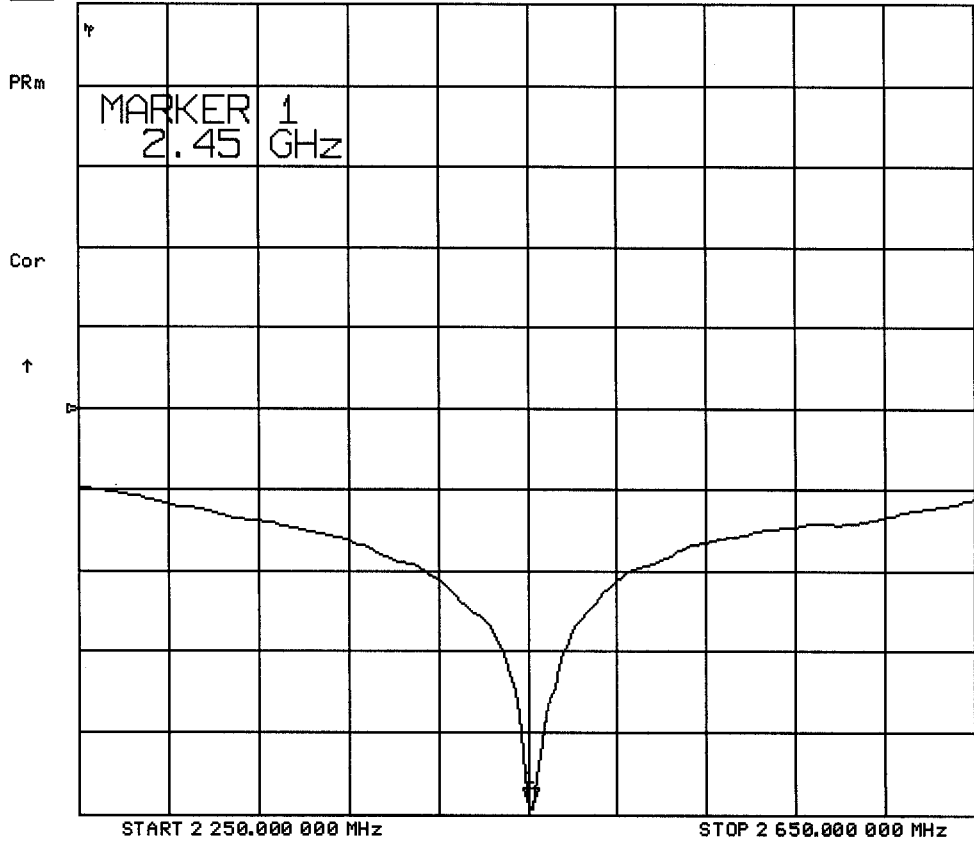

Dipole 2450MHz

SAM Phantom; Flat Section

Probe: ET3DV6 - SNI387; ConvF(4.70,4.70,4.70); Crest factor: 1.0; 2450 MHz Brain: $\sigma = 1.79 \text{ mho/m}$ $\epsilon_r = 36.8$ $\rho = 1.00 \text{ g/cm}^3$

Cubes (4): Peak: 29.7 mW/g $\pm 0.04 \text{ dB}$, SAR (1g): 14.0 mW/g $\pm 0.04 \text{ dB}$, SAR (10g): 6.35 mW/g $\pm 0.04 \text{ dB}$, (Worst-case extrapolation)

Penetration depth: 6.4 (6.1, 7.2) [mm]; Powerdrift: -0.04 dB

Ambient Temp.: 23.6°C; Fluid Temp.: 23.8°C

Forward Conducted Power: 250 mW

Calibration Date: October 24, 2002

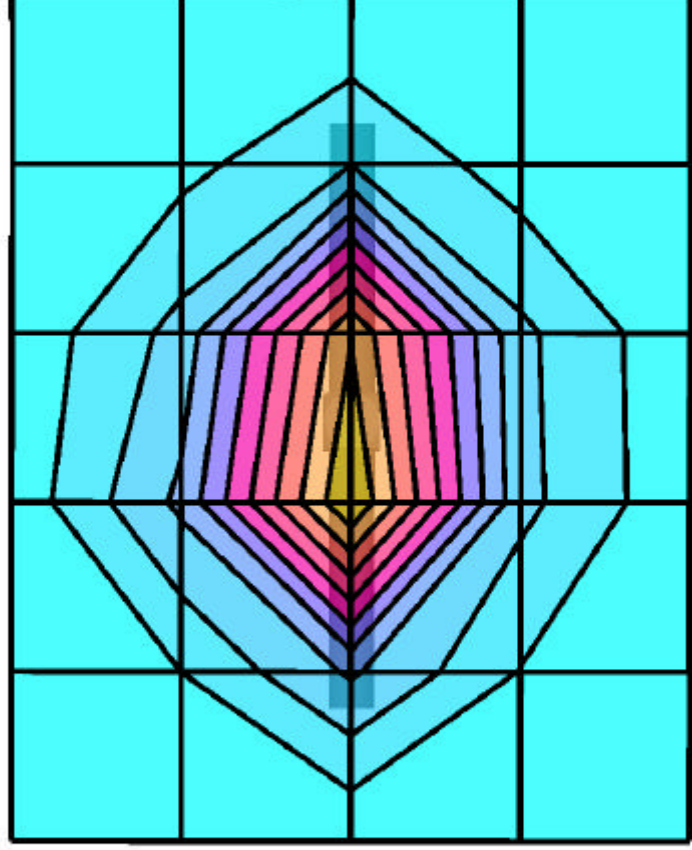

SAR_{tot} [mW/g]

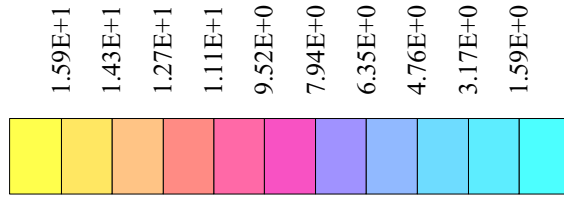

2450MHz System Validation

Measured Fluid Dielectric Parameters (Brain)

October 24, 2002

Frequency		ϵ'	ϵ''
2.350000000	GHz	37.2108	12.9039
2.360000000	GHz	37.1695	12.9350
2.370000000	GHz	37.1398	12.9630
2.380000000	GHz	37.1057	12.9945
2.390000000	GHz	37.0746	13.0290
2.400000000	GHz	37.0424	13.0464
2.410000000	GHz	36.9746	13.0743
2.420000000	GHz	36.9322	13.1074
2.430000000	GHz	36.8908	13.1372
2.440000000	GHz	36.8449	13.1527
2.450000000	GHz	36.7983	13.1767
2.460000000	GHz	36.7651	13.2038
2.470000000	GHz	36.7300	13.2377
2.480000000	GHz	36.7004	13.2677
2.490000000	GHz	36.6658	13.2862
2.500000000	GHz	36.6120	13.2988
2.510000000	GHz	36.5655	13.3268
2.520000000	GHz	36.5147	13.3582
2.530000000	GHz	36.4743	13.3922
2.540000000	GHz	36.4044	13.4131
2.550000000	GHz	36.3807	13.4402

APPENDIX D - PROBE CALIBRATION

Client **Celltech Labs**

CALIBRATION CERTIFICATE

Object(s) **ET3DV6 - SN:1387**

Calibration procedure(s) **QA CAL-01.v2
Calibration procedure for dosimetric E-field probes**

Calibration date: **February 26, 2003**

Condition of the calibrated item **In Tolerance (according to the specific calibration document)**

This calibration statement documents traceability of M&TE used in the calibration procedures and conformity of the procedures with the ISO/IEC 17025 international standard.

All calibrations have been conducted in the closed laboratory facility: environment temperature 22 +/- 2 degrees Celsius and humidity < 75%.

Calibration Equipment used (M&TE critical for calibration)

Model Type	ID #	Cal Date	Scheduled Calibration
RF generator HP 8684C	US3642U01700	4-Aug-99 (in house check Aug-02)	In house check: Aug-05
Power sensor E4412A	MY41495277	8-Mar-02	Mar-03
Power sensor HP 8481A	MY41092180	18-Sep-02	Sep-03
Power meter EPM E4419B	GB41293874	13-Sep-02	Sep-03
Network Analyzer HP 8753E	US38432426	3-May-00	In house check: May 03
Fluke Process Calibrator Type 702	SN: 6295803	3-Sep-01	Sep-03

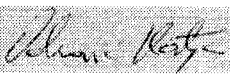
	Name	Function	Signature
Calibrated by:	Nico Vetterli	Technician	
Approved by:	Katja Pokovic	Laboratory Director	

Date issued: February 26, 2003

This calibration certificate is issued as an intermediate solution until the accreditation process (based on ISO/IEC 17025 International Standard) for Calibration Laboratory of Schmid & Partner Engineering AG is completed.

Probe ET3DV6

SN:1387

Manufactured:	September 21, 1999
Last calibration:	February 22, 2002
Recalibrated:	February 26, 2003

Calibrated for DASY Systems

(Note: non-compatible with DASY2 system!)

DASY - Parameters of Probe: ET3DV6 SN:1387

Sensitivity in Free Space

NormX	1.55 $\mu\text{V}/(\text{V}/\text{m})^2$
NormY	1.65 $\mu\text{V}/(\text{V}/\text{m})^2$
NormZ	1.64 $\mu\text{V}/(\text{V}/\text{m})^2$

Diode Compression

DCP X	92	mV
DCP Y	92	mV
DCP Z	92	mV

Sensitivity in Tissue Simulating Liquid

Head	900 MHz	$\epsilon_r = 41.5 \pm 5\%$	$\sigma = 0.97 \pm 5\%$ mho/m
Head	835 MHz	$\epsilon_r = 41.5 \pm 5\%$	$\sigma = 0.90 \pm 5\%$ mho/m
ConvF X	6.6 $\pm 9.5\%$ (k=2)		Boundary effect:
ConvF Y	6.6 $\pm 9.5\%$ (k=2)		Alpha 0.37
ConvF Z	6.6 $\pm 9.5\%$ (k=2)		Depth 2.61
Head	1800 MHz	$\epsilon_r = 40.0 \pm 5\%$	$\sigma = 1.40 \pm 5\%$ mho/m
Head	1900 MHz	$\epsilon_r = 40.0 \pm 5\%$	$\sigma = 1.40 \pm 5\%$ mho/m
ConvF X	5.2 $\pm 9.5\%$ (k=2)		Boundary effect:
ConvF Y	5.2 $\pm 9.5\%$ (k=2)		Alpha 0.50
ConvF Z	5.2 $\pm 9.5\%$ (k=2)		Depth 2.73

Boundary Effect

Head	900 MHz	Typical SAR gradient: 5 % per mm	
	Probe Tip to Boundary	1 mm	2 mm
	SAR _{be} [%] Without Correction Algorithm	10.2	5.9
	SAR _{be} [%] With Correction Algorithm	0.4	0.6
Head	1800 MHz	Typical SAR gradient: 10 % per mm	
	Probe Tip to Boundary	1 mm	2 mm
	SAR _{be} [%] Without Correction Algorithm	14.6	9.8
	SAR _{be} [%] With Correction Algorithm	0.2	0.0

Sensor Offset

Probe Tip to Sensor Center	2.7	mm
Optical Surface Detection	1.4 \pm 0.2	mm

Receiving Pattern (ϕ), $\theta = 0^\circ$

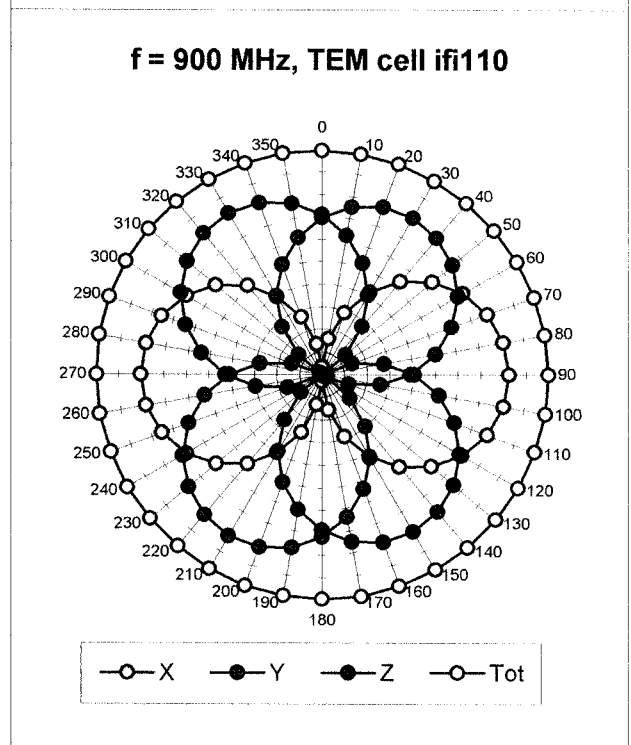
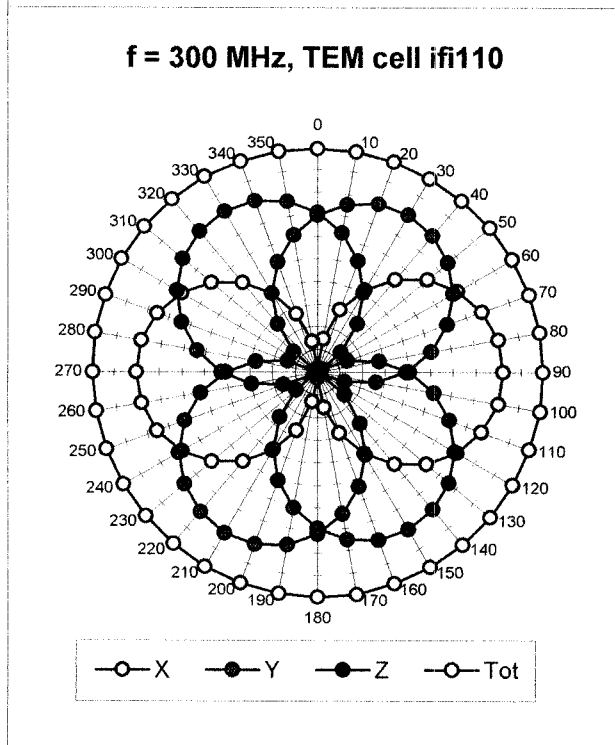
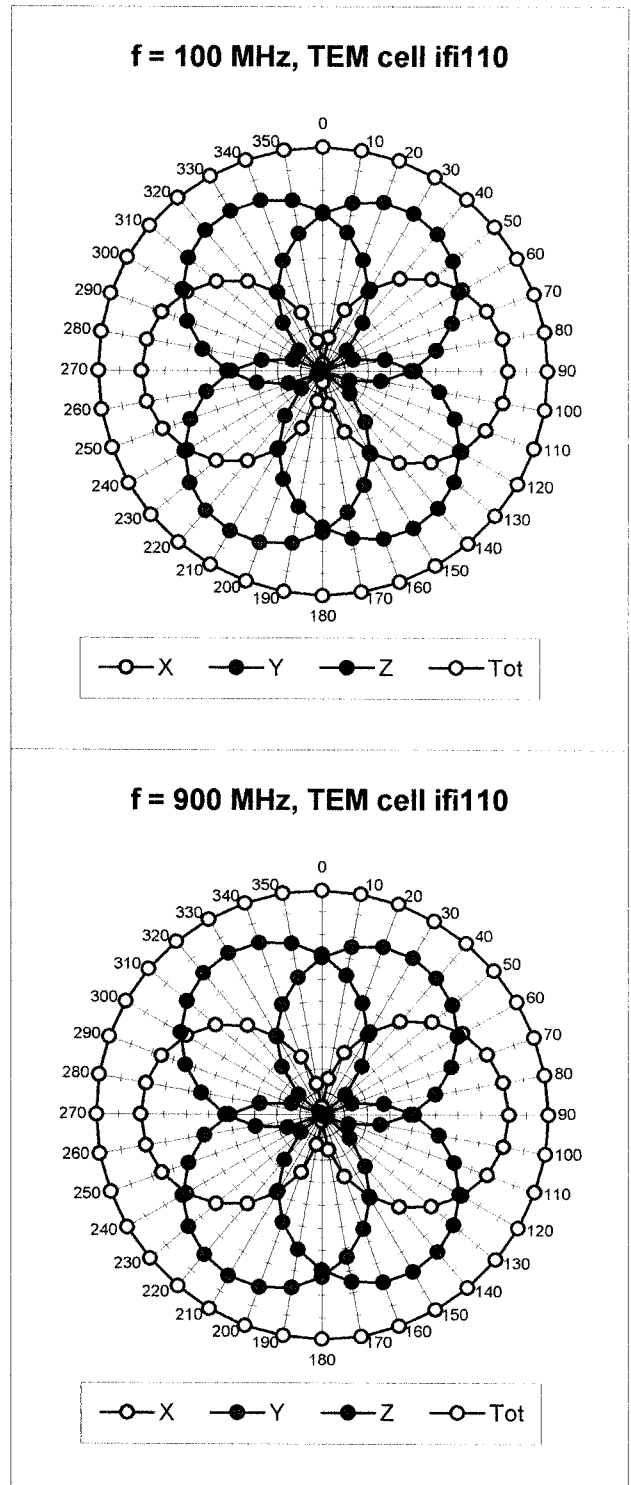
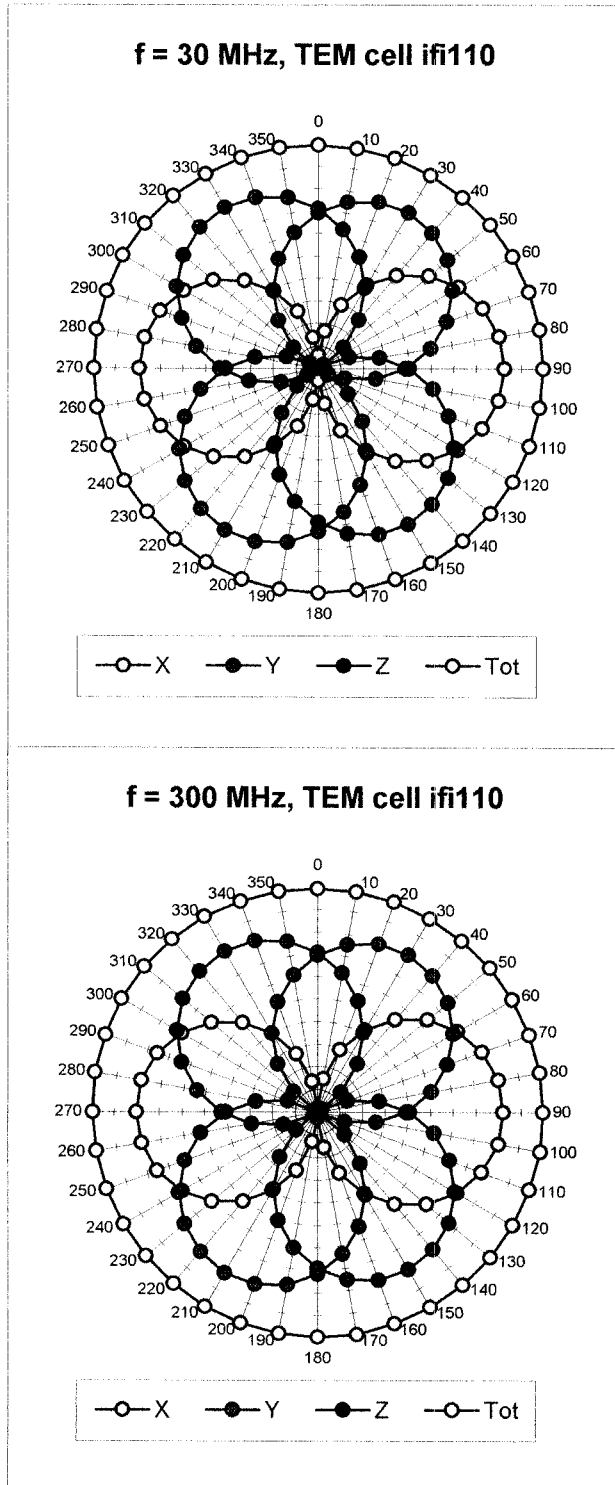

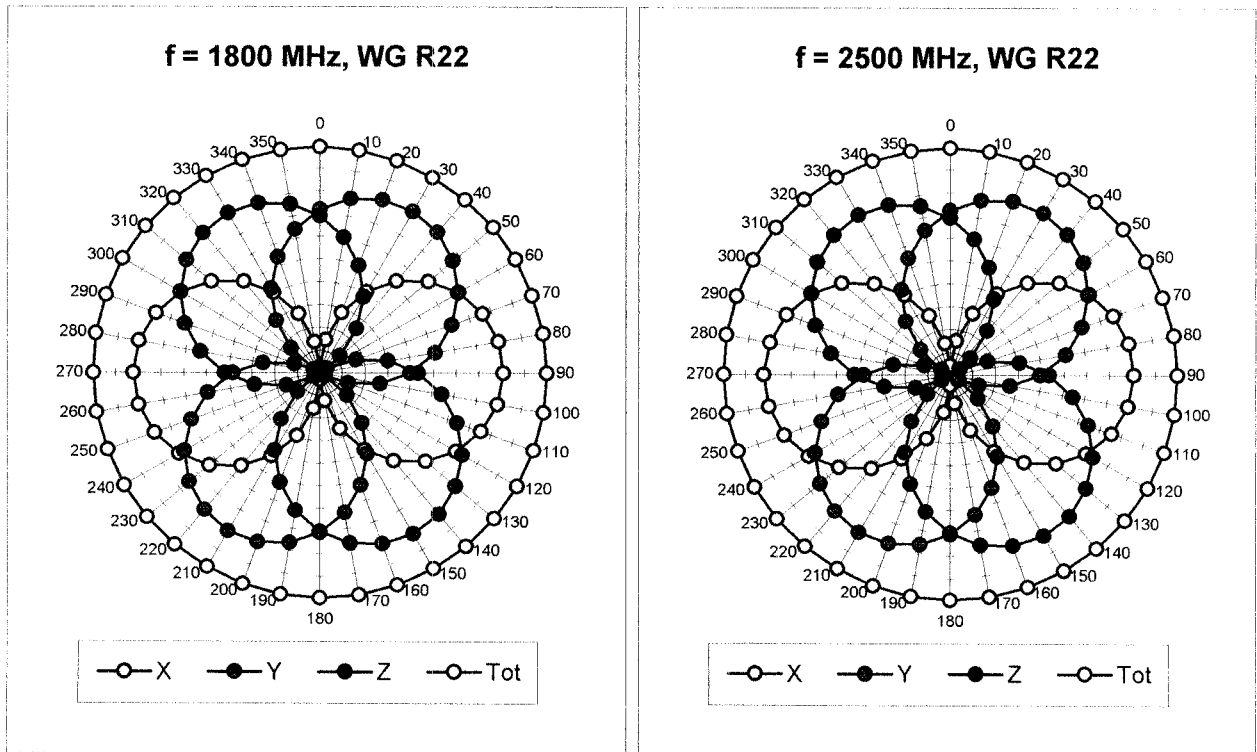

Isotropy Error (ϕ), $\theta = 0^\circ$

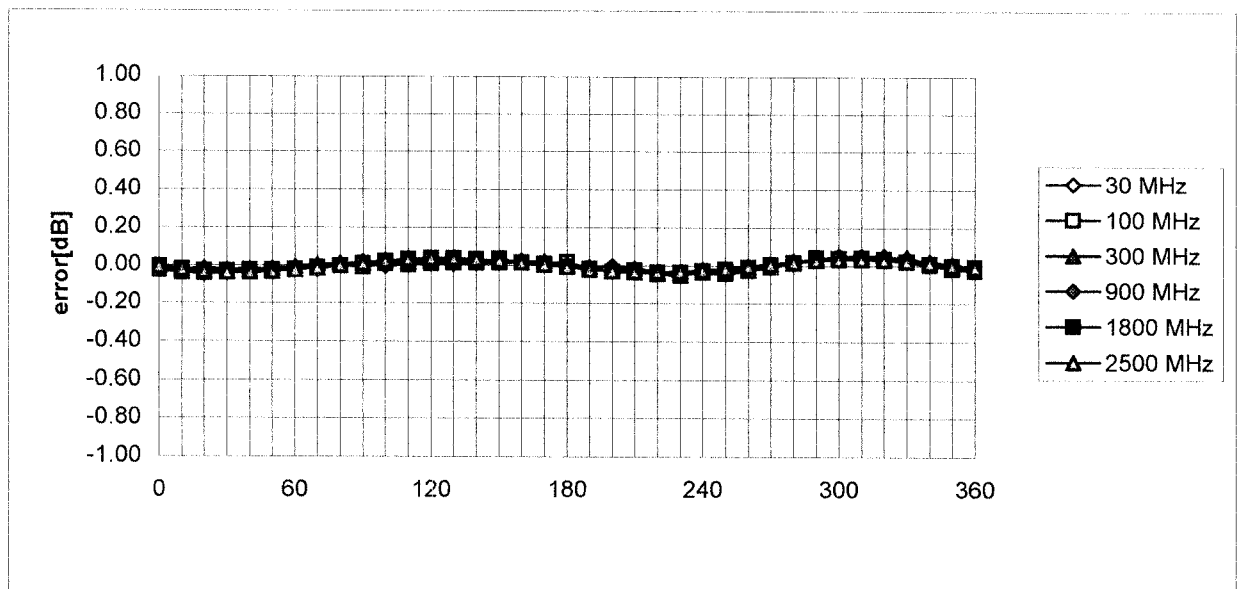

Frequency Response of E-Field

(TEM-Cell:ifi110, Waveguide R22)

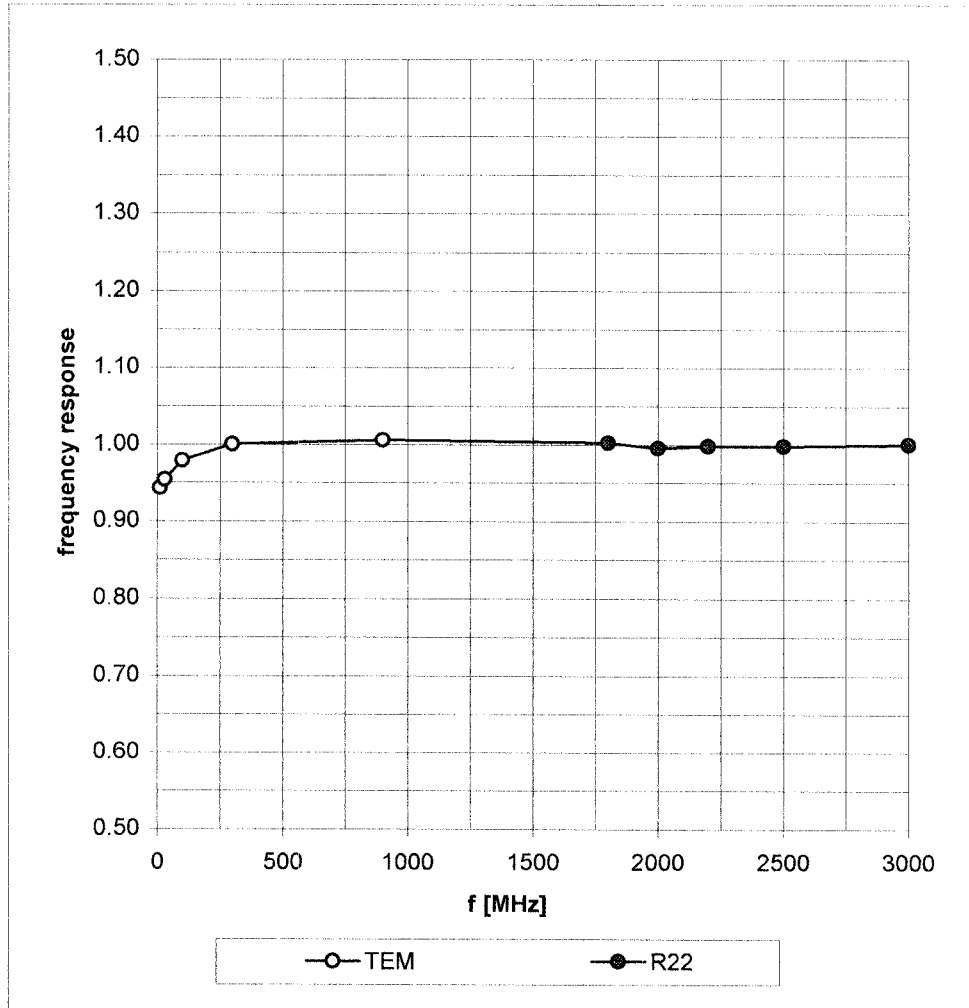

Dynamic Range f(SAR_{brain}) (Waveguide R22)

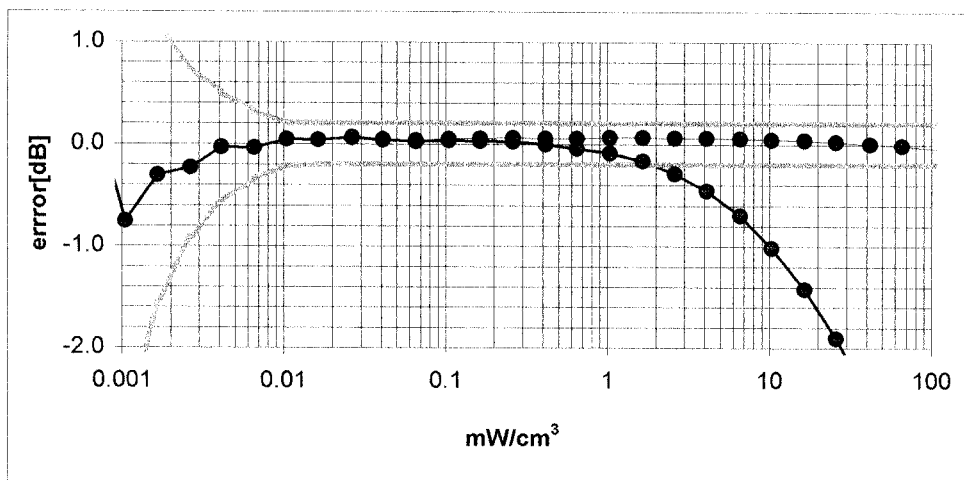
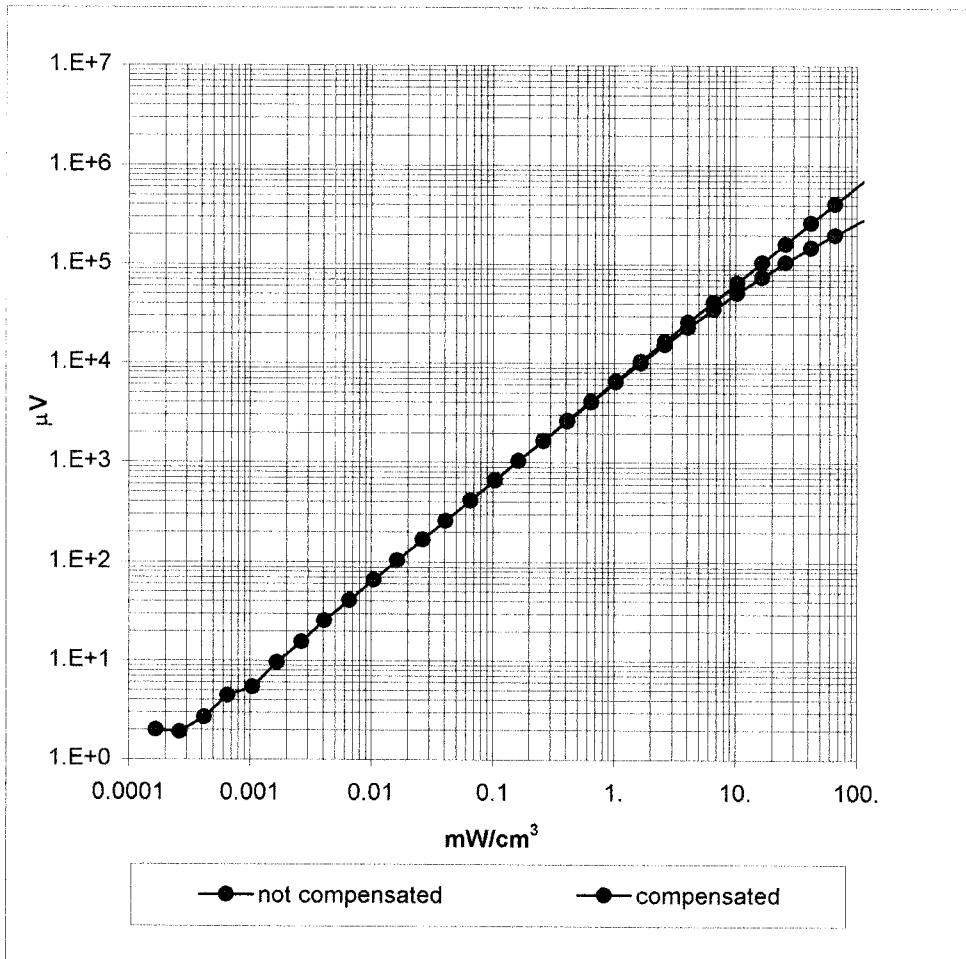

Conversion Factor Assessment

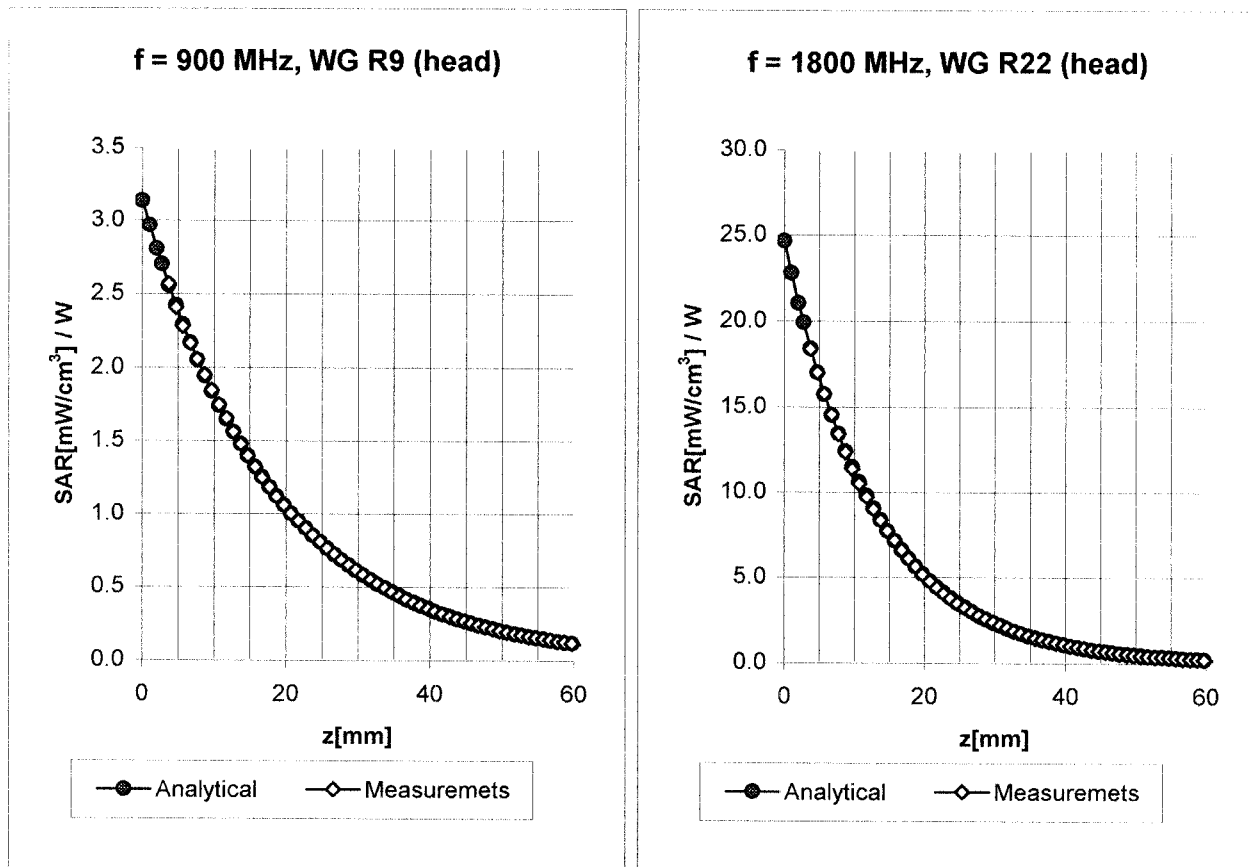

Head	900 MHz	$\epsilon_r = 41.5 \pm 5\%$	$\sigma = 0.97 \pm 5\% \text{ mho/m}$
Head	835 MHz	$\epsilon_r = 41.5 \pm 5\%$	$\sigma = 0.90 \pm 5\% \text{ mho/m}$
	ConvF X	6.6 $\pm 9.5\%$ (k=2)	Boundary effect:
	ConvF Y	6.6 $\pm 9.5\%$ (k=2)	Alpha 0.37
	ConvF Z	6.6 $\pm 9.5\%$ (k=2)	Depth 2.61
Head	1800 MHz	$\epsilon_r = 40.0 \pm 5\%$	$\sigma = 1.40 \pm 5\% \text{ mho/m}$
Head	1900 MHz	$\epsilon_r = 40.0 \pm 5\%$	$\sigma = 1.40 \pm 5\% \text{ mho/m}$
	ConvF X	5.2 $\pm 9.5\%$ (k=2)	Boundary effect:
	ConvF Y	5.2 $\pm 9.5\%$ (k=2)	Alpha 0.50
	ConvF Z	5.2 $\pm 9.5\%$ (k=2)	Depth 2.73

Conversion Factor Assessment

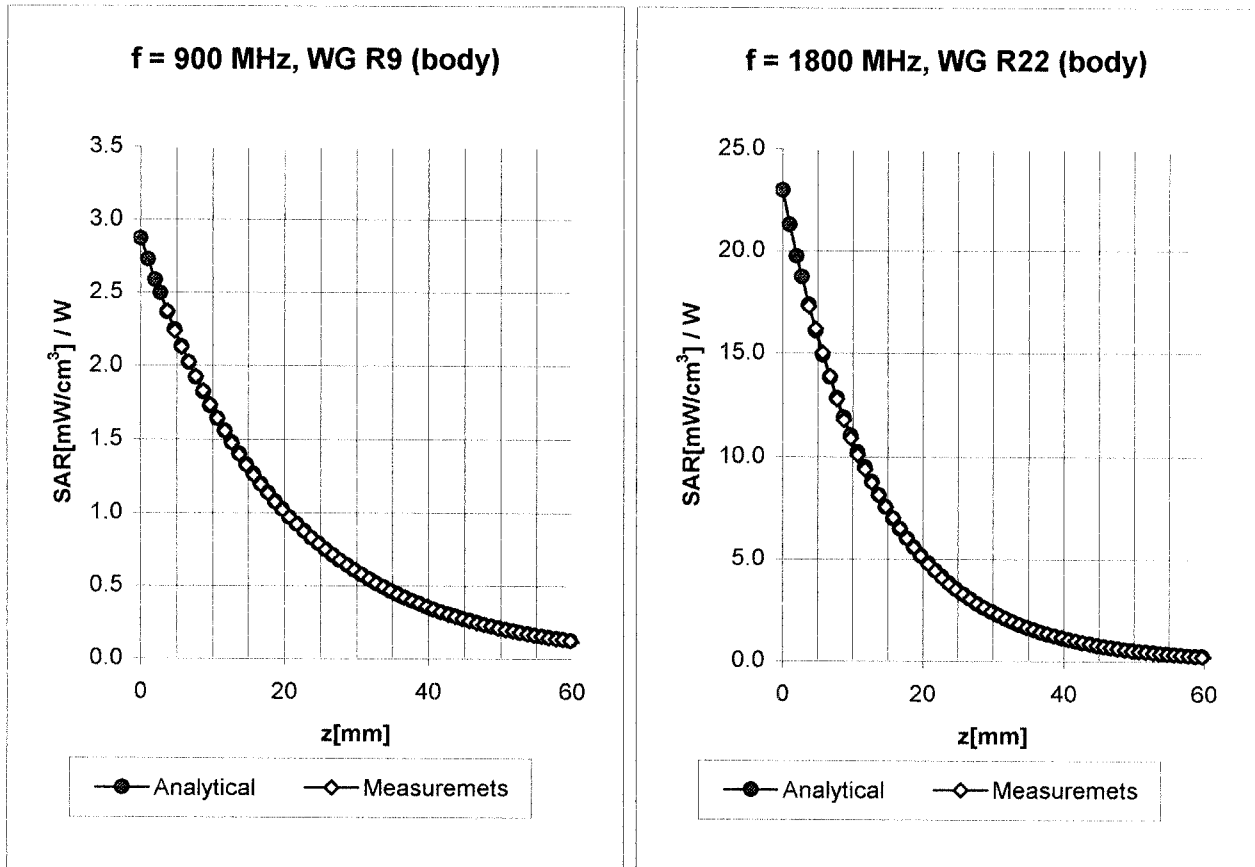

Body	900 MHz	$\epsilon_r = 55.0 \pm 5\%$	$\sigma = 1.05 \pm 5\% \text{ mho/m}$
Body	835 MHz	$\epsilon_r = 55.2 \pm 5\%$	$\sigma = 0.97 \pm 5\% \text{ mho/m}$
	ConvF X	6.4 $\pm 9.5\%$ (k=2)	Boundary effect:
	ConvF Y	6.4 $\pm 9.5\%$ (k=2)	Alpha 0.45
	ConvF Z	6.4 $\pm 9.5\%$ (k=2)	Depth 2.35
Body	1800 MHz	$\epsilon_r = 53.3 \pm 5\%$	$\sigma = 1.52 \pm 5\% \text{ mho/m}$
Body	1900 MHz	$\epsilon_r = 53.3 \pm 5\%$	$\sigma = 1.52 \pm 5\% \text{ mho/m}$
	ConvF X	4.9 $\pm 9.5\%$ (k=2)	Boundary effect:
	ConvF Y	4.9 $\pm 9.5\%$ (k=2)	Alpha 0.60
	ConvF Z	4.9 $\pm 9.5\%$ (k=2)	Depth 2.59

Conversion Factor Assessment

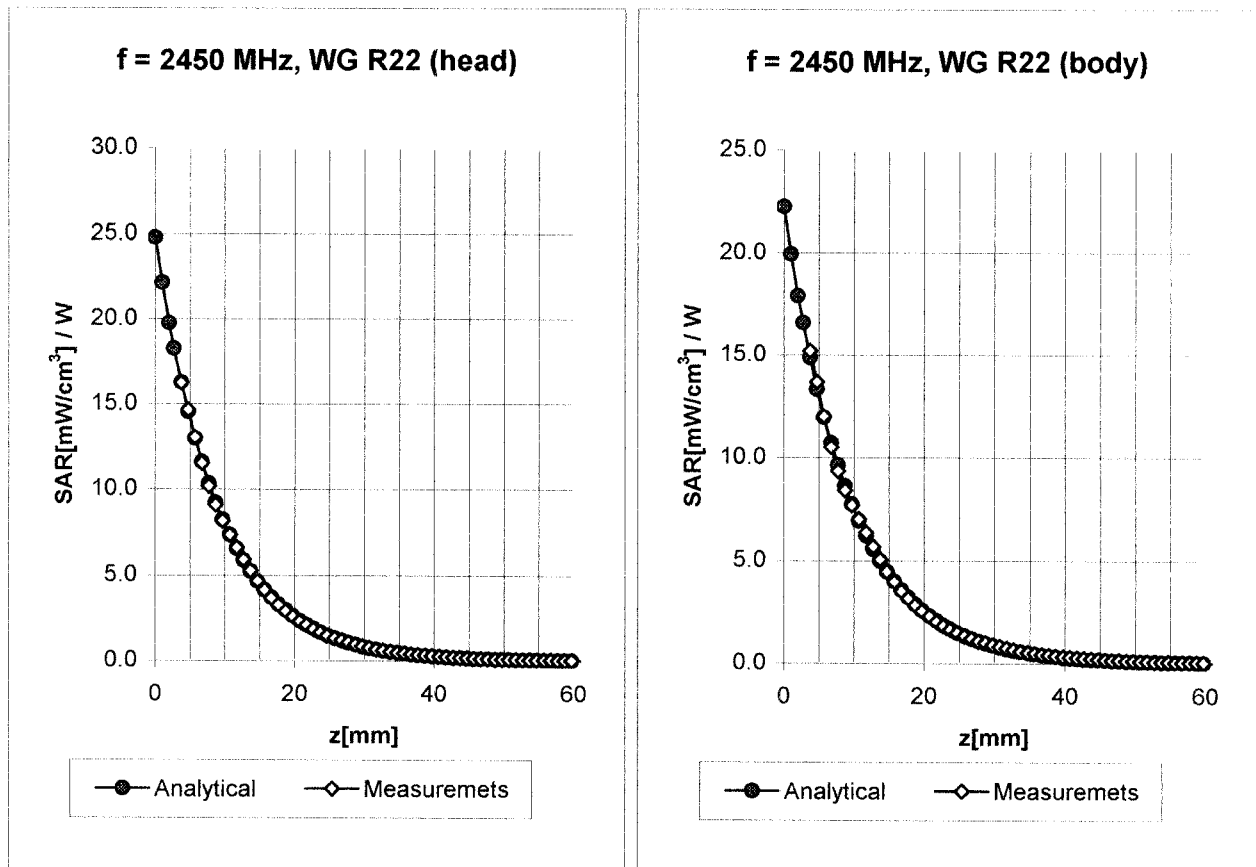

Head	2450	MHz	$\epsilon_r = 39.2 \pm 5\%$	$\sigma = 1.80 \pm 5\%$ mho/m
	ConvF X	5.0	$\pm 8.9\%$ (k=2)	Boundary effect:
	ConvF Y	5.0	$\pm 8.9\%$ (k=2)	Alpha 1.04
	ConvF Z	5.0	$\pm 8.9\%$ (k=2)	Depth 1.85
Body	2450	MHz	$\epsilon_r = 52.7 \pm 5\%$	$\sigma = 1.95 \pm 5\%$ mho/m
	ConvF X	4.6	$\pm 8.9\%$ (k=2)	Boundary effect:
	ConvF Y	4.6	$\pm 8.9\%$ (k=2)	Alpha 1.20
	ConvF Z	4.6	$\pm 8.9\%$ (k=2)	Depth 1.60

Deviation from Isotropy in HSL

Error (θ, ϕ), $f = 900$ MHz

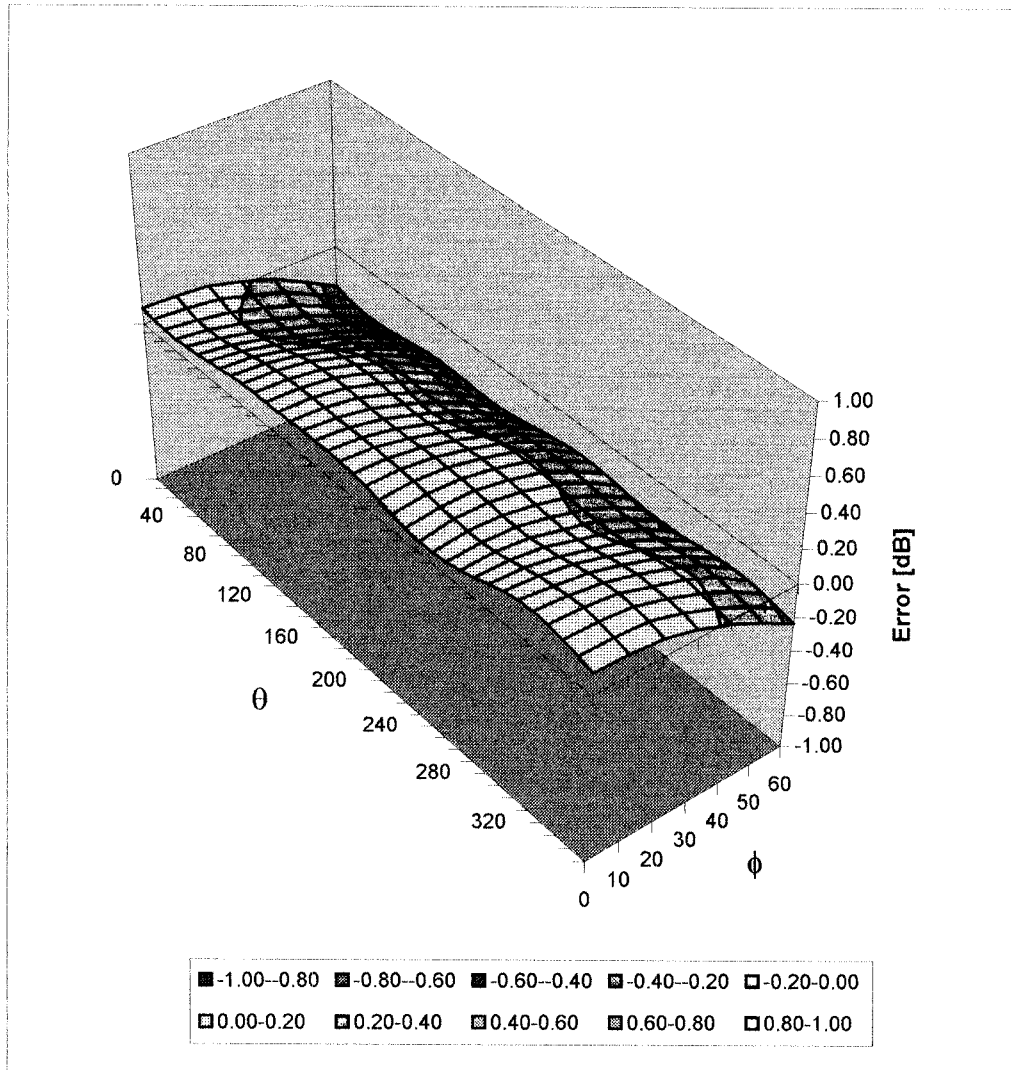

Additional Conversion Factors for Dosimetric E-Field Probe

Type:	ET3DV6
Serial Number:	1387
Place of Assessment:	Zurich
Date of Assessment:	February 28, 2003
Probe Calibration Date:	February 26, 2003

Schmid & Partner Engineering AG hereby certifies that conversion factor(s) of this probe have been evaluated on the date indicated above. The assessment was performed using the FDTD numerical code SEMCAD of Schmid & Partner Engineering AG. Since the evaluation is coupled with measured conversion factors, it has to be recalculated yearly, i.e., following the re-calibration schedule of the probe. The uncertainty of the numerical assessment is based on the extrapolation from measured value at 900 MHz or at 1800 MHz.

Assessed by:

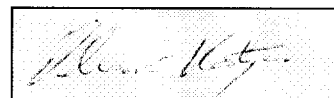

Dosimetric E-Field Probe ET3DV6 SN:1387

Conversion factor (\pm standard deviation)

150 MHz	ConvF	$9.1 \pm 8\%$	$\epsilon_r = 52.3$ $\sigma = 0.76 \text{ mho/m}$ (head tissue)
300 MHz	ConvF	$7.9 \pm 8\%$	$\epsilon_r = 45.3$ $\sigma = 0.87 \text{ mho/m}$ (head tissue)
450 MHz	ConvF	$7.5 \pm 8\%$	$\epsilon_r = 43.5$ $\sigma = 0.87 \text{ mho/m}$ (head tissue)
150 MHz	ConvF	$8.8 \pm 8\%$	$\epsilon_r = 61.9$ $\sigma = 0.80 \text{ mho/m}$ (body tissue)
300 MHz	ConvF	$8.0 \pm 8\%$	$\epsilon_r = 58.2$ $\sigma = 0.92 \text{ mho/m}$ (body tissue)
450 MHz	ConvF	$7.7 \pm 8\%$	$\epsilon_r = 56.7$ $\sigma = 0.94 \text{ mho/m}$ (body tissue)

APPENDIX E - MEASURED FLUID DIELECTRIC PARAMETERS

2450 MHz System Performance Check

Measured Fluid Dielectric Parameters (Brain)

August 29, 2003

Frequency	ϵ'	ϵ''
2.350000000 GHz	37.8252	13.2805
2.360000000 GHz	37.7946	13.3103
2.370000000 GHz	37.7682	13.3477
2.380000000 GHz	37.7319	13.3713
2.390000000 GHz	37.7040	13.3940
2.400000000 GHz	37.6657	13.4059
2.410000000 GHz	37.6008	13.4312
2.420000000 GHz	37.5565	13.4676
2.430000000 GHz	37.4881	13.4964
2.440000000 GHz	37.4450	13.5352
2.450000000 GHz	37.3954	13.5714
2.460000000 GHz	37.3468	13.6179
2.470000000 GHz	37.3266	13.6580
2.480000000 GHz	37.2934	13.6844
2.490000000 GHz	37.2789	13.7094
2.500000000 GHz	37.2457	13.7039
2.510000000 GHz	37.1968	13.7278
2.520000000 GHz	37.1576	13.7656
2.530000000 GHz	37.0965	13.7759
2.540000000 GHz	37.0477	13.8196
2.550000000 GHz	36.9965	13.8333

2450 MHz DUT Evaluation (Body)

Measured Fluid Dielectric Parameters (Muscle)

August 29, 2003

Frequency	ϵ'	ϵ''
2.350000000 GHz	50.6358	14.1895
2.360000000 GHz	50.6118	14.2159
2.370000000 GHz	50.5835	14.2404
2.380000000 GHz	50.5643	14.2837
2.390000000 GHz	50.5383	14.3139
2.400000000 GHz	50.4981	14.3398
2.410000000 GHz	50.4644	14.3911
2.420000000 GHz	50.4372	14.4315
2.430000000 GHz	50.3912	14.4700
2.440000000 GHz	50.3657	14.5242
2.450000000 GHz	50.3097	14.5579
2.460000000 GHz	50.3027	14.6127
2.470000000 GHz	50.2587	14.6479
2.480000000 GHz	50.2469	14.6843
2.490000000 GHz	50.2183	14.7236
2.500000000 GHz	50.1776	14.7312
2.510000000 GHz	50.1315	14.7864
2.520000000 GHz	50.1020	14.8215
2.530000000 GHz	50.0414	14.8890
2.540000000 GHz	50.0066	14.9175
2.550000000 GHz	49.9694	14.9720

APPENDIX F - SAM PHANTOM CERTIFICATE OF CONFORMITY

Schmid & Partner Engineering AG

Zeughausstrasse 43, 8004 Zurich, Switzerland, Phone +41 1 245 97 00, Fax +41 1 245 97 79

Certificate of conformity / First Article Inspection

Item	SAM Twin Phantom V4.0
Type No	QD 000 P40 BA
Series No	TP-1002 and higher
Manufacturer / Origin	Untersee Composites Hauptstr. 69 CH-8559 Fruthwilen Switzerland

Tests

The series production process used allows the limitation to test of first articles.
Complete tests were made on the pre-series Type No. QD 000 P40 AA, Serial No. TP-1001 and on the series first article Type No. QD 000 P40 BA, Serial No. TP-1006. Certain parameters have been retested using further series units (called samples).

Test	Requirement	Details	Units tested
Shape	Compliance with the geometry according to the CAD model.	IT'IS CAD File (*)	First article, Samples
Material thickness	Compliant with the requirements according to the standards	2mm +/- 0.2mm in specific areas	First article, Samples
Material parameters	Dielectric parameters for required frequencies	200 MHz – 3 GHz Relative permittivity < 5 Loss tangent < 0.05.	Material sample TP 104-5
Material resistivity	The material has been tested to be compatible with the liquids defined in the standards	Liquid type HSL 1800 and others according to the standard.	Pre-series, First article

Standards

- [1] CENELEC EN 50361
 - [2] IEEE P1528-200x draft 6.5
 - [3] IEC PT 62209 draft 0.9
- (*) The IT'IS CAD file is derived from [2] and is also within the tolerance requirements of the shapes of [1] and [3].

Conformity

Based on the sample tests above, we certify that this item is in compliance with the uncertainty requirements of SAR measurements specified in standard [1] and draft standards [2] and [3].

Date 18.11.2001

Signature / Stamp

**Schmid & Partner
Engineering AG**

Zeughausstrasse 43, CH-8004 Zurich
Tel. +41 1 245 97 00, Fax +41 1 245 97 79