

DECLARATION OF COMPLIANCE SAR RF EXPOSURE EVALUATION

Test Lab

CELLTECH LABS INC.
Testing and Engineering Services
1955 Moss Court
Kelowna, B.C.
Canada V1Y 9L3
Phone: 250-448-7047
Fax: 250-448-7046
e-mail: info@celltechlabs.com
web site: www.celltechlabs.com

Applicant Information

ITRONIX CORPORATION
801 South Stevens Street
Spokane, WA 99210-0179

Rule Part(s):	FCC 47 CFR §2.1093; IC RSS-102 Issue 1 (Provisional)
Test Procedure(s):	FCC OET Bulletin 65, Supplement C (01-01)
FCC Device Classification:	PCS Licensed Transmitter (PCB)
IC Device Classification:	2GHz Personal Communication Services (RSS-133 Issue 2) 800MHz CDMA Cellular Transmitter (RSS-129 Issue 2)
FCC ID:	KBCIX260MPIA555BT
Model(s):	IX260
Device Type:	Rugged Laptop PC with Sierra Wireless AirCard 555/550 Dual-Band PCS/Cellular CDMA PCMCIA Modem Card co-located with Cisco Systems MPI-350 Mini-PCI DSSS WLAN Card & Mitsumi WML-C11 Bluetooth Transmitter
Tx Frequency Range(s):	1851.25 - 1908.75 MHz (PCS CDMA) 824.70 - 848.31 MHz (Cellular CDMA) 2412 - 2462 MHz (WLAN) 2402 - 2480 MHz (Bluetooth)
RF Output Power Tested:	23.0 dBm Conducted (PCS CDMA) 23.0 dBm Conducted (Cellular CDMA)
Antenna Type(s):	External Dipole (PCS/Cellular CDMA Modem) Internal - upper right edge of LCD display (WLAN) Internal - upper left edge of LCD display (Bluetooth)
Battery Type:	11.1V Lithium-Ion, 6.0Ah (Model: A2121-2)
Max. SAR Measured:	1.24 W/kg (PCS CDMA) / 0.512 W/kg (Cellular CDMA)

Celltech Labs Inc. declares under its sole responsibility that this wireless device has demonstrated compliance with the Specific Absorption Rate (SAR) RF exposure requirements specified in FCC 47 CFR §2.1093 and Health Canada's Safety Code 6. The device was tested in accordance with the measurement standards and procedures specified in FCC OET Bulletin 65, Supplement C (Edition 01-01) and Industry Canada RSS-102 Issue 1 (Provisional) for the General Population / Uncontrolled Exposure environment. All measurements were performed in accordance with the SAR system manufacturer recommendations.

I attest to the accuracy of data. All measurements were performed by me or were made under my supervision and are correct to the best of my knowledge and belief. I assume full responsibility for the completeness of these measurements and vouch for the qualifications of all persons taking them.

This test report shall not be reproduced partially, or in full, without the prior written approval of Celltech Labs Inc. The results and statements contained in this report pertain only to the device(s) evaluated.



Russell Pipe
Senior Compliance Technologist
Celltech Labs Inc.



TABLE OF CONTENTS		
1.0	INTRODUCTION.....	3
2.0	DESCRIPTION OF DUT.....	3
3.0	SAR MEASUREMENT SYSTEM	4
4.0	MEASUREMENT SUMMARY.....	5-6
5.0	DETAILS OF SAR EVALUATION.....	7
6.0	EVALUATION PROCEDURES.....	7-8
7.0	SYSTEM PERFORMANCE CHECK.....	9
8.0	SIMULATED EQUIVALENT TISSUES.....	10
9.0	SAR LIMITS.....	10
10.0	SYSTEM SPECIFICATIONS.....	11
11.0	PROBE SPECIFICATION.....	12
12.0	SAM PHANTOM.....	12
13.0	DEVICE HOLDER.....	12
14.0	TEST EQUIPMENT LIST.....	13
15.0	MEASUREMENT UNCERTAINTIES.....	14-15
16.0	REFERENCES.....	16
	APPENDIX A - SAR MEASUREMENT DATA.....	17
	APPENDIX B - SYSTEM PERFORMANCE CHECK DATA.....	18
	APPENDIX C - SYSTEM VALIDATION.....	19
	APPENDIX D - PROBE CALIBRATION.....	20
	APPENDIX E - MEASURED FLUID DIELECTRIC PARAMETERS.....	21
	APPENDIX F - SAM PHANTOM CERTIFICATE OF CONFORMITY.....	22
	APPENDIX G - SAR TEST SETUP PHOTOGRAPHS.....	23

1.0 INTRODUCTION

This measurement report demonstrates that the ITRONIX CORPORATION Model: IX260 FCC ID: KBCIX260MPIA555BT Rugged Laptop PC with Sierra Wireless AirCard 555/550 Dual-Band PCS/Cellular CDMA PCMCIA Modem Card co-located with Cisco Systems MPI-350 Mini-PCI DSSS WLAN Card and Mitsumi WML-C11 Bluetooth Transmitter complies with the RF exposure requirements specified in FCC 47 CFR §2.1093 (see reference [1]) and Health Canada Safety Code 6 (see reference [2]) for the General Population environment. The test procedures described in FCC OET Bulletin 65, Supplement C, Edition 01-01 (see reference [3]) and IC RSS-102 Issue 1 (Provisional) (see reference [4]) were employed. A description of the product, operating configuration, detailed summary of the test results, methodology and procedures used in the evaluation, equipment used, and the various provisions of the rules are included within this test report.

2.0 DESCRIPTION of Device Under Test (DUT)

FCC Rule Part(s)	47 CFR §2.1093
IC Rule Part(s)	IC RSS-102 Issue 1 (Provisional)
Test Procedure(s)	FCC OET Bulletin 65, Supplement C (01-01)
FCC Device Classification	PCS Licensed Transmitter (PCB)
IC Device Classification	2GHz Personal Communication Services (RSS-133 Issue 2) 800MHz CDMA Cellular Transmitter (RSS-129 Issue 2)
Device Type	Rugged Laptop PC with Sierra Wireless AirCard 555/550 Dual-Band PCS/Cellular CDMA PCMCIA Modem Card co-located with Cisco Systems MPI-350 Mini-PCI DSSS WLAN Card and Mitsumi WML-C11 Bluetooth Transmitter
FCC ID	KBCIX260MPIA555BT
Model(s)	IX260
Serial No.	ZZGEG3135ZZ1409 (Identical Prototype)
Modulation	QPSK
Tx Frequency Range	1851.25 - 1908.75 MHz (PCS CDMA) 824.70 - 848.31 MHz (Cellular CDMA) 2412 - 2462 MHz (WLAN) 2402 - 2480 MHz (Bluetooth)
RF Output Power Tested	23.0 dBm Conducted (PCS CDMA) 23.0 dBm Conducted (Cellular CDMA) 21.2 dBm Peak Conducted (WLAN) 14.5 dBm Peak Conducted (Bluetooth)
Antenna Type(s)	External Dipole (Dual-Band CDMA) Internal - upper right edge of LCD display (WLAN) Internal - upper left edge of LCD display (Bluetooth)
Battery Type	11.1V Lithium-Ion, 6.0Ah (Model: A2121-2)

3.0 SAR MEASUREMENT SYSTEM

Celltech Labs SAR measurement facility utilizes the Dosimetric Assessment System (DASY™) manufactured by Schmid & Partner Engineering AG (SPEAG™) of Zurich, Switzerland. The DASY system is comprised of the robot controller, computer, near-field probe, probe alignment sensor, specific anthropomorphic mannequin (SAM) phantom, and various planar phantoms for brain and/or body SAR evaluations. The robot is a six-axis industrial robot performing precise movements to position the probe to the location (points) of maximum electromagnetic field (EMF). A cell controller system contains the power supply, robot controller, teach pendant (Joystick), and remote control, is used to drive the robot motors. The Staubli robot is connected to the cell controller to allow software manipulation of the robot. A data acquisition electronic (DAE) circuit performs the signal amplification, signal multiplexing, AD-conversion, offset measurements, mechanical surface detection, collision detection, etc. is connected to the Electro-optical coupler (EOC). The EOC performs the conversion from the optical into digital electric signal of the DAE and transfers data to the PC plug-in card. The DAE3 utilizes a highly sensitive electrometer-grade preamplifier with auto-zeroing, a channel and gain-switching multiplexer, a fast 16-bit AD-converter and a command decoder and control logic unit. Transmission to the PC-card is accomplished through an optical downlink for data and status information and an optical uplink for commands and clock lines. The mechanical probe-mounting device includes two different sensor systems for frontal and sidewise probe contacts. They are also used for mechanical surface detection and probe collision detection. The robot uses its own controller with a built in VME-bus computer.



DASY3 SAR Measurement System with SAM phantom

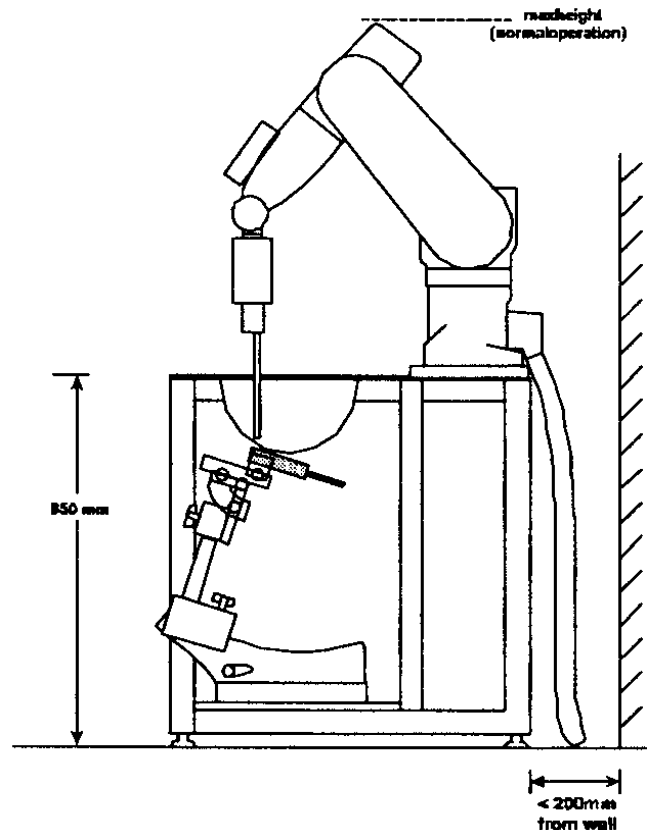

Figure 1. DASY3 Compact Version - Side View

4.0 MEASUREMENT SUMMARY

BODY SAR MEASUREMENT RESULTS - PCS CDMA												
Transmit Mode	Freq. (MHz)	Chan.	Battery Type	Conducted Power (dBm)		Antenna Position to Planar Phantom	Laptop PC Position to Planar Phantom	Separation Distance to Planar Phantom (cm)	Measured SAR 1g (W/kg)		Scaled SAR 1g (W/kg)	
				Before	After				P	S	P	S
PCS CDMA	1880.00	600	Lithium-ion	23.0	22.9	Parallel (Stowed)	Back of LCD (LCD Closed)	0.0	P 1.21 S 1.07	P 1.24 S 1.09		
PCS CDMA	1851.25	25	Lithium-ion	23.0	22.9	Parallel (Stowed)	Back of LCD (LCD Closed)	0.0	P 0.770 S 0.693	P 0.787 S 0.710		
PCS CDMA	1909.75	1175	Lithium-ion	23.0	22.9	Parallel (Stowed)	Back of LCD (LCD Closed)	0.0	P 0.920 S 0.869	P 0.942 S 0.889		
PCS CDMA & DSSS WLAN	1880.00	600	Lithium-ion	23.0	22.8	Parallel (Stowed)	Back of LCD (LCD Closed)	0.0	P 1.12 S 1.06	P 1.17 S 1.11		
PCS CDMA, DSSS WLAN, & Bluetooth	1880.00	600	Lithium-ion	23.0	22.8	Parallel (Stowed)	Back of LCD (LCD Closed)	0.0	P 1.13 S 1.08	P 1.18 S 1.13		
ANSI / IEEE C95.1 1992 - SAFETY LIMIT BODY: 1.6 W/kg (averaged over 1 gram) Spatial Peak - Uncontrolled Exposure / General Population												
Test Date(s)		08/27/03			Relative Humidity			45 %				
Measured Mixture Type		1900 MHz Body			Atmospheric Pressure			101.5 kPa				
Dielectric Constant ϵ_r		IEEE Target		Measured		Ambient Temperature		24.7 °C				
		53.3 ±5%		51.1		Fluid Temperature		22.4 °C				
Conductivity σ (mho/m)		IEEE Target		Measured		Fluid Depth		≥ 15 cm				
		1.52 ±5%		1.52		ρ (Kg/m³)		1000				

Notes:

- The measurement results were obtained with the DUT tested in the conditions described in this report. Detailed measurement data and plots showing the maximum SAR location of the DUT are reported in Appendix A.
- The DUT was tested with the LCD display lid in the closed position, which was determined to be the worst-case configuration based on the internal transmitters transmitting when the LCD display lid is closed.
- All secondary peak SAR locations within 2 dB of the primary peak value were evaluated and reported (P = Primary, S = Secondary).
- Scaled SAR results are reported to show SAR values without conducted power drift. The conducted power drifts were added to the measured SAR values in dB.
- Co-located transmitter SAR is reported only for mid channel to demonstrate any cumulative effects in SAR relative to the single-transmit peak SAR data at the worst-case channel.
- The ambient and fluid temperatures were measured prior to, and during, the fluid dielectric parameter check and the SAR evaluation. The temperatures listed in the table shown above were consistent for all measurement periods.
- The dielectric properties of the simulated body fluid were measured prior to the evaluation using an 85070C Dielectric Probe Kit and an 8753E Network Analyzer (see Appendix E for printout of measured fluid dielectric parameters).

MEASUREMENT SUMMARY (Cont.)

BODY SAR MEASUREMENT RESULTS - CELLULAR CDMA										
Transmit Mode	Freq. (MHz)	Chan.	Battery Type	Conducted Power (dBm)		Antenna Position to Planar Phantom	Laptop PC Position to Planar Phantom	Separation Distance to Planar Phantom (cm)	Measured SAR 1g (W/kg)	Scaled SAR 1g (W/kg)
				Before Test	After Test					
Cellular CDMA	835.89	363	Lithium-ion	23.0	22.8	Parallel (Stowed)	Back of LCD (LCD Closed)	0.0	0.489	0.512
Cellular CDMA & DSSS WLAN	835.89	363	Lithium-ion	23.0	22.9	Parallel (Stowed)	Back of LCD (LCD Closed)	0.0	0.496	0.507
Cellular CDMA, DSSS WLAN, & Bluetooth	835.89	363	Lithium-ion	23.0	23.0	Parallel (Stowed)	Back of LCD (LCD Closed)	0.0	0.482	0.482
ANSI / IEEE C95.1 1992 - SAFETY LIMIT BODY: 1.6 W/kg (averaged over 1 gram) Spatial Peak - Uncontrolled Exposure / General Population										
Test Date(s)		08/28/03			Relative Humidity			55 %		
Measured Mixture Type		835 MHz Body			Atmospheric Pressure			102.0 kPa		
Dielectric Constant ϵ_r		IEEE Target		Measured		Ambient Temperature		23.9 °C		
		55.2 ±5%		55.3		Fluid Temperature		23.2 °C		
Conductivity σ (mho/m)		IEEE Target		Measured		Fluid Depth		≥ 15 cm		
		0.97 ±5%		1.00		ρ (Kg/m³)		1000		

Notes:

- The measurement results were obtained with the DUT tested in the conditions described in this report. Detailed measurement data and plots showing the maximum SAR location of the DUT are reported in Appendix A.
- If the SAR measurements performed at the middle channel were ≥ 3dB below the SAR limit, SAR evaluation for the low and high channels was optional (per FCC OET Bulletin 65, Supplement C, Edition 01-01 (see reference [3])).
- Scaled SAR results are reported to show SAR values without conducted power drift. The conducted power drifts were added to the measured SAR values in dB.
- The DUT was tested with the LCD display lid in the closed position, which was determined to be the worst-case configuration based on internal transmitters transmitting when the LCD display lid is closed.
- The ambient and fluid temperatures were measured prior to, and during, the fluid dielectric parameter check and the SAR evaluation. The temperatures listed in the table shown above were consistent for all measurement periods.
- The dielectric properties of the simulated body fluid were measured prior to the evaluation using an 85070C Dielectric Probe Kit and an 8753E Network Analyzer (see Appendix E for printout of measured fluid dielectric parameters).

5.0 DETAILS OF SAR EVALUATION

The ITRONIX CORPORATION Model: IX260 FCC ID: KBCIX260MPIA555BT Rugged Laptop PC with Sierra Wireless AirCard 555/550 Dual-Band PCS/Cellular CDMA PCMCIA Modem Card co-located with Cisco Systems MPI-350 Mini-PCI DSSS WLAN Card and Mitsumi WML-C11 Bluetooth Transmitter was found to be compliant for localized Specific Absorption Rate based on the following test provisions and conditions described below. The detailed test setup photographs are shown in Appendix G.

1. The DUT was tested for body SAR with the LCD display closed and the back of the LCD display facing parallel to the outer surface of the SAM phantom (planar section) with a 0.0 cm separation distance. The DUT was tested with the dipole antenna in the parallel (stowed) position to the outer surface of the SAM phantom (planar section).
2. All secondary peak SAR locations within 2 dB of the primary peak value were evaluated (see SAR Plots - Appendix A).
3. Due to the dimensions of the DUT the initial coarse scans did not cover the entire area of the Laptop PC. Subsequently, a second coarse scan was performed for the highest SAR configurations to show there were no secondary peak SAR locations within 2 dB of the primary peak values.
4. Due to the dimensions of the DUT, a stack of low-density, low-loss dielectric foamed polystyrene was used in place of the device holder.
5. The conducted power levels were measured before and after each test using a Gigatronics 8652A Universal Power Meter according to the procedures described in FCC 47 CFR §2.1046.
6. For the co-located simultaneous transmit tests the Cisco MPI-350 DSSS WLAN Card was set to the maximum conducted power level (21.2 dBm) at the mid channel (2437MHz) with a CW signal and the right side internal antenna transmitting. The Mitsumi WML-C11 Bluetooth transmitter was set to the maximum conducted power level (14.5 dBm) at the mid channel (2441MHz) with a modulated signal and the left side internal antenna transmitting.
7. The DUT was controlled in test mode via internal software. SAR measurements were performed with the DUT transmitting continuously at maximum power in the "always up" power control mode with a modulated CDMA signal.
8. The DUT was tested with a fully charged battery.

6.0 EVALUATION PROCEDURES

- a. (i) The evaluation was performed in the applicable area of the phantom depending on the type of device being tested. For devices held to the ear during normal operation, both the left and right ear positions were evaluated in accordance with FCC OET Bulletin 65, Supplement C (Edition 01-01) using the SAM phantom.
(ii) For body-worn and face-held devices a planar phantom was used.
- b. The SAR was determined by a pre-defined procedure within the DASY3 software. Upon completion of a reference and optical surface check, the exposed region of the phantom was scanned near the inner surface with a grid spacing of 20mm x 20mm.
- c. Based on the area scan data, the area of maximum absorption was determined by spline interpolation. Around this point, a volume of 40 x 40 x 35 mm (fine resolution volume scan, zoom scan) was assessed by measuring 5 x 5 x 7 points.
- d. The 1g and 10g spatial peak SAR was determined as follows:
 1. The first step was an extrapolation to find the points between the dipole center of the probe and the surface of the phantom. This data cannot be measured, since the center of the dipoles is 2.7 mm away from the tip of the probe and the distance between the surface and the lowest measuring point is 1.4 mm (see probe calibration document in Appendix D). The extrapolation was based on a least square algorithm [W. Gander, Computermathematik, p.168-180] (see reference [6]). Through the points in the first 3 cm in all z-axis, polynomials of the fourth order were calculated. This polynomial was then used to evaluate the points between the surface and the probe tip.
 2. The next step used 3D-spline interpolation to get all points within the measured volume in a 1mm grid (35000 points). The 3D-spline is composed of three one-dimensional splines with the "Not a knot" condition [W. Gander, Computermathematik, p.141-150] (x, y and z -direction) [Numerical Recipes in C, Second Edition, p.123ff] (see reference [6]).
 3. The maximal interpolated value was searched with a straightforward algorithm. Around this maximum the SAR values averaged over the spatial volumes (1g or 10g) were computed using the 3D-spline interpolation algorithm. 8000 points (20x20x20) were interpolated to calculate the average.

EVALUATION PROCEDURES (Cont.)

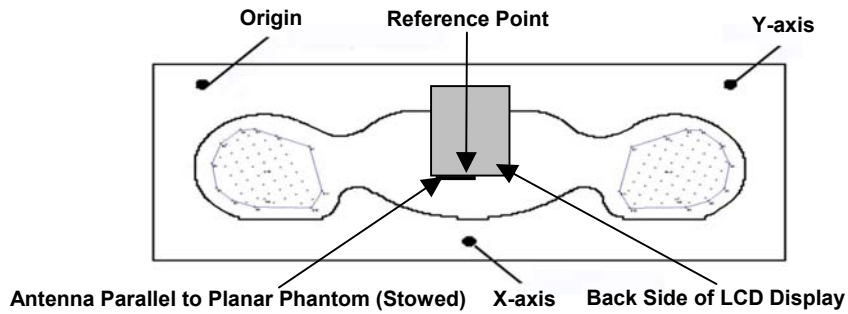

**Figure 2. Phantom Reference Point & DUT Positioning
Back Side of LCD Display (Closed) - Cube Scan**

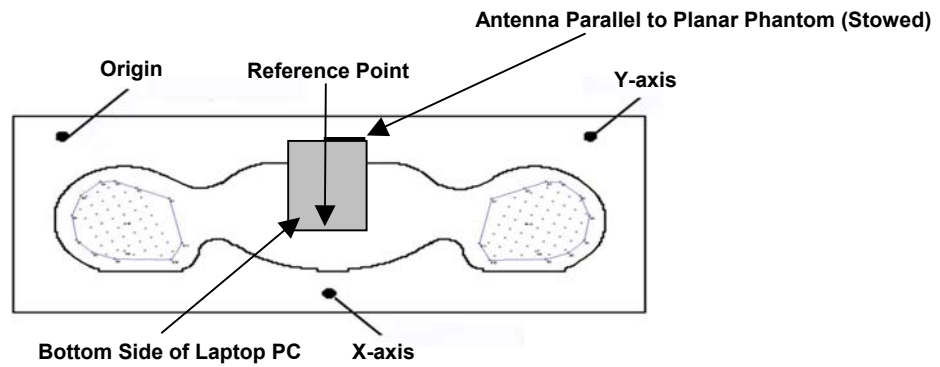

**Figure 3. Phantom Reference Point & DUT Positioning
2nd Half of the Back Side LCD Display (Closed) - Coarse Scan**

7.0 SYSTEM PERFORMANCE CHECK

Prior to the SAR evaluation a system check was performed at the planar section of the SAM phantom with an 1800MHz dipole and a 900MHz dipole (see Appendix C for system validation procedures). The fluid dielectric parameters were measured prior to the system check using an 85070C Dielectric Probe Kit and an 8753E Network Analyzer (see Appendix E for printout of measured fluid dielectric parameters). A forward power of 250mW was applied to the dipole and the system was verified to a tolerance of $\pm 10\%$ (see Appendix B for system check test plots).

SYSTEM PERFORMANCE CHECK											
Test Date	Equiv. Tissue	SAR 1g (W/kg)		Dielectric Constant ϵ_r		Conductivity σ (mho/m)		ρ (Kg/m ³)	Ambient Temp.	Fluid Temp.	Fluid Depth
		IEEE Target	Measured	IEEE Target	Measured	IEEE Target	Measured				
08/27/03	1800MHz Brain	9.53 $\pm 10\%$	9.37	40.0 $\pm 5\%$	39.6	1.40 $\pm 5\%$	1.34	1000	24.0 °C	22.8 °C	≥ 15 cm
08/28/03	900MHz Brain	2.70 $\pm 10\%$	2.52	41.5 $\pm 5\%$	40.5	0.97 $\pm 5\%$	0.97	1000	23.5 °C	22.7 °C	≥ 15 cm

Note(s):

- The ambient and fluid temperatures were measured prior to, and during, the fluid dielectric parameter check and the system performance check. The temperatures listed in the table above were consistent for all measurement periods.

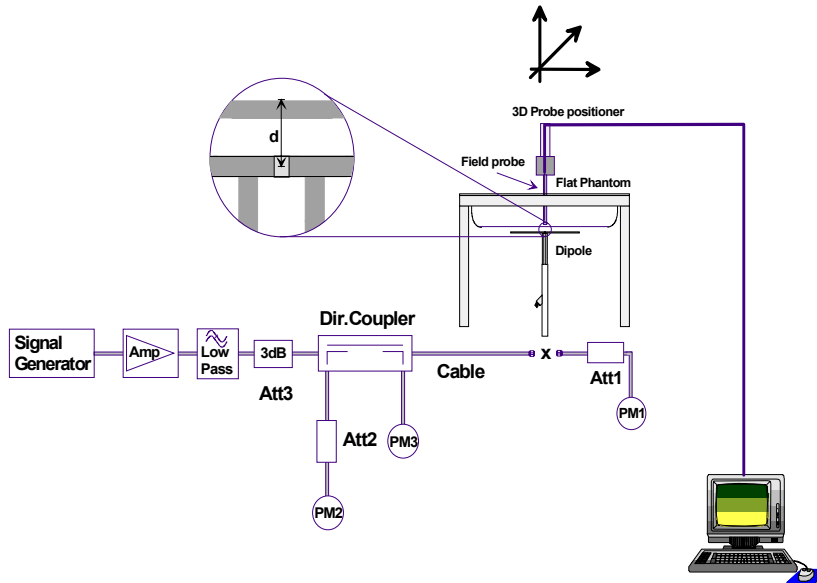

Figure 4. System Performance Check Setup Diagram



1800MHz Dipole Setup



900MHz Dipole Setup

8.0 EQUIVALENT TISSUES

The 1800MHz and 1900 MHz simulated tissue mixtures consist of Glycol-monobutyl, water, and salt. The 835MHz and 900MHz simulated tissue mixtures consist of a viscous gel using hydroxethylcellulose (HEC) gelling agent and sugar / saline solution. Preservation with a bactericide was added and visual inspection was made to ensure air bubbles were not trapped during the mixing process. The fluids were prepared according to standardized procedures and measured for dielectric parameters (permittivity and conductivity).

1800MHz & 1900MHz TISSUE MIXTURES (1 Liter Yields)		
INGREDIENT	1800 MHz Brain (System Check)	1900 MHz Body (DUT Evaluation)
Water	548.0 g	716.60 g
Glycol Monobutyl	448.5 g	300.70 g
Salt	3.20 g	3.10 g

835MHz & 900MHz TISSUE MIXTURES		
INGREDIENT	900 MHz Brain (System Check)	835 MHz Body (DUT Evaluation)
Water	40.71 %	53.70 %
Sugar	56.63 %	45.10 %
Salt	1.48 %	0.97 %
HEC	1.00 %	0.13%
Bactericide	0.18 %	0.10 %

9.0 SAR SAFETY LIMITS

EXPOSURE LIMITS	SAR (W/kg)	
	(General Population / Uncontrolled Exposure Environment)	(Occupational / Controlled Exposure Environment)
Spatial Average (averaged over the whole body)	0.08	0.4
Spatial Peak (averaged over any 1 g of tissue)	1.60	8.0
Spatial Peak (hands/wrists/feet/ankles averaged over 10 g)	4.0	20.0

Notes:

1. Uncontrolled environments are defined as locations where there is potential exposure of individuals who have no knowledge or control of their potential exposure.
2. Controlled environments are defined as locations where there is potential exposure of individuals who have knowledge of their potential exposure and can exercise control over their exposure.

10.0 ROBOT SYSTEM SPECIFICATIONS

Specifications

POSITIONER: Stäubli Unimation Corp. Robot Model: RX60L
Repeatability: 0.02 mm
No. of axis: 6

Data Acquisition Electronic (DAE) System

Cell Controller

Processor: Pentium III
Clock Speed: 450 MHz
Operating System: Windows NT
Data Card: DASY3 PC-Board

Data Converter

Features: Signal Amplifier, multiplexer, A/D converter, and control logic
Software: DASY3 software
Connecting Lines: Optical downlink for data and status info.
Optical uplink for commands and clock

PC Interface Card

Function: 24 bit (64 MHz) DSP for real time processing
Link to DAE3
16-bit A/D converter for surface detection system
serial link to robot
direct emergency stop output for robot

E-Field Probe

Model: ET3DV6
Serial No.: 1387
Construction: Triangular core fiber optic detection system
Frequency: 10 MHz to 6 GHz
Linearity: ± 0.2 dB (30 MHz to 3 GHz)

Phantom

Type: SAM V4.0C
Shell Material: Fiberglass
Thickness: 2.0 ± 0.1 mm
Volume: Approx. 20 liters

11.0 PROBE SPECIFICATION (ET3DV6)

Construction:	Symmetrical design with triangular core Built-in shielding against static charges PEEK enclosure material (resistant to organic solvents, e.g. glycol)
Calibration:	In air from 10 MHz to 2.5 GHz In brain simulating tissue at frequencies of 900 MHz and 1.8 GHz (accuracy $\pm 8\%$)
Frequency:	10 MHz to >6 GHz; Linearity: ± 0.2 dB (30 MHz to 3 GHz)
Directivity:	± 0.2 dB in brain tissue (rotation around probe axis) ± 0.4 dB in brain tissue (rotation normal to probe axis)
Dynamic Range:	5 μ W/g to >100 mW/g; Linearity: ± 0.2 dB
Surface Detection:	± 0.2 mm repeatability in air and clear liquids over diffuse reflecting surfaces
Dimensions:	Overall length: 330 mm Tip length: 16 mm Body diameter: 12 mm Tip diameter: 6.8 mm Distance from probe tip to dipole centers: 2.7 mm
Application:	General dosimetry up to 3 GHz Compliance tests of mobile phone



ET3DV6 E-Field Probe

12.0 SAM PHANTOM V4.0C

The SAM phantom V4.0C is a fiberglass shell phantom with a 2.0 mm shell thickness for left and right head and flat planar area integrated in a wooden table. The shape of the fiberglass shell corresponds to the phantom defined by SCC34-SC2. The device holder positions are adjusted to the standard measurement positions in the three sections.

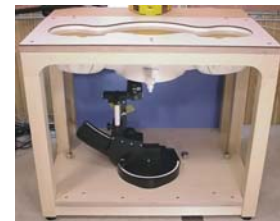

SAM Phantom

13.0 DEVICE HOLDER

The DASY3 device holder has two scales for device rotation (with respect to the body axis) and the device inclination (with respect to the line between the ear openings). The plane between the ear openings and the mouth tip has a rotation angle of 65°. The bottom plate contains three pair of bolts for locking the device holder. The device holder positions are adjusted to the standard measurement positions in the three sections.



Device Holder

14.0 TEST EQUIPMENT LIST

SAR MEASUREMENT SYSTEM		
EQUIPMENT	SERIAL NO.	CALIBRATION DATE
DASY3 System		
-Robot	599396-01	N/A
-ET3DV6 E-Field Probe	1387	Feb 2003
-300MHz Validation Dipole	135	Oct 2002
-450MHz Validation Dipole	136	Oct 2002
-900MHz Validation Dipole	054	June 2003
-1800MHz Validation Dipole	247	June 2003
-2450MHz Validation Dipole	150	Oct 2002
-SAM Phantom V4.0C	N/A	N/A
-Small Planar Phantom	N/A	N/A
-Medium Planar Phantom	N/A	N/A
-Large Planar Phantom	N/A	N/A
85070C Dielectric Probe Kit	N/A	N/A
Gigatronics 8652A Power Meter	1835272	Feb 2003
-Power Sensor 80701A	1833535	Feb 2003
-Power Sensor 80701A	1833542	Feb 2003
Pasternack Attenuator (30dB, 2W)	PE7014-30	N/A
E4408B Spectrum Analyzer	US39240170	Dec 2002
8594E Spectrum Analyzer	3543A02721	Feb 2003
8753E Network Analyzer	US38433013	Feb 2003
8648D Signal Generator	3847A00611	Feb 2003
5S1G4 Amplifier Research Power Amplifier	26235	N/A

15.0 MEASUREMENT UNCERTAINTIES

UNCERTAINTY BUDGET FOR DEVICE EVALUATION						
Error Description	Uncertainty Value ±%	Probability Distribution	Divisor	C_i 1g	Standard Uncertainty ±% (1g)	v_i or v_{eff}
Measurement System						
Probe calibration	± 4.8	Normal	1	1	± 4.8	∞
Axial isotropy of the probe	± 4.7	Rectangular	√3	(1- C_p)	± 1.9	∞
Spherical isotropy of the probe	± 9.6	Rectangular	√3	(C_p)	± 3.9	∞
Spatial resolution	± 0.0	Rectangular	√3	1	± 0.0	∞
Boundary effects	± 5.5	Rectangular	√3	1	± 3.2	∞
Probe linearity	± 4.7	Rectangular	√3	1	± 2.7	∞
Detection limit	± 1.0	Rectangular	√3	1	± 0.6	∞
Readout electronics	± 1.0	Normal	1	1	± 1.0	∞
Response time	± 0.8	Rectangular	√3	1	± 0.5	∞
Integration time	± 1.4	Rectangular	√3	1	± 0.8	∞
RF ambient conditions	± 3.0	Rectangular	√3	1	± 1.7	∞
Mech. constraints of robot	± 0.4	Rectangular	√3	1	± 0.2	∞
Probe positioning	± 2.9	Rectangular	√3	1	± 1.7	∞
Extrapolation & integration	± 3.9	Rectangular	√3	1	± 2.3	∞
Test Sample Related						
Device positioning	± 6.0	Normal	√3	1	± 6.7	12
Device holder uncertainty	± 5.0	Normal	√3	1	± 5.9	8
Power drift	± 5.0	Rectangular	√3		± 2.9	∞
Phantom and Setup						
Phantom uncertainty	± 4.0	Rectangular	√3	1	± 2.3	∞
Liquid conductivity (target)	± 5.0	Rectangular	√3	0.6	± 1.7	∞
Liquid conductivity (measured)	± 5.0	Rectangular	√3	0.6	± 1.7	∞
Liquid permittivity (target)	± 5.0	Rectangular	√3	0.6	± 1.7	∞
Liquid permittivity (measured)	± 5.0	Rectangular	√3	0.6	± 1.7	∞
Combined Standard Uncertainty					± 13.3	
Expanded Uncertainty (k=2)					± 26.6	

Measurement Uncertainty Table in accordance with IEEE Std 1528-200X (Draft - see Reference [5])

15.0 MEASUREMENT UNCERTAINTIES (Cont.)

UNCERTAINTY BUDGET FOR SYSTEM VALIDATION						
Error Description	Uncertainty Value ±%	Probability Distribution	Divisor	C_i 1g	Standard Uncertainty ±% (1g)	v_i or v_{eff}
Measurement System						
Probe calibration	± 4.8	Normal	1	1	± 4.8	∞
Axial isotropy of the probe	± 4.7	Rectangular	√3	(1- C_p)	± 1.9	∞
Spherical isotropy of the probe	± 9.6	Rectangular	√3	(C_p)	± 3.9	∞
Spatial resolution	± 0.0	Rectangular	√3	1	± 0.0	∞
Boundary effects	± 5.5	Rectangular	√3	1	± 3.2	∞
Probe linearity	± 4.7	Rectangular	√3	1	± 2.7	∞
Detection limit	± 1.0	Rectangular	√3	1	± 0.6	∞
Readout electronics	± 1.0	Normal	1	1	± 1.0	∞
Response time	± 0.8	Rectangular	√3	1	± 0.5	∞
Integration time	± 1.4	Rectangular	√3	1	± 0.8	∞
RF ambient conditions	± 3.0	Rectangular	√3	1	± 1.7	∞
Mech. constraints of robot	± 0.4	Rectangular	√3	1	± 0.2	∞
Probe positioning	± 2.9	Rectangular	√3	1	± 1.7	∞
Extrapolation & integration	± 3.9	Rectangular	√3	1	± 2.3	∞
Dipole						
Dipole Axis to Liquid Distance	± 2.0	Rectangular	√3	1	± 1.2	∞
Input Power	± 4.7	Rectangular	√3	1	± 2.7	∞
Phantom and Setup						
Phantom uncertainty	± 4.0	Rectangular	√3	1	± 2.3	∞
Liquid conductivity (target)	± 5.0	Rectangular	√3	0.6	± 1.7	∞
Liquid conductivity (measured)	± 5.0	Rectangular	√3	0.6	± 1.7	∞
Liquid permittivity (target)	± 5.0	Rectangular	√3	0.6	± 1.7	∞
Liquid permittivity (measured)	± 5.0	Rectangular	√3	0.6	± 1.7	∞
Combined Standard Uncertainty					± 9.9	
Expanded Uncertainty (k=2)					± 19.8	

Measurement Uncertainty Table in accordance with IEEE Std 1528-200X (Draft - see Reference [5])

16.0 REFERENCES

- [1] Federal Communications Commission, "Radiofrequency radiation exposure evaluation: portable devices", Rule Part 47 CFR §2.1093: 1999.
- [2] Health Canada, "Limits of Human Exposure to Radiofrequency Electromagnetic Fields in the Frequency Range from 3 kHz to 300 GHz", Safety Code 6.
- [3] Federal Communications Commission, "Evaluating Compliance with FCC Guidelines for Human Exposure to Radio frequency Electromagnetic Fields", OET Bulletin 65, Supplement C (Edition 01-01), FCC, Washington, D.C.: June 2001.
- [4] Industry Canada, "Evaluation Procedure for Mobile and Portable Radio Transmitters with respect to Health Canada's Safety Code 6 for Exposure of Humans to Radio Frequency Fields", Radio Standards Specification RSS-102 Issue 1 (Provisional): September 1999.
- [5] IEEE Standards Coordinating Committee 34, Std 1528-200X, "DRAFT Recommended Practice for Determining the Spatial-Peak Specific Absorption Rate (SAR) in the Human Body Due to Wireless Communications Devices: Experimental Techniques".
- [6] W. Gander, *Computermathematick*, Birkhaeuser, Basel: 1992.

APPENDIX B - SYSTEM PERFORMANCE CHECK DATA

08/27/03

System Performance Check - 1800MHz Dipole

SAM Phantom; Flat Section

Probe: ET3DV6 - SN1387; ConvF(5.20,5.20,5.20); Crest factor: 1.0; Brain 1800 MHz: $\sigma = 1.34$ mho/m $\epsilon_r = 39.6$ $\rho = 1.00$ g/cm³

Cube 5x5x7: Peak: 16.4 mW/g, SAR (1g): 9.37 mW/g, SAR (10g): 5.02 mW/g, (Worst-case extrapolation)

Penetration depth: 9.1 (9.0, 9.5) [mm]; Powerdrift: -0.01 dB

Ambient Temp. 24.0°C; Fluid Temp. 22.8°C

Forward Conducted Power: 250 mW

Date Tested: August 27, 2003

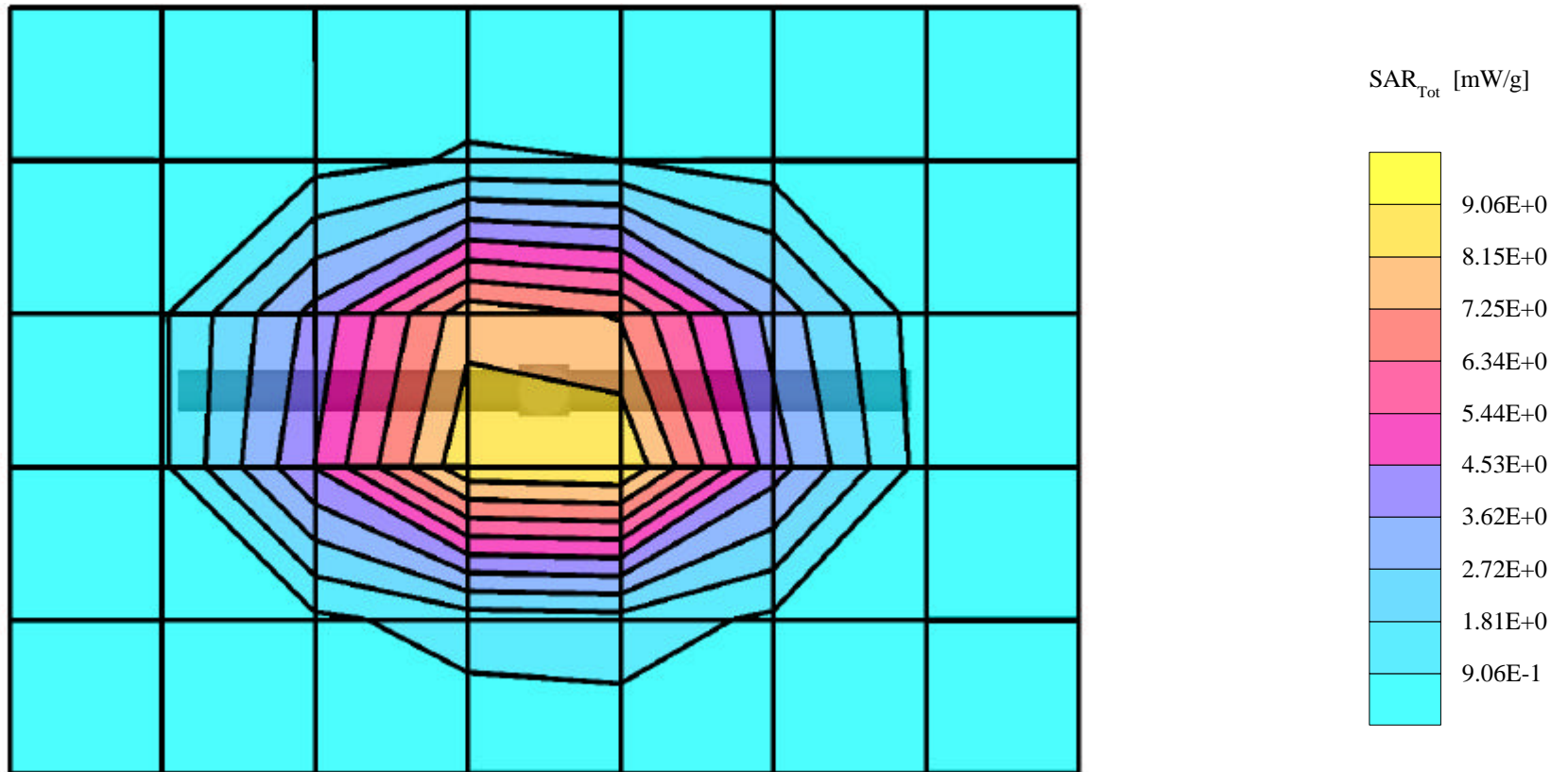

System Performance Check - 900MHz Dipole

SAM Phantom; Flat Section

Probe: ET3DV6 - SN1387; ConvF(6.60,6.60,6.60); Crest factor: 1.0; Brain 900 MHz: $\sigma = 0.97$ mho/m $\epsilon_r = 40.5$ $\rho = 1.00$ g/cm³

Cube 5x5x7: Peak: 3.85 mW/g, SAR (1g): 2.52 mW/g, SAR (10g): 1.62 mW/g, (Worst-case extrapolation)

Penetration depth: 12.1 (11.7, 12.7) [mm]; Powerdrift: -0.03 dB

Ambient Temp. 23.5°C; Fluid Temp. 22.7°C

Conducted Power: 250mW

Date Tested: August 28, 2003

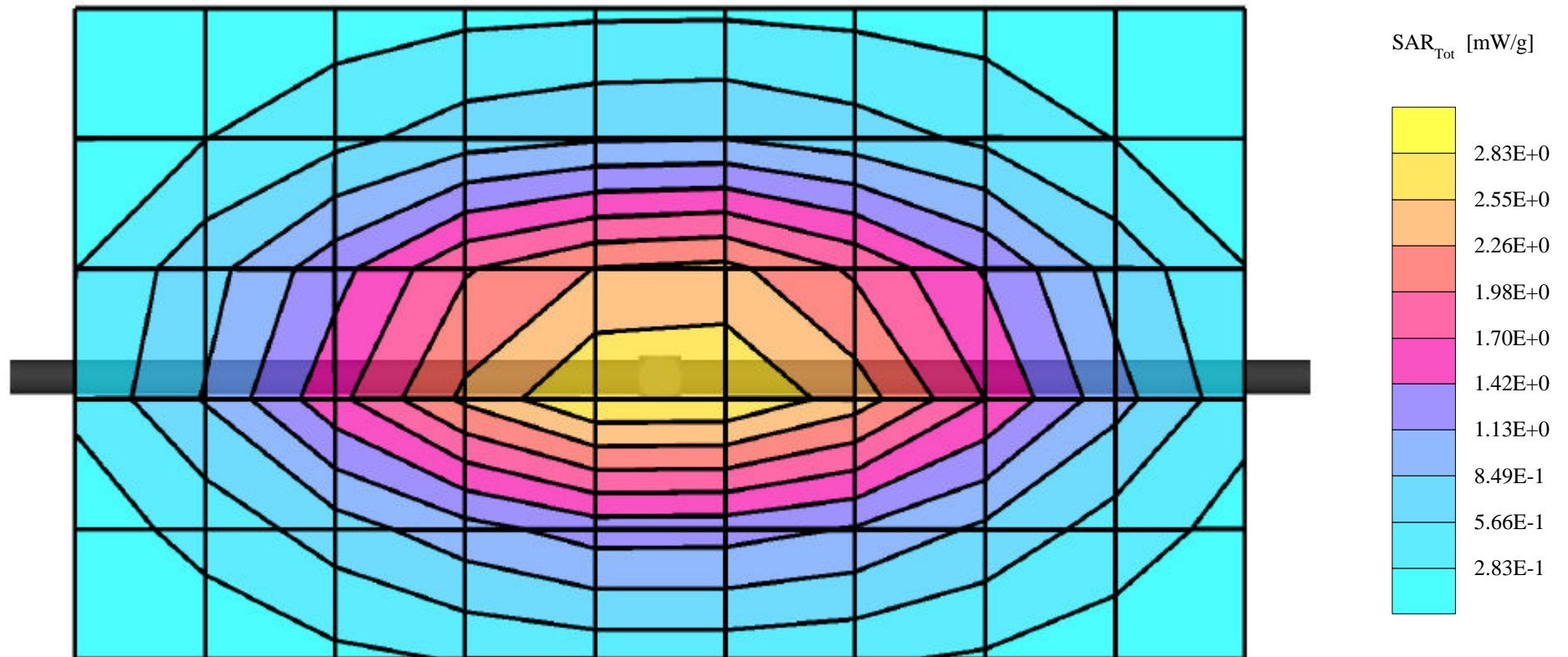

APPENDIX E - MEASURED FLUID DIELECTRIC PARAMETERS

1800MHz System Performance Check

Measured Fluid Dielectric Parameters (Brain)

August 27, 2003

Frequency	e'	e''
1.700000000 GHz	40.0880	13.1522
1.710000000 GHz	40.0471	13.1692
1.720000000 GHz	40.0052	13.1931
1.730000000 GHz	39.9538	13.2194
1.740000000 GHz	39.9102	13.2568
1.750000000 GHz	39.8514	13.2816
1.760000000 GHz	39.8037	13.3123
1.770000000 GHz	39.7688	13.3415
1.780000000 GHz	39.7277	13.3532
1.790000000 GHz	39.6755	13.3747
1.800000000 GHz	39.6314	13.3975
1.810000000 GHz	39.5857	13.4154
1.820000000 GHz	39.5257	13.4180
1.830000000 GHz	39.4887	13.4461
1.840000000 GHz	39.4568	13.4561
1.850000000 GHz	39.4248	13.4692
1.860000000 GHz	39.3981	13.4792
1.870000000 GHz	39.3651	13.4871
1.880000000 GHz	39.3404	13.5019
1.890000000 GHz	39.3223	13.5394
1.900000000 GHz	39.2959	13.5434

1900MHz DUT Evaluation (Body)

Measured Fluid Dielectric Parameters (Muscle)

August 27, 2003

Frequency	ϵ'	ϵ''
1.800000000 GHz	51.3842	14.1994
1.810000000 GHz	51.3440	14.2362
1.820000000 GHz	51.2918	14.2477
1.830000000 GHz	51.2573	14.2696
1.840000000 GHz	51.2239	14.2908
1.850000000 GHz	51.1961	14.3039
1.860000000 GHz	51.1636	14.3178
1.870000000 GHz	51.1334	14.3406
1.880000000 GHz	51.1123	14.3556
1.890000000 GHz	51.0918	14.3774
1.900000000 GHz	51.0838	14.3954
1.910000000 GHz	51.0668	14.4214
1.920000000 GHz	51.0447	14.4555
1.930000000 GHz	51.0351	14.4857
1.940000000 GHz	51.0222	14.5260
1.950000000 GHz	50.9981	14.5518
1.960000000 GHz	50.9769	14.5787
1.970000000 GHz	50.9472	14.6100
1.980000000 GHz	50.9162	14.6570
1.990000000 GHz	50.8943	14.7311
2.000000000 GHz	50.8311	14.7696

900MHz System Performance Check

Measured Fluid Dielectric Parameters (Brain)

August 28, 2003

Frequency	ϵ'	ϵ''
800.000000 MHz	41.7244	19.8699
810.000000 MHz	41.6004	19.8359
820.000000 MHz	41.4801	19.7808
830.000000 MHz	41.3409	19.7592
840.000000 MHz	41.1931	19.7097
850.000000 MHz	41.0304	19.6664
860.000000 MHz	40.9130	19.6223
870.000000 MHz	40.7859	19.6030
880.000000 MHz	40.6905	19.5756
890.000000 MHz	40.5734	19.5655
900.000000 MHz	40.5106	19.4411
910.000000 MHz	40.3959	19.4180
920.000000 MHz	40.3042	19.3794
930.000000 MHz	40.2158	19.3264
940.000000 MHz	40.0558	19.3443
950.000000 MHz	39.9641	19.3231
960.000000 MHz	39.8389	19.2755
970.000000 MHz	39.7111	19.2396
980.000000 MHz	39.5972	19.2378
990.000000 MHz	39.4926	19.1971
1.000000000 GHz	39.4103	19.1460

835MHz DUT Evaluation (Body)

Measured Fluid Dielectric Parameters (Muscle)

August 28, 2003

Frequency	ϵ'	ϵ''
735.000000 MHz	56.2067	22.2946
745.000000 MHz	56.1512	22.2054
755.000000 MHz	56.0348	22.1383
765.000000 MHz	55.9371	22.0425
775.000000 MHz	55.8270	22.0001
785.000000 MHz	55.7452	21.9255
795.000000 MHz	55.6820	21.8916
805.000000 MHz	55.6271	21.8379
815.000000 MHz	55.5351	21.7813
825.000000 MHz	55.3990	21.7310
835.000000 MHz	55.3001	21.6629
845.000000 MHz	55.1709	21.6353
855.000000 MHz	55.0737	21.5639
865.000000 MHz	54.9744	21.5056
875.000000 MHz	54.8748	21.4917
885.000000 MHz	54.7720	21.4584
895.000000 MHz	54.7553	21.3390
905.000000 MHz	54.6827	21.2851
915.000000 MHz	54.5955	21.2641
925.000000 MHz	54.5415	21.1887
935.000000 MHz	54.4292	21.1641

APPENDIX F - SAM PHANTOM CERTIFICATE OF CONFORMITY

Schmid & Partner Engineering AG

Zeughausstrasse 43, 8004 Zurich, Switzerland, Phone +41 1 245 97 00, Fax +41 1 245 97 79

Certificate of conformity / First Article Inspection

Item	SAM Twin Phantom V4.0
Type No	QD 000 P40 BA
Series No	TP-1002 and higher
Manufacturer / Origin	Untersee Composites Hauptstr. 69 CH-8559 Fruthwilen Switzerland

Tests

The series production process used allows the limitation to test of first articles.
Complete tests were made on the pre-series Type No. QD 000 P40 AA, Serial No. TP-1001 and on the series first article Type No. QD 000 P40 BA, Serial No. TP-1006. Certain parameters have been retested using further series units (called samples).

Test	Requirement	Details	Units tested
Shape	Compliance with the geometry according to the CAD model.	IT'IS CAD File (*)	First article, Samples
Material thickness	Compliant with the requirements according to the standards	2mm +/- 0.2mm in specific areas	First article, Samples
Material parameters	Dielectric parameters for required frequencies	200 MHz – 3 GHz Relative permittivity < 5 Loss tangent < 0.05.	Material sample TP 104-5
Material resistivity	The material has been tested to be compatible with the liquids defined in the standards	Liquid type HSL 1800 and others according to the standard.	Pre-series, First article

Standards

- [1] CENELEC EN 50361
 - [2] IEEE P1528-200x draft 6.5
 - [3] IEC PT 62209 draft 0.9
- (*) The IT'IS CAD file is derived from [2] and is also within the tolerance requirements of the shapes of [1] and [3].

Conformity

Based on the sample tests above, we certify that this item is in compliance with the uncertainty requirements of SAR measurements specified in standard [1] and draft standards [2] and [3].

Date 18.11.2001

Signature / Stamp

**Schmid & Partner
Engineering AG**

Zeughausstrasse 43, CH-8004 Zurich
Tel. +41 1 245 97 00, Fax +41 1 245 97 79