

DECLARATION OF COMPLIANCE SAR EVALUATION

Test Lab

CELLTECH LABS INC.
Testing and Engineering Lab
1955 Moss Court
Kelowna, B.C.
Canada V1Y 9L3
Phone: 250-448-7047
Fax: 250-448-7046
e-mail: info@celltechlabs.com
web site: www.celltechlabs.com

Applicant Information

ITRONIX CORPORATION
801 South Stevens Street
Spokane, WA 99210-0179

| | |
|-----------------------------------|--|
| Rule Part(s): | FCC 47 CFR §2.1093; IC RSS-102 Issue 1 (Provisional) |
| Test Procedure(s): | FCC OET Bulletin 65, Supplement C (01-01) |
| FCC Device Classification: | Digital Transmission System (DTS) |
| IC Device Classification: | Low Power License-Exempt Radiocommunication Device |
| FCC ID: | KBCIX260AC555-MPI |
| Model(s): | IX260 |
| Device Type: | Rugged Laptop PC with Cisco MPI-350 Mini-PCI DSSS WLAN Card (Co-located with Sierra Wireless AirCard 555/550 Cellular/PCS CDMA Modem) |
| Tx Frequency Range: | 2412 - 2462 MHz |
| RF Output Power Tested: | 21.2 dBm Peak Conducted (2412 MHz) 21.1 dBm Peak Conducted (2437 MHz) 21.1 dBm Peak Conducted (2462 MHz) |
| Antenna Type(s): | Dual Internal (DSSS WLAN Card) External Dipole (Co-located CDMA Modem) |
| Battery Type: | 11.1V Lithium-Ion, 6.0Ah (Model: A2121-2) |
| Max. SAR Measured: | 0.397 W/kg (1g average) |

Celltech Labs Inc. declares under its sole responsibility that this device was found to be in compliance with the Specific Absorption Rate (SAR) RF exposure requirements specified in FCC 47 CFR §2.1093 and Health Canada's Safety Code 6. The device was tested in accordance with the measurement standards and procedures specified in FCC OET Bulletin 65, Supplement C, Edition 01-01 and Industry Canada RSS-102 Issue 1 (General Population / Uncontrolled Exposure).

I attest to the accuracy of data. All measurements were performed by me or were made under my supervision and are correct to the best of my knowledge and belief. I assume full responsibility for the completeness of these measurements and vouch for the qualifications of all persons taking them.

This test report shall not be reproduced partially, or in full, without the prior written approval of Celltech Labs Inc. The results and statements contained in this report pertain only to the device(s) evaluated.



Russell Pipe
Senior Compliance Technologist
Celltech Labs Inc.



| TABLE OF CONTENTS | | |
|--------------------------|--|-----------|
| 1.0 | INTRODUCTION..... | 3 |
| 2.0 | DESCRIPTION OF EUT..... | 3 |
| 3.0 | SAR MEASUREMENT SYSTEM | 4 |
| 4.0 | MEASUREMENT SUMMARY..... | 5 |
| 5.0 | DETAILS OF SAR EVALUATION..... | 6 |
| 6.0 | EVALUATION PROCEDURES..... | 7 |
| 7.0 | SYSTEM PERFORMANCE CHECK..... | 8 |
| 8.0 | EQUIVALENT TISSUES..... | 9 |
| 9.0 | SAR LIMITS..... | 9 |
| 10.0 | SYSTEM SPECIFICATIONS..... | 10 |
| 11.0 | PROBE SPECIFICATION..... | 11 |
| 12.0 | SAM PHANTOM..... | 11 |
| 13.0 | DEVICE HOLDER..... | 11 |
| 14.0 | TEST EQUIPMENT LIST..... | 12 |
| 15.0 | MEASUREMENT UNCERTAINTIES..... | 13 |
| 16.0 | REFERENCES..... | 14 |
| | APPENDIX A - SAR MEASUREMENT DATA..... | 15 |
| | APPENDIX B - SYSTEM CHECK DATA..... | 16 |
| | APPENDIX C - SYSTEM VALIDATION..... | 17 |
| | APPENDIX D - PROBE CALIBRATION..... | 18 |
| | APPENDIX E - MEASURED FLUID DIELECTRIC PARAMETERS..... | 19 |
| | APPENDIX F - SAM PHANTOM CERTIFICATE OF CONFORMITY..... | 20 |
| | APPENDIX G - SAR TEST SETUP PHOTOGRAPHS..... | 21 |

1.0 INTRODUCTION

This measurement report demonstrates that the ITRONIX CORPORATION Model: IX260 Rugged Laptop PC with internal Cisco Systems MPI-350 Mini-PCI DSSS WLAN Card (co-located with Sierra Wireless AirCard 555/550 Dual-Band Cellular/PCS CDMA Modem) FCC ID: KBCIX260AC555-MPI complies with the RF exposure requirements specified in FCC 47 CFR §2.1093 (see reference [1]), and Health Canada Safety Code 6 (see reference [2]) for the General Population environment. The test procedures described in FCC OET Bulletin 65, Supplement C, Edition 01-01 (see reference [3]) and IC RSS-102 Issue 1 (Provisional) (see reference [4]), were employed. A description of the product, operating configuration, detailed summary of the test results, methodology and procedures used in the evaluation, equipment used, and the various provisions of the rules are included within this test report.

2.0 DESCRIPTION of Equipment Under Test (EUT)

| | |
|----------------------------------|---|
| FCC Rule Part(s) | 47 CFR §2.1093 |
| IC Rule Part(s) | IC RSS-102 Issue 1 (Provisional) |
| Test Procedure | FCC OET Bulletin 65, Supplement C (01-01) |
| FCC Device Classification | Digital Transmission System (DTS) |
| IC Device Classification | Low Power License-Exempt Radiocommunication Device |
| Device Type | Rugged Laptop PC with Cisco MPI-350 Mini-PCI DSSS WLAN Card (co-located with Sierra Wireless AirCard 555/550 Dual-Band Cellular/PCS CDMA Modem) |
| FCC ID | KBCIX260AC555-MPI |
| Model(s) | IX260 |
| Serial No. | Pre-production |
| Tx Frequency Range | 2412 - 2462 MHz |
| RF Output Power Tested | 21.2 dBm Peak Conducted (2412 MHz) 21.1 dBm Peak Conducted (2437 MHz) 21.1 dBm Peak Conducted (2462 MHz) |
| Antenna Type | Dual Internal (DSSS WLAN Card) External Dipole (Co-located CDMA Modem) |
| Battery Type | 11.1V Lithium-Ion, 6.0Ah (Model: A2121-2) |

3.0 SAR MEASUREMENT SYSTEM

Celltech Labs SAR measurement facility utilizes the Dosimetric Assessment System (DASY™) manufactured by Schmid & Partner Engineering AG (SPEAG™) of Zurich, Switzerland. The DASY system is comprised of the robot controller, computer, near-field probe, probe alignment sensor, specific anthropomorphic mannequin (SAM) phantom, and various planar phantoms for brain and/or body SAR evaluations. The robot is a six-axis industrial robot performing precise movements to position the probe to the location (points) of maximum electromagnetic field (EMF). A cell controller system contains the power supply, robot controller, teach pendant (Joystick), and remote control, is used to drive the robot motors. The Staubli robot is connected to the cell controller to allow software manipulation of the robot. A data acquisition electronic (DAE) circuit performs the signal amplification, signal multiplexing, AD-conversion, offset measurements, mechanical surface detection, collision detection, etc. is connected to the Electro-optical coupler (EOC). The EOC performs the conversion from the optical into digital electric signal of the DAE and transfers data to the PC plug-in card. The DAE3 utilizes a highly sensitive electrometer-grade preamplifier with auto-zeroing, a channel and gain-switching multiplexer, a fast 16-bit AD-converter and a command decoder and control logic unit. Transmission to the PC-card is accomplished through an optical downlink for data and status information and an optical uplink for commands and clock lines. The mechanical probe-mounting device includes two different sensor systems for frontal and sidewise probe contacts. They are also used for mechanical surface detection and probe collision detection. The robot uses its own controller with a built in VME-bus computer.



DASY3 SAR Measurement System with SAM phantom

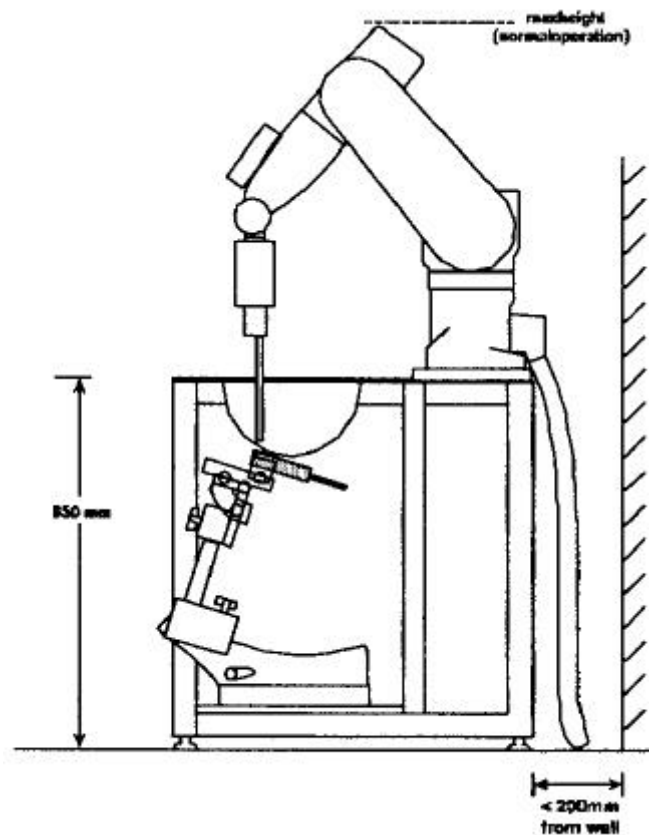

Figure 1. DASY3 Compact Version - Side View

4.0 MEASUREMENT SUMMARY

The measurement results were obtained with the EUT tested in the conditions described in this report. Detailed measurement data and plots showing the maximum SAR location of the EUT are reported in Appendix A.

| BODY SAR MEASUREMENT RESULTS | | | | | | | | | |
|---|---------|----------------|----------------------------|-------|-----------------------------|------------|--------------------------------------|--------------------------|------------------------|
| Freq. (MHz) | Channel | Mode | Peak Conducted Power (dBm) | | Phantom Section | Antenna | Laptop PC Position to Planar Phantom | Separation Distance (cm) | Measured SAR 1g (W/kg) |
| | | | Before | After | | | | | |
| 2437 | Mid | CW | 21.1 | 21.2 | Planar | Left Side | Back of LCD (LCD Closed) | 1.5 | 0.311 |
| 2437 | Mid | CW | 21.1 | 20.9 | Planar | Right Side | Back of LCD (LCD Closed) | 1.5 | 0.397 |
| 2437 | Mid | CW | 21.1 | 21.0 | Planar | Left Side | Bottom of Laptop (LCD Closed) | 0.0 | 0.0128 |
| 2437 | Mid | CW | 21.1 | 20.9 | Planar | Right Side | Bottom of Laptop (LCD Closed) | 0.0 | 0.0201 |
| 2437 | Mid | CW | 21.1 | 21.0 | Planar | Left Side | Left Side of LCD (LCD Open) | 0.0 | 0.0558 |
| 2437 | Mid | CW | 21.1 | 21.0 | Planar | Right Side | Right Side of LCD (LCD Open) | 0.0 | 0.0713 |
| ANSI / IEEE C95.1 1992 - SAFETY LIMIT BODY: 1.6 W/kg (averaged over 1 gram) Spatial Peak - Uncontrolled Exposure / General Population | | | | | | | | | |
| Test Date(s) | | 12/10/02 | | | Relative Humidity | | 52 % | | |
| Measured Mixture Type | | 2450MHz Muscle | | | Atmospheric Pressure | | 101.0 kPa | | |
| Dielectric Constant ϵ_r | | IEEE Target | Measured | | Ambient Temperature | | 23.3 °C | | |
| | | 52.7 ±10% | 47.7 | | Fluid Temperature | | 22.8 °C | | |
| Conductivity σ (mho/m) | | IEEE Target | Measured | | Fluid Depth | | ≥ 15 cm | | |
| | | 1.95 ±5% | 2.01 | | ρ (Kg/m ³) | | 1000 | | |

Note(s):

1. If the SAR measurements performed at the middle channel were ≥ 3 dB below the SAR limit, SAR evaluation for the low and high channels was optional (per FCC OET Bulletin 65, Supplement C, Edition 01-01 (see reference [3])).
2. The ambient and fluid temperatures were measured prior to, and during, the fluid dielectric parameter check and the SAR evaluation. The temperatures listed in the table above were consistent for all measurement periods.

5.0 DETAILS OF SAR EVALUATION

The ITRONIX CORPORATION Model: IX260 Rugged Laptop PC with internal Cisco Systems MPI-350 Mini-PCI DSSS WLAN Card (co-located with Sierra Wireless AirCard 555/550 Dual-Band Cellular/PCS CDMA Modem) FCC ID: KBCIX260AC555-MPI was found to be compliant for localized Specific Absorption Rate based on the following test provisions and conditions described below. The detailed test setup photographs are shown in Appendix G.

1. The EUT was tested for body SAR with the LCD display closed and the back of the LCD display facing parallel to the outer surface of the planar phantom. A 1.5 cm separation distance was maintained between the back of the LCD display and the outer surface of the planar phantom. Both the left and right sides of the back of the LCD display were evaluated due to the dual antenna placement internal to the back of the LCD display.
2. The EUT was tested for body SAR with the LCD display closed and the bottom of the Laptop PC facing parallel to, and touching, the outer surface of the planar phantom. Both the left and right sides of the bottom of the Laptop PC were evaluated due to the dual antenna placement internal to the back of the LCD display.
3. The EUT was tested for body SAR with the LCD display open and the left side of the LCD display facing parallel to, and touching, the outer surface of the planar phantom.
4. The EUT was tested for body SAR with the LCD display open and the right side of the LCD display facing parallel to, and touching, the outer surface of the planar phantom.
5. A 1.3 dB cable offset was entered into the Gigatronics 8652A Universal Power Meter prior to the conducted power measurements. The peak conducted power levels were measured before and after each test according to the procedures described in FCC 47 CFR §2.1046. If the conducted power level measured after each evaluation varied more than 5% from the initial power level, then the EUT was retested. Any unusual anomalies over the course of the test also warranted a re-evaluation.
6. The EUT was controlled via internal software and was tested in unmodulated continuous transmit operation (Continuous Wave mode at 100% duty cycle).
7. The location of the maximum spatial SAR distribution (Hot Spot) was determined relative to the device and its antenna.
8. The EUT was tested with a fully charged battery.
9. Due to the dimensions of the EUT, a stack of low-density, low-loss dielectric foamed polystyrene was used in place of the device holder.

6.0 EVALUATION PROCEDURES

- a. (i) The evaluation was performed in the applicable area of the phantom depending on the type of device being tested. For devices held to the ear during normal operation, both the left and right ear positions were evaluated in accordance with FCC OET Bulletin 65, Supplement C (Edition 01-01) using the SAM phantom.
(ii) For body-worn and face-held devices a planar phantom was used.
- b. The SAR was determined by a pre-defined procedure within the DASY3 software. Upon completion of a reference and optical surface check, the exposed region of the phantom was scanned near the inner surface with a grid spacing of 20mm x 20mm.
- c. Based on the area scan data, the area of maximum absorption was determined by spline interpolation. Around this point, a volume of 40 x 40 x 35 mm (fine resolution volume scan, zoom scan) was assessed by measuring 5 x 5 x 7 points.
- d. The 1g and 10g spatial peak SAR was determined as follows:
 1. The first step was an extrapolation to find the points between the dipole center of the probe and the surface of the phantom. This data cannot be measured, since the center of the dipoles is 2.7 mm away from the tip of the probe and the distance between the surface and the lowest measuring point is 1.3 mm (see probe calibration document in Appendix D). The extrapolation was based on a least square algorithm [W. Gander, Computermathematik, p.168-180] (see reference [6]). Through the points in the first 3 cm in all z-axis, polynomials of the fourth order were calculated. This polynomial was then used to evaluate the points between the surface and the probe tip.
 2. The next step used 3D-spline interpolation to get all points within the measured volume in a 1mm grid (35000 points). The 3D-spline is composed of three one-dimensional splines with the "Not a knot" condition [W. Gander, Computermathematik, p.141-150] (x, y and z -direction) [Numerical Recipes in C, Second Edition, p.123ff] (see reference [6]).
 3. The maximal interpolated value was searched with a straightforward algorithm. Around this maximum the SAR values averaged over the spatial volumes (1g or 10g) were computed using the 3D-spline interpolation algorithm. 8000 points (20x20x20) were interpolated to calculate the average.

EVALUATION PROCEDURES (Cont.)

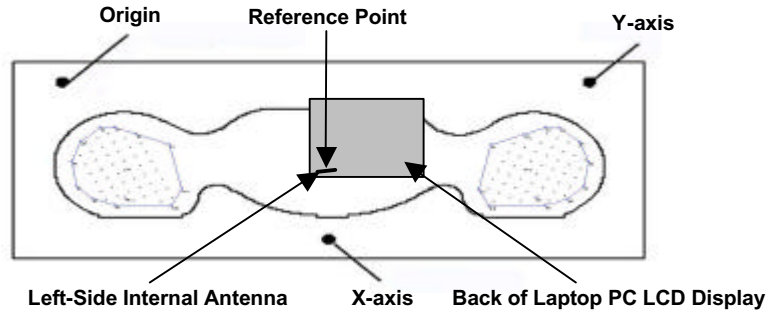

**Figure 2. Phantom Reference Point & EUT Positioning
Back Top Left Side of LCD Display (Closed)- Left-Side Antenna**

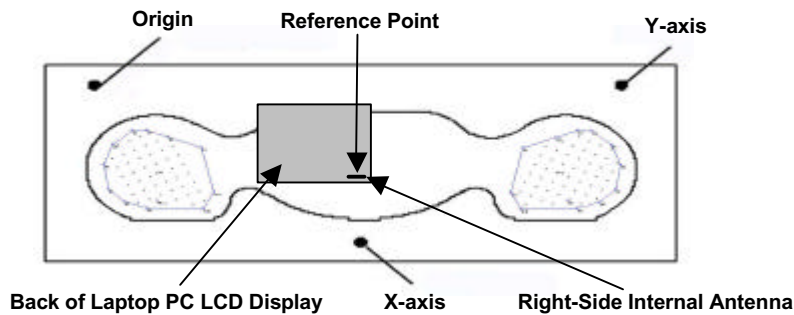

**Figure 3. Phantom Reference Point & EUT Positioning
Back Top Right Side of LCD Display (Closed)- Right-Side Antenna**

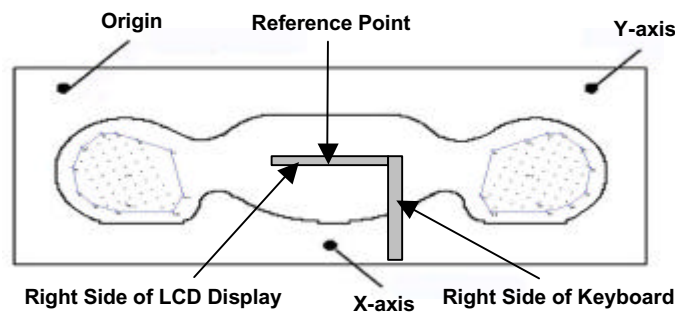

**Figure 4. Phantom Reference Point & EUT Positioning
Right Side of Laptop PC LCD Display (Open) - Right-Side Antenna**

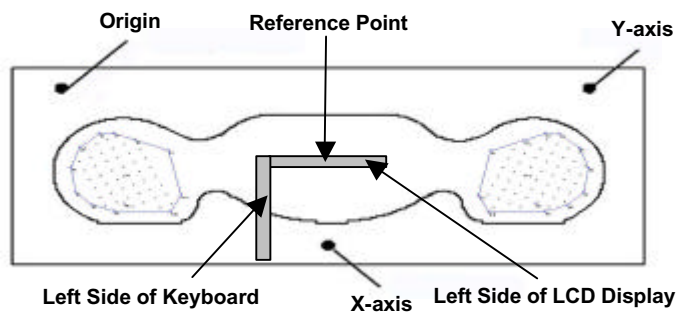

**Figure 5. Phantom Reference Point & EUT Positioning
Left Side of Laptop PC LCD Display (Open) - Left-Side Antenna**

7.0 SYSTEM PERFORMANCE CHECK

Prior to the evaluation a system check was performed in the planar section of the SAM phantom with a 2450MHz dipole (see Appendix C for detailed system validation procedures). The simulated brain fluid was verified using an 85070C Dielectric Probe Kit and an 8753E Network Analyzer (see Appendix E for printout of measured fluid dielectric parameters). A forward power of 250 mW was applied to the dipole and system was verified to a tolerance of $\pm 10\%$ (see Appendix B for system check test plot).

| SYSTEM PERFORMANCE CHECK | | | | | | | | | | | |
|--------------------------|---------------|-----------------|----------|----------------------------------|----------|-------------------------------|----------|-----------------------------|---------------|-------------|--------------|
| Test Date | Equiv. Tissue | SAR 1g (W/kg) | | Dielectric Constant ϵ_r | | Conductivity σ (mho/m) | | ρ (Kg/m ³) | Ambient Temp. | Fluid Temp. | Fluid Depth |
| | | IEEE Target | Measured | IEEE Target | Measured | IEEE Target | Measured | | | | |
| 12/10/02 | 2450MHz Brain | 13.1 $\pm 10\%$ | 13.5 | 39.2 $\pm 10\%$ | 36.4 | 1.80 $\pm 5\%$ | 1.85 | 1000 | 23.5 °C* | 24.0 °C* | ≥ 15 cm |
| | | | | | | | | | 23.3 °C** | 23.8 °C** | |

* Fluid Parameter Check
 ** System Performance Check

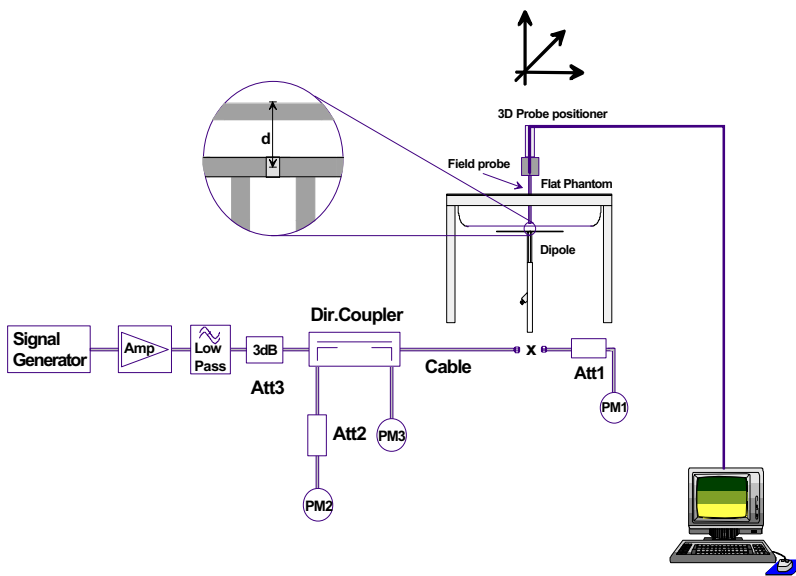

Figure 6. System Check Setup Diagram



2450MHz System Check Setup Photograph

8.0 EQUIVALENT TISSUES

The 2450MHz brain and body simulated tissue mixtures consist of Glycol-monobutyl, water, and salt (body mixture only). The fluid was prepared according to standardized procedures and measured for dielectric parameters (permittivity and conductivity).

| SIMULATED TISSUE MIXTURES | | |
|---------------------------|---------------------------------|----------------------------------|
| INGREDIENT | 2450MHz Brain (System Check) | 2450MHz Body (EUT Evaluation) |
| Water | 55.20 % | 69.95 % |
| Glycol Monobutyl | 44.80 % | 30.00 % |
| Salt | - | 0.05 % |

9.0 SAR SAFETY LIMITS

| EXPOSURE LIMITS | SAR (W/kg) | |
|--|--|--|
| | (General Population / Uncontrolled Exposure Environment) | (Occupational / Controlled Exposure Environment) |
| Spatial Average (averaged over the whole body) | 0.08 | 0.4 |
| Spatial Peak (averaged over any 1 g of tissue) | 1.60 | 8.0 |
| Spatial Peak (hands/wrists/feet/ankles averaged over 10 g) | 4.0 | 20.0 |

Notes:

1. Uncontrolled environments are defined as locations where there is potential exposure of individuals who have no knowledge or control of their potential exposure.
2. Controlled environments are defined as locations where there is potential exposure of individuals who have knowledge of their potential exposure and can exercise control over their exposure.

10.0 ROBOT SYSTEM SPECIFICATIONS

Specifications

POSITIONER: Stäubli Unimation Corp. Robot Model: RX60L
Repeatability: 0.02 mm
No. of axis: 6

Data Acquisition Electronic (DAE) System

Cell Controller

Processor: Pentium III
Clock Speed: 450 MHz
Operating System: Windows NT
Data Card: DASY3 PC-Board

Data Converter

Features: Signal Amplifier, multiplexer, A/D converter, and control logic
Software: DASY3 software
Connecting Lines: Optical downlink for data and status info.
Optical uplink for commands and clock

PC Interface Card

Function: 24 bit (64 MHz) DSP for real time processing
Link to DAE3
16-bit A/D converter for surface detection system
serial link to robot
direct emergency stop output for robot

E-Field Probe

Model: ET3DV6
Serial No.: 1387
Construction: Triangular core fiber optic detection system
Frequency: 10 MHz to 6 GHz
Linearity: ± 0.2 dB (30 MHz to 3 GHz)

Phantom

Type: SAM V4.0C
Shell Material: Fiberglass
Thickness: 2.0 \pm 0.1 mm
Volume: Approx. 20 liters

11.0 PROBE SPECIFICATION (ET3DV6)

| | |
|----------------|--|
| Construction: | Symmetrical design with triangular core Built-in shielding against static charges PEEK enclosure material (resistant to organic solvents, e.g. glycol) |
| Calibration: | In air from 10 MHz to 2.5 GHz In brain simulating tissue at frequencies of 900 MHz and 1.8 GHz (accuracy $\pm 8\%$) |
| Frequency: | 10 MHz to >6 GHz; Linearity: ± 0.2 dB (30 MHz to 3 GHz) |
| Directivity: | ± 0.2 dB in brain tissue (rotation around probe axis) ± 0.4 dB in brain tissue (rotation normal to probe axis) |
| Dynam. Rnge: | 5 μ W/g to >100 mW/g; Linearity: ± 0.2 dB |
| Srfce. Detect. | ± 0.2 mm repeatability in air and clear liquids over diffuse reflecting surfaces |
| Dimensions: | Overall length: 330 mm Tip length: 16 mm Body diameter: 12 mm Tip diameter: 6.8 mm Distance from probe tip to dipole centers: 2.7 mm |
| Application: | General dosimetry up to 3 GHz Compliance tests of mobile phone |



ET3DV6 E-Field Probe

12.0 SAM PHANTOM V4.0C

The SAM phantom V4.0C is a fiberglass shell phantom with a 2.0 mm shell thickness for left and right head and flat planar area integrated in a wooden table. The shape of the fiberglass shell corresponds to the phantom defined by SCC34-SC2. The device holder positions are adjusted to the standard measurement positions in the three sections.



SAM Phantom

13.0 DEVICE HOLDER

The DASY3 device holder has two scales for device rotation (with respect to the body axis) and the device inclination (with respect to the line between the ear openings). The plane between the ear openings and the mouth tip has a rotation angle of 65° . The bottom plate contains three pair of bolts for locking the device holder. The device holder positions are adjusted to the standard measurement positions in the three sections.



Device Holder

14.0 TEST EQUIPMENT LIST

| SAR MEASUREMENT SYSTEM | | |
|---|--|---|
| EQUIPMENT | SERIAL NO. | CALIBRATION DATE |
| DASY3 System -Robot -ET3DV6 E-Field Probe -300MHz Validation Dipole -450MHz Validation Dipole -900MHz Validation Dipole -1800MHz Validation Dipole -2450MHz Validation Dipole -SAM Phantom V4.0C -Small Planar Phantom -Medium Planar Phantom -Large Planar Phantom | 599396-01 1387 135 136 054 247 150 N/A N/A N/A N/A | N/A Feb 2002 Oct 2002 Oct 2002 June 2001 June 2001 Oct 2002 N/A N/A N/A N/A |
| 85070C Dielectric Probe Kit | N/A | N/A |
| Gigatronics 8652A Power Meter -Power Sensor 80701A -Power Sensor 80701A | 1835272 1833535 1833542 | Feb 2002 Feb 2002 Mar 2002 |
| E4408B Spectrum Analyzer | US39240170 | Nov 2002 |
| 8594E Spectrum Analyzer | 3543A02721 | Feb 2002 |
| 8753E Network Analyzer | US38433013 | Feb 2002 |
| 8648D Signal Generator | 3847A00611 | Feb 2002 |
| 5S1G4 Amplifier Research Power Amplifier | 26235 | N/A |

15.0 MEASUREMENT UNCERTAINTIES

| Error Description | Uncertainty Value ±% | Probability Distribution | Divisor | C _i 1g | Standard Uncertainty ±% (1g) | v _i or v _{eff} |
|--------------------------------------|-------------------------|--------------------------|---------|----------------------|---------------------------------|------------------------------------|
| Measurement System | | | | | | |
| Probe calibration | ± 4.8 | Normal | 1 | 1 | ± 4.8 | ∞ |
| Axial isotropy of the probe | ± 4.7 | Rectangular | √3 | (1-c _p) | ± 1.9 | ∞ |
| Spherical isotropy of the probe | ± 9.6 | Rectangular | √3 | (c _p) | ± 3.9 | ∞ |
| Spatial resolution | ± 0.0 | Rectangular | √3 | 1 | ± 0.0 | ∞ |
| Boundary effects | ± 5.5 | Rectangular | √3 | 1 | ± 3.2 | ∞ |
| Probe linearity | ± 4.7 | Rectangular | √3 | 1 | ± 2.7 | ∞ |
| Detection limit | ± 1.0 | Rectangular | √3 | 1 | ± 0.6 | ∞ |
| Readout electronics | ± 1.0 | Normal | 1 | 1 | ± 1.0 | ∞ |
| Response time | ± 0.8 | Rectangular | √3 | 1 | ± 0.5 | ∞ |
| Integration time | ± 1.4 | Rectangular | √3 | 1 | ± 0.8 | ∞ |
| RF ambient conditions | ± 3.0 | Rectangular | √3 | 1 | ± 1.7 | ∞ |
| Mech. constraints of robot | ± 0.4 | Rectangular | √3 | 1 | ± 0.2 | ∞ |
| Probe positioning | ± 2.9 | Rectangular | √3 | 1 | ± 1.7 | ∞ |
| Extrapolation & integration | ± 3.9 | Rectangular | √3 | 1 | ± 2.3 | ∞ |
| Test Sample Related | | | | | | |
| Device positioning | ± 6.0 | Normal | √3 | 1 | ± 6.7 | 12 |
| Device holder uncertainty | ± 5.0 | Normal | √3 | 1 | ± 5.9 | 8 |
| Power drift | ± 5.0 | Rectangular | √3 | | ± 2.9 | ∞ |
| Phantom and Setup | | | | | | |
| Phantom uncertainty | ± 4.0 | Rectangular | √3 | 1 | ± 2.3 | ∞ |
| Liquid conductivity (target) | ± 5.0 | Rectangular | √3 | 0.6 | ± 1.7 | ∞ |
| Liquid conductivity (measured) | ± 5.0 | Rectangular | √3 | 0.6 | ± 1.7 | ∞ |
| Liquid permittivity (target) | ± 10.0 | Rectangular | √3 | 0.6 | ± 3.5 | ∞ |
| Liquid permittivity (measured) | ± 10.0 | Rectangular | √3 | 0.6 | ± 3.5 | ∞ |
| Combined Standard Uncertainty | | | | | ± 13.7 | |
| Expanded Uncertainty (k=2) | | | | | ± 27.5 | |

Measurement Uncertainty Table in accordance with IEEE Std 1528 (Draft - see reference [5])

16.0 REFERENCES

- [1] Federal Communications Commission, "Radiofrequency radiation exposure evaluation: portable devices", Rule Part 47 CFR §2.1093: 1999.
- [2] Health Canada, "Limits of Human Exposure to Radiofrequency Electromagnetic Fields in the Frequency Range from 3 kHz to 300 GHz", Safety Code 6.
- [3] Federal Communications Commission, "Evaluating Compliance with FCC Guidelines for Human Exposure to Radio frequency Electromagnetic Fields", OET Bulletin 65, Supplement C (Edition 01-01), FCC, Washington, D.C.: June 2001.
- [4] Industry Canada, "Evaluation Procedure for Mobile and Portable Radio Transmitters with respect to Health Canada's Safety Code 6 for Exposure of Humans to Radio Frequency Fields", Radio Standards Specification RSS-102 Issue 1 (Provisional): September 1999.
- [5] IEEE Standards Coordinating Committee 34, Std 1528-200X, "DRAFT Recommended Practice for Determining the Spatial-Peak Specific Absorption Rate (SAR) in the Human Body Due to Wireless Communications Devices: Experimental Techniques".
- [6] W. Gander, *Computermathematick*, Birkhaeuser, Basel: 1992.

APPENDIX B - SYSTEM CHECK DATA

System Performance Check - 2450MHz Dipole

SAM Phantom; Flat Section

Probe: ET3DV6 - SNI1387; ConvF(4.70,4.70,4.70); Crest factor: 1.0; 2450 MHz Brain: $\sigma = 1.85 \text{ mho/m}$ $\epsilon_r = 36.4 \rho = 1.00 \text{ g/cm}^3$

Cube 5x5x7; Peak: 28.7 mW/g, SAR (1g): 13.5 mW/g, SAR (10g): 6.14 mW/g, (Worst-case extrapolation)

Penetration depth: 6.3 (6.1, 7.1) [mm]; Powerdrift: -0.15 dB

Ambient Temp: 23.3°C; Fluid Temp: 23.8°C

Forward Conducted Power: 250 mW

Test Date: December 10, 2002

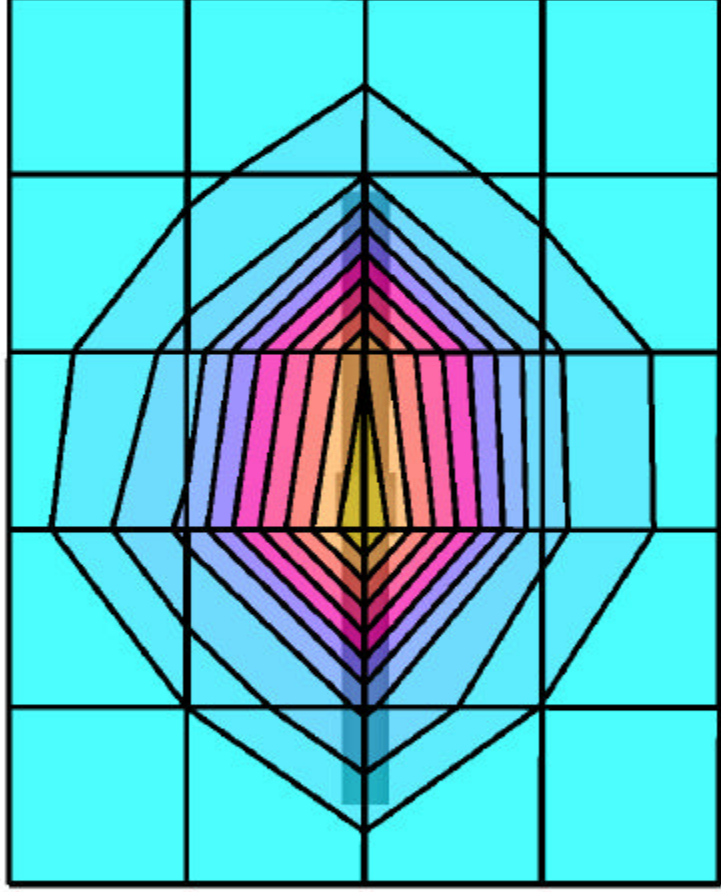
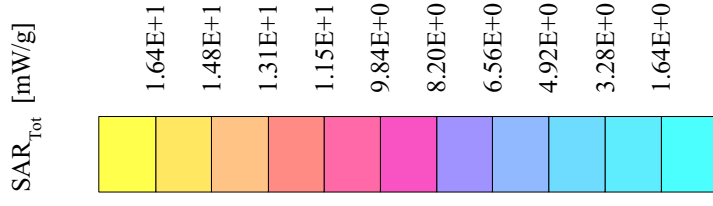

APPENDIX C - SYSTEM VALIDATION

2450MHz SYSTEM VALIDATION DIPOLE

Type:

2450MHz Validation Dipole

Serial Number:

150

Place of Calibration:

Celltech Research Inc.

Date of Calibration:

October 24, 2002

Celltech Research Inc. hereby certifies that this device has been calibrated on the date indicated above.

Calibrated by:

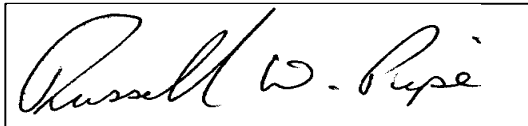

Approved by:

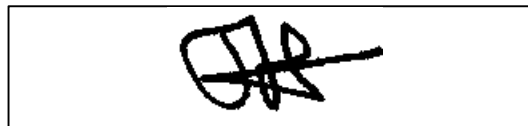

1. Dipole Construction & Electrical Characteristics

The validation dipole was constructed in accordance with the IEEE Std "Recommended Practice for Determining the Spatial-Peak Specific Absorption Rate (SAR) in the Human Body Due to Wireless Communications Devices: Experimental Techniques". The electrical properties were measured using an HP 8753E Network Analyzer. The network analyzer was calibrated to the validation dipole N-type connector feed point using an HP85032E Type N calibration kit. The dipole was placed parallel to a planar phantom at a separation distance of 10.0mm from the simulating fluid using a loss-less dielectric spacer. The measured input impedance is:

| | |
|---------------------------------|--|
| Feed point impedance at 2450MHz | $\text{Re}\{Z\} = 49.838\Omega$ $\text{Im}\{Z\} = 0.2207\Omega$ |
| Return Loss at 2450MHz | -49.398 dB |

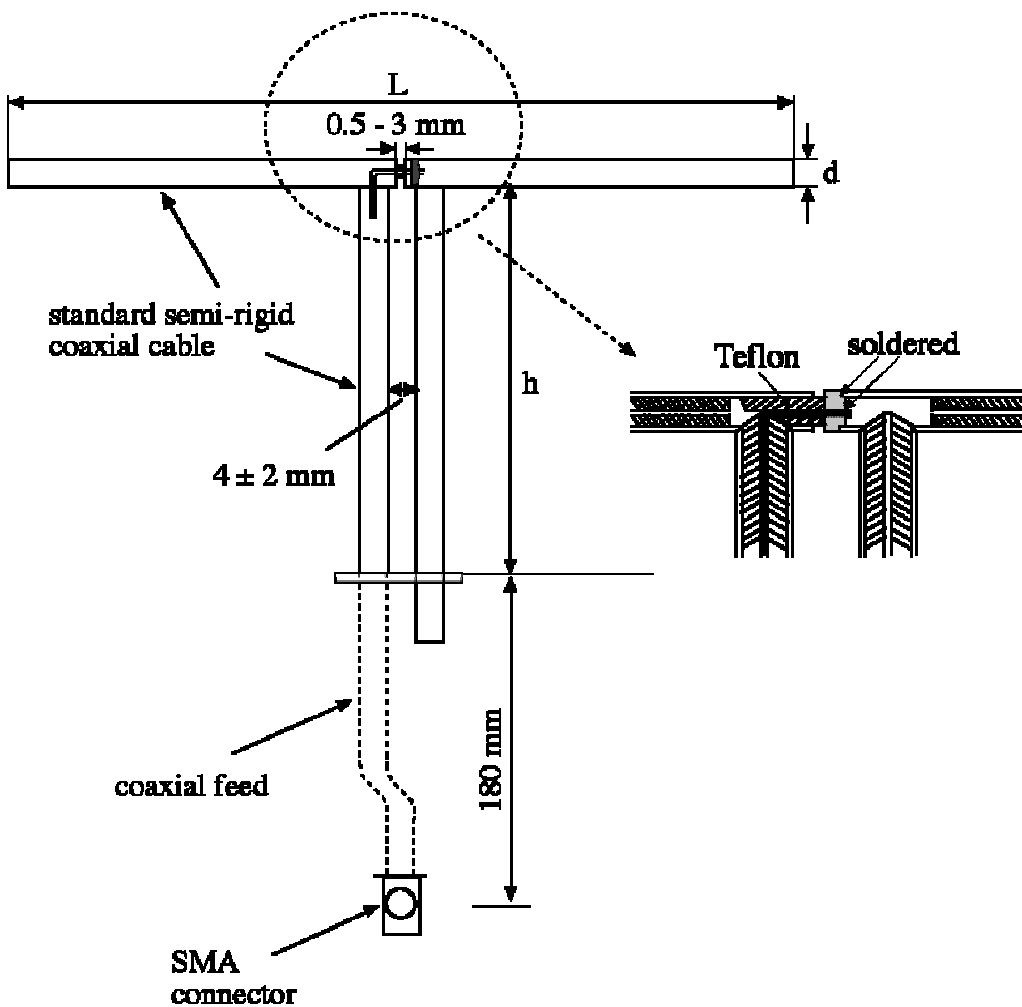

Validation Dipole Dimensions

| Frequency (MHz) | L (mm) | h (mm) | d (mm) |
|-----------------|--------|--------|--------|
| 300 | 420.0 | 250.0 | 6.2 |
| 450 | 288.0 | 167.0 | 6.2 |
| 835 | 161.0 | 89.8 | 3.6 |
| 900 | 149.0 | 83.3 | 3.6 |
| 1450 | 89.1 | 51.7 | 3.6 |
| 1800 | 72.0 | 41.7 | 3.6 |
| 1900 | 68.0 | 39.5 | 3.6 |
| 2000 | 64.5 | 37.5 | 3.6 |
| 2450 | 51.8 | 30.6 | 3.6 |
| 3000 | 41.5 | 25.0 | 3.6 |

2. Validation Phantom

The validation phantom is the SAM (Specific Anthropomorphic Mannequin) phantom manufactured by Schmid & Partner Engineering AG. The SAM phantom is a Fiberglass shell integrated in a wooden table. The shape of the shell corresponds to the phantom defined by SCC34-SC2. It enables the dosimetric evaluation of left and right hand phone usage as well as body mounted usage at the flat phantom region. A cover prevents evaporation of the liquid. Reference markings on the phantom allow the complete setup of all predefined phantom positions and measurement grids by manually teaching three points in the robot.

Shell Thickness: 2.0 ± 0.1 mm
Filling Volume: Approx. 20 liters
Dimensions: 50 cm (W) x 100 cm (L)

SAM Twin-Phantom

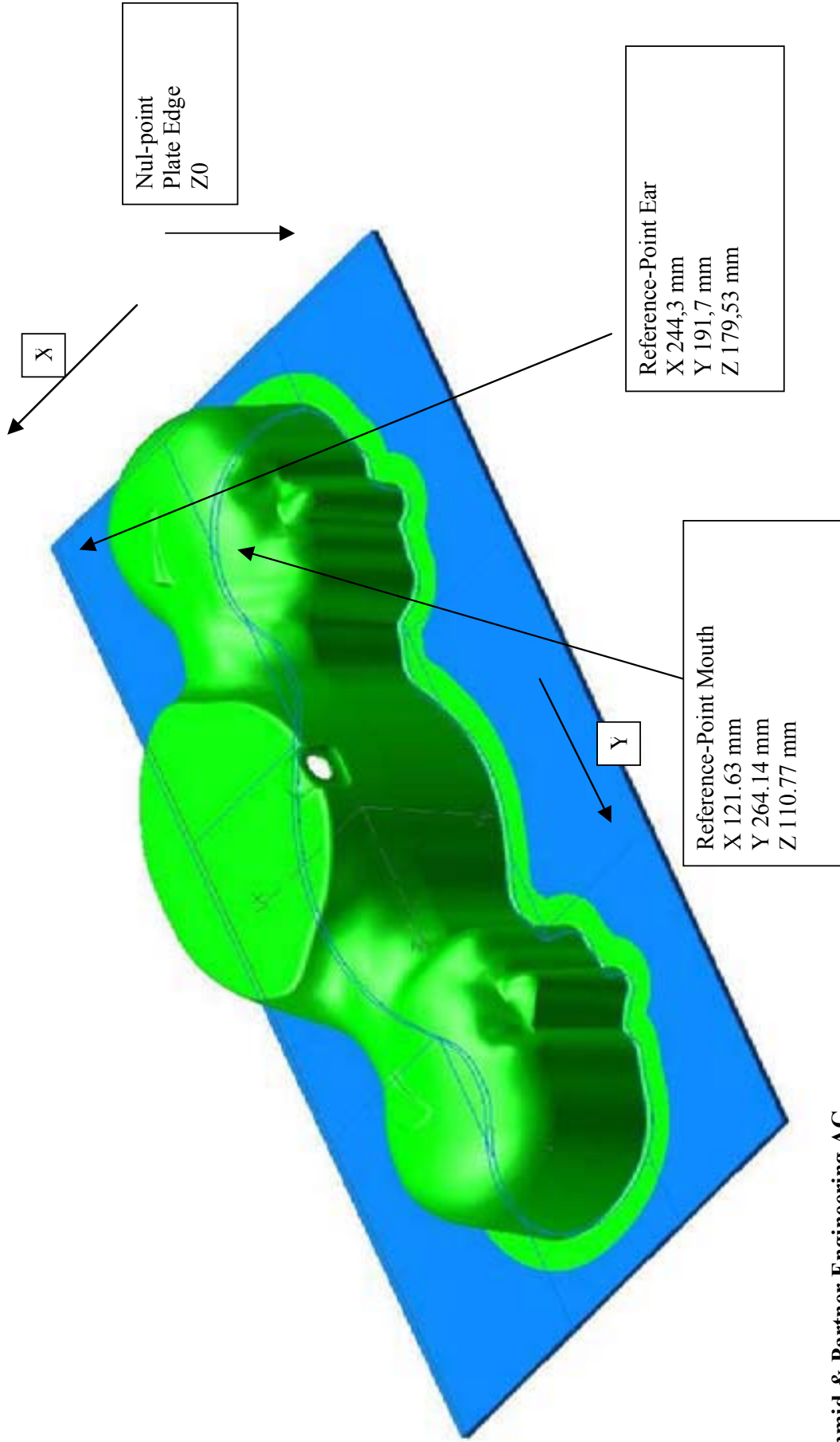

2450MHz Dipole Calibration



2450MHz Dipole Calibration



3. Measurement Conditions

The planar phantom was filled with brain simulating tissue having the following electrical parameters at 2450MHz:

| | |
|------------------------|------------|
| Relative Permittivity: | 36.8 |
| Conductivity: | 1.79 mho/m |
| Ambient Temperature: | 23.6°C |
| Fluid Temperature: | 23.8°C |
| Fluid Depth: | ≥ 15cm |

The 2450MHz simulating tissue consists of the following ingredients:

| Ingredient | Percentage by weight |
|---|---|
| Water | 55.20% |
| Glycol Monobutyl | 44.80% |
| Target Dielectric Parameters at 22°C | $\epsilon_r = 39.2$ (+/-10%) $\sigma = 1.80$ S/m (+/-5%) |

4. SAR Measurement

The SAR measurement was performed with the E-field probe in mechanical detection mode only. The setup and determination of the forward power into the dipole was performed using the following procedures.

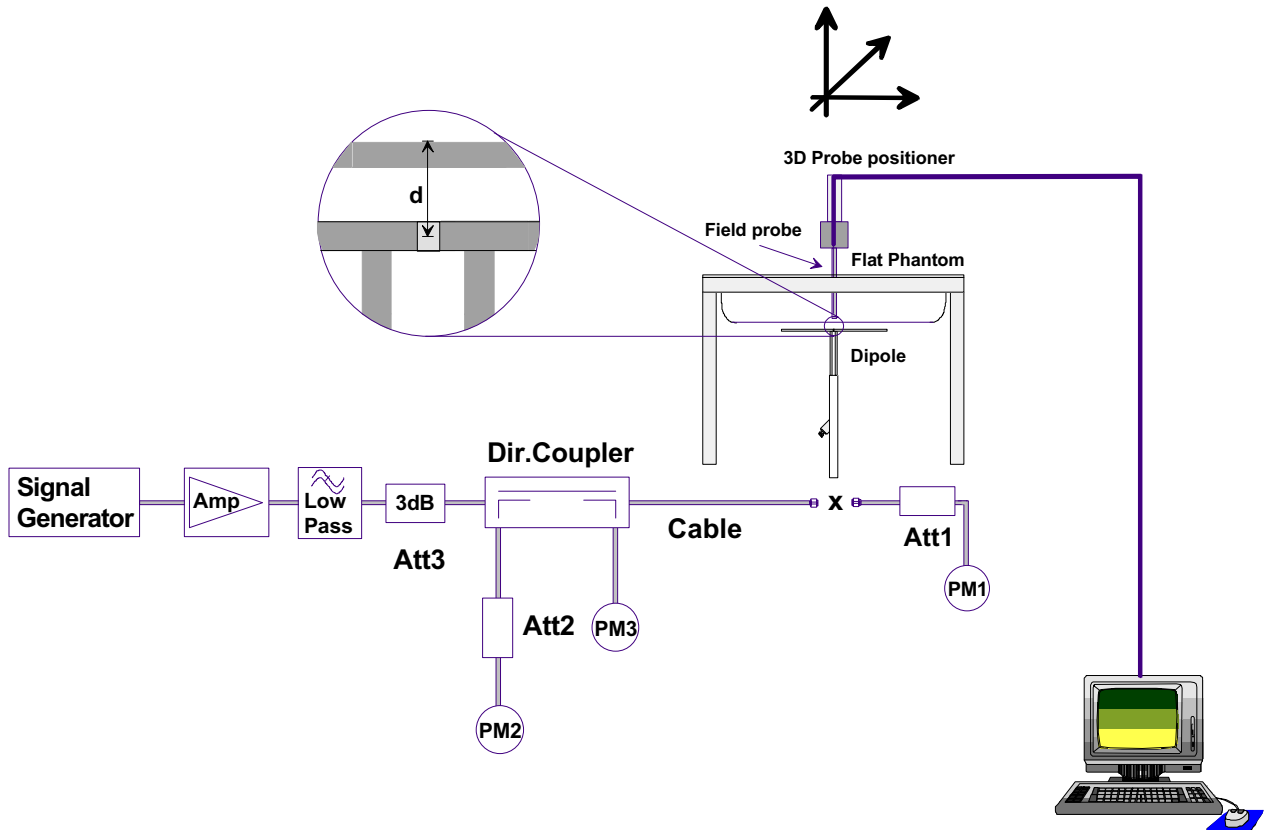

First, the power meter PM1 (including attenuator Att1) is connected to the cable to measure the forward power at the location of the dipole connector (X). The signal generator is adjusted for the desired forward power at the dipole connector (taking into account the attenuation of Att1) as read by power meter PM2. After connecting the cable to the dipole, the signal generator is readjusted for the same reading at power meter PM2. If the signal generator does not allow adjustment in 0.01dB steps, the remaining difference at PM2 must be taken into consideration. PM3 records the reflected power from the dipole to ensure that the value is not changed from the previous value. The reflected power should be 20dB below the forward power.

Ten SAR measurements were performed in order to achieve repeatability and to establish an average target value.

Validation Dipole SAR Test Results

| Validation Measurement | SAR @ 0.25W Input averaged over 1g | SAR @ 1W Input averaged over 1g | SAR @ 0.25W Input averaged over 10g | SAR @ 1W Input averaged over 10g | Peak SAR @ 0.25W Input |
|------------------------|------------------------------------|---------------------------------|-------------------------------------|----------------------------------|------------------------|
| Test 1 | 14.4 | 57.6 | 6.55 | 26.20 | 30.5 |
| Test 2 | 14.2 | 56.8 | 6.44 | 25.76 | 30.0 |
| Test 3 | 14.0 | 56.0 | 6.35 | 25.40 | 29.7 |
| Test 4 | 13.9 | 55.6 | 6.32 | 25.28 | 29.5 |
| Test 5 | 14.0 | 56.0 | 6.33 | 25.32 | 29.7 |
| Test 6 | 14.0 | 56.0 | 6.33 | 25.32 | 29.7 |
| Test 7 | 13.9 | 55.6 | 6.31 | 25.24 | 29.5 |
| Test 8 | 13.8 | 55.2 | 6.28 | 25.12 | 29.3 |
| Test 9 | 13.8 | 55.2 | 6.28 | 25.12 | 29.4 |
| Test10 | 14.0 | 56.0 | 6.33 | 25.32 | 29.7 |
| Average Value | 14.0 | 56.0 | 6.35 | 25.41 | 29.7 |

The results have been normalized to 1W (forward power) into the dipole.

Averaged over 1cm (1g) of tissue: 56.00 mW/g

Averaged over 10cm (10g) of tissue: 25.41 mW/g

24 Oct 2002 09:28:50

CH1 S11 1 U FS 1: 49.838 Ω 0.2207 Ω 14.337 pH 2 450.000 000 MHz

PRm

MARKER 1
2.45 GHz

Cor

↑

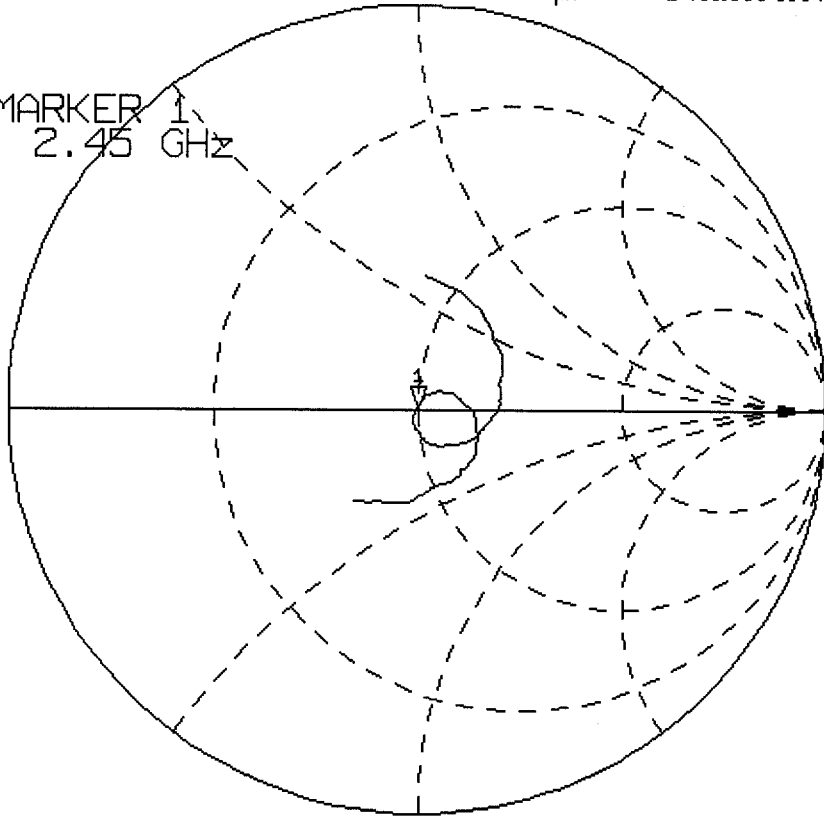

START 2 250.000 000 MHz

STOP 2 650.000 000 MHz

24 Oct 2002 09:28:12

CH1 S11 LOG 10 dB/REF 0 dB 11-49.398 dB 2 450.000 000 MHz

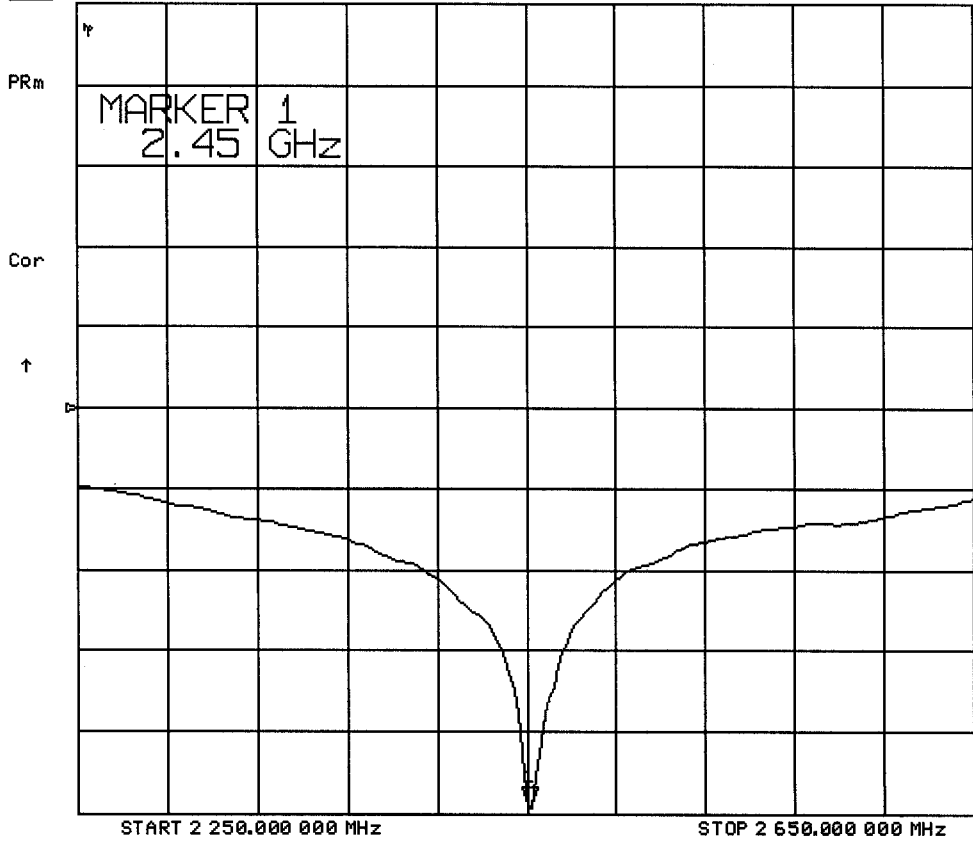

Dipole 2450MHz

SAM Phantom; Flat Section

Probe: ET3DV6 - SNI387; ConvF(4.70,4.70,4.70); Crest factor: 1.0; 2450 MHz Brain: $\sigma = 1.79 \text{ mho/m}$ $\epsilon_r = 36.8 \rho = 1.00 \text{ g/cm}^3$

Cubes (4): Peak: 29.7 mW/g $\pm 0.04 \text{ dB}$, SAR (1g): 14.0 mW/g $\pm 0.04 \text{ dB}$, SAR (10g): 6.35 mW/g $\pm 0.04 \text{ dB}$, (Worst-case extrapolation)

Penetration depth: 6.4 (6.1, 7.2) [mm]; Powerdrift: -0.04 dB

Ambient Temp.: 23.6°C; Fluid Temp.: 23.8°C

Forward Conducted Power: 250 mW

Calibration Date: October 24, 2002

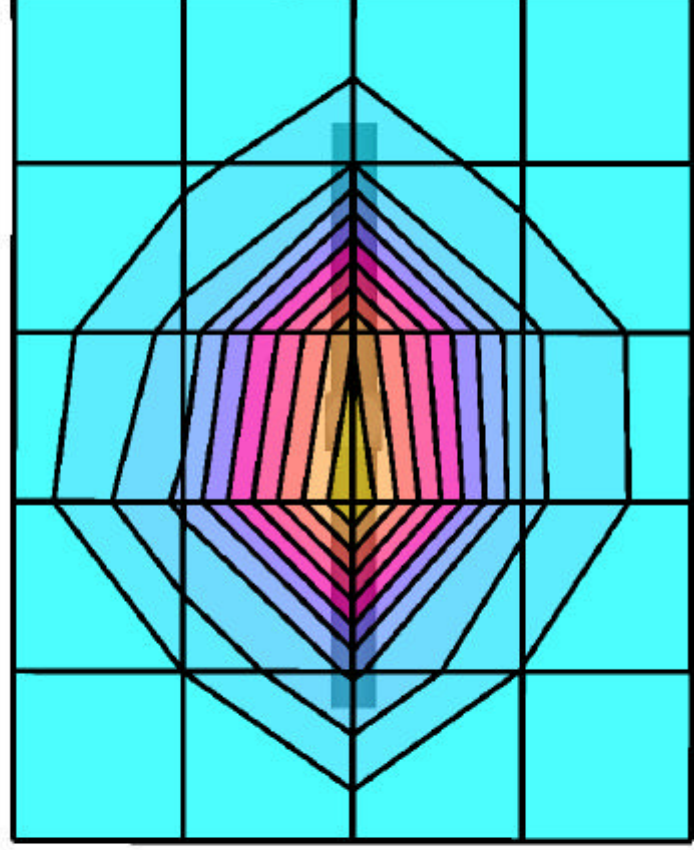

SAR_{tot} [mW/g]



2450MHz System Validation

Measured Fluid Dielectric Parameters (Brain)

October 24, 2002

| Frequency | ϵ' | ϵ'' |
|-----------------|-------------|--------------|
| 2.350000000 GHz | 37.2108 | 12.9039 |
| 2.360000000 GHz | 37.1695 | 12.9350 |
| 2.370000000 GHz | 37.1398 | 12.9630 |
| 2.380000000 GHz | 37.1057 | 12.9945 |
| 2.390000000 GHz | 37.0746 | 13.0290 |
| 2.400000000 GHz | 37.0424 | 13.0464 |
| 2.410000000 GHz | 36.9746 | 13.0743 |
| 2.420000000 GHz | 36.9322 | 13.1074 |
| 2.430000000 GHz | 36.8908 | 13.1372 |
| 2.440000000 GHz | 36.8449 | 13.1527 |
| 2.450000000 GHz | 36.7983 | 13.1767 |
| 2.460000000 GHz | 36.7651 | 13.2038 |
| 2.470000000 GHz | 36.7300 | 13.2377 |
| 2.480000000 GHz | 36.7004 | 13.2677 |
| 2.490000000 GHz | 36.6658 | 13.2862 |
| 2.500000000 GHz | 36.6120 | 13.2988 |
| 2.510000000 GHz | 36.5655 | 13.3268 |
| 2.520000000 GHz | 36.5147 | 13.3582 |
| 2.530000000 GHz | 36.4743 | 13.3922 |
| 2.540000000 GHz | 36.4044 | 13.4131 |
| 2.550000000 GHz | 36.3807 | 13.4402 |

APPENDIX D - PROBE CALIBRATION

Schmid & Partner Engineering AG

Zeughausstrasse 43, 8004 Zurich, Switzerland, Phone +41 1 245 97 00, Fax +41 1 245 97 79

Calibration Certificate

Dosimetric E-Field Probe

Type:

ET3DV6

Serial Number:

1387

Place of Calibration:

Zurich

Date of Calibration:

February 22, 2002

Calibration Interval:

12 months

Schmid & Partner Engineering AG hereby certifies, that this device has been calibrated on the date indicated above. The calibration was performed in accordance with specifications and procedures of Schmid & Partner Engineering AG.

Wherever applicable, the standards used in the calibration process are traceable to international standards. In all other cases the standards of the Laboratory for EMF and Microwave Electronics at the Swiss Federal Institute of Technology (ETH) in Zurich, Switzerland have been applied.

Calibrated by:

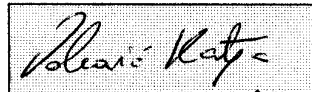

Approved by:



Probe ET3DV6

SN:1387

| | |
|-------------------|--------------------|
| Manufactured: | September 21, 1999 |
| Last calibration: | September 22, 1999 |
| Recalibrated: | February 22, 2002 |

Calibrated for System DASY3

DASY3 - Parameters of Probe: ET3DV6 SN:1387

Sensitivity in Free Space

| | |
|-------|---|
| NormX | 1.58 $\mu\text{V}/(\text{V}/\text{m})^2$ |
| NormY | 1.67 $\mu\text{V}/(\text{V}/\text{m})^2$ |
| NormZ | 1.67 $\mu\text{V}/(\text{V}/\text{m})^2$ |

Diode Compression

| | | |
|-------|-----------|----|
| DCP X | 97 | mV |
| DCP Y | 97 | mV |
| DCP Z | 97 | mV |

Sensitivity in Tissue Simulating Liquid

| | | | |
|---------|------------------------------|-----------------------------|-------------------------------|
| Head | 900 MHz | $\epsilon_r = 41.5 \pm 5\%$ | $\sigma = 0.97 \pm 5\%$ mho/m |
| Head | 835 MHz | $\epsilon_r = 41.5 \pm 5\%$ | $\sigma = 0.90 \pm 5\%$ mho/m |
| ConvF X | 6.6 $\pm 9.5\%$ (k=2) | | Boundary effect: |
| ConvF Y | 6.6 $\pm 9.5\%$ (k=2) | | Alpha 0.40 |
| ConvF Z | 6.6 $\pm 9.5\%$ (k=2) | | Depth 2.38 |
| Head | 1800 MHz | $\epsilon_r = 40.0 \pm 5\%$ | $\sigma = 1.40 \pm 5\%$ mho/m |
| Head | 1900 MHz | $\epsilon_r = 40.0 \pm 5\%$ | $\sigma = 1.40 \pm 5\%$ mho/m |
| ConvF X | 5.4 $\pm 9.5\%$ (k=2) | | Boundary effect: |
| ConvF Y | 5.4 $\pm 9.5\%$ (k=2) | | Alpha 0.57 |
| ConvF Z | 5.4 $\pm 9.5\%$ (k=2) | | Depth 2.18 |

Boundary Effect

| | | | |
|------|--|--|-------------|
| Head | 900 MHz | Typical SAR gradient: 5 % per mm | |
| | Probe Tip to Boundary | 1 mm | 2 mm |
| | SAR _{be} [%] Without Correction Algorithm | 9.7 | 5.4 |
| | SAR _{be} [%] With Correction Algorithm | 0.3 | 0.6 |
| Head | 1800 MHz | Typical SAR gradient: 10 % per mm | |
| | Probe Tip to Boundary | 1 mm | 2 mm |
| | SAR _{be} [%] Without Correction Algorithm | 11.5 | 7.3 |
| | SAR _{be} [%] With Correction Algorithm | 0.1 | 0.3 |

Sensor Offset

| | | |
|----------------------------|---------------------------------|----|
| Probe Tip to Sensor Center | 2.7 | mm |
| Optical Surface Detection | 1.3 \pm 0.2 | mm |

Receiving Pattern (ϕ , $\theta = 0^\circ$)

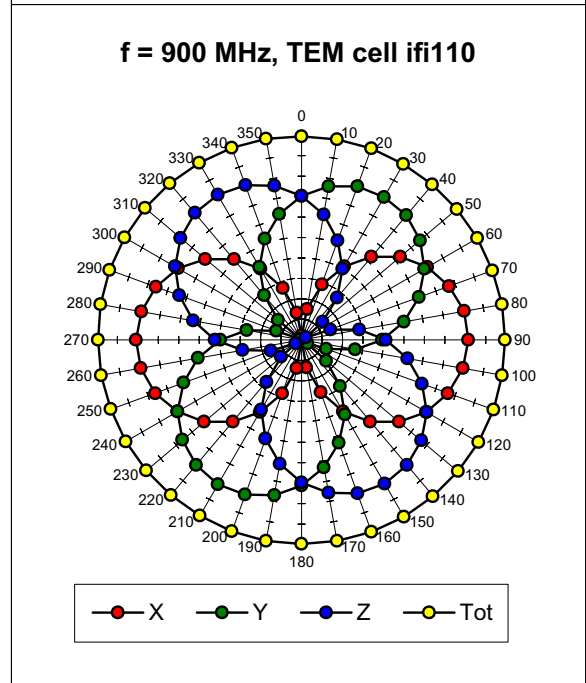
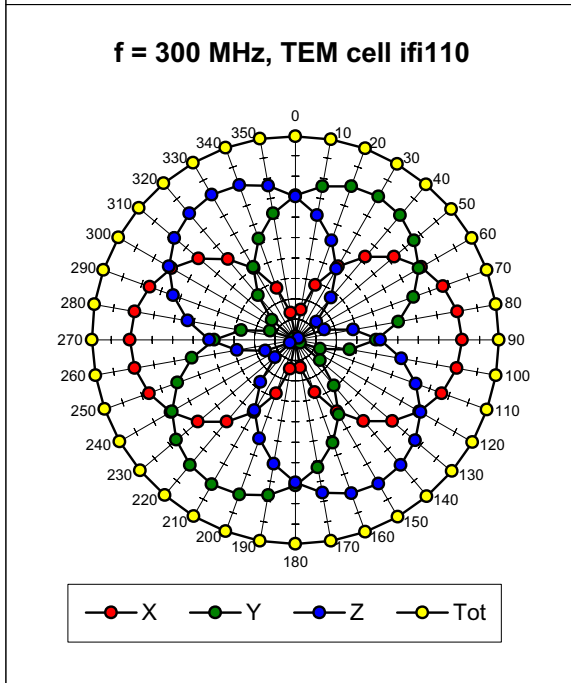
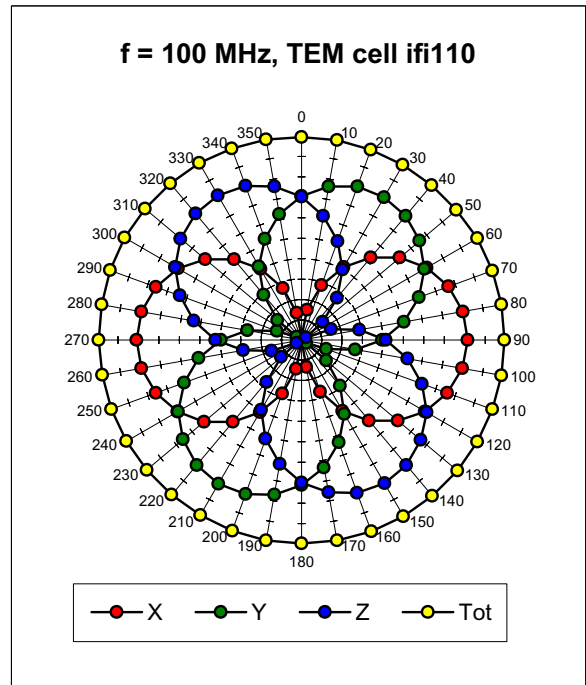
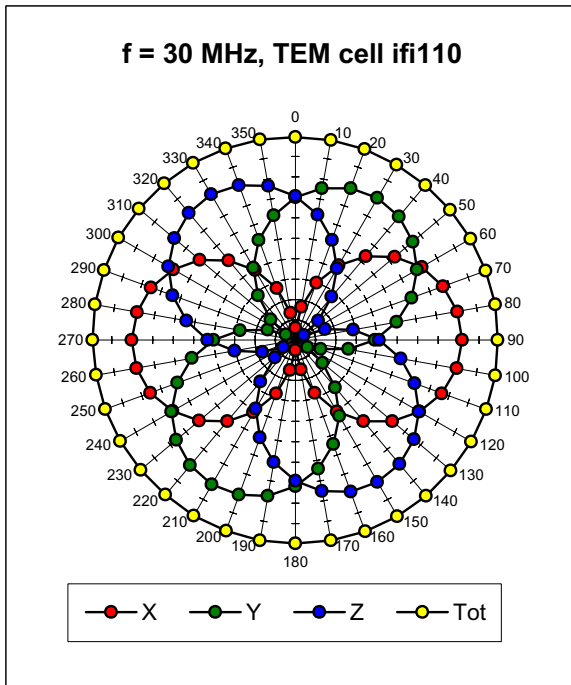

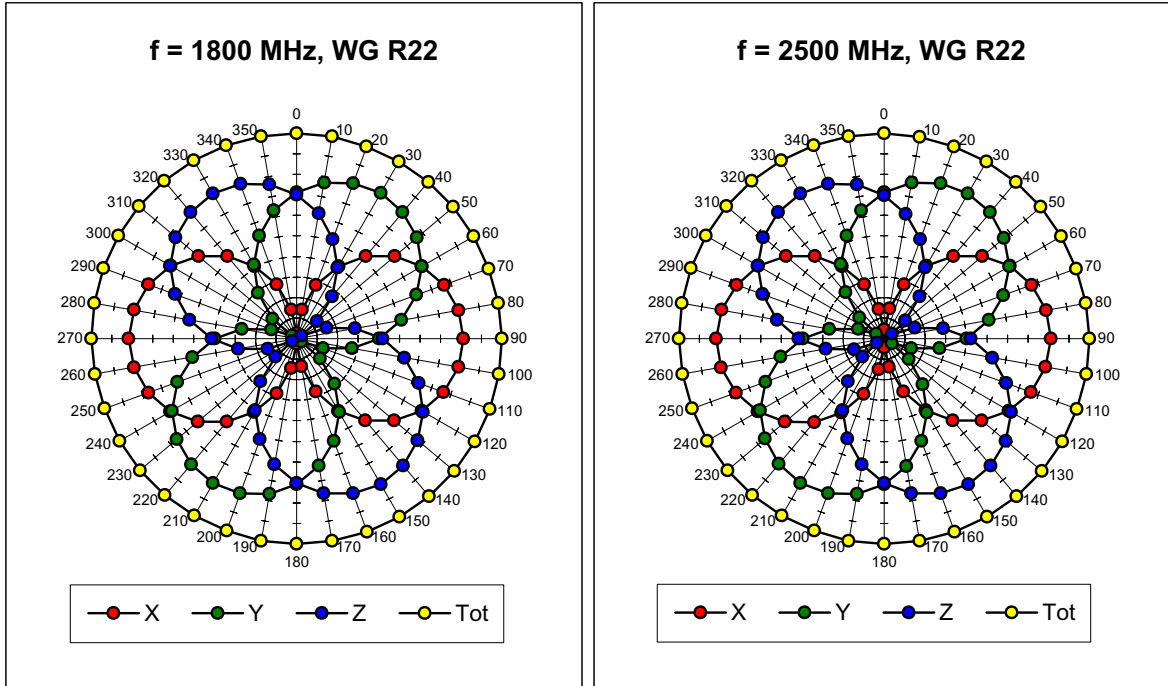

Isotropy Error (ϕ), $\theta = 0^\circ$

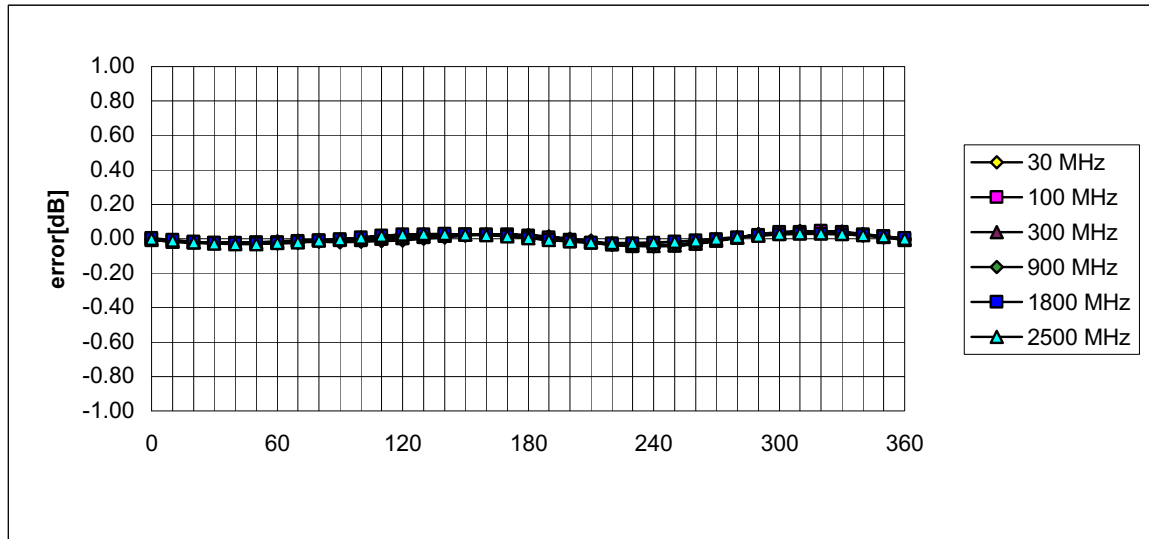

Frequency Response of E-Field

(TEM-Cell:ifi110, Waveguide R22)

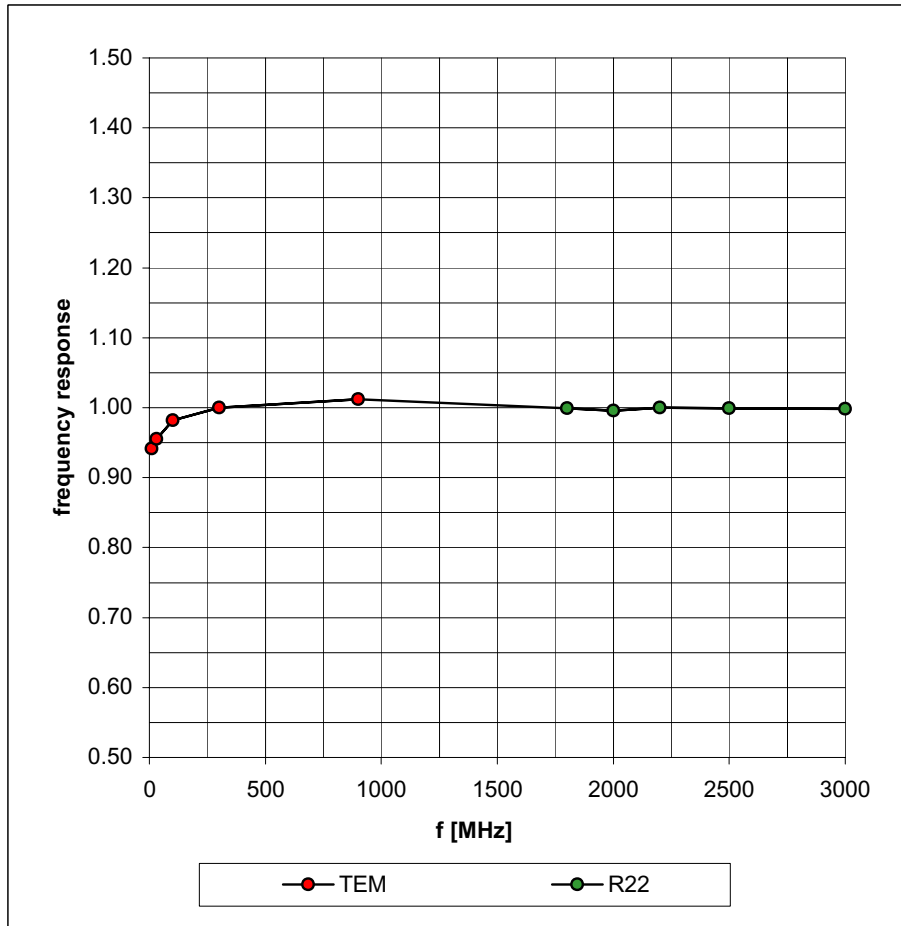

Dynamic Range f(SAR_{brain}) (Waveguide R22)

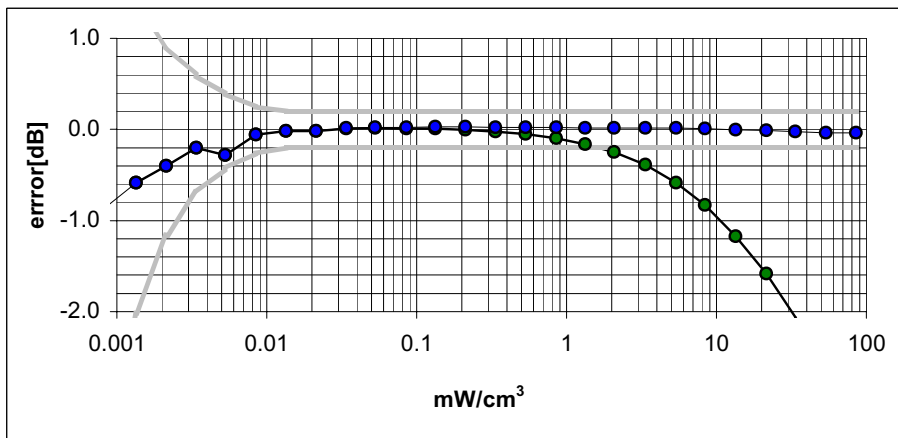
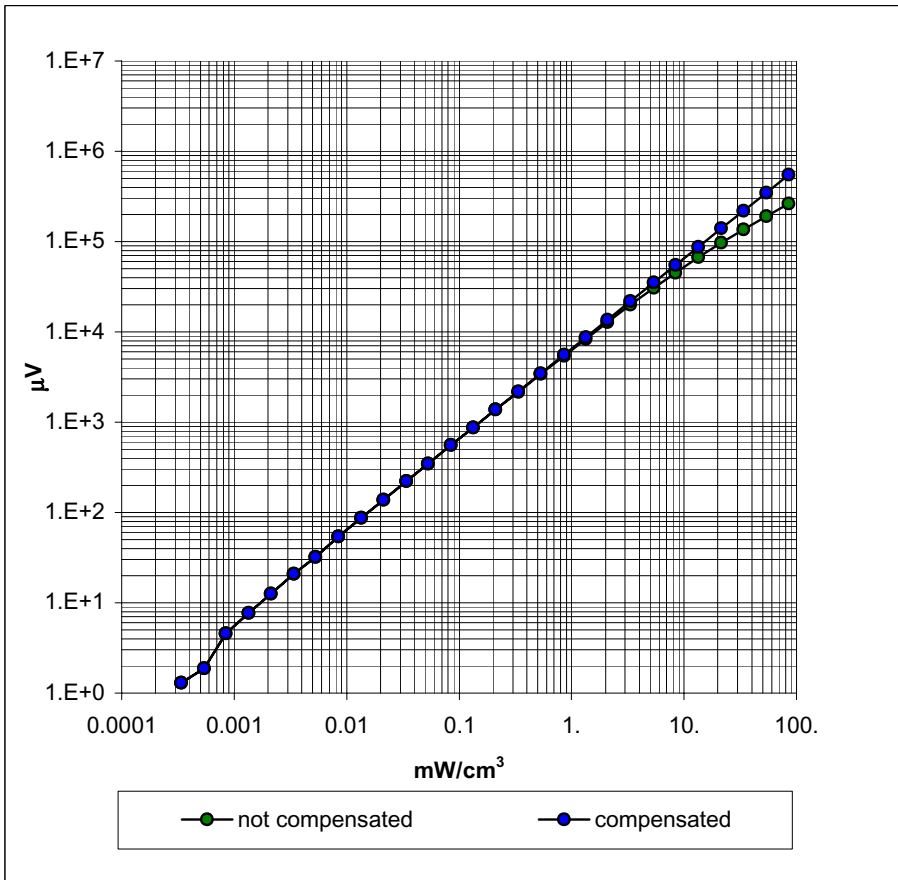

Conversion Factor Assessment

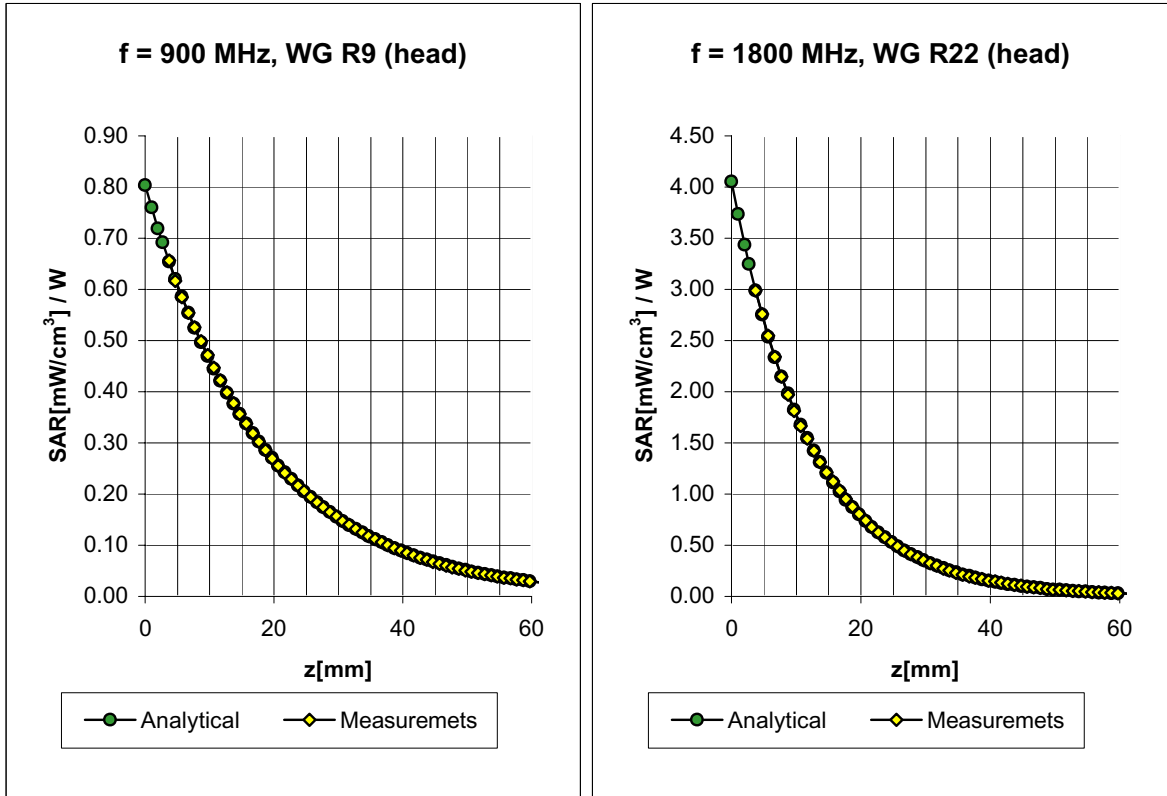

| | | | |
|------|----------|------------------------------|---------------------------------------|
| Head | 900 MHz | $\epsilon_r = 41.5 \pm 5\%$ | $\sigma = 0.97 \pm 5\% \text{ mho/m}$ |
| Head | 835 MHz | $\epsilon_r = 41.5 \pm 5\%$ | $\sigma = 0.90 \pm 5\% \text{ mho/m}$ |
| | ConvF X | 6.6 $\pm 9.5\%$ (k=2) | Boundary effect: |
| | ConvF Y | 6.6 $\pm 9.5\%$ (k=2) | Alpha 0.40 |
| | ConvF Z | 6.6 $\pm 9.5\%$ (k=2) | Depth 2.38 |
| Head | 1800 MHz | $\epsilon_r = 40.0 \pm 5\%$ | $\sigma = 1.40 \pm 5\% \text{ mho/m}$ |
| Head | 1900 MHz | $\epsilon_r = 40.0 \pm 5\%$ | $\sigma = 1.40 \pm 5\% \text{ mho/m}$ |
| | ConvF X | 5.4 $\pm 9.5\%$ (k=2) | Boundary effect: |
| | ConvF Y | 5.4 $\pm 9.5\%$ (k=2) | Alpha 0.57 |
| | ConvF Z | 5.4 $\pm 9.5\%$ (k=2) | Depth 2.18 |

ET3DV6 SN:1387

February 22, 2002

Conversion Factor Assessment

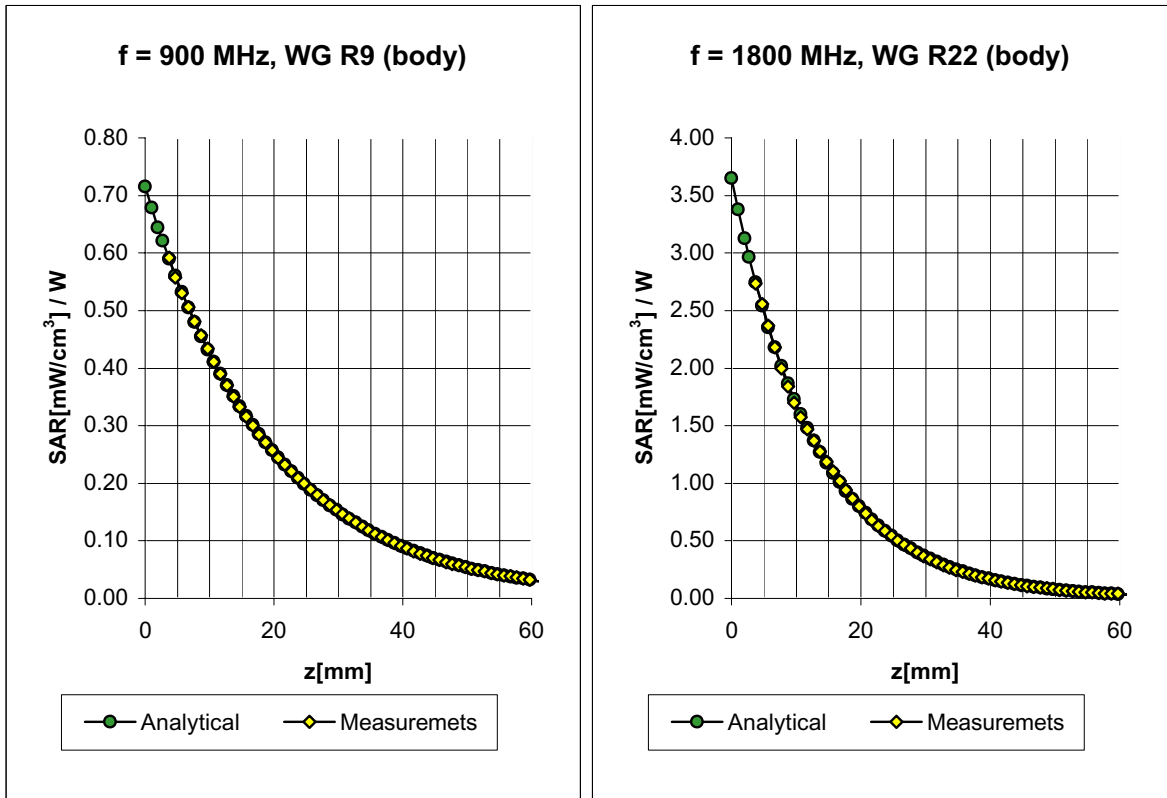

| | | | |
|-------------|-----------------|------------------------------|---------------------------------------|
| Body | 900 MHz | $\epsilon_r = 55.0 \pm 5\%$ | $\sigma = 1.05 \pm 5\% \text{ mho/m}$ |
| Body | 835 MHz | $\epsilon_r = 55.2 \pm 5\%$ | $\sigma = 0.97 \pm 5\% \text{ mho/m}$ |
| | ConvF X | 6.3 $\pm 9.5\%$ (k=2) | Boundary effect: |
| | ConvF Y | 6.3 $\pm 9.5\%$ (k=2) | Alpha 0.42 |
| | ConvF Z | 6.3 $\pm 9.5\%$ (k=2) | Depth 2.44 |
| Body | 1800 MHz | $\epsilon_r = 53.3 \pm 5\%$ | $\sigma = 1.52 \pm 5\% \text{ mho/m}$ |
| Body | 1900 MHz | $\epsilon_r = 53.3 \pm 5\%$ | $\sigma = 1.52 \pm 5\% \text{ mho/m}$ |
| | ConvF X | 5.0 $\pm 9.5\%$ (k=2) | Boundary effect: |
| | ConvF Y | 5.0 $\pm 9.5\%$ (k=2) | Alpha 0.76 |
| | ConvF Z | 5.0 $\pm 9.5\%$ (k=2) | Depth 2.01 |

ET3DV6 SN:1387

February 22, 2002

Deviation from Isotropy in HSL

Error (θ, ϕ), $f = 900$ MHz

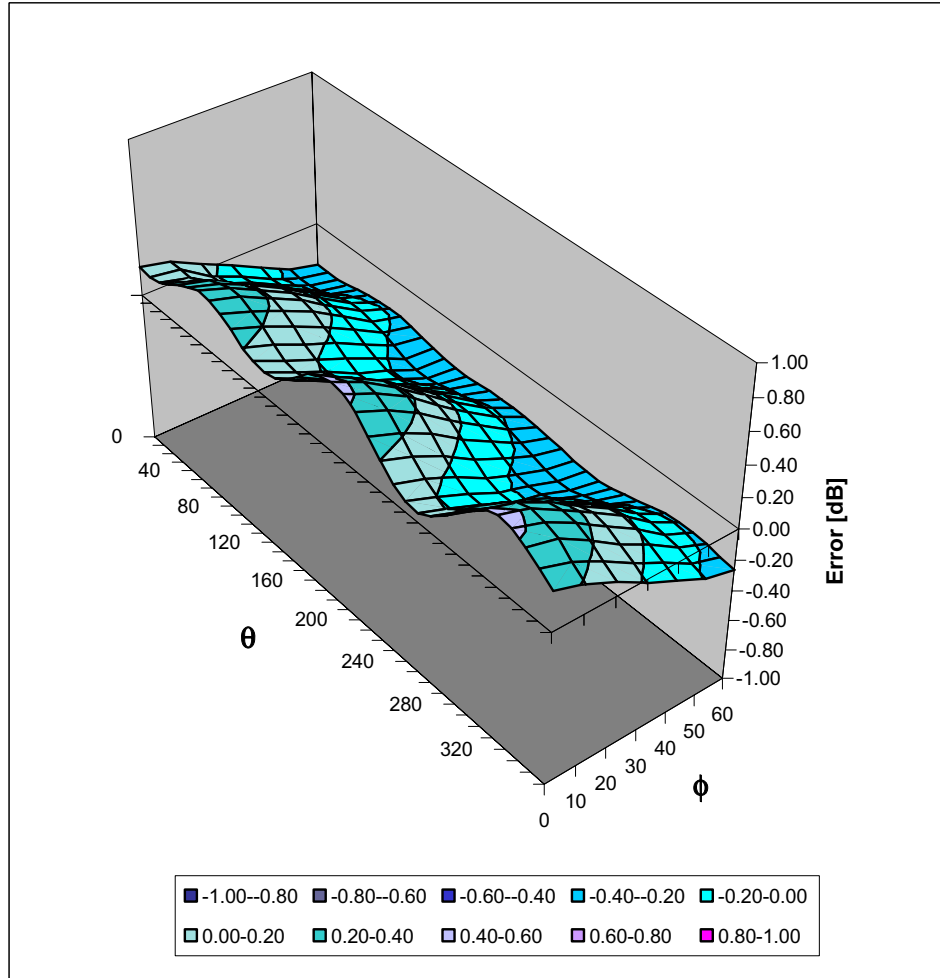

Additional Conversion Factors for Dosimetric E-Field Probe

Type:

ET3DV6

Serial Number:

1387

Place of Assessment:

Zurich

Date of Assessment:

February 25, 2002

Probe Calibration Date:

February 22, 2002

Schmid & Partner Engineering AG hereby certifies that conversion factor(s) of this probe have been evaluated on the date indicated above. The assessment was performed using the FDTD numerical code SEMCAD of Schmid & Partner Engineering AG. Since the evaluation is coupled with measured conversion factors, it has to be recalculated yearly, i.e., following the re-calibration schedule of the probe. The uncertainty of the numerical assessment is based on the extrapolation from measured value at 900 MHz or at 1800 MHz.

Assessed by:

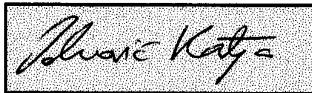

Dosimetric E-Field Probe ET3DV6 SN:1387

Conversion Factor (\pm standard deviation)

| | | | |
|----------|-------|---------------|---|
| 150 MHz | ConvF | $9.2 \pm 8\%$ | $\epsilon_r = 52.3$ $\sigma = 0.76 \text{ mho/m}$ (head tissue) |
| 300 MHz | ConvF | $8.0 \pm 8\%$ | $\epsilon_r = 45.3$ $\sigma = 0.87 \text{ mho/m}$ (head tissue) |
| 450 MHz | ConvF | $7.3 \pm 8\%$ | $\epsilon_r = 43.5$ $\sigma = 0.87 \text{ mho/m}$ (head tissue) |
| 2450 MHz | ConvF | $4.7 \pm 8\%$ | $\epsilon_r = 39.2$ $\sigma = 1.80 \text{ mho/m}$ (head tissue) |
| 150 MHz | ConvF | $8.8 \pm 8\%$ | $\epsilon_r = 61.9$ $\sigma = 0.80 \text{ mho/m}$ (body tissue) |
| 450 MHz | ConvF | $7.7 \pm 8\%$ | $\epsilon_r = 56.7$ $\sigma = 0.94 \text{ mho/m}$ (body tissue) |
| 2450 MHz | ConvF | $4.3 \pm 8\%$ | $\epsilon_r = 52.7$ $\sigma = 1.95 \text{ mho/m}$ (body tissue) |

APPENDIX E - MEASURED FLUID DIELECTRIC PARAMETERS

2450MHz System Performance Check

Measured Fluid Dielectric Parameters (Brain)

December 10, 2002

| Frequency | | ϵ' | ϵ'' |
|-------------|-----|-------------|--------------|
| 2.350000000 | GHz | 36.8272 | 13.3406 |
| 2.360000000 | GHz | 36.7859 | 13.3717 |
| 2.370000000 | GHz | 36.7562 | 13.3997 |
| 2.380000000 | GHz | 36.7221 | 13.4312 |
| 2.390000000 | GHz | 36.6910 | 13.4657 |
| 2.400000000 | GHz | 36.6588 | 13.4831 |
| 2.410000000 | GHz | 36.5910 | 13.5110 |
| 2.420000000 | GHz | 36.5486 | 13.5441 |
| 2.430000000 | GHz | 36.5072 | 13.5739 |
| 2.440000000 | GHz | 36.4613 | 13.5894 |
| 2.450000000 | GHz | 36.4147 | 13.6134 |
| 2.460000000 | GHz | 36.3815 | 13.6405 |
| 2.470000000 | GHz | 36.3464 | 13.6744 |
| 2.480000000 | GHz | 36.3168 | 13.7044 |
| 2.490000000 | GHz | 36.2822 | 13.7229 |
| 2.500000000 | GHz | 36.2284 | 13.7355 |
| 2.510000000 | GHz | 36.1819 | 13.7635 |
| 2.520000000 | GHz | 36.1311 | 13.7949 |
| 2.530000000 | GHz | 36.0907 | 13.8289 |
| 2.540000000 | GHz | 36.0208 | 13.8498 |
| 2.550000000 | GHz | 35.9971 | 13.8769 |

2450MHz EUT Evaluation (Body)

Measured Fluid Dielectric Parameters (Muscle)

December 10, 2002

| Frequency | ϵ' | ϵ'' |
|-----------------|-------------|--------------|
| 2.350000000 GHz | 48.1454 | 14.4131 |
| 2.360000000 GHz | 48.1126 | 14.4703 |
| 2.370000000 GHz | 48.0801 | 14.5106 |
| 2.380000000 GHz | 48.0451 | 14.5473 |
| 2.390000000 GHz | 48.0106 | 14.5704 |
| 2.400000000 GHz | 47.9610 | 14.6036 |
| 2.410000000 GHz | 47.9172 | 14.6346 |
| 2.420000000 GHz | 47.8604 | 14.6804 |
| 2.430000000 GHz | 47.8023 | 14.7113 |
| 2.440000000 GHz | 47.7464 | 14.7678 |
| 2.450000000 GHz | 47.7097 | 14.8002 |
| 2.460000000 GHz | 47.6605 | 14.8540 |
| 2.470000000 GHz | 47.6371 | 14.8898 |
| 2.480000000 GHz | 47.5999 | 14.9213 |
| 2.490000000 GHz | 47.5731 | 14.9517 |
| 2.500000000 GHz | 47.5573 | 14.9667 |
| 2.510000000 GHz | 47.4852 | 14.9882 |
| 2.520000000 GHz | 47.4566 | 15.0257 |
| 2.530000000 GHz | 47.3898 | 15.0528 |
| 2.540000000 GHz | 47.3346 | 15.0947 |
| 2.550000000 GHz | 47.2979 | 15.1160 |

APPENDIX F - SAM PHANTOM CERTIFICATE OF CONFORMITY

Schmid & Partner Engineering AG

Zeughausstrasse 43, 8004 Zurich, Switzerland, Phone +41 1 245 97 00, Fax +41 1 245 97 79

Certificate of conformity / First Article Inspection

| | |
|-----------------------|--|
| Item | SAM Twin Phantom V4.0 |
| Type No | QD 000 P40 BA |
| Series No | TP-1002 and higher |
| Manufacturer / Origin | Untersee Composites Hauptstr. 69 CH-8559 Fruthwilen Switzerland |

Tests

The series production process used allows the limitation to test of first articles. Complete tests were made on the pre-series Type No. QD 000 P40 AA, Serial No. TP-1001 and on the series first article Type No. QD 000 P40 BA, Serial No. TP-1006. Certain parameters have been retested using further series units (called samples).

| Test | Requirement | Details | Units tested |
|----------------------|---|--|---------------------------|
| Shape | Compliance with the geometry according to the CAD model. | IT'IS CAD File (*) | First article, Samples |
| Material thickness | Compliant with the requirements according to the standards | 2mm +/- 0.2mm in specific areas | First article, Samples |
| Material parameters | Dielectric parameters for required frequencies | 200 MHz – 3 GHz Relative permittivity < 5 Loss tangent < 0.05. | Material sample TP 104-5 |
| Material resistivity | The material has been tested to be compatible with the liquids defined in the standards | Liquid type HSL 1800 and others according to the standard. | Pre-series, First article |

Standards

- [1] CENELEC EN 50361
- [2] IEEE P1528-200x draft 6.5
- [3] IEC PT 62209 draft 0.9

(*) The IT'IS CAD file is derived from [2] and is also within the tolerance requirements of the shapes of [1] and [3].

Conformity

Based on the sample tests above, we certify that this item is in compliance with the uncertainty requirements of SAR measurements specified in standard [1] and draft standards [2] and [3].

Date 18.11.2001

Signature / Stamp



**Schmid & Partner
Engineering AG**



Zeughausstrasse 43, CH-8004 Zurich
Tel. +41 1 245 97 00, Fax +41 1 245 97 79