

**DECLARATION OF COMPLIANCE
SAR EVALUATION**

Test Lab

CELLTECH LABS INC.
Testing and Engineering Lab
1955 Moss Court
Kelowna, B.C.
Canada V1Y 9L3
Phone: 250-448-7047
Fax: 250-448-7046
e-mail: info@celltechlabs.com
web site: www.celltechlabs.com

Applicant Information

ITRONIX CORPORATION
801 South Stevens Street
Spokane, WA 99204

Rule Part(s):	FCC 47 CFR §2.1093; IC RSS-102 Issue 1 (Provisional)
Test Procedure(s):	FCC OET Bulletin 65, Supplement C (01-01)
FCC Device Classification:	Licensed Non-Broadcast Station Transmitter (TNB)
IC Device Classification:	Data Transmitter in Cellular Mobile Band
FCC ID:	KBCIX260AC300
Model(s):	IX260
Device Type:	Rugged Laptop PC with Sierra Wireless AirCard 300/350 CDPD Modem
Tx Frequency Range:	824.04 - 848.97 MHz
RF Output Power Tested:	28.0 dBm (Conducted)
Antenna Type:	External Dipole
Battery Type:	11.1V Lithium-Ion, 6.0Ah (Model: A2121-2)
Max. SAR Measured:	1.17 W/kg (1g average)

Celltech Labs Inc. declares under its sole responsibility that this device was found to be in compliance with the Specific Absorption Rate (SAR) RF exposure requirements specified in FCC 47 CFR §2.1093 and Health Canada's Safety Code 6. The device was tested in accordance with the measurement standards and procedures specified in FCC OET Bulletin 65, Supplement C, Edition 01-01 and Industry Canada RSS-102 Issue 1 - Provisional (General Population / Uncontrolled Exposure).

I attest to the accuracy of data. All measurements were performed by me or were made under my supervision and are correct to the best of my knowledge and belief. I assume full responsibility for the completeness of these measurements and vouch for the qualifications of all persons taking them.

This test report shall not be reproduced partially, or in full, without the prior written approval of Celltech Labs Inc. The results and statements contained in this report pertain only to the device(s) evaluated.



Russell Pipe
Senior Compliance Technologist
Celltech Labs Inc.



TABLE OF CONTENTS		
1.0	INTRODUCTION.....	3
2.0	DESCRIPTION OF EUT.....	3
3.0	SAR MEASUREMENT SYSTEM	4
4.0	MEASUREMENT SUMMARY.....	5
5.0	DETAILS OF SAR EVALUATION.....	6
6.0	EVALUATION PROCEDURES.....	6-7
7.0	SYSTEM PERFORMANCE CHECK.....	8
8.0	EQUIVALENT TISSUES.....	9
9.0	SAR LIMITS.....	9
10.0	SYSTEM SPECIFICATIONS.....	10
11.0	PROBE SPECIFICATION.....	11
12.0	SAM PHANTOM.....	11
13.0	DEVICE HOLDER.....	11
14.0	TEST EQUIPMENT LIST.....	12
15.0	MEASUREMENT UNCERTAINTIES.....	13
16.0	REFERENCES.....	14
	APPENDIX A - SAR MEASUREMENT DATA.....	15
	APPENDIX B - SYSTEM CHECK DATA.....	16
	APPENDIX C - SYSTEM VALIDATION.....	17
	APPENDIX D - PROBE CALIBRATION.....	18
	APPENDIX E - MEASURED FLUID DIELECTRIC PARAMETERS.....	19
	APPENDIX F - SAM PHANTOM CERTIFICATE OF CONFORMITY.....	20
	APPENDIX G - SAR TEST SETUP PHOTOGRAPHS.....	21

1.0 INTRODUCTION

This measurement report demonstrates that the ITRONIX CORPORATION Model: IX260 Rugged Laptop PC with Sierra Wireless AirCard 300/350 CDPD PCMCIA Modem Card FCC ID: KBCIX260AC300 complies with the RF exposure requirements specified in FCC 47 CFR §2.1093 (see reference [1]) and Health Canada Safety Code 6 (see reference [2]) for the General Population environment. The test procedures described in FCC OET Bulletin 65, Supplement C, Edition 01-01 (see reference [3]) and IC RSS-102 Issue 1 (Provisional) (see reference [4]), were employed. A description of the product, operating configuration, detailed summary of the test results, methodology and procedures used in the evaluation, equipment used, and the various provisions of the rules are included within this test report.

2.0 DESCRIPTION of Equipment Under Test (EUT)

FCC Rule Part(s)	47 CFR §2.1093
IC Rule Part(s)	IC RSS-102 Issue 1 (Provisional)
Test Procedure	FCC OET Bulletin 65, Supplement C (01-01)
FCC Device Classification	Licensed Non-Broadcast Station Transmitter (TNB)
IC Device Classification	Data Transmitter in Cellular Mobile Band
Device Type	Rugged Laptop PC with Sierra Wireless AirCard 300/350 CDPD PCMCIA Modem Card
FCC ID	KBCIX260AC300
Model(s)	IX260
Serial No.	Pre-production
Modulation	GMSK
Tx Frequency Range	824.04 - 848.97 MHz
RF Output Power Tested	28.0 dBm (Conducted)
Antenna Type	External Dipole (Length: 4.3 inches)
Battery Type	11.1V Lithium-Ion, 6.0Ah (Model: A2121-2)

3.0 SAR MEASUREMENT SYSTEM

Celltech Labs SAR measurement facility utilizes the Dosimetric Assessment System (DASY™) manufactured by Schmid & Partner Engineering AG (SPEAG™) of Zurich, Switzerland. The DASY system is comprised of the robot controller, computer, near-field probe, probe alignment sensor, specific anthropomorphic mannequin (SAM) phantom, and various planar phantoms for brain and/or body SAR evaluations. The robot is a six-axis industrial robot performing precise movements to position the probe to the location (points) of maximum electromagnetic field (EMF). A cell controller system contains the power supply, robot controller, teach pendant (Joystick), and remote control, is used to drive the robot motors. The Staubli robot is connected to the cell controller to allow software manipulation of the robot. A data acquisition electronic (DAE) circuit performs the signal amplification, signal multiplexing, AD-conversion, offset measurements, mechanical surface detection, collision detection, etc. is connected to the Electro-optical coupler (EOC). The EOC performs the conversion from the optical into digital electric signal of the DAE and transfers data to the PC plug-in card. The DAE3 utilizes a highly sensitive electrometer-grade preamplifier with auto-zeroing, a channel and gain-switching multiplexer, a fast 16-bit AD-converter and a command decoder and control logic unit. Transmission to the PC-card is accomplished through an optical downlink for data and status information and an optical uplink for commands and clock lines. The mechanical probe-mounting device includes two different sensor systems for frontal and sidewise probe contacts. They are also used for mechanical surface detection and probe collision detection. The robot uses its own controller with a built in VME-bus computer.



DASY3 SAR Measurement System with SAM phantom

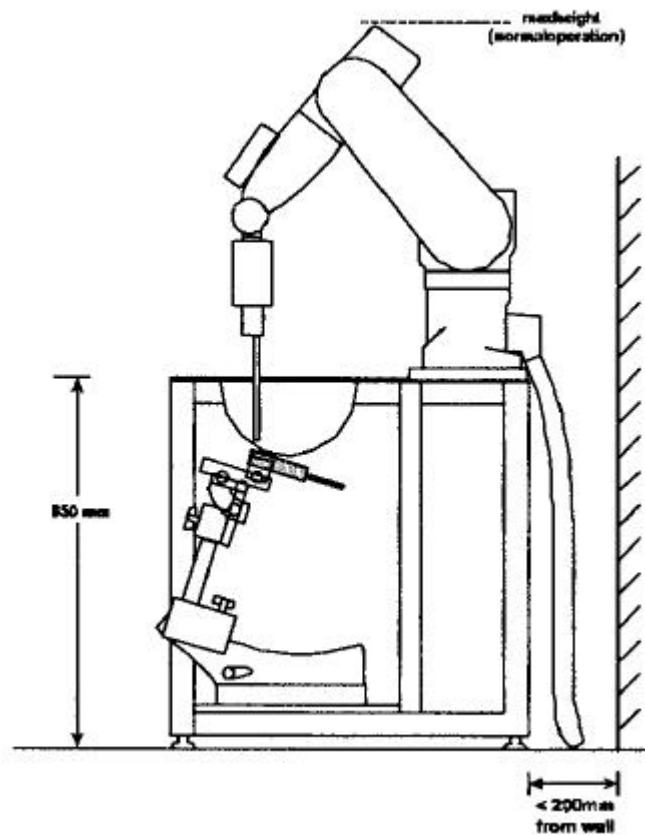

Figure 1. DASY3 Compact Version - Side View

4.0 MEASUREMENT SUMMARY

The measurement results were obtained with the EUT tested in the conditions described in this report. Detailed measurement data and plots showing the maximum SAR location of the EUT are reported in Appendix A.

BODY SAR MEASUREMENT RESULTS									
Freq. (MHz)	Channel	Mode	Conducted Power (dBm)		Phantom Section	Antenna Position to Planar Phantom	Laptop PC Position to Planar Phantom	Separation Distance (cm)	Measured SAR 1g (W/kg)
			Before	After					
824.04	991	CW	28.0	27.8	Planar	Parallel (Stowed)	Back of LCD (LCD Closed)	1.0	1.02
836.49	383	CW	28.0	27.8	Planar	Parallel (Stowed)	Back of LCD (LCD Closed)	1.0	0.778
848.97	799	CW	28.0	27.8	Planar	Parallel (Stowed)	Back of LCD (LCD Closed)	1.0	0.684
836.49	383	CW	28.0	27.8	Planar	Perpendicular (180°)	Back of LCD (LCD Closed)	1.0	0.0807
836.49	383	CW	28.0	27.8	Planar	Parallel (Stowed)	Bottom Side of PC (LCD Closed)	0.0	0.0634
836.49	383	CW	28.0	27.8	Planar	Perpendicular (Extended)	Bottom Side of PC (LCD Closed)	0.0	0.138
824.04	991	CW	28.0	27.8	Planar	Parallel (Stowed)	Right Side of LCD (LCD Closed)	2.0	1.06
836.49	383	CW	28.0	27.8	Planar	Parallel (Stowed)	Right Side of LCD (LCD Closed)	2.0	0.841
848.97	799	CW	28.0	27.8	Planar	Parallel (Stowed)	Right Side of LCD (LCD Closed)	2.0	0.756
824.04	991	CW	28.0	27.8	Planar	Parallel (Extended)	Right side of LCD (LCD Closed)	2.0	1.11
836.49	383	CW	28.0	27.8	Planar	Parallel (Extended)	Right side of LCD (LCD Closed)	2.0	1.17
848.97	799	CW	28.0	27.8	Planar	Parallel (Extended)	Right side of LCD (LCD Closed)	2.0	0.742
ANSI / IEEE C95.1 1992 - SAFETY LIMIT BODY: 1.6 W/kg (averaged over 1 gram) Spatial Peak - Uncontrolled Exposure / General Population									
Test Date(s)		02/11/03			Relative Humidity		59 %		
Measured Mixture Type		835MHz Body			Atmospheric Pressure		102.5 kPa		
Dielectric Constant ϵ_r		IEEE Target	Measured	Ambient Temperature		23.2 °C			
		55.2 ±5%	54.2	Fluid Temperature		21.2 °C			
Conductivity σ (mho/m)		IEEE Target	Measured	Fluid Depth		≥ 15 cm			
		0.97 ±5%	0.97	ρ (Kg/m³)		1000			

Note(s):

1. If the SAR measurements performed at the middle channel were ≥ 3 dB below the SAR limit, SAR evaluation for the low and high channels was optional for each test configuration (per FCC OET Bulletin 65, Supplement C, Edition 01-01 (see reference [3])).
2. The ambient and fluid temperatures were measured prior to, and during, the fluid dielectric parameter check and the SAR evaluation. The temperatures listed in the table above were consistent for all measurement periods.

5.0 DETAILS OF SAR EVALUATION

The ITRONIX CORPORATION Model: IX260 Rugged Laptop PC with Sierra Wireless AirCard 300/350 Cellular CDPD PCMCIA Modem Card FCC ID: KBCIX260AC300 was found to be compliant for localized Specific Absorption Rate based on the following test provisions and conditions described below. The detailed test setup photographs are shown in Appendix G.

1. The EUT was tested for body SAR with the LCD display closed and the back of the LCD display facing parallel to the outer surface of the planar phantom, and a 1.0 cm separation distance between the back of the LCD display and the planar phantom. The EUT was tested with the antenna in both the parallel (stowed) and perpendicular (180°) positions to the outer surface of the planar phantom.
2. The EUT was tested for body SAR with the LCD display closed and the bottom of the Laptop PC facing parallel to, and touching, the outer surface of the planar phantom. The EUT was tested with the antenna in both the parallel (stowed) and perpendicular (extended) positions to the outer surface of the planar phantom.
3. The EUT was tested for body SAR with the LCD display closed and the right side of the LCD display (antenna side) facing parallel to the outer surface of the planar phantom, and a 2.0 cm separation distance between the antenna and the planar phantom. The EUT was tested with the antenna parallel to the outer surface of the planar phantom in both the stowed and extended positions.
4. The conducted power levels were measured before and after each test using a Gigatronics 8652A Universal Power Meter according to the procedures described in FCC 47 CFR §2.1046. If the conducted power levels measured after each evaluation varied more than 5% from the initial power level, then the EUT was retested. Any unusual anomalies over the course of the test also warranted a re-evaluation.
5. The EUT was controlled in test mode via internal software. SAR measurements were performed with the EUT operating at maximum power in unmodulated continuous transmit mode (CW).
6. The location of the maximum spatial SAR distribution (Hot Spot) was determined relative to the device and antenna.
7. The EUT was tested with a fully charged battery.
8. Due to the dimensions of the EUT, a stack of low-density, low-loss dielectric foamed polystyrene was used in place of the device holder.
9. Due to the dimensions of the EUT the coarse scans did not cover the entire area of the Laptop PC (back of LCD display and bottom of Laptop PC positions). Subsequently, a second coarse scan was performed for the highest SAR configurations to show there were no secondary peak SAR locations within 3dB of the primary peak values. At this time there is no approved phantom available that is twice the dimensions of the Laptop PC.

6.0 EVALUATION PROCEDURES

- (i) The evaluation was performed in the applicable area of the phantom depending on the type of device being tested. For devices held to the ear during normal operation, both the left and right ear positions were evaluated in accordance with FCC OET Bulletin 65, Supplement C (Edition 01-01) using the SAM phantom.
- (ii) For body-worn and face-held devices a planar phantom was used.
- b. The SAR was determined by a pre-defined procedure within the DASY3 software. Upon completion of a reference and optical surface check, the exposed region of the phantom was scanned near the inner surface with a grid spacing of 20mm x 20mm.
- c. Based on the area scan data, the area of maximum absorption was determined by spline interpolation. Around this point, a volume of 40 x 40 x 35 mm (fine resolution volume scan, zoom scan) was assessed by measuring 5 x 5 x 7 points.
- d. The 1g and 10g spatial peak SAR was determined as follows:
 1. The first step was an extrapolation to find the points between the dipole center of the probe and the surface of the phantom. This data cannot be measured, since the center of the dipoles is 2.7 mm away from the tip of the probe and the distance between the surface and the lowest measuring point is 1.3 mm (see probe calibration document in Appendix D). The extrapolation was based on a least square algorithm [W. Gander, Computermathematik, p.168-180] (see reference [6]). Through the points in the first 3 cm in all z-axis, polynomials of the fourth order were calculated. This polynomial was then used to evaluate the points between the surface and the probe tip.
 2. The next step used 3D-spline interpolation to get all points within the measured volume in a 1mm grid (35000 points). The 3D-spline is composed of three one-dimensional splines with the "Not a knot" condition [W. Gander, Computermathematik, p.141-150] (x, y and z -direction) [Numerical Recipes in C, Second Edition, p.123ff] (see reference [6]).
 3. The maximal interpolated value was searched with a straightforward algorithm. Around this maximum the SAR values averaged over the spatial volumes (1g or 10g) were computed using the 3D-spline interpolation algorithm. 8000 points (20x20x20) were interpolated to calculate the average.

EVALUATION PROCEDURES (Cont.)

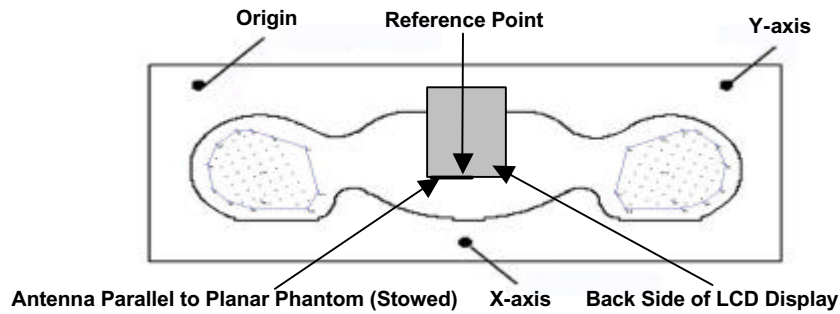

Figure 2. Phantom Reference Point & EUT Positioning Back Side of LCD Display (Closed)

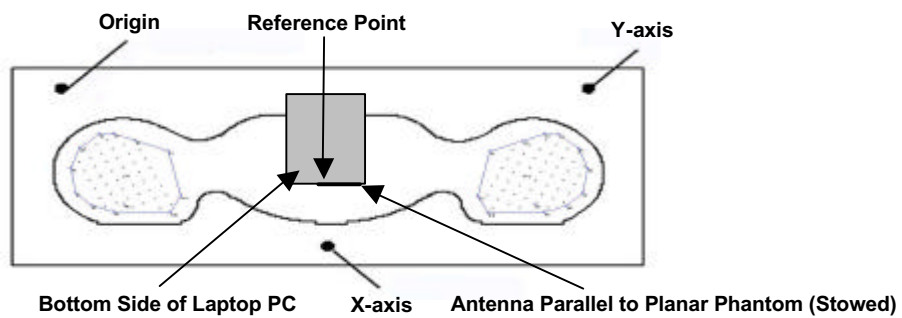

Figure 3. Phantom Reference Point & EUT Positioning Bottom Side of Laptop PC (LCD Display Closed)

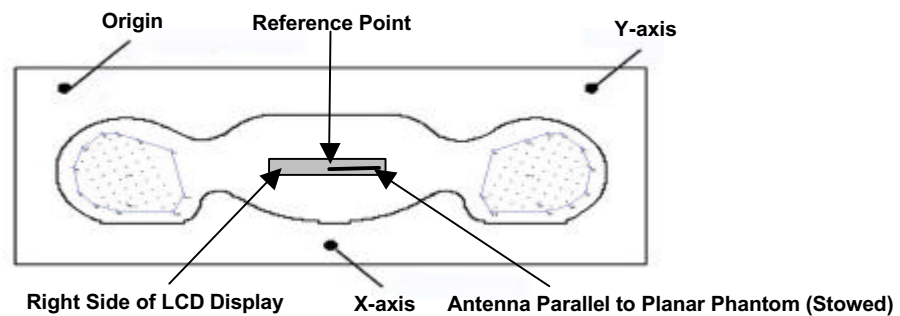

Figure 4. Phantom Reference Point & EUT Positioning Right Side of LCD Display (Closed)

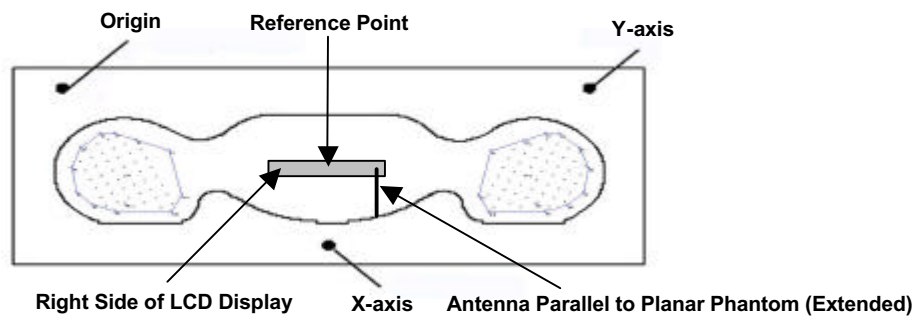

Figure 5. Phantom Reference Point & EUT Positioning Right Side of LCD Display (Closed)

7.0 SYSTEM PERFORMANCE CHECK

Prior to the assessment a system check was performed in the planar section of the SAM phantom with a 900MHz dipole (see Appendix C for system validation procedures). The fluid dielectric parameters were measured prior to the system check using an 85070C Dielectric Probe Kit and an 8753E Network Analyzer (see Appendix E for printout of measured fluid dielectric parameters). A forward power of 250mW was applied to the dipole and the system was verified to a tolerance of $\pm 10\%$ (see Appendix B for system check test plot).

SYSTEM PERFORMANCE CHECK											
Test Date	Equiv. Tissue	SAR 1g (W/kg)		Dielectric Constant ϵ_r		Conductivity σ (mho/m)		ρ (Kg/m ³)	Ambient Temp.	Fluid Temp.	Fluid Depth
		IEEE Target	Measured	IEEE Target	Measured	IEEE Target	Measured				
02/11/03	900MHz (Brain)	2.70 $\pm 10\%$	2.71	41.5 $\pm 5\%$	41.0	0.97 $\pm 5\%$	0.97	1000	23.2 °C	21.2 °C	≥ 15 cm

Note(s):

- The ambient and fluid temperatures were measured prior to, and during, the fluid dielectric parameter check and the system performance check. The temperatures listed in the table above were consistent for all measurement periods.

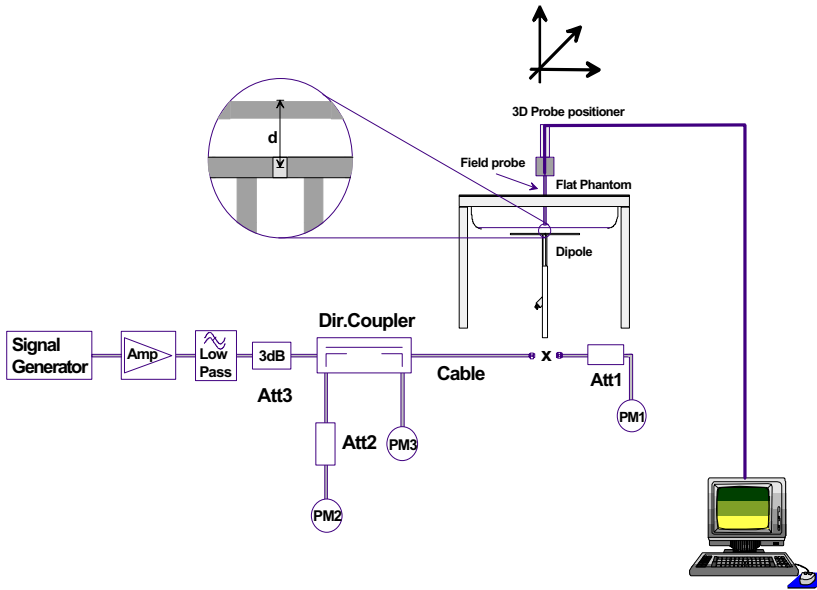

Figure 6. System Check Setup Diagram



900MHz System Check Setup

8.0 EQUIVALENT TISSUES

The 835MHz and 900MHz simulated tissues consist of a viscous gel using hydroxethylcellulose (HEC) gelling agent and saline solution. Preservation with a bactericide was added and visual inspection was made to ensure air bubbles were not trapped during the mixing process. The fluids were prepared according to standardized procedures and measured for dielectric parameters (permittivity and conductivity).

835MHz & 900MHz TISSUE MIXTURES		
INGREDIENT	900MHz Brain (System Check)	835MHz Body (EUT Evaluation)
Water	40.71 %	53.70 %
Sugar	56.63 %	45.10 %
Salt	1.48 %	0.97 %
HEC	1.00 %	0.13%
Bactericide	0.18 %	0.10 %

9.0 SAR SAFETY LIMITS

EXPOSURE LIMITS	SAR (W/kg)	
	(General Population / Uncontrolled Exposure Environment)	(Occupational / Controlled Exposure Environment)
Spatial Average (averaged over the whole body)	0.08	0.4
Spatial Peak (averaged over any 1 g of tissue)	1.60	8.0
Spatial Peak (hands/wrists/feet/ankles averaged over 10 g)	4.0	20.0

Notes:

1. Uncontrolled environments are defined as locations where there is potential exposure of individuals who have no knowledge or control of their potential exposure.
2. Controlled environments are defined as locations where there is potential exposure of individuals who have knowledge of their potential exposure and can exercise control over their exposure.

10.0 ROBOT SYSTEM SPECIFICATIONS

Specifications

POSITIONER: Stäubli Unimation Corp. Robot Model: RX60L
Repeatability: 0.02 mm
No. of axis: 6

Data Acquisition Electronic (DAE) System

Cell Controller

Processor: Pentium III
Clock Speed: 450 MHz
Operating System: Windows NT
Data Card: DASY3 PC-Board

Data Converter

Features: Signal Amplifier, multiplexer, A/D converter, and control logic
Software: DASY3 software
Connecting Lines: Optical downlink for data and status info.
Optical uplink for commands and clock

PC Interface Card

Function: 24 bit (64 MHz) DSP for real time processing
Link to DAE3
16-bit A/D converter for surface detection system
serial link to robot
direct emergency stop output for robot

E-Field Probe

Model: ET3DV6
Serial No.(s): 1590
Construction: Triangular core fiber optic detection system
Frequency: 10 MHz to 6 GHz
Linearity: ± 0.2 dB (30 MHz to 3 GHz)

Phantom

Type: SAM V4.0C
Shell Material: Fiberglass
Thickness: 2.0 ± 0.1 mm
Volume: Approx. 20 liters

11.0 PROBE SPECIFICATION (ET3DV6)

Construction:	Symmetrical design with triangular core Built-in shielding against static charges PEEK enclosure material (resistant to organic solvents, e.g. glycol)
Calibration:	In air from 10 MHz to 2.5 GHz In brain simulating tissue at frequencies of 900 MHz and 1.8 GHz (accuracy $\pm 8\%$)
Frequency:	10 MHz to >6 GHz; Linearity: ± 0.2 dB (30 MHz to 3 GHz)
Directivity:	± 0.2 dB in brain tissue (rotation around probe axis) ± 0.4 dB in brain tissue (rotation normal to probe axis)
Dynam. Rnge:	5 μ W/g to >100 mW/g; Linearity: ± 0.2 dB
Srfce. Detect.	± 0.2 mm repeatability in air and clear liquids over diffuse reflecting surfaces
Dimensions:	Overall length: 330 mm Tip length: 16 mm Body diameter: 12 mm Tip diameter: 6.8 mm Distance from probe tip to dipole centers: 2.7 mm
Application:	General dosimetry up to 3 GHz Compliance tests of mobile phone



ET3DV6 E-Field Probe

12.0 SAM PHANTOM V4.0C

The SAM phantom V4.0C is a fiberglass shell phantom with a 2.0 mm shell thickness for left and right head and flat planar area integrated in a wooden table. The shape of the fiberglass shell corresponds to the phantom defined by SCC34-SC2. The device holder positions are adjusted to the standard measurement positions in the three sections.

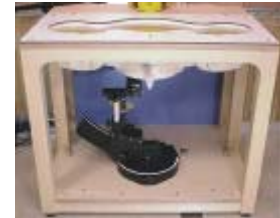

SAM Phantom

13.0 DEVICE HOLDER

The DAS3 device holder has two scales for device rotation (with respect to the body axis) and the device inclination (with respect to the line between the ear openings). The plane between the ear openings and the mouth tip has a rotation angle of 65° . The bottom plate contains three pair of bolts for locking the device holder. The device holder positions are adjusted to the standard measurement positions in the three sections.



Device Holder

14.0 TEST EQUIPMENT LIST

SAR MEASUREMENT SYSTEM		
EQUIPMENT	SERIAL NO.	CALIBRATION DATE
DASY3 System -Robot -ET3DV6 E-Field Probe -300MHz Validation Dipole -450MHz Validation Dipole -900MHz Validation Dipole -1800MHz Validation Dipole -2450MHz Validation Dipole -SAM Phantom V4.0C -Small Planar Phantom -Medium Planar Phantom -Large Planar Phantom	599396-01 1590 135 136 054 247 150 N/A N/A N/A N/A	N/A Dec 2002 Oct 2002 Oct 2002 June 2001 June 2001 Oct 2002 N/A N/A N/A N/A
85070C Dielectric Probe Kit	N/A	N/A
Gigatronics 8652A Power Meter -Power Sensor 80701A -Power Sensor 80701A	1835272 1833535 1833542	Feb 2003 Feb 2003 Mar 2002
Pasternack Attenuator (30dB, 2W)	PE7014-30	N/A
E4408B Spectrum Analyzer	US39240170	Nov 2002
8594E Spectrum Analyzer	3543A02721	Feb 2003
8753E Network Analyzer	US38433013	Feb 2003
8648D Signal Generator	3847A00611	Feb 2003
5S1G4 Amplifier Research Power Amplifier	26235	N/A

15.0 MEASUREMENT UNCERTAINTIES

Error Description	Uncertainty Value ±%	Probability Distribution	Divisor	c_i 1g	Standard Uncertainty ±% (1g)	v_i or v_{eff}
Measurement System						
Probe calibration	± 4.8	Normal	1	1	± 4.8	∞
Axial isotropy of the probe	± 4.7	Rectangular	√3	(1- c_p)	± 1.9	∞
Spherical isotropy of the probe	± 9.6	Rectangular	√3	(c_p)	± 3.9	∞
Spatial resolution	± 0.0	Rectangular	√3	1	± 0.0	∞
Boundary effects	± 5.5	Rectangular	√3	1	± 3.2	∞
Probe linearity	± 4.7	Rectangular	√3	1	± 2.7	∞
Detection limit	± 1.0	Rectangular	√3	1	± 0.6	∞
Readout electronics	± 1.0	Normal	1	1	± 1.0	∞
Response time	± 0.8	Rectangular	√3	1	± 0.5	∞
Integration time	± 1.4	Rectangular	√3	1	± 0.8	∞
RF ambient conditions	± 3.0	Rectangular	√3	1	± 1.7	∞
Mech. constraints of robot	± 0.4	Rectangular	√3	1	± 0.2	∞
Probe positioning	± 2.9	Rectangular	√3	1	± 1.7	∞
Extrapolation & integration	± 3.9	Rectangular	√3	1	± 2.3	∞
Test Sample Related						
Device positioning	± 6.0	Normal	√3	1	± 6.7	12
Device holder uncertainty	± 5.0	Normal	√3	1	± 5.9	8
Power drift	± 5.0	Rectangular	√3		± 2.9	∞
Phantom and Setup						
Phantom uncertainty	± 4.0	Rectangular	√3	1	± 2.3	∞
Liquid conductivity (target)	± 5.0	Rectangular	√3	0.6	± 1.7	∞
Liquid conductivity (measured)	± 5.0	Rectangular	√3	0.6	± 1.7	∞
Liquid permittivity (target)	± 5.0	Rectangular	√3	0.6	± 1.7	∞
Liquid permittivity (measured)	± 5.0	Rectangular	√3	0.6	± 1.7	∞
Combined Standard Uncertainty					± 13.7	
Expanded Uncertainty (k=2)					± 27.5	

Measurement Uncertainty Table in accordance with IEEE Std 1528 (Draft - see Reference [5])

16.0 REFERENCES

- [1] Federal Communications Commission, "Radiofrequency radiation exposure evaluation: portable devices", Rule Part 47 CFR §2.1093: 1999.
- [2] Health Canada, "Limits of Human Exposure to Radiofrequency Electromagnetic Fields in the Frequency Range from 3 kHz to 300 GHz", Safety Code 6.
- [3] Federal Communications Commission, "Evaluating Compliance with FCC Guidelines for Human Exposure to Radio frequency Electromagnetic Fields", OET Bulletin 65, Supplement C (Edition 01-01), FCC, Washington, D.C.: June 2001.
- [4] Industry Canada, "Evaluation Procedure for Mobile and Portable Radio Transmitters with respect to Health Canada's Safety Code 6 for Exposure of Humans to Radio Frequency Fields", Radio Standards Specification RSS-102 Issue 1 (Provisional): September 1999.
- [5] IEEE Standards Coordinating Committee 34, Std 1528-200X, "DRAFT Recommended Practice for Determining the Spatial-Peak Specific Absorption Rate (SAR) in the Human Body Due to Wireless Communications Devices: Experimental Techniques".
- [6] W. Gander, *Computermathematick*, Birkhaeuser, Basel: 1992.

APPENDIX B - SYSTEM CHECK DATA

System Performance Check - 900MHz Dipole

SAM Phantom; Flat Section

Probe: ET3DV6 - SNI1590; ConvF(6.90,6.90,6.90); Crest factor: 1.0; 900MHz Brain: $\sigma = 0.97$ mho/m $\epsilon_r = 41.0$ $\rho = 1.00$ g/cm³

Cube 5x5x7; Peak: 4.40 mW/g, SAR (1g): 2.71 mW/g, SAR (10g): 1.70 mW/g, (Worst-case extrapolation)

Penetration depth: 11.3 (10.2, 12.8) [mm]

Powerdrift: -0.05 dB

Forward Conducted Power: 250 mW

Date Tested: February 11, 2003

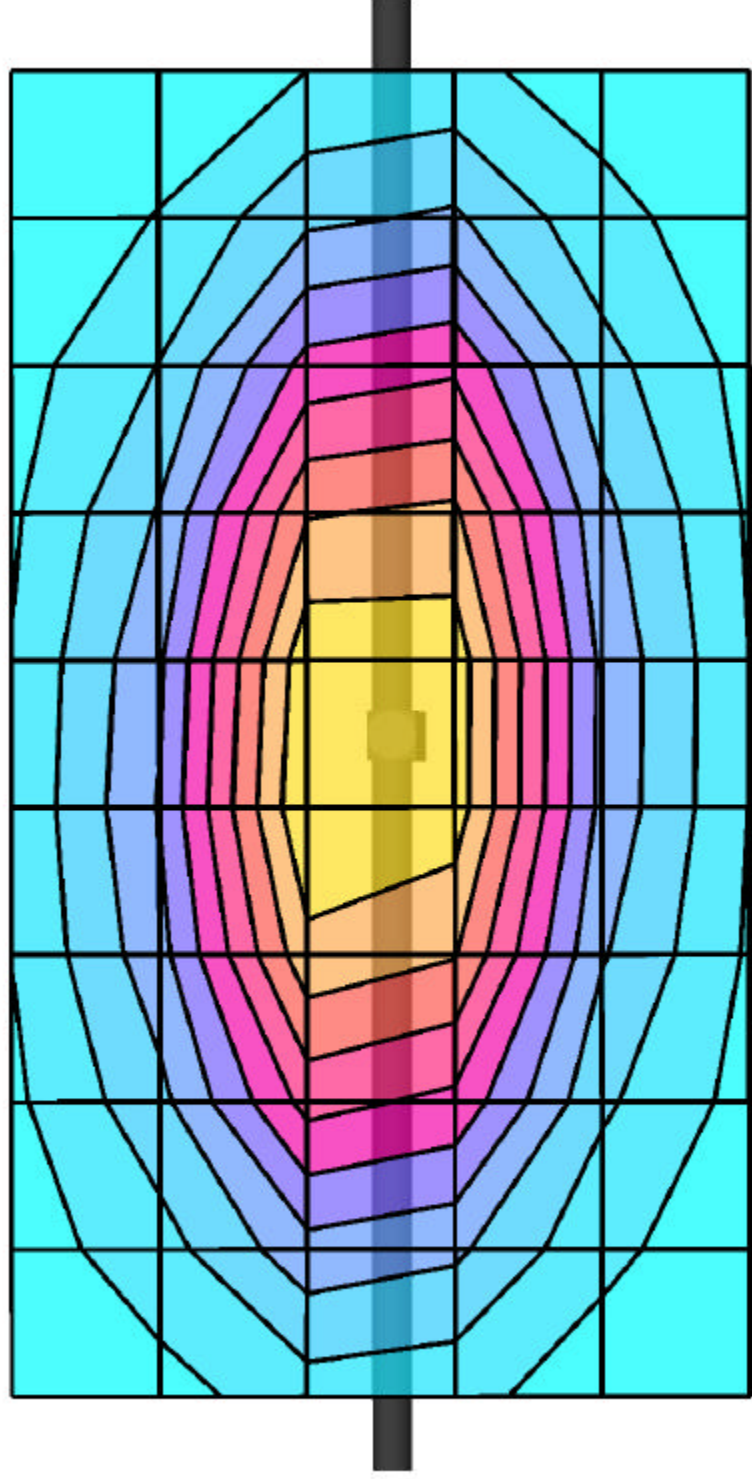

SAR_{tot} [mW/g]

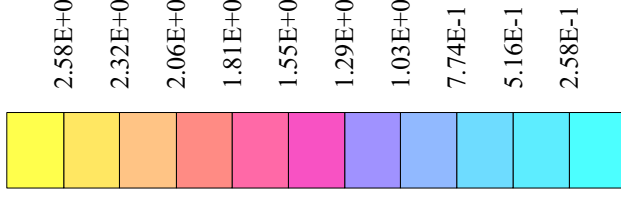

APPENDIX C - SYSTEM VALIDATION

Schmid & Partner Engineering AG

Zeughausstrasse 43, 8004 Zurich, Switzerland, Phone +41 1 245 97 00, Fax +41 1 245 97 79

Calibration Certificate

900 MHz System Validation Dipole

Type:

D900V2

Serial Number:

054

Place of Calibration:

Zurich

Date of Calibration:

June 20, 2001

Calibration Interval:

24 months

Schmid & Partner Engineering AG hereby certifies, that this device has been calibrated on the date indicated above. The calibration was performed in accordance with specifications and procedures of Schmid & Partner Engineering AG.

Wherever applicable, the standards used in the calibration process are traceable to international standards. In all other cases the standards of the Laboratory for EMF and Microwave Electronics at the Swiss Federal Institute of Technology (ETH) in Zurich, Switzerland have been applied.

Calibrated by:

Rhonic Vohja

Approved by:

[Signature]

DASY

Dipole Validation Kit

Type: D900V2

Serial: 054

Manufactured: August 25, 1999
Calibrated: June 20, 2001

1. Measurement Conditions

The measurements were performed in the flat section of the new generic twin phantom filled with head simulating solution of the following electrical parameters at 900 MHz:

Relative Dielectricity	42.4	$\pm 5\%$
Conductivity	0.97 mho/m	$\pm 5\%$

The DASY3 System (Software version 3.1c) with a dosimetric E-field probe ET3DV6 (SN:1507, Conversion factor 6.27 at 900 MHz) was used for the measurements.

The dipole was mounted on the small tripod so that the dipole feedpoint was positioned below the center marking of the flat phantom section and the dipole was oriented parallel to the body axis (the long side of the phantom). The standard measuring distance was 15mm from dipole center to the solution surface. The included distance holder was used during measurements for accurate distance positioning.

The coarse grid with a grid spacing of 15mm was aligned with the dipole. The 5x5x7 fine cube was chosen for cube integration. Probe isotropy errors were cancelled by measuring the SAR with normal and 90° turned probe orientations and averaging.

The dipole input power (forward power) was 250mW $\pm 3\%$. The results are normalized to 1W input power.

2. SAR Measurement

Standard SAR-measurements were performed with the phantom according to the measurement conditions described in section 1. The results have been normalized to a dipole input power of 1W (forward power). The resulting averaged SAR-values are:

averaged over 1 cm ³ (1 g) of tissue:	11.12 mW/g
averaged over 10 cm ³ (10 g) of tissue:	7.04 mW/g

Note: If the liquid parameters for validation are slightly different from the ones used for initial calibration, the SAR-values will be different as well.

5. SAR Measurement

Standard SAR-measurements were performed with the phantom according to the measurement conditions described in section 4. The results have been normalized to a dipole input power of 1W (forward power). The resulting averaged SAR-values are:

averaged over 1 cm ³ (1 g) of tissue:	10.12 mW/g
averaged over 10 cm ³ (10 g) of tissue:	6.52 mW/g

Note: If the liquid parameters for validation are slightly different from the ones used for initial calibration, the SAR-values will be different as well.

6. Handling

The dipole is made of standard semirigid coaxial cable. The center conductor of the feeding line is directly connected to the second arm of the dipole. The antenna is therefore short-circuited for DC-signals.

Do not apply excessive force to the dipole arms, because they might bend. If the dipole arms have to be bent back, take care to release stress to the soldered connections near the feedpoint; they might come off.

After prolonged use with 100W radiated power, only a slight warming of the dipole near the feedpoint can be measured.

CHI S11 1 U FS 1: 51.324 Ω -478.52 m Ω 369.56 pF 900.000 000 MHz

PRm
Del
Cor
Avg
16
↑

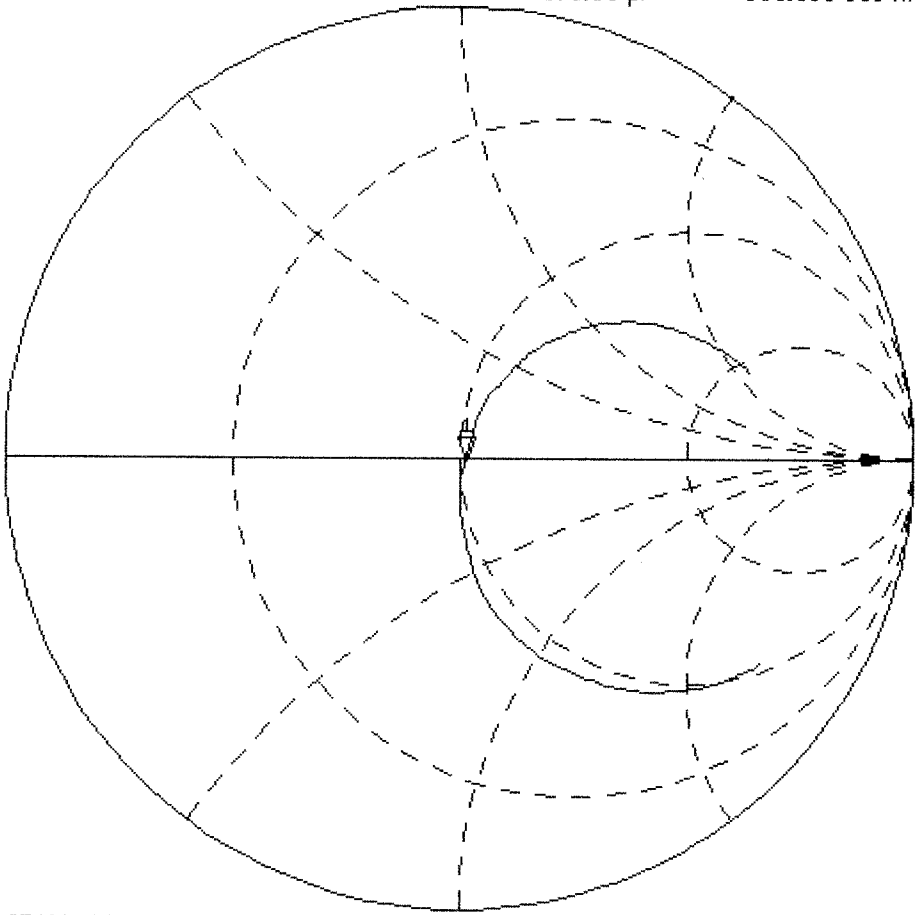

START 700.000 000 MHz

STOP 1 100.000 000 MHz

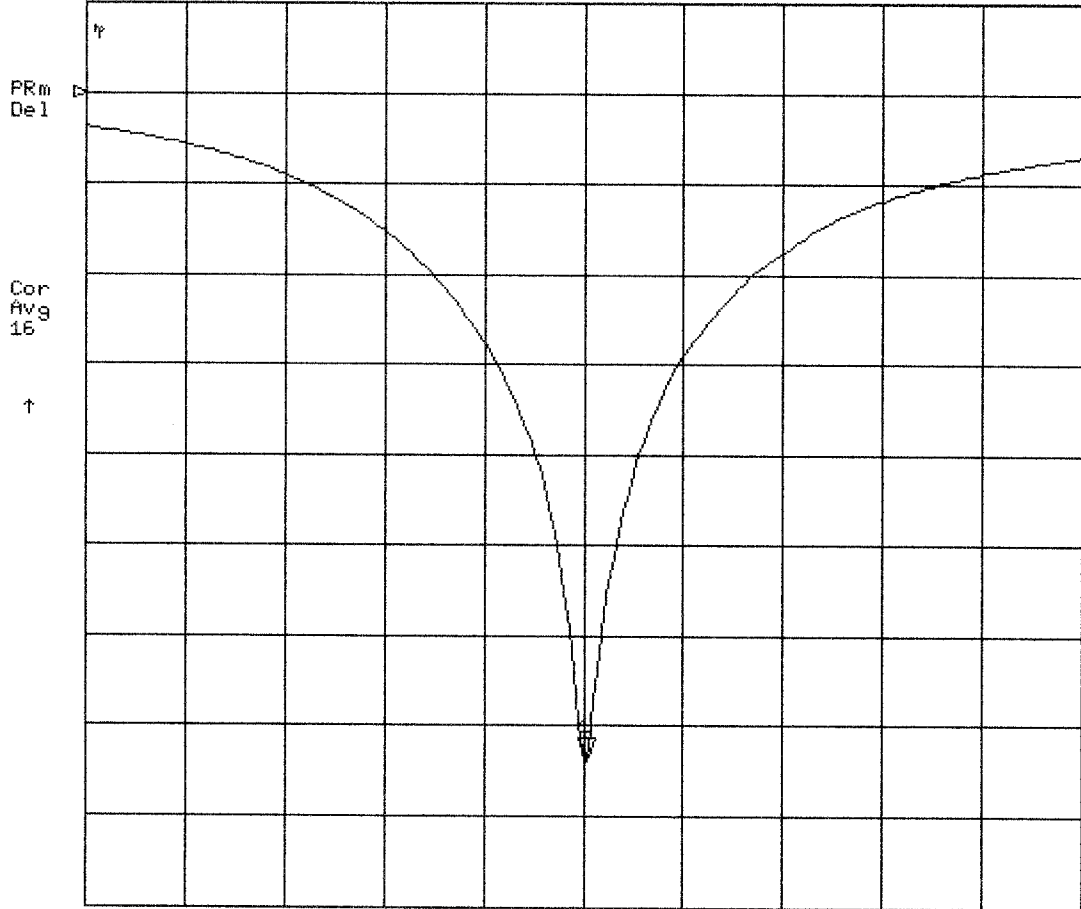

Validation Dipole D900V2 SN:054, d = 15 mm

Frequency: 900 MHz; Antenna Input Power: 250 [mW]
Generic Twin Phantom; Flat Section; Grid Spacing: Dx = 15.0, Dy = 15.0, Dz = 10.0
Probe: ET3DV6 - SN1507; ConvF(6.27,6.27,6.27); Crest factor: 1.0; IEEE1528 900 MHz: $\sigma = 0.97$ mho/m $\epsilon_r = 42.4$ $\rho = 1.00$ g/cm³
Cubes (2): Peak: 4.47 mW/g ± 0.05 dB, SAR (1g): 2.78 mW/g ± 0.04 dB, SAR (10g): 1.76 mW/g ± 0.02 dB, (Worst-case extrapolation)
Penetration depth: 11.5 (10.3, 13.2) [mm]
Powerdrift: -0.00 dB

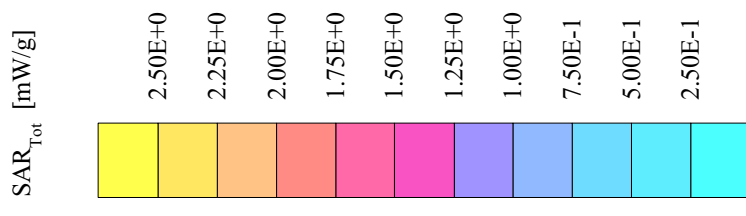

APPENDIX D - PROBE CALIBRATION

Schmid & Partner Engineering AG

Zeughausstrasse 43, 8004 Zurich, Switzerland, Phone +41 1 245 97 00, Fax +41 1 245 97 79

Calibration Certificate

Dosimetric E-Field Probe

Type:	ET3DV6
Serial Number:	1590
Place of Calibration:	Zurich
Date of Calibration:	December 1, 2002
Calibration Interval:	12 months

Schmid & Partner Engineering AG hereby certifies, that this device has been calibrated on the date indicated above. The calibration was performed in accordance with specifications and procedures of Schmid & Partner Engineering AG.

Wherever applicable, the standards used in the calibration process are traceable to international standards. In all other cases the standards of the Laboratory for EMF and Microwave Electronics at the Swiss Federal Institute of Technology (ETH) in Zurich, Switzerland have been applied.

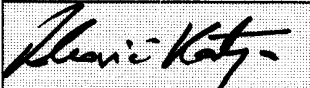
Calibrated by:	
Approved by:	

Probe ET3DV6

SN:1590

Manufactured:	March 19, 2001
Last calibration:	April 26, 2002
Recalibrated:	December 1, 2002

Calibrated for DASY Systems

(Note: non-compatible with DASY2 system!)

DASY - Parameters of Probe: ET3DV6 SN:1590

Sensitivity in Free Space

NormX	1.75 $\mu\text{V}/(\text{V}/\text{m})^2$
NormY	1.89 $\mu\text{V}/(\text{V}/\text{m})^2$
NormZ	1.63 $\mu\text{V}/(\text{V}/\text{m})^2$

Diode Compression

DCP X	92	mV
DCP Y	92	mV
DCP Z	92	mV

Sensitivity in Tissue Simulating Liquid

Head	900 MHz	$\epsilon_r = 41.5 \pm 5\%$	$\sigma = 0.97 \pm 5\%$ mho/m
Head	835 MHz	$\epsilon_r = 41.5 \pm 5\%$	$\sigma = 0.90 \pm 5\%$ mho/m
ConvF X	6.9 $\pm 9.5\%$ (k=2)		Boundary effect:
ConvF Y	6.9 $\pm 9.5\%$ (k=2)		Alpha 0.30
ConvF Z	6.9 $\pm 9.5\%$ (k=2)		Depth 2.71
Head	1800 MHz	$\epsilon_r = 40.0 \pm 5\%$	$\sigma = 1.40 \pm 5\%$ mho/m
Head	1900 MHz	$\epsilon_r = 40.0 \pm 5\%$	$\sigma = 1.40 \pm 5\%$ mho/m
ConvF X	5.6 $\pm 9.5\%$ (k=2)		Boundary effect:
ConvF Y	5.6 $\pm 9.5\%$ (k=2)		Alpha 0.42
ConvF Z	5.6 $\pm 9.5\%$ (k=2)		Depth 2.56

Boundary Effect

Head	900 MHz	Typical SAR gradient: 5 % per mm	
	Probe Tip to Boundary	1 mm	2 mm
	SAR _{be} [%] Without Correction Algorithm	8.7	5.0
	SAR _{be} [%] With Correction Algorithm	0.3	0.5
Head	1800 MHz	Typical SAR gradient: 10 % per mm	
	Probe Tip to Boundary	1 mm	2 mm
	SAR _{be} [%] Without Correction Algorithm	10.7	7.4
	SAR _{be} [%] With Correction Algorithm	0.1	0.3

Sensor Offset

Probe Tip to Sensor Center	2.7	mm
Optical Surface Detection	1.2 \pm 0.2	mm

Receiving Pattern (ϕ), $\theta = 0^\circ$

f = 30 MHz, TEM cell ifi110

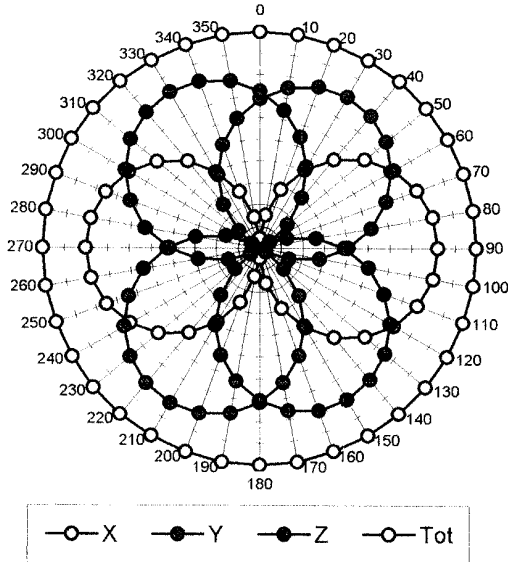

f = 100 MHz, TEM cell ifi110

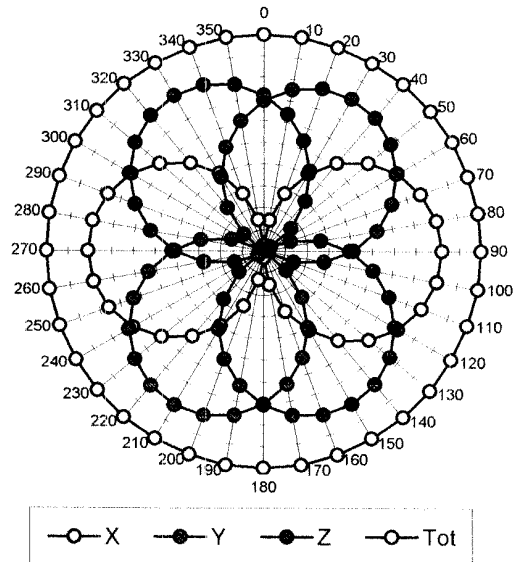

f = 300 MHz, TEM cell ifi110

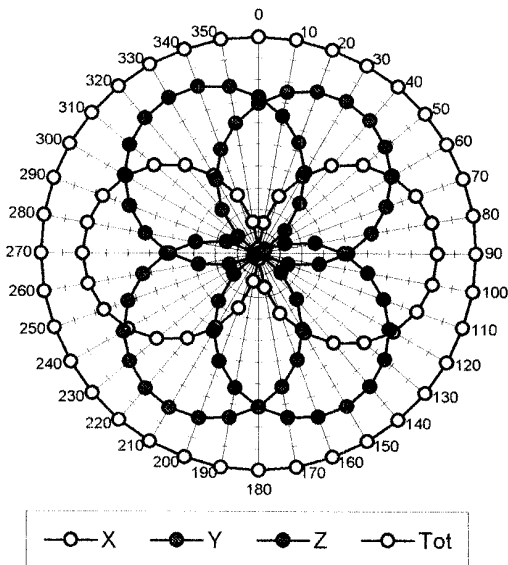

f = 900 MHz, TEM cell ifi110

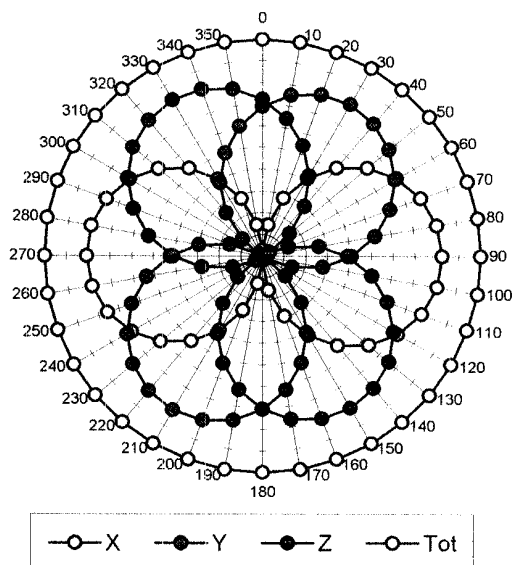

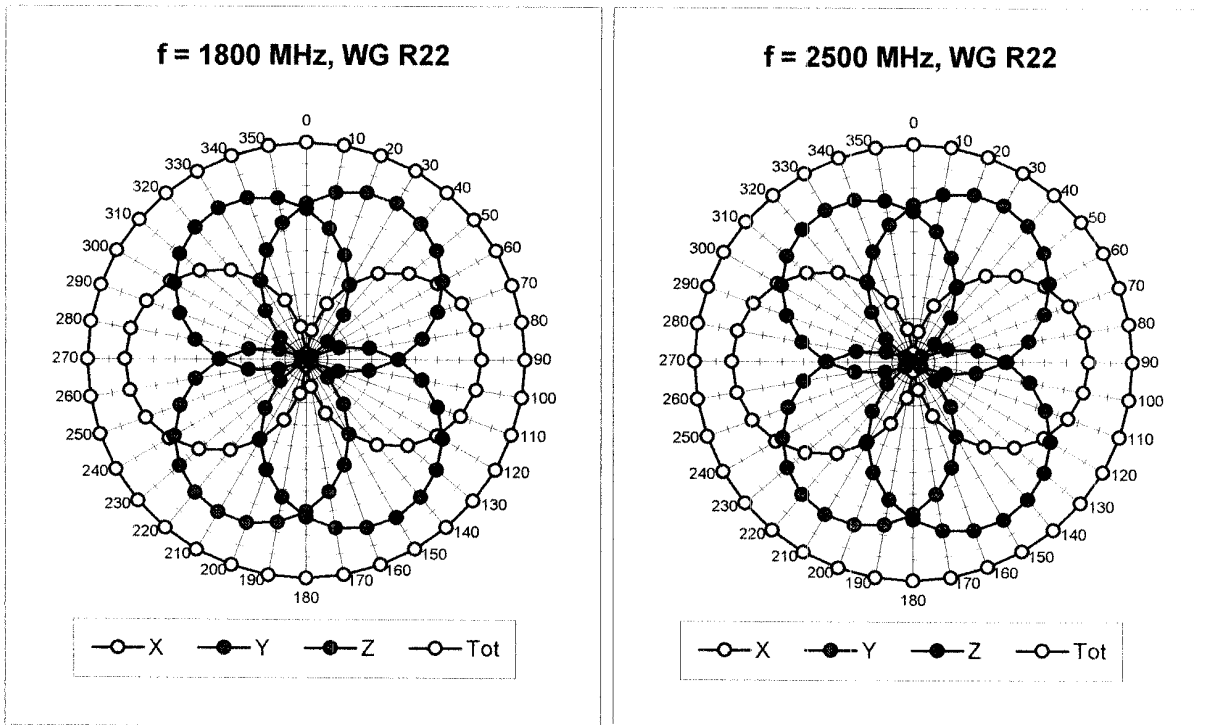

Isotropy Error (ϕ), $\theta = 0^\circ$

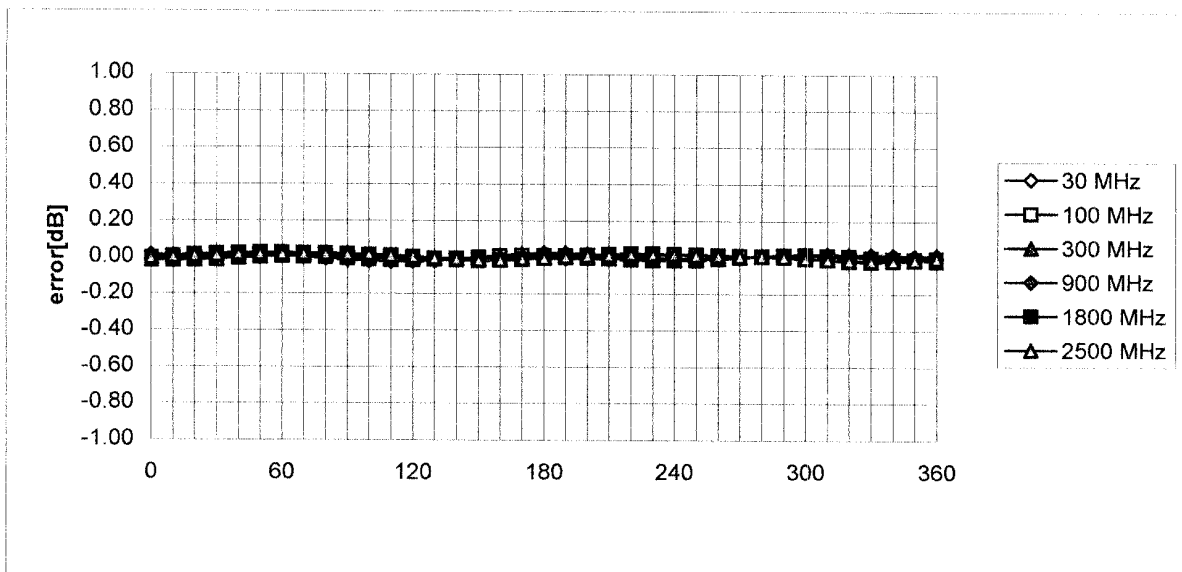

Frequency Response of E-Field

(TEM-Cell:ifi110, Waveguide R22)

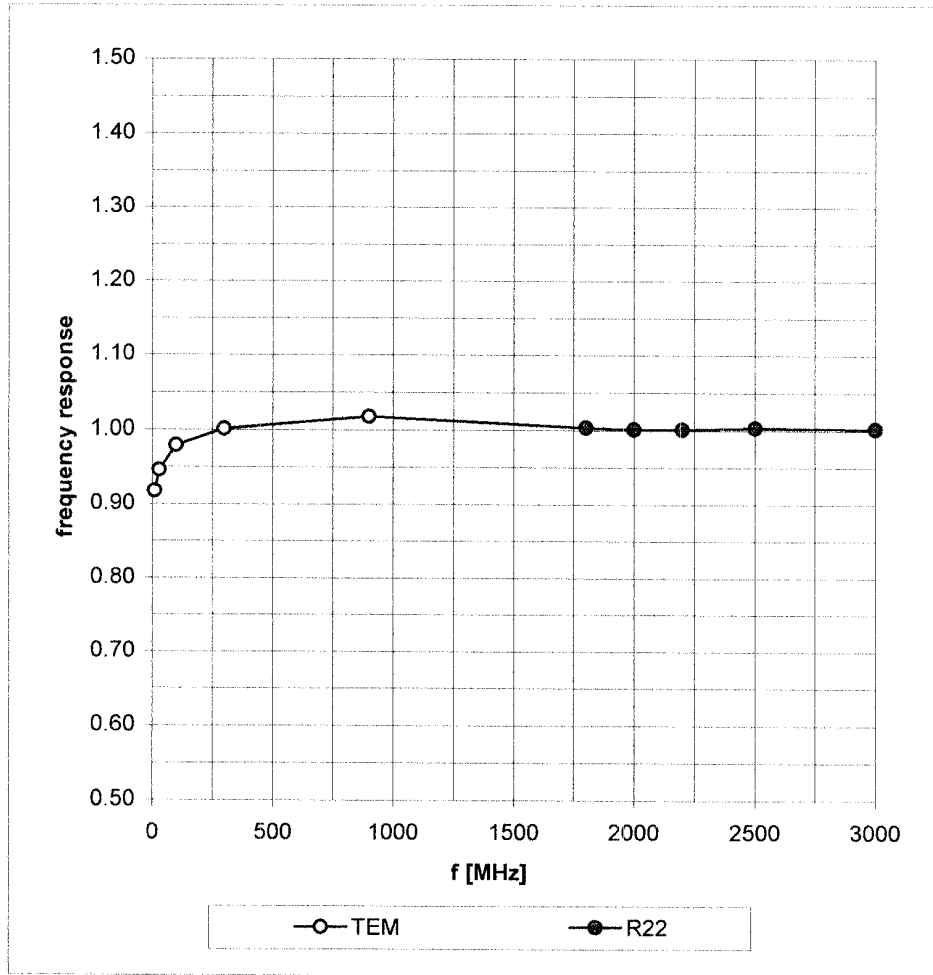

Dynamic Range f(SAR_{brain}) (Waveguide R22)

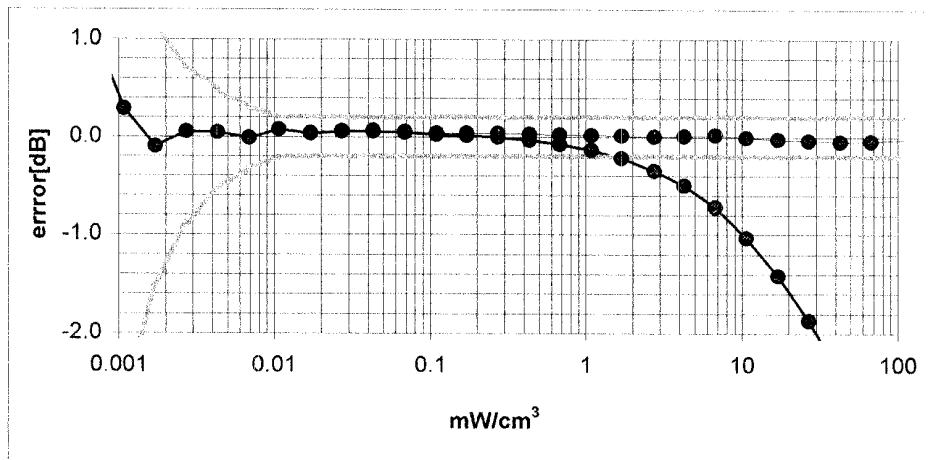
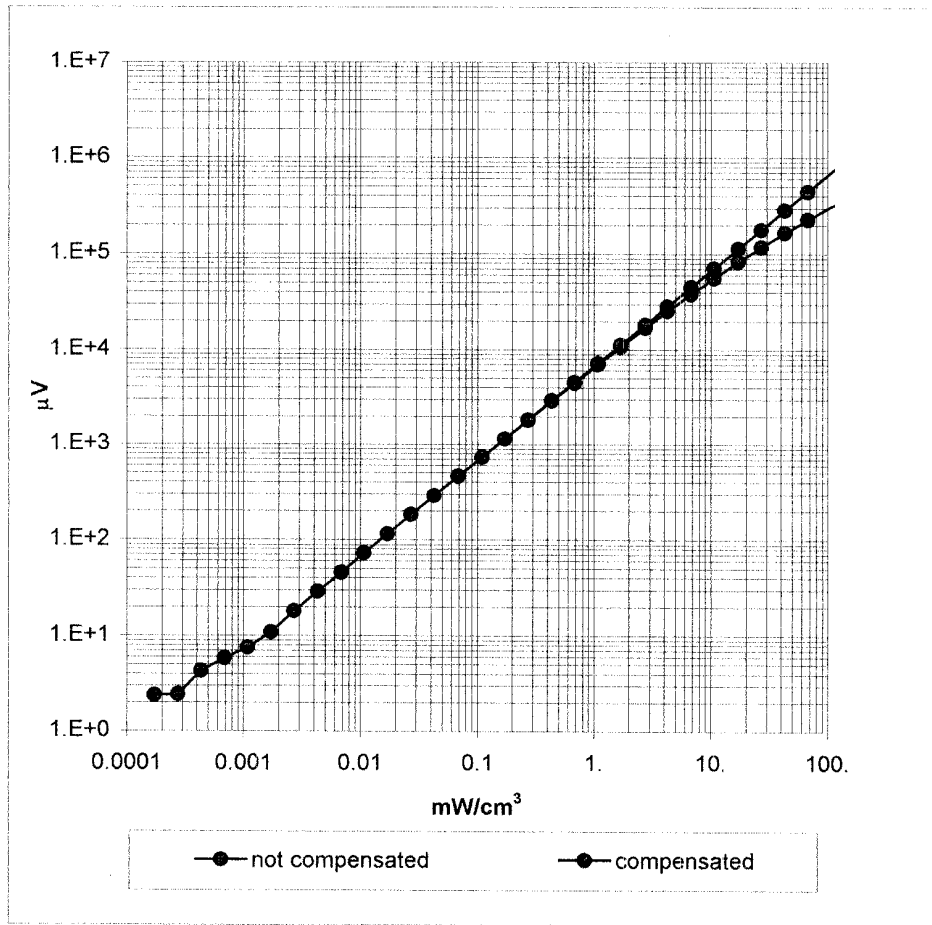

Conversion Factor Assessment

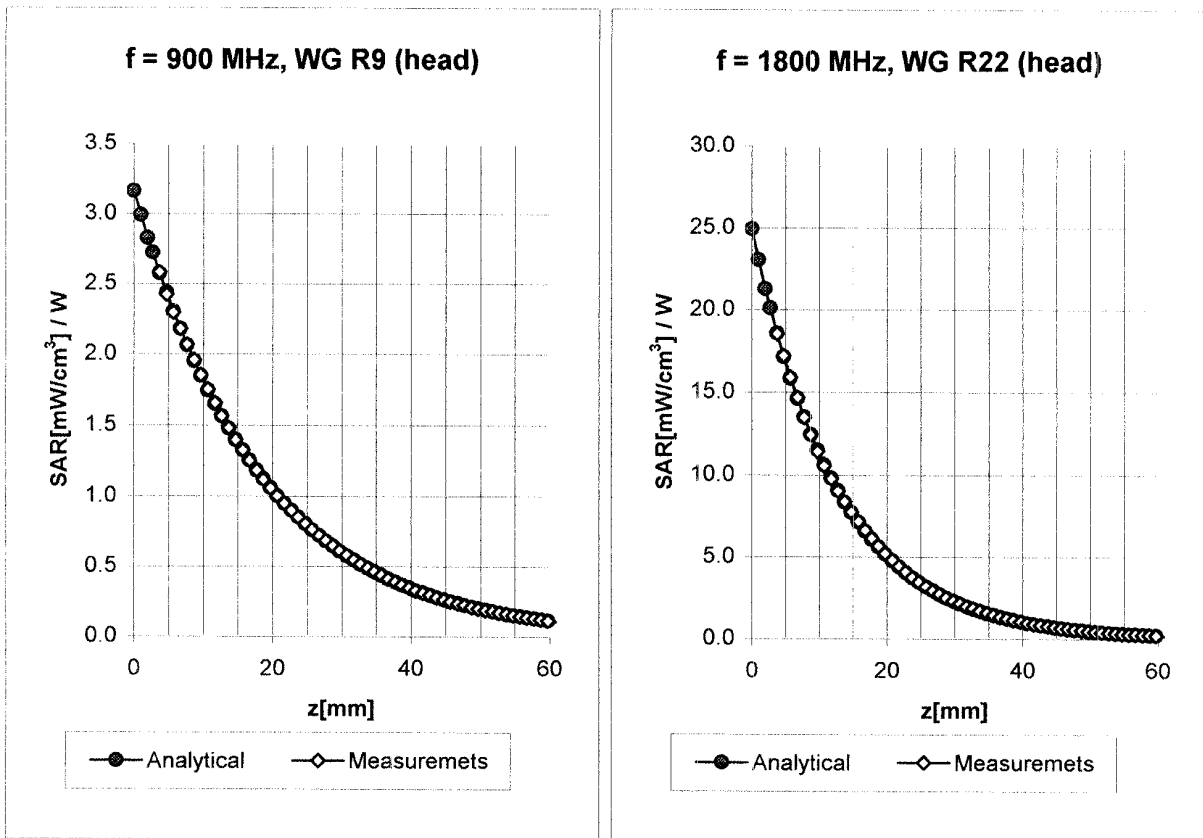

Head	900 MHz	$\epsilon_r = 41.5 \pm 5\%$	$\sigma = 0.97 \pm 5\% \text{ mho/m}$
Head	835 MHz	$\epsilon_r = 41.5 \pm 5\%$	$\sigma = 0.90 \pm 5\% \text{ mho/m}$
	ConvF X	6.9 $\pm 9.5\%$ (k=2)	Boundary effect:
	ConvF Y	6.9 $\pm 9.5\%$ (k=2)	Alpha 0.30
	ConvF Z	6.9 $\pm 9.5\%$ (k=2)	Depth 2.71
Head	1800 MHz	$\epsilon_r = 40.0 \pm 5\%$	$\sigma = 1.40 \pm 5\% \text{ mho/m}$
Head	1900 MHz	$\epsilon_r = 40.0 \pm 5\%$	$\sigma = 1.40 \pm 5\% \text{ mho/m}$
	ConvF X	5.6 $\pm 9.5\%$ (k=2)	Boundary effect:
	ConvF Y	5.6 $\pm 9.5\%$ (k=2)	Alpha 0.42
	ConvF Z	5.6 $\pm 9.5\%$ (k=2)	Depth 2.56

Conversion Factor Assessment

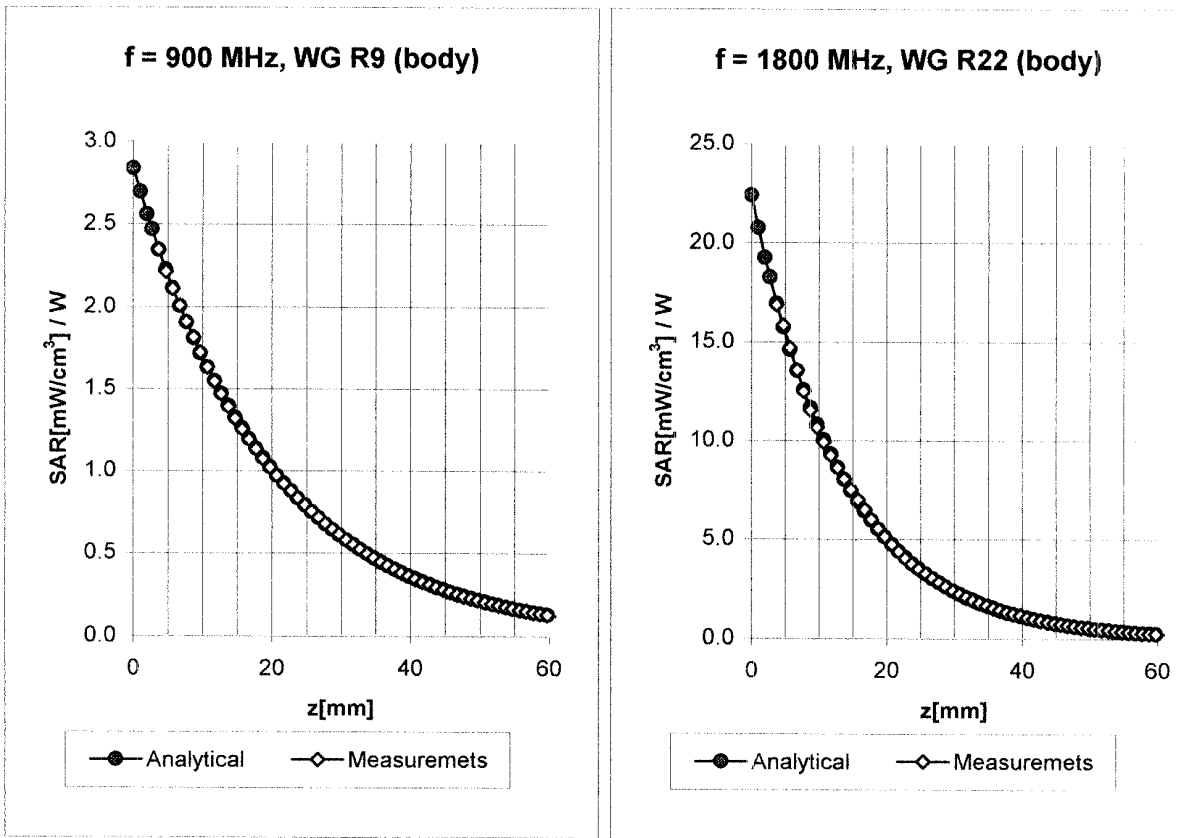

Body	900 MHz	$\epsilon_r = 55.0 \pm 5\%$	$\sigma = 1.05 \pm 5\% \text{ mho/m}$
Body	835 MHz	$\epsilon_r = 55.2 \pm 5\%$	$\sigma = 0.97 \pm 5\% \text{ mho/m}$
	ConvF X	6.7 $\pm 9.5\%$ (k=2)	Boundary effect:
	ConvF Y	6.7 $\pm 9.5\%$ (k=2)	Alpha 0.34
	ConvF Z	6.7 $\pm 9.5\%$ (k=2)	Depth 2.57
Body	1800 MHz	$\epsilon_r = 53.3 \pm 5\%$	$\sigma = 1.52 \pm 5\% \text{ mho/m}$
Body	1900 MHz	$\epsilon_r = 53.3 \pm 5\%$	$\sigma = 1.52 \pm 5\% \text{ mho/m}$
	ConvF X	5.3 $\pm 9.5\%$ (k=2)	Boundary effect:
	ConvF Y	5.3 $\pm 9.5\%$ (k=2)	Alpha 0.52
	ConvF Z	5.3 $\pm 9.5\%$ (k=2)	Depth 2.46

Deviation from Isotropy in HSL

Error (θ, ϕ), $f = 900$ MHz

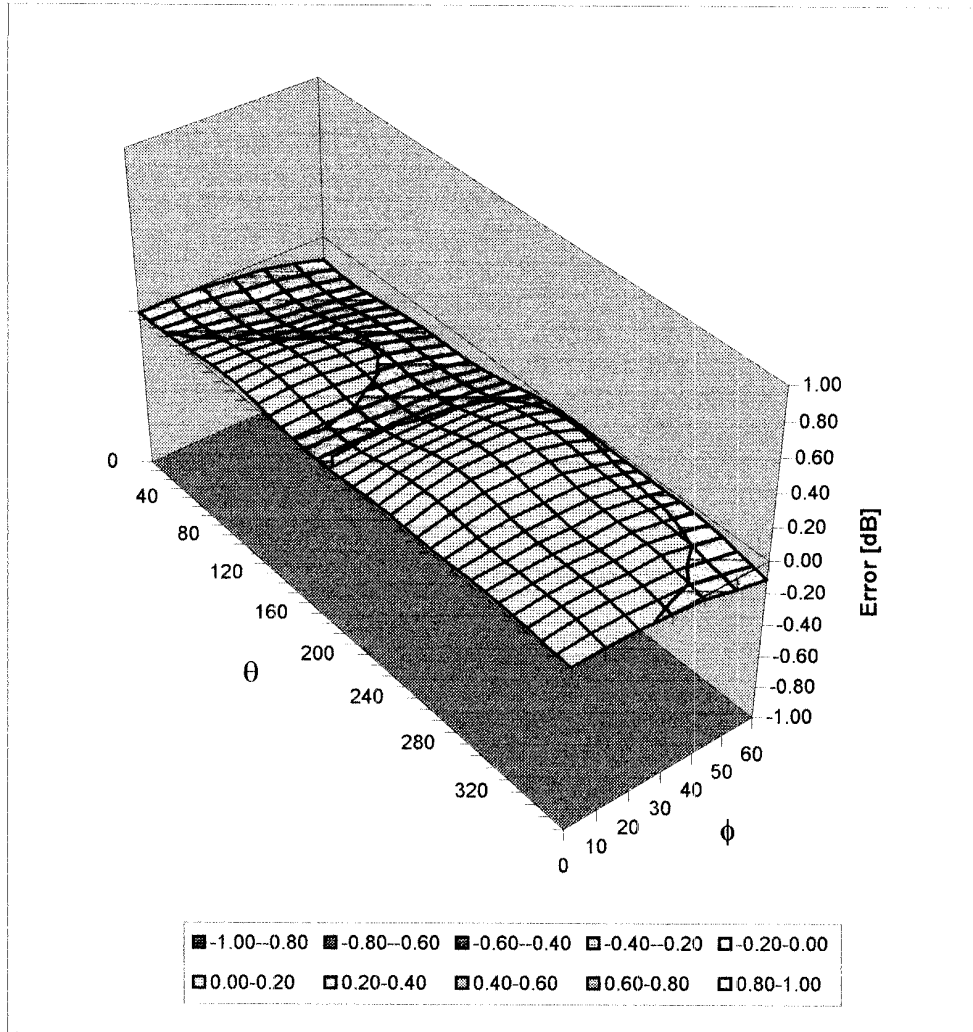

Additional Conversion Factors for Dosimetric E-Field Probe

Type:

ET3DV6

Serial Number:

1590

Place of Assessment:

Zurich

Date of Assessment:

May 1, 2002

Probe Calibration Date:

April 26, 2002

Schmid & Partner Engineering AG hereby certifies that conversion factor(s) of this probe have been evaluated on the date indicated above. The assessment was performed using the FDTD numerical code SEMCAD of Schmid & Partner Engineering AG. Since the evaluation is coupled with measured conversion factors, it has to be recalculated yearly, i.e., following the re-calibration schedule of the probe. The uncertainty of the numerical assessment is based on the extrapolation from measured value at 900 MHz or at 1800 MHz.

Assessed by:

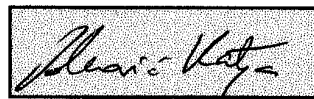

Dosimetric E-Field Probe ET3DV6 SN:1590

Conversion factor (\pm standard deviation)

150 MHz	ConvF	9.4 \pm 8%	$\epsilon_r = 52.3$ $\sigma = 0.76$ mho/m (head tissue)
300 MHz	ConvF	8.2 \pm 8%	$\epsilon_r = 45.3$ $\sigma = 0.87$ mho/m (head tissue)
450 MHz	ConvF	7.8 \pm 8%	$\epsilon_r = 43.5$ $\sigma = 0.87$ mho/m (head tissue)
150 MHz	ConvF	9.1 \pm 8%	$\epsilon_r = 61.9$ $\sigma = 0.80$ mho/m (body tissue)
450 MHz	ConvF	7.9 \pm 8%	$\epsilon_r = 56.7$ $\sigma = 0.94$ mho/m (body tissue)
2450 MHz	ConvF	4.5 \pm 8%	$\epsilon_r = 39.2$ $\sigma = 1.80$ mho/m (head tissue)
2450 MHz	ConvF	4.1 \pm 8%	$\epsilon_r = 52.7$ $\sigma = 1.95$ mho/m (body tissue)

APPENDIX E - MEASURED FLUID DIELECTRIC PARAMETERS

900MHz System Performance Check

Measured Fluid Dielectric Parameters (Brain)

February 11, 2003

Frequency	ϵ'	ϵ''
800.000000 MHz	42.1740	19.7156
810.000000 MHz	42.0933	19.7013
820.000000 MHz	41.9317	19.6725
830.000000 MHz	41.8074	19.6084
840.000000 MHz	41.6626	19.5887
850.000000 MHz	41.5291	19.5567
860.000000 MHz	41.4146	19.5412
870.000000 MHz	41.2620	19.4866
880.000000 MHz	41.1726	19.4965
890.000000 MHz	41.0479	19.4769
900.000000 MHz	40.9714	19.3895
910.000000 MHz	40.8670	19.3664
920.000000 MHz	40.7501	19.2749
930.000000 MHz	40.6708	19.2660
940.000000 MHz	40.5484	19.2325
950.000000 MHz	40.4001	19.2273
960.000000 MHz	40.3158	19.2033
970.000000 MHz	40.1948	19.1730
980.000000 MHz	40.0876	19.1766
990.000000 MHz	39.9922	19.1632
1.000000000 GHz	39.9056	19.0976

835MHz EUT Evaluation (Body)

Measured Fluid Dielectric Parameters (Muscle)

February 11, 2003

Frequency	ϵ'	ϵ''
735.000000 MHz	55.2522	21.3305
745.000000 MHz	55.1502	21.2742
755.000000 MHz	55.0243	21.2391
765.000000 MHz	54.8962	21.1469
775.000000 MHz	54.7944	21.1179
785.000000 MHz	54.6730	21.0850
795.000000 MHz	54.6008	21.0471
805.000000 MHz	54.5538	20.9894
815.000000 MHz	54.4461	20.9878
825.000000 MHz	54.3696	20.9362
835.000000 MHz	54.2178	20.9241
845.000000 MHz	54.1283	20.8737
855.000000 MHz	53.9724	20.8384
865.000000 MHz	53.8957	20.8285
875.000000 MHz	53.7562	20.8108
885.000000 MHz	53.6668	20.8278
895.000000 MHz	53.6177	20.7085
905.000000 MHz	53.5210	20.6876
915.000000 MHz	53.4192	20.6436
925.000000 MHz	53.3289	20.6320
935.000000 MHz	53.2620	20.5808

APPENDIX F - SAM PHANTOM CERTIFICATE OF CONFORMITY

Schmid & Partner Engineering AG

Zeughausstrasse 43, 8004 Zurich, Switzerland, Phone +41 1 245 97 00, Fax +41 1 245 97 79

Certificate of conformity / First Article Inspection

Item	SAM Twin Phantom V4.0
Type No	QD 000 P40 BA
Series No	TP-1002 and higher
Manufacturer / Origin	Untersee Composites Hauptstr. 69 CH-8559 Fruthwilen Switzerland

Tests

The series production process used allows the limitation to test of first articles. Complete tests were made on the pre-series Type No. QD 000 P40 AA, Serial No. TP-1001 and on the series first article Type No. QD 000 P40 BA, Serial No. TP-1006. Certain parameters have been retested using further series units (called samples).

Test	Requirement	Details	Units tested
Shape	Compliance with the geometry according to the CAD model.	IT'IS CAD File (*)	First article, Samples
Material thickness	Compliant with the requirements according to the standards	2mm +/- 0.2mm in specific areas	First article, Samples
Material parameters	Dielectric parameters for required frequencies	200 MHz – 3 GHz Relative permittivity < 5 Loss tangent < 0.05.	Material sample TP 104-5
Material resistivity	The material has been tested to be compatible with the liquids defined in the standards	Liquid type HSL 1800 and others according to the standard.	Pre-series, First article

Standards

- [1] CENELEC EN 50361
- [2] IEEE P1528-200x draft 6.5
- [3] IEC PT 62209 draft 0.9

(*) The IT'IS CAD file is derived from [2] and is also within the tolerance requirements of the shapes of [1] and [3].

Conformity

Based on the sample tests above, we certify that this item is in compliance with the uncertainty requirements of SAR measurements specified in standard [1] and draft standards [2] and [3].

Date 18.11.2001

Signature / Stamp



**Schmid & Partner
Engineering AG**



Zeughausstrasse 43, CH-8004 Zurich
Tel. +41 1 245 97 00, Fax +41 1 245 97 79