

6 Out of Band Emissions at Antenna Terminals

FCC 22.901(d), 22.917, 24.238(a)

Out of Band Emissions:

The mean power of emissions must be attenuated below the mean power of the unmodulated carrier (P) on any frequency outside the frequency band by at least $(43 + 10 \log P)$ dB, in this case, -13dBm.

6.1 Test Procedure

The RF output of the transmitter was connected to a spectrum analyzer through a calibrated coaxial cable. Sufficient scans were taken to show the out-of-band Emissions, if any, up to 10th harmonic. The EUT was scanned for spurious emissions from 1MHz to 20GHz with sufficient bandwidth and video resolution. Data plots are included. The measurement cable path loss at 20GHz (including an attenuator) was 13dB (11dB at lower frequencies). To larger path loss of 13dB was used for all measurements to be conservative.

Test Setup

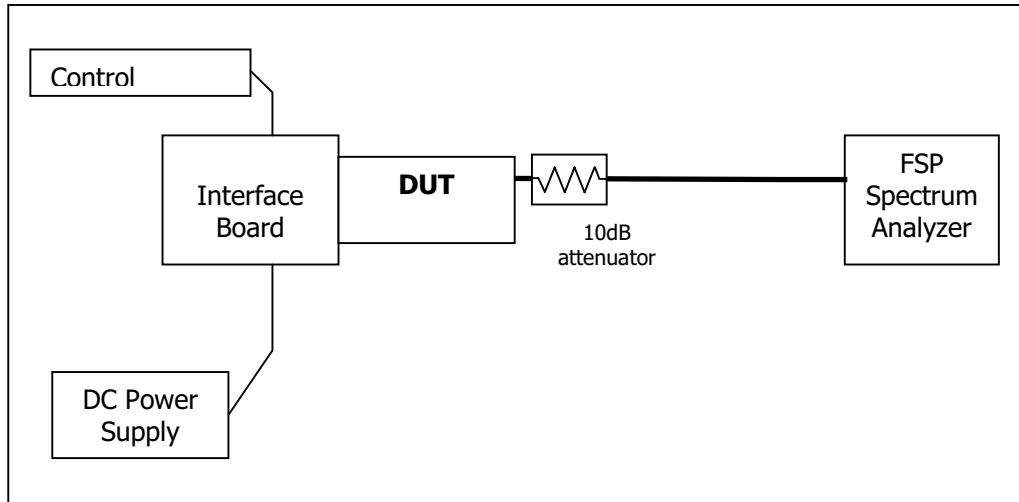

6.2 Test Equipment

EQUIPMENT	MANUFACTURER	MODEL NO.	SERIAL NO.	CAL. DATE
Control Computer	TC	Generic PC	100488	N/A
Wireless Test Set	Rohde & Schwarz	CMU200	836766/030	N/A
Spectrum Analyzer	Rohde & Schwarz	FSP 30GHz	US41421268	Sept. 12, 2003
DC Power Supply	HP	E3631A	100060	N/A
Interface Board	Shop built	Minnow	N/A	N/A
Directional Coupler	Pasternack	PE2209-10	N/A	N/A

SIERRA WIRELESS, INC.

6.3 Test Results

Refer to the following plots.

- **Cellular Band**

Plot Number	Description
6.4.1 – 6.4.3	GMSK Mode, Low channel, 824.20 MHz
6.4.4 – 6.4.6	GMSK Mode, Middle Channel, 836.6 MHz
6.4.7 – 6.4.9	GMSK Mode, High Channel, 848.8 MHz
6.4.10 – 6.4.12	8-PSK Mode, Low channel, 824.20 MHz
6.4.13 – 6.4.15	8-PSK Mode, Middle Channel, 836.6 MHz
6.4.16 – 6.4.18	8-PSK Mode, High Channel, 848.8 MHz

- **PCS Band**

Plot Number	Description
6.4.19 – 6.4.21	GMSK Mode, Low Channel, 1850.2 MHz
6.4.22 – 6.4.24	GMSK Mode, Middle Channel, 1880.0 MHz
6.4.25 – 6.4.27	GMSK Mode, High Channel, 1909.8 MHz
6.4.28 – 6.4.30	8-PSK, Mode, Low Channel, 1850.2 MHz
6.4.31 – 6.4.33	8-PSK Mode, Middle Channel, 1880.0 MHz
6.4.34 – 6.4.36	8-PSK Mode, High Channel, 1909.8 MHz

- **Emissions in Base Station Frequency Range, Cellular band**

Plot Number	Description
6.4.37	GMSK, Low channel, 824.20 MHz
6.4.38	GMSK, Middle Channel, 836.6 MHz
6.4.39	GMSK, High Channel, 848.8 MHz
6.4.40	8-PSK, Low channel, 824.20 MHz
6.4.41	8-PSK, Middle Channel, 836.6 MHz
6.4.42	8-PSK, High Channel, 848.8 MHz

These plots show that the conducted emission limits requirements are met.

6.4 Test Plots

Plot 6.4.1) Out of Band Emissions at Antenna Terminals
 GSMK, Low channel, 824.200 MHz, 1 MHz to 1 GHz

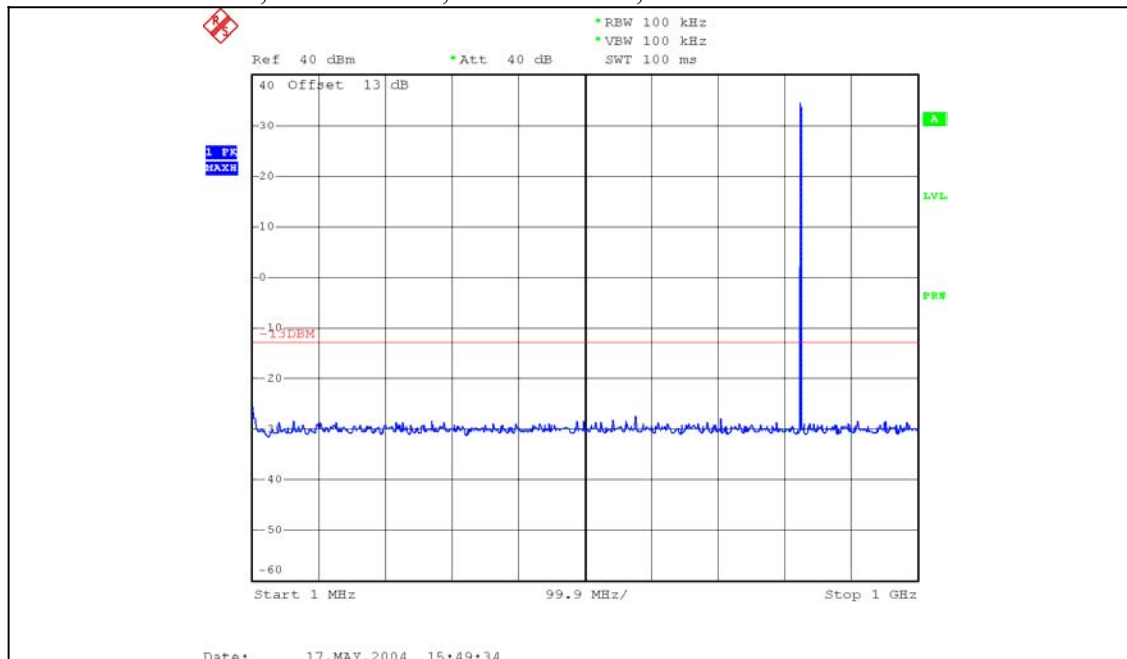

Plot 6.4.2) Out of Band Emissions at Antenna Terminals
 GSMK, Low channel, 824.200 MHz, TX signal +/- 20 MHz

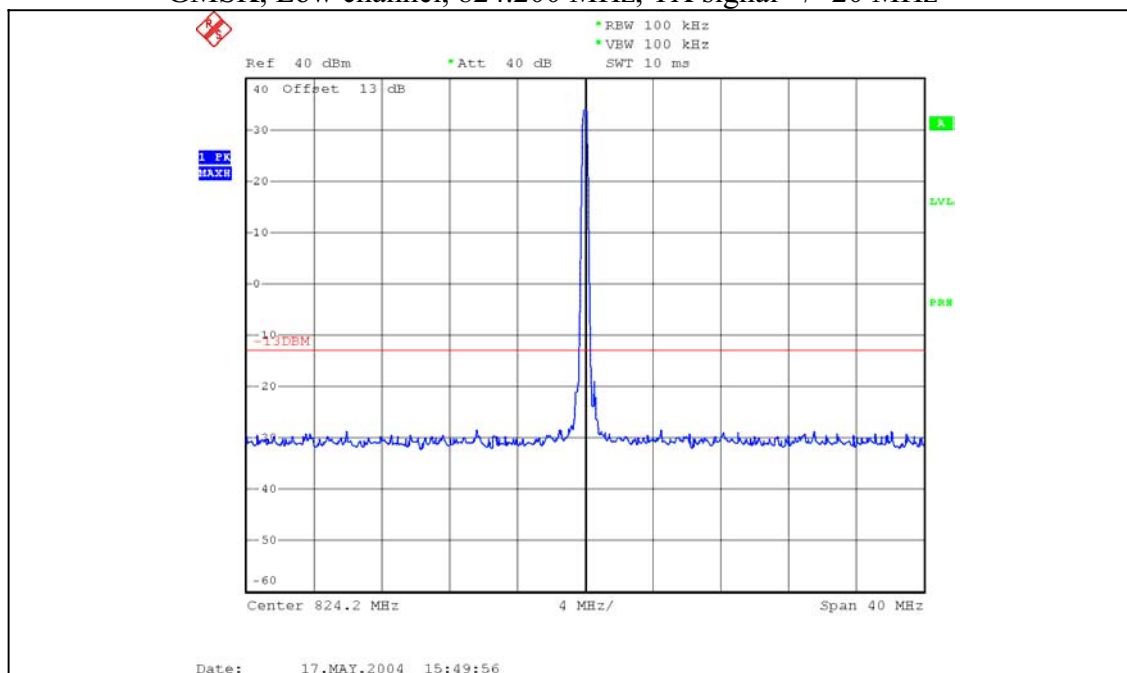

Strong emission shown in each case is the carrier signal.

Plot 6.4.4) Out of Band Emissions at Antenna Terminals
 GMSK, Mid Channel, 836.6 MHz, 1 MHz to 1 GHz

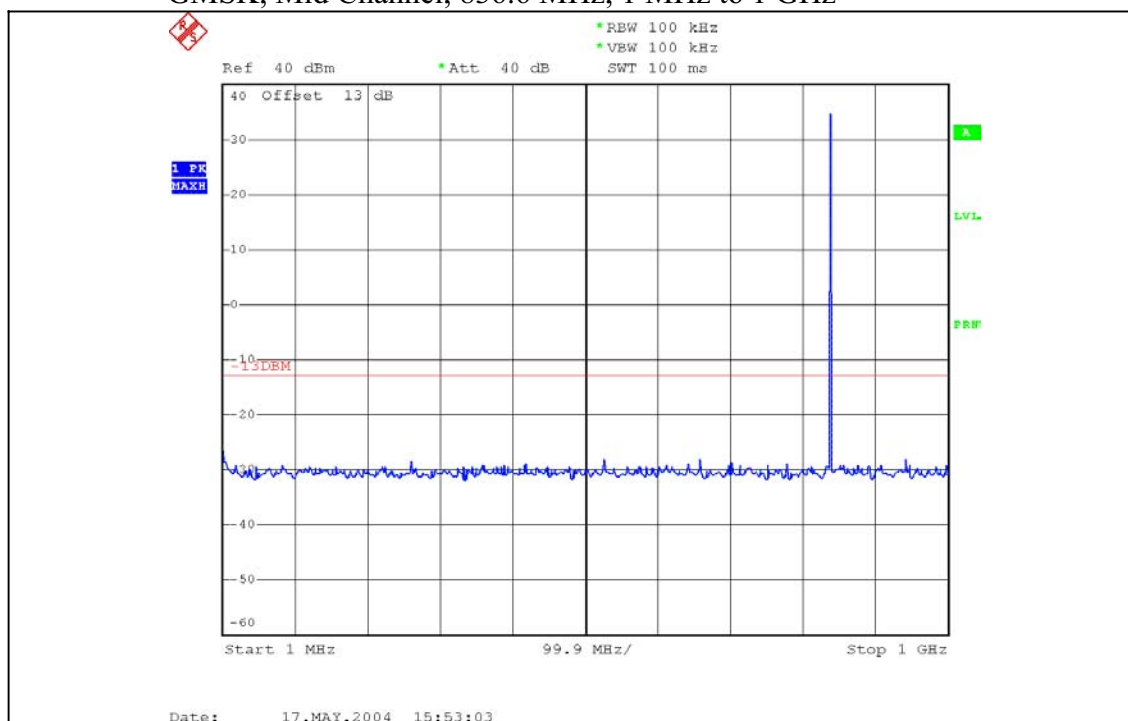

Plot 6.4.5) Out of Band Emissions at Antenna Terminals
 GMSK, Mid Channel, 836.6 MHz, TX signal +/- 20 MHz

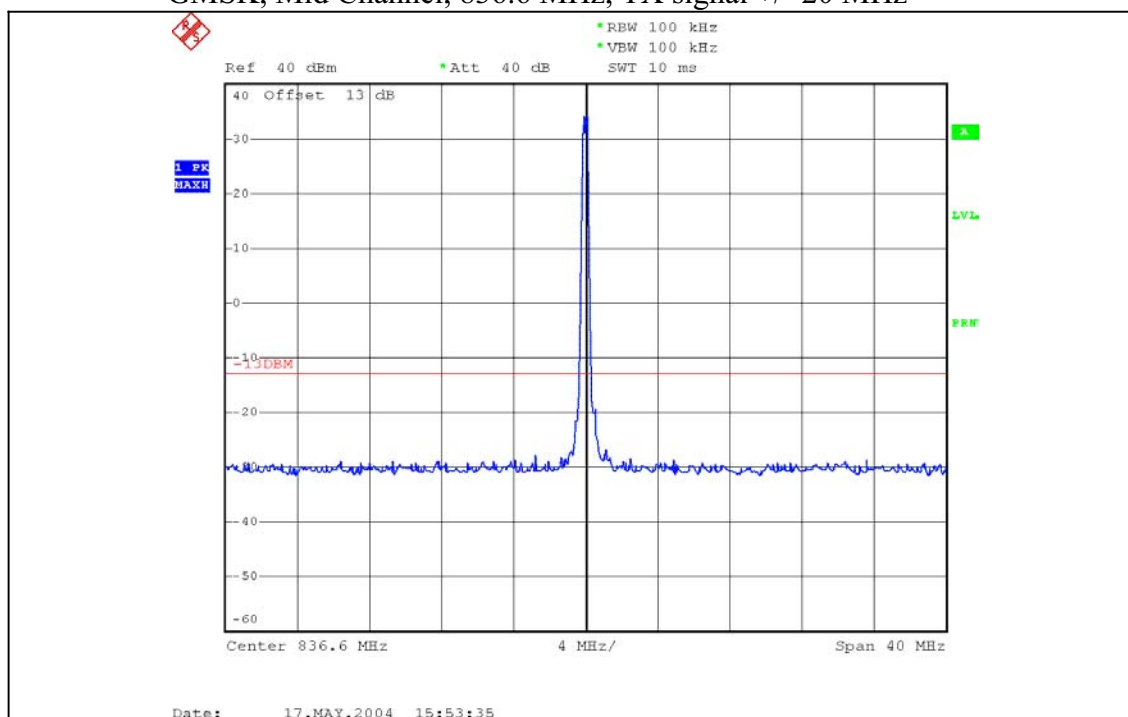

Strong emission shown in each case is the carrier signal.

© 2004 Sierra Wireless, Inc.

The contents of this page are subject to the confidentiality information on page one.

SIERRA WIRELESS, INC.

Plot 6.4.6) Out of Band Emissions at Antenna Terminals
 GSMK, Mid Channel, 836.6 MHz, 1 GHz to 20 GHz

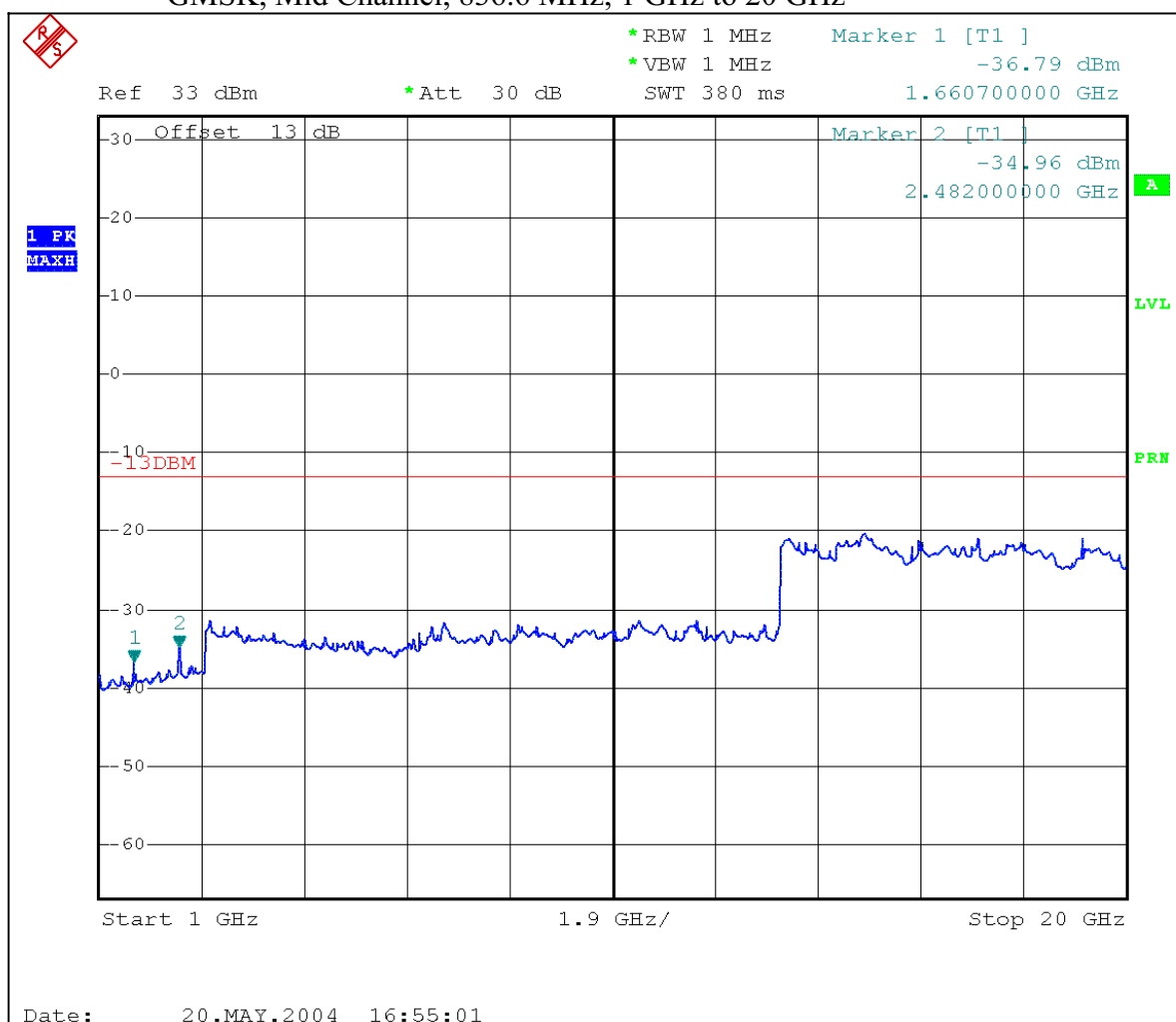

Cellular Harmonics for Ch. 190 (836.6 MHz)	Level (dBm)
Second	-36 dBm
Third	-34 dBm
All others	< -30dBm up to 20GHz

Plot 6.4.7) Out of Band Emissions at Antenna Terminals
 GMSK, High Channel, 848.8 MHz, 1 MHz to 1 GHz

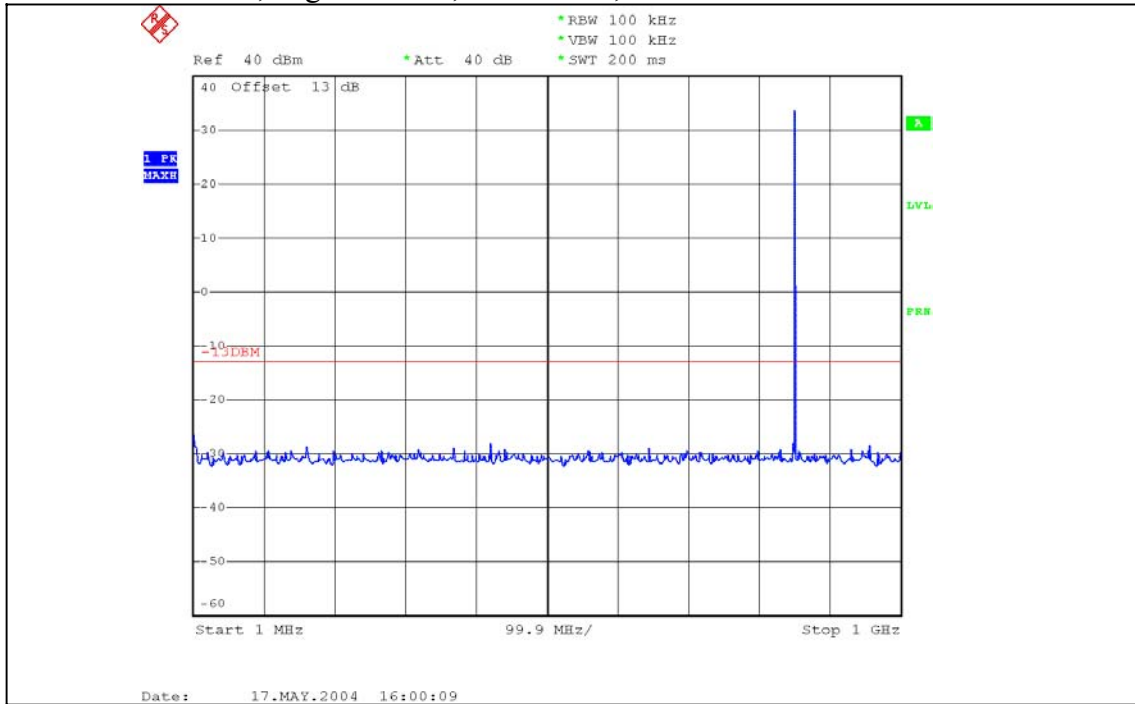

Plot 6.4.8) Out of Band Emissions at Antenna Terminals
 GMSK, High Channel, 848.8 MHz, TX signal +/- 20 MHz

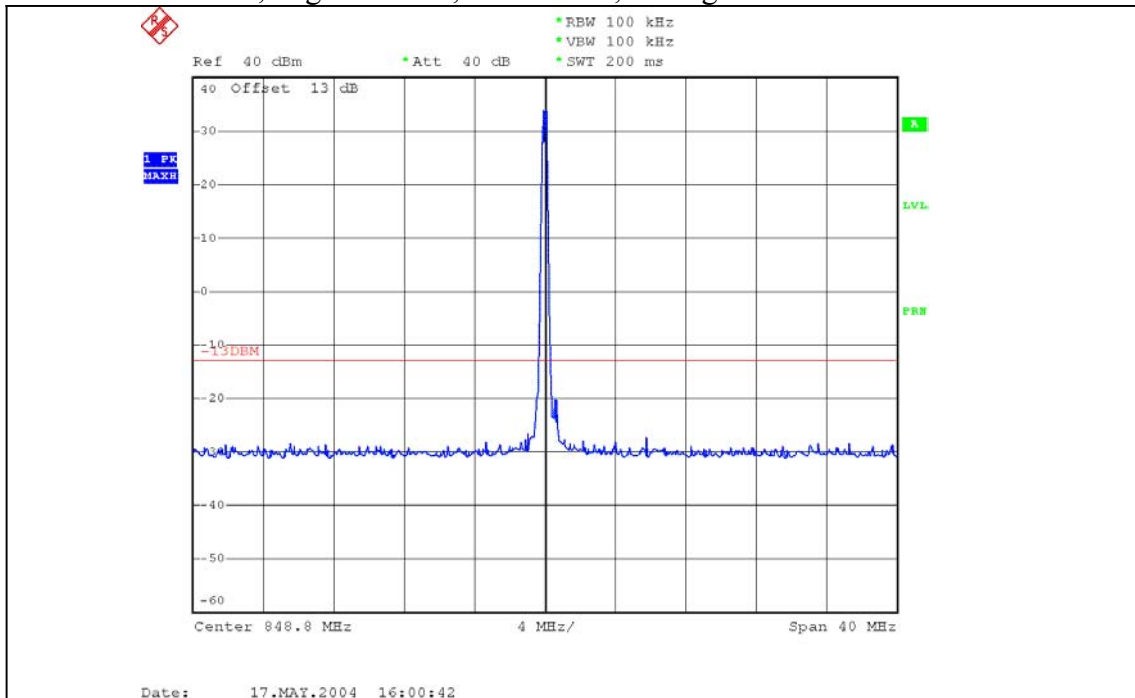

Strong emission shown in each case is the carrier signal.

SIERRA WIRELESS, INC.

Plot 6.4.9) Out of Band Emissions at Antenna Terminals
 GMSK, High Channel, 848.8 MHz, 1 GHz to 20 GHz

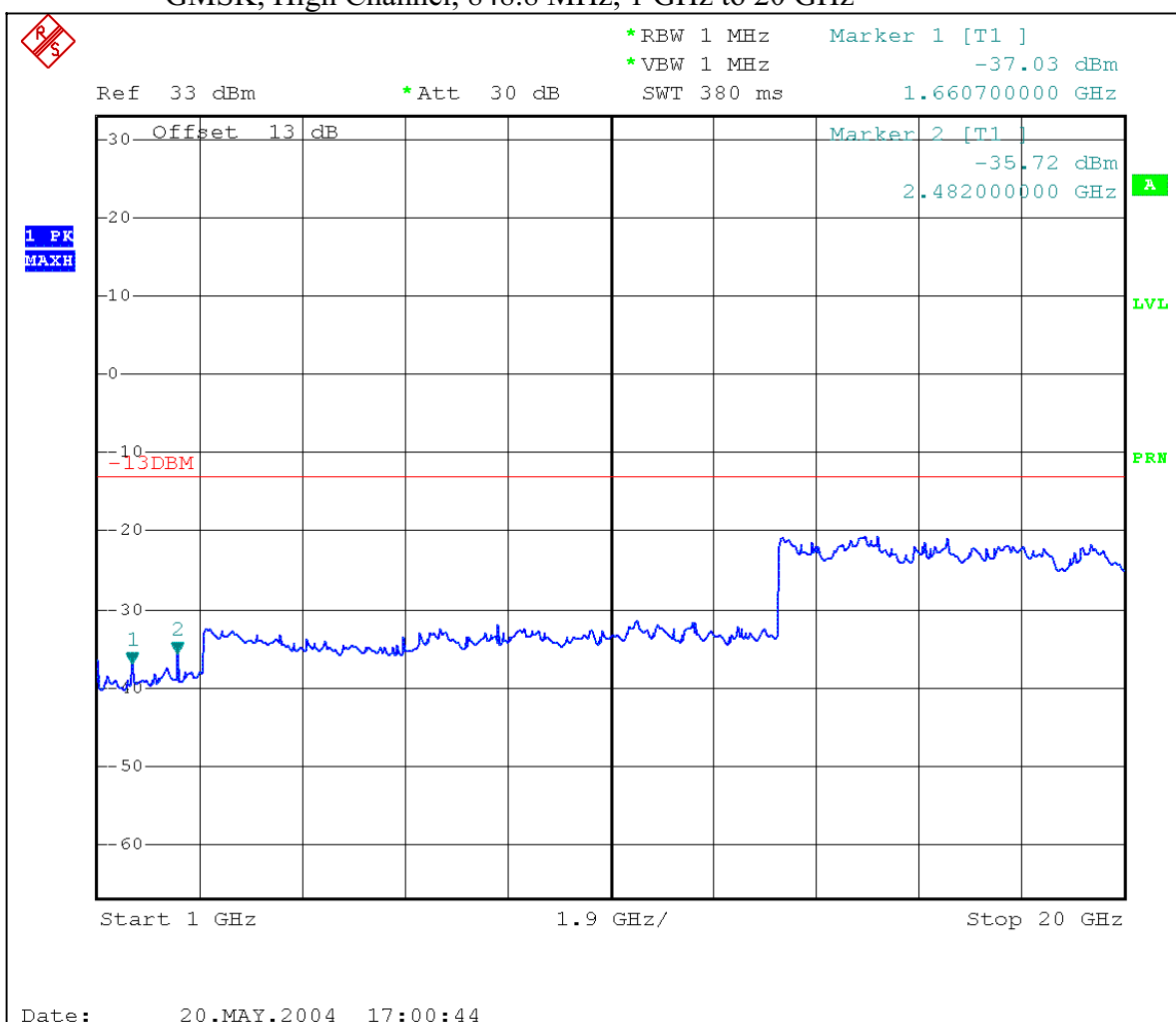

Cellular Harmonics for Ch. 251 (848.8 MHz)	Level (dBm)
Second	-37 dBm
Third	-35 dBm
All others	< -30dBm up to 20GHz

SIERRA WIRELESS, INC.

Plot 6.4.10) Out of Band Emissions at Antenna Terminals
8-PSK, Low channel, 824.200 MHz, 1 MHz to 1 GHz

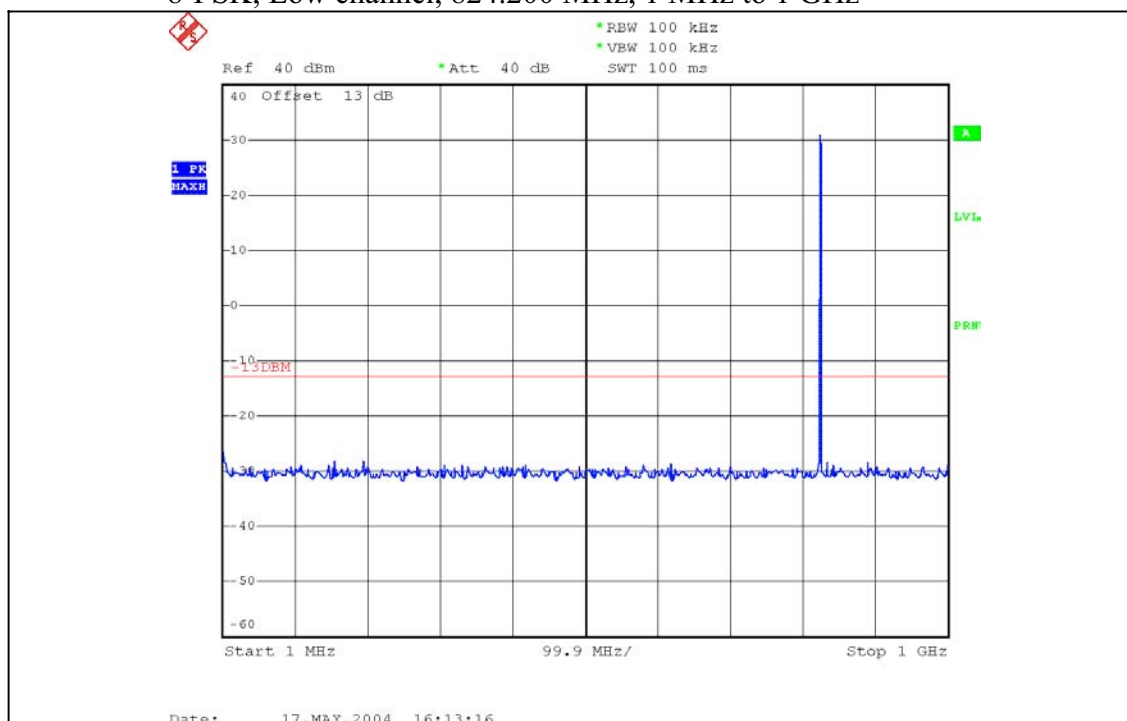

Plot 6.4.11) Out of Band Emissions at Antenna Terminals
8-PSK, Low channel, 824.200 MHz, TX signal +/- 20 MHz

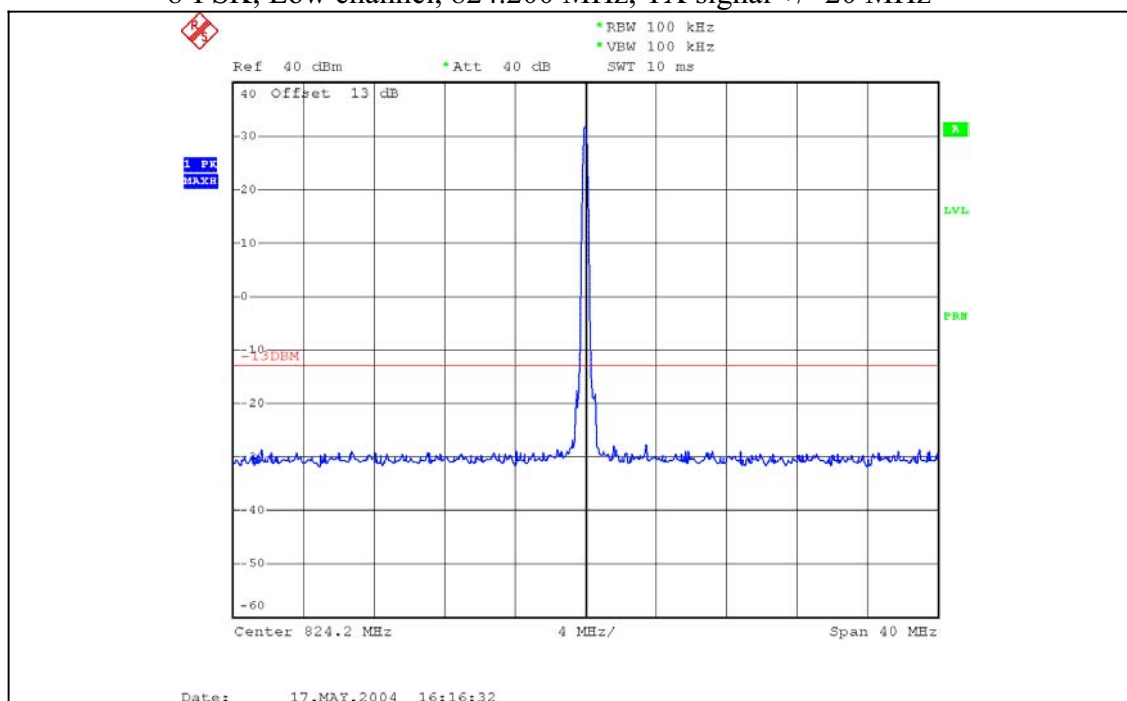

Strong emission shown in each case is the carrier signal.

© 2004 Sierra Wireless, Inc.

The contents of this page are subject to the confidentiality information on page one.

SIERRA WIRELESS, INC.

Plot 6.4.12) Out of Band Emissions at Antenna Terminals
 8-PSK, Low channel, 824.200 MHz, 1 GHz to 20 GHz

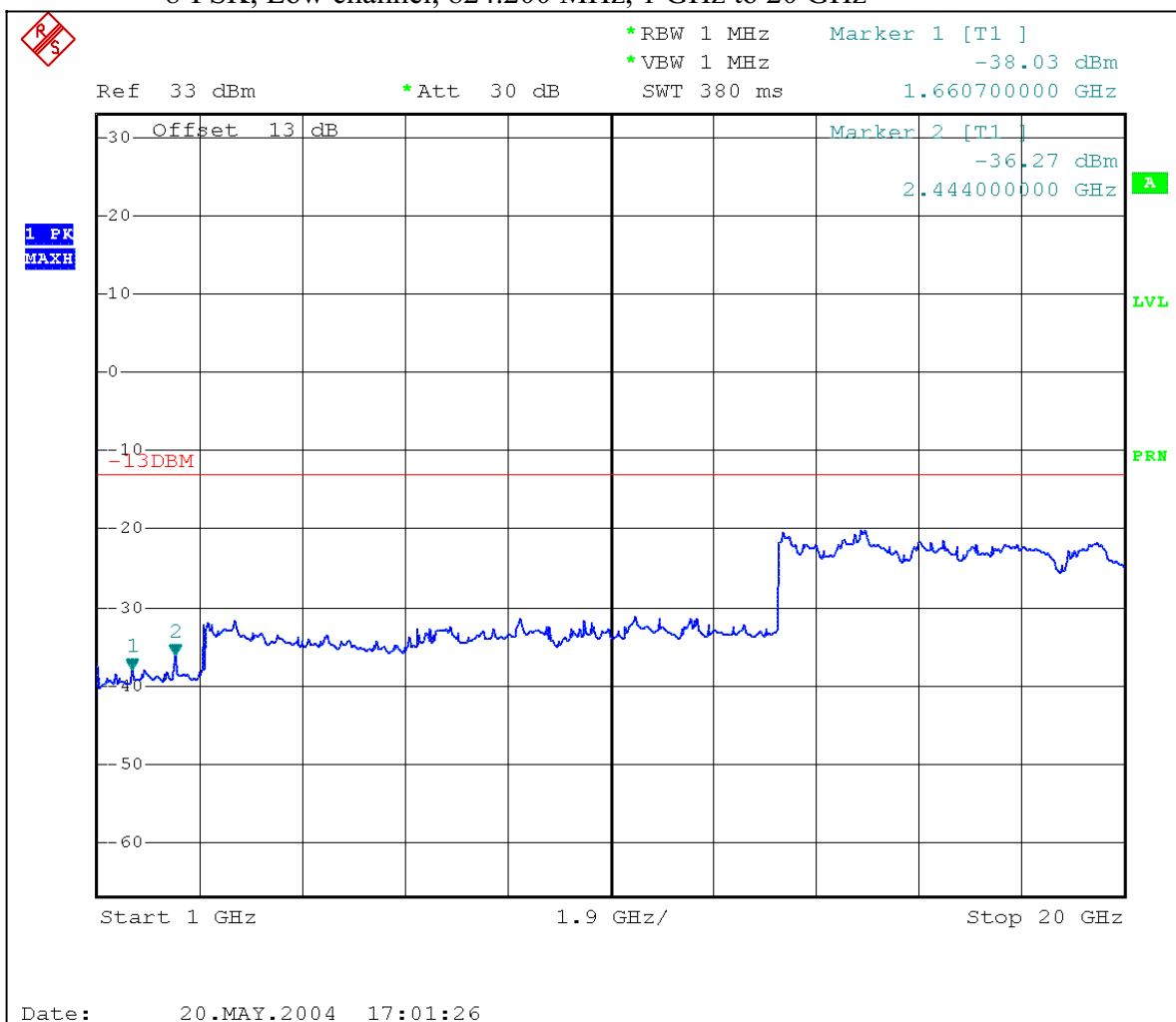

Cellular Harmonics for Ch. 128 (824.2 MHz)	Level (dBm)
Second	-38 dBm
Third	-36 dBm
All others	< -30dBm up to 20GHz

Plot 6.4.13) Out of Band Emissions at Antenna Terminals
 8-PSK, Mid Channel, 836.6 MHz, 1 MHz to 1 GHz

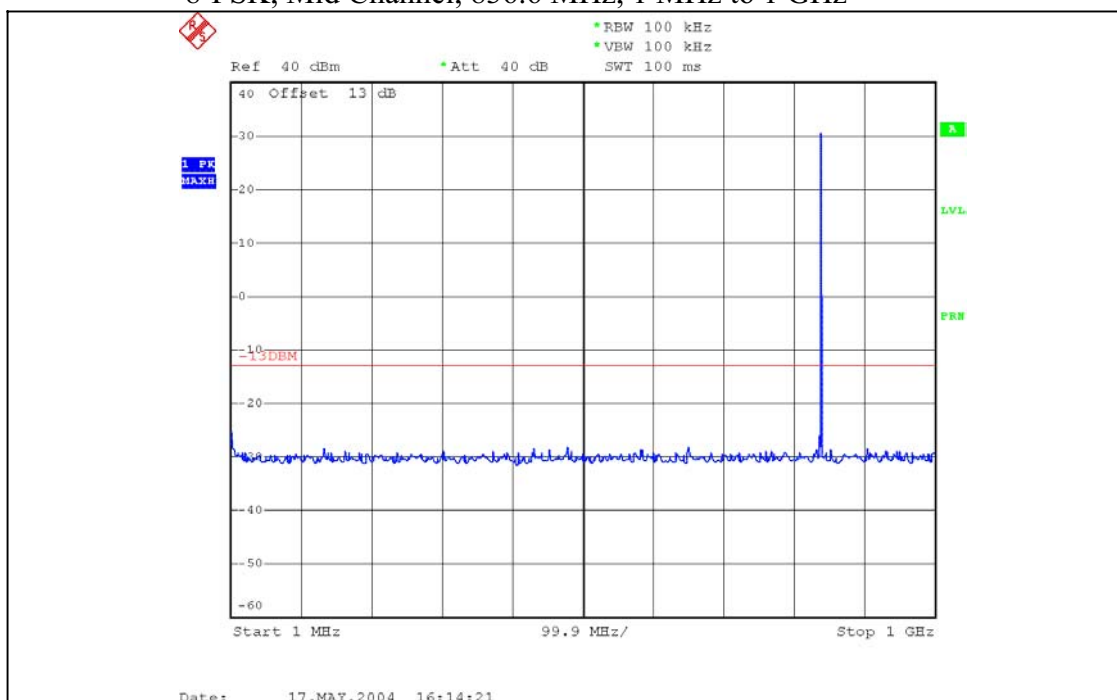

Plot 6.4.14) Out of Band Emissions at Antenna Terminals
 8-PSK, Mid Channel, 836.6 MHz, TX signal +/- 20 MHz

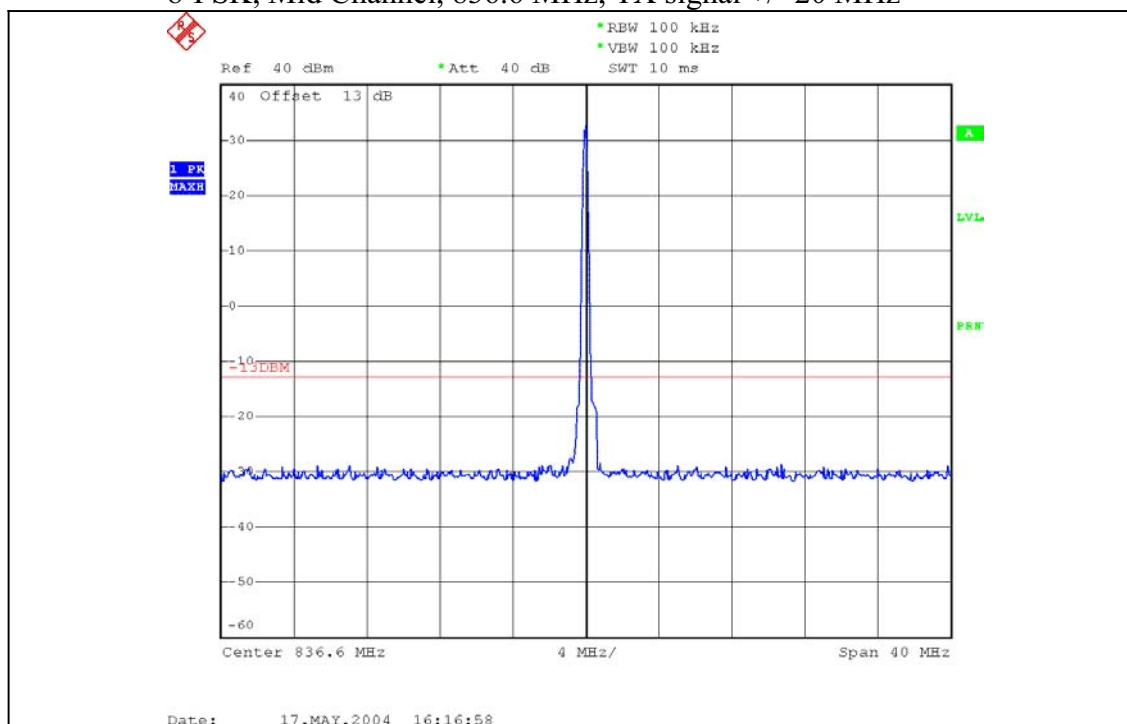

Strong emission shown in each case is the carrier signal.

Plot 6.4.15) Out of Band Emissions at Antenna Terminals
 8-PSK, Mid Channel, 836.6 MHz, 1 GHz to 20 GHz

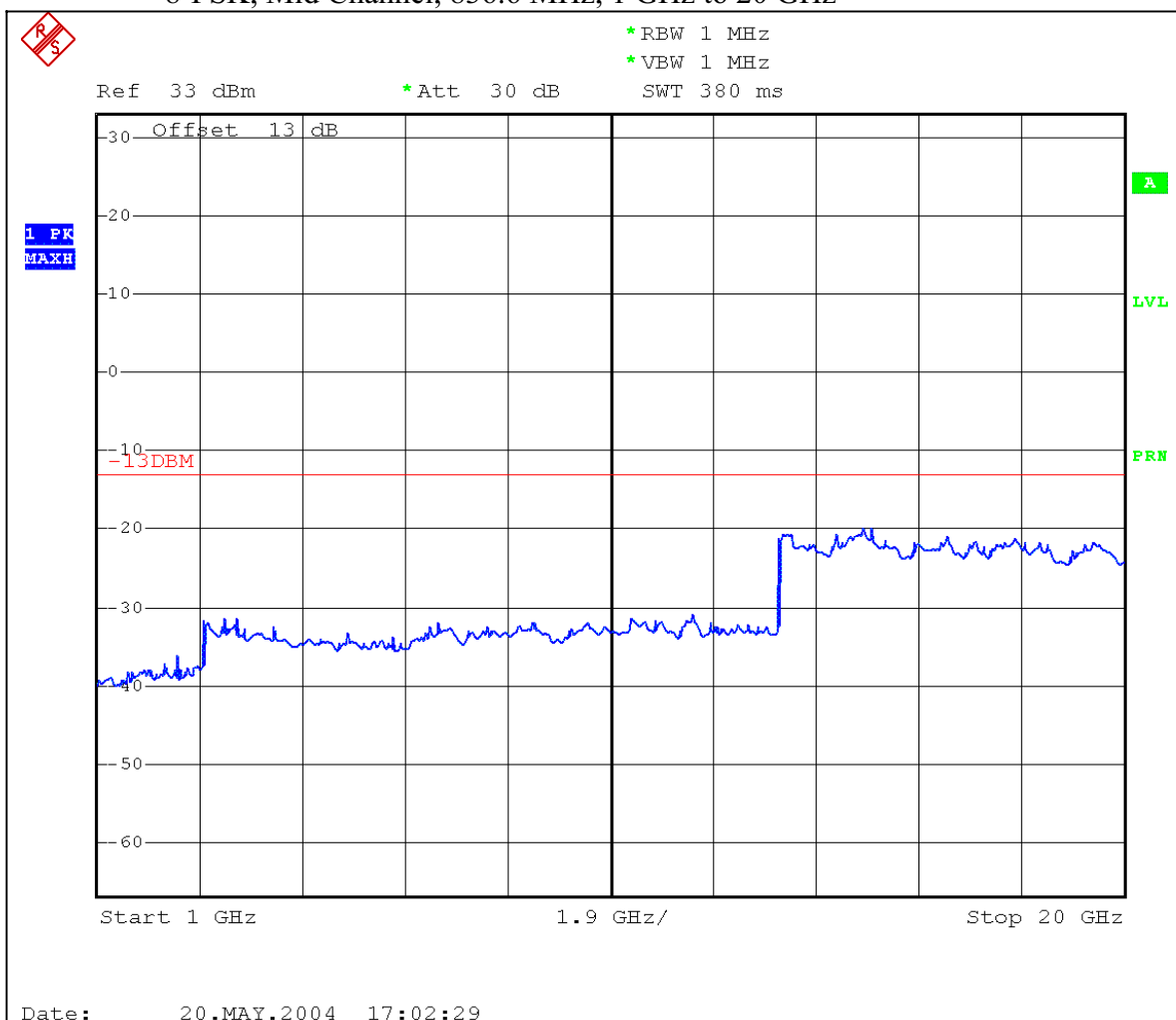

Cellular Harmonics for Ch. 190 (836.6 MHz)	Level (dBm)
Second	--
Third	--
All others	< -30dBm up to 20GHz

Plot 6.4.16) Out of Band Emissions at Antenna Terminals
 8-PSK, High Channel, 848.8 MHz, 1 MHz to 1 GHz

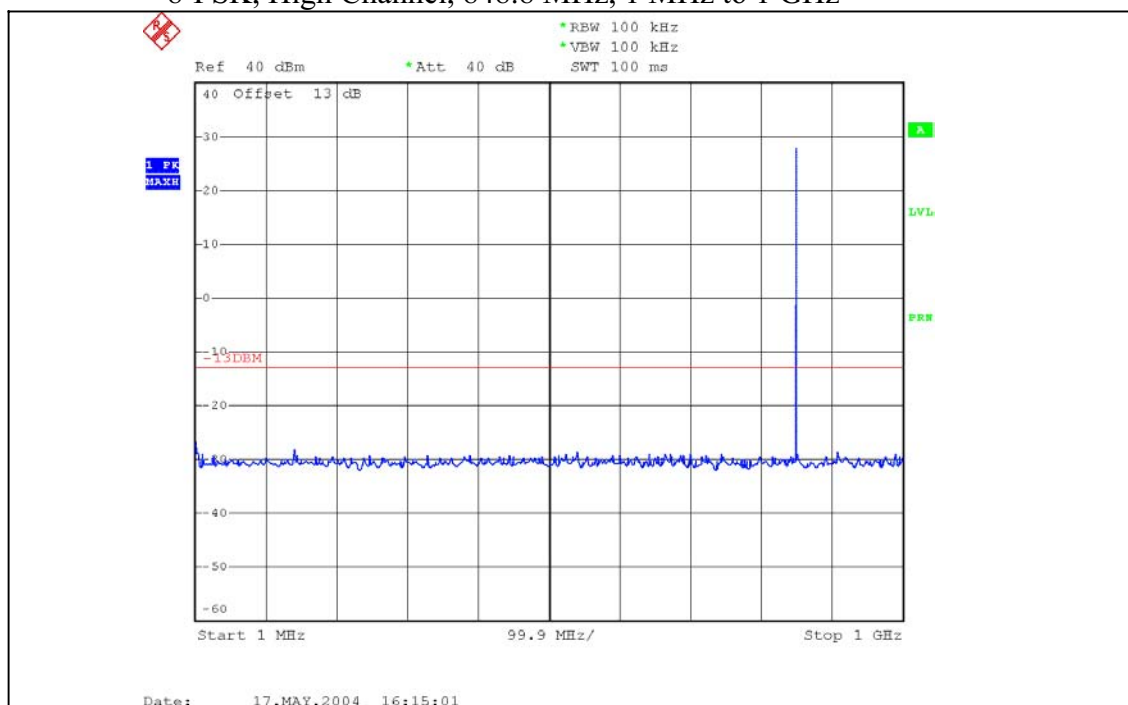

Plot 6.4.17) Out of Band Emissions at Antenna Terminals
 8-PSK, High Channel, 848.8 MHz, TX signal +/- 20 MHz

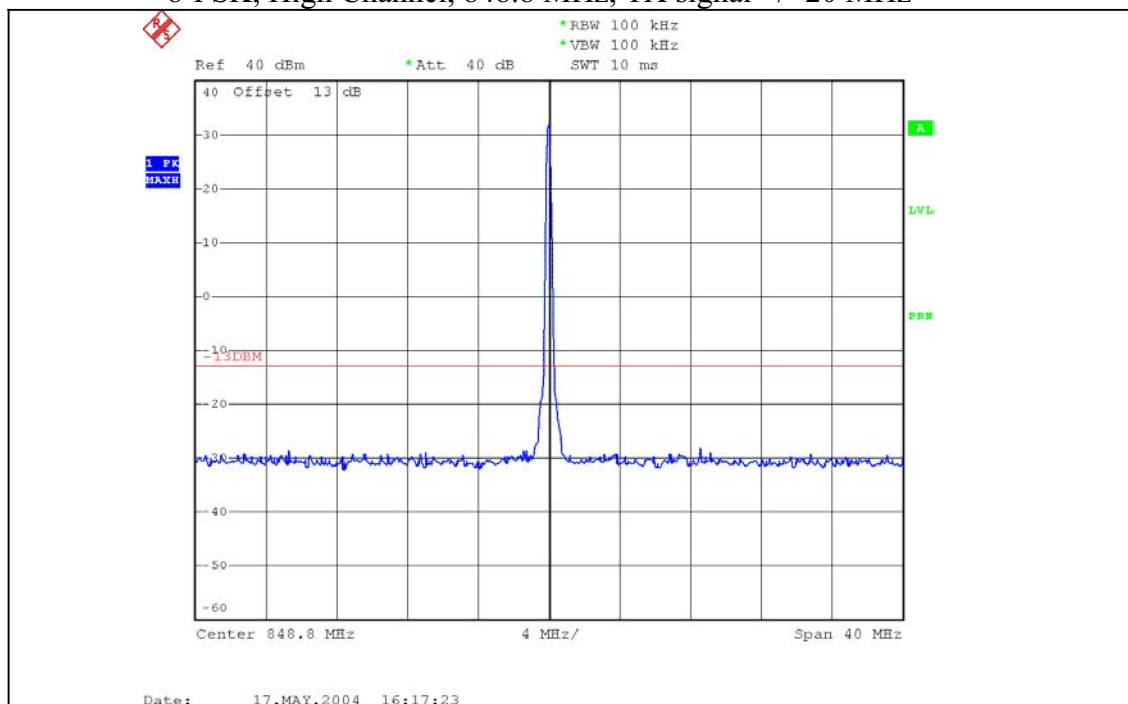

Strong emission shown in each case is the carrier signal.

SIERRA WIRELESS, INC.

Plot 6.4.18) Out of Band Emissions at Antenna Terminals
 8-PSK, High Channel, 848.8 MHz, 1 GHz to 20 GHz

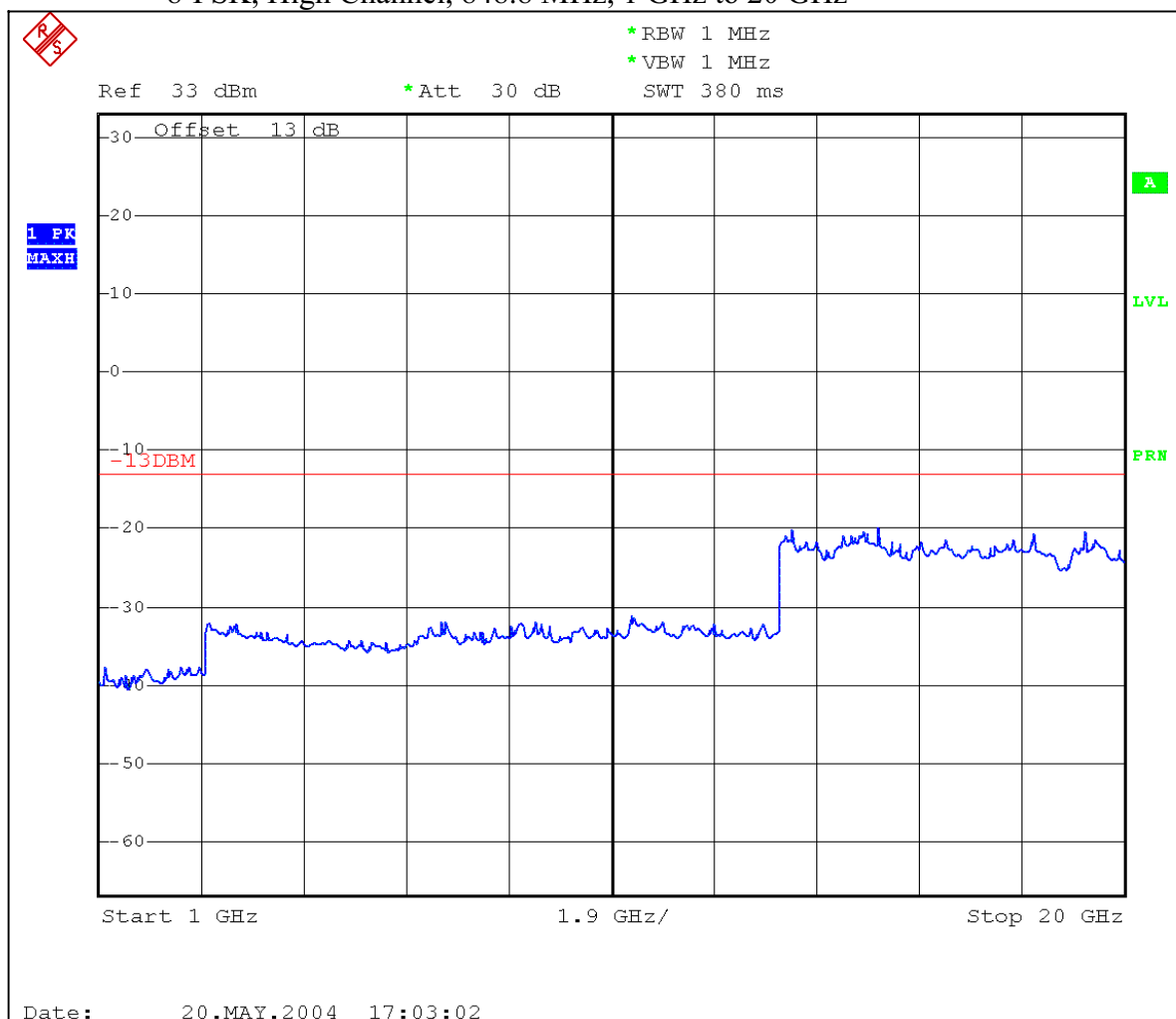

Cellular Harmonics for Ch. 251 (848.8 MHz)	Level (dBm)
Second	--
Third	--
All others	< -30dBm up to 20GHz

Plot 6.4.21) Out of Band Emissions at Antenna Terminals
 GMSK, Low channel, 1850.2 MHz, 1 GHz to 20 GHz

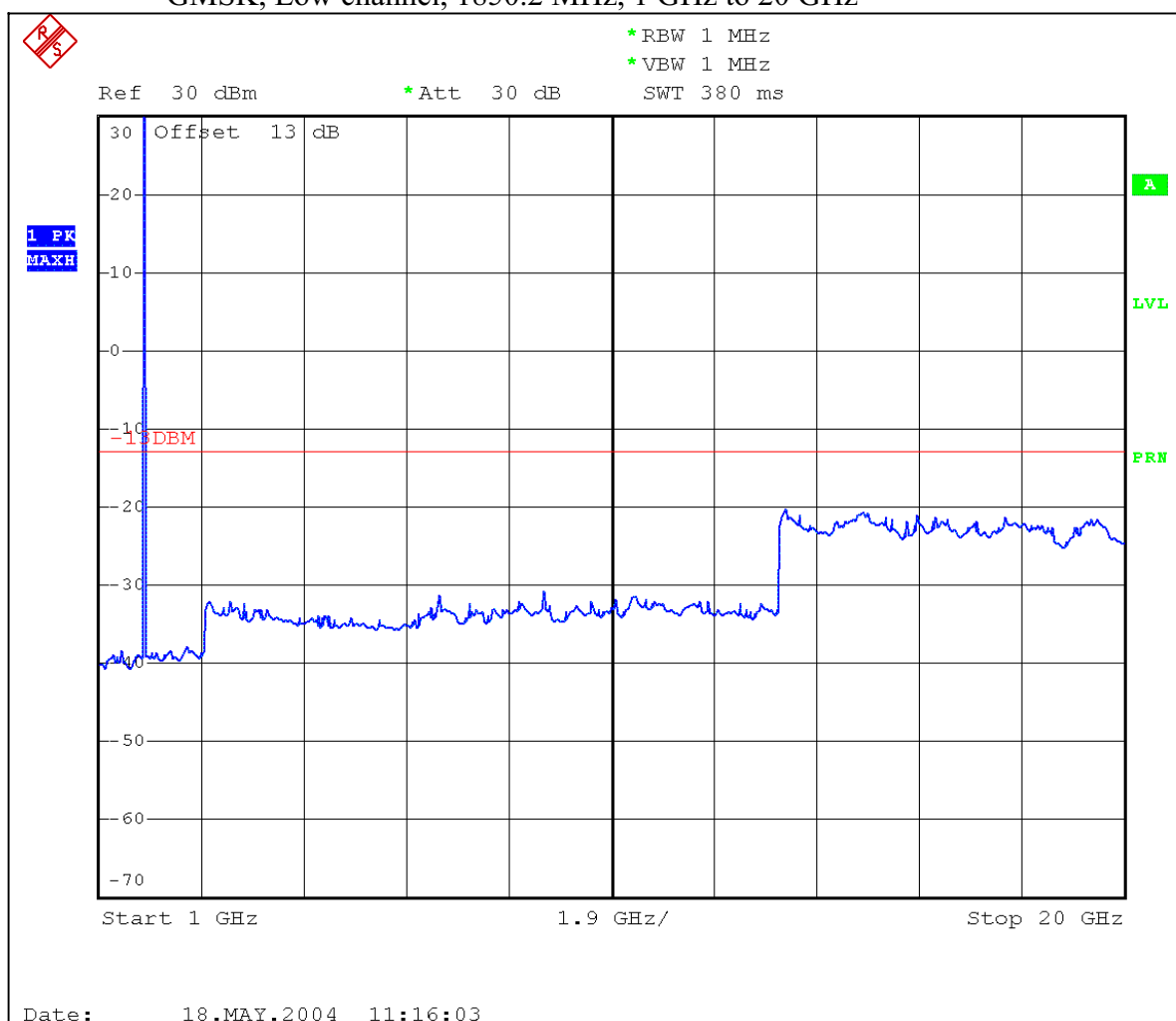

Strong emission shown is the carrier signal.

Plot 6.4.22) Out of Band Emissions at Antenna Terminals
 GMSK, Middle channel, 1880.0 MHz, 1 MHz to 1 GHz

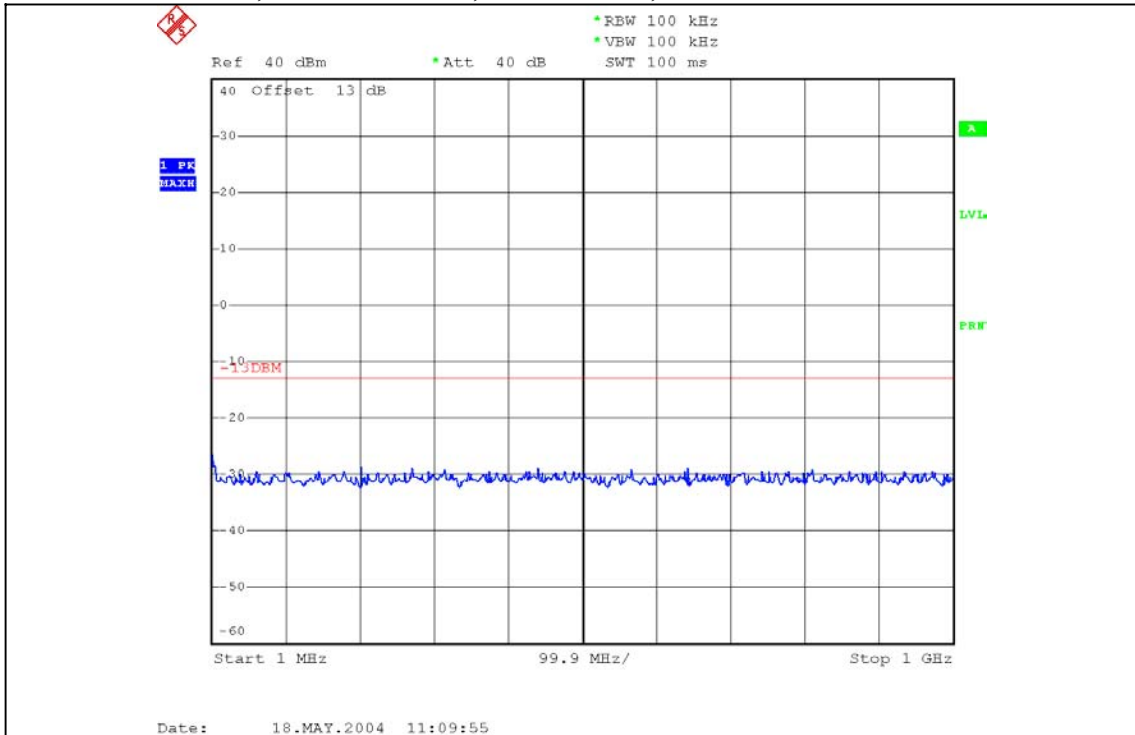

Plot 6.4.23) Out of Band Emissions at Antenna Terminals
 GMSK, Middle channel, 1880.0 MHz, TX signal +/- 20 MHz

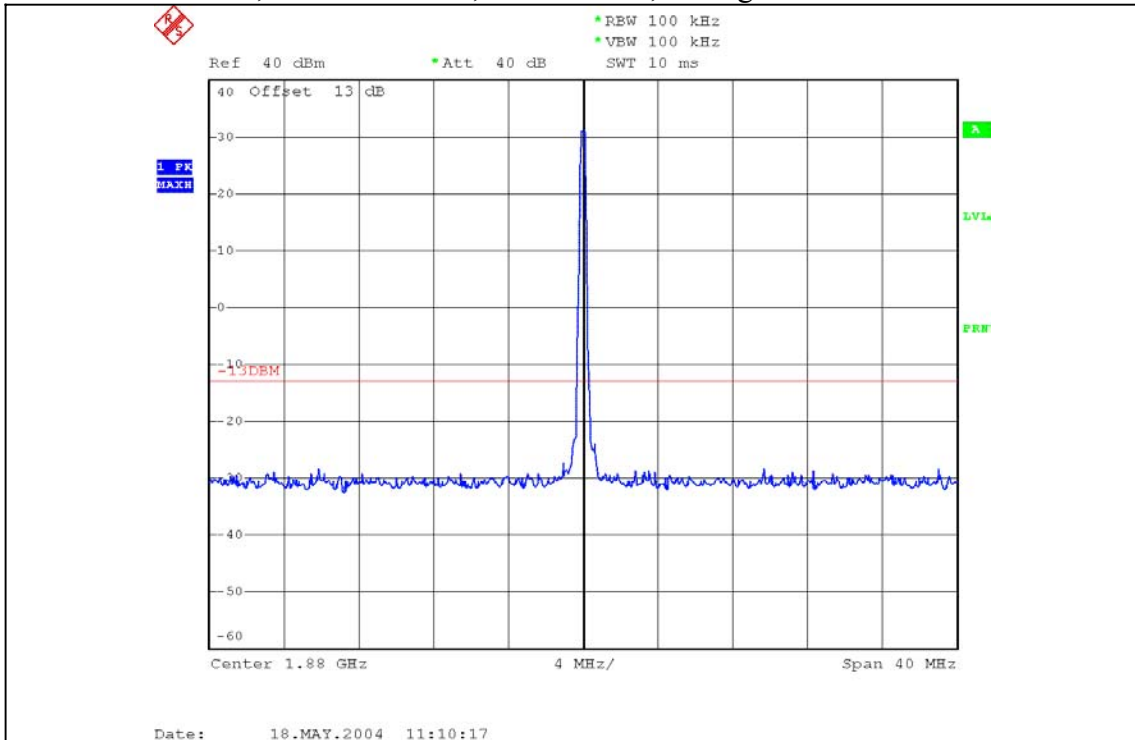

SIERRA WIRELESS, INC.

Plot 6.4.24) Out of Band Emissions at Antenna Terminals
GMSK, Middle channel, 1880.0 MHz, 1 GHz to 20 GHz

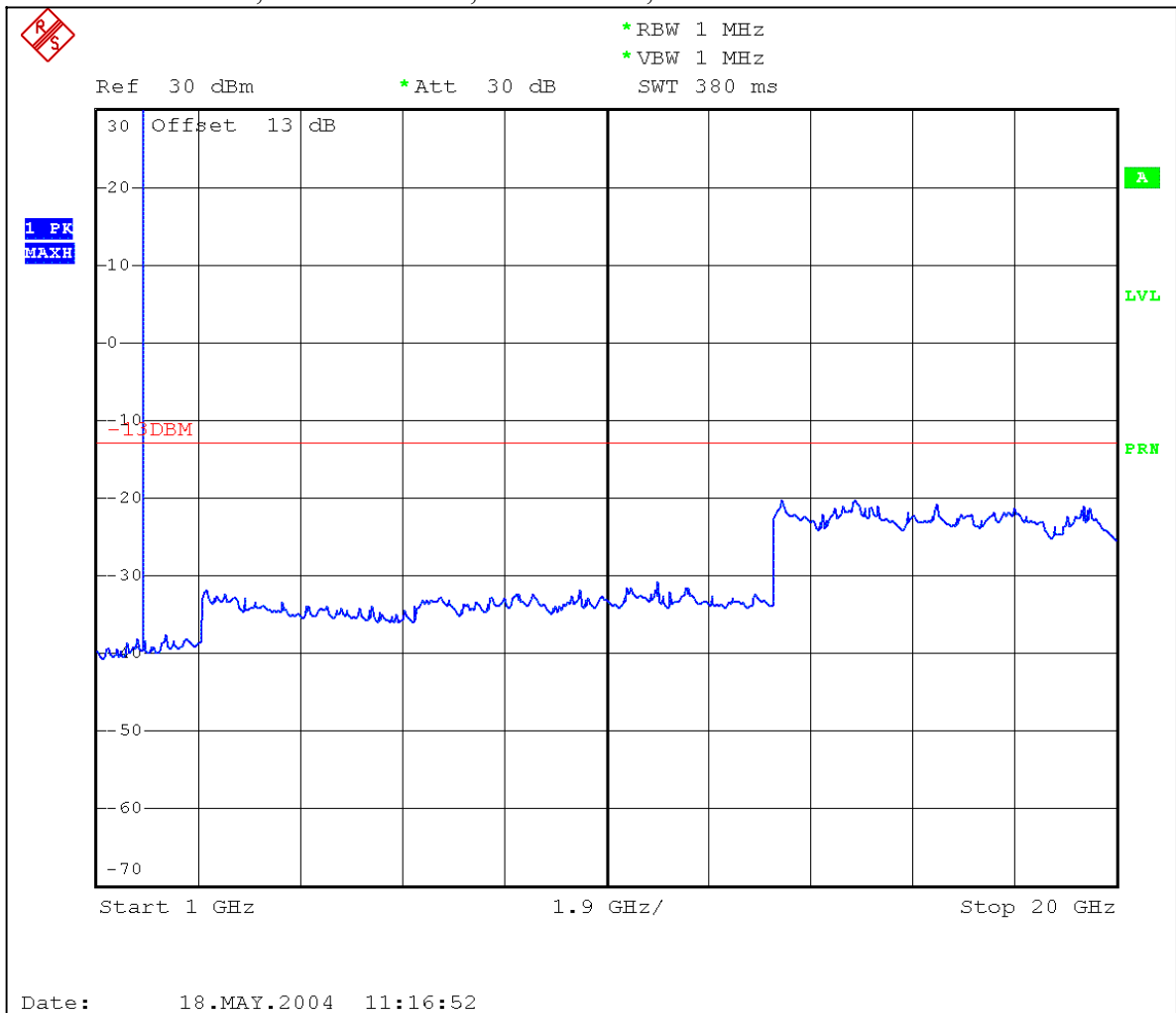

Strong emission shown is the carrier signal.

Plot 6.4.25) Out of Band Emissions at Antenna Terminals
 GMSK, High channel, 1909.8 MHz, 1 MHz to 1 GHz

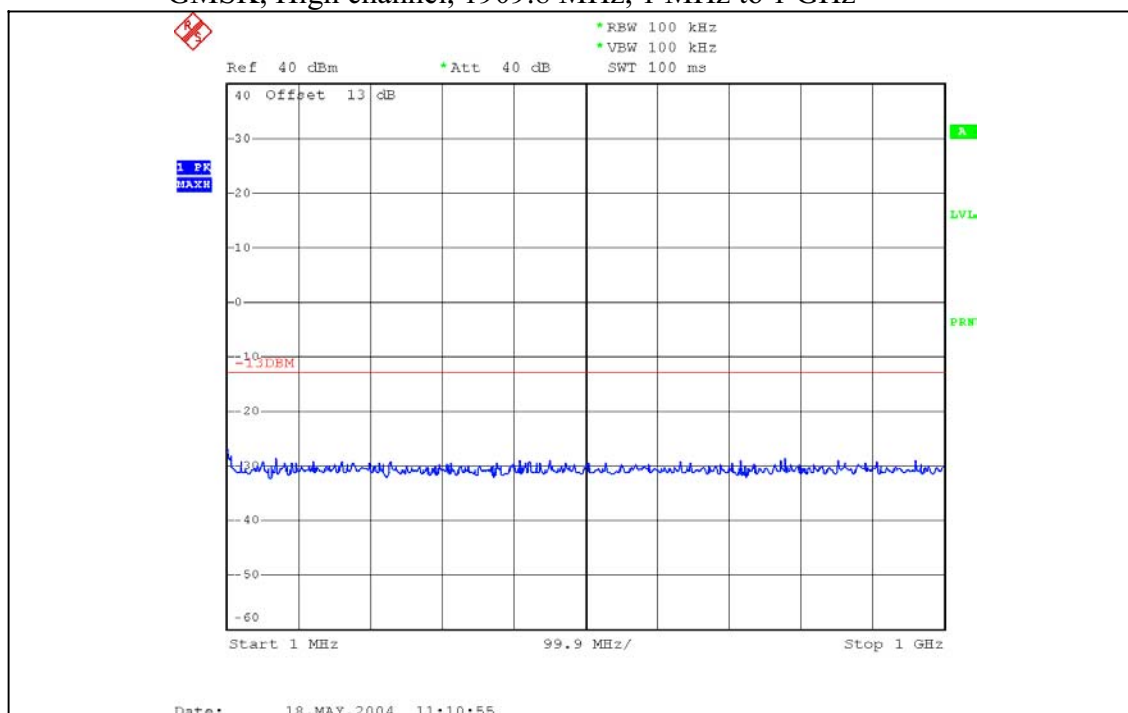

Plot 6.4.26) Out of Band Emissions at Antenna Terminals
 GMSK, High channel, 1909.8 MHz, TX signal +/- 20 MHz

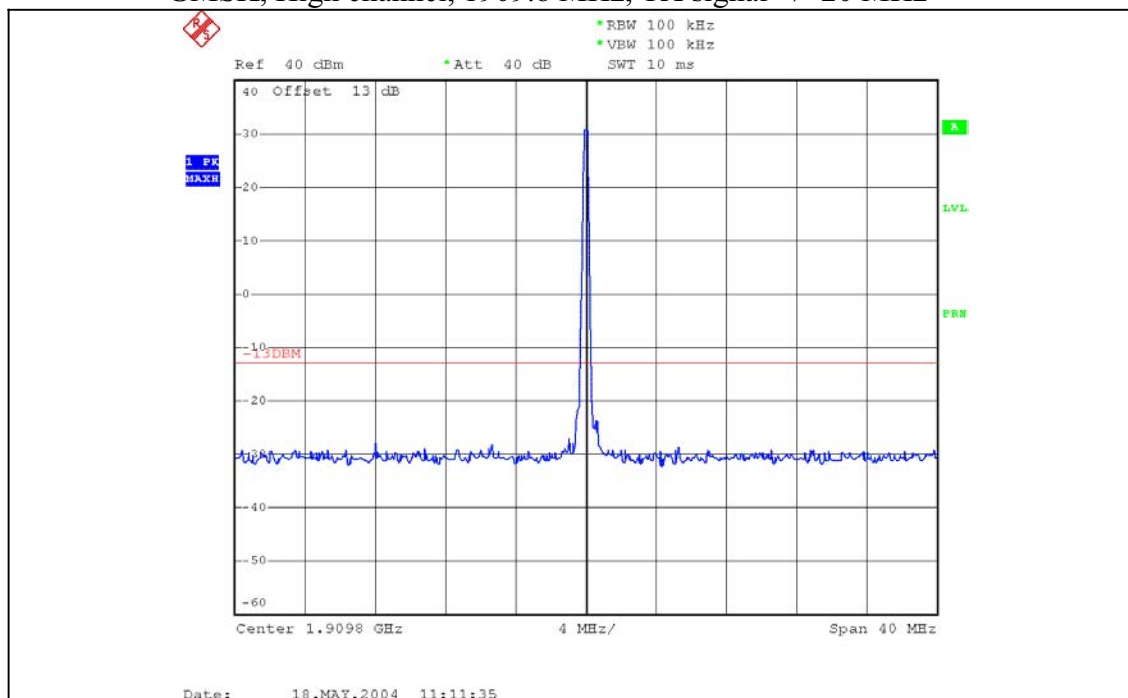

Plot 6.4.27) Out of Band Emissions at Antenna Terminals
GMSK, High channel, 1909.8 MHz, 1 GHz to 20 GHz

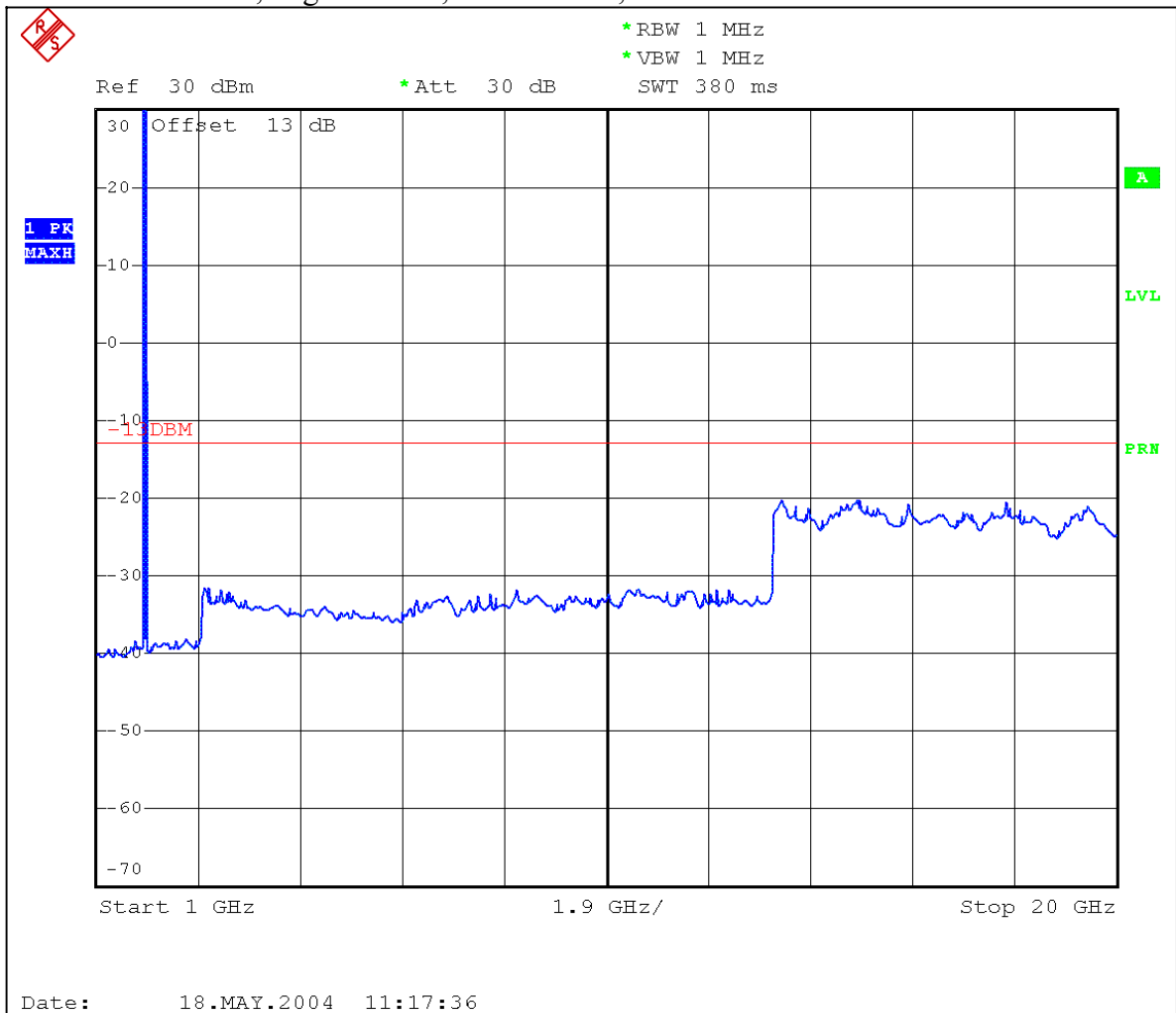

Strong emission shown is the carrier signal.

Plot 6.4.28) Out of Band Emissions at Antenna Terminals
8-PSK, Low channel, 1851.2 MHz, 1 MHz to 1 GHz

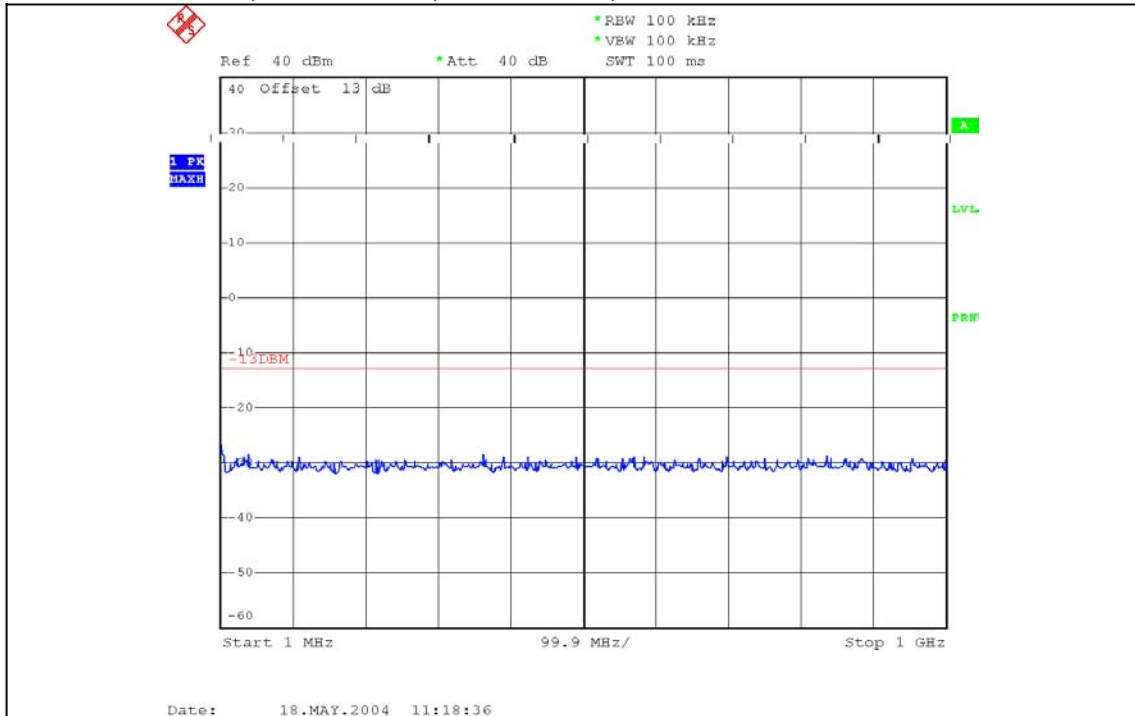

Plot 6.4.29) Out of Band Emissions at Antenna Terminals
8-PSK, Low channel, 1851.2 MHz, TX signal +/- 20 MHz

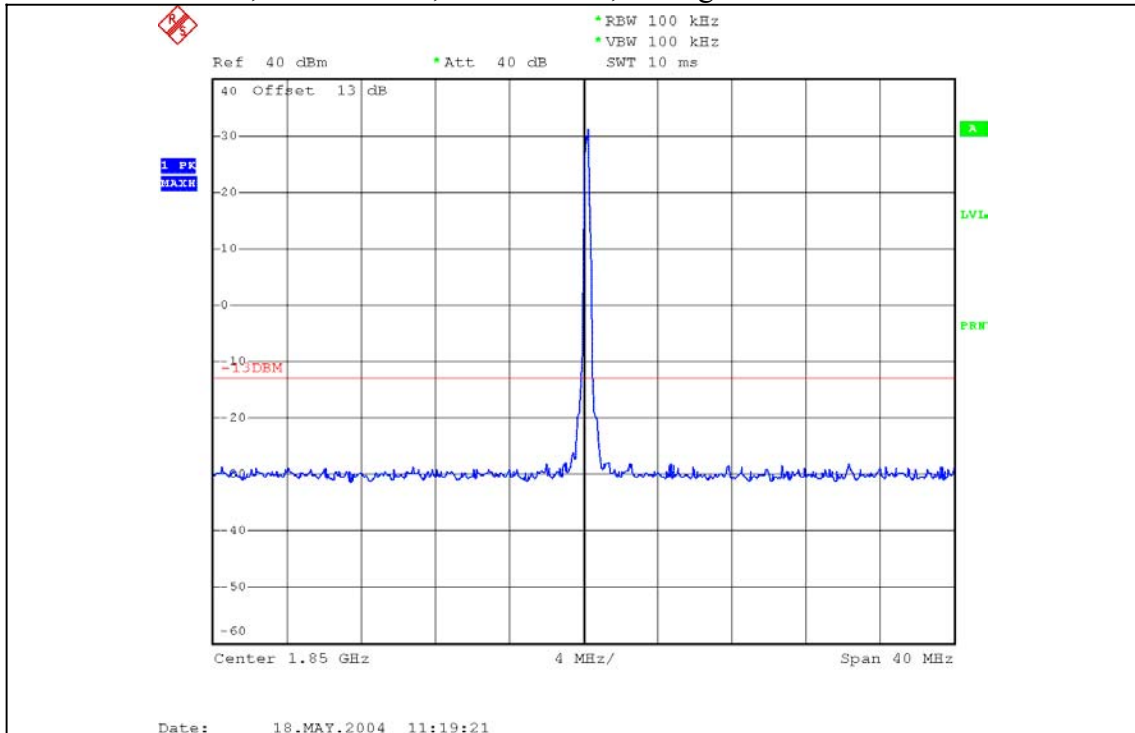

SIERRA WIRELESS, INC.

Plot 6.4.30) Out of Band Emissions at Antenna Terminals
8-PSK, Low channel, 1851.2 MHz, 1 GHz to 20 GHz

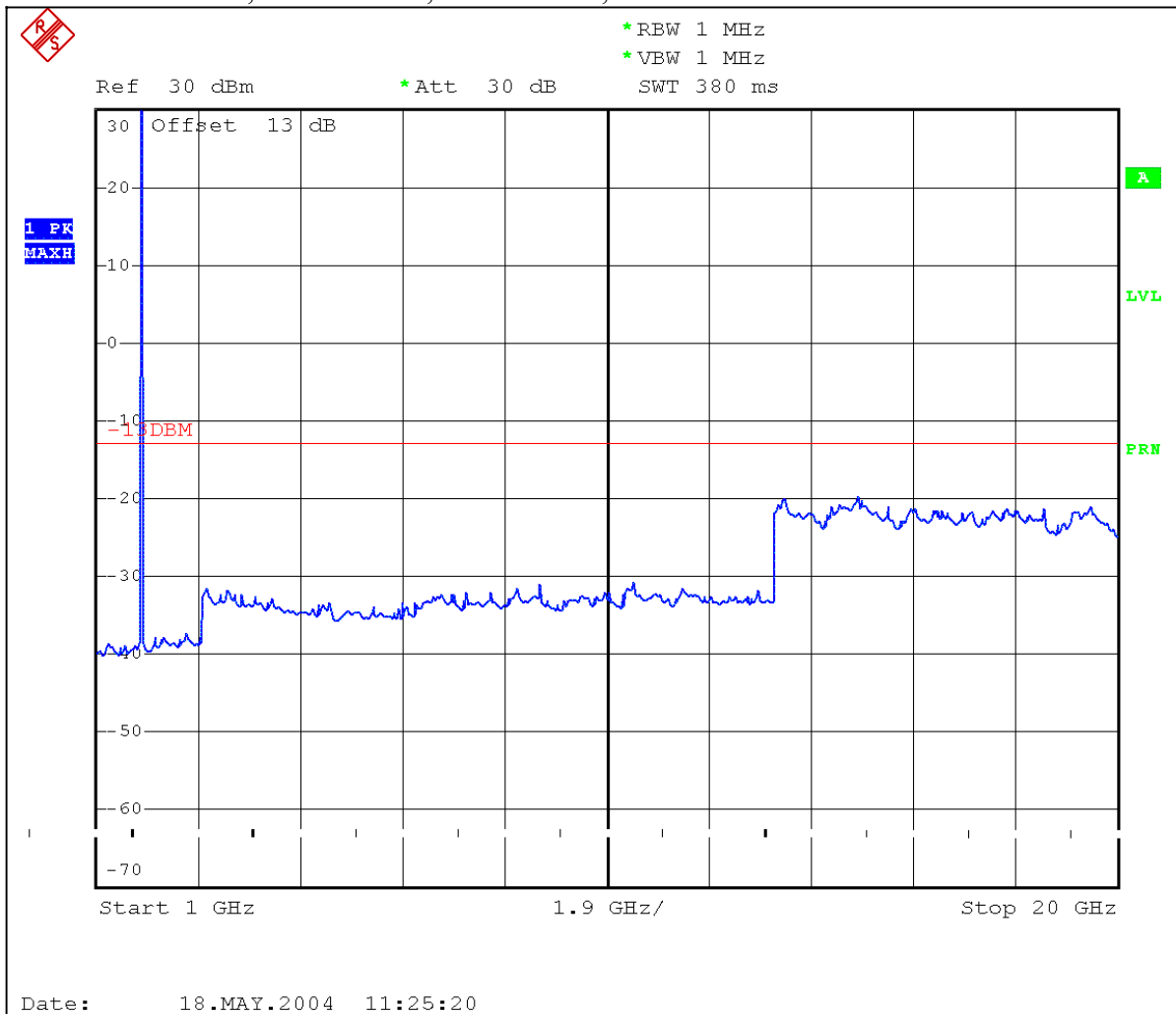

Strong emission shown is the carrier signal.

Plot 6.4.31) Out of Band Emissions at Antenna Terminals
 8-PSK, Middle channel, 1880.0 MHz, 1 MHz to 1 GHz

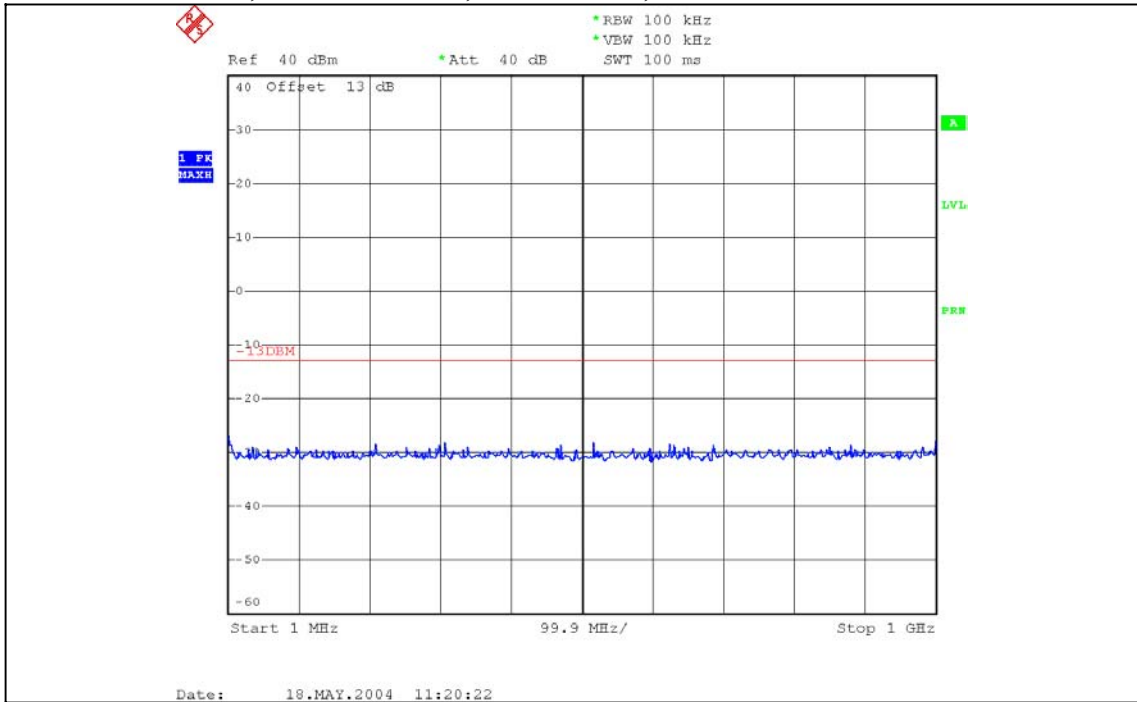

Plot 6.4.32) Out of Band Emissions at Antenna Terminals
 8-PSK, Middle channel, 1880.0 MHz, TX signal +/- 20 MHz

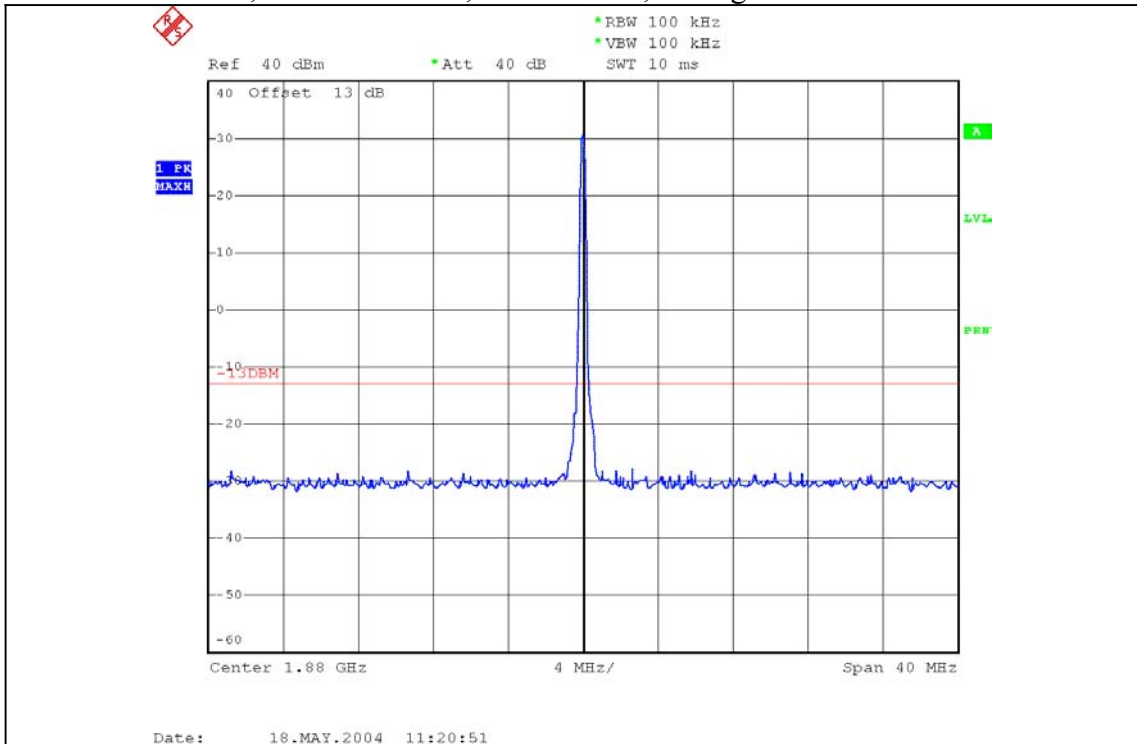

SIERRA WIRELESS, INC.

Plot 6.4.33) Out of Band Emissions at Antenna Terminals
8-PSK, Middle channel, 1880.0 MHz, 1 GHz to 20 GHz

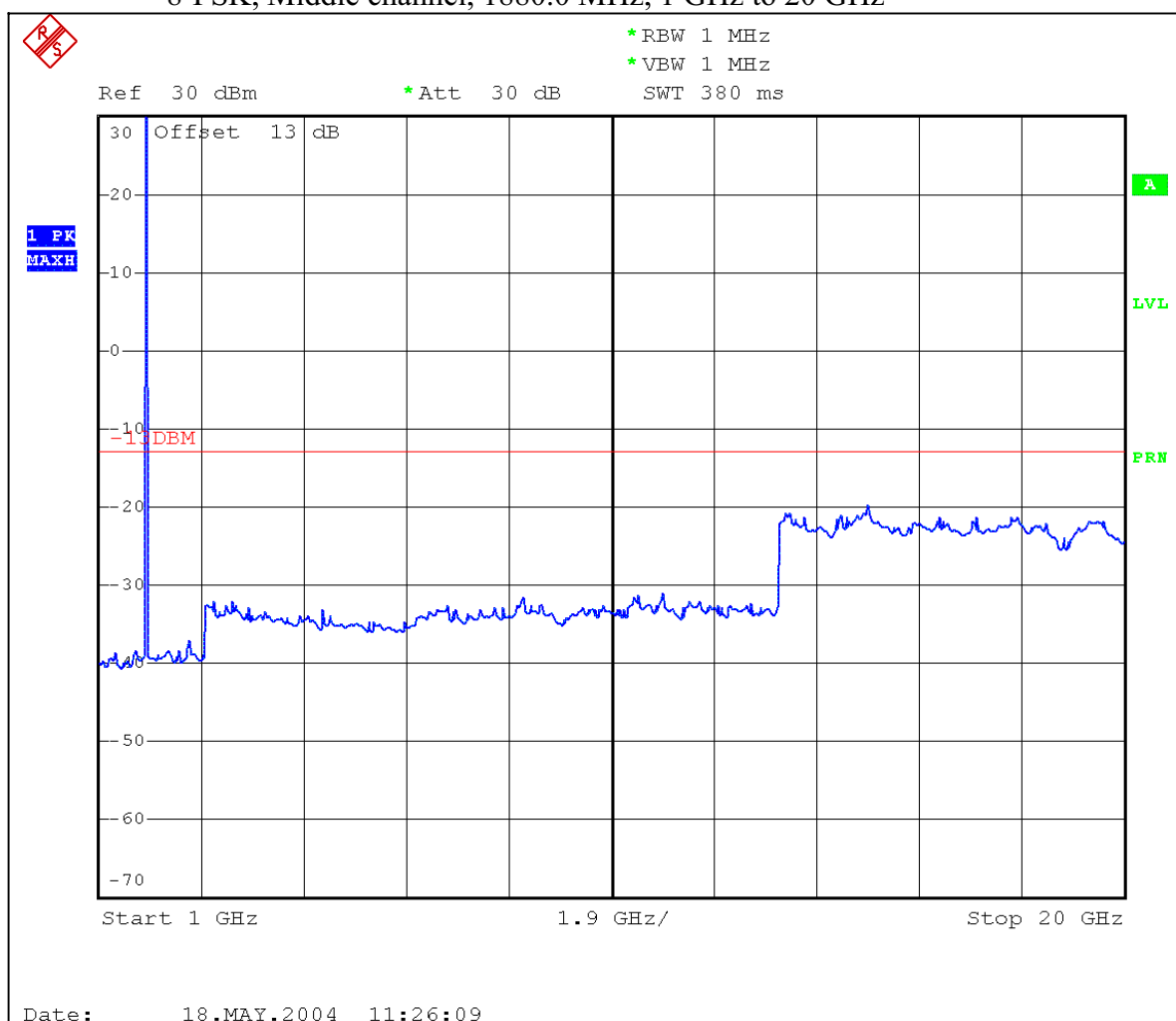

Strong emission shown is the carrier signal.

Plot 6.4.34) Out of Band Emissions at Antenna Terminals
 8-PSK, High channel, 1909.8 MHz, 1 MHz to 1 GHz

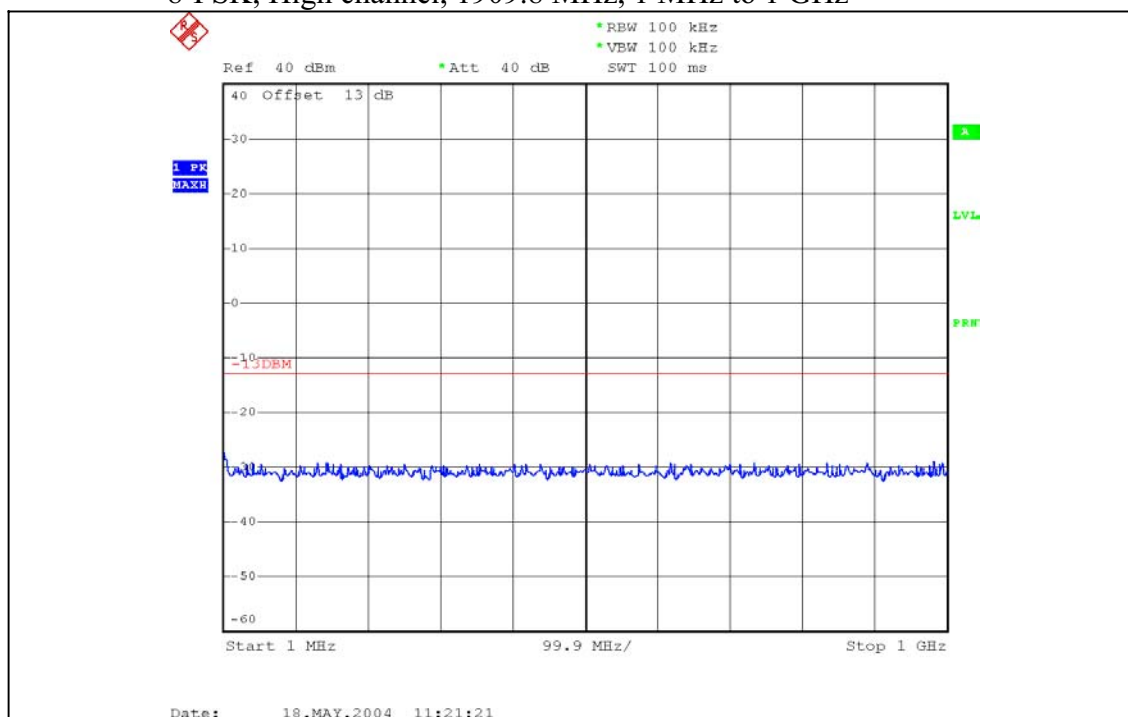

Plot 6.4.35) Out of Band Emissions at Antenna Terminals
 8-PSK, High channel, 1909.8 MHz, TX signal +/- 20 MHz

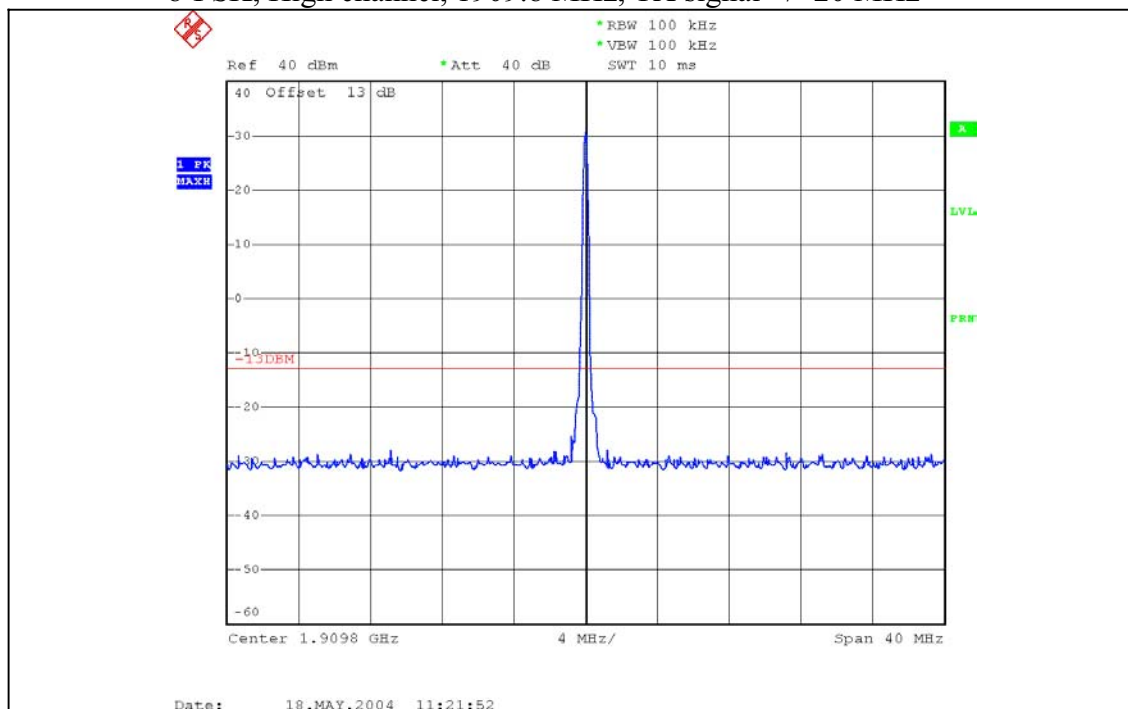

Plot 6.4.36) Out of Band Emissions at Antenna Terminals
8-PSK, High channel, 1909.8 MHz, 1 GHz to 20 GHz

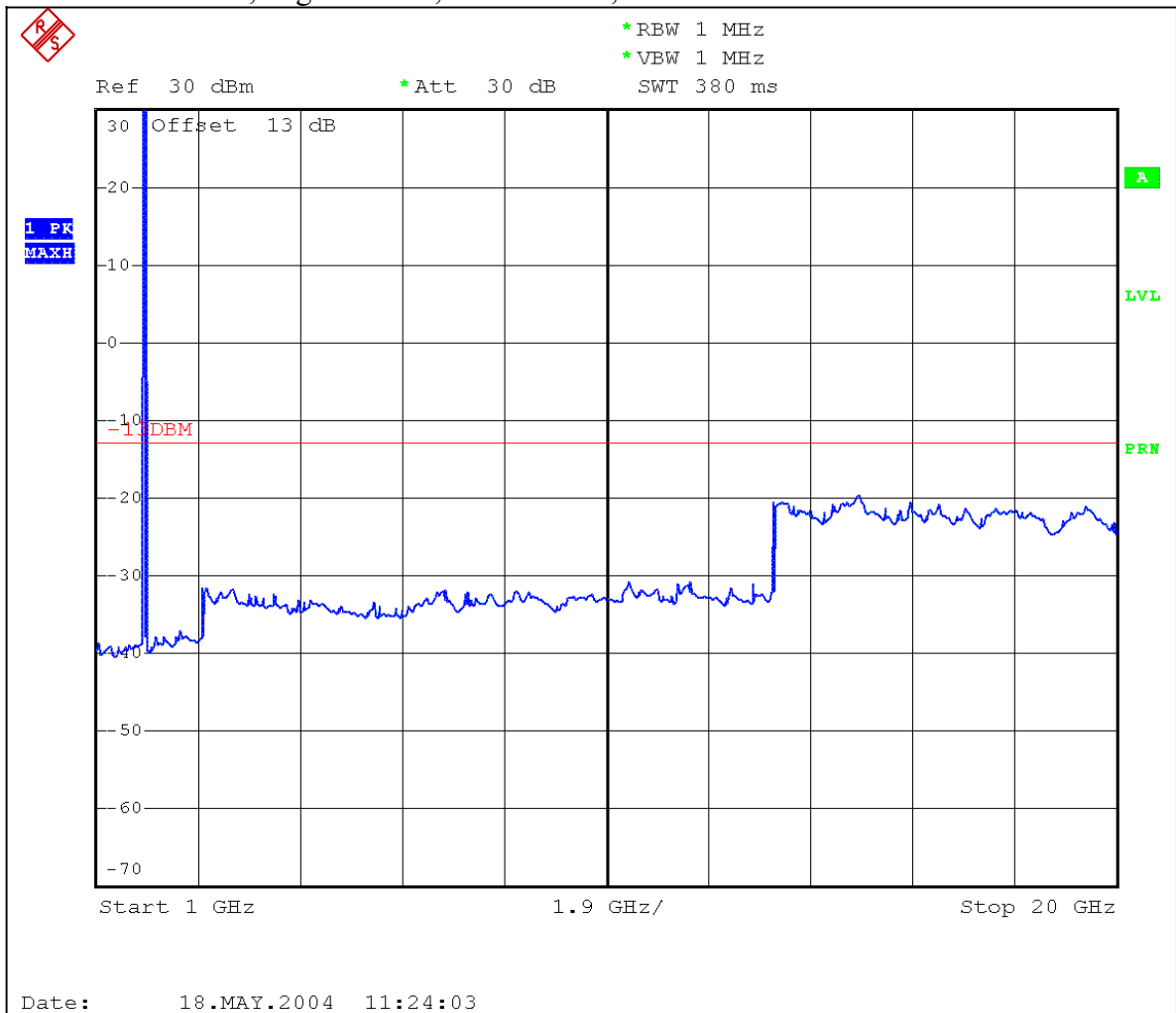

Strong emission shown is the carrier signal.

**Plot 6.4.37) Emissions in Base Station Frequency Range, Cellular band
GMSK, Low channel, 824.200 MHz**

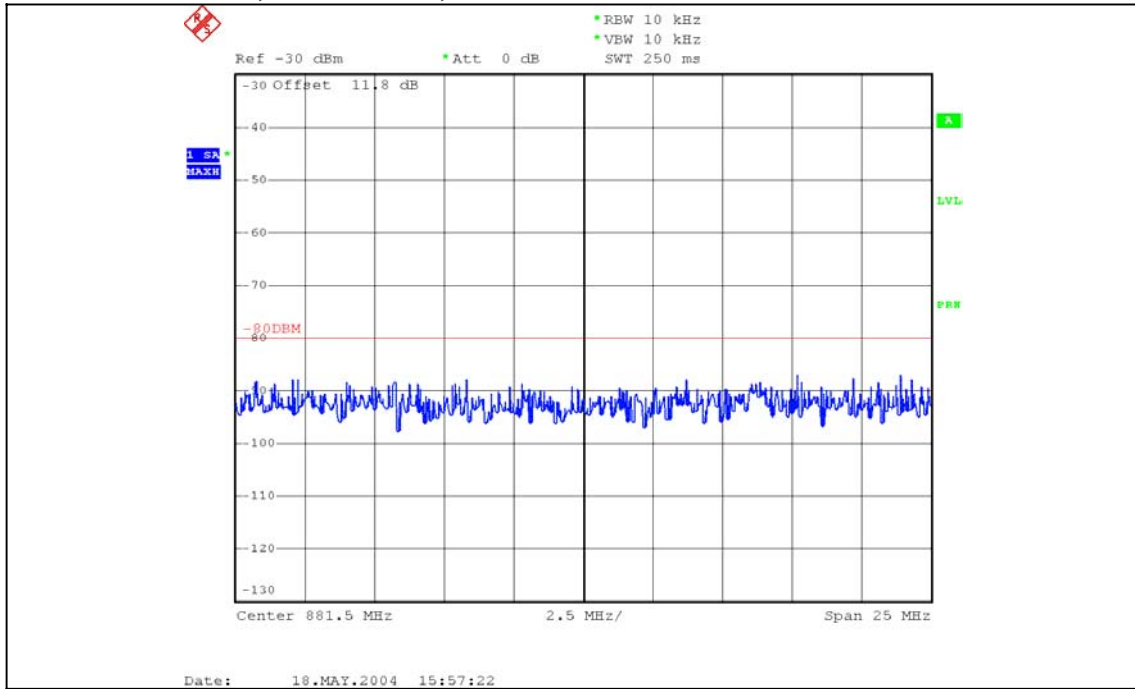

**Plot 6.4.38) Emissions in Base Station Frequency Range, Cellular band
GMSK, Middle channel, 836.600 MHz**

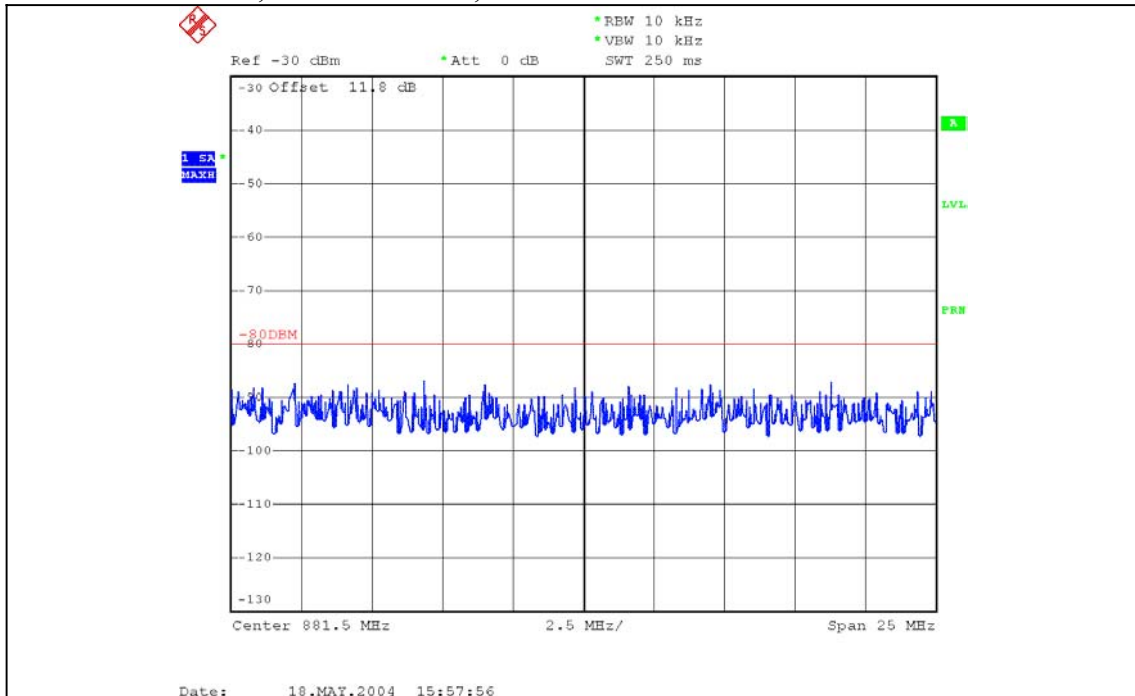

**Plot 6.4.39) Emissions in Base Station Frequency Range, Cellular band
GMSK, High channel, 848.800 MHz**

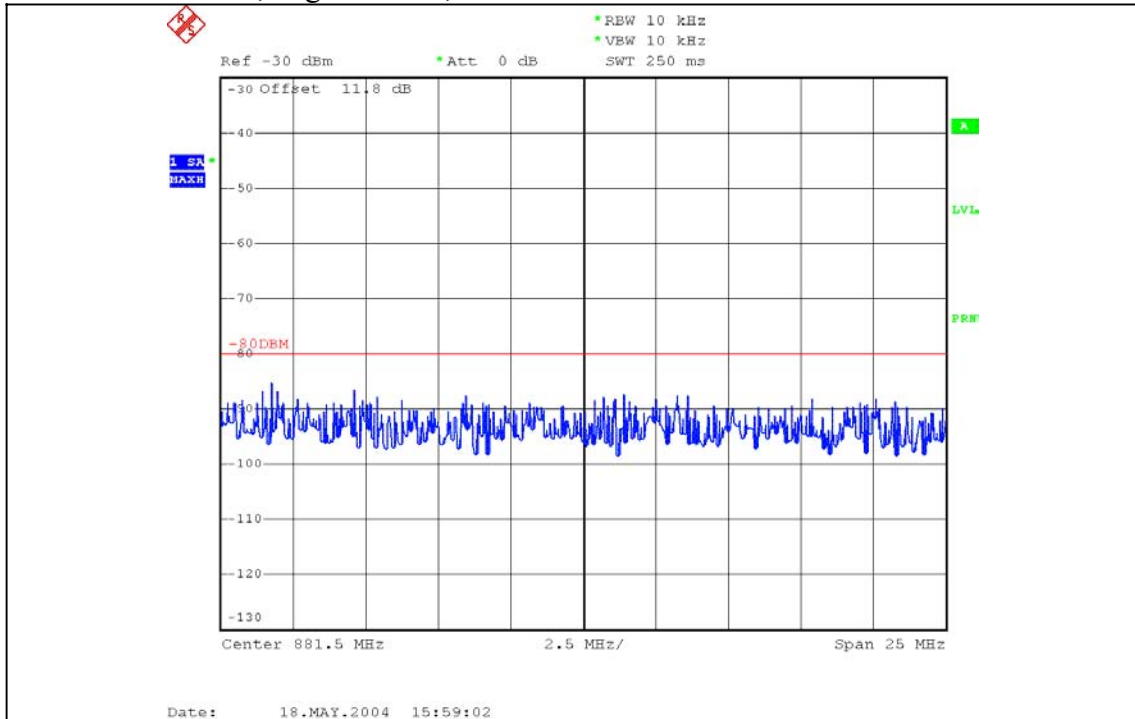

**Plot 6.4.40) Emissions in Base Station Frequency Range, Cellular band
8-PSK, Low channel, 824.200 MHz**

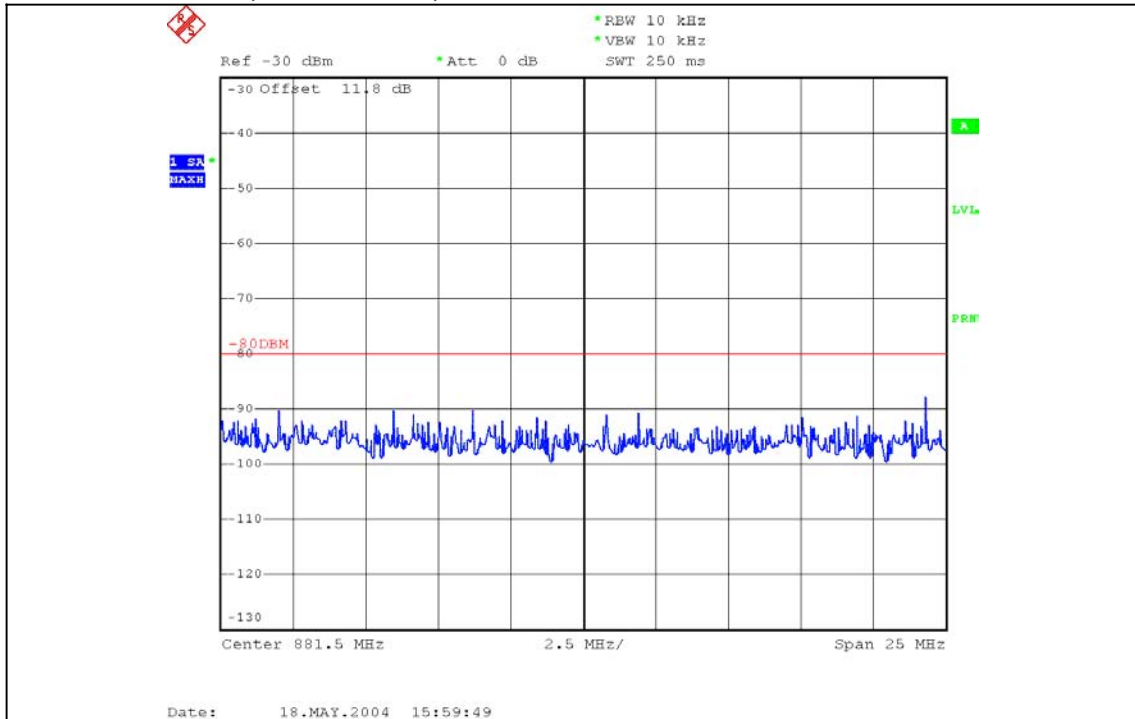

**Plot 6.4.41) Emissions in Base Station Frequency Range, Cellular band
8-PSK, Middle channel, 836.600 MHz**

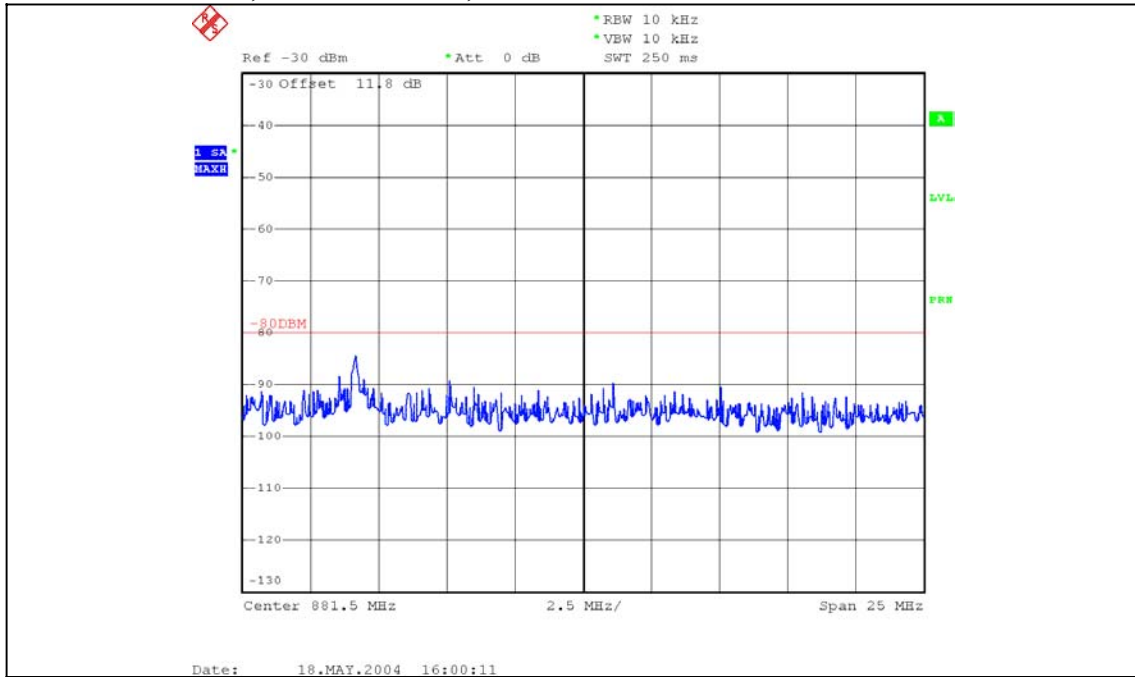

**Plot 6.4.42) Emissions in Base Station Frequency Range, Cellular band
8-PSK, High channel, 848.800 MHz**

