

7 Block Edge Compliance

FCC part 22H/24E

7.1 Test Procedure

The transmitter output was connected to a Rohde & Schwarz CMU200 Test Set and configured to operate at maximum power. The block edge emissions were measured at the required operating frequencies in each band on the Spectrum Analyzer.

Test Setup

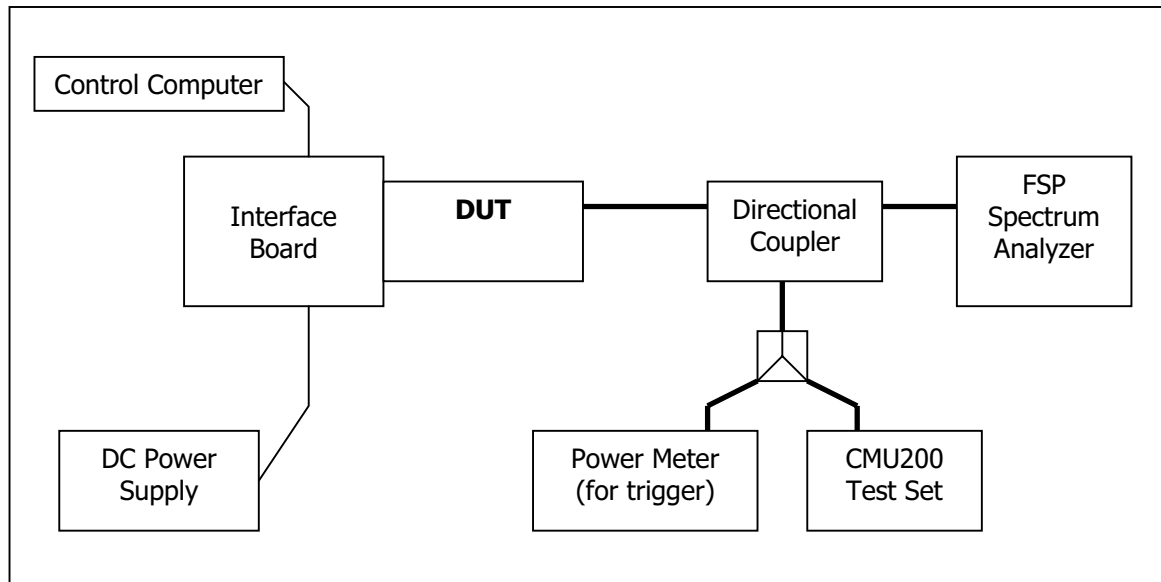

7.2 Test Equipment

Instrument List

EQUIPMENT	MANUFACTURER	MODEL NO.	SERIAL NO.	CAL. DATE
Control Computer	TC	Generic PC	100488	N/A
Wireless Test Set	Rohde & Schwarz	CMU200	836766/030	N/A
Spectrum Analyzer	Rohde & Schwarz	FSP 30GHz	US41421268	Sept. 12, 2003
DC Power Supply	HP	E3631A	100060	N/A
Interface Board	Shop built	Minnow	N/A	N/A
Directional Coupler	Pasternack	PE2209-10	N/A	N/A

SIERRA WIRELESS, INC.

7.3 Test Results

Block Test	Frequency Boundaries (MHz)	Channels Tested	Corresponding Plots	Result
1	GMSK: Below 824 MHz, above 849 MHz	128, 251	7.4.1, 7.4.2	Complies
2	8PSK: Below 824 MHz, above 849 MHz	128, 251	7.4.3, 7.4.4	Complies
3	GMSK: Below 1850MHz, above 1910MHz	512, 810	7.4.5, 7.4.6	Complies
4	8PSK: Below 1850MHz, above 1910MHz	512, 810	7.4.7, 7.4.8	Complies

SIERRA WIRELESS, INC.

7.4 Test Plots

Plot 7.4.1) GSMK; Cellular low channel, below 824 MHz

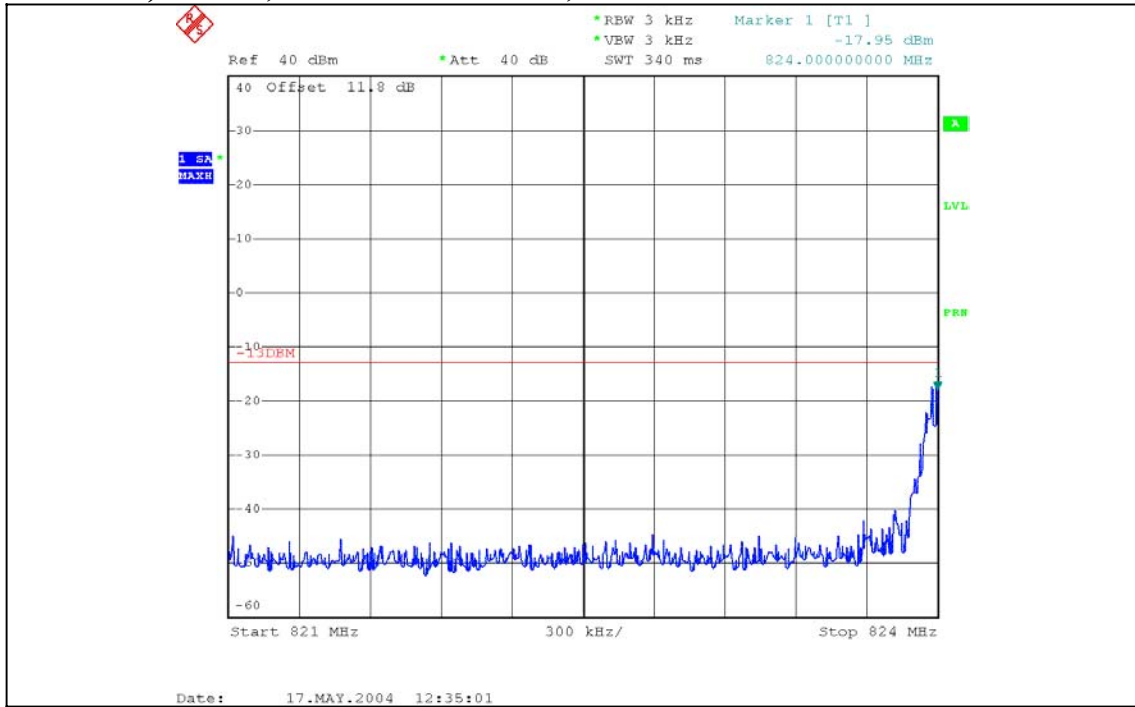

Plot 7.4.2) GSMK; Cellular high channel, above 849 MHz

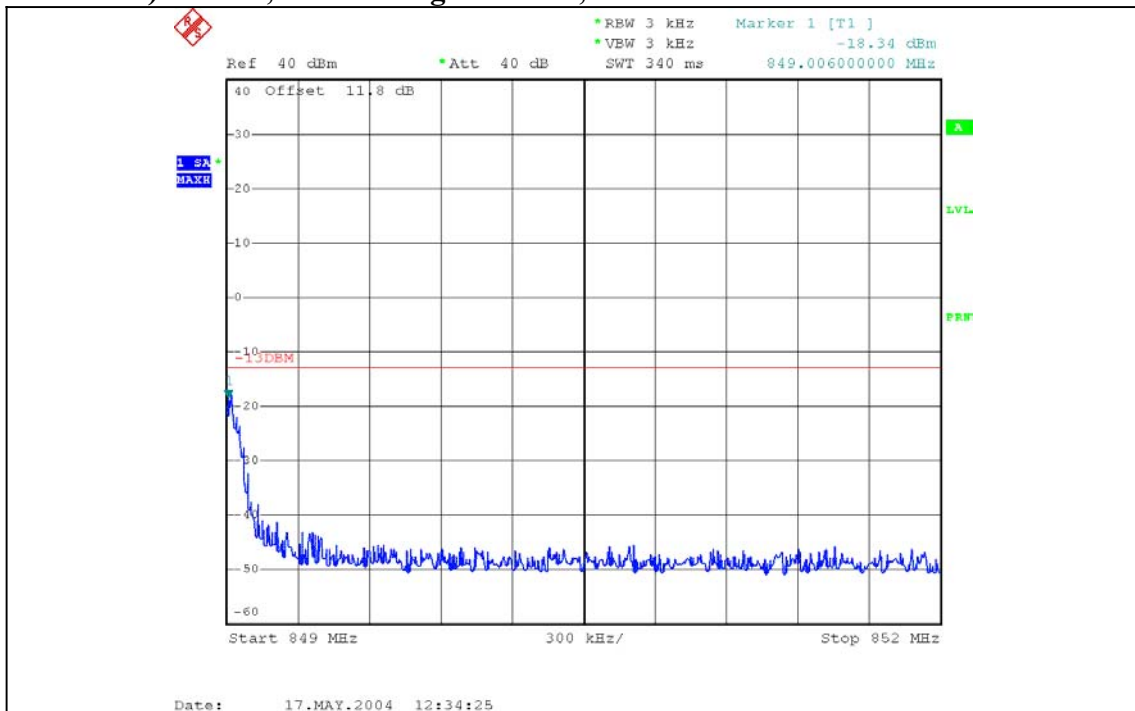

SIERRA WIRELESS, INC.

Plot 7.4.3) 8-PSK; Cellular low channel, below 824 MHz

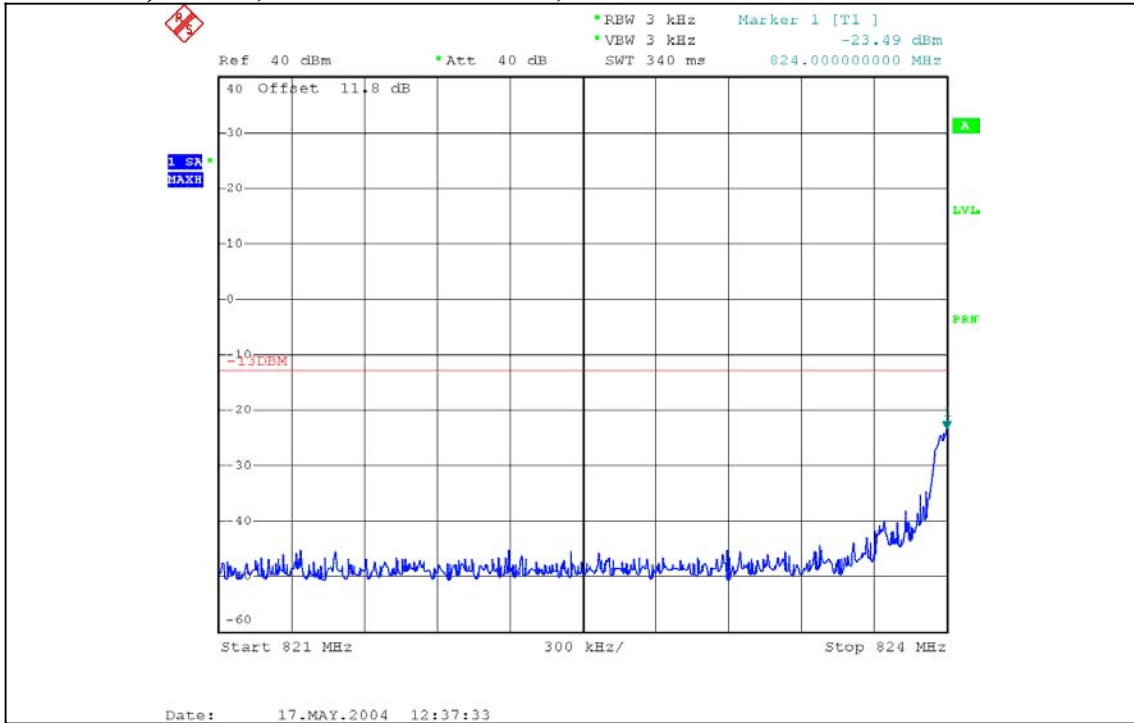

Plot 7.4.4) 8-PSK; Cellular high channel, above 849 MHz

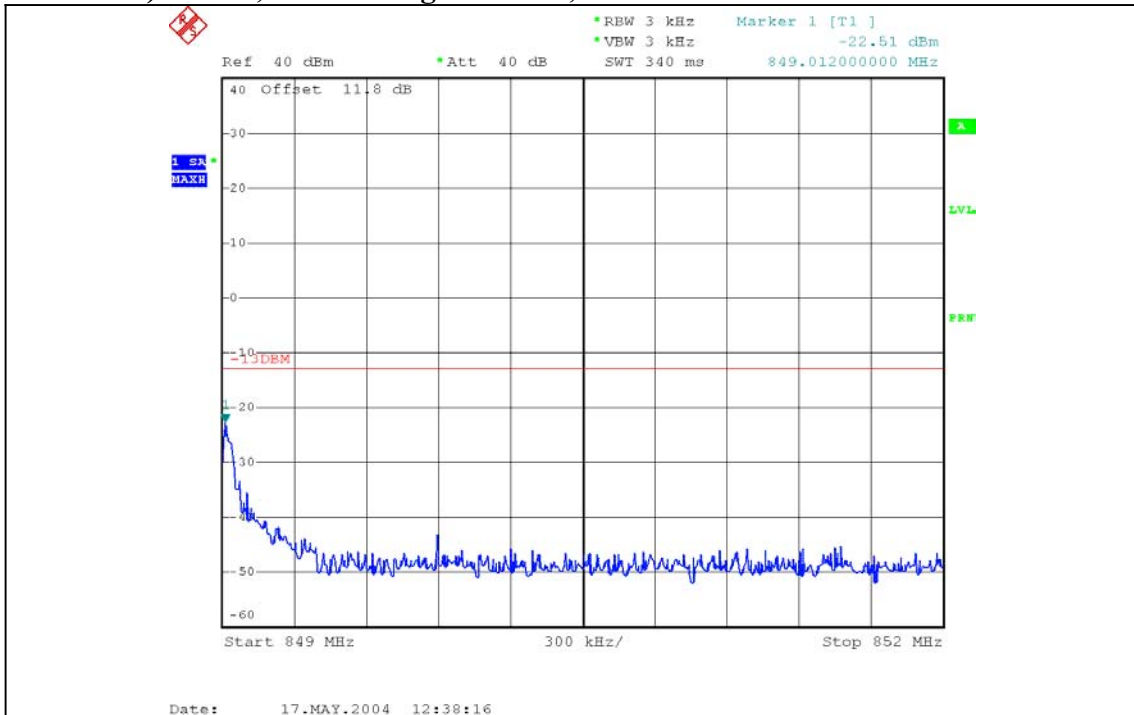

SIERRA WIRELESS, INC.

Plot 7.4.5) GMSK; PCS low channel, below 1850 MHz

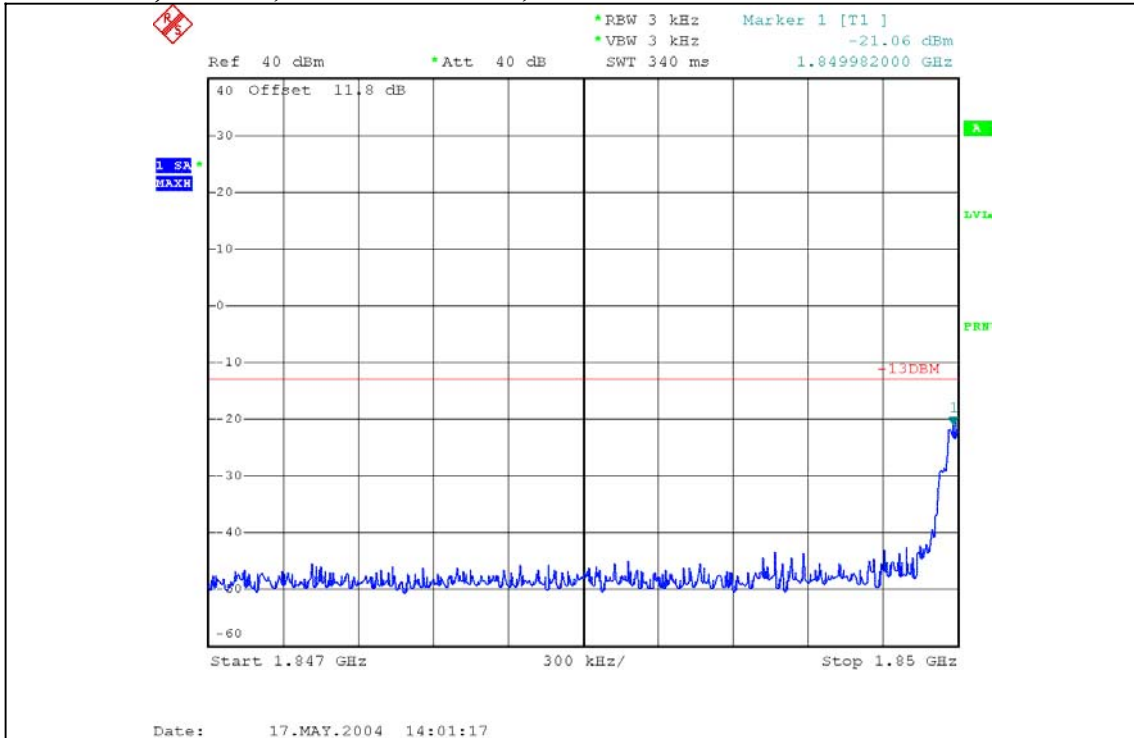

Plot 7.4.6) GMSK; PCS high channel, above 1910 MHz

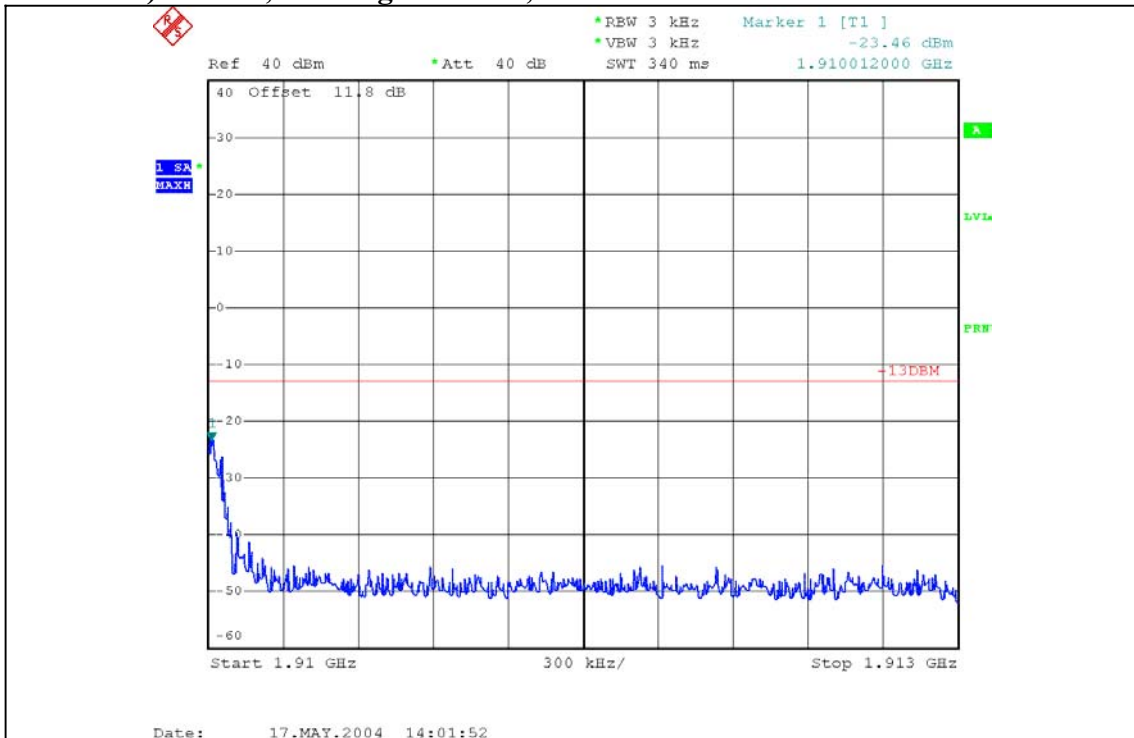

SIERRA WIRELESS, INC.

Plot 7.4.7) 8-PSK; PCS low channel, below 1850 MHz

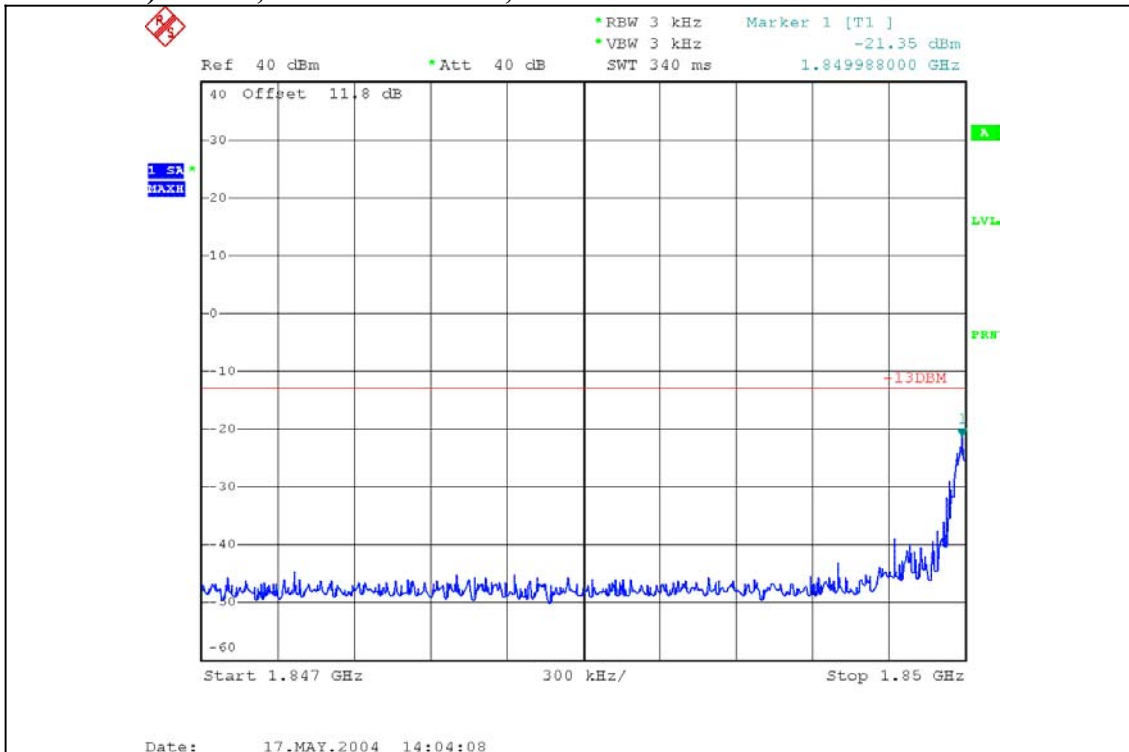

Plot 7.4.8) 8-PSK; PCS high channel, above 1910 MHz

