

Test Report S/N:	102604KBC-T578-E24G Issue 1.0		
Test Date(s):	28Jan05 - 01Feb05		
Test Type(s):	FCC §2, §22H, §24E	IC RSS-132/133	
Lab Registration(s):	FCC #714830	IC Lab File #3874	

**FCC PART 22(H) & 24(E) EMC TEST REPORT**  
 FOR THE  
**ITRONIX RUGGED HANDHELD PC MODEL: IX100XAC775**  
 WITH THE  
**SIERRA WIRELESS AIRCARD 775**  
**DUAL-BAND GSM GPRS/EDGE PCMCIA MODEM**  
 UTILIZING AN  
**EXTERNAL 1/4-WAVE HELIX ANTENNA AND**  
**VEHICLE-MOUNT DIPOLE ANTENNA AND CRADLE**

TRSN 102604KBC-T578-E24G  
 Issue 1.0

**Celltech Compliance Testing & Engineering Lab**  
**(Celltech Labs Inc.)**  
**1955 Moss Court**  
**Kelowna, BC**  
**Canada**  
**V1Y 9L3**

**February 1, 2005**

<b>Applicant:</b>	<b>Itronix Corporation</b>	<b>Model:</b>	<b>IX100XAC775</b>	<b>FCC ID:</b>	<b>KBCIX100XAC775</b>	<b>IC ID:</b>	<b>1943A-IX100Xe</b>	
<b>Rugged Handheld PC with internal Sierra Wireless AirCard 775 Dual-Band GSM GPRS/EDGE Modem</b>								
2005 Celltech Labs Inc	This document is not to be reproduced in whole or in part without the written permission of Celltech Labs Inc.						1 of 35	

<b>Test Report S/N:</b>	102604KBC-T578-E24G Issue 1.0		
<b>Test Date(s):</b>	28Jan05 - 01Feb05		
<b>Test Type(s):</b>	FCC §2, §22H, §24E	IC RSS-132/133	
<b>Lab Registration(s):</b>	FCC #714830	IC Lab File #3874	

## DECLARATION OF COMPLIANCE

<b>Test Lab</b>		<b>CELLTECH LABS INC.</b> Testing and Engineering Services 1955 Moss Court Kelowna, B.C. Canada V1Y 9L3		<b>Applicant Information</b>		<b>ITRONIX CORPORATION</b> 801 South Stevens Street Spokane, WA 99204 United States	
<b>Phone:</b>		250-448-7047					
<b>Fax:</b>		250-448-7048					
<b>E-mail:</b>		info@celltechlabs.com		<b>Web site:</b>		www.celltechlabs.com	
<b>Laboratory Registration No.(s):</b>		FCC:	714830	IC:	IC 3874		
<b>Rule Part(s):</b>		FCC:	Dual Band GSM	§2; §22H; §24E			
		IC:	Dual Band GSM	RSS-133 Issue 2 Revision 1, RSS-132 Issue 1 (Provisional)			
<b>Device Classification:</b>		FCC:	Dual Band GSM	- PCS Licensed Transmitter worn on body (PCT)			
		IC:	Dual Band GSM	- 800 MHz Cellular Telephones Employing New Technologies - 2 GHz Personal Communication Services			
<b>Device Identification:</b>		FCC:	KBCIX100XAC775	IC:	1943A-IX100Xe		
<b>DUT Description:</b>							
<b>Model:</b>		IX100XAC775					
<b>Device Description:</b>		Rugged Handheld PC with internal Sierra Wireless AirCard 775 Dual-Band GSM GPRS/EDGE PCMCIA Modem, External ¼-Wave Helix Antenna, Vehicle-Mount Antenna, and Vehicle Cradle					
<b>Tx Frequency Range(s):</b>		Cellular	824.2 - 848.8 MHz	PCS	1850.2 - 1909.8 MHz		
<b>Rx Frequency Range(s):</b>		Cellular	869.2 - 894.8 MHz	PCS	1930.2 - 1990.8 MHz		
<b>Max. Conducted RF Output Power:</b>		Cellular	+32.1 dBm Peak	PCS	+28.8 dBm Peak		
<b>Max. ERP/EIRP Measured:</b>		Cellular	External Helix Antenna	+30.05 dBm	PCS	External Helix Antenna	+30.90 dBm
			Vehicle-Mount Antenna	+27.36 dBm	PCS	Vehicle-Mount Antenna	+24.84 dBm
<b>Max. No. of Time Slots Tested:</b>		4 (Class 12)					
<b>Source-Based Time-Av. Duty Cycle:</b>		50 %					
<b>Source-Based Time-Av. Cond. Power:</b>		Cellular	+29.1 dBm Peak	PCS	+25.8 dBm Peak		
<b>Modulation Tested:</b>		GMSK					
<b>Emission Designator(s):</b>		238KGXW, 242KGXW, 240KG7W, 242KG7W					
<b>Frequency Tolerance(s):</b>		Cellular	2.5 PPM	PCS	2.5 PPM		
<b>Antenna Type(s):</b>		Ext. Attached	Nearson ¼-Wave Helix P/N: 47-0180-003				
		Vehicle-Mount	MaxRad P/N: WMLPVDB800/1900				
<b>Power Supply:</b>		Model MPE-C045-12 AC Power Adapter; Lithium-ion Battery 7.4 V, 3.0 Ah (P/N: 46-0136-001)					

This wireless portable device has demonstrated compliance with the applicable technical standards as indicated in the measurement report and was tested in accordance with the measurement procedures specified in FCC 47 CFR Parts 2, 15.247, 22H, 24E, Industry Canada RSS 133 Issue 2, RSS-132 Issue 1 (Provisional); and ANSI TIA/EIA-603-C-2004.

I attest to the accuracy of the data. All measurements reported herein were performed by me or were under my supervision and are correct to the best of my knowledge and belief. I assume full responsibility for the completeness of these measurements and vouch for the qualifications of all persons taking them.

This test report shall not be reproduced partially, or in full, without the prior written approval of Celltech Labs Inc. The results and statements contained in this report pertain only to the device(s) evaluated.



Russell Pipe  
Senior Compliance Technologist  
Celltech Labs Inc.



Duane M. Friesen  
EMC Manager  
Celltech Labs Inc.



<b>Applicant:</b>	Itronix Corporation	<b>Model:</b>	IX100XAC775	<b>FCC ID:</b>	KBCIX100XAC775	<b>IC ID:</b>	1943A-IX100Xe
<b>Rugged Handheld PC with internal Sierra Wireless AirCard 775 Dual-Band GSM GPRS/EDGE Modem</b>							
2005 Celltech Labs Inc		This document is not to be reproduced in whole or in part without the written permission of Celltech Labs Inc.				2 of 35	

<b>Test Report S/N:</b>	102604KBC-T578-E24G Issue 1.0		
<b>Test Date(s):</b>	28Jan05 - 01Feb05		
<b>Test Type(s):</b>	FCC §2, §22H, §24E	IC RSS-132/133	
<b>Lab Registration(s):</b>	FCC #714830	IC Lab File #3874	

## TABLE OF CONTENTS

1.0 SCOPE .....	5
2.0 REFERENCES .....	6
2.1 Normative References .....	6
3.0 TERMS AND DEFINITIONS .....	7
4.0 FACILITIES AND ACCREDITATIONS .....	8
5.0 GENERAL INFORMATION .....	8
5.1 Applicant Information .....	8
5.2 DUT Description .....	8
5.3 Co-Located Equipment .....	9
5.4 Cable Descriptions .....	9
5.5 Support Equipment .....	10
5.6 Clock Frequencies .....	10
5.7 Mode(s) of Operation Tested .....	11
5.8 Configuration Description .....	12
6.0 PASS/FAIL CRITERIA .....	12
APPENDIX .....	13
Appendix A - Photographs .....	14
Appendix B - GSM Conducted RF Output Power Measurement .....	15
Appendix C - Effective Radiated Power / Effective Isotropic Radiated Power Measurement .....	18
Appendix D - Radiated Spurious Emissions Measurement .....	24
Appendix E - Maximum Permissible Exposure Calculation .....	32
END OF DOCUMENT .....	35

## FIGURES

Figure B.6-1 - Setup Drawing .....	16
Figure C.6-1 - Setup Drawing .....	19
Figure D.6-1 - Setup Drawing .....	25

## PHOTOGRAPHS

Photograph A.1-1 - Front of IX100X Rugged Handheld PC with ¼-Wave Helix Antenna .....	14
Photograph A.1-2 - IX100X Rugged Handheld PC with IX100X Vehicle Cradle and Vehicle-Mount Antenna .....	14
Photograph A.1-3 - IX100X Rugged Handheld PC with AirCard 775 GSM GPRS/EDGE Modem .....	14
Photograph A.1-4 - Sierra Wireless AirCard 775 GSM GPRS/EDGE Modem .....	14
Photograph C.7-1 - Dipole Receive Antenna with DUT Helix Antenna Configuration .....	20
Photograph C.7-2 - Horn Receive Antenna with DUT Helix Antenna Configuration .....	20
Photograph C.7-3 - Horn Receive Antenna with DUT Vehicle-Mount Antenna Configuration .....	20
Photograph C.7-4 - Dipole Substitution Setup .....	20
Photograph D.7-1 - BiConilog Receive Antenna with DUT Vehicle-Mount Antenna Configuration .....	26
Photograph D.7-2 - Horn Receive Antenna with DUT Helix Antenna Configuration .....	26



<b>Test Report S/N:</b>	102604KBC-T578-E24G Issue 1.0		
<b>Test Date(s):</b>	28Jan05 - 01Feb05		
<b>Test Type(s):</b>	FCC §2, §22H, §24E	IC RSS-132/133	
<b>Lab Registration(s):</b>	FCC #714830	IC Lab File #3874	

### TEST SUMMARY

Referenced Standard: FCC CFR Title 47 Parts 2, 22 & 24

Appendix	Test Description	Procedure Reference	Limit Reference	Test Start Date	Test End Date	Result
B	Conducted RF Output Power	FCC 97-114	§2.1046	28Jan05	28Jan05	Pass
C	Effective Radiated Power / Effective Isotropic Radiated Power	ANSI/TIA/EIA-603-C	§22.913 §24.232(b)	28Jan05	31Jan05	Pass
D	Radiated Spurious Emissions	ANSI/TIA/EIA-603-C	§22.917 (a), §24.238 (a)	28Jan05	31Jan05	Pass
E	Maximum Permissible Exposure	FCC CFR 47 § 2.1091 IEEE Std C95.1-1999	§1.1310 Table 1 (b)	1Feb05	1Feb05	Pass



Referenced Standard: IC RSS-132 & RSS-133

B	Conducted RF Output Power	ANSI/TIA/EIA-603-C	RSS-132 §4.4 RSS-133 §6.2	28Jan05	28Jan05	Pass
C	Effective Radiated Power / Effective Isotropic Radiated Power	ANSI/TIA/EIA-603-C	RSS-132 §4.4 RSS-133 §6.2	28Jan05	31Jan05	Pass
D	Radiated Spurious Emissions	ANSI/TIA/EIA-603-C	RSS-132 §4.4 RSS-133 §6.3	28Jan05	31Jan05	Pass
E	Maximum Permissible Exposure	RSS-102	Safety Code 6 2.2.1(a) Table 5	1Feb05	1Feb05	Pass

### REVISION LOG

Issue	Description	Implemented By	Implementation Date
1.0	Initial Release	Jon Hughes	1Feb05

### SIGNATORIES

Prepared By:		Feb. 1, 2005
Name/Title:	Duane M. Friesen, C.E.T. / EMC Manager	Date
Approved By:		Feb. 1, 2005
Name/Title:	Jon Hughes / General Manager	Date

<b>Applicant:</b>	Itronix Corporation	<b>Model:</b>	IX100XAC775	<b>FCC ID:</b>	KBCIX100XAC775	<b>IC ID:</b>	1943A-IX100Xe
<b>Rugged Handheld PC with internal Sierra Wireless AirCard 775 Dual-Band GSM GPRS/EDGE Modem</b>							
2005 Celltech Labs Inc	This document is not to be reproduced in whole or in part without the written permission of Celltech Labs Inc.						4 of 35

<b>Test Report S/N:</b>	102604KBC-T578-E24G Issue 1.0		
<b>Test Date(s):</b>	28Jan05 - 01Feb05		
<b>Test Type(s):</b>	FCC §2, §22H, §24E	IC RSS-132/133	
<b>Lab Registration(s):</b>	FCC #714830	IC Lab File #3874	

## 1.0 SCOPE

This report outlines the measurements made and results collected during electromagnetic emissions testing of the Itronix Corporation IX100X Rugged Handheld PC with the Sierra Wireless AirCard 775 Dual-Band GSM GPRS/EDGE PCMCIA Modem. A Nearson ¼-Wave Helix antenna was attached to the upper right side edge of the IX100X Rugged Handheld PC. The IX100X also has the option of being mounted in a vehicle cradle with the Dual-Band GSM Modem utilizing a vehicle-mounted MaxRad antenna. Results obtain for both configurations are presented in this report. The measurement results were applied against the applicable EMC requirements and limits outlined in the technical rules and regulations set forth in the Federal Communication Commission Code of Federal Regulations Title 47 Parts 2, 22 Subpart H, and 24 Subpart E; and Industry Canada Radio Standards Specification RSS-132 Issue 1 (Provisional), and RSS-133 Issue 2.

<b>Applicant:</b>	<b>Itronix Corporation</b>	<b>Model:</b>	<b>IX100XAC775</b>	<b>FCC ID:</b>	<b>KBCIX100XAC775</b>	<b>IC ID:</b>	<b>1943A-IX100Xe</b>	
<b>Rugged Handheld PC with internal Sierra Wireless AirCard 775 Dual-Band GSM GPRS/EDGE Modem</b>								
2005 Celltech Labs Inc	This document is not to be reproduced in whole or in part without the written permission of Celltech Labs Inc.						5 of 35	

<b>Test Report S/N:</b>	102604KBC-T578-E24G Issue 1.0		
<b>Test Date(s):</b>	28Jan05 - 01Feb05		
<b>Test Type(s):</b>	FCC §2, §22H, §24E	IC RSS-132/133	
<b>Lab Registration(s):</b>	FCC #714830	IC Lab File #3874	

## 2.0 REFERENCES

### 2.1 Normative References

ANSI/ISO 17025:1999	General Requirements for competence of testing and calibration laboratories
IEEE/ANSI C63.4:2003	Methods of Measurement of Radio-Noise Emissions from Low-Voltage Electrical and Electronic Equipment in the Range of 9 kHz to 40 GHz
IEEE/ANSI Std C95.1:1999	American National Standard Safety Levels with Respect to Human Exposure to Radio Frequency Electromagnetic Fields
ANSI/TIA/EIA-603-C:2004	Land Mobile FM or PM Communication Equipment Measurement and Performance Standards
CFR Title 47 Part 2:2003	Code of Federal Regulations Title 47: Telecommunication Part 2: Frequency Allocations and Radio Treaty Matters; General Rules and Regulations
CFR Title 47 Part 22:2003	Code of Federal Regulations Title 47: Telecommunication Part 22: Public Mobile Services
CFR Title 47 Part 24:2003	Code of Federal Regulations Title 47: Telecommunication Part 24: Personal Communication Services
IC Spectrum Management & Telecommunications Policy	Radio Standards Specification RSS-102 Issue 1 (Provisional) - Evaluation Procedure for Mobile and Portable Radio Transmitters with respect to Health Canada's Safety Code 6 for Exposure of Humans to Radio Frequency Fields RSS-132 Issue 1 (Provisional) 800 MHz Cellular Telephones Employing New Technologies RSS-133 Issue 2, Revision 1 Personal Communication Services RSS-212 Issue 1 (Provisional) - Test Facilities & Test Methods for Radio Equipment

<b>Applicant:</b>	<b>Itronix Corporation</b>	<b>Model:</b>	<b>IX100XAC775</b>	<b>FCC ID:</b>	<b>KBCIX100XAC775</b>	<b>IC ID:</b>	<b>1943A-IX100Xe</b>	
<b>Rugged Handheld PC with internal Sierra Wireless AirCard 775 Dual-Band GSM GPRS/EDGE Modem</b>								
2005 Celltech Labs Inc	This document is not to be reproduced in whole or in part without the written permission of Celltech Labs Inc.						6 of 35	

<b>Test Report S/N:</b>	102604KBC-T578-E24G Issue 1.0		
<b>Test Date(s):</b>	28Jan05 - 01Feb05		
<b>Test Type(s):</b>	FCC §2, §22H, §24E	IC RSS-132/133	
<b>Lab Registration(s):</b>	FCC #714830	IC Lab File #3874	

### 3.0 TERMS AND DEFINITIONS

AV	Average
CDMA	Code Division Multiple Access
CFR	Code of Federal Regulations
dB	decibel
dBm	dB referenced to 1 mW
dBuV	dB referenced to 1 uV
DUT	Device under Test
dBc	dB down from carrier
EBW	Emission Bandwidth
EDGE	Enhanced Data Rates for GSM Evolution
EIRP	Effective Isotropic Radiated Power
EMC	Electromagnetic Compatibility
ERP	Effective Radiated Power
FCC	Federal Communication Commission
FHSS	Frequency Hopping Spread Spectrum
GSM	Global Systems for Mobile Communication
GPRS	General Packet Radio Service
HP	Hewlett Packard
HPF	High Pass Filter
Hpol	Horizontal Polarization
Hz	Hertz
IC	Industry Canada
kHz	kilohertz
LNA	Low Noise Amplifier
m	meter
MHz	Megahertz
Mbps	megabits per second
na	not applicable
n/a	not available
PK	Peak
PPSD	Peak Power Spectral Density
QP	Quasi-peak
RBW	Resolution Bandwidth
R&S	Rohde & Schwarz
RSS	Radio Standard Specification
SA	Spectrum Analyzer
VBW	Video Bandwidth
Vpol	Vertical Polarization
WLAN	Wireless Local Area Network

<b>Applicant:</b>	Itronix Corporation	<b>Model:</b>	IX100XAC775	<b>FCC ID:</b>	KBCIX100XAC775	<b>IC ID:</b>	1943A-IX100Xe
<b>Rugged Handheld PC with internal Sierra Wireless AirCard 775 Dual-Band GSM GPRS/EDGE Modem</b>							
2005 Celltech Labs Inc	This document is not to be reproduced in whole or in part without the written permission of Celltech Labs Inc.						7 of 35

<b>Test Report S/N:</b>	102604KBC-T578-E24G Issue 1.0		
<b>Test Date(s):</b>	28Jan05 - 01Feb05		
<b>Test Type(s):</b>	FCC §2, §22H, §24E	IC RSS-132/133	
<b>Lab Registration(s):</b>	FCC #714830	IC Lab File #3874	

#### 4.0 FACILITIES AND ACCREDITATIONS

The facilities used in collecting the test results outlined in this report are located at 1955 Moss Court, Kelowna, British Columbia, Canada, V1Y 9L3. The radiated and conducted emissions sites conform with the requirements set forth in ANSI C63.4 and are filed and listed with the FCC under Registration Number 714830 and Industry Canada under File Number IC 3874.

#### 5.0 GENERAL INFORMATION

##### 5.1 Applicant Information

<b>Company Name:</b>	Itronix Corporation
<b>Address:</b>	801 South Stevens Street Spokane, WA 99204 United States

##### 5.2 DUT Description

The DUT consisted of the IX100X Rugged Handheld PC containing a Sierra Wireless AirCard 775 Dual-Band GSM GPRS/EDGE PCMCIA Modem connected to an External Nearson ¼-Wave Helix Antenna located on the upper right side edge of the PC. The IX100X has the option of being mounted in a vehicle cradle with the Dual-Band GSM Modem utilizing a vehicle-mounted MaxRad antenna with a 17-foot attached cable. Photographs of the DUT placement and construction are shown in Appendix A.

<b>Device:</b>	IX100X Rugged Handheld PC		
<b>Model:</b>	IX100XAC775		
<b>Serial Number(s):</b>	MH002		
<b>Identifier(s):</b>	<b>FCC ID:</b> KBCIX100XAC775	<b>IC:</b> 1943A-IX100Xe	
<b>Classification:</b>	<b>FCC:</b> PCS Licensed Transmitter worn on body (PCT)		
<b>Power Source:</b>	Magic Power Technology MPE-C045-12 R2 (F-875-1008-1) AC-DC power supply Output 12 VDC, 3.75A		

<b>Device:</b>	IX100X Vehicle Cradle
<b>Part Number:</b>	50-0107-001
<b>Serial Number(s):</b>	12



<b>Test Report S/N:</b>	102604KBC-T578-E24G Issue 1.0		
<b>Test Date(s):</b>	28Jan05 - 01Feb05		
<b>Test Type(s):</b>	FCC §2, §22H, §24E	IC RSS-132/133	
<b>Lab Registration(s):</b>	FCC #714830	IC Lab File #3874	

<b>Device:</b>	Dual-Band GSM GPRS/EDGE PCMCIA Modem			
<b>Model:</b>	Sierra Wireless AirCard 775			
<b>Serial Number:</b>	X04072701619010			
<b>Identifier(s):</b>	<b>FCC ID:</b>	N7NAC775	<b>IC:</b>	2417-AC775
<b>Rule Part(s):</b>	<b>FCC:</b>	§2.1091; §22.913, §22.917; §24.232(b), §24.238		
	<b>IC:</b>	RSS-133 Issue 2; RSS-132 Issue 1 (Provisional)		
<b>Classification(s):</b>	<b>FCC:</b>	PCS Licensed Transmitter (PCB)		
	<b>IC:</b>	800 MHz Cellular Telephones employing New Technologies (RSS-132)		
		2 GHz Personal Communication Services (RSS-133)		
<b>Power Source:</b>	Powered from the internal PC power supply			

<b>Device:</b>	Nearson External Mounted ¼-Wave Helix Antenna (upper right side edge of PC)		
<b>Model / Part No.:</b>	Model: 321 / PN: 47-0180-003		
<b>Gain:</b>	-2 dBi (880-960 MHz) 0 dBi (all other bands)		

<b>Device:</b>	MaxRad Vehicle-Mount Antenna with attached cable		
<b>Model / Part No.:</b>	P/N: WMLPVDB800/1900		
<b>Gain:</b>	3 dBi		

### 5.3 Co-Located Equipment

<b>Name:</b>	none
<b>Model:</b>	na

### 5.4 Cable Descriptions

ROUTING		Length m	Model	Terminations		Shield Type	Shield Termination		Suppression
From	To			End 1	End 2		End 1	End 2	
none									

<b>Applicant:</b>	Itronix Corporation	<b>Model:</b>	IX100XAC775	<b>FCC ID:</b>	KBCIX100XAC775	<b>IC ID:</b>	1943A-IX100Xe
<b>Rugged Handheld PC with internal Sierra Wireless AirCard 775 Dual-Band GSM GPRS/EDGE Modem</b>							
2005 Celltech Labs Inc	This document is not to be reproduced in whole or in part without the written permission of Celltech Labs Inc.						9 of 35

<b>Test Report S/N:</b>	102604KBC-T578-E24G Issue 1.0		
<b>Test Date(s):</b>	28Jan05 - 01Feb05		
<b>Test Type(s):</b>	FCC §2, §22H, §24E	IC RSS-132/133	
<b>Lab Registration(s):</b>	FCC #714830	IC Lab File #3874	

### 5.5 Support Equipment

The following equipment was used in support of the DUT.

Co-located Support Equipment List		
Manufacturer	Model	Description
none		

### 5.6 Clock Frequencies

#### 5.6.1 DUT Clock Frequencies

<b>Device:</b>	Rugged Handheld PC
<b>Clocks:</b>	n/a
<b>Device:</b>	Dual-Band GSM Modem
<b>Clocks:</b>	n/a
<b>Device:</b>	Vehicle cradle
<b>Clocks:</b>	None
<b>Device:</b>	Nearson ¼-Wave Helix Antenna
<b>Clocks:</b>	None
<b>Device:</b>	Vehicle-mount MaxRad antenna
<b>Clocks:</b>	None

#### 5.6.2 Co-Located Clock Frequencies

<b>Device:</b>	None
<b>Clocks:</b>	

<b>Test Report S/N:</b>	102604KBC-T578-E24G Issue 1.0		
<b>Test Date(s):</b>	28Jan05 - 01Feb05		
<b>Test Type(s):</b>	FCC §2, §22H, §24E	IC RSS-132/133	
<b>Lab Registration(s):</b>	FCC #714830	IC Lab File #3874	

## 5.7 Mode(s) of Operation Tested

### 5.7.1 Dual-Band GSM GPRS/EDGE Modem

Customer supplied software was used to set the GSM Modem to the appropriate channel and power level for the specific measurement. Prescan measurements were made with the GSM modem set to each of the low, mid and high channels in each band. Final measurements were made of all significant emissions. The following settings were used for each channel.

#### 5.7.1.1 Cellular GSM

<b>TX Frequency Range:</b>	824.2 - 848.8 MHz Ch. 128 (824.200 MHz), Ch. 190 (836.600 MHz) & Ch. 251 (848.800 MHz) measured unless otherwise noted
<b>Software Power Gain Settings:</b>	The supplied software set the power to maximum rated output power.
<b>RF Peak Conducted Output Power Tested:</b>	Ch. 128 - +32.06 dBm Ch. 190 - +31.92 dBm Ch. 251 - +31.87 dBm *conducted power measured at card port while powered with AC adapter
<b>Battery Type(s):</b>	7.4V Lithium-ion, 3.0Ah (Model: 46-0136-001)
<b>Modulation Type:</b>	GMSK

#### 5.7.1.2 PCS GSM

<b>TX Frequency Range:</b>	1850.2 - 1909.8 MHz Ch. 512 (1850.2 MHz), Ch. 661 (1880.0) & Ch. 810 (1909.8 MHz) measured unless otherwise noted
<b>Software Power Gain Settings:</b>	The supplied software set the power for maximum rated output power.
<b>RF Peak Conducted Output Power Tested:</b>	Ch. 512 - +28.58 dBm Ch. 661 - +28.58 dBm Ch. 810 - +28.82 dBm *conducted power measured at card port while powered with AC adapter
<b>Battery Type(s):</b>	7.4V Lithium-ion, 3.0Ah (Model: 46-0136-001)
<b>Modulation Type:</b>	GMSK

### 5.7.2 DUT Exercising Software Description

The DUT was configured and exercised using customer supplied test software that allowed an operator to set the parameters of the Dual-Band GSM modem's operation. The settings used are described in each appendix.

<b>Applicant:</b>	Itronix Corporation	<b>Model:</b>	IX100XAC775	<b>FCC ID:</b>	KBCIX100XAC775	<b>IC ID:</b>	1943A-IX100Xe
<b>Rugged Handheld PC with internal Sierra Wireless AirCard 775 Dual-Band GSM GPRS/EDGE Modem</b>							
2005 Celltech Labs Inc	This document is not to be reproduced in whole or in part without the written permission of Celltech Labs Inc.						11 of 35

<b>Test Report S/N:</b>	102604KBC-T578-E24G Issue 1.0		
<b>Test Date(s):</b>	28Jan05 - 01Feb05		
<b>Test Type(s):</b>	FCC §2, §22H, §24E	IC RSS-132/133	
<b>Lab Registration(s):</b>	FCC #714830	IC Lab File #3874	

### 5.8 Configuration Description

The DUT was configured, as described by the client as being representative of what would be delivered to a final customer. Using prescan testing as a reference, the PC was positioned with its face pointing up for the spurious emissions testing described herein. For ERP/EIRP measurements, the PC was oriented to match the orientation of the receive antenna. More specific details may be included in each appendix.

#### 5.8.1 Configuration Justification

The DUT was tested in a configuration described by the client as being worse case but typical of normal use. Since the system is available for use while hand held or installed in a mobile cradle using a vehicle-mounted dipole antenna, both configurations were tested and results reported herein.

### 6.0 PASS/FAIL CRITERIA

Unless otherwise noted in the Appendices, the pass/fail criteria is the limit set forth in the reference standards. A DUT is considered to have passed the requirements, if the data collected during the described measurement procedure is no greater than the specified limits as defined. The pass/fail statements made in this report only apply to the unit tested.

<b>Applicant:</b>	<b>Itronix Corporation</b>	<b>Model:</b>	<b>IX100XAC775</b>	<b>FCC ID:</b>	<b>KBCIX100XAC775</b>	<b>IC ID:</b>	<b>1943A-IX100Xe</b>	
<b>Rugged Handheld PC with internal Sierra Wireless AirCard 775 Dual-Band GSM GPRS/EDGE Modem</b>								
2005 Celltech Labs Inc		This document is not to be reproduced in whole or in part without the written permission of Celltech Labs Inc.					12 of 35	

<b>Test Report S/N:</b>	102604KBC-T578-E24G Issue 1.0		
<b>Test Date(s):</b>	28Jan05 - 01Feb05		
<b>Test Type(s):</b>	FCC §2, §22H, §24E	IC RSS-132/133	
<b>Lab Registration(s):</b>	FCC #714830	IC Lab File #3874	

## APPENDIX

<b>Applicant:</b>	<b>Itronix Corporation</b>	<b>Model:</b>	<b>IX100XAC775</b>	<b>FCC ID:</b>	<b>KBCIX100XAC775</b>	<b>IC ID:</b>	<b>1943A-IX100Xe</b>
<b>Rugged Handheld PC with internal Sierra Wireless AirCard 775 Dual-Band GSM GPRS/EDGE Modem</b>							
2005 Celltech Labs Inc	This document is not to be reproduced in whole or in part without the written permission of Celltech Labs Inc.						13 of 35

Test Report S/N:	102604KBC-T578-E24G Issue 1.0		
Test Date(s):	28Jan05 - 01Feb05		
Test Type(s):	FCC §2, §22H, §24E	IC RSS-132/133	
Lab Registration(s):	FCC #714830	IC Lab File #3874	

## Appendix A - Photographs

### A.1 DUT PHOTOGRAPHS

Photograph A.1-1 - Front of IX100X Rugged Handheld PC with ¼-Wave Helix Antenna



Photograph A.1-2 - IX100X Rugged Handheld PC with IX100X Vehicle Cradle and Vehicle-Mount Antenna



Photograph A.1-3 - IX100X Rugged Handheld PC with AirCard 775 GSM GPRS/EDGE Modem



Photograph A.1-4 - Sierra Wireless AirCard 775 GSM GPRS/EDGE Modem



Applicant:	Itronix Corporation	Model:	IX100XAC775	FCC ID:	KBCIX100XAC775	IC ID:	1943A-IX100Xe
Rugged Handheld PC with internal Sierra Wireless AirCard 775 Dual-Band GSM GPRS/EDGE Modem							
2005 Celltech Labs Inc	This document is not to be reproduced in whole or in part without the written permission of Celltech Labs Inc.						14 of 35

<b>Test Report S/N:</b>	102604KBC-T578-E24G Issue 1.0		
<b>Test Date(s):</b>	28Jan05 - 01Feb05		
<b>Test Type(s):</b>	FCC §2, §22H, §24E	IC RSS-132/133	
<b>Lab Registration(s):</b>	FCC #714830	IC Lab File #3874	

## Appendix B - GSM Conducted RF Output Power Measurement

### B.1 REFERENCES

<b>Normative Reference Standard</b>	FCC CFR 47 §2.1046 (a)
<b>Procedure Reference</b>	FCC 97-114

### B.2 LIMITS

#### B.2.1 FCC CFR 47

FCC CFR 47 §2.1046 (a) For transmitters other than single sideband, independent sideband and controlled carrier radiotelephone, power output shall be measured at the RF output terminals when the transmitter is adjusted in accordance with the tune-up procedures to give the values of current and voltage on the circuit elements specified in §2.1033(c) (8).

\*ERP and EIRP limits are specified in Appendix C.

### B.3 ENVIRONMENTAL CONDITIONS

<b>Temperature</b>	25.2 +/- 2 °C
<b>Humidity</b>	35 +/- 2 %
<b>Barometric Pressure</b>	96.34 kPa

### B.4 EQUIPMENT LIST

ASSET NUMBER	MANUFACTURER	MODEL	DESCRIPTION	LAST CAL	CAL DUE
00008	Gigatronics	8652A	Power Meter	30Apr04	30Apr05
00010	Gigatronics	80701A	Power Sensor	30Apr04	30Apr05
00012	Gigatronics	80701A	Power Sensor	30Apr04	30Apr05
00107	HP	8491C	Attenuator	n/a	n/a

\*Cable and attenuator verified with power meter prior to use

<b>Applicant:</b>	Itronix Corporation	<b>Model:</b>	IX100XAC775	<b>FCC ID:</b>	KBCIX100XAC775	<b>IC ID:</b>	1943A-IX100Xe
<b>Rugged Handheld PC with internal Sierra Wireless AirCard 775 Dual-Band GSM GPRS/EDGE Modem</b>							
2005 Celltech Labs Inc	This document is not to be reproduced in whole or in part without the written permission of Celltech Labs Inc.						15 of 35

<b>Test Report S/N:</b>	102604KBC-T578-E24G Issue 1.0		
<b>Test Date(s):</b>	28Jan05 - 01Feb05		
<b>Test Type(s):</b>	FCC §2, §22H, §24E	IC RSS-132/133	
<b>Lab Registration(s):</b>	FCC #714830	IC Lab File #3874	

<b>B.5 MEASUREMENT EQUIPMENT SETUP</b>	
<b>Measurement Equipment Connections</b>	The equipment was connected as shown in the setup drawing in B.6.
<b>Measurement Equipment Settings</b>	Power Meter Settings: Mode - BAP Frequency compensation set for carrier frequency Offset set appropriately for carrier frequency and attenuator characteristics
<b>Measurement Procedure</b>	The RF conducted power levels for both PCS and cellular bands were measured at the DUT antenna connector port using a Gigatronics 8652A Universal Power Meter in burst average power mode. An offset was entered into the power meter to correct for the losses of the attenuator and cable installed between the transmitter output port and the power sensor input. The DUT test software was used to set it to transmit in the GSM "always up" power control mode. All subsequent tests were performed using the same power measurement procedures.

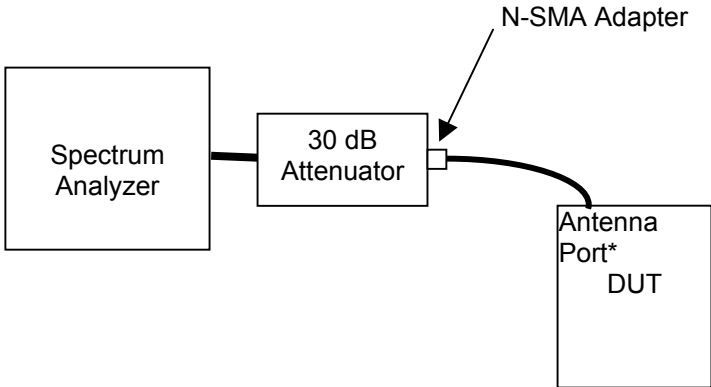
<b>B.6 SETUP DRAWING</b>	
Figure B.6-1 - Setup Drawing	
 <pre> graph LR     SA[Spectrum Analyzer] --- A[30 dB Attenuator]     A --- NSMA[N-SMA Adapter]     NSMA --- AP[Antenna Port* DUT]             </pre>	
*measurement made/referenced at PCMCIA card antenna connector port.	

<b>Applicant:</b>	Itronix Corporation	<b>Model:</b>	IX100XAC775	<b>FCC ID:</b>	KBCIX100XAC775	<b>IC ID:</b>	1943A-IX100Xe	
<b>Rugged Handheld PC with internal Sierra Wireless AirCard 775 Dual-Band GSM GPRS/EDGE Modem</b>								
2005 Celltech Labs Inc	This document is not to be reproduced in whole or in part without the written permission of Celltech Labs Inc.						16 of 35	



<b>Test Report S/N:</b>	102604KBC-T578-E24G Issue 1.0		
<b>Test Date(s):</b>	28Jan05 - 01Feb05		
<b>Test Type(s):</b>	FCC §2, §22H, §24E	IC RSS-132/133	
<b>Lab Registration(s):</b>	FCC #714830	IC Lab File #3874	

**B.7 DUT OPERATING DESCRIPTION**

Power measurements were made of each channel in both the cellular and PCS bands, with the GSM modem set appropriately as described in section 5.7.1

**B.8 TEST RESULTS**

Mode	Channel	Frequency	Conducted Power
Cellular GSM	128	824.2 MHz	+32.06 dBm
	190	836.6 MHz	+31.92 dBm
	251	848.8 MHz	+31.87 dBm
PCS GSM	512	1850.2 MHz	+28.58 dBm
	661	1880.0 MHz	+28.58 dBm
	810	1909.8 MHz	+28.82 dBm

**B.9 PASS/FAIL**

There is no pass/fail criterion for this measurement.

**B.10 SIGN-OFF**

I attest to the accuracy of the data. All measurements reported herein were performed by me and are correct to the best of my knowledge and belief. I assume full responsibility for the completeness of these measurements.



\_\_\_\_\_  
 Russell Pipe  
 Senior Compliance Technologist  
 Celltech Labs Inc.

\_\_\_\_\_  
 28Jan05

Date

<b>Test Report S/N:</b>	102604KBC-T578-E24G Issue 1.0		
<b>Test Date(s):</b>	28Jan05 - 01Feb05		
<b>Test Type(s):</b>	FCC §2, §22H, §24E	IC RSS-132/133	
<b>Lab Registration(s):</b>	FCC #714830	IC Lab File #3874	

## Appendix C - Effective Radiated Power / Effective Isotropic Radiated Power Measurement

### C.1 REFERENCES

<b>Normative Reference Standard</b>	FCC CFR 47 §22.913 (a), FCC CFR 47 §24.232 (b)
<b>Procedure Reference</b>	ANSI/TIA/EIA-603-C

### C.2 LIMITS

#### C.2.1 FCC CFR 47

FCC CFR 47 §22.913 (a)	(a) <i>Maximum ERP. .... The ERP of mobile transmitters and auxiliary transmitters must not exceed 7 Watts.</i>
FCC CFR 47 §24.232 (b)	(b) <i>Mobile/portable stations are limited to 2 watts e.i.r.p. peak power and the equipment must employ means to limit the power to the minimum necessary for successful communications.</i>

### C.3 ENVIRONMENTAL CONDITIONS

<b>Temperature</b>	27.4 +/- 2 °C
<b>Humidity</b>	33 +/- 2 %
<b>Barometric Pressure</b>	96.24 +/- 0.2 kPa

### C.4 EQUIPMENT LIST

ASSET NUMBER	MANUFACTURER	MODEL	DESCRIPTION	LAST CAL	CAL DUE
00072	EMCO	2075	Mini-mast	n/a	n/a
00073	EMCO	2080	Turn Table	n/a	n/a
00071	EMCO	2090	Multi-Device Controller	n/a	n/a
00055	EMCO	3121C	Dipole Antenna	4Dec03	4Dec05
00034	ETS	3115	Double Ridged Guide Horn	24Mar04	24Mar05
00036	ETS	3115	Double Ridged Guide Horn	24Mar04	24Mar05
00202	ETS	3160-09	Small Horn Antenna	27May04	27Jun05
00049	HP	8566B	Spectrum Analyzer RF Section	18May04	18May05
00049	HP	85650A	Quasi-peak Adapter	18May04	18May05
00047	HP	85685A	RF Preselector	18May04	18May05
00048	Gore	65474	Microwave Cable	20May04	20May05
00030	HP	83017A	LNA	20May04	20May05
00006	R & S	SMR 20	Signal Generator (10MHz-40GHz)	30Apr04	30Apr05
00114	Amplifier Research	DC7154	Directional Coupler (0.8-4.2 GHz)	n/a	n/a
00078	Pasternack	PE2214-20	Directional Coupler (1-18 GHz)	n/a	n/a
00106	Amplifier Research	5S1G4	Power Amplifier (5W, 800MHz-4.2GHz)	n/a	n/a
00041	Amplifier Research	10W1000C	Power Amplifier (0.5 – 1 GHz)	n/a	n/a
00008	Gigatronics	8652A	Power Meter	30Apr04	30Apr05
00010	Gigatronics	80701A	Power Sensor	30Apr04	30Apr05

<b>Applicant:</b>	Itronix Corporation	<b>Model:</b>	IX100XAC775	<b>FCC ID:</b>	KBCIX100XAC775	<b>IC ID:</b>	1943A-IX100Xe
<b>Rugged Handheld PC with internal Sierra Wireless AirCard 775 Dual-Band GSM GPRS/EDGE Modem</b>							
2005 Celltech Labs Inc	This document is not to be reproduced in whole or in part without the written permission of Celltech Labs Inc.						18 of 35

<b>Test Report S/N:</b>	102604KBC-T578-E24G Issue 1.0		
<b>Test Date(s):</b>	28Jan05 - 01Feb05		
<b>Test Type(s):</b>	FCC §2, §22H, §24E	IC RSS-132/133	
<b>Lab Registration(s):</b>	FCC #714830	IC Lab File #3874	

### C.5 MEASUREMENT EQUIPMENT SETUP

<b>MEASUREMENT EQUIPMENT CONNECTIONS</b>	For the field strength measurements, the measurement equipment was connected as shown in C.6. A number of antennas were used to cover the applicable frequency range tested <sup>1</sup> . The ranges in which each antenna was used are as follows. For the final substitutions, the DUT was replaced with the appropriate antenna and fed from a CW signal source sufficient to replicate the received field strength of the emission being investigated.			
	Frequency Range		RX Antenna	TX Antenna
	30 MHz – 1GHz		Dipole	Dipole
	1 GHz – 18 GHz		ETS 3115 Horn	ETS 3115 Horn
<b>MEASUREMENT EQUIPMENT SETTINGS</b>	For the spurious out-of-band emissions, the spectrum analyzer was set to the following settings:			
	Mode	RBW	VBW	Detector
		kHz	kHz	
	Cellular	100	300	Peak
	PCS	1000	1000	Peak

### C.6 SETUP DRAWING

Figure C.6-1 - Setup Drawing

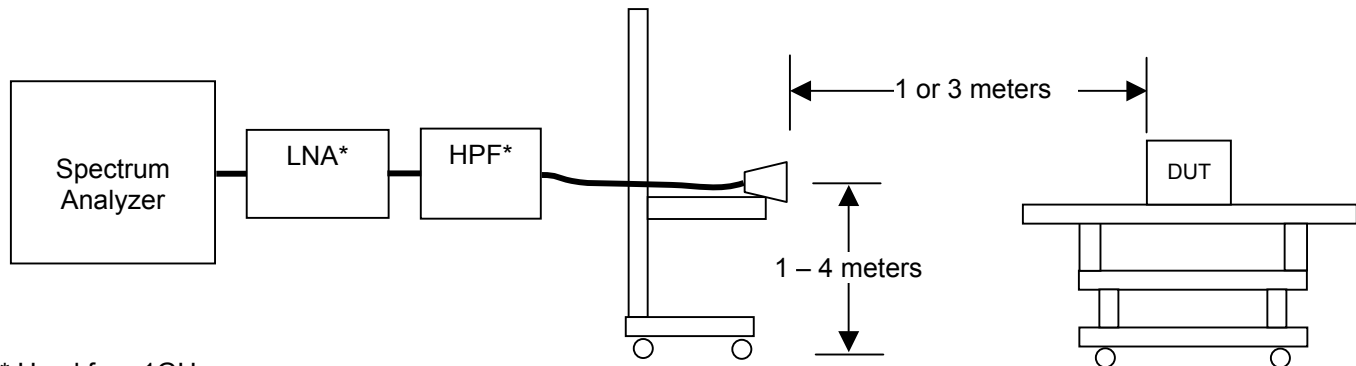

\* Used for >1GHz

<b>Applicant:</b>	Itronix Corporation	<b>Model:</b>	IX100XAC775	<b>FCC ID:</b>	KBCIX100XAC775	<b>IC ID:</b>	1943A-IX100Xe
<b>Rugged Handheld PC with internal Sierra Wireless AirCard 775 Dual-Band GSM GPRS/EDGE Modem</b>							
2005 Celltech Labs Inc	This document is not to be reproduced in whole or in part without the written permission of Celltech Labs Inc.						19 of 35

<b>Test Report S/N:</b>	102604KBC-T578-E24G Issue 1.0		
<b>Test Date(s):</b>	28Jan05 - 01Feb05		
<b>Test Type(s):</b>	FCC §2, §22H, §24E	IC RSS-132/133	
<b>Lab Registration(s):</b>	FCC #714830	IC Lab File #3874	

### C.7 SETUP PHOTOGRAPHS

<p>Photograph C.7-1 - Dipole Receive Antenna with DUT Helix Antenna Configuration</p>	<p>Photograph C.7-2 - Horn Receive Antenna with DUT Helix Antenna Configuration</p>
	
<p>Photograph C.7-3 - Horn Receive Antenna with DUT Vehicle-Mount Antenna Configuration</p>	<p>Photograph C.7-4 - Dipole Substitution Setup</p>
	

### C.8 DUT OPERATING DESCRIPTION

Measurements were made for the low, mid and high GSM channels transmitting in each of the cellular and PCS bands at maximum power levels as described in Appendix B. Each antenna configuration (attached Helix and MaxRad vehicle-mount) was evaluated.

<b>Applicant:</b>	Itronix Corporation	<b>Model:</b>	IX100XAC775	<b>FCC ID:</b>	KBCIX100XAC775	<b>IC ID:</b>	1943A-IX100Xe
<b>Rugged Handheld PC with internal Sierra Wireless AirCard 775 Dual-Band GSM GPRS/EDGE Modem</b>							
2005 Celltech Labs Inc	This document is not to be reproduced in whole or in part without the written permission of Celltech Labs Inc.						20 of 35

<b>Test Report S/N:</b>	102604KBC-T578-E24G Issue 1.0		
<b>Test Date(s):</b>	28Jan05 - 01Feb05		
<b>Test Type(s):</b>	FCC §2, §22H, §24E	IC RSS-132/133	
<b>Lab Registration(s):</b>	FCC #714830	IC Lab File #3874	

## C.9 TEST RESULTS

### C.9.1 Carrier Levels (Attached Helix Antenna)

#### C.9.1.1 Cellular GSM Carrier Levels



**Project Number:** 102604KBC-T578  
**Company:** Itronix  
**Product:** IX100X+ with AC775

**Standard:** FCC22.913  
**Test Start Date:** 28-Jan-05  
**Test End Date:** 31-Jan-05

**Attached Helix Antenna Carrier Power Levels**

Polarity	Distance m	Rx Antenna	Tx Antenna	Channel	Frequency	Corrected Field Strength	Substituted SA Signal Level	Power Applied to Antenna	Antenna Gain	Carrier ERP Level		ERP Limit		Margin dB	Pass/Fail
					MHz	dBuV/m	dBuV	dBm	dBd	dBm	Watts	dBm	Watts		
H	3	A_3121C	B_3121C	128	824.20	130.91	101.66	31.89	-0.86	28.89	0.774	38.45	7.00	9.56	PASS
H	3	A_3121C	B_3121C	190	836.60	129.46	100.24	32.46	-0.71	29.61	0.914	38.45	7.00	8.84	PASS
H	3	A_3121C	B_3121C	251	848.80	129.69	100.50	32.75	-0.56	30.05	1.01	38.45	7.00	8.40	PASS
V	3	A_3121C	B_3121C	128	824.20	128.05	98.80	27.95	-0.86	24.95	0.312	38.45	7.00	13.50	PASS
V	3	A_3121C	B_3121C	190	836.60	129.20	99.98	31.53	-0.71	28.68	0.738	38.45	7.00	9.77	PASS
V	3	A_3121C	B_3121C	251	848.80	127.75	98.56	29.86	-0.56	27.16	0.519	38.45	7.00	11.29	PASS

Note:  
EUT orientation same as RX antenna polarity  
Dipole Antenna used for substitution  
Antenna factors are stated in dBd  
ERP = Power applied to Antenna + Antenna Gain  
Margin = Limit - Level

#### C.9.1.2 PCS GSM Carrier Levels



**Project Number:** 102604KBC-T578  
**Company:** Itronix  
**Product:** IX100X+ with AC775

**Standard:** FCC24.232b  
**Test Start Date:** 28-Jan-05  
**Test End Date:** 31-Jan-05

**Attached Helix Antenna Carrier Power Levels**

Polarity	Distance m	Rx Antenna	Tx Antenna	Channel	Frequency	Corrected Field Strength	Substituted SA Signal Level	Power Applied to Antenna	Antenna Gain	Carrier EIRP Level		EIRP Limit		Margin dB	Pass/Fail
					MHz	dBuV/m	dBuV	dBm	dBi	dBm	Watts	dBm	Watts		
H	3	Horn SN6276	Horn SN6267	512	1850.20	125.43	93.48	21.92	6.55	28.47	0.703	33.01	2.00	4.54	PASS
H	3	Horn SN6276	Horn SN6267	661	1880.00	125.53	93.44	23.31	6.58	29.89	0.975	33.01	2.00	3.12	PASS
H	3	Horn SN6276	Horn SN6267	810	1909.80	123.83	91.58	24.29	6.61	30.90	1.23	33.01	2.00	2.11	PASS
V	3	Horn SN6276	Horn SN6267	512	1850.20	122.65	90.70	19.83	6.55	26.38	0.435	33.01	2.00	6.63	PASS
V	3	Horn SN6276	Horn SN6267	661	1880.00	123.61	91.52	21.33	6.58	27.91	0.618	33.01	2.00	5.10	PASS
V	3	Horn SN6276	Horn SN6267	810	1909.80	120.35	88.10	20.44	6.61	27.05	0.507	33.01	2.00	5.96	PASS

Note:  
EUT orientation same as RX antenna polarity  
Horn Antenna used for substitution  
Antenna factors are stated in dBi  
EIRP = Power applied to Antenna + Antenna Gain  
Margin = Limit - Level

**Applicant:** Itronix Corporation    **Model:** IX100XAC775    **FCC ID:** KBCIX100XAC775    **IC ID:** 1943A-IX100Xe

**Rugged Handheld PC with internal Sierra Wireless AirCard 775 Dual-Band GSM GPRS/EDGE Modem**



<b>Test Report S/N:</b>	102604KBC-T578-E24G Issue 1.0		
<b>Test Date(s):</b>	28Jan05 - 01Feb05		
<b>Test Type(s):</b>	FCC §2, §22H, §24E	IC RSS-132/133	
<b>Lab Registration(s):</b>	FCC #714830	IC Lab File #3874	

### C.9.2 Carrier Levels (Vehicle-Mount Dipole Antenna)

#### C.9.2.1 PCS GSM Carrier Levels

	<b>Project Number:</b>	102604KBC-T578	<b>Standard:</b>	FCC22.913
	<b>Company:</b>	Itronix	<b>Test Start Date:</b>	28-Jan-05
	<b>Product:</b>	IX100X+ with AC775	<b>Test End Date:</b>	31-Jan-05

Polarity	Distance	Rx Antenna	Tx Antenna	Channel	Frequency	Corrected Field Strength	Substituted SA Signal Level	Power Applied to Antenna	Antenna Gain	Carrier ERP Level		ERP Limit		Margin	Pass/Fail
					MHz	dBuV/m	dBuV	dBm	dBd	dBm	Watts	dBm	Watts		
H	3	A_3121C	B_3121C	128	824.20	115.25	86.00	16.13	-0.86	13.13	0.021	38.45	7.00	25.32	PASS
H	3	A_3121C	B_3121C	190	836.60	117.72	88.50	19.20	-0.71	16.35	0.043	38.45	7.00	22.10	PASS
H	3	A_3121C	B_3121C	251	848.80	117.19	88.00	18.66	-0.56	15.96	0.039	38.45	7.00	22.49	PASS
V	3	A_3121C	B_3121C	128	824.20	125.31	96.06	25.26	-0.86	22.26	0.168	38.45	7.00	16.19	PASS
V	3	A_3121C	B_3121C	190	836.60	127.82	98.60	30.21	-0.71	27.36	0.544	38.45	7.00	11.09	PASS
V	3	A_3121C	B_3121C	251	848.80	125.33	96.14	28.03	-0.56	25.33	0.341	38.45	7.00	13.12	PASS

Note:  
EUT orientation same as RX antenna polarity  
Dipole Antenna used for substitution  
Antenna factors are stated in dBd  
ERP = Power applied to Antenna + Antenna Gain  
Margin = Limit - Level

#### C.9.2.2 PCS GSM Carrier Levels

	<b>Project Number:</b>	102604KBC-T578	<b>Standard:</b>	FCC24.232b
	<b>Company:</b>	Itronix	<b>Test Start Date:</b>	28-Jan-05
	<b>Product:</b>	IX100X+ with AC775	<b>Test End Date:</b>	31-Jan-05

Polarity	Distance	Rx Antenna	Tx Antenna	Channel	Frequency	Corrected Field Strength	Substituted SA Signal Level	Power Applied to Antenna	Antenna Gain	Carrier EIRP Level		EIRP Limit		Margin	Pass/Fail
					MHz	dBuV/m	dBuV	dBm	dBi	dBm	Watts	dBm	Watts		
H	3	Horn SN6276	Horn SN6267	512	1850.20	110.85	78.90	7.30	6.55	13.85	0.024	33.01	2.00	19.16	PASS
H	3	Horn SN6276	Horn SN6267	661	1880.00	108.19	76.10	7.50	6.58	14.08	0.026	33.01	2.00	18.93	PASS
H	3	Horn SN6276	Horn SN6267	810	1909.80	107.55	75.30	8.61	6.61	15.22	0.033	33.01	2.00	17.79	PASS
V	3	Horn SN6276	Horn SN6267	512	1850.20	120.51	88.56	17.79	6.55	24.34	0.272	33.01	2.00	8.67	PASS
V	3	Horn SN6276	Horn SN6267	661	1880.00	119.81	87.72	17.68	6.58	24.26	0.267	33.01	2.00	8.75	PASS
V	3	Horn SN6276	Horn SN6267	810	1909.80	118.13	85.88	18.23	6.61	24.84	0.305	33.01	2.00	8.17	PASS

Note:  
EUT orientation same as RX antenna polarity  
Horn Antenna used for substitution  
Antenna factors are stated in dBi  
EIRP = Power applied to Antenna + Antenna Gain  
Margin = Limit - Level

<b>Applicant:</b>	Itronix Corporation	<b>Model:</b>	IX100XAC775	<b>FCC ID:</b>	KBCIX100XAC775	<b>IC ID:</b>	1943A-IX100Xe
<b>Rugged Handheld PC with internal Sierra Wireless AirCard 775 Dual-Band GSM GPRS/EDGE Modem</b>							
2005 Celltech Labs Inc	This document is not to be reproduced in whole or in part without the written permission of Celltech Labs Inc.						22 of 35



<b>Test Report S/N:</b>	102604KBC-T578-E24G Issue 1.0		
<b>Test Date(s):</b>	28Jan05 - 01Feb05		
<b>Test Type(s):</b>	FCC §2, §22H, §24E	IC RSS-132/133	
<b>Lab Registration(s):</b>	FCC #714830	IC Lab File #3874	

### C.10 PASS/FAIL

In reference to the results outlined in C.9, the DUT passes the requirements as stated in the reference standards as follows:

FCC 22.913 (a) Maximum ERP. .... The ERP of mobile transmitters and auxiliary transmitters must not exceed 7 Watts. A maximum ERP of 30.05 dBm (1.01 Watts) was measured when Channel 251 was transmitting through the attached Helix antenna. A maximum ERP of 27.36 dBm (0.544 Watts) was measured when Channel 190 was transmitting through the MaxRad vehicle-mount antenna.

FCC 24.232 (b): Mobile/portable stations are limited to 2 watts e.i.r.p. peak power....

A maximum EIRP of 30.9 dBm (1.23 Watts) was measured when Channel 810 was transmitting through the attached Helix antenna. A maximum EIRP of 24.84 dBm (0.305 Watts) was measured when Channel 810 was transmitting through the MaxRad vehicle-mount antenna.

### C.11 SIGN-OFF

I attest to the accuracy of the data. All measurements reported herein were performed by me and are correct to the best of my knowledge and belief. I assume full responsibility for the completeness of these measurements.



Russell Pipe  
Senior Compliance Technologist  
Celltech Labs Inc.

31Jan05  
Date

<b>Applicant:</b>	Itronix Corporation	<b>Model:</b>	IX100XAC775	<b>FCC ID:</b>	KBCIX100XAC775	<b>IC ID:</b>	1943A-IX100Xe
<b>Rugged Handheld PC with internal Sierra Wireless AirCard 775 Dual-Band GSM GPRS/EDGE Modem</b>							
2005 Celltech Labs Inc	This document is not to be reproduced in whole or in part without the written permission of Celltech Labs Inc.						23 of 35

<b>Test Report S/N:</b>	102604KBC-T578-E24G Issue 1.0		
<b>Test Date(s):</b>	28Jan05 - 01Feb05		
<b>Test Type(s):</b>	FCC §2, §22H, §24E	IC RSS-132/133	
<b>Lab Registration(s):</b>	FCC #714830	IC Lab File #3874	

## Appendix D - Radiated Spurious Emissions Measurement

### D.1 REFERENCES

<b>Normative Reference Standard</b>	FCC CFR 47 §22.917(a), FCC CFR 47 §24.238(a)
<b>Procedure Reference</b>	ANSI/TIA/EIA-603-C

### D.2 LIMITS

#### D.2.1 FCC CFR 47

FCC CFR 47 §22.917	(a) Out of band emissions. The power of any emission outside of the authorized operating frequency ranges must be attenuated below the transmitting power (P) by a factor of at least $43 + 10 \log(P)$ dB
FCC CFR 47 §24.238	(a) Out of band emissions. The power of any emission outside of the authorized operating frequency ranges must be attenuated below the transmitting power (P) by a factor of at least $43 + 10 \log(P)$ dB.

### D.3 ENVIRONMENTAL CONDITIONS

<b>Temperature</b>	27.4 +/- 2 °C
<b>Humidity</b>	33 +/- 2 %
<b>Barometric Pressure</b>	96.24 +/- 0.2 kPa

### D.4 EQUIPMENT LIST

ASSET NUMBER	MANUFACTURER	MODEL	DESCRIPTION	LAST CAL	CAL DUE
00072	EMCO	2075	Mini-mast	n/a	n/a
00073	EMCO	2080	Turn Table	n/a	n/a
00071	EMCO	2090	Multi-Device Controller	n/a	n/a
00050	Chase	CBL-6111A	Bilog Antenna	30Apr04	30Apr05
00055	EMCO	3121C	Dipole Antenna	4Dec03	4Dec05
00034	ETS	3115	Double Ridged Guide Horn	24Mar04	24Mar05
00036	ETS	3115	Double Ridged Guide Horn	24Mar04	24Mar05
00202	ETS	3160-09	Small Horn Antenna	27May04	27Jun05
00049	HP	8566B	Spectrum Analyzer RF Section	18May04	18May05
00049	HP	85650A	Quasi-peak Adapter	18May04	18May05
00047	HP	85685A	RF Preselector	18May04	18May05
00048	Gore	65474	Microwave Cable	20May04	20May05
00030	HP	83017A	LNA	20May04	20May05
00006	R & S	SMR 20	Signal Generator (10MHz-40GHz)	30Apr04	30Apr05
00114	Amplifier Research	DC7154	Directional Coupler (0.8-4.2 GHz)	n/a	n/a
00078	Pasternack	PE2214-20	Directional Coupler (1-18 GHz)	n/a	n/a
00106	Amplifier Research	5S1G4	Power Amplifier (5W, 800MHz-4.2GHz)	n/a	n/a
00041	Amplifier Research	10W1000C	Power Amplifier (0.5 – 1 GHz)	n/a	n/a
00008	Gigatronics	8652A	Power Meter	30Apr04	30Apr05
00010	Gigatronics	80701A	Power Sensor	30Apr04	30Apr05

<b>Applicant:</b>	Itronix Corporation	<b>Model:</b>	IX100XAC775	<b>FCC ID:</b>	KBCIX100XAC775	<b>IC ID:</b>	1943A-IX100Xe
<b>Rugged Handheld PC with internal Sierra Wireless AirCard 775 Dual-Band GSM GPRS/EDGE Modem</b>							
2005 Celltech Labs Inc	This document is not to be reproduced in whole or in part without the written permission of Celltech Labs Inc.						24 of 35



<b>Test Report S/N:</b>	102604KBC-T578-E24G Issue 1.0		
<b>Test Date(s):</b>	28Jan05 - 01Feb05		
<b>Test Type(s):</b>	FCC §2, §22H, §24E	IC RSS-132/133	
<b>Lab Registration(s):</b>	FCC #714830	IC Lab File #3874	

### D.5 MEASUREMENT EQUIPMENT SETUP

<b>MEASUREMENT EQUIPMENT CONNECTIONS</b>	For the field strength measurements, the measurement equipment was connected as shown in D.6. A number of antennas were used to cover the applicable frequency range tested <sup>1</sup> . The ranges in which each antenna was used are as follows. For the final substitutions, the DUT was replaced with the appropriate antenna and fed from a CW signal source sufficient to replicate the received field strength of the emission being investigated.			
	Frequency Range	RX Antenna	TX Antenna	
	30 MHz – 1GHz	Bilog	Dipole	
	1 GHz – 18 GHz	ETS 3115 Horn	ETS 3115 Horn	
	18 GHz – 20 GHz	ETS 3160-09 Horn	ETS 3160-09 Horn	
<b>MEASUREMENT EQUIPMENT SETTINGS</b>	For the spurious out-of-band emissions, the spectrum analyzer was set to the following settings:			
	Mode	RBW	VBW	Detector
		kHz	kHz	
	Cellular	100	300	Peak*
	PCS	1000	1000	Peak*
*Where the peak emission exceeded the average limit, an average measurement was made using video averaging				

### D.6 SETUP DRAWING

Figure D.6-1 - Setup Drawing

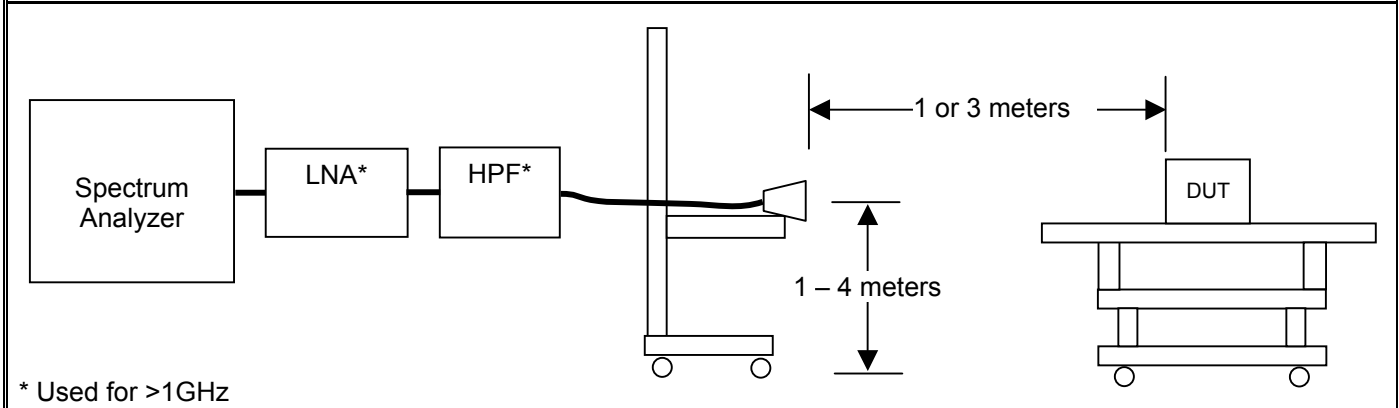

<b>Applicant:</b>	Itronix Corporation	<b>Model:</b>	IX100XAC775	<b>FCC ID:</b>	KBCIX100XAC775	<b>IC ID:</b>	1943A-IX100Xe
<b>Rugged Handheld PC with internal Sierra Wireless AirCard 775 Dual-Band GSM GPRS/EDGE Modem</b>							
2005 Celltech Labs Inc	This document is not to be reproduced in whole or in part without the written permission of Celltech Labs Inc.						25 of 35

<b>Test Report S/N:</b>	102604KBC-T578-E24G Issue 1.0		
<b>Test Date(s):</b>	28Jan05 - 01Feb05		
<b>Test Type(s):</b>	FCC §2, §22H, §24E	IC RSS-132/133	
<b>Lab Registration(s):</b>	FCC #714830	IC Lab File #3874	

### D.7 SETUP PHOTOGRAPHS

Photograph D.7-1 - BiConilog Receive Antenna with DUT Vehicle-Mount Antenna Configuration



Photograph D.7-2 - Horn Receive Antenna with DUT Helix Antenna Configuration



### D.8 DUT OPERATING DESCRIPTION

Measurements were made for the low, mid and high GSM channels transmitting in each of the cellular and PCS bands at maximum power levels as described in Appendix B. Each antenna configuration (attached Helix and MaxRad vehicle-mount) was evaluated.

<b>Applicant:</b>	Itronix Corporation	<b>Model:</b>	IX100XAC775	<b>FCC ID:</b>	KBCIX100XAC775	<b>IC ID:</b>	1943A-IX100Xe
<b>Rugged Handheld PC with internal Sierra Wireless AirCard 775 Dual-Band GSM GPRS/EDGE Modem</b>							
2005 Celltech Labs Inc	This document is not to be reproduced in whole or in part without the written permission of Celltech Labs Inc.						26 of 35

<b>Test Report S/N:</b>	102604KBC-T578-E24G Issue 1.0		
<b>Test Date(s):</b>	28Jan05 - 01Feb05		
<b>Test Type(s):</b>	FCC §2, §22H, §24E	IC RSS-132/133	
<b>Lab Registration(s):</b>	FCC #714830	IC Lab File #3874	

## D.9 TEST RESULTS

The spurious measurements detailed in this section are referenced to the carrier levels set forth in Appendix C of this report:

### D.9.1 Spurious Emissions (Attached Helix Antenna)

#### D.9.1.1 Cellular GSM Spurious Emissions



**Project Number:** 102604KBC-T578  
**Company:** Itronix  
**Product:** IX100X+ with AC775

**Standard:** FCC22.917  
**Test Start Date:** 28-Jan-05  
**Test End Date:** 31-Jan-05

**Attached Helix Antenna**

Polarity	Distance	Rx Antenna	Tx Antenna	Channel	Frequency	Corrected Field Strength	Substituted SA Signal Level	Power Applied to Antenna	Antenna Gain	ERP Emission Level	ERP Limit	Margin	Pass/Fail
					MHz	dBuV/m	dBuV	dBm	dBd	dBm	dBm*	dB	
H	3	Horn SN6276	Horn SN6267	128	1648.00	73.76	43.00	-35.10	4.20	-30.90	-13.00	17.90	PASS
H	3	Horn SN6276	Horn SN6267	128	2472.00	47.57	50.40	-48.40	5.59	-42.81	-13.00	29.81	PASS
H	3	Horn SN6276	Horn SN6267	128	3295.75	51.87	51.10	-49.00	5.83	-43.17	-13.00	30.17	PASS
V	3	Horn SN6276	Horn SN6267	128	1648.00	79.51	48.75	-28.46	4.20	-24.26	-13.00	11.26	PASS
V	3	Horn SN6276	Horn SN6267	128	2472.00	45.97	48.80	-55.51	5.59	-49.92	-13.00	36.92	PASS
V	3	Horn SN6276	Horn SN6267	128	3295.75	51.47	50.70	-48.30	5.83	-42.47	-13.00	29.47	PASS
H	3	Horn SN6276	Horn SN6267	190	1673.00	75.75	44.85	-32.96	4.22	-28.74	-13.00	15.74	PASS
H	3	Horn SN6276	Horn SN6267	190	2510.00	46.91	49.60	-51.50	5.65	-45.85	-13.00	32.85	PASS
H	3	Horn SN6276	Horn SN6267	190	3346.50	52.35	51.35	-49.00	5.86	-43.14	-13.00	30.14	PASS
V	3	Horn SN6276	Horn SN6267	190	1673.00	80.55	49.65	-27.01	4.22	-22.79	-13.00	9.79	PASS
V	3	Horn SN6276	Horn SN6267	190	2510.00	49.61	52.30	-48.90	5.65	-43.25	-13.00	30.25	PASS
V	3	Horn SN6276	Horn SN6267	190	3346.50	54.20	53.20	-47.20	5.86	-41.34	-13.00	28.34	PASS
H	3	Horn SN6276	Horn SN6267	251	1697.00	75.84	44.80	-33.00	4.25	-28.75	-13.00	15.75	PASS
H	3	Horn SN6276	Horn SN6267	251	2546.00	46.43	48.90	-53.50	5.65	-47.85	-13.00	34.85	PASS
H	3	Horn SN6276	Horn SN6267	251	3395.20	47.63	46.40	-52.30	5.89	-46.41	-13.00	33.41	PASS
V	3	Horn SN6276	Horn SN6267	251	1697.00	81.14	50.10	-25.69	4.25	-21.44	-13.00	8.44	PASS
V	3	Horn SN6276	Horn SN6267	251	2546.00	47.98	50.45	-49.60	5.65	-43.95	-13.00	30.95	PASS
V	3	Horn SN6276	Horn SN6267	251	3395.20	51.28	50.05	-44.30	5.89	-38.41	-13.00	25.41	PASS

Note:  
 EUT orientation same as RX antenna polarity  
 Antenna factors are stated in dBd  
 ERP = Power applied to Antenna + Antenna Gain  
 Margin = Limit - Level  
 Limit =  $43 + 10 \cdot \log(\text{Fundamental Power Level, in watts})$  below the Fundamental peak power => -13 dBm

\*The emissions reported above represent the highest emissions or noise floor measured within the frequency band of 30MHz and the 10<sup>th</sup> harmonic of the carrier with field strengths within 20 dB of the theoretical limit. All other emissions attributed to the EUT had field strengths greater than 20 dB below the theoretical limit and substitutions were not made.

<b>Applicant:</b> Itronix Corporation	<b>Model:</b> IX100XAC775	<b>FCC ID:</b> KBCIX100XAC775	<b>IC ID:</b> 1943A-IX100Xe
<b>Rugged Handheld PC with internal Sierra Wireless AirCard 775 Dual-Band GSM GPRS/EDGE Modem</b>			
2005 Celltech Labs Inc	This document is not to be reproduced in whole or in part without the written permission of Celltech Labs Inc.		27 of 35

<b>Test Report S/N:</b>	102604KBC-T578-E24G Issue 1.0		
<b>Test Date(s):</b>	28Jan05 - 01Feb05		
<b>Test Type(s):</b>	FCC §2, §22H, §24E	IC RSS-132/133	
<b>Lab Registration(s):</b>	FCC #714830	IC Lab File #3874	

D.9.1.2 PCS GSM Spurious Emissions



**Project Number:** 102604KBC-T578  
**Company:** Itronix  
**Product:** IX100X+ with AC775

**Standard:** FCC24.238  
**Test Start Date:** 28-Jan-05  
**Test End Date:** 31-Jan-05

Attached Helix Antenna

Polarity	Distance	Rx Antenna	Tx Antenna	Channel	Frequency	Corrected Field Strength	Substituted SA Signal Level	Power Applied to Antenna	Antenna Gain	EIRP Emission Level	EIRP Limit	Margin	Pass/Fail
					MHz	dBuV/m	dBuV	dBm	dBi	dBm	dBm*	dB	
H	3	Horn SN6276	Horn SN6267	512	2725.00	54.25	55.85	-44.00	7.80	-36.20	-13.00	23.20	PASS
H	3	Horn SN6276	Horn SN6267	512	3700.00	58.72	54.40	-49.18	8.06	-41.12	-13.00	28.12	PASS
H	3	Horn SN6276	Horn SN6267	512	5549.75	49.81	42.30	-62.52	8.66	-53.86	-13.00	40.86	PASS
H	1	Horn SN6276	Horn SN6267	512	16417.10	63.29	47.65	-47.98	13.17	-34.81	-13.00	21.81	PASS
H	1	Horn SN6276	Horn SN6267	512	17086.50	60.79	43.25	-47.25	11.42	-35.83	-13.00	22.83	PASS
H	1	3160-09	3160-09	512	18436.00	60.44	46.43	-46.43	15.27	-31.16	-13.00	18.16	PASS
V	3	Horn SN6276	Horn SN6267	512	2698.00	50.63	52.35	-50.69	7.80	-42.89	-13.00	29.89	PASS
V	3	Horn SN6276	Horn SN6267	512	3700.00	56.62	52.30	-51.45	8.06	-43.39	-13.00	30.39	PASS
V	3	Horn SN6276	Horn SN6267	512	5549.75	51.01	43.50	-61.57	8.66	-52.91	-13.00	39.91	PASS
V	1	Horn SN6276	Horn SN6267	512	15963.70	61.84	47.60	-48.07	13.96	-34.11	-13.00	21.11	PASS
V	1	Horn SN6276	Horn SN6267	512	17086.50	60.04	42.50	-46.56	11.42	-35.14	-13.00	22.14	PASS
H	3	Horn SN6276	Horn SN6267	661	3759.50	55.46	51.00	-55.49	8.05	-47.44	-13.00	34.44	PASS
H	3	Horn SN6276	Horn SN6267	661	5640.00	49.56	42.00	-61.47	8.77	-52.70	-13.00	39.70	PASS
H	1	Horn SN6276	Horn SN6267	661	16430.10	63.21	47.50	-47.99	13.14	-34.85	-13.00	21.85	PASS
H	1	Horn SN6276	Horn SN6267	661	17058.00	59.72	42.25	-47.59	11.51	-36.08	-13.00	23.08	PASS
V	3	Horn SN6276	Horn SN6267	661	2759.00	52.45	47.00	-50.80	7.80	-43.00	-13.00	30.00	PASS
V	3	Horn SN6276	Horn SN6267	661	3759.50	57.06	52.60	-52.41	8.05	-44.36	-13.00	31.36	PASS
V	3	Horn SN6276	Horn SN6267	661	5640.00	49.34	42.90	-59.05	8.77	-50.28	-13.00	37.28	PASS
V	1	Horn SN6276	Horn SN6267	661	16391.10	63.34	47.80	-47.79	13.22	-34.57	-13.00	21.57	PASS
V	1	Horn SN6276	Horn SN6267	661	17979.00	62.46	42.20	-45.99	7.99	-38.00	-13.00	25.00	PASS
H	3	Horn SN6276	Horn SN6267	810	3819.00	55.23	50.60	-54.60	8.04	-46.56	-13.00	33.56	PASS
H	3	Horn SN6276	Horn SN6267	810	5729.40	49.57	41.90	-63.02	8.88	-54.14	-13.00	41.14	PASS
H	1	Horn SN6276	Horn SN6267	810	13368.60	61.26	46.35	-48.14	10.82	-37.32	-13.00	24.32	PASS
H	1	Horn SN6276	Horn SN6267	810	16253.00	62.82	47.65	-48.13	13.49	-34.64	-13.00	21.64	PASS
H	1	Horn SN6276	Horn SN6267	810	17493.00	61.90	43.00	-47.02	10.12	-36.90	-13.00	23.90	PASS
H	1	3160-09	3160-09	810	18588.00	59.10	44.80	-46.00	15.34	-30.66	-13.00	17.66	PASS
V	3	Horn SN6276	Horn SN6267	810	3819.00	58.43	53.80	-50.28	8.04	-42.24	-13.00	29.24	PASS
V	3	Horn SN6276	Horn SN6267	810	5729.40	51.27	43.60	-60.12	8.88	-51.24	-13.00	38.24	PASS
V	1	Horn SN6276	Horn SN6267	810	13368.60	61.26	46.35	-48.52	10.82	-37.70	-13.00	24.70	PASS
V	1	Horn SN6276	Horn SN6267	810	16409.00	63.64	48.05	-48.81	13.18	-35.63	-13.00	22.63	PASS
V	1	Horn SN6276	Horn SN6267	810	17187.00	60.60	42.65	-44.90	11.10	-33.80	-13.00	20.80	PASS

Note:  
 EUT orientation same as RX antenna polarity  
 Antenna factors are stated in dBi  
 EIRP = Power applied to Antenna + Antenna Gain  
 Margin = Limit - Level  
 Limit =  $43 + 10 \log(\text{Fundamental Power Level, in watts})$  below the Fundamental peak power => -13 dBm

\*The emissions reported above represent the highest emissions or noise floor measured within the frequency band of 30MHz and the 10<sup>th</sup> harmonic of the carrier with field strengths within 20 dB of the theoretical limit. All other emissions attributed to the EUT had field strengths greater than 20 dB below the theoretical limit and substitutions were not made.

<b>Applicant:</b> Itronix Corporation	<b>Model:</b> IX100XAC775	<b>FCC ID:</b> KBCIX100XAC775	<b>IC ID:</b> 1943A-IX100Xe
<b>Rugged Handheld PC with internal Sierra Wireless AirCard 775 Dual-Band GSM GPRS/EDGE Modem</b>			
2005 Celltech Labs Inc			This document is not to be reproduced in whole or in part without the written permission of Celltech Labs Inc. 28 of 35

<b>Test Report S/N:</b>	102604KBC-T578-E24G Issue 1.0	
<b>Test Date(s):</b>	28Jan05 - 01Feb05	
<b>Test Type(s):</b>	FCC §2, §22H, §24E	IC RSS-132/133
<b>Lab Registration(s):</b>	FCC #714830	IC Lab File #3874

## D.9.2 Spurious Emissions (Vehicle-Mount Dipole Antenna)

### D.9.2.1 Cellular GSM Spurious Emissions



**Project Number:** 102604KBC-T578  
**Company:** Itronix  
**Product:** IX100X+ with AC775

**Standard:** FCC22.917  
**Test Start Date:** 28-Jan-05  
**Test End Date:** 31-Jan-05

**External Mobile Dipole Antenna and Cradle**

Polarity	Distance	Rx Antenna	Tx Antenna	Channel	Frequency	Corrected Field Strength	Substituted SA Signal Level	Power Applied to Antenna	Antenna Gain	ERP Emission Level	ERP Limit	Margin	Pass/Fail
					MHz	dBuV/m	dBuV	dBm	dBd	dBm	dBm*	dB	
H	3	Horn SN6276	Horn SN6267	128	1648.00	68.16	37.40	-48.70	4.20	-44.50	-13.00	31.50	PASS
H	3	Horn SN6276	Horn SN6267	128	2472.00	42.67	45.50	-53.80	5.59	-48.21	-13.00	35.21	PASS
H	3	Horn SN6276	Horn SN6267	128	3295.75	48.82	48.05	-52.00	5.83	-46.17	-13.00	33.17	PASS
V	3	Horn SN6276	Horn SN6267	128	1648.00	70.06	39.30	-46.50	4.20	-42.30	-13.00	29.30	PASS
V	3	Horn SN6276	Horn SN6267	128	2472.00	47.32	50.15	-47.70	5.59	-42.11	-13.00	29.11	PASS
V	3	Horn SN6276	Horn SN6267	128	3295.75	48.07	47.30	-51.80	5.83	-45.97	-13.00	32.97	PASS
H	3	Horn SN6276	Horn SN6267	190	1673.00	69.80	38.90	-38.93	4.22	-34.71	-13.00	21.71	PASS
H	3	Horn SN6276	Horn SN6267	190	2509.00	47.06	49.75	-51.70	5.65	-46.05	-13.00	33.05	PASS
H	3	Horn SN6276	Horn SN6267	190	3344.75	46.09	45.10	-55.20	5.86	-49.34	-13.00	36.34	PASS
V	3	Horn SN6276	Horn SN6267	190	1673.00	73.20	42.30	-35.30	4.22	-31.08	-13.00	18.08	PASS
V	3	Horn SN6276	Horn SN6267	190	2509.00	48.91	51.60	-49.60	5.65	-43.95	-13.00	30.95	PASS
V	3	Horn SN6276	Horn SN6267	190	3344.75	48.04	47.05	-53.10	5.86	-47.24	-13.00	34.24	PASS
H	3	Horn SN6276	Horn SN6267	251	1697.60	74.05	43.00	-34.89	4.25	-30.64	-13.00	17.64	PASS
H	3	Horn SN6276	Horn SN6267	251	2546.00	48.13	50.60	-51.80	5.65	-46.15	-13.00	33.15	PASS
H	3	Horn SN6276	Horn SN6267	251	3395.50	47.73	46.50	-53.70	5.89	-47.81	-13.00	34.81	PASS
V	3	Horn SN6276	Horn SN6267	251	1697.00	69.84	38.80	-38.30	4.25	-34.05	-13.00	21.05	PASS
V	3	Horn SN6276	Horn SN6267	251	2546.00	49.63	52.10	-48.00	5.65	-42.35	-13.00	29.35	PASS
V	3	Horn SN6276	Horn SN6267	251	3395.50	49.28	48.05	-52.20	5.89	-46.31	-13.00	33.31	PASS

Note:  
 EUT orientation same as RX antenna polarity  
 Antenna factors are stated in dBd  
 ERP = Power applied to Antenna + Antenna Gain  
 Margin = Limit - Level  
 Limit =  $43 + 10 \log(\text{Fundamental Power Level, in watts})$  below the Fundamental peak power => -13 dBm

\*The emissions reported above represent the highest emissions or noise floor measured within the frequency band of 30MHz and the 10<sup>th</sup> harmonic of the carrier with field strengths within 20 dB of the theoretical limit. All other emissions attributed to the EUT had field strengths greater than 20 dB below the theoretical limit and substitutions were not made.

<b>Applicant:</b> Itronix Corporation	<b>Model:</b> IX100XAC775	<b>FCC ID:</b> KBCIX100XAC775	<b>IC ID:</b> 1943A-IX100Xe
<b>Rugged Handheld PC with internal Sierra Wireless AirCard 775 Dual-Band GSM GPRS/EDGE Modem</b>			
2005 Celltech Labs Inc	This document is not to be reproduced in whole or in part without the written permission of Celltech Labs Inc.		29 of 35

<b>Test Report S/N:</b>	102604KBC-T578-E24G Issue 1.0	
<b>Test Date(s):</b>	28Jan05 - 01Feb05	
<b>Test Type(s):</b>	FCC §2, §22H, §24E	IC RSS-132/133
<b>Lab Registration(s):</b>	FCC #714830	IC Lab File #3874

D.9.2.2 PCS GSM Spurious Emissions



**Project Number:** 102604KBC-T578  
**Company:** Itronix  
**Product:** IX100X+ with AC775

**Standard:** FCC24.238  
**Test Start Date:** 28-Jan-05  
**Test End Date:** 31-Jan-05

External Mobile Dipole Antenna and Cradle

Polarity	Distance	Rx Antenna	Tx Antenna	Channel	Frequency	Corrected Field Strength	Substituted SA Signal Level	Power Applied to Antenna	Antenna Gain	EIRP Emission Level	EIRP Limit	Margin	Pass/Fail
					MHz	dBuV/m	dBuV	dBm	dBi	dBm	dBm*	dB	
H	1	Horn SN6276	Horn SN6267	512	16418.80	63.65	48.00	-47.82	13.16	-34.66	-13.00	21.66	PASS
H	1	Horn SN6276	Horn SN6267	512	17463.00	61.43	42.45	-47.63	10.22	-37.41	-13.00	24.41	PASS
V	3	Horn SN6276	Horn SN6267	512	3700.00	52.00	49.55	-49.60	8.06	-41.54	-13.00	28.54	PASS
V	1	Horn SN6276	Horn SN6267	512	16428.50	63.35	47.65	-47.30	13.14	-34.16	-13.00	21.16	PASS
V	1	Horn SN6276	Horn SN6267	512	16651.80	58.95	42.60	-47.00	12.61	-34.39	-13.00	21.39	PASS
H	1	Horn SN6276	Horn SN6267	661	16244.90	63.44	48.30	-47.78	13.51	-34.27	-13.00	21.27	PASS
H	1	Horn SN6276	Horn SN6267	661	16920.00	58.53	41.50	-48.12	11.91	-36.21	-13.00	23.21	PASS
V	3	Horn SN6276	Horn SN6267	661	3759.50	50.96	48.35	-52.50	8.05	-44.45	-13.00	31.45	PASS
V	1	Horn SN6276	Horn SN6267	661	14600.40	62.36	46.85	-47.80	11.02	-36.78	-13.00	23.78	PASS
V	1	Horn SN6276	Horn SN6267	661	17571.00	62.14	43.05	-42.80	9.79	-33.01	-13.00	20.01	PASS
H	1	Horn SN6276	Horn SN6267	810	16233.50	63.04	47.95	-47.78	13.53	-34.25	-13.00	21.25	PASS
H	1	Horn SN6276	Horn SN6267	810	17187.00	60.65	42.70	-46.69	11.10	-35.59	-13.00	22.59	PASS
V	3	Horn SN6276	Horn SN6267	810	3819.00	62.12	59.30	-32.47	8.04	-24.43	-13.00	11.43	PASS
V	1	Horn SN6276	Horn SN6267	810	15126.90	62.86	47.85	-47.10	11.71	-35.39	-13.00	22.39	PASS
V	1	Horn SN6276	Horn SN6267	810	17187.00	60.55	42.60	-44.03	11.10	-32.93	-13.00	19.93	PASS

Note:  
 EUT orientation same as RX antenna polarity  
 Antenna factors are stated in dBi  
 EIRP = Power applied to Antenna + Antenna Gain  
 Margin = Limit - Level  
 Limit =  $43 + 10 \cdot \log(\text{Fundamental Power Level, in watts})$  below the Fundamental peak power => -13 dBm

\*The emissions reported above represent the highest emissions or noise floor measured within the frequency band of 30MHz and the 10<sup>th</sup> harmonic of the carrier with field strengths within 20 dB of the theoretical limit. All other emissions attributed to the EUT had field strengths greater than 20 dB below the theoretical limit and substitutions were not made.

<b>Applicant:</b> Itronix Corporation	<b>Model:</b> IX100XAC775	<b>FCC ID:</b> KBCIX100XAC775	<b>IC ID:</b> 1943A-IX100Xe
<b>Rugged Handheld PC with internal Sierra Wireless AirCard 775 Dual-Band GSM GPRS/EDGE Modem</b>			
2005 Celltech Labs Inc	This document is not to be reproduced in whole or in part without the written permission of Celltech Labs Inc.		30 of 35



<b>Test Report S/N:</b>	102604KBC-T578-E24G Issue 1.0		
<b>Test Date(s):</b>	28Jan05 - 01Feb05		
<b>Test Type(s):</b>	FCC §2, §22H, §24E	IC RSS-132/133	
<b>Lab Registration(s):</b>	FCC #714830	IC Lab File #3874	

#### D.10 PASS/FAIL

In reference to the results outlined in D.9, the DUT passes the requirements as stated in the reference standards as follows:

FCC 22.917 (a) Out of band emissions. The power of any emission outside of the authorized operating frequency ranges must be attenuated below the transmitting power (P) by a factor of at least  $43 + 10 \log(P)$  dB.

FCC 24.238 (a): Out of band emissions. The power of any emission outside of the authorized operating frequency ranges must be attenuated below the transmitting power (P) by a factor of at least  $43 + 10 \log(P)$  dB.

#### D.11 SIGN-OFF

I attest to the accuracy of the data. All measurements reported herein were performed by me and are correct to the best of my knowledge and belief. I assume full responsibility for the completeness of these measurements.



Russell Pipe  
Senior Compliance Technologist  
Celltech Labs Inc.

31Jan05  
Date

<b>Applicant:</b>	Itronix Corporation	<b>Model:</b>	IX100XAC775	<b>FCC ID:</b>	KBCIX100XAC775	<b>IC ID:</b>	1943A-IX100Xe	
<b>Rugged Handheld PC with internal Sierra Wireless AirCard 775 Dual-Band GSM GPRS/EDGE Modem</b>								
2005 Celltech Labs Inc	This document is not to be reproduced in whole or in part without the written permission of Celltech Labs Inc.						31 of 35	

<b>Test Report S/N:</b>	102604KBC-T578-E24G Issue 1.0		
<b>Test Date(s):</b>	28Jan05 - 01Feb05		
<b>Test Type(s):</b>	FCC §2, §22H, §24E	IC RSS-132/133	
<b>Lab Registration(s):</b>	FCC #714830	IC Lab File #3874	

## Appendix E - Maximum Permissible Exposure Calculation

### E.1 REFERENCES

<b>Normative Reference Standard</b>	FCC CFR 47§1.1310 IEEE Std C95.1-1999
<b>Procedure Reference</b>	FCC CFR 47§2.1091

### E.2 LIMITS

FCC CFR 47§1.1310 Table 1(b)	Frequency	Power Density
	300 – 1500 MHz	f/1500 mW/cm <sup>2</sup>
	1500 – 100,000 MHz	1.0 mW/cm <sup>2</sup>

### E.3 ENVIRONMENTAL CONDITIONS

<b>Temperature</b>	na
<b>Humidity</b>	na
<b>Barometric Pressure</b>	na

### E.4 EQUIPMENT LIST

ASSET NUMBER	MANUFACTURER	MODEL	DESCRIPTION	LAST CAL	CAL DUE
na					

### E.5 MEASUREMENT EQUIPMENT SETUP

<b>MEASUREMENT EQUIPMENT CONNECTIONS</b>	The results described herein were determined by calculations, so no measurement equipment was used. The power measurements for each radio used in these calculations were made with the system transmitting as described in Appendix B of this report.
<b>MEASUREMENT EQUIPMENT SETTINGS</b>	na

### E.6 SETUP PHOTOS

na
----

### E.7 SETUP DRAWINGS

na
----

### E.8 DUT OPERATING DESCRIPTION

<b>Dual-Band GSM</b>	The maximum GSM RF conducted output power in each band used for these calculations was measured on Channel 128 for cellular and Channel 810 for PCS.
----------------------	--

<b>Applicant:</b>	Itronix Corporation	<b>Model:</b>	IX100XAC775	<b>FCC ID:</b>	KBCIX100XAC775	<b>IC ID:</b>	1943A-IX100Xe
<b>Rugged Handheld PC with internal Sierra Wireless AirCard 775 Dual-Band GSM GPRS/EDGE Modem</b>							
2005 Celltech Labs Inc	This document is not to be reproduced in whole or in part without the written permission of Celltech Labs Inc.						32 of 35



Test Report S/N:	102604KBC-T578-E24G Issue 1.0		
Test Date(s):	28Jan05 - 01Feb05		
Test Type(s):	FCC §2, §22H, §24E	IC RSS-132/133	
Lab Registration(s):	FCC #714830	IC Lab File #3874	

## E.9 TEST RESULTS

### E.9.1 Calculations:

#### Vehicle-Mount Dipole Antenna (Highest Power Cellular GSM Channel):

Ratio of Time ON vs Total TX Time **0.50**

Tx Frequency:	<b>824</b>	(MHz)
RF Output Power at Antenna Input Terminal:	<b>32.06</b>	(dBm)
Source-Based Time -Average Factor:	<b>-3.01</b>	(dB)
Source-Based Time-Averaged RF Output Power at Antenna Input Terminal:	<b>29.05</b>	(dBm)
Antenna gain:	<b>3.00</b>	(dBi)
Cable Loss:	<b>1.89</b>	(dB)
Antenna gain - Cable Loss:	<b>1.11</b>	(dBi)

$$S = \frac{0.55}{1} \text{ (mW/cm}^2\text{)}$$

$$P = \frac{803.4706}{1} \text{ (mW)}$$

$$G = \frac{1.29}{1} \text{ (numeric)}$$

$$R = 12.26 \text{ (cm)}$$

S at 20cm: 0.206171852 (mW/cm<sup>2</sup>)

#### Vehicle-Mount Dipole Antenna (Highest Power PCS GSM Channel):

Ratio of Time ON vs Total TX Time **0.50**

Tx Frequency:	<b>1910</b>	(MHz)
RF Output Power at Antenna Input Terminal:	<b>28.82</b>	(dBm)
Source-Based Time -Average Factor:	<b>-3.01</b>	(dB)
Source-Based Time-Averaged RF Output Power at Antenna Input Terminal:	<b>25.81</b>	(dBm)
Antenna gain:	<b>3.00</b>	(dBi)
Cable Loss:	<b>2.80</b>	(dB)
Antenna gain - Cable Loss:	<b>3.00</b>	(dBi)

$$S = \frac{1.00}{1} \text{ (mW/cm}^2\text{)}$$

$$P = \frac{381.0395}{1} \text{ (mW)}$$

$$G = \frac{2.00}{1} \text{ (numeric)}$$

$$R = 7.78 \text{ (cm)}$$

S at 20cm: 0.151087791 (mW/cm<sup>2</sup>)

#### Formulae:

$$S = \frac{PG}{4\pi R^2}$$

where: S = Power Density Limit  
P = Power Applied to the Antenna  
G = Numeric Antenna Gain  
R = Distance from Antenna

$$R = \sqrt{\frac{P}{4\pi S}}$$

Source-Based Time-Average Factor = 20 \* log (Time On / (Time On + Time Off))

Source-Based Time-Average RF Output Power (dBm) = RF Output Power (dBm) + Source-Based Time Average Factor (dB)

Applicant:	Itronix Corporation	Model:	IX100XAC775	FCC ID:	KBCIX100XAC775	IC ID:	1943A-IX100Xe
Rugged Handheld PC with internal Sierra Wireless AirCard 775 Dual-Band GSM GPRS/EDGE Modem							
2005 Celltech Labs Inc	This document is not to be reproduced in whole or in part without the written permission of Celltech Labs Inc.						33 of 35

Test Report S/N:	102604KBC-T578-E24G Issue 1.0		
Test Date(s):	28Jan05 - 01Feb05		
Test Type(s):	FCC §2, §22H, §24E	IC RSS-132/133	
Lab Registration(s):	FCC #714830	IC Lab File #3874	

**Results:**

Mode	Source-Based Time-Averaged RF Conducted Output Power	Antenna Gain	Cable Loss	MPE Distance	Power Density at 20 cm	Power Density Limit
	dBm	dBi	dB	cm	mW/cm <sup>2</sup>	mW/cm <sup>2</sup>
<b>Vehicle-Mount Dipole Antenna</b>						
Cellular - GSM	29.05	3.0	1.89	12.26	0.2062	0.57
PCS - GSM	25.81	3.0	2.80	7.78	0.1511	1.0

**E.10 PASS/FAIL**

In reference to the results outlined in E.9 the DUT passes the requirements as stated in the reference standards as follows:  
 1) The DUT must comply with the minimum spacing requirement of 20 cm to ensure an exposure of not more than  $f/1500$  (0.57) mW/cm<sup>2</sup> for frequencies between 300 and 1500 MHz and 1 mW/cm<sup>2</sup> for frequencies between 1500 and 100,000 MHz.

**E.11 SIGN-OFF**

I attest to the accuracy of the data. All measurements reported herein were performed by me and are correct to the best of my knowledge and belief. I assume full responsibility for the completeness of these measurements.



Duane M. Friesen, C.E.T.  
EMC Manager  
Celltech Labs Inc.

1Feb05

Date

Applicant:	Itronix Corporation	Model:	IX100XAC775	FCC ID:	KBCIX100XAC775	IC ID:	1943A-IX100Xe
Rugged Handheld PC with internal Sierra Wireless AirCard 775 Dual-Band GSM GPRS/EDGE Modem							
2005 Celltech Labs Inc	This document is not to be reproduced in whole or in part without the written permission of Celltech Labs Inc.						34 of 35

<b>Test Report S/N:</b>	102604KBC-T578-E24G Issue 1.0		
<b>Test Date(s):</b>	28Jan05 - 01Feb05		
<b>Test Type(s):</b>	FCC §2, §22H, §24E	IC RSS-132/133	
<b>Lab Registration(s):</b>	FCC #714830	IC Lab File #3874	

**END OF DOCUMENT**

<b>Applicant:</b>	<b>Itronix Corporation</b>	<b>Model:</b>	<b>IX100XAC775</b>	<b>FCC ID:</b>	<b>KBCIX100XAC775</b>	<b>IC ID:</b>	<b>1943A-IX100Xe</b>
<b>Rugged Handheld PC with internal Sierra Wireless AirCard 775 Dual-Band GSM GPRS/EDGE Modem</b>							
2005 Celltech Labs Inc	This document is not to be reproduced in whole or in part without the written permission of Celltech Labs Inc.						35 of 35