

## DECLARATION OF COMPLIANCE SAR RF EXPOSURE EVALUATION

### Test Lab

**CELLTECH LABS INC.**  
Testing and Engineering Services  
1955 Moss Court  
Kelowna, B.C.  
Canada V1Y 9L3  
Phone: 250-448-7047  
Fax: 250-448-7046  
e-mail: info@celltechlabs.com  
web site: www.celltechlabs.com

### Applicant Information

**ITRONIX CORPORATION**  
801 South Stevens Street  
Spokane, WA 99204  
USA

<b>Rule Part(s):</b>	FCC 47 CFR §2.1093; IC RSS-102 Issue 1 (Provisional)
<b>Test Procedure(s):</b>	FCC OET Bulletin 65, Supplement C (Edition 01-01)
<b>FCC Device Classification:</b>	PCS Licensed Transmitter (PCB)
<b>IC Device Classification:</b>	2GHz Personal Communication Services
<b>FCC IDENTIFIER:</b>	KBCIX100XA750WLBT
<b>IC Certification No.:</b>	1943A-IX100Xa
<b>Model(s):</b>	IX100XA750WLBT
<b>Device Type:</b>	Rugged Handheld PC with Sierra Wireless AirCard 750 PCS GPRS Modem co-located with USI WM-BB-AG-01 802.11b & Bluetooth X PCS GPRS (AirCard 750), DSSS (802.11b), FHSS (Bluetooth)
<b>Mode(s) of Operation:</b>	
<b>Tx Frequency Range(s):</b>	1850.2 - 1909.8 MHz (PCS GSM/GPRS) 2412 - 2462 MHz (802.11b) 2402 - 2480 MHz (Bluetooth)
<b>Max. RF Output Power Tested:</b>	28.7 dBm Peak Conducted (PCS GPRS) 14.0 dBm Peak Conducted (802.11b) 3.5 dBm Peak Conducted (Bluetooth)
<b>Antenna Type(s) Tested:</b>	External - ¼ Wave Helix (PCS GPRS) Internal - Front Top Center above LCD Display (802.11b) Internal - Front Right Side Center (Bluetooth)
<b>Battery Type(s) Tested:</b>	Lithium-ion 7.4 V, 3.0 Ah (P/N: 46-0136-001)
<b>Body-worn Accessories Tested:</b>	Nylon Carry Case (P/N: 54-0644-001) Ear-Microphone (Model: JABRA)
<b>Max. SAR Level Measured:</b>	1.52 W/kg (1g average)

Celltech Labs Inc. declares under its sole responsibility that this wireless portable device has demonstrated compliance with the Specific Absorption Rate (SAR) RF exposure requirements specified in FCC 47 CFR §2.1093 and Health Canada's Safety Code 6. The device was tested in accordance with the measurement standards and procedures specified in FCC OET Bulletin 65, Supplement C (Edition 01-01), and Industry Canada RSS-102 Issue 1 (Provisional) for the General Population / Uncontrolled Exposure environment. All measurements were performed in accordance with the SAR system manufacturer recommendations.

I attest to the accuracy of data. All measurements were performed by me or were made under my supervision and are correct to the best of my knowledge and belief. I assume full responsibility for the completeness of these measurements and vouch for the qualifications of all persons taking them.

This test report shall not be reproduced partially, or in full, without the prior written approval of Celltech Labs Inc. The results and statements contained in this report pertain only to the device(s) evaluated.



**Russell Pipe**  
Senior Compliance Technologist  
Celltech Labs Inc.



<b>TABLE OF CONTENTS</b>		
<b>1.0</b>	<b>INTRODUCTION.....</b>	<b>3</b>
<b>2.0</b>	<b>DESCRIPTION OF DUT.....</b>	<b>3</b>
<b>3.0</b>	<b>SAR MEASUREMENT SYSTEM.....</b>	<b>4</b>
<b>4.0</b>	<b>MEASUREMENT SUMMARY.....</b>	<b>5</b>
<b>5.0</b>	<b>DETAILS OF SAR EVALUATION.....</b>	<b>6-7</b>
<b>6.0</b>	<b>EVALUATION PROCEDURES.....</b>	<b>8</b>
<b>7.0</b>	<b>SYSTEM PERFORMANCE CHECK.....</b>	<b>9</b>
<b>8.0</b>	<b>SIMULATED EQUIVALENT TISSUES.....</b>	<b>10</b>
<b>9.0</b>	<b>SAR SAFETY LIMITS.....</b>	<b>10</b>
<b>10.0</b>	<b>ROBOT SYSTEM SPECIFICATIONS.....</b>	<b>11</b>
<b>11.0</b>	<b>PROBE SPECIFICATION.....</b>	<b>12</b>
<b>12.0</b>	<b>SAM PHANTOM V4.0C.....</b>	<b>12</b>
<b>13.0</b>	<b>PLANAR PHANTOM.....</b>	<b>12</b>
<b>14.0</b>	<b>DEVICE HOLDER.....</b>	<b>12</b>
<b>15.0</b>	<b>TEST EQUIPMENT LIST.....</b>	<b>13</b>
<b>16.0</b>	<b>MEASUREMENT UNCERTAINTIES.....</b>	<b>14-15</b>
<b>17.0</b>	<b>REFERENCES.....</b>	<b>16</b>
	<b>APPENDIX A - SAR MEASUREMENT DATA.....</b>	<b>17</b>
	<b>APPENDIX B - SYSTEM PERFORMANCE CHECK DATA.....</b>	<b>18</b>
	<b>APPENDIX C - SYSTEM VALIDATION.....</b>	<b>19</b>
	<b>APPENDIX D - PROBE CALIBRATION.....</b>	<b>20</b>
	<b>APPENDIX E - MEASURED FLUID DIELECTRIC PARAMETERS.....</b>	<b>21</b>
	<b>APPENDIX F - SAM PHANTOM CERTIFICATE OF CONFORMITY.....</b>	<b>22</b>
	<b>APPENDIX G - PLANAR PHANTOM CERTIFICATE OF CONFORMITY.....</b>	<b>23</b>
	<b>APPENDIX H - SAR TEST SETUP PHOTOGRAPHS.....</b>	<b>24</b>

## 1.0 INTRODUCTION

This measurement report demonstrates that the ITRONIX CORPORATION Model: IX100XA750WLBT Rugged Handheld PC FCC ID: KBCIX100XA750WLBT with Sierra Wireless AirCard 750 PCS GPRS PCMCIA Modem co-located with USI WM-BB-AG-01 802.11b & Bluetooth Combo Transmitter complies with the SAR (Specific Absorption Rate) RF exposure requirements specified in FCC 47 CFR §2.1093 (see reference [1]), and Health Canada Safety Code 6 (see reference [2]) for the General Population environment. The test procedures described in FCC OET Bulletin 65, Supplement C (Edition 01-01) (see reference [3]) and IC RSS-102 Issue 1 (Provisional) (see reference [4]), were employed. A description of the product, operating configuration, detailed summary of the test results, methodology and procedures used in the evaluation, equipment used, and the various provisions of the rules are included within this test report.

## 2.0 DESCRIPTION OF DEVICE UNDER TEST (DUT)

<b>FCC Rule Part(s)</b>	47 CFR §2.1093		
<b>IC Rule Part(s)</b>	IC RSS-102 Issue 1 (Provisional)		
<b>Test Procedure(s)</b>	FCC OET Bulletin 65, Supplement C (01-01)		
<b>FCC Device Classification</b>	PCS Licensed Transmitter (PCB)		
<b>IC Device Classification</b>	2GHz Personal Communication Services (RSS-133 Issue 2)		
<b>Device Type</b>	Rugged Handheld PC with Sierra Wireless AirCard 750 PCS GPRS PCMCIA Modem co-located with USI WM-BB-AG-01802.11b & Bluetooth Transmitters		
<b>FCC IDENTIFIER</b>	KBCIX100XA750WLBT		
<b>IC Certification No.</b>	1943A-IX100Xa		
<b>Model(s)</b>	IX100XA750WLBT		
<b>Serial No.</b>	510495001-U5103-0025	Identical Prototype	
<b>Mode(s) of Operation</b>	PCS GPRS	GMSK	Gaussian Minimum Shift Keying
	802.11b	DSSS	Direct Sequence Spread Spectrum
	Bluetooth	FHSS	Frequency Hopping Spread Spectrum
<b>Tx Frequency Range(s)</b>	1850.2 - 1909.8 MHz		PCS GSM/GPRS
	2412 - 2462 MHz		802.11b
	2402 - 2480 MHz		Bluetooth
<b>Max. RF Output Power Tested</b>	28.7 dBm	Peak Conducted	PCS GPRS
	14.0 dBm	Peak Conducted	802.11b
	3.5 dBm	Peak Conducted	Bluetooth
<b>Antenna Type(s) Tested</b>	External	¼ Wave Helix	PCS GPRS
	Internal	Front Top Center above LCD Display	802.11b
	Internal	Front Right Side Center	Bluetooth
<b>Battery Type(s) Tested</b>	Internal	7.4V, 3.0 Ah	P/N: 46-0136-001
<b>Body-worn Accessories Tested</b>	Nylon Carry Case		P/N: 54-0644-001
	Ear-Microphone		Model: JABRA

### 3.0 SAR MEASUREMENT SYSTEM

Celltech Labs Inc. SAR measurement facility utilizes the Dosimetric Assessment System (DASY™) manufactured by Schmid & Partner Engineering AG (SPEAG™) of Zurich, Switzerland. The DASY4 measurement system is comprised of the measurement server, robot controller, computer, near-field probe, probe alignment sensor, specific anthropomorphic mannequin (SAM) phantom, and various planar phantoms for brain and/or body SAR evaluations. The robot is a six-axis industrial robot performing precise movements to position the probe to the location (points) of maximum electromagnetic field (EMF). A cell controller system contains the power supply, robot controller, teach pendant (Joystick), and remote control, is used to drive the robot motors. The Staubli robot is connected to the cell controller to allow software manipulation of the robot. A data acquisition electronic (DAE) circuit performs the signal amplification, signal multiplexing, AD-conversion, offset measurements, mechanical surface detection, collision detection, etc. is connected to the Electro-optical coupler (EOC). The EOC performs the conversion from the optical into digital electric signal of the DAE and transfers data to the DASY4 measurement server. The DAE4 utilizes a highly sensitive electrometer-grade preamplifier with auto-zeroing, a channel and gain-switching multiplexer, a fast 16-bit AD-converter and a command decoder and control logic unit. Transmission to the DASY4 measurement server is accomplished through an optical downlink for data and status information and an optical uplink for commands and clock lines. The mechanical probe-mounting device includes two different sensor systems for frontal and sidewise probe contacts. The sensor systems are also used for mechanical surface detection and probe collision detection. The robot uses its own controller with a built in VME-bus computer.



**DASY4 SAR Measurement System with planar phantom**



**DASY4 SAR Measurement System with SAM phantom**

## 4.0 MEASUREMENT SUMMARY

BODY-WORN SAR MEASUREMENT RESULTS													
Test Date	Tx Type	Test Mode	Freq. (MHz)	Chan.	Cond. Power Before Test (dBm)	Antenna Type	Body-Worn Accessories	DUT Position Relative to Front of Carry Case	DUT Position Relative to Planar Phantom	Separation Distance to Planar Phantom (cm)	SAR Drift During Test (dB)	Measured SAR 1g (W/kg)	
Mar-4	GPRS	GPRS	1880.0	661	28.6	External	--	--	Back Side facing Phantom	0.0	-0.0202	P	0.508
												S	0.453
Mar-4	GPRS	GPRS	1880.0	661	28.6	External	--	--	Right Side Facing Phantom	0.5	-0.00779	1.46	
Mar-4	GPRS	GPRS	1850.2	512	28.7	External	--	--	Right Side Facing Phantom	0.5	0.00168	1.52	
Mar-4	GPRS	GPRS	1909.8	810	28.6	External	--	--	Right Side Facing Phantom	0.5	0.000107	1.30	
Mar-5	GPRS	GPRS	1880.0	661	28.6	External	Carry Case Ear-Mic	Front Side facing Front of Case	Front Side facing Phantom	0.0	0.00205	0.530	
Mar-5	GPRS	GPRS	1880.0	661	28.6	External	Carry Case Ear-Mic	Back Side facing Front of Case	Back Side facing Phantom	0.0	-0.0647	P	0.388
												S	0.357
Mar-5	GPRS	GPRS	1880.0	661	28.6	External	Carry Case Ear-Mic	Front Side facing Front of Case	Right Side Facing Phantom	0.0	-0.02	1.37	
Mar-5	GPRS	GPRS	1850.2	512	28.7	External	Carry Case Ear-Mic	Front Side facing Front of Case	Right Side Facing Phantom	0.0	-0.08	1.48	
Mar-5	GPRS	GPRS	1909.8	810	28.6	External	Carry Case Ear-Mic	Front Side facing Front of Case	Right Side Facing Phantom	0.0	-0.01	1.18	
Mar-5	GPRS	GPRS	1880.0	661	28.6	External	Carry Case Ear-Mic	Back Side facing Front of Case	Right Side Facing Phantom	0.0	0.02	1.30	
Mar-5	GPRS	GPRS	1850.2	512	28.7	External	Carry Case Ear-Mic	Back Side facing Front of Case	Right Side Facing Phantom	0.0	0.01	1.48	
Mar-5	GPRS	GPRS	1909.8	810	28.6	External	Carry Case Ear-Mic	Back Side facing Front of Case	Right Side Facing Phantom	0.0	0.00	1.07	
Mar-5	GPRS	GPRS	1850.2	512	28.7	External	--	--	Right Side Facing Phantom	0.5	-0.04	1.48	
	802.11b	DSSS	2437	Mid	14.0	Internal							
Mar-5	GPRS	GPRS	1850.2	512	28.7	External	--	--	Right Side Facing Phantom	0.5	-0.01	1.44	
	802.11b	DSSS	2437	Mid	14.0	Internal							
	BT	Modulated	2441	Mid	3.5	Internal							

**ANSI / IEEE C95.1 1999 - SAFETY LIMIT**  
**BODY: 1.6 W/kg (averaged over 1 gram)**  
**Spatial Peak - Uncontrolled Exposure / General Population**

Measured Mixture Type	1880 MHz Body				Test Date(s)		Mar. 4	Mar. 5	Unit
<b>Dielectric Constant</b> $\epsilon_r$	<b>IEEE Target</b>		<b>Measured</b>		<b>Relative Humidity</b>		32	31	%
	<b>53.3</b>	<b>±5%</b>	<b>Mar. 4</b>	51.4	<b>Atmospheric Pressure</b>		102.1	101.5	kPa
			<b>Mar. 5</b>	52.2	<b>Ambient Temperature</b>		24.1	23.4	°C
<b>Conductivity</b> $\sigma$ (mho/m)	<b>IEEE Target</b>		<b>Measured</b>		<b>Fluid Temperature</b>		21.8	21.7	°C
	<b>1.52</b>	<b>±5%</b>	<b>Mar. 4</b>	1.54	<b>Fluid Depth</b>		≥ 15	≥ 15	cm
			<b>Mar. 5</b>	1.59	<b><math>\rho</math> (Kg/m<sup>3</sup>)</b>		1000		



## 5.0 DETAILS OF SAR EVALUATION

The ITRONIX CORPORATION Model: IX100XA750WLBT FCC ID: KBCIX100XA750WLBT Rugged Handheld PC with Sierra Wireless AirCard 750 PCS GSM/GPRS PCMCIA Modem Card co-located with USI WM-BB-AG-01 802.11b & Bluetooth Combo Transmitter was compliant for localized Specific Absorption Rate (Uncontrolled Exposure) based on the test provisions and conditions described below. The detailed test setup photographs are shown in Appendix H.

### Body SAR Configuration

1. The DUT was tested for body SAR (lap-held) with the back side (battery side) facing parallel to, and touching, the outer surface of the planar phantom.
2. The DUT was tested for body SAR (lap-held) with the right side (antenna side) facing parallel to the outer surface of the planar phantom with a 0.5 cm air-gap separation distance between the right side of the DUT and the planar phantom.
3. The DUT was tested for body SAR with the shoulder-worn nylon carry case and ear-microphone accessories. The front side of the DUT (keypad/LCD side) was placed parallel to the outer surface of the planar phantom with the front side of the DUT facing the front of the carry case. The front of the carry case was touching the outer surface of the planar phantom.
4. The DUT was tested for body SAR with the shoulder-worn nylon carry case and ear-microphone accessories. The back side of the DUT (battery side) was placed parallel to the outer surface of the planar phantom with the back side of the DUT facing the front of the carry case. The front of the carry case was touching the outer surface of the planar phantom.
5. The DUT was tested for body SAR with the shoulder-worn nylon carry case and ear-microphone accessories. The right side of the DUT (antenna side) was placed parallel to the outer surface of the planar phantom with the front side of the DUT facing the front of the carry case. The right side of the carry case was touching the outer surface of the planar phantom.
6. The DUT was tested for body SAR with the shoulder-worn nylon carry case and ear-microphone accessories. The right side of the DUT (antenna side) was placed parallel to the outer surface of the planar phantom with the back side of the DUT facing the front of the carry case. The left side of the carry case was touching the outer surface of the planar phantom.
7. With the DUT placed in the nylon carry case the thickness of the carry case provided a 0.5 cm separation distance from the DUT to the outer surface of the planar phantom.
8. If the measured SAR levels at the mid channel were  $\geq 3$  dB below the SAR limit, SAR evaluation for the low and high channels was optional (per FCC OET Bulletin 65, Supplement C, Edition 01-01 - see reference [3]).
9. Secondary peak SAR levels were reported within 2 dB of the maximum as shown in the test data table on page 5 (P = Primary, S = Secondary).
10. Co-located simultaneous transmit tests were performed with both GPRS and 802.11b transmitters for the worst-case single-transmit GPRS configuration.
11. Co-located simultaneous transmit tests were performed with GPRS, 802.11b, and Bluetooth transmitters for the worst-case single-transmit GPRS configuration.
12. Due to the dimensions of the DUT, a stack of low-density, low-loss dielectric foamed polystyrene was used in place of the device holder.
13. The ambient and fluid temperatures were measured prior to, and during, the fluid dielectric parameter check and the SAR evaluation. The temperatures listed in the test data table (page 5) were consistent for all measurement periods.
14. The dielectric parameters of the simulated tissue mixture were measured prior to the SAR evaluation using an HP 85070C Dielectric Probe Kit and an HP 8753E Network Analyzer (see Appendix E for printout of measured fluid dielectric parameters).
15. The SAR evaluations were performed within 24 hours of the system performance check.

### DUT Test Modes & Power Settings

16. The DUT was controlled in test mode via internal software. PCS GPRS SAR measurements were performed with the DUT transmitting continuously at maximum power on 4 time slots in GPRS mode (Crest factor: 2). This is the maximum output condition since the DUT is a Class 12 multi-slot GSM/GPRS modem. For the co-located simultaneous transmit tests the 802.11b was placed in continuous transmit operation at maximum power with a modulated DSSS signal. The Bluetooth transmitter was placed in continuous transmit operation at maximum power with the frequency hopping disabled and a modulated signal.
17. The peak conducted power levels were measured at the card before each test using a Gigatronics 8652A Universal Power Meter according to the procedures described in FCC 47 CFR §2.1046.
18. The power drifts were measured by the DASY4 system for the duration of the SAR evaluations.
19. The DUT was tested with a fully charged battery for each test.

**DETAILS OF SAR EVALUATION (Cont.)**



**Back Side of DUT facing body - worst-case antenna configuration in relation to left arm**



**Front Side of DUT facing body - worst-case antenna configuration in relation to right arm**

## 6.0 EVALUATION PROCEDURES

- a. (i) The evaluation was performed in the applicable area of the phantom depending on the type of device being tested. For devices held to the ear during normal operation, both the left and right ear positions were evaluated using the SAM phantom.  
(ii) For body-worn and face-held devices a planar phantom was used.
- b. The SAR was determined by a pre-defined procedure within the DASY4 software. Upon completion of a reference and optical surface check, the exposed region of the phantom was scanned near the inner surface with a grid spacing of 15mm x 15mm.

An area scan was determined as follows:

- c. Based on the defined area scan grid, a more detailed grid is created to increase the points by a factor of 10. The interpolation function then evaluates all field values between corresponding measurement points.
- d. A linear search is applied to find all the candidate maxima. Subsequently, all maxima are removed that are >2 dB from the global maximum. The remaining maxima are then used to position the cube scans.

A 1g and 10g spatial peak SAR was determined as follows:

- e. Extrapolation is used to find the points between the dipole center of the probe and the surface of the phantom. This data cannot be measured, since the center of the dipoles is 2.7 mm away from the tip of the probe and the distance between the surface and the lowest measuring point is 1.4 mm (see probe calibration document in Appendix D). The extrapolation was based on trivariate quadratics computed from the previously calculated 3D interpolated points nearest the phantom surface.
- f. Interpolated data is used to calculate the average SAR over 1g and 10g cubes by spatially discretizing the entire measured cube. The volume used to determine the averaged SAR is a 1mm grid (42875 interpolated points).
- g. A zoom scan volume of 32 mm x 32 mm x 30 mm (5 x 5 x 7 points) centered at the peak SAR location determined from the area scan is used for all zoom scans for devices with a transmit frequency < 800 MHz. Zoom scans for frequencies  $\geq$  800 MHz are determined with a scan volume of 30 mm x 30 mm x 30 mm (7 x 7 x 7) to ensure complete capture of the peak spatial-average SAR.



## 7.0 SYSTEM PERFORMANCE CHECK

Prior to the SAR evaluation a system check was performed at the planar section of the SAM phantom with an 1800MHz dipole (see Appendix C for system validation procedures). The dielectric parameters of the simulated brain tissue mixture were measured prior to the system performance check using an HP 85070C Dielectric Probe Kit and an HP 8753E Network Analyzer (see Appendix E for printout of measured fluid dielectric parameters). A forward power of 250mW was applied to the dipole and the system was verified to a tolerance of  $\pm 10\%$  (see Appendix B for system performance check test plot).

SYSTEM PERFORMANCE CHECK													
Test Date	Equiv. Tissue	SAR 1g (W/kg)		Dielectric Constant $\epsilon_r$		Conductivity $\sigma$ (mho/m)		$\rho$ (Kg/m <sup>3</sup> )	Amb. Temp. (°C)	Fluid Temp. (°C)	Fluid Depth (cm)	Humid. (%)	Barom. Press. (kPa)
		IEEE Target	Measured	IEEE Target	Measured	IEEE Target	Measured						
03/04/04	Brain	<b>9.53 (<math>\pm 10\%</math>)</b>	9.40 (-1.4%)	<b>40.0 <math>\pm 5\%</math></b>	40.0	<b>1.40 <math>\pm 5\%</math></b>	1.38	1000	23.2	21.6	$\geq 15$	35	101.9

**Note(s):**

1. The ambient and fluid temperatures were measured prior to, and during, the fluid dielectric parameter check and the system performance check. The temperatures listed in the table above were consistent for all measurement periods.

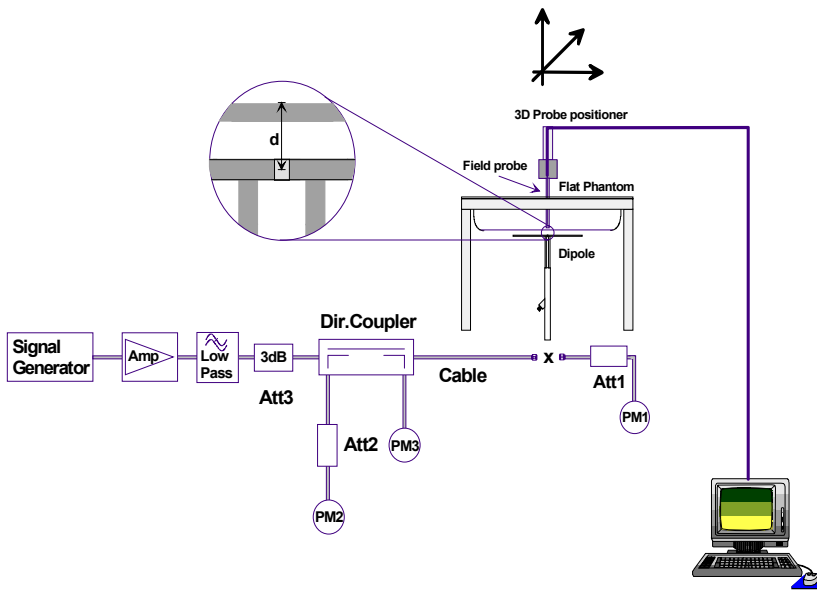

**Figure 1. System Performance Check Setup Diagram**

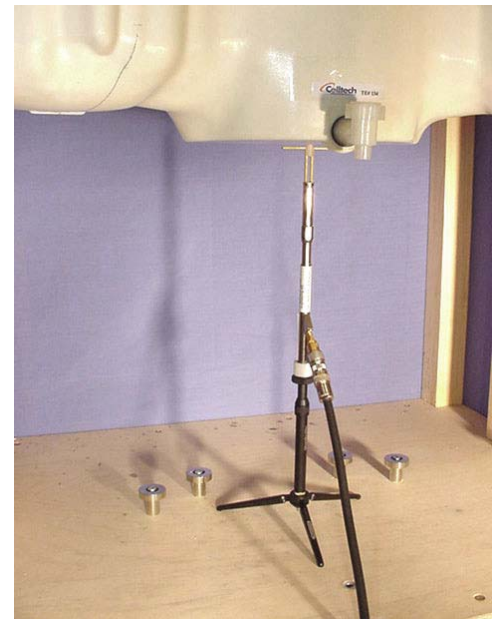

**1800MHz Dipole Setup**

## 8.0 SIMULATED EQUIVALENT TISSUES

The 1800MHz and 1880MHz simulated tissue mixtures consist of Glycol-monobutyl, water, and salt. The fluids were prepared according to standardized procedures and measured for dielectric parameters (permittivity and conductivity).

SIMULATED TISSUE MIXTURES		
INGREDIENT	1800 MHz Brain	1880 MHz Body
	System Performance Check	DUT Evaluation
Water	54.83 %	69.85 %
Glycol Monobutyl	44.86 %	29.89 %
Salt	0.31 %	0.26 %

## 9.0 SAR SAFETY LIMITS

EXPOSURE LIMITS	SAR (W/kg)	
	(General Population / Uncontrolled Exposure Environment)	(Occupational / Controlled Exposure Environment)
Spatial Average (averaged over the whole body)	0.08	0.4
Spatial Peak (averaged over any 1 g of tissue)	1.60	8.0
Spatial Peak (hands/wrists/feet/ankles averaged over 10 g)	4.0	20.0

Notes:

1. Uncontrolled environments are defined as locations where there is potential exposure of individuals who have no knowledge or control of their potential exposure.
2. Controlled environments are defined as locations where there is potential exposure of individuals who have knowledge of their potential exposure and can exercise control over their exposure.

## 10.0 ROBOT SYSTEM SPECIFICATIONS

### Specifications

**POSITIONER:** Stäubli Unimation Corp. Robot Model: RX60L  
**Repeatability:** 0.02 mm  
**No. of axis:** 6

### Data Acquisition Electronic (DAE) System

#### Cell Controller

**Processor:** AMD Athlon XP 2400+  
**Clock Speed:** 2.0 GHz  
**Operating System:** Windows XP Professional

#### Data Converter

**Features:** Signal Amplifier, multiplexer, A/D converter, and control logic  
**Software:** DASY4 software  
**Connecting Lines:** Optical downlink for data and status info.  
 Optical uplink for commands and clock

### DASY4 Measurement Server

**Function:** Real-time data evaluation for field measurements and surface detection  
**Hardware:** PC/104 166MHz Pentium CPU; 32 MB chipdisk; 64 MB RAM  
**Connections:** COM1, COM2, DAE, Robot, Ethernet, Service Interface

### E-Field Probe

**Model:** ET3DV6  
**Serial No.:** 1590  
**Construction:** Triangular core fiber optic detection system  
**Frequency:** 10 MHz to 6 GHz  
**Linearity:**  $\pm 0.2$  dB (30 MHz to 3 GHz)

### Phantom(s)

#### Evaluation Phantom

**Type:** Planar Phantom  
**Shell Material:** Fiberglass  
**Thickness:**  $2.0 \pm 0.1$  mm  
**Volume:** Approx. 72 liters

#### Validation Phantom

**Type:** SAM V4.0C  
**Shell Material:** Fiberglass  
**Thickness:**  $2.0 \pm 0.1$  mm  
**Volume:** Approx. 20 liters

## 11.0 PROBE SPECIFICATION (ET3DV6)

Construction:	Symmetrical design with triangular core Built-in shielding against static charges PEEK enclosure material (resistant to organic solvents, e.g. glycol)
Calibration:	In air from 10 MHz to 2.5 GHz In brain simulating tissue at frequencies of 900 MHz and 1.8 GHz (accuracy $\pm 8\%$ )
Frequency:	10 MHz to <6 GHz; Linearity: $\pm 0.2$ dB (30 MHz to 3 GHz)
Directivity:	$\pm 0.2$ dB in brain tissue (rotation around probe axis) $\pm 0.4$ dB in brain tissue (rotation normal to probe axis)
Dynamic Range:	5 $\mu$ W/g to <100 mW/g; Linearity: $\pm 0.2$ dB
Surface. Detection:	$\pm 0.2$ mm repeatability in air and clear liquids over diffuse reflecting surfaces
Dimensions:	Overall length: 330 mm Tip length: 16 mm Body diameter: 12 mm Tip diameter: 6.8 mm Distance from probe tip to dipole centers: 2.7 mm
Application:	General dosimetry up to 3 GHz Compliance tests of mobile phone



ET3DV6 E-Field Probe

## 12.0 SAM PHANTOM V4.0C

The SAM phantom V4.0C is a fiberglass shell phantom with a 2.0 mm (+/-0.2 mm) shell thickness for left and right head and flat planar area integrated in the wooden table of the DASY4 compact system. The shape of the fiberglass shell corresponds to the phantom defined by SCC34-SC2. The device holder positions are adjusted to the standard measurement positions in the three sections (see Appendix F for specifications of the SAM phantom V4.0C).

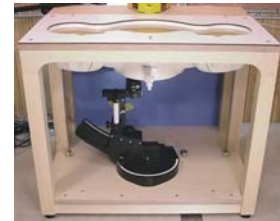

SAM Phantom

## 13.0 PLANAR PHANTOM

The planar phantom is a fiberglass shell phantom with a 2.0 mm (+/-0.2mm) thick device measurement area at the center of the phantom for SAR evaluations of devices with a larger surface area than the planar section of the SAM phantom. The planar phantom is integrated in the wooden table of the DASY4 compact system (see Appendix G for dimensions and specifications of the planar phantom).



Planar Phantom

## 14.0 DEVICE HOLDER

The DASY4 device holder has two scales for device rotation (with respect to the body axis) and the device inclination (with respect to the line between the ear openings). The plane between the ear openings and the mouth tip has a rotation angle of 65°. The bottom plate contains three pair of bolts for locking the device holder. The device holder positions are adjusted to the standard measurement positions in the three sections.



Device Holder

## 15.0 TEST EQUIPMENT LIST

TEST EQUIPMENT	SERIAL NO.	CALIBRATION DATE
Schmid & Partner DASY4 System	-	-
DASY4 Measurement Server	1078	N/A
-Robot	599396-01	N/A
DAE3	353	Dec 2003
DAE3	370	May 2003
-ET3DV6 E-Field Probe	1387	Mar 2004
-ET3DV6 E-Field Probe	1590	May 2003
-300MHz Validation Dipole	135	Oct 2003
-450MHz Validation Dipole	136	Nov 2003
-835MHz Validation Dipole	411	Mar 2004
-900MHz Validation Dipole	054	June 2003
-1800MHz Validation Dipole	247	June 2003
-2450MHz Validation Dipole	150	Sept 2003
-SAM Phantom V4.0C	1033	N/A
-Barski Planar Phantom	03-01	N/A
-Plexiglas Planar Phantom	161	N/A
-Validation Planar Phantom	137	N/A
HP 85070C Dielectric Probe Kit	N/A	N/A
Gigatronics 8651A Power Meter	8650137	April 2003
Gigatronics 8652A Power Meter	1835267	April 2003
Gigatronics 80701A Power Sensor	1833535	April 2003
Gigatronics 80701A Power Sensor	1833542	April 2003
Gigatronics 80701A Power Sensor	1834350	April 2003
HP E4408B Spectrum Analyzer	US39240170	Dec 2003
HP 8594E Spectrum Analyzer	3543A02721	April 2003
HP 8753E Network Analyzer	US38433013	April 2003
HP 8648D Signal Generator	3847A00611	April 2003
Amplifier Research 5S1G4 Power Amplifier	26235	N/A



## 16.0 MEASUREMENT UNCERTAINTIES

Error Description	Uncertainty Value ±%	Probability Distribution	Divisor	C <sub>i</sub> 1g	Standard Uncertainty ±% (1g)	v <sub>i</sub> OR v <sub>eff</sub>
<b>Measurement System</b>						
Probe calibration	± 4.8	Normal	1	1	± 4.8	∞
Axial isotropy of the probe	± 4.7	Rectangular	√3	(1-c <sub>p</sub> )	± 1.9	∞
Spherical isotropy of the probe	± 9.6	Rectangular	√3	(c <sub>p</sub> )	± 3.9	∞
Spatial resolution	± 0.0	Rectangular	√3	1	± 0.0	∞
Boundary effects	± 5.5	Rectangular	√3	1	± 3.2	∞
Probe linearity	± 4.7	Rectangular	√3	1	± 2.7	∞
Detection limit	± 1.0	Rectangular	√3	1	± 0.6	∞
Readout electronics	± 1.0	Normal	1	1	± 1.0	∞
Response time	± 0.8	Rectangular	√3	1	± 0.5	∞
Integration time	± 1.4	Rectangular	√3	1	± 0.8	∞
RF ambient conditions	± 3.0	Rectangular	√3	1	± 1.7	∞
Mech. constraints of robot	± 0.4	Rectangular	√3	1	± 0.2	∞
Probe positioning	± 2.9	Rectangular	√3	1	± 1.7	∞
Extrapolation & integration	± 3.9	Rectangular	√3	1	± 2.3	∞
<b>Test Sample Related</b>						
Device positioning	± 6.0	Normal	√3	1	± 6.7	12
Device holder uncertainty	± 5.0	Normal	√3	1	± 5.9	8
Power drift	± 5.0	Rectangular	√3		± 2.9	∞
<b>Phantom and Setup</b>						
Phantom uncertainty	± 4.0	Rectangular	√3	1	± 2.3	∞
Liquid conductivity (target)	± 5.0	Rectangular	√3	0.6	± 1.7	∞
Liquid conductivity (measured)	± 5.0	Rectangular	√3	0.6	± 1.7	∞
Liquid permittivity (target)	± 5.0	Rectangular	√3	0.6	± 1.7	∞
Liquid permittivity (measured)	± 5.0	Rectangular	√3	0.6	± 1.7	∞
<b>Combined Standard Uncertainty</b>					<b>± 13.3</b>	
<b>Expanded Uncertainty (k=2)</b>					<b>± 26.6</b>	

Measurement Uncertainty Table in accordance with IEEE Std. 1528-2003 (see reference [5])

## MEASUREMENT UNCERTAINTIES (Cont.)

UNCERTAINTY BUDGET FOR SYSTEM VALIDATION						
Error Description	Uncertainty Value ±%	Probability Distribution	Divisor	C <sub>i</sub> 1g	Standard Uncertainty ±% (1g)	v <sub>i</sub> or v <sub>eff</sub>
<b>Measurement System</b>						
Probe calibration	± 4.8	Normal	1	1	± 4.8	∞
Axial isotropy of the probe	± 4.7	Rectangular	√3	(1-c <sub>p</sub> )	± 1.9	∞
Spherical isotropy of the probe	± 9.6	Rectangular	√3	(c <sub>p</sub> )	± 3.9	∞
Spatial resolution	± 0.0	Rectangular	√3	1	± 0.0	∞
Boundary effects	± 5.5	Rectangular	√3	1	± 3.2	∞
Probe linearity	± 4.7	Rectangular	√3	1	± 2.7	∞
Detection limit	± 1.0	Rectangular	√3	1	± 0.6	∞
Readout electronics	± 1.0	Normal	1	1	± 1.0	∞
Response time	± 0.8	Rectangular	√3	1	± 0.5	∞
Integration time	± 1.4	Rectangular	√3	1	± 0.8	∞
RF ambient conditions	± 3.0	Rectangular	√3	1	± 1.7	∞
Mech. constraints of robot	± 0.4	Rectangular	√3	1	± 0.2	∞
Probe positioning	± 2.9	Rectangular	√3	1	± 1.7	∞
Extrapolation & integration	± 3.9	Rectangular	√3	1	± 2.3	∞
<b>Dipole</b>						
Dipole Axis to Liquid Distance	± 2.0	Rectangular	√3	1	± 1.2	∞
Input Power	± 4.7	Rectangular	√3	1	± 2.7	∞
<b>Phantom and Setup</b>						
Phantom uncertainty	± 4.0	Rectangular	√3	1	± 2.3	∞
Liquid conductivity (target)	± 5.0	Rectangular	√3	0.6	± 1.7	∞
Liquid conductivity (measured)	± 5.0	Rectangular	√3	0.6	± 1.7	∞
Liquid permittivity (target)	± 5.0	Rectangular	√3	0.6	± 1.7	∞
Liquid permittivity (measured)	± 5.0	Rectangular	√3	0.6	± 1.7	∞
<b>Combined Standard Uncertainty</b>					<b>± 9.9</b>	
<b>Expanded Uncertainty (k=2)</b>					<b>± 19.8</b>	

Measurement Uncertainty Table in accordance with IEEE Std. 1528-2003 (see reference [5])

Test Report S/N:	021104-469KBC
Test Date(s):	March 04-05, 2004
Test Type:	FCC/IC SAR Evaluation

## 17.0 REFERENCES

- [1] Federal Communications Commission, "Radiofrequency radiation exposure evaluation: portable devices", Rule Part 47 CFR §2.1093: 1999.
- [2] Health Canada, "Limits of Human Exposure to Radiofrequency Electromagnetic Fields in the Frequency Range from 3 kHz to 300 GHz", Safety Code 6.
- [3] Federal Communications Commission, "Evaluating Compliance with FCC Guidelines for Human Exposure to Radio frequency Electromagnetic Fields", OET Bulletin 65, Supplement C (Edition 01-01), FCC, Washington, D.C.: June 2001.
- [4] Industry Canada, "Evaluation Procedure for Mobile and Portable Radio Transmitters with respect to Health Canada's Safety Code 6 for Exposure of Humans to Radio Frequency Fields", Radio Standards Specification RSS-102 Issue 1 (Provisional): September 1999.
- [5] IEEE Standard 1528-2003, "Recommended Practice for Determining the Peak Spatial-Average Specific Absorption Rate (SAR) in the Human Head from Wireless Communications Devices: Measurement Techniques".

Test Report S/N:	021104-469KBC
Test Date(s):	March 04-05, 2004
Test Type:	FCC/IC SAR Evaluation

## APPENDIX B - SYSTEM PERFORMANCE CHECK DATA

## System Performance Check - 1800 MHz Dipole

Date Tested: 03/04/04

DUT: Dipole 1800 MHz; Model: D1800V2; Type: System Performance Check; Serial: 247

Ambient Temp: 23.2 °C; Fluid Temp: 21.6 °C; Barometric Pressure: 101.9 kPa; Humidity: 35%

Communication System: CW

Forward Conducted Power: 250mW

Frequency: 1800 MHz; Duty Cycle: 1:1

Medium: HSL1800 ( $\sigma = 1.38 \text{ mho/m}$ ;  $\epsilon_r = 40$ ;  $\rho = 1000 \text{ kg/m}^3$ )

- Probe: ET3DV6 - SN1590; ConvF(5.5, 5.5, 5.5); Calibrated: 15/05/2003
- Sensor-Surface: 4mm (Mechanical And Optical Surface Detection)
- Electronics: DAE3 Sn353; Calibrated: 19/12/2003
- Phantom: SAM 4.0; Type: Fiberglass; Serial: 1033
- Measurement SW: DASy4, V4.2 Build 12; Postprocessing SW: SEMCAD, V1.8 Build 94

### 1800 MHz System Performance Check/Area Scan (5x8x1):

Measurement grid: dx=15mm, dy=15mm

### 1800 MHz System Performance Check/Zoom Scan (7x7x7)/Cube 0:

Measurement grid: dx=5mm, dy=5mm, dz=5mm

Peak SAR (extrapolated) = 16.3 W/kg

**SAR(1 g) = 9.40 mW/g; SAR(10 g) = 5.03 mW/g**

Reference Value = 92 V/m

Power Drift = -0.0 dB

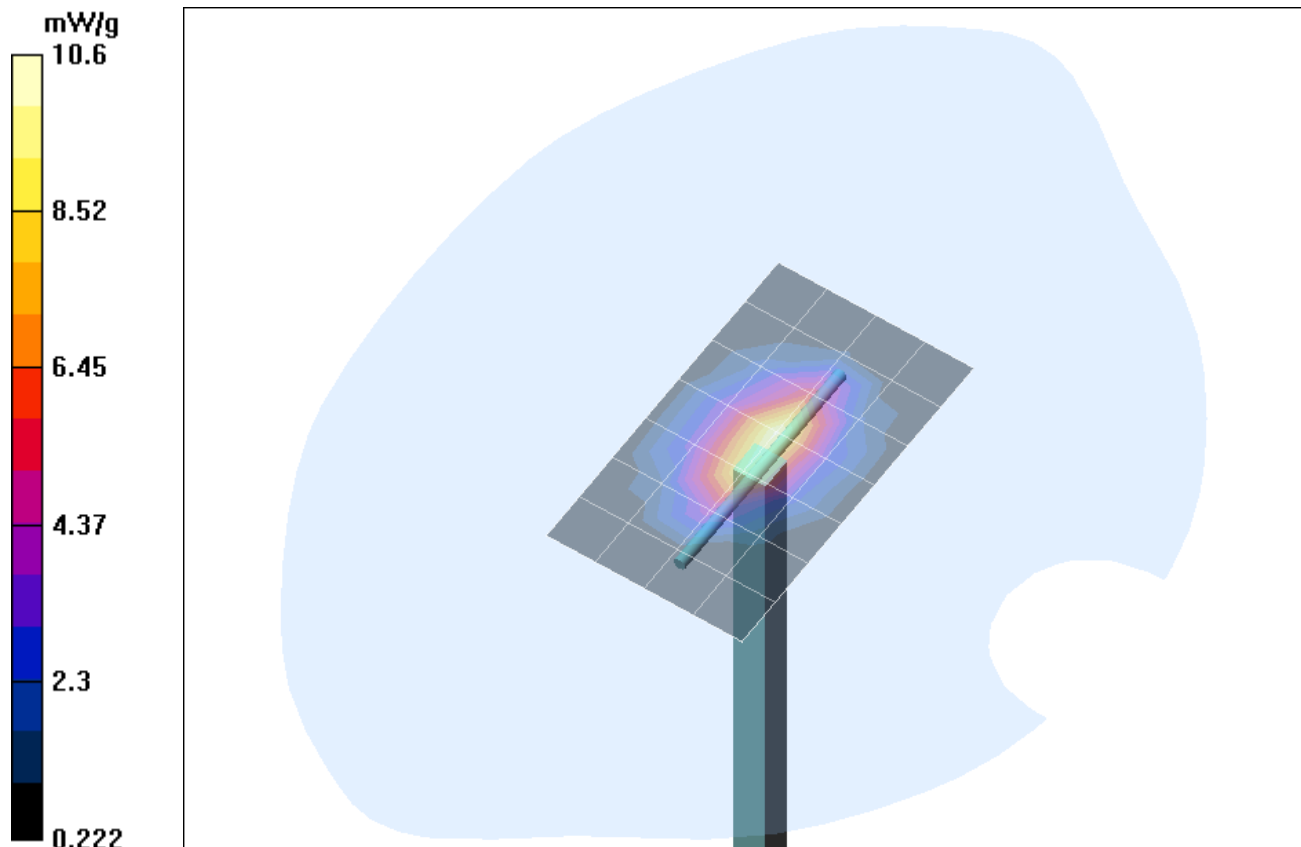



### Z-Axis Scan

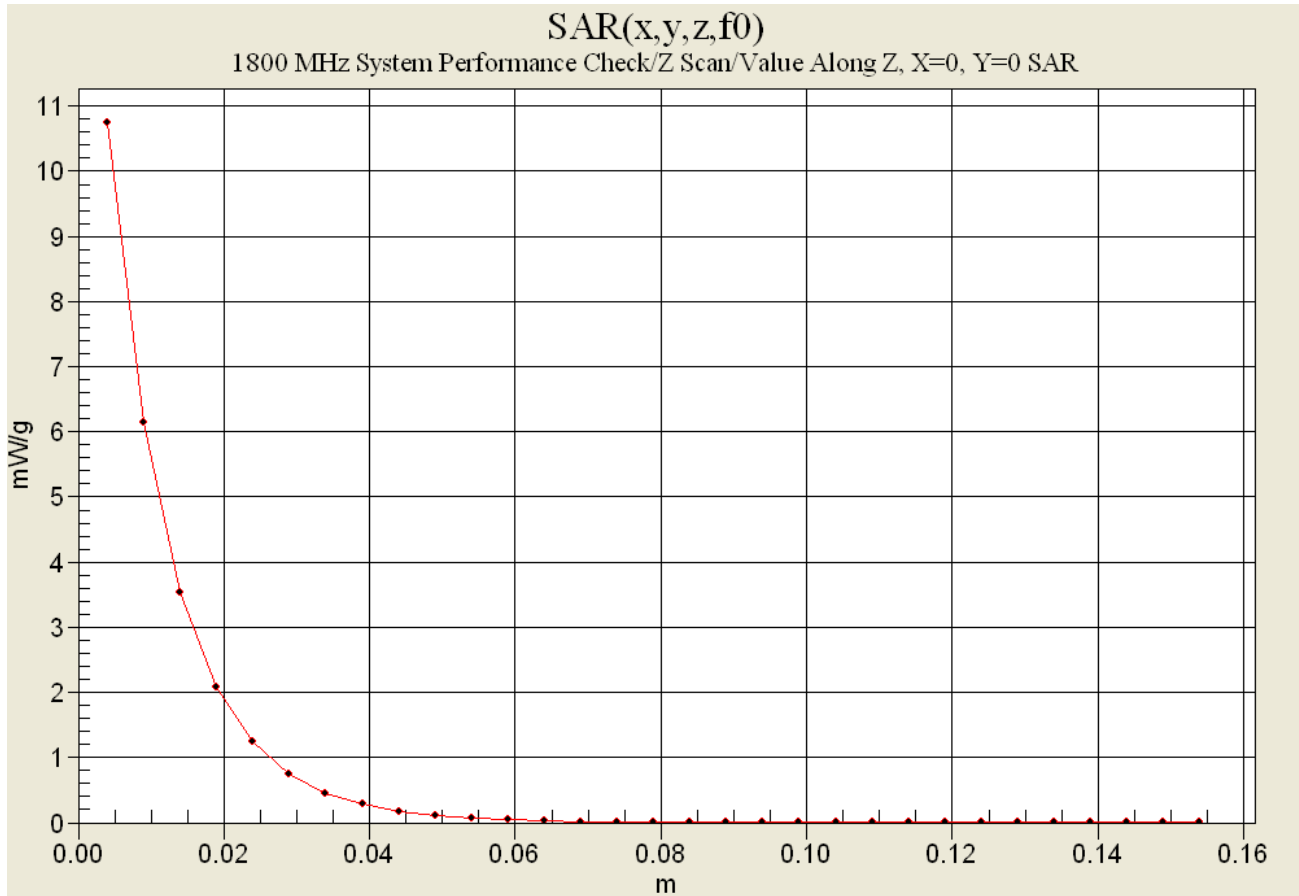

Test Report S/N:	021104-469KBC
Test Date(s):	March 04-05, 2004
Test Type:	FCC/IC SAR Evaluation

## APPENDIX C - SYSTEM VALIDATION

**Client**      **Celltech Labs**

**CALIBRATION CERTIFICATE**

**Object(s)**      **D1800V2 - SN.247**

**Calibration procedure(s)**      **QA CAL-05.v2**  
**Calibration procedure for dipole validation kits**

**Calibration date:**      **June 4, 2003**

**Condition of the calibrated item**      **In Tolerance (according to the specific calibration document)**

This calibration statement documents traceability of M&TE used in the calibration procedures and conformity of the procedures with the ISO/IEC 17025 international standard.

All calibrations have been conducted in the closed laboratory facility: environment temperature 22 +/- 2 degrees Celsius and humidity < 75%.

**Calibration Equipment used (M&TE critical for calibration)**

Model Type	ID #	Cal Date (Calibrated by, Certificate No.)	Scheduled Calibration
RF generator R&S SML-03	100698	27-Mar-2002 (R&S, No. 20-92389)	In house check: Mar-05
Power sensor HP 8481A	MY41092317	18-Oct-02 (Agilent, No. 20021018)	Oct-04
Power sensor HP 8481A	US37292783	30-Oct-02 (METAS, No. 252-0236)	Oct-03
Power meter EPM E442	GB37480704	30-Oct-02 (METAS, No. 252-0236)	Oct-03
Network Analyzer HP 8753E	US37390585	18-Oct-01 (Agilent, No. 24BR1033101)	In house check: Oct 03

	Name	Function	Signature
Calibrated by:	Judith Mueller	Technician	<i>J. F. Basoldt</i>

Approved by:	Katja Pokovic	Laboratory Director	<i>Katja Pokovic</i>
--------------	---------------	---------------------	----------------------

Date issued: June 4, 2003

This calibration certificate is issued as an intermediate solution until the accreditation process (based on ISO/IEC 17025 International Standard) for Calibration Laboratory of Schmid & Partner Engineering AG is completed.

# DASY

## Dipole Validation Kit

Type: D1800V2

Serial: 247

Manufactured: August 25, 1999

Calibrated: June 4, 2003

## 1. Measurement Conditions

The measurements were performed in the flat section of the SAM twin phantom filled with **head simulating solution** of the following electrical parameters at 1800 MHz:

Relative Dielectricity	<b>39.2</b>	$\pm 5\%$
Conductivity	<b>1.36 mho/m</b>	$\pm 5\%$

The DASY4 System with a dosimetric E-field probe ET3DV6 (SN:1507, Conversion factor 5.3 at 1800 MHz) was used for the measurements.

The dipole was mounted on the small tripod so that the dipole feedpoint was positioned below the center marking of the flat phantom section and the dipole was oriented parallel to the body axis (the long side of the phantom). The standard measuring distance was 10mm from dipole center to the solution surface. The included distance spacer was used during measurements for accurate distance positioning.

The coarse grid with a grid spacing of 15mm was aligned with the dipole. The 7x7x7 fine cube was chosen for cube integration.

The dipole input power (forward power) was  $250\text{mW} \pm 3\%$ . The results are normalized to 1W input power.

## 2. SAR Measurement with DASY4 System

Standard SAR-measurements were performed according to the measurement conditions described in section 1. The results (see figure supplied) have been normalized to a dipole input power of 1W (forward power). The resulting averaged SAR-values measured with the dosimetric probe ET3DV6 SN:1507 and applying the advanced extrapolation are:

averaged over $1\text{ cm}^3$ (1 g) of tissue:	<b>39.6 mW/g</b> $\pm 16.8\%$ (k=2) <sup>1</sup>
averaged over $10\text{ cm}^3$ (10 g) of tissue:	<b>20.9 mW/g</b> $\pm 16.2\%$ (k=2) <sup>1</sup>

---

<sup>1</sup> validation uncertainty



### 3. Dipole Impedance and Return Loss

The impedance was measured at the SMA-connector with a network analyzer and numerically transformed to the dipole feedpoint. The transformation parameters from the SMA-connector to the dipole feedpoint are:

Electrical delay:           **1.190 ns**   (one direction)  
Transmission factor:       **0.998**       (voltage transmission, one direction)

The dipole was positioned at the flat phantom sections according to section 1 and the distance spacer was in place during impedance measurements.

Feedpoint impedance at 1800 MHz:            $\text{Re}\{Z\} = 48.5 \Omega$

$\text{Im}\{Z\} = -6.5 \Omega$

Return Loss at 1800 MHz                    **-23.3 dB**

### 4. Handling

Do not apply excessive force to the dipole arms, because they might bend. Bending of the dipole arms stresses the soldered connections near the feedpoint leading to a damage of the dipole.

### 5. Design

The dipole is made of standard semirigid coaxial cable. The center conductor of the feeding line is directly connected to the second arm of the dipole. The antenna is therefore short-circuited for DC-signals.

### 6. Power Test

After long term use with 40W radiated power, only a slight warming of the dipole near the feedpoint can be measured.

Date/Time: 06/04/03 14:55:26

Test Laboratory: SPEAG, Zurich, Switzerland  
 File Name: SN247\_SN1507\_HSL1800\_040603.da4

**DUT: Dipole 1800 MHz; Type: D1800V2; Serial: D1800V2 - SN247**  
**Program: Dipole Calibration**

Communication System: CW-1800; Frequency: 1800 MHz; Duty Cycle: 1:1  
 Medium: HSL 1800 MHz ( $\sigma = 1.36 \text{ mho/m}$ ,  $\epsilon_r = 39.22$ ,  $\rho = 1000 \text{ kg/m}^3$ )

Phantom section: Flat Section

Measurement Standard: DASY4 (High Precision Assessment)

DASY4 Configuration:

- Probe: ET3DV6 - SN1507; ConvF(5.3, 5.3, 5.3); Calibrated: 1/18/2003
- Sensor-Surface: 4mm (Mechanical Surface Detection)
- Electronics: DAE3 - SN411; Calibrated: 1/16/2003
- Phantom: SAM with CRP - TP1006; Type: SAM 4.0; Serial: TP:1006
- Measurement SW: DASY4, V4.1 Build 47; Postprocessing SW: SEMCAD, V1.6 Build 115

**Pin = 250 mW; d = 10 mm/Area Scan (81x81x1):** Measurement grid: dx=15mm, dy=15mm

Reference Value = 96 V/m

Power Drift = -0.004 dB

Maximum value of SAR = 11 mW/g

**Pin = 250 mW; d = 10 mm/Zoom Scan (7x7x7)/Cube 0:** Measurement grid: dx=5mm, dy=5mm, dz=5mm

Peak SAR (extrapolated) = 16.9 W/kg

SAR(1 g) = 9.9 mW/g; SAR(10 g) = 5.22 mW/g

Reference Value = 96 V/m

Power Drift = -0.004 dB

Maximum value of SAR = 11.1 mW/g

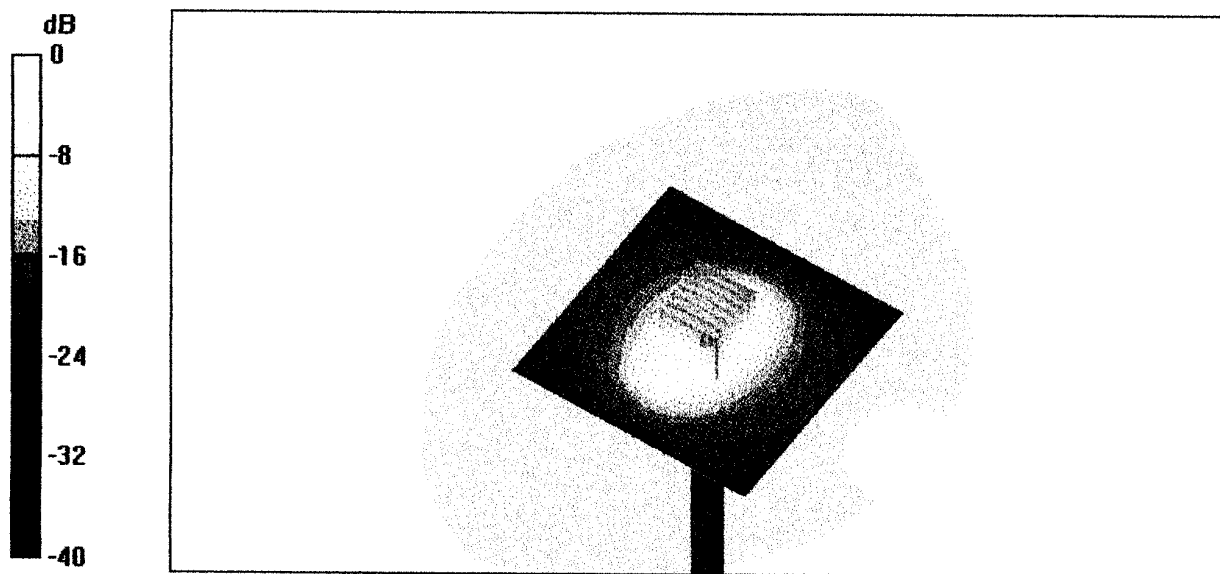

0 dB = 11.1mW/g

4 Jun 2003 10:48:36

[CH1] S11 1 U FS 1: 48.520  $\omega$  -6.5293  $\omega$  13.542 pF 1 800.000 000 MHz

De1

Cor

Avg  
16

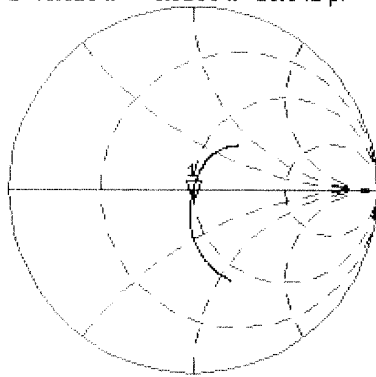

CH2 S11 LOG 5 dB/REF -20 dB 1:-23.337 dB 1 800.000 000 MHz

Cor

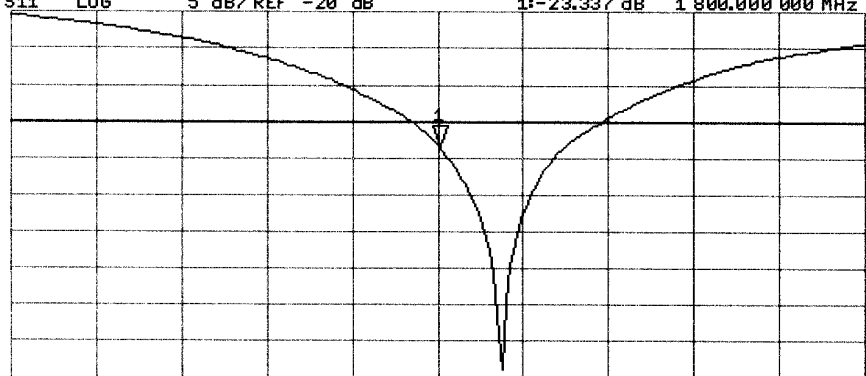



CENTER 1 800.000 000 MHz

SPAN 400.000 000 MHz

Test Report S/N:	021104-469KBC
Test Date(s):	March 04-05, 2004
Test Type:	FCC/IC SAR Evaluation

## APPENDIX D - PROBE CALIBRATION

Client **Celltech Labs**

CALIBRATION CERTIFICATE			
Object(s)	ET3DV6 - SN:1590		
Calibration procedure(s)	QA CAL-01.v2 Calibration procedure for dosimetric E-field probes		
Calibration date:	May 15, 2003		
Condition of the calibrated item	In Tolerance (according to the specific calibration document)		
This calibration statement documents traceability of M&TE used in the calibration procedures and conformity of the procedures with the ISO/IEC 17025 international standard.			
All calibrations have been conducted in the closed laboratory facility: environment temperature 22 +/- 2 degrees Celsius and humidity < 75%.			
Calibration Equipment used (M&TE critical for calibration)			
Model Type	ID #	Cal Date (Calibrated by, Certificate No.)	Scheduled Calibration
RF generator HP 8684C	US3642U01700	4-Aug-99 (SPEAG, in house check Aug-02)	In house check: Aug-05
Power sensor E4412A	MY41495277	2-Apr-03 (METAS, No 252-0250)	Apr-04
Power sensor HP 8481A	MY41092180	18-Sep-02 (Agilent, No. 20020918)	Sep-03
Power meter EPM E4419B	GB41293874	2-Apr-03 (METAS, No 252-0250)	Apr-04
Network Analyzer HP 8753E	US38432426	3-May-00 (Agilent, No. 8702K094602)	In house check: May 03
Fluke Process Calibrator Type 702	SN: 6295803	3-Sep-01 (ELCAL, No.2360)	Sep-03
Calibrated by:	Name Nicola Vetterli	Function Technician	Signature 
Approved by:	Name Katja Polovic	Function Laboratory Director	Signature 
Date issued: May 15, 2003			
This calibration certificate is issued as an intermediate solution until the accreditation process (based on ISO/IEC 17025 International Standard) for Calibration Laboratory of Schmid & Partner Engineering AG is completed.			

# Probe ET3DV6

SN:1590

Manufactured:	March 19, 2001
Last calibration:	April 26, 2002
Recalibrated:	May 15, 2003

Calibrated for DASY Systems

(Note: non-compatible with DASY2 system!)

**DASY - Parameters of Probe: ET3DV6 SN:1590****Sensitivity in Free Space**

NormX	<b>1.76</b> $\mu\text{V}/(\text{V}/\text{m})^2$
NormY	<b>1.91</b> $\mu\text{V}/(\text{V}/\text{m})^2$
NormZ	<b>1.66</b> $\mu\text{V}/(\text{V}/\text{m})^2$

**Diode Compression**

DCP X	<b>92</b>	mV
DCP Y	<b>92</b>	mV
DCP Z	<b>92</b>	mV

**Sensitivity in Tissue Simulating Liquid**

Head                      900 MHz                       $\epsilon_r = 41.5 \pm 5\%$                        $\sigma = 0.97 \pm 5\%$  mho/m

Valid for f=800-1000 MHz with Head Tissue Simulating Liquid according to EN 50361, P1528-200X

ConvF X	<b>7.0</b> $\pm 9.5\%$ (k=2)	Boundary effect:
ConvF Y	<b>7.0</b> $\pm 9.5\%$ (k=2)	Alpha <b>0.33</b>
ConvF Z	<b>7.0</b> $\pm 9.5\%$ (k=2)	Depth <b>2.56</b>

Head                      1800 MHz                       $\epsilon_r = 40.0 \pm 5\%$                        $\sigma = 1.40 \pm 5\%$  mho/m

Valid for f=1710-1910 MHz with Head Tissue Simulating Liquid according to EN 50361, P1528-200X

ConvF X	<b>5.5</b> $\pm 9.5\%$ (k=2)	Boundary effect:
ConvF Y	<b>5.5</b> $\pm 9.5\%$ (k=2)	Alpha <b>0.44</b>
ConvF Z	<b>5.5</b> $\pm 9.5\%$ (k=2)	Depth <b>2.69</b>

**Boundary Effect**

Head                      900 MHz                      Typical SAR gradient: 5 % per mm

Probe Tip to Boundary		<b>1 mm</b>	<b>2 mm</b>
SAR <sub>be</sub> [%]	Without Correction Algorithm	8.7	5.0
SAR <sub>be</sub> [%]	With Correction Algorithm	0.3	0.5

Head                      1800 MHz                      Typical SAR gradient: 10 % per mm

Probe Tip to Boundary		<b>1 mm</b>	<b>2 mm</b>
SAR <sub>be</sub> [%]	Without Correction Algorithm	12.3	8.5
SAR <sub>be</sub> [%]	With Correction Algorithm	0.2	0.1

**Sensor Offset**

Probe Tip to Sensor Center	<b>2.7</b>	mm
Optical Surface Detection	<b>1.4 <math>\pm</math> 0.2</b>	mm

### Receiving Pattern ( $\phi$ ), $\theta = 0^\circ$

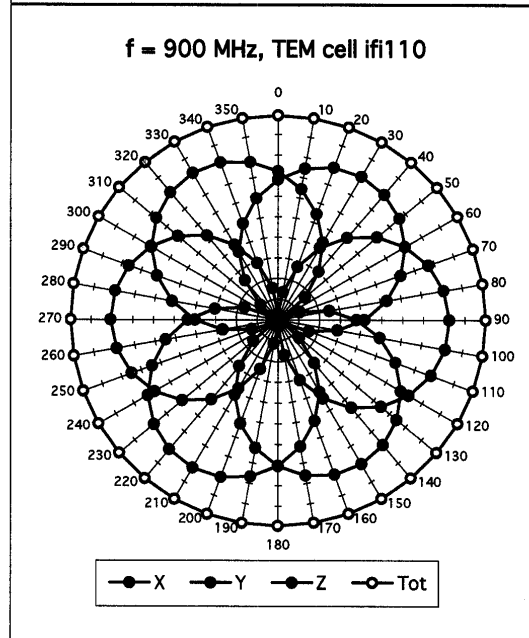
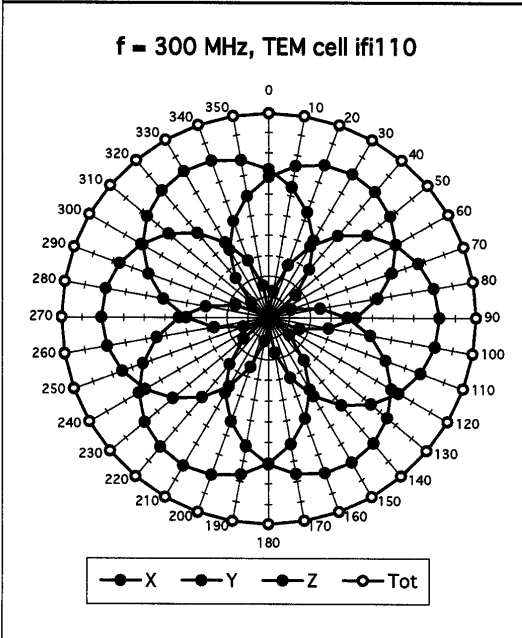
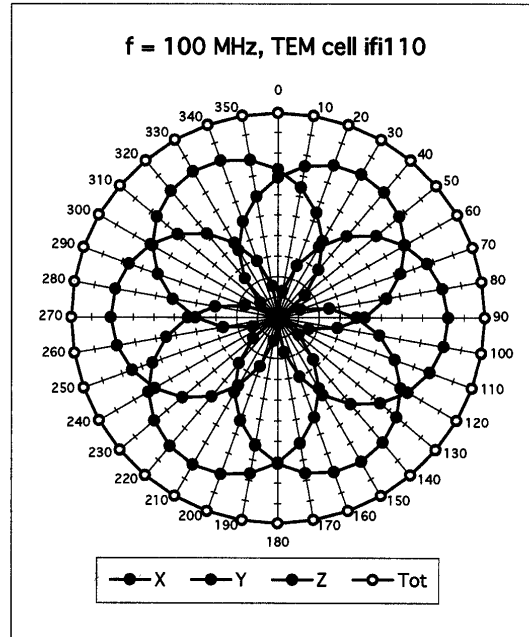
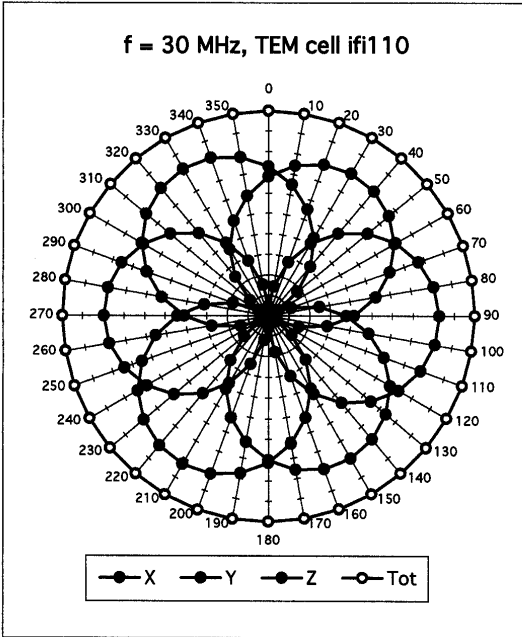



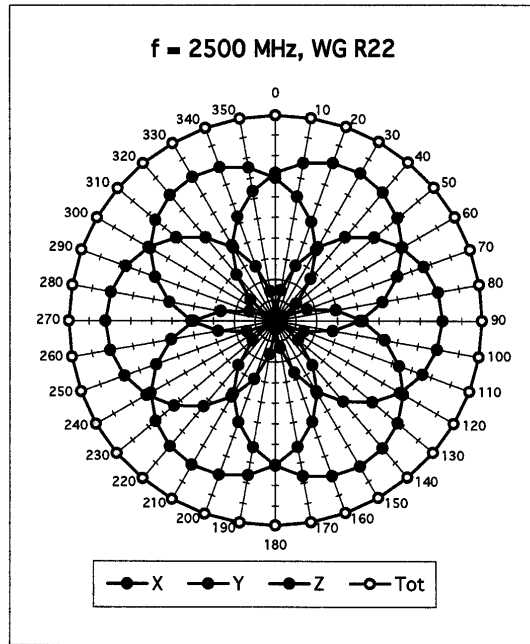
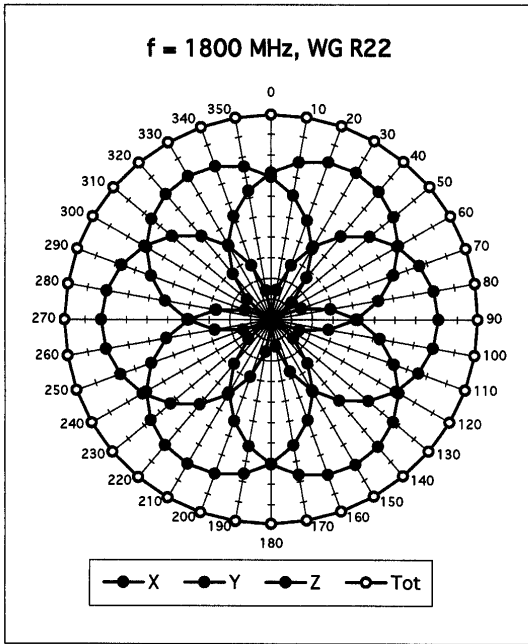

**Isotropy Error ( $\phi$ ),  $\theta = 0^\circ$**

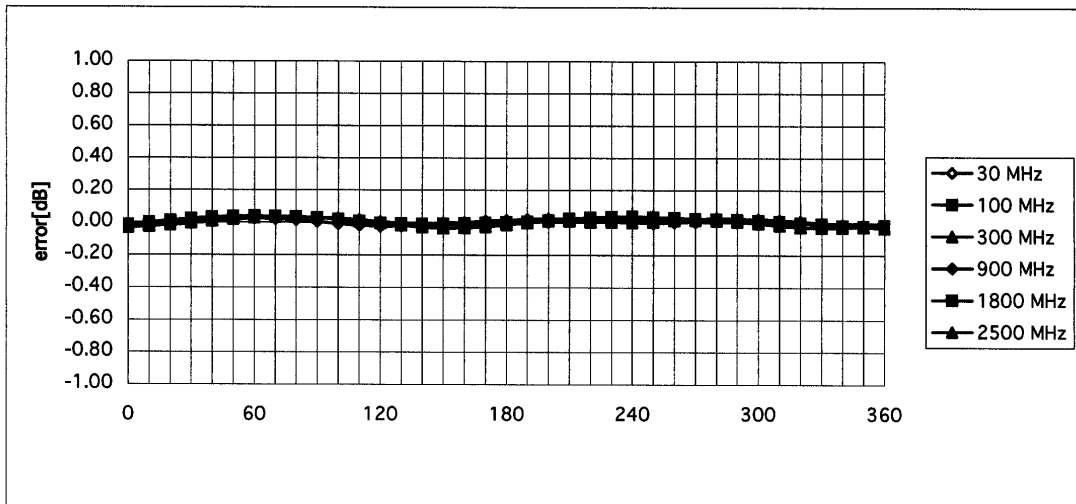

### Frequency Response of E-Field

( TEM-Cell:ifi110, Waveguide R22)

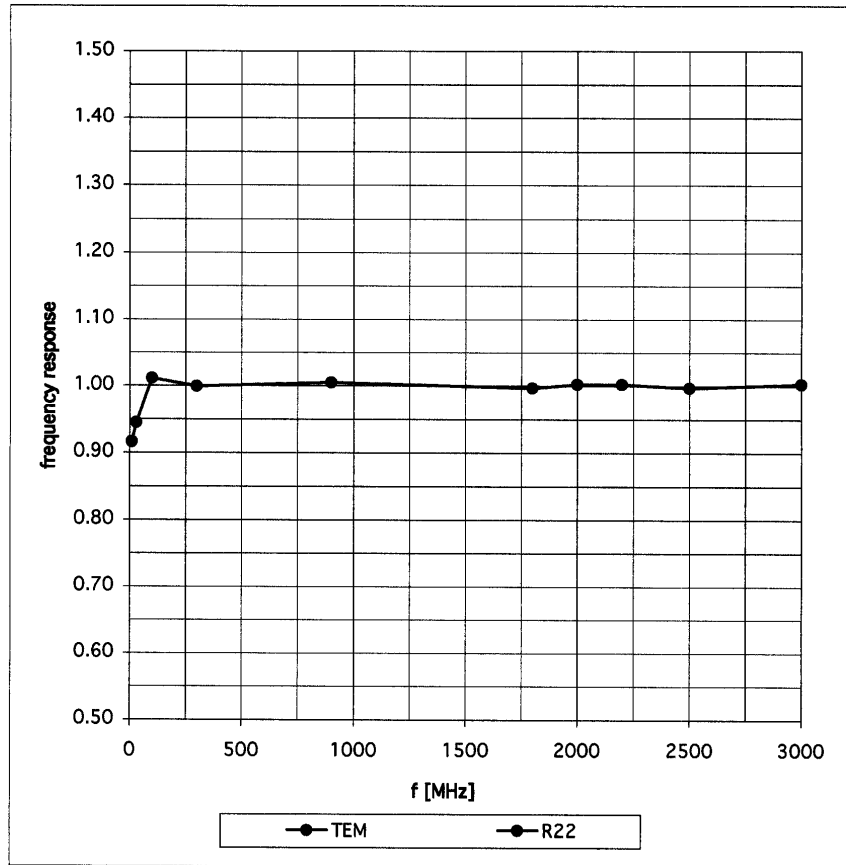

### Dynamic Range f(SAR<sub>brain</sub>)

( Waveguide R22 )

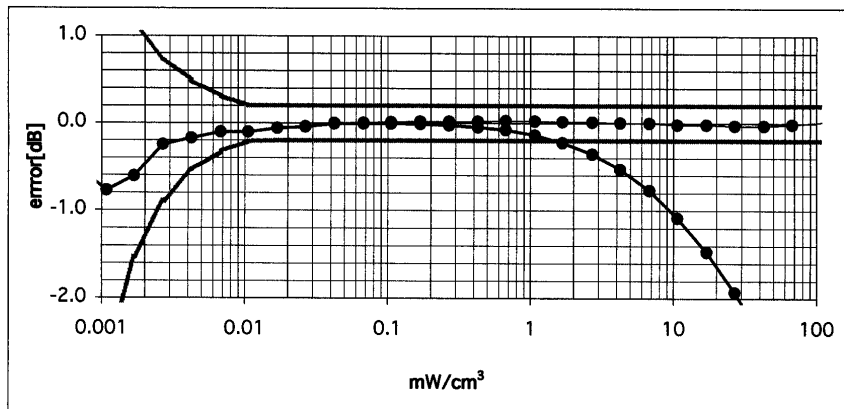
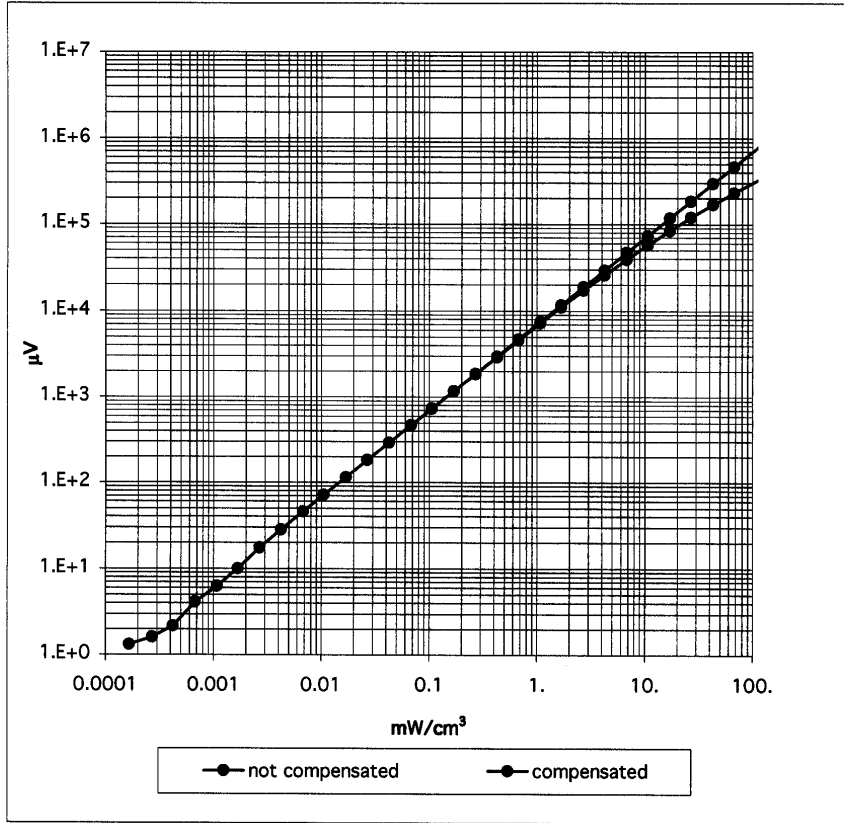

### Conversion Factor Assessment

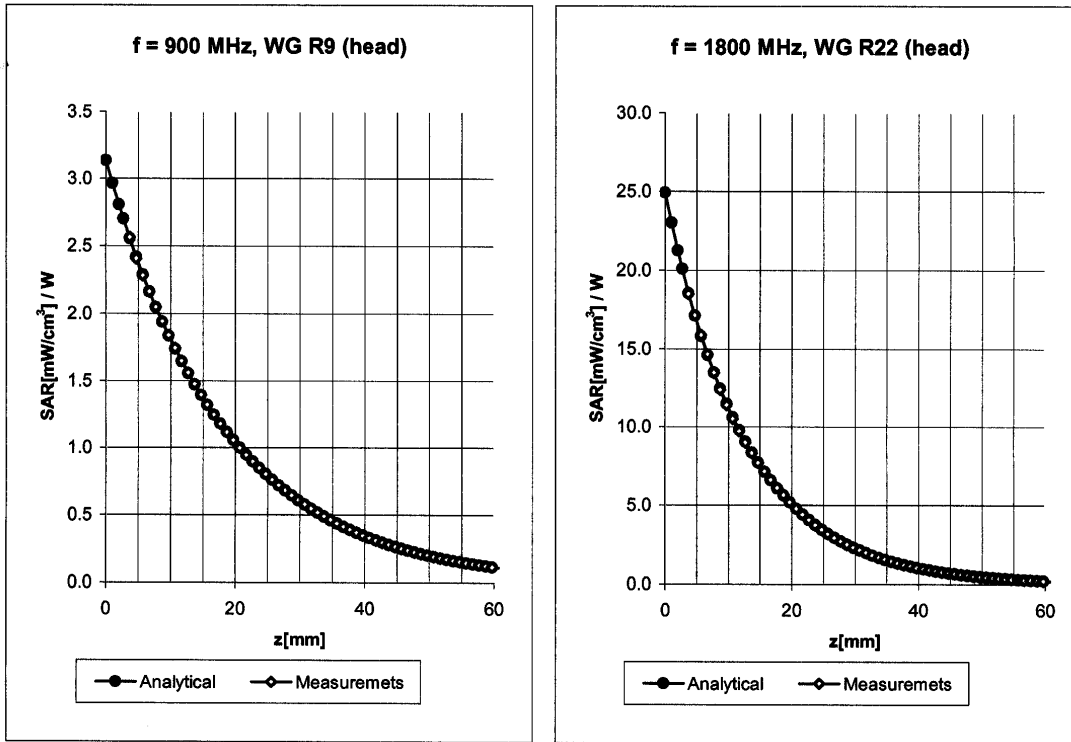

Head                      900 MHz                       $\epsilon_r = 41.5 \pm 5\%$                        $\sigma = 0.97 \pm 5\%$  mho/m

Valid for f=800-1000 MHz with Head Tissue Simulating Liquid according to EN 50361, P1528-200X

ConvF X	7.0 ± 9.5% (k=2)	Boundary effect:	
ConvF Y	7.0 ± 9.5% (k=2)	Alpha	<b>0.33</b>
ConvF Z	7.0 ± 9.5% (k=2)	Depth	<b>2.56</b>

Head                      1800 MHz                       $\epsilon_r = 40.0 \pm 5\%$                        $\sigma = 1.40 \pm 5\%$  mho/m

Valid for f=1710-1910 MHz with Head Tissue Simulating Liquid according to EN 50361, P1528-200X

ConvF X	5.5 ± 9.5% (k=2)	Boundary effect:	
ConvF Y	5.5 ± 9.5% (k=2)	Alpha	<b>0.44</b>
ConvF Z	5.5 ± 9.5% (k=2)	Depth	<b>2.69</b>

### Conversion Factor Assessment

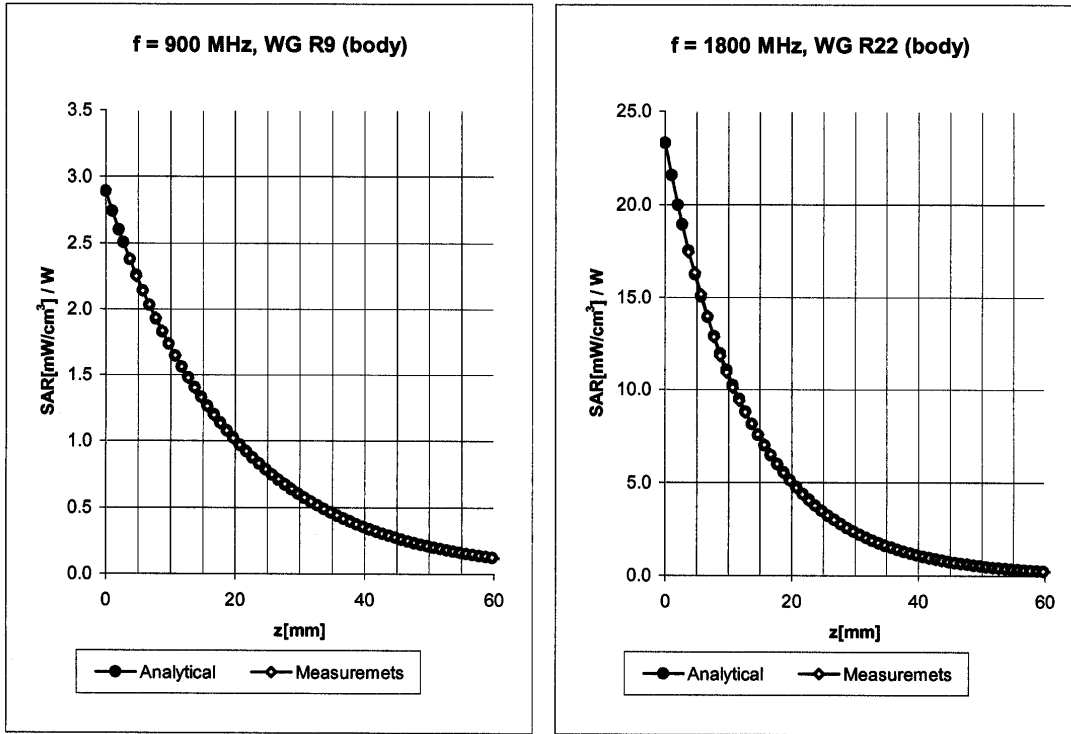

Body                      900 MHz                       $\epsilon_r = 55.0 \pm 5\%$                        $\sigma = 1.05 \pm 5\%$  mho/m

Valid for f=800-1000 MHz with Body Tissue Simulating Liquid according to OET 65 Suppl. C

ConvF X	<b>6.8</b> $\pm 9.5\%$ (k=2)	Boundary effect:
ConvF Y	<b>6.8</b> $\pm 9.5\%$ (k=2)	Alpha <b>0.34</b>
ConvF Z	<b>6.8</b> $\pm 9.5\%$ (k=2)	Depth <b>2.61</b>

Body                      1800 MHz                       $\epsilon_r = 53.3 \pm 5\%$                        $\sigma = 1.52 \pm 5\%$  mho/m

Valid for f=1710-1910 MHz with Body Tissue Simulating Liquid according to OET 65 Suppl. C

ConvF X	<b>5.0</b> $\pm 9.5\%$ (k=2)	Boundary effect:
ConvF Y	<b>5.0</b> $\pm 9.5\%$ (k=2)	Alpha <b>0.52</b>
ConvF Z	<b>5.0</b> $\pm 9.5\%$ (k=2)	Depth <b>2.69</b>

### Conversion Factor Assessment

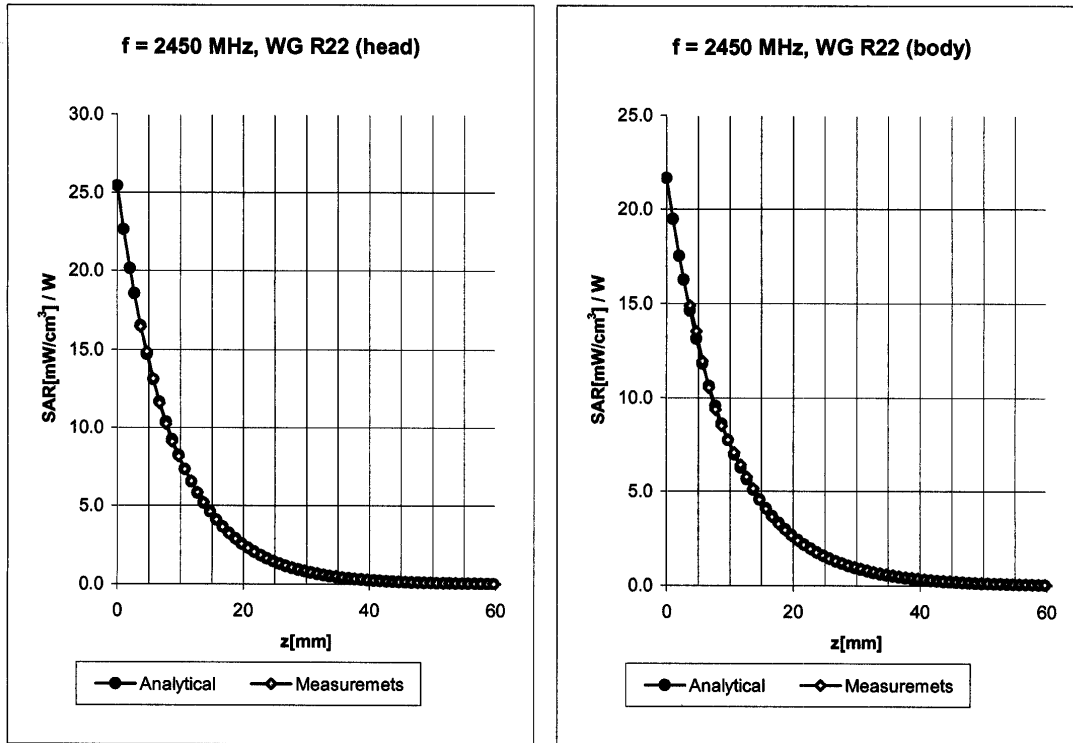

Head      2450      MHz       $\epsilon_r = 39.2 \pm 5\%$        $\sigma = 1.80 \pm 5\%$  mho/m

Valid for f=2400-2500 MHz with Head Tissue Simulating Liquid according to EN 50361, P1528-200X

ConvF X	5.0 ± 8.9% (k=2)	Boundary effect:	
ConvF Y	5.0 ± 8.9% (k=2)	Alpha	<b>0.88</b>
ConvF Z	5.0 ± 8.9% (k=2)	Depth	<b>1.92</b>

Body      2450      MHz       $\epsilon_r = 52.7 \pm 5\%$        $\sigma = 1.95 \pm 5\%$  mho/m

Valid for f=2400-2500 MHz with Body Tissue Simulating Liquid according to OET 65 Suppl. C

ConvF X	4.4 ± 8.9% (k=2)	Boundary effect:	
ConvF Y	4.4 ± 8.9% (k=2)	Alpha	<b>0.90</b>
ConvF Z	4.4 ± 8.9% (k=2)	Depth	<b>1.87</b>

### Deviation from Isotropy in HSL

Error ( $\theta, \phi$ ),  $f = 900$  MHz

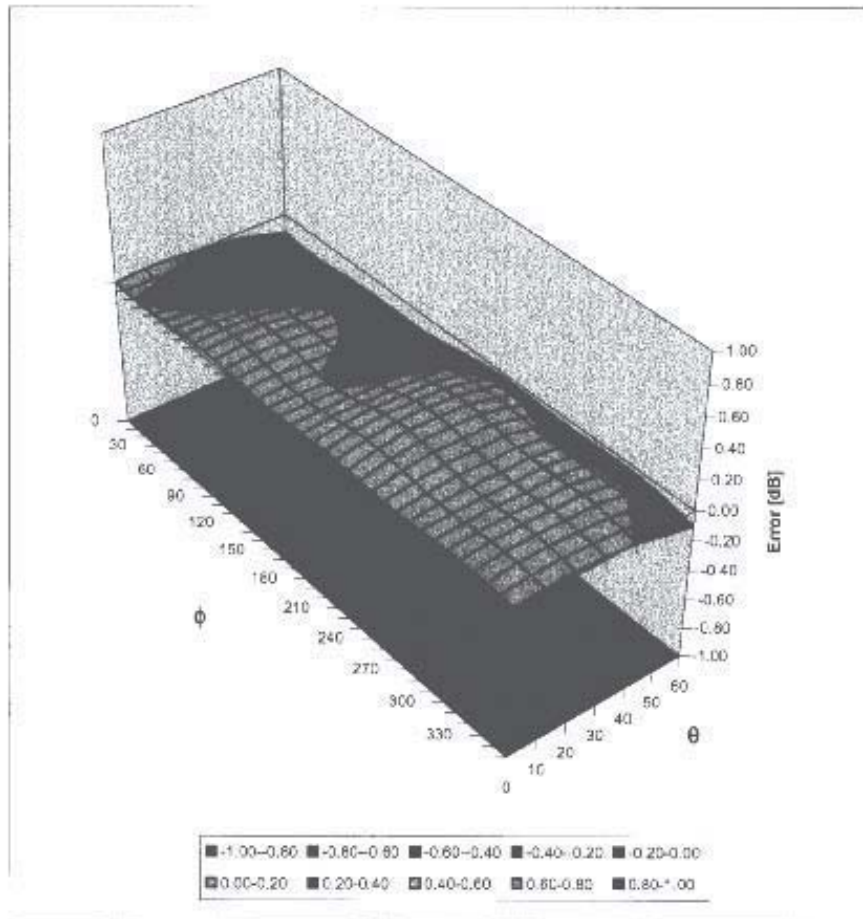

## Additional Conversion Factors for Dosimetric E-Field Probe

Type:

**ET3DV6**

Serial Number:

**1590**

Place of Assessment:

**Zurich**

Date of Assessment:

**May 19, 2003**

Probe Calibration Date:

**May 15, 2003**

Schmid & Partner Engineering AG hereby certifies that conversion factor(s) of this probe have been evaluated on the date indicated above. The assessment was performed using the FDTD numerical code SEMCAD of Schmid & Partner Engineering AG. Since the evaluation is coupled with measured conversion factors, it has to be recalculated yearly, i.e., following the re-calibration schedule of the probe. The uncertainty of the numerical assessment is based on the extrapolation from measured value at 900 MHz or at 1800 MHz.

Assessed by:

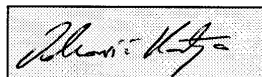



**Dosimetric E-Field Probe ET3DV6 SN:1590**Conversion factor ( $\pm$  standard deviation)

<b>150 MHz</b>	ConvF	<b>9.6 <math>\pm</math> 8%</b>	$\epsilon_r = 52.3 \pm 5\%$ $\sigma = 0.76 \pm 5\%$ mho/m (head tissue)
<b>300 MHz</b>	ConvF	<b>8.3 <math>\pm</math> 8%</b>	$\epsilon_r = 45.3 \pm 5\%$ $\sigma = 0.87 \pm 5\%$ mho/m (head tissue)
<b>450 MHz</b>	ConvF	<b>7.9 <math>\pm</math> 8%</b>	$\epsilon_r = 43.5 \pm 5\%$ $\sigma = 0.87 \pm 5\%$ mho/m (head tissue)
<b>150 MHz</b>	ConvF	<b>9.2 <math>\pm</math> 8%</b>	$\epsilon_r = 61.9 \pm 5\%$ $\sigma = 0.80 \pm 5\%$ mho/m (body tissue)
<b>450 MHz</b>	ConvF	<b>8.1 <math>\pm</math> 8%</b>	$\epsilon_r = 56.7 \pm 5\%$ $\sigma = 0.94 \pm 5\%$ mho/m (body tissue)

Test Report S/N:	021104-469KBC
Test Date(s):	March 04-05, 2004
Test Type:	FCC/IC SAR Evaluation

**APPENDIX E - MEASURED FLUID DIELECTRIC PARAMETERS**

# 1800 MHz System Performance Check

## Measured Fluid Dielectric Parameters (Brain)

March 04, 2004

Frequency	e'	e''
1.700000000 GHz	40.5168	13.5794
1.710000000 GHz	40.4880	13.6050
1.720000000 GHz	40.4225	13.6300
1.730000000 GHz	40.3724	13.6681
1.740000000 GHz	40.3039	13.6830
1.750000000 GHz	40.2425	13.7126
1.760000000 GHz	40.2051	13.7280
1.770000000 GHz	40.1596	13.7485
1.780000000 GHz	40.1142	13.7567
1.790000000 GHz	40.0752	13.7735
1.800000000 GHz	40.0238	13.7981
1.810000000 GHz	39.9838	13.8342
1.820000000 GHz	39.9251	13.8575
1.830000000 GHz	39.8839	13.8823
1.840000000 GHz	39.8542	13.8941
1.850000000 GHz	39.8046	13.9063
1.860000000 GHz	39.7820	13.9260
1.870000000 GHz	39.7369	13.9177
1.880000000 GHz	39.7039	13.9411
1.890000000 GHz	39.6830	13.9629
1.900000000 GHz	39.6735	13.9774

# 1880 MHz DUT Evaluation (Body)

## Measured Fluid Dielectric Parameters (Muscle)

March 04, 2004

Frequency	$\epsilon'$	$\epsilon''$
1.780000000 GHz	51.7750	14.4235
1.790000000 GHz	51.7473	14.4440
1.800000000 GHz	51.6773	14.4674
1.810000000 GHz	51.6709	14.5132
1.820000000 GHz	51.6001	14.5311
1.830000000 GHz	51.5782	14.5832
1.840000000 GHz	51.5517	14.6108
1.850000000 GHz	51.5196	14.6504
1.860000000 GHz	51.4922	14.6684
1.870000000 GHz	51.4634	14.6950
1.880000000 GHz	51.4385	14.7077
1.890000000 GHz	51.4186	14.7484
1.900000000 GHz	51.3783	14.7679
1.910000000 GHz	51.3431	14.8153
1.920000000 GHz	51.3214	14.8475
1.930000000 GHz	51.2893	14.8820
1.940000000 GHz	51.2657	14.9199
1.950000000 GHz	51.2186	14.9651
1.960000000 GHz	51.1901	14.9973
1.970000000 GHz	51.1376	15.0518
1.980000000 GHz	51.0906	15.0946

# 1880 MHz DUT Evaluation (Body)

## Measured Fluid Dielectric Parameters (Muscle)

March 05, 2004

Frequency	$\epsilon'$	$\epsilon''$
1.850000000 GHz	52.2555	15.1175
1.855000000 GHz	52.2565	15.1278
1.860000000 GHz	52.2418	15.1445
1.865000000 GHz	52.2371	15.1597
1.870000000 GHz	52.2061	15.1691
1.875000000 GHz	52.1946	15.1795
1.880000000 GHz	52.1773	15.1951
1.885000000 GHz	52.1628	15.2011
1.890000000 GHz	52.1405	15.2142
1.895000000 GHz	52.1279	15.2295
1.900000000 GHz	52.1026	15.2381
1.905000000 GHz	52.0728	15.2654
1.910000000 GHz	52.0328	15.2767
1.915000000 GHz	51.9985	15.2938
1.920000000 GHz	51.9674	15.3299
1.925000000 GHz	51.9382	15.3356
1.930000000 GHz	51.9237	15.3570
1.935000000 GHz	51.8872	15.3696
1.940000000 GHz	51.8826	15.3929
1.945000000 GHz	51.8596	15.4152
1.950000000 GHz	51.8483	15.4341

Test Report S/N:	021104-469KBC
Test Date(s):	March 04-05, 2004
Test Type:	FCC/IC SAR Evaluation

## APPENDIX F - SAM PHANTOM CERTIFICATE OF CONFORMITY

# Schmid & Partner Engineering AG

Zeughausstrasse 43, 8004 Zurich, Switzerland, Phone +41 1 245 97 00, Fax +41 1 245 97 79

## Certificate of conformity / First Article Inspection

Item	SAM Twin Phantom V4.0
Type No	QD 000 P40 BA
Series No	TP-1002 and higher
Manufacturer / Origin	Untersee Composites Hauptstr. 69 CH-8559 Fruthwilen Switzerland

### Tests

The series production process used allows the limitation to test of first articles. Complete tests were made on the pre-series Type No. QD 000 P40 AA, Serial No. TP-1001 and on the series first article Type No. QD 000 P40 BA, Serial No. TP-1006. Certain parameters have been retested using further series units (called samples).

Test	Requirement	Details	Units tested
Shape	Compliance with the geometry according to the CAD model.	IT'IS CAD File (*)	First article, Samples
Material thickness	Compliant with the requirements according to the standards	2mm +/- 0.2mm in specific areas	First article, Samples
Material parameters	Dielectric parameters for required frequencies	200 MHz – 3 GHz Relative permittivity < 5 Loss tangent < 0.05.	Material sample TP 104-5
Material resistivity	The material has been tested to be compatible with the liquids defined in the standards	Liquid type HSL 1800 and others according to the standard.	Pre-series, First article

### Standards

- [1] CENELEC EN 50361
- [2] IEEE P1528-200x draft 6.5
- [3] IEC PT 62209 draft 0.9

(\*) The IT'IS CAD file is derived from [2] and is also within the tolerance requirements of the shapes of [1] and [3].

### Conformity

Based on the sample tests above, we certify that this item is in compliance with the uncertainty requirements of SAR measurements specified in standard [1] and draft standards [2] and [3].

Date 18.11.2001

Signature / Stamp



**Schmid & Partner  
Engineering AG**



Zeughausstrasse 43, CH-8004 Zurich  
Tel. +41 1 245 97 00, Fax +41 1 245 97 79

Test Report S/N:	021104-469KBC
Test Date(s):	March 04-05, 2004
Test Type:	FCC/IC SAR Evaluation

## APPENDIX G - PLANAR PHANTOM CERTIFICATE OF CONFORMITY



2378 Westlake Road  
Kelowna, B.C. Canada  
V1Z-2V2



Ph. # 250-769-6848  
Fax # 250-769-6334  
E-mail: [barskiind@shaw.ca](mailto:barskiind@shaw.ca)  
Web: [www.bcfiberglass.com](http://www.bcfiberglass.com)

## FIBERGLASS FABRICATORS

### Certificate of Conformity

Item : Flat Planar Phantom Unit # 03-01  
Date: June 16, 2003  
Manufacturer: Barski Industries (1985 Ltd)

Test	Requirement	Details
Shape	Compliance to geometry according to drawing	Supplied CAD drawing
Material Thickness	Compliant with the requirements	2mm +/- 0.2mm in measurement area
Material Parameters	Dielectric parameters for required frequencies Based on Dow Chemical technical data	100 MHz-5 GHz Relative permittivity<5 Loss Tangent<0.05

#### Conformity

Based on the above information, we certify this product to be compliant to the requirements specified.

Signature: 

Daniel Chailier



**Fiberglass Planar Phantom - Top View**



**Fiberglass Planar Phantom - Front View**



**Fiberglass Planar Phantom - Back View**



**Fiberglass Planar Phantom - Bottom View**

## Dimensions of Fiberglass Planar Phantom

(Manufactured by Barski Industries Ltd. - Unit# 03-01)

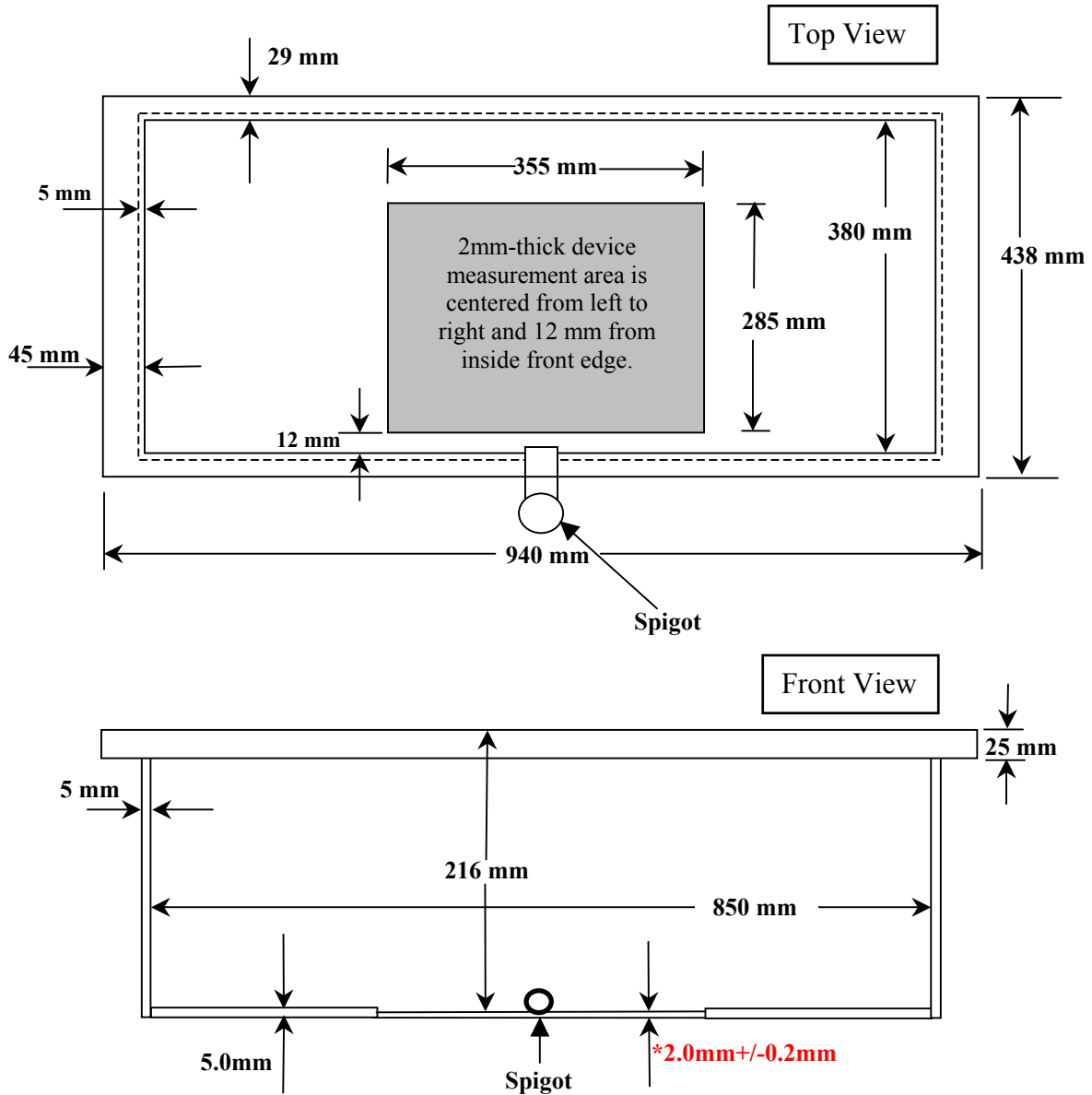

**Note: Measurements that aren't repeated for the opposite sides are the same as the side measured.  
This drawing is not to scale.**