

DECLARATION OF COMPLIANCE SAR RF EXPOSURE EVALUATION

Test Lab

CELLTECH LABS INC.
Testing and Engineering Services
1955 Moss Court
Kelowna, B.C.
Canada V1Y 9L3
Phone: 250-448-7047
Fax: 250-448-7046
e-mail: info@celltechlabs.com
web site: www.celltechlabs.com

Applicant Information

ITRONIX CORPORATION
801 South Stevens Street
Spokane, WA 99204
USA

<p>Rule Part(s): Test Procedure(s): FCC Device Classification: IC Device Classification: FCC IDENTIFIER: Model(s): Device Type:</p> <p>Internal Transmitter(s):</p> <p>Mode(s) of Operation:</p> <p>Tx Frequency Range(s):</p> <p>Max. RF Output Power(s):</p> <p>Antenna Type(s):</p> <p>Battery Type(s): Body-worn Accessories:</p> <p>Max. SAR Level Measured:</p>	<p>FCC 47 CFR §2.1093; IC RSS-102 Issue 1 (Provisional) FCC OET Bulletin 65, Supplement C (Edition 01-01) Digital Transmission System (DTS) Low Power License-Exempt Radiocommunication Device KBCIX100XA555WLBT IX100XA555WLBT Rugged Handheld PC with 802.11b & Bluetooth Transmitter (co-located with Dual-Band PCS/Cellular CDMA Modem) USI WM-BB-AG-01 802.11b & Bluetooth Combo Module Sierra Wireless AirCard 555/550 CDMA PCMCIA Modem DSSS (Direct Sequence Spread Spectrum) - 802.11b FHSS (Frequency Hopping Spread Spectrum) - Bluetooth 2412 - 2462 MHz (802.11b) 2402 - 2480 MHz (Bluetooth) 14.0 dBm Peak Conducted (802.11b) 3.5 dBm Peak Conducted (Bluetooth) (23.0 dBm Conducted - PCS/Cellular CDMA) Internal - Front Top Center above LCD Display (802.11b) Internal - Front Right Side Center (Bluetooth) (External ¼ wave Helix - Dual-Band CDMA) Lithium-ion 7.4 V, 3.0 Ah (P/N: 46-0136-001) Nylon Carry Case (P/N: 54-0644-001) Ear-Microphone (Model: JABRA) 0.053 W/kg (1g average)</p>
--	---

Celltech Labs Inc. declares under its sole responsibility that this wireless portable device has demonstrated compliance with the Specific Absorption Rate (SAR) RF exposure requirements specified in FCC 47 CFR §2.1093 and Health Canada's Safety Code 6. The device was tested in accordance with the measurement standards and procedures specified in FCC OET Bulletin 65, Supplement C (Edition 01-01), and Industry Canada RSS-102 Issue 1 (Provisional) for the General Population / Uncontrolled Exposure environment. All measurements were performed in accordance with the SAR system manufacturer recommendations.

I attest to the accuracy of data. All measurements were performed by me or were made under my supervision and are correct to the best of my knowledge and belief. I assume full responsibility for the completeness of these measurements and vouch for the qualifications of all persons taking them.

This test report shall not be reproduced partially, or in full, without the prior written approval of Celltech Labs Inc.. The results and statements contained in this report pertain only to the device(s) evaluated.



Russell Pipe
Senior Compliance Technologist
Celltech Labs Inc.



TABLE OF CONTENTS		
1.0	INTRODUCTION.....	3
2.0	DESCRIPTION OF DUT.....	3
3.0	SAR MEASUREMENT SYSTEM.....	4
4.0	MEASUREMENT SUMMARY.....	5
5.0	DETAILS OF SAR EVALUATION.....	6
6.0	EVALUATION PROCEDURES.....	6
7.0	SYSTEM PERFORMANCE CHECK.....	7
8.0	SIMULATED EQUIVALENT TISSUES.....	8
9.0	SAR SAFETY LIMITS.....	8
10.0	ROBOT SYSTEM SPECIFICATIONS.....	9
11.0	PROBE SPECIFICATION.....	10
12.0	SAM PHANTOM V4.0C.....	10
13.0	PLANAR PHANTOM.....	10
14.0	DEVICE HOLDER.....	10
15.0	TEST EQUIPMENT LIST.....	11
16.0	MEASUREMENT UNCERTAINTIES.....	12-13
17.0	REFERENCES.....	14
	APPENDIX A - SAR MEASUREMENT DATA.....	15
	APPENDIX B - SYSTEM PERFORMANCE CHECK DATA.....	16
	APPENDIX C - SYSTEM VALIDATION.....	17
	APPENDIX D - PROBE CALIBRATION.....	18
	APPENDIX E - MEASURED FLUID DIELECTRIC PARAMETERS.....	19
	APPENDIX F - SAM PHANTOM CERTIFICATE OF CONFORMITY.....	20
	APPENDIX G - PLANAR PHANTOM CERTIFICATE OF CONFORMITY.....	21
	APPENDIX H - SAR TEST SETUP PHOTOGRAPHS.....	22

1.0 INTRODUCTION

This measurement report demonstrates that ITRONIX CORPORATION Model: IX100XA555WLBT Rugged Handheld PC FCC ID: KBCIX100XA555WLBT with 802.11b & Bluetooth Combo Transmitter (co-located with Dual-Band PCS/Cellular CDMA PCMCIA Modem) complies with the SAR (Specific Absorption Rate) RF exposure requirements specified in FCC 47 CFR §2.1093 (see reference [1]), and Health Canada Safety Code 6 (see reference [2]) for the General Population / Uncontrolled Exposure environment. The test procedures described in FCC OET Bulletin 65, Supplement C (Edition 01-01) (see reference [3]) and IC RSS-102 Issue 1 (Provisional) (see reference [4]), were employed. A description of the product, operating configuration, detailed summary of the test results, methodology and procedures used in the evaluation, equipment used, and the various provisions of the rules are included within this test report.

2.0 DESCRIPTION OF DEVICE UNDER TEST (DUT)

FCC Rule Part(s)	47 CFR §2.1093		
IC Rule Part(s)	IC RSS-102 Issue 1 (Provisional)		
Test Procedure(s)	FCC OET Bulletin 65, Supplement C (01-01)		
FCC Device Classification	Digital Transmission System (DTS)		
IC Device Classification	Low Power License-Exempt Radiocommunication Device		
Device Type	Rugged Handheld PC with 802.11b & Bluetooth Transmitter (Co-located with Dual-Band PCS/Cellular CDMA PCMCIA Modem)		
Internal Transmitter(s)	USI WM-BB-AG-01 802.11b / Bluetooth Combo Module		
	Sierra Wireless AirCard 555/550 PCS/Cellular CDMA Modem		
FCC IDENTIFIER	KBCIX100XA555WLBT		
Model(s)	IX100XA555WLBT		
Serial No.	510495001-U5103-0025	Identical Prototype	
Mode(s) of Operation	802.11b	DSSS	Direct Sequence Spread Spectrum
	Bluetooth	FHSS	Frequency Hopping Spread Spectrum
Tx Frequency Range(s)	2412 - 2462 MHz	802.11b	
	2402 - 2480 MHz	Bluetooth	
Max. RF Output Power Tested	14.0 dBm	Peak Conducted	802.11b
	3.5 dBm	Peak Conducted	Bluetooth
Antenna Type(s) Tested	Internal	Front Top Center (above LCD Display)	802.11b
	Internal	Front Right Side Center	Bluetooth
Battery Type(s) Tested	Lithium-ion	7.4 V, 3.0 Ah	P/N: 46-0136-001
Body-worn Accessories Tested	Nylon Carry Case		P/N: 54-0644-001
	Ear-Microphone		Model: JABRA

3.0 SAR MEASUREMENT SYSTEM

Celltech Labs Inc. SAR measurement facility utilizes the Dosimetric Assessment System (DASY™) manufactured by Schmid & Partner Engineering AG (SPEAG™) of Zurich, Switzerland. The DASY4 measurement system is comprised of the measurement server, robot controller, computer, near-field probe, probe alignment sensor, specific anthropomorphic mannequin (SAM) phantom, and various planar phantoms for brain and/or body SAR evaluations. The robot is a six-axis industrial robot performing precise movements to position the probe to the location (points) of maximum electromagnetic field (EMF). A cell controller system contains the power supply, robot controller, teach pendant (Joystick), and remote control, is used to drive the robot motors. The Staubli robot is connected to the cell controller to allow software manipulation of the robot. A data acquisition electronic (DAE) circuit performs the signal amplification, signal multiplexing, AD-conversion, offset measurements, mechanical surface detection, collision detection, etc. is connected to the Electro-optical coupler (EOC). The EOC performs the conversion from the optical into digital electric signal of the DAE and transfers data to the DASY4 measurement server. The DAE4 utilizes a highly sensitive electrometer-grade preamplifier with auto-zeroing, a channel and gain-switching multiplexer, a fast 16-bit AD-converter and a command decoder and control logic unit. Transmission to the DASY4 measurement server is accomplished through an optical downlink for data and status information and an optical uplink for commands and clock lines. The mechanical probe-mounting device includes two different sensor systems for frontal and sidewise probe contacts. The sensor systems are also used for mechanical surface detection and probe collision detection. The robot uses its own controller with a built in VME-bus computer.



DASY4 SAR Measurement System with planar phantom



DASY4 SAR Measurement System with SAM phantom

4.0 MEASUREMENT SUMMARY

BODY-WORN SAR MEASUREMENT RESULTS

Tx	Test Mode	Freq. (MHz)	Cond. Power Before Test (dBm)	Batt. Type	Antenna Type	Body-Worn Accessories	DUT Position Relative to Front of Carry Case	DUT Position Relative to Planar Phantom	Separ. Distance to Planar Phantom (cm)	Measured SAR 1g (W/kg)		SAR Drift During Test (dB)	Scaled SAR 1g (W/kg)	
										F	£		F	£
802.11b	DSSS	2437	14.0	Li-ion	Internal	Carry Case Ear-Mic	Front Side facing Front of Carry Case	Front Side facing Phantom	0.0	F	0.035	-0.193	F	0.037
										£	0.028		£	0.029
802.11b	DSSS	2437	14.0	Li-ion	Internal	Carry Case Ear-Mic	Front Side facing Front of Carry Case	Front Side facing Phantom	0.0	F	0.053	-0.0318	F	0.053
BT	Modulated Fixed Freq.	2441	3.5		Internal					£	0.038		£	0.038

ANSI / IEEE C95.1 1999 - SAFETY LIMIT
Spatial Peak - Uncontrolled Exposure / General Population
BODY: 1.6 W/kg (averaged over 1 gram)

Test Date(s)	03/02/04		Relative Humidity	30	%	
Measured Fluid Type	2450 MHz Body		Atmospheric Pressure	101.9	kPa	
Dielectric Constant ϵ_r	IEEE Target		Ambient Temperature	24.1	°C	
	52.7	± 5%	Measured	50.5	Fluid Temperature	23.8
Conductivity σ (mho/m)	IEEE Target		Fluid Depth	≥ 15	cm	
	1.95	± 5%	Measured	2.01	ρ (Kg/m ³)	1000

Note(s):

- The measurement results were obtained with the DUT tested in the conditions described in this report. Detailed measurement data and plots showing the maximum SAR location of the DUT are reported in Appendix A.
- If the SAR levels measured at the mid channel were ≥ 3 dB below the SAR limit; SAR evaluation for the low and high channels was optional (per FCC OET Bulletin 65, Supplement C, Edition 01-01 - see reference [3]).
- Secondary peak SAR locations were evaluated to report SAR levels within 2 dB of the primary (P = Primary, S = Secondary).
- The power drifts measured by the DASY system for the duration of the SAR evaluations were added to the measured SAR levels to report scaled SAR results.
- The ambient and fluid temperatures were measured prior to, and during, the fluid dielectric parameter check and the SAR evaluation. The temperatures reported were consistent for all measurement periods.
- The dielectric parameters of the simulated body tissue were measured prior to the evaluation using an HP 85070C Dielectric Probe Kit and an HP 8753E Network Analyzer (see attached printout of measured fluid dielectric parameters).
- The SAR evaluations were performed within 24 hours of the system performance check.

5.0 DETAILS OF SAR EVALUATION

The ITRONIX CORPORATION Model: IX100XA555WLBT Rugged Handheld PC FCC ID: KBCIX100XA555WLBT with internal 802.11b & Bluetooth Combo Transmitter (co-located with Dual-Band PCS/Cellular CDMA PCMCIA Modem) was compliant for localized Specific Absorption Rate (Uncontrolled Exposure) based on the following test provisions and conditions described below. The detailed test setup photographs are shown in Appendix H.

Body-worn SAR Configuration

1. The DUT was tested for body-worn SAR with shoulder carry case and ear-microphone accessories. The front side of the DUT (keypad/LCD side) was facing the front of the carry case and placed parallel to the outer surface of the planar phantom. The front of the carry case was touching the outer surface of the planar phantom. The nylon carry case provides a 0.5 cm separation distance from the DUT to the outer surface of the planar phantom.
2. Due to the dimensions of the DUT, a stack of low-density, low-loss dielectric foamed polystyrene was used in place of the device holder.
3. The ambient and fluid temperatures were measured prior to, and during, the fluid dielectric parameter check and the SAR evaluation. The temperatures reported were consistent for all measurement periods.
4. The dielectric parameters of the simulated body tissue were measured prior to the SAR evaluation using an HP 85070C Dielectric Probe Kit and an HP 8753E Network Analyzer (see Appendix E for printout of measured fluid dielectric parameters).
5. The SAR evaluations were performed within 24 hours of the system performance check.

DUT Test Modes & Power Settings

6. The conducted power levels were measured prior to the SAR evaluation using a Gigatronics 8652A Universal Power Meter according to the procedures described in FCC 47 CFR §2.1046.
7. The power drifts measured by the DASY4 system for the duration of the SAR evaluations were added to the measured SAR levels to report scaled SAR results as shown in the test data table (page 5).
8. The DUT was controlled in test mode via internal software. SAR measurements were performed with the DUT transmitting continuously at maximum power with a modulated DSSS signal for 802.11b transmit, and modulated signal, fixed frequency for Bluetooth transmit.
9. The SAR evaluations were performed with a fully charged battery in the DUT.

6.0 EVALUATION PROCEDURES

- a. (i) The evaluation was performed in the applicable area of the phantom depending on the type of device being tested. For devices held to the ear during normal operation, both the left and right ear positions were evaluated using the SAM phantom.
(ii) For body-worn and face-held devices a planar phantom was used.
- b. The SAR was determined by a pre-defined procedure within the DASY4 software. Upon completion of a reference and optical surface check, the exposed region of the phantom was scanned near the inner surface with a grid spacing of 15mm x 15mm.

An area scan was determined as follows:

- c. Based on the defined area scan grid, a more detailed grid is created to increase the points by a factor of 10. The interpolation function then evaluates all field values between corresponding measurement points.
- d. A linear search is applied to find all the candidate maxima. Subsequently, all maxima are removed that are >2 dB from the global maximum. The remaining maxima are then used to position the cube scans.

A 1g and 10g spatial peak SAR was determined as follows:

- e. Extrapolation is used to find the points between the dipole center of the probe and the surface of the phantom. This data cannot be measured, since the center of the dipoles is 2.7 mm away from the tip of the probe and the distance between the surface and the lowest measuring point is 1.4 mm (see probe calibration document in Appendix D). The extrapolation was based on trivariate quadratics computed from the previously calculated 3D interpolated points nearest the phantom surface.
- f. Interpolated data is used to calculate the average SAR over 1g and 10g cubes by spatially discretizing the entire measured cube. The volume used to determine the averaged SAR is a 1mm grid (42875 interpolated points).
- g. A zoom scan volume of 32 mm x 32 mm x 30 mm (5 x 5 x 7 points) centered at the peak SAR location determined from the area scan is used for all zoom scans for devices with a transmit frequency < 800 MHz. Zoom scans for frequencies ≥ 800 MHz are determined with a scan volume of 30 mm x 30 mm x 30 mm (7 x 7 x 7) to ensure complete capture of the peak spatial-average SAR.

7.0 SYSTEM PERFORMANCE CHECK

Prior to the SAR evaluation a system check was performed at the planar section of the SAM phantom with a 2450MHz dipole (see Appendix C for system validation procedures). The dielectric parameters of the simulated tissue were measured prior to the system performance check using an HP 85070C Dielectric Probe Kit and an HP 8753E Network Analyzer (see Appendix E for printout of measured fluid dielectric parameters). A forward power of 250 mW was applied to the dipole and the system was verified to a tolerance of $\pm 10\%$ (see Appendix B for system performance check test plot).

SYSTEM PERFORMANCE CHECK													
Test Date	Equiv. Tissue	SAR 1g (W/kg)		Dielectric Constant ϵ_r		Conductivity σ (mho/m)		ρ (Kg/m ³)	Amb. Temp. (°C)	Fluid Temp. (°C)	Fluid Depth (cm)	Humid. (%)	Barom. Press. (kPa)
		IEEE Target	Measured	IEEE Target	Measured	IEEE Target	Measured						
03/02/04	Brain	13.1 $\pm 10\%$	13.4 (+2.3%)	39.2 $\pm 5\%$	37.4	1.80 $\pm 5\%$	1.89	1000	23.7	23.9	≥ 15	32	100.6

Note(s):

- The ambient and fluid temperatures were measured prior to, and during, the fluid dielectric parameter check and the system performance check. The temperatures listed in the table above were consistent for all measurement periods.

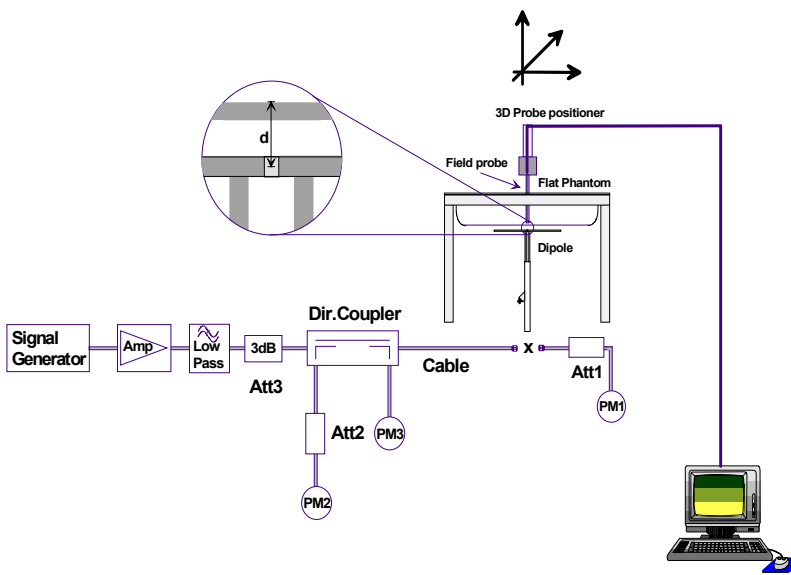

Figure 1. System Performance Check Setup Diagram



2450MHz Dipole Setup

8.0 SIMULATED EQUIVALENT TISSUES

The 2450MHz simulated tissue mixtures consist of Glycol-monobutyl, water, and salt (body mixture only). The fluids were prepared according to standardized procedures and measured for dielectric parameters (permittivity and conductivity).

SIMULATED TISSUE MIXTURES		
INGREDIENT	2450 MHz Brain	2450 MHz Body
	System Performance Check	DUT Evaluation
Water	52.00 %	69.98 %
Glycol Monobutyl	48.00 %	30.00 %
Salt	-	0.02 %

9.0 SAR SAFETY LIMITS

EXPOSURE LIMITS	SAR (W/kg)	
	(General Population / Uncontrolled Exposure Environment)	(Occupational / Controlled Exposure Environment)
Spatial Average (averaged over the whole body)	0.08	0.4
Spatial Peak (averaged over any 1 g of tissue)	1.60	8.0
Spatial Peak (hands/wrists/feet/ankles averaged over 10 g)	4.0	20.0

Notes:

1. Uncontrolled environments are defined as locations where there is potential exposure of individuals who have no knowledge or control of their potential exposure.
2. Controlled environments are defined as locations where there is potential exposure of individuals who have knowledge of their potential exposure and can exercise control over their exposure.

10.0 ROBOT SYSTEM SPECIFICATIONS

Specifications

POSITIONER: Stäubli Unimation Corp. Robot Model: RX60L
Repeatability: 0.02 mm
No. of axis: 6

Data Acquisition Electronic (DAE) System

Cell Controller

Processor: AMD Athlon XP 2400+
Clock Speed: 2.0 GHz
Operating System: Windows XP Professional

Data Converter

Features: Signal Amplifier, multiplexer, A/D converter, and control logic
Software: DASY4 software
Connecting Lines: Optical downlink for data and status info.
 Optical uplink for commands and clock

DASY4 Measurement Server

Function: Real-time data evaluation for field measurements and surface detection
Hardware: PC/104 166MHz Pentium CPU; 32 MB chipdisk; 64 MB RAM
Connections: COM1, COM2, DAE, Robot, Ethernet, Service Interface

E-Field Probe

Model: ET3DV6
Serial No.: 1590
Construction: Triangular core fiber optic detection system
Frequency: 10 MHz to 6 GHz
Linearity: ± 0.2 dB (30 MHz to 3 GHz)

Phantom(s)

Evaluation Phantom

Type: Planar Phantom
Shell Material: Fiberglass
Thickness: 2.0 \pm 0.1 mm
Volume: Approx. 72 liters

Validation Phantom

Type: SAM V4.0C
Shell Material: Fiberglass
Thickness: 2.0 \pm 0.1 mm
Volume: Approx. 20 liters

11.0 PROBE SPECIFICATION (ET3DV6)

Construction:	Symmetrical design with triangular core Built-in shielding against static charges PEEK enclosure material (resistant to organic solvents, e.g. glycol)
Calibration:	In air from 10 MHz to 2.5 GHz In brain simulating tissue at frequencies of 900 MHz and 1.8 GHz (accuracy $\pm 8\%$)
Frequency:	10 MHz to <6 GHz; Linearity: ± 0.2 dB (30 MHz to 3 GHz)
Directivity:	± 0.2 dB in brain tissue (rotation around probe axis) ± 0.4 dB in brain tissue (rotation normal to probe axis)
Dynamic Range:	5 μ W/g to <100 mW/g; Linearity: ± 0.2 dB
Surface. Detection:	± 0.2 mm repeatability in air and clear liquids over diffuse reflecting surfaces
Dimensions:	Overall length: 330 mm Tip length: 16 mm Body diameter: 12 mm Tip diameter: 6.8 mm Distance from probe tip to dipole centers: 2.7 mm
Application:	General dosimetry up to 3 GHz Compliance tests of mobile phone



ET3DV6 E-Field Probe

12.0 SAM PHANTOM V4.0C

The SAM phantom V4.0C is a fiberglass shell phantom with a 2.0 mm (± 0.2 mm) shell thickness for left and right head and flat planar area integrated in a wooden table. The shape of the fiberglass shell corresponds to the phantom defined by SCC34-SC2. The device holder positions are adjusted to the standard measurement positions in the three sections (see Appendix F for specifications of the SAM phantom V4.0C).

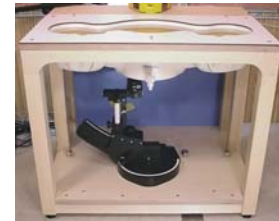

SAM Phantom

13.0 PLANAR PHANTOM

The planar phantom is a fiberglass shell phantom with a 2.0 mm (± 0.2 mm) thick device measurement area at the center of the phantom for SAR evaluations of devices with a larger surface area than the planar section of the SAM phantom. The planar phantom is integrated in a wooden table (see Appendix G for dimensions and specifications of the planar phantom).



Planar Phantom

14.0 DEVICE HOLDER

The DASY4 device holder has two scales for device rotation (with respect to the body axis) and the device inclination (with respect to the line between the ear openings). The plane between the ear openings and the mouth tip has a rotation angle of 65° . The bottom plate contains three pair of bolts for locking the device holder. The device holder positions are adjusted to the standard measurement positions in the three sections.



Device Holder

15.0 TEST EQUIPMENT LIST

TEST EQUIPMENT	SERIAL NO.	CALIBRATION DATE
Schmid & Partner DASY4 System	-	-
-DASY4 Measurement Server	1078	N/A
-Robot	599396-01	N/A
-DAE3	353	Dec 2003
-DAE3	370	May 2003
-ET3DV6 E-Field Probe	1387	Mar 2004
-ET3DV6 E-Field Probe	1590	May 2003
-300MHz Validation Dipole	135	Oct 2003
-450MHz Validation Dipole	136	Nov 2003
-835MHz Validation Dipole	411	Mar 2004
-900MHz Validation Dipole	054	June 2003
-1800MHz Validation Dipole	247	June 2003
-2450MHz Validation Dipole	150	Sept 2003
-SAM Phantom V4.0C	1033	N/A
-Barski Planar Phantom	03-01	N/A
-Plexiglas Planar Phantom	161	N/A
-Validation Planar Phantom	137	N/A
HP 85070C Dielectric Probe Kit	N/A	N/A
Gigatronics 8651A Power Meter	8650137	April 2003
Gigatronics 8652A Power Meter	1835267	April 2003
Gigatronics 80701A Power Sensor	1833535	April 2003
Gigatronics 80701A Power Sensor	1833542	April 2003
Gigatronics 80701A Power Sensor	1834350	April 2003
HP E4408B Spectrum Analyzer	US39240170	Dec 2003
HP 8594E Spectrum Analyzer	3543A02721	April 2003
HP 8753E Network Analyzer	US38433013	April 2003
HP 8648D Signal Generator	3847A00611	April 2003
Amplifier Research 5S1G4 Power Amplifier	26235	N/A

16.0 MEASUREMENT UNCERTAINTIES

UNCERTAINTY BUDGET FOR DEVICE EVALUATION						
Error Description	Uncertainty Value ±%	Probability Distribution	Divisor	C _i 1g	Standard Uncertainty ±% (1g)	v _i or v _{eff}
Measurement System						
Probe calibration	± 4.5	Normal	1	1	± 4.5	∞
Axial isotropy of the probe	± 4.7	Rectangular	√3	(1-c _p)	± 1.9	∞
Spherical isotropy of the probe	± 9.6	Rectangular	√3	(c _p)	± 3.9	∞
Spatial resolution	± 0.0	Rectangular	√3	1	± 0.0	∞
Boundary effects	± 5.5	Rectangular	√3	1	± 3.2	∞
Probe linearity	± 4.7	Rectangular	√3	1	± 2.7	∞
Detection limit	± 1.0	Rectangular	√3	1	± 0.6	∞
Readout electronics	± 1.0	Normal	1	1	± 1.0	∞
Response time	± 0.8	Rectangular	√3	1	± 0.5	∞
Integration time	± 1.4	Rectangular	√3	1	± 0.8	∞
RF ambient conditions	± 3.0	Rectangular	√3	1	± 1.7	∞
Mech. constraints of robot	± 0.4	Rectangular	√3	1	± 0.2	∞
Probe positioning	± 2.9	Rectangular	√3	1	± 1.7	∞
Extrapolation & integration	± 3.9	Rectangular	√3	1	± 2.3	∞
Test Sample Related						
Device positioning	± 6.0	Normal	√3	1	± 6.7	12
Device holder uncertainty	± 5.0	Normal	√3	1	± 5.9	8
Power drift	± 5.0	Rectangular	√3		± 2.9	∞
Phantom and Setup						
Phantom uncertainty	± 4.0	Rectangular	√3	1	± 2.3	∞
Liquid conductivity (target)	± 5.0	Rectangular	√3	0.6	± 1.7	∞
Liquid conductivity (measured)	± 5.0	Rectangular	√3	0.6	± 1.7	∞
Liquid permittivity (target)	± 5.0	Rectangular	√3	0.6	± 1.7	∞
Liquid permittivity (measured)	± 5.0	Rectangular	√3	0.6	± 1.7	∞
Combined Standard Uncertainty					± 13.2	
Expanded Uncertainty (k=2)					± 26.4	

Measurement Uncertainty Table in accordance with IEEE Standard 1528-2003 (see reference [5])

MEASUREMENT UNCERTAINTIES (Cont.)

UNCERTAINTY BUDGET FOR SYSTEM VALIDATION						
Error Description	Uncertainty Value ±%	Probability Distribution	Divisor	C _i 1g	Standard Uncertainty ±% (1g)	v _i or v _{eff}
Measurement System						
Probe calibration	± 4.5	Normal	1	1	± 4.5	∞
Axial isotropy of the probe	± 4.7	Rectangular	√3	(1-c _p)	± 1.9	∞
Spherical isotropy of the probe	± 9.6	Rectangular	√3	(c _p)	± 3.9	∞
Spatial resolution	± 0.0	Rectangular	√3	1	± 0.0	∞
Boundary effects	± 5.5	Rectangular	√3	1	± 3.2	∞
Probe linearity	± 4.7	Rectangular	√3	1	± 2.7	∞
Detection limit	± 1.0	Rectangular	√3	1	± 0.6	∞
Readout electronics	± 1.0	Normal	1	1	± 1.0	∞
Response time	± 0.8	Rectangular	√3	1	± 0.5	∞
Integration time	± 1.4	Rectangular	√3	1	± 0.8	∞
RF ambient conditions	± 3.0	Rectangular	√3	1	± 1.7	∞
Mech. constraints of robot	± 0.4	Rectangular	√3	1	± 0.2	∞
Probe positioning	± 2.9	Rectangular	√3	1	± 1.7	∞
Extrapolation & integration	± 3.9	Rectangular	√3	1	± 2.3	∞
Dipole						
Dipole Axis to Liquid Distance	± 2.0	Rectangular	√3	1	± 1.2	∞
Input Power	± 4.7	Rectangular	√3	1	± 2.7	∞
Phantom and Setup						
Phantom uncertainty	± 4.0	Rectangular	√3	1	± 2.3	∞
Liquid conductivity (target)	± 5.0	Rectangular	√3	0.6	± 1.7	∞
Liquid conductivity (measured)	± 5.0	Rectangular	√3	0.6	± 1.7	∞
Liquid permittivity (target)	± 5.0	Rectangular	√3	0.6	± 1.7	∞
Liquid permittivity (measured)	± 5.0	Rectangular	√3	0.6	± 1.7	∞
Combined Standard Uncertainty					± 9.8	
Expanded Uncertainty (k=2)					± 19.6	

Measurement Uncertainty Table in accordance with IEEE Standard 1528-2003 (see reference [5])

Test Report S/N:	021104-474KBC
Test Date(s):	March 02, 2004
Test Type:	FCC/IC SAR Evaluation

17.0 REFERENCES

- [1] Federal Communications Commission, "Radiofrequency radiation exposure evaluation: portable devices", Rule Part 47 CFR §2.1093: 1999.
- [2] Health Canada, "Limits of Human Exposure to Radiofrequency Electromagnetic Fields in the Frequency Range from 3 kHz to 300 GHz", Safety Code 6.
- [3] Federal Communications Commission, "Evaluating Compliance with FCC Guidelines for Human Exposure to Radio frequency Electromagnetic Fields", OET Bulletin 65, Supplement C (Edition 01-01), FCC, Washington, D.C.: June 2001.
- [4] Industry Canada, "Evaluation Procedure for Mobile and Portable Radio Transmitters with respect to Health Canada's Safety Code 6 for Exposure of Humans to Radio Frequency Fields", Radio Standards Specification RSS-102 Issue 1 (Provisional): September 1999.
- [5] IEEE Standard 1528-2003, "Recommended Practice for Determining the Peak Spatial-Average Specific Absorption Rate (SAR) in the Human Head from Wireless Communications Devices: Measurement Techniques".

Test Report S/N:	021104-474KBC
Test Date(s):	March 02, 2004
Test Type:	FCC/IC SAR Evaluation

APPENDIX A - SAR MEASUREMENT DATA

Body-Worn SAR - 802.11b Transmit - Front Side of DUT (802.11b Antenna Side)

Date Tested: 03/02/04

DUT: Itronix; Model: IX100XA555WLBT; Type: Rugged Handheld PC with 802.11b/Bluetooth; Serial: 510495001-U5103-0025
 Body-Worn Accessories: Nylon Carry-Case (P/N: 54-0644-001), Ear-Microphone (Model: JABRA)

Ambient Temp: 24.1 °C; Fluid Temp: 23.8 °C; Barometric Pressure: 101.9 kPa; Humidity: 30%

7.4V, 3.0Ah Li-ion Battery Pack
 Communication System: DSSS
 Frequency: 2437 MHz; Duty Cycle: 1:1
 RF Output Power: 14.0 dBm (Peak Conducted)
 Medium: M2450 ($\sigma = 2.01$ mho/m; $\epsilon_r = 50.5$; $\rho = 1000$ kg/m³)
 - Probe: ET3DV6 - SN1590; ConvF(4.4, 4.4, 4.4); Calibrated: 15/05/2003
 - Sensor-Surface: 4mm (Mechanical Surface Detection)
 - Electronics: DAE3 Sn353; Calibrated: 19/12/2003
 - Phantom: Barski Planar; Type: Fiberglass; S/N: 03-01
 - Measurement SW: DASy4, V4.2 Build 12; Postprocessing SW: SEMCAD, V1.8 Build 94

Body-Worn - 802.11b - Front Side of DUT & Carry Case - 0.0 cm Separation Distance - Mid Channel

Area Scan (10x22x1): Measurement grid: dx=15mm, dy=15mm

Body-Worn - 802.11b - Front Side of DUT & Carry Case - 0.0 cm Separation Distance - Mid Channel

Zoom Scan (7x7x7)/Cube 0: Measurement grid: dx=5mm, dy=5mm, dz=5mm

Peak SAR (extrapolated) = 0.070 W/kg

SAR(1 g) = 0.035 mW/g; SAR(10 g) = 0.020 mW/g

Reference Value = 4.37 V/m

Power Drift = -0.193 dB

Body-Worn - 802.11b - Front Side of DUT & Carry Case - 0.0 cm Separation Distance - Mid Channel

Zoom Scan (7x7x7)/Cube 1: Measurement grid: dx=5mm, dy=5mm, dz=5mm

Peak SAR (extrapolated) = 0.054 W/kg

SAR(1 g) = 0.028 mW/g; SAR(10 g) = 0.017 mW/g

Reference Value = 4.37 V/m

Power Drift = -0.193 dB

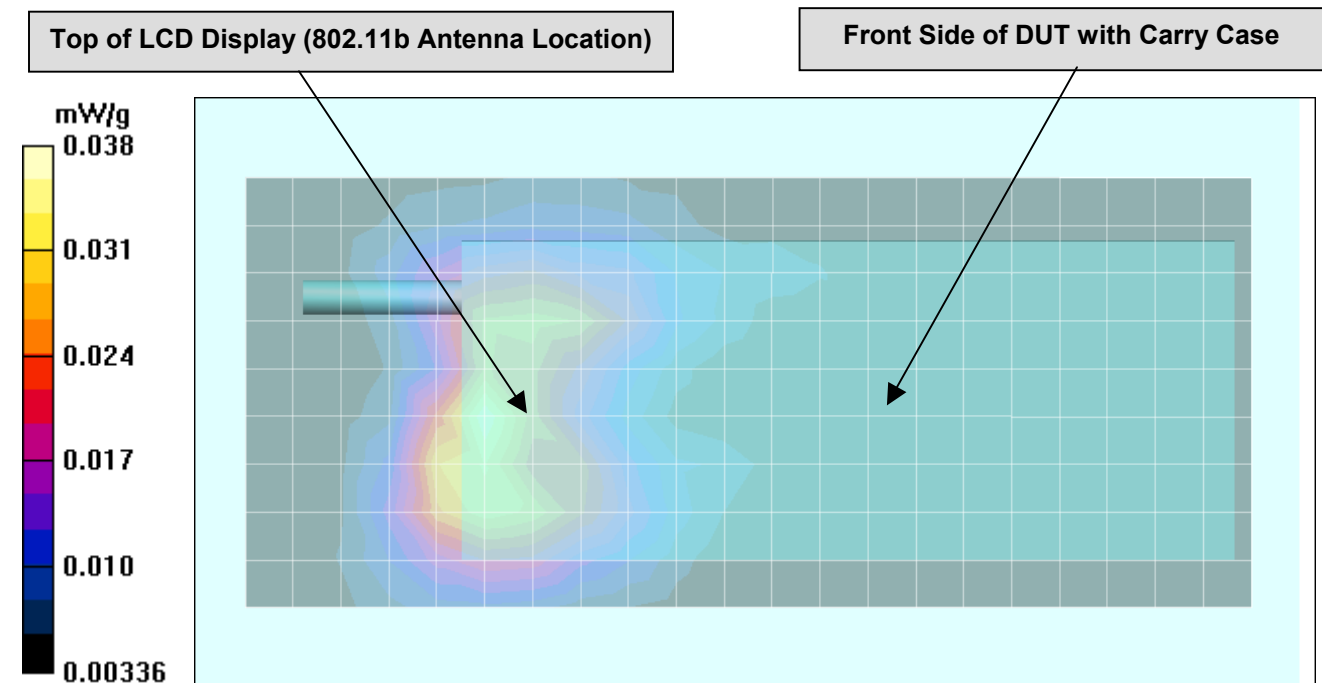

Body-Worn SAR - 802.11b & Bluetooth Transmit - Front Side of DUT (Antenna Side)

Date Tested: 03/02/04

DUT: Itronix; Model: IX100XA555WLBT; Type: Rugged Handheld PC with 802.11b/Bluetooth; Serial: 510495001-U5103-0025
 Body-Worn Accessories: Nylon Carry Case (P/N: 54-0644-001), Ear-Microphone (Model: JABRA)

Ambient Temp: 24.1 °C; Fluid Temp: 23.8 °C; Barometric Pressure: 101.9 kPa; Humidity: 30%
 Lithium-ion 7.4V 3.0 Ah Battery
 Communication System: DSSS (802.11b)
 Communication System: Modulated Fixed Frequency (Bluetooth)
 Frequency: 2437 MHz; Duty Cycle: 1:1 (802.11b)
 Frequency: 2441 MHz; Duty Cycle: 1:1 (Bluetooth)
 RF Output Power: 14.0 dBm (Peak Conducted) 802.11b
 RF Output Power: 3.5 dBm (Peak Conducted) Bluetooth
 Medium: M2450 ($\sigma = 2.01$ mho/m; $\epsilon_r = 50.5$; $\rho = 1000$ kg/m³)
 - Probe: ET3DV6 - SN1590; ConvF(4.4, 4.4, 4.4); Calibrated: 15/05/2003
 - Sensor-Surface: 4mm (Mechanical Surface Detection)
 - Electronics: DAE3 Sn353; Calibrated: 19/12/2003
 - Phantom: Barski Planar; Type: Fibreglas; S/N: 03-01
 - Measurement SW: DASY4, V4.2 Build 12; Postprocessing SW: SEMCAD, V1.8 Build 94

Body-Worn - 802.11b & Bluetooth - Front Side of DUT & Carry Case - 0.0 cm Separation Distance - Mid Channel Area Scan (10x22x1): Measurement grid: dx=15mm, dy=15mm

Body-Worn - 802.11b & Bluetooth - Front Side of DUT & Carry Case - 0.0 cm Separation Distance - Mid Channel Zoom Scan (7x7x7)/Cube 0: Measurement grid: dx=5mm, dy=5mm, dz=5mm

Reference Value = 5.24 V/m; Power Drift = -0.0318 dB
 Peak SAR (extrapolated) = 0.116 W/kg

SAR(1 g) = 0.053 mW/g; SAR(10 g) = 0.029 mW/g

Body-Worn - 802.11b & Bluetooth - Front Side of DUT & Carry Case - 0.0 cm Separation Distance - Mid Channel Zoom Scan (7x7x7)/Cube 1: Measurement grid: dx=5mm, dy=5mm, dz=5mm

Reference Value = 5.24 V/m; Power Drift = -0.0318 dB
 Peak SAR (extrapolated) = 0.081 W/kg

SAR(1 g) = 0.038 mW/g; SAR(10 g) = 0.022 mW/g

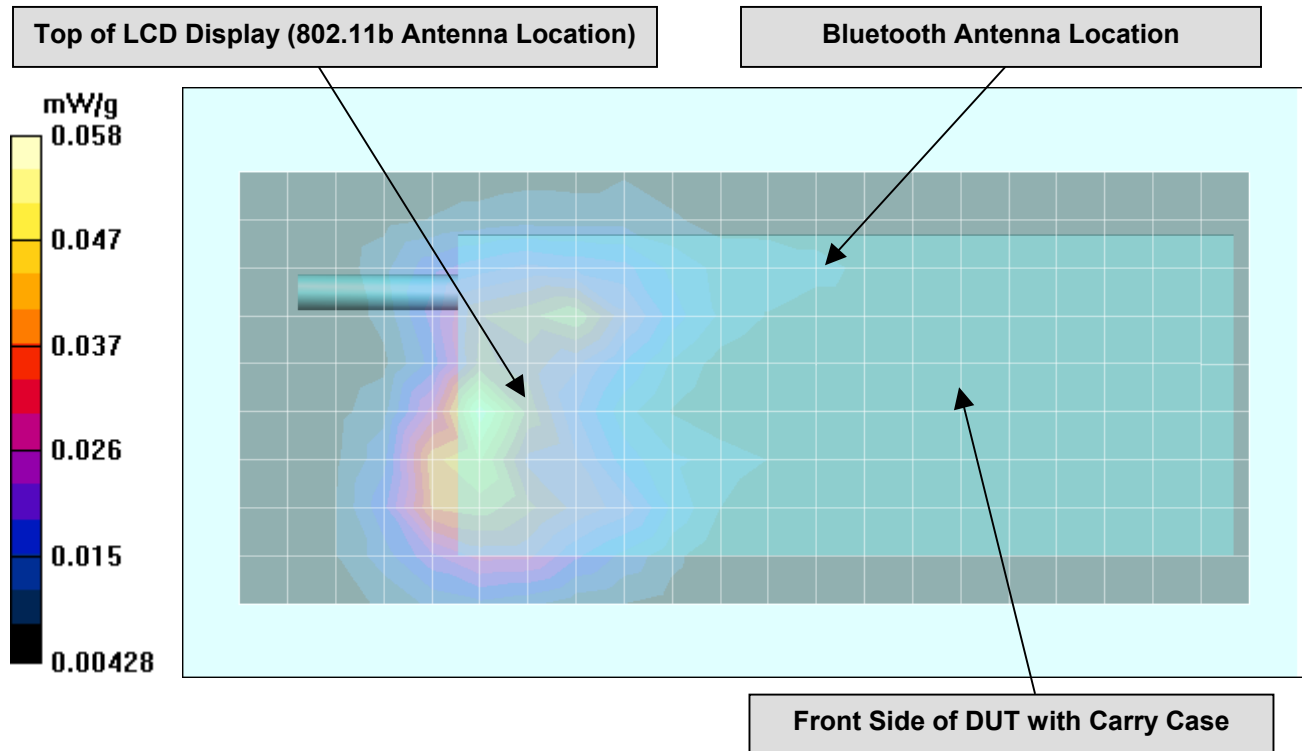

Z-Axis Scan

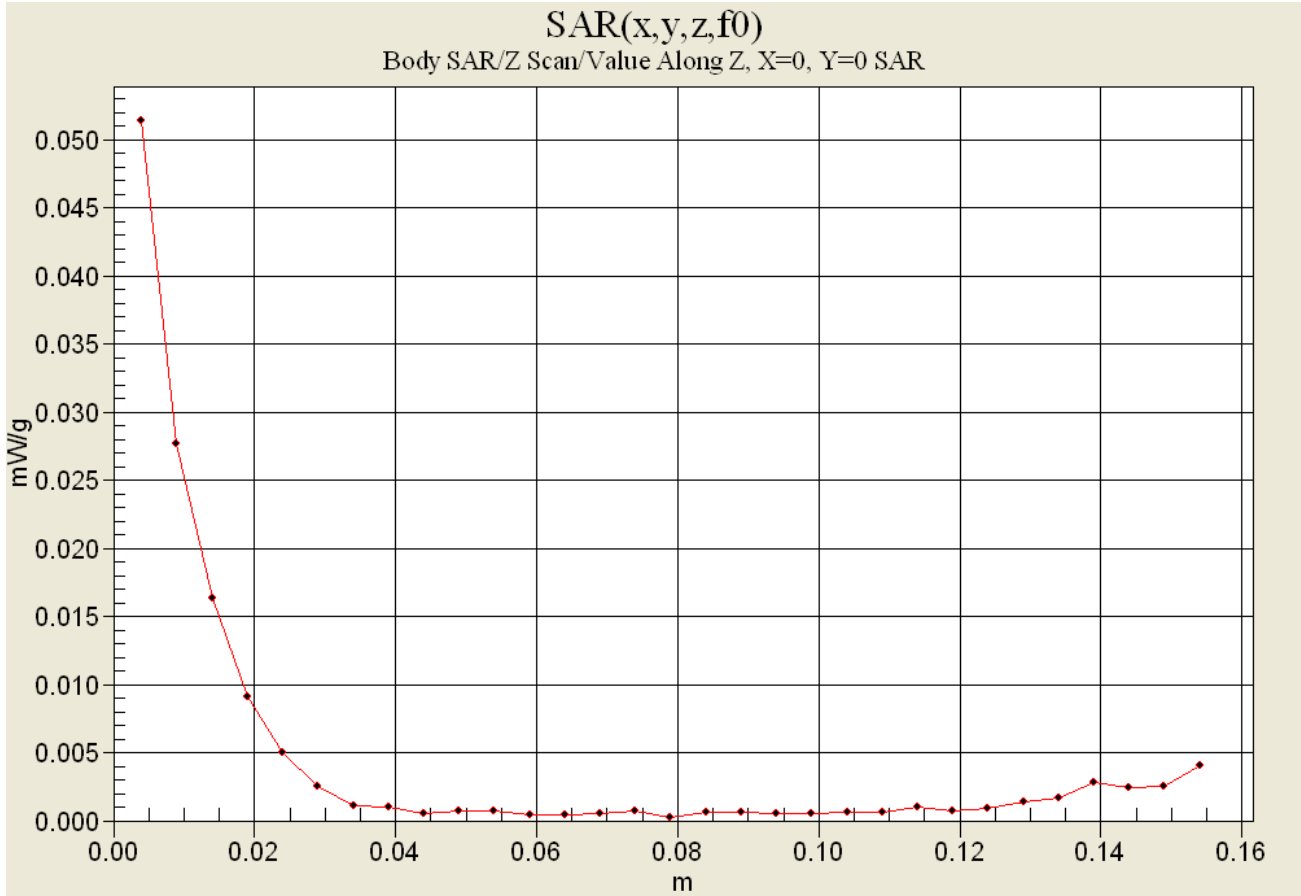

Test Report S/N:	021104-474KBC
Test Date(s):	March 02, 2004
Test Type:	FCC/IC SAR Evaluation

APPENDIX B - SYSTEM PERFORMANCE CHECK DATA

System Performance Check - 2450 MHz Dipole

Date Tested: 03/02/04

DUT: Dipole 2450 MHz; Model: D2450V2; Type: System Performance Check Serial: 150

Ambient Temp: 23.7 °C; Fluid Temp: 23.9 °C; Barometric Pressure: 100.6 kPa; Humidity: 32%

Communication System: CW
 Forward Conducted Power: 250mW
 Frequency: 2450 MHz; Duty Cycle: 1:1
 Medium: HSL2450 ($\sigma = 1.89 \text{ mho/m}$; $\epsilon_r = 37.4$; $\rho = 1000 \text{ kg/m}^3$)

- Probe: ET3DV6 - SN1590; ConvF(5, 5, 5); Calibrated: 15/05/2003
- Sensor-Surface: 4mm (Mechanical And Optical Surface Detection)
- Electronics: DAE3 Sn353; Calibrated: 19/12/2003
- Phantom: SAM 4.0; Type: Fiberglas; Serial: 1033
- Measurement SW: DASY4, V4.2 Build 37; Postprocessing SW: SEMCAD, V1.8 Build 109

2450 MHz System Performance Check/Area Scan (6x10x1):

Measurement grid: dx=10mm, dy=10mm

2450 MHz System Performance Check/Zoom Scan (7x7x7)/Cube 0:

Measurement grid: dx=5mm, dy=5mm, dz=5mm

Peak SAR (extrapolated) = 28.1 W/kg

SAR(1 g) = 13.4 mW/g; SAR(10 g) = 6.25 mW/g

Reference Value = 91.5 V/m

Power Drift = -0.0 dB

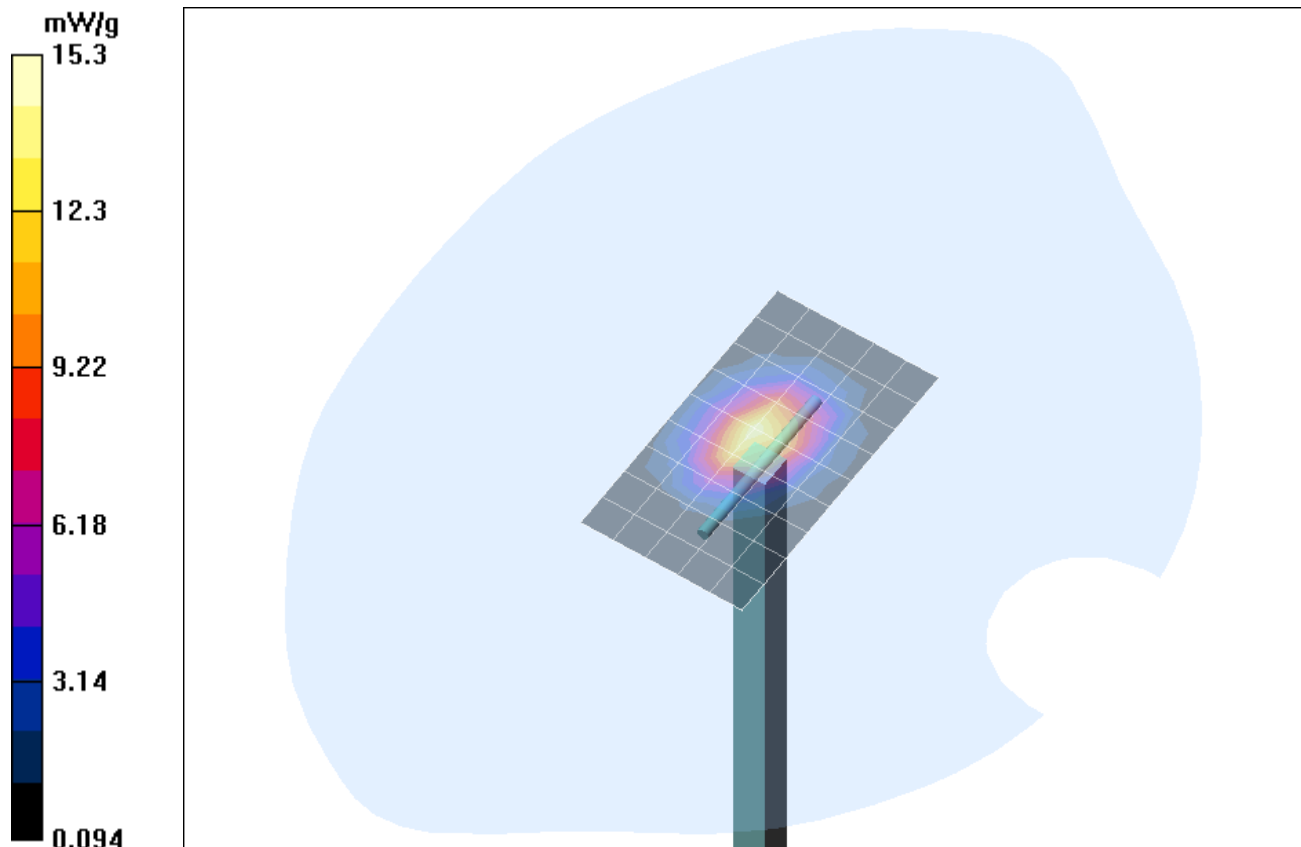

Z-Axis Scan

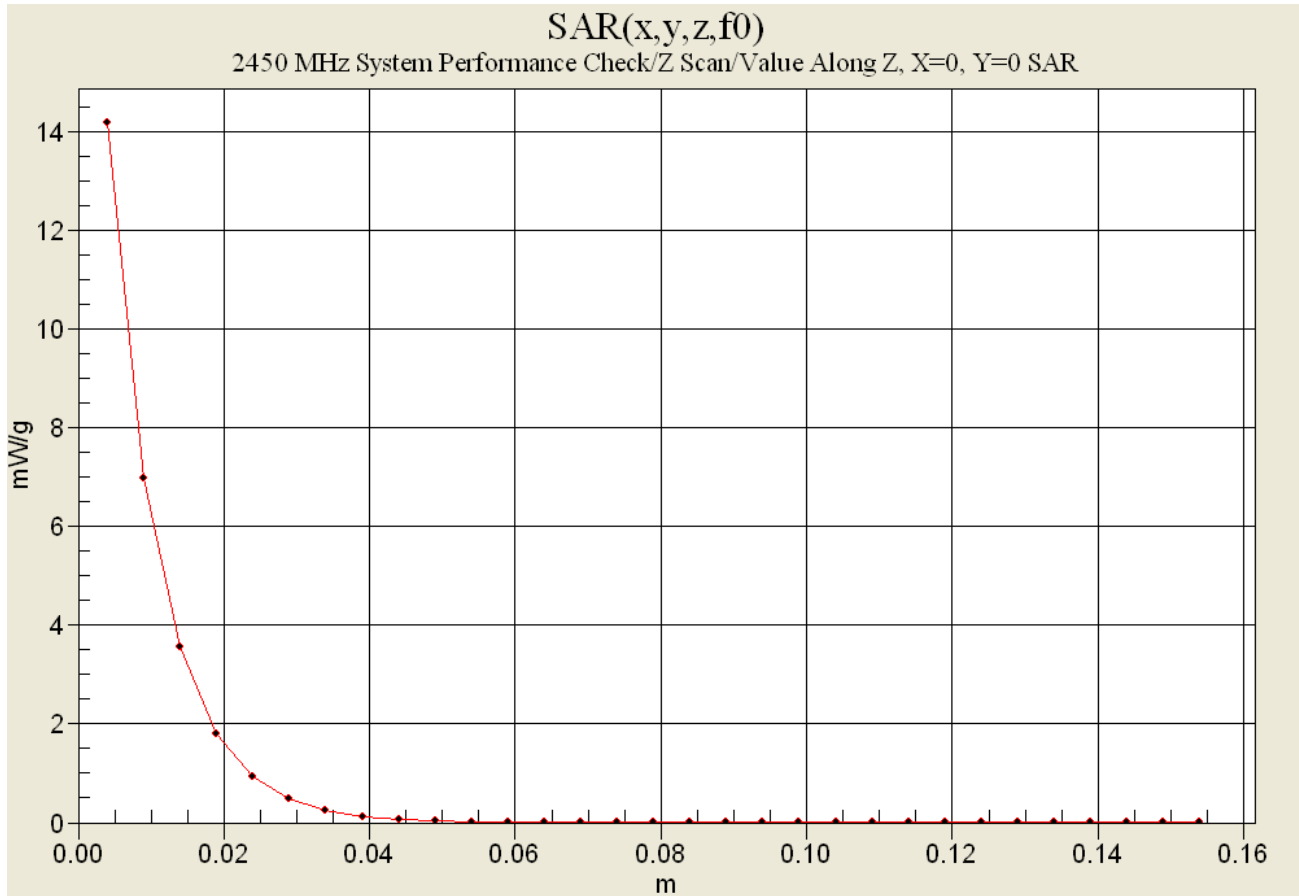

Test Report S/N:	021104-474KBC
Test Date(s):	March 02, 2004
Test Type:	FCC/IC SAR Evaluation

APPENDIX C - SYSTEM VALIDATION

2450MHz SYSTEM VALIDATION DIPOLE

Type:

2450MHz Validation Dipole

Serial Number:

150

Place of Calibration:

Celltech Labs Inc.

Date of Calibration:

September 17, 2003

Celltech Labs Inc. hereby certifies that this device has been calibrated on the date indicated above.

Calibrated by:

Spencer Watson

Approved by:

Russell W. Pipe

1. Dipole Construction & Electrical Characteristics

The validation dipole was constructed in accordance with the IEEE Std “Recommended Practice for Determining the Spatial-Peak Specific Absorption Rate (SAR) in the Human Body Due to Wireless Communications Devices: Experimental Techniques”. The electrical properties were measured using an HP 8753E Network Analyzer. The network analyzer was calibrated to the validation dipole N-type connector feed point using an HP85032E Type N calibration kit. The dipole was placed parallel to a planar phantom at a separation distance of 10.0mm from the simulating fluid using a loss-less dielectric spacer. The measured input impedance is:

Feed point impedance at 2450MHz	$\text{Re}\{Z\} = 44.488\Omega$ $\text{Im}\{Z\} = -2.4883\Omega$
Return Loss at 2450MHz	-25.322 dB

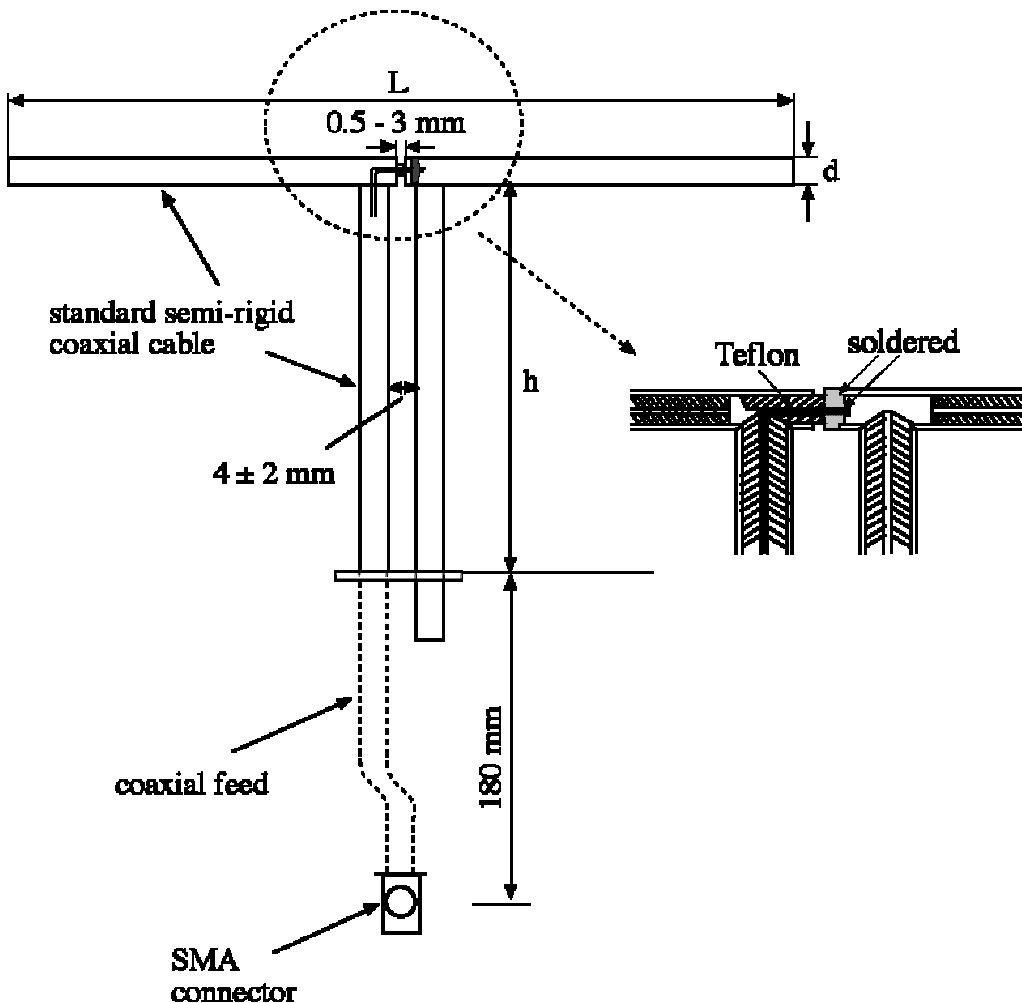

17 Sep 2003 11:17:40

CH1 S11 1 U FS

1: 44.488 Ω -2.4883 Ω 26.107 pF

2 450.000 000 MHz

PRm

MARKER 1
2.45 GHz

Cor

↑

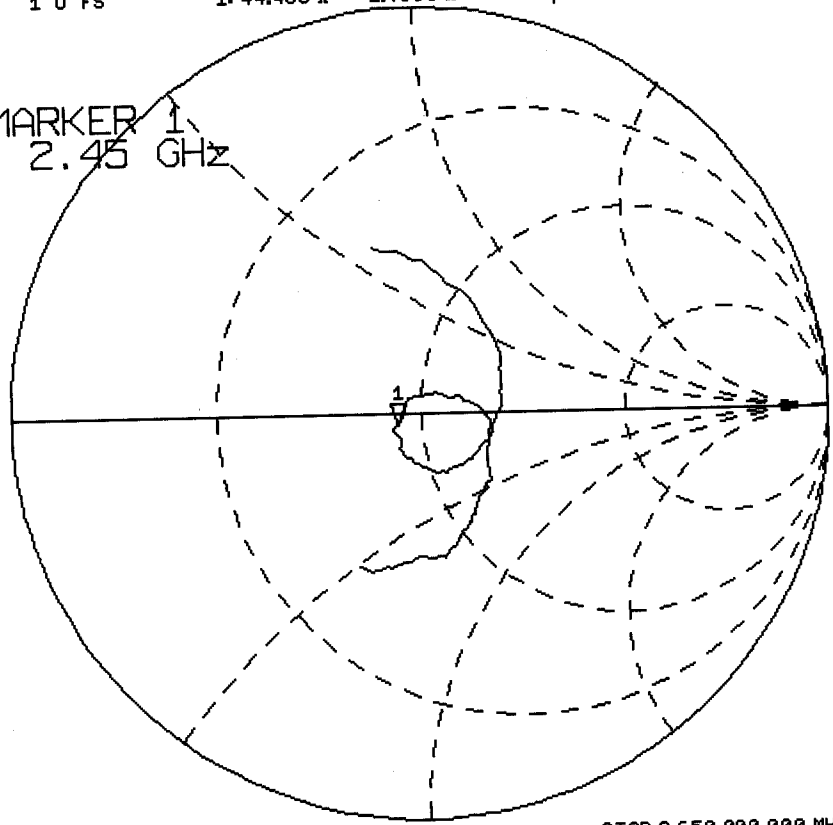

START 2 250.000 000 MHz

STOP 2 650.000 000 MHz

17 Sep 2003 11:16:48

CH1 S11 LOG 10 dB/REF 0 dB

1:-25.322 dB 2 450.000 000 MHz

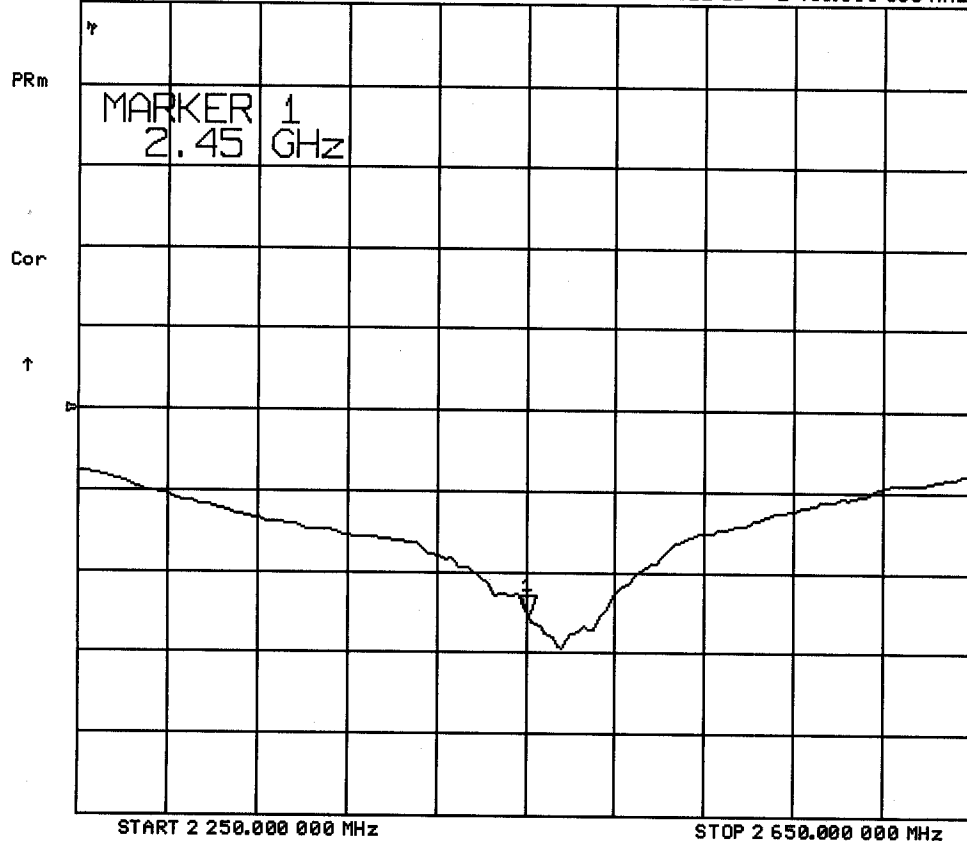

Validation Dipole Dimensions

Frequency (MHz)	L (mm)	h (mm)	d (mm)
300	420.0	250.0	6.2
450	288.0	167.0	6.2
835	161.0	89.8	3.6
900	149.0	83.3	3.6
1450	89.1	51.7	3.6
1800	72.0	41.7	3.6
1900	68.0	39.5	3.6
2000	64.5	37.5	3.6
2450	51.8	30.6	3.6
3000	41.5	25.0	3.6

2. Validation Phantom

The validation phantom is the SAM (Specific Anthropomorphic Mannequin) phantom manufactured by Schmid & Partner Engineering AG. The SAM phantom is a Fiberglass shell integrated in a wooden table. The shape of the shell corresponds to the phantom defined by SCC34-SC2. It enables the dosimetric evaluation of left and right hand phone usage as well as body mounted usage at the flat phantom region. A cover prevents evaporation of the liquid. Reference markings on the phantom allow the complete setup of all predefined phantom positions and measurement grids by manually teaching three points in the robot.

Shell Thickness: 2.0 ± 0.1 mm
Filling Volume: Approx. 20 liters
Dimensions: 50 cm (W) x 100 cm (L)

2450MHz Dipole Calibration



2450MHz Dipole Calibration



3. Measurement Conditions

The planar phantom was filled with brain simulating tissue having the following electrical parameters at 2450MHz:

Relative Permittivity:	37.3
Conductivity:	1.88 mho/m
Ambient Temperature:	21.6°C
Fluid Temperature:	23.9°C
Fluid Depth:	≥ 15cm

The 2450MHz simulating tissue consists of the following ingredients:

Ingredient	Percentage by weight
Water	52.00%
Glycol Monobutyl	48.00%
Target Dielectric Parameters at 22°C	$\epsilon_r = 39.2 (+/-5\%)$ $\sigma = 1.80 \text{ S/m } (+/-5\%)$

4. SAR Measurement

The SAR measurement was performed with the E-field probe in mechanical detection mode only. The setup and determination of the forward power into the dipole was performed using the following procedures.

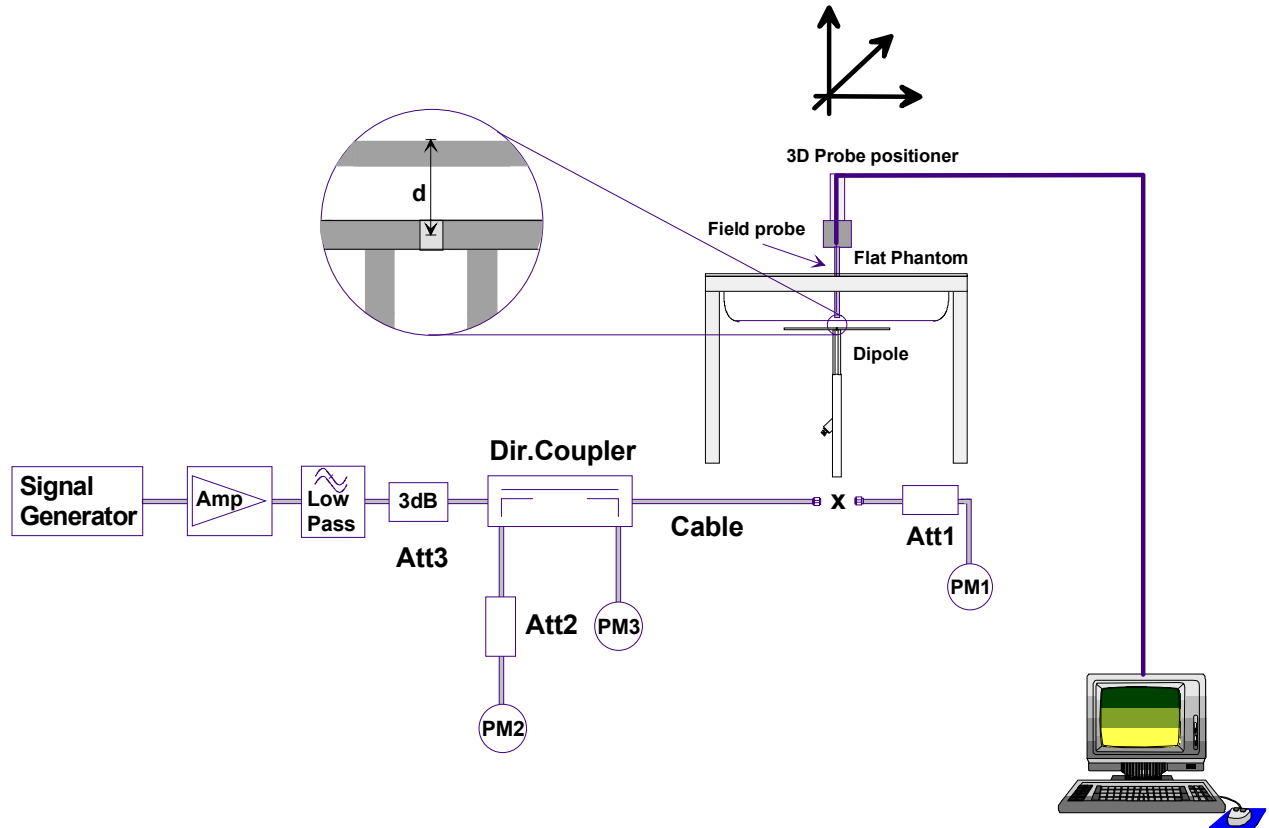

First, the power meter PM1 (including attenuator Att1) is connected to the cable to measure the forward power at the location of the dipole connector (X). The signal generator is adjusted for the desired forward power at the dipole connector (taking into account the attenuation of Att1) as read by power meter PM2. After connecting the cable to the dipole, the signal generator is readjusted for the same reading at power meter PM2. If the signal generator does not allow adjustment in 0.01dB steps, the remaining difference at PM2 must be taken into consideration. PM3 records the reflected power from the dipole to ensure that the value is not changed from the previous value. The reflected power should be 20dB below the forward power.

Ten SAR measurements were performed in order to achieve repeatability and to establish an average target value.

Validation Dipole SAR Test Results

Validation Measurement	SAR @ 0.25W Input averaged over 1g	SAR @ 1W Input averaged over 1g	SAR @ 0.25W Input averaged over 10g	SAR @ 1W Input averaged over 10g	Peak SAR @ 0.25W Input
Test 1	13.9	55.6	6.27	25.08	29.5
Test 2	13.9	55.6	6.25	25.00	29.1
Test 3	13.9	55.6	6.24	24.96	28.9
Test 4	14.0	56.0	6.31	25.24	29.1
Test 5	14.0	56.0	6.27	25.08	29.7
Test 6	13.8	55.2	6.25	25.00	29.3
Test 7	13.9	55.6	6.22	24.88	29.3
Test 8	13.9	55.6	6.24	24.96	29.4
Test 9	14.0	56.0	6.29	25.16	30.0
Test10	13.8	55.2	6.17	24.68	29.3
Average Value	13.91	55.64	6.251	25.00	29.36

The results have been normalized to 1W (forward power) into the dipole.

Averaged over 1cm (1g) of tissue: 55.64 mW/g

Averaged over 10cm (10g) of tissue: 25.00 mW/g

Test Date: 09/17/03

DUT: Dipole 2450 MHz; Type: D2450V2; Serial: D2450V2 - SN:150

Ambient Temp: 22.2C; Fluid Temp: 23.8C
Barometric Pressure: 101.9 kPa; Humidity: 52%

Communication System: CW
Frequency: 2450 MHz; Duty Cycle: 1:1
Medium: HSL2450 ($\sigma = 1.88$ mho/m, $\epsilon_r = 37.3$, $\rho = 1000$ kg/m³)

- Probe: ET3DV6 - SN1387; ConvF(5, 5, 5); Calibrated: 26/02/2003
- Sensor-Surface: 4mm (Mechanical And Optical Surface Detection)
- Electronics: DAE3 Sn370; Calibrated: 19/05/2003
- Phantom: SAM front; Type: SAM 4.0; Serial: 1033
- Measurement SW: DASY4, V4.1 Build 47; Postprocessing SW: SEMCAD, V1.6 Build 116

Probe SN1387 Validation at 2450 MHz/Area Scan (6x10x1): Measurement grid: dx=10mm, dy=10mm

Probe SN1387 Validation at 2450 MHz/Zoom Scan (7x7x7)/Cube 0: Measurement grid: dx=5mm, dy=5mm, dz=5mm
Peak SAR (extrapolated) = 29.5 W/kg
SAR(1 g) = 13.9 mW/g; SAR(10 g) = 6.27 mW/g
Reference Value = 96.7 V/m
Power Drift = -0.08 dB

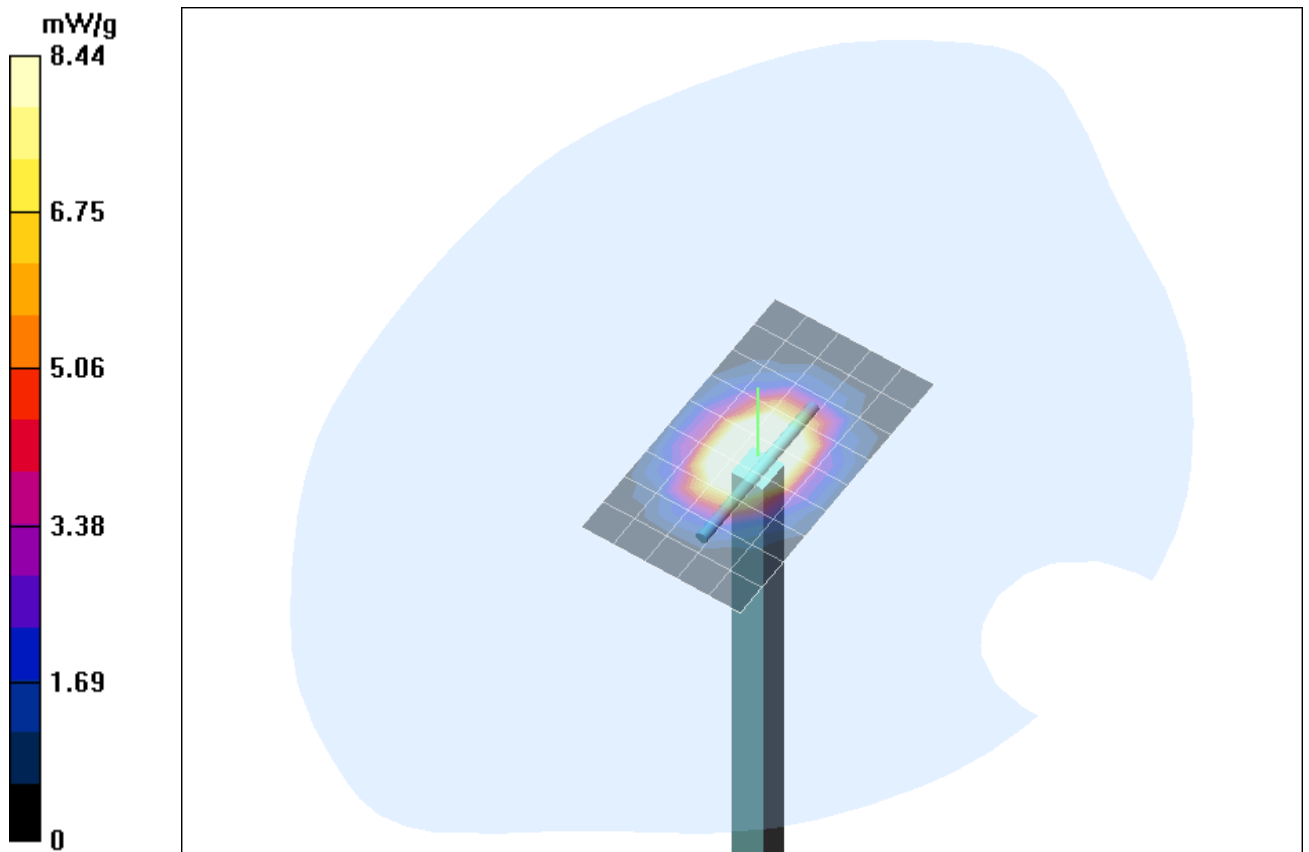

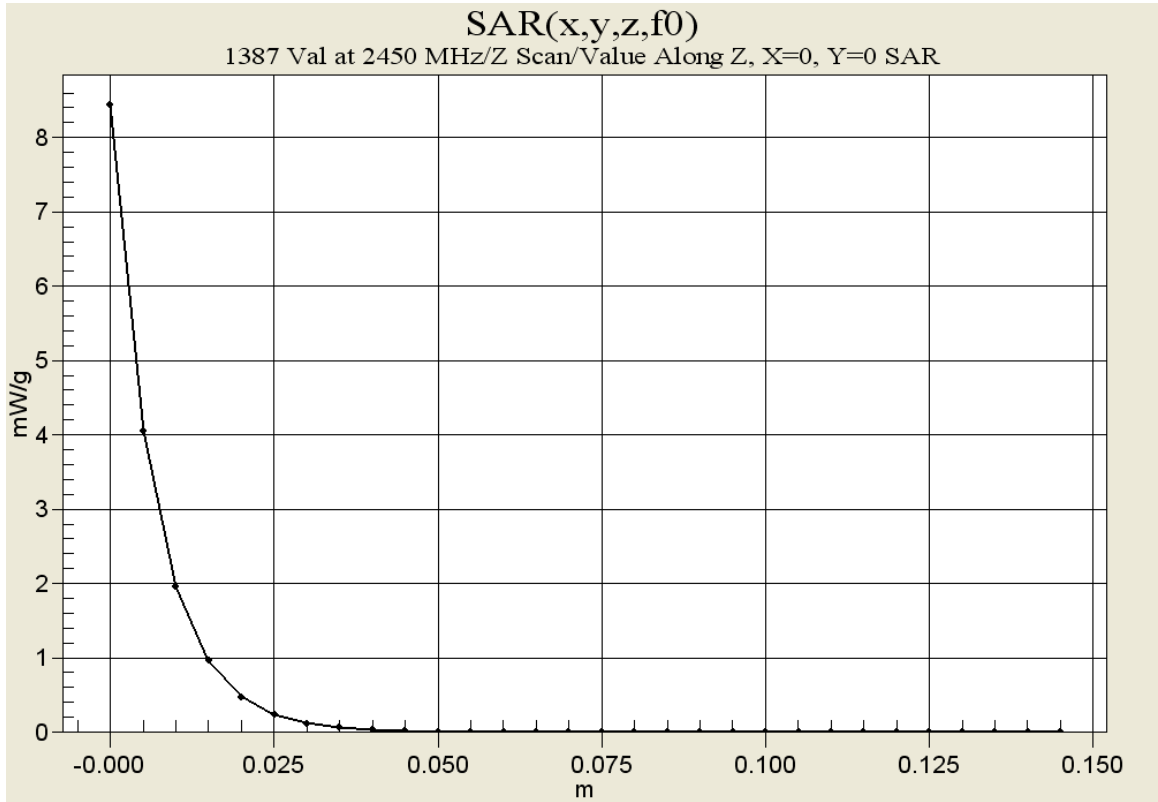

2450MHz System Validation

Measured Fluid Dielectric Parameters (Brain)



September 17, 2003

Frequency	ϵ'	ϵ''
2.350000000 GHz	37.7457	13.5170
2.360000000 GHz	37.7101	13.5534
2.370000000 GHz	37.6951	13.5903
2.380000000 GHz	37.6613	13.6228
2.390000000 GHz	37.6411	13.6368
2.400000000 GHz	37.5853	13.6598
2.410000000 GHz	37.5236	13.6742
2.420000000 GHz	37.4573	13.7091
2.430000000 GHz	37.4063	13.7484
2.440000000 GHz	37.3419	13.7798
2.450000000 GHz	37.2875	13.8226
2.460000000 GHz	37.2447	13.8618
2.470000000 GHz	37.2198	13.8951
2.480000000 GHz	37.1940	13.9293
2.490000000 GHz	37.1679	13.9423
2.500000000 GHz	37.1333	13.9571
2.510000000 GHz	37.0990	13.9745
2.520000000 GHz	37.0410	14.0116
2.530000000 GHz	36.9938	14.0375
2.540000000 GHz	36.9185	14.0546
2.550000000 GHz	36.8657	14.0912

Test Report S/N:	021104-474KBC
Test Date(s):	March 02, 2004
Test Type:	FCC/IC SAR Evaluation

APPENDIX D - PROBE CALIBRATION

Client **Celltech Labs**

CALIBRATION CERTIFICATE																															
Object(s)	ET3DV6 - SN:1590																														
Calibration procedure(s)	QA CAL-01.v2 Calibration procedure for dosimetric E-field probes																														
Calibration date:	May 15, 2003																														
Condition of the calibrated item	In Tolerance (according to the specific calibration document)																														
<p>This calibration statement documents traceability of M&TE used in the calibration procedures and conformity of the procedures with the ISO/IEC 17025 international standard.</p> <p>All calibrations have been conducted in the closed laboratory facility: environment temperature 22 +/- 2 degrees Celsius and humidity < 75%.</p> <p>Calibration Equipment used (M&TE critical for calibration)</p> <table border="1"> <thead> <tr> <th>Model Type</th> <th>ID #</th> <th>Cal Date (Calibrated by, Certificate No.)</th> <th>Scheduled Calibration</th> </tr> </thead> <tbody> <tr> <td>RF generator HP 8684C</td> <td>US3642U01700</td> <td>4-Aug-99 (SPEAG, in house check Aug-02)</td> <td>In house check: Aug-05</td> </tr> <tr> <td>Power sensor E4412A</td> <td>MY41495277</td> <td>2-Apr-03 (METAS, No 252-0250)</td> <td>Apr-04</td> </tr> <tr> <td>Power sensor HP 8481A</td> <td>MY41092180</td> <td>18-Sep-02 (Agilent, No. 20020918)</td> <td>Sep-03</td> </tr> <tr> <td>Power meter EPM E4419B</td> <td>GB41293874</td> <td>2-Apr-03 (METAS, No 252-0250)</td> <td>Apr-04</td> </tr> <tr> <td>Network Analyzer HP 8753E</td> <td>US38432426</td> <td>3-May-00 (Agilent, No. 8702K094602)</td> <td>In house check: May 03</td> </tr> <tr> <td>Fluke Process Calibrator Type 702</td> <td>SN: 6295803</td> <td>3-Sep-01 (ELCAL, No.2360)</td> <td>Sep-03</td> </tr> </tbody> </table>				Model Type	ID #	Cal Date (Calibrated by, Certificate No.)	Scheduled Calibration	RF generator HP 8684C	US3642U01700	4-Aug-99 (SPEAG, in house check Aug-02)	In house check: Aug-05	Power sensor E4412A	MY41495277	2-Apr-03 (METAS, No 252-0250)	Apr-04	Power sensor HP 8481A	MY41092180	18-Sep-02 (Agilent, No. 20020918)	Sep-03	Power meter EPM E4419B	GB41293874	2-Apr-03 (METAS, No 252-0250)	Apr-04	Network Analyzer HP 8753E	US38432426	3-May-00 (Agilent, No. 8702K094602)	In house check: May 03	Fluke Process Calibrator Type 702	SN: 6295803	3-Sep-01 (ELCAL, No.2360)	Sep-03
Model Type	ID #	Cal Date (Calibrated by, Certificate No.)	Scheduled Calibration																												
RF generator HP 8684C	US3642U01700	4-Aug-99 (SPEAG, in house check Aug-02)	In house check: Aug-05																												
Power sensor E4412A	MY41495277	2-Apr-03 (METAS, No 252-0250)	Apr-04																												
Power sensor HP 8481A	MY41092180	18-Sep-02 (Agilent, No. 20020918)	Sep-03																												
Power meter EPM E4419B	GB41293874	2-Apr-03 (METAS, No 252-0250)	Apr-04																												
Network Analyzer HP 8753E	US38432426	3-May-00 (Agilent, No. 8702K094602)	In house check: May 03																												
Fluke Process Calibrator Type 702	SN: 6295803	3-Sep-01 (ELCAL, No.2360)	Sep-03																												
Calibrated by:	Name Nicola Verberl	Function Technician	Signature 																												
Approved by:	Name Katja Polovic	Function Laboratory Director	Signature 																												
Date issued: May 15, 2003																															
<p>This calibration certificate is issued as an intermediate solution until the accreditation process (based on ISO/IEC 17025 International Standard) for Calibration Laboratory of Schmid & Partner Engineering AG is completed.</p>																															

Probe ET3DV6

SN:1590

Manufactured:	March 19, 2001
Last calibration:	April 26, 2002
Recalibrated:	May 15, 2003

Calibrated for DASY Systems

(Note: non-compatible with DASY2 system!)

DASY - Parameters of Probe: ET3DV6 SN:1590**Sensitivity in Free Space**

NormX	1.76 $\mu\text{V}/(\text{V}/\text{m})^2$
NormY	1.91 $\mu\text{V}/(\text{V}/\text{m})^2$
NormZ	1.66 $\mu\text{V}/(\text{V}/\text{m})^2$

Diode Compression

DCP X	92	mV
DCP Y	92	mV
DCP Z	92	mV

Sensitivity in Tissue Simulating Liquid

Head 900 MHz $\epsilon_r = 41.5 \pm 5\%$ $\sigma = 0.97 \pm 5\%$ mho/m

Valid for f=800-1000 MHz with Head Tissue Simulating Liquid according to EN 50361, P1528-200X

ConvF X	7.0 $\pm 9.5\%$ (k=2)	Boundary effect:
ConvF Y	7.0 $\pm 9.5\%$ (k=2)	Alpha 0.33
ConvF Z	7.0 $\pm 9.5\%$ (k=2)	Depth 2.56

Head 1800 MHz $\epsilon_r = 40.0 \pm 5\%$ $\sigma = 1.40 \pm 5\%$ mho/m

Valid for f=1710-1910 MHz with Head Tissue Simulating Liquid according to EN 50361, P1528-200X

ConvF X	5.5 $\pm 9.5\%$ (k=2)	Boundary effect:
ConvF Y	5.5 $\pm 9.5\%$ (k=2)	Alpha 0.44
ConvF Z	5.5 $\pm 9.5\%$ (k=2)	Depth 2.69

Boundary Effect

Head 900 MHz Typical SAR gradient: 5 % per mm

Probe Tip to Boundary		1 mm	2 mm
SAR _{be} [%]	Without Correction Algorithm	8.7	5.0
SAR _{be} [%]	With Correction Algorithm	0.3	0.5

Head 1800 MHz Typical SAR gradient: 10 % per mm

Probe Tip to Boundary		1 mm	2 mm
SAR _{be} [%]	Without Correction Algorithm	12.3	8.5
SAR _{be} [%]	With Correction Algorithm	0.2	0.1

Sensor Offset

Probe Tip to Sensor Center	2.7	mm
Optical Surface Detection	1.4 \pm 0.2	mm

Receiving Pattern (ϕ), $\theta = 0^\circ$

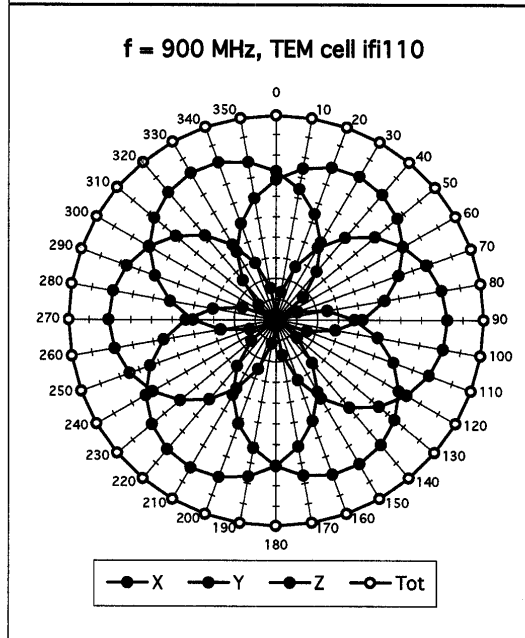
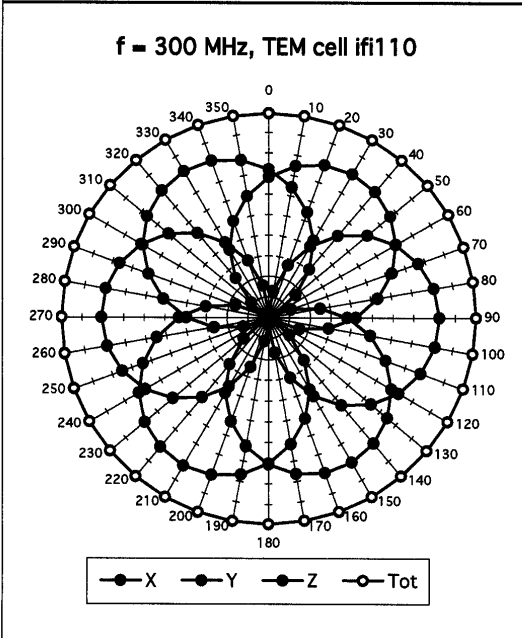
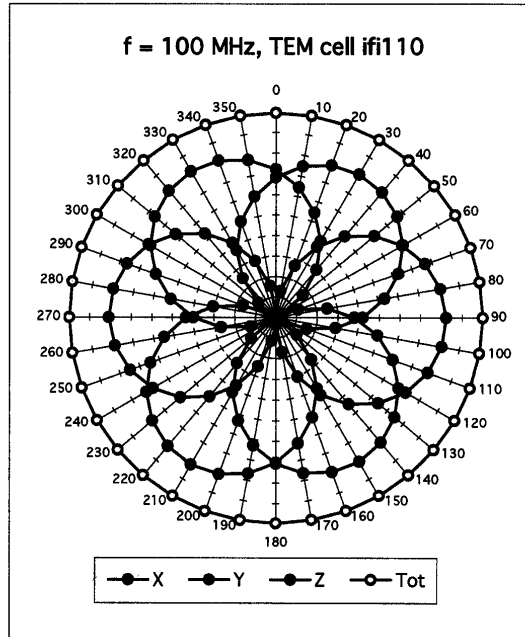
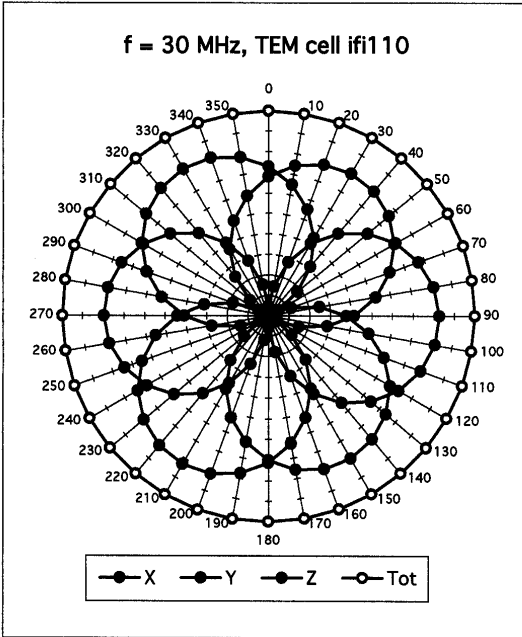

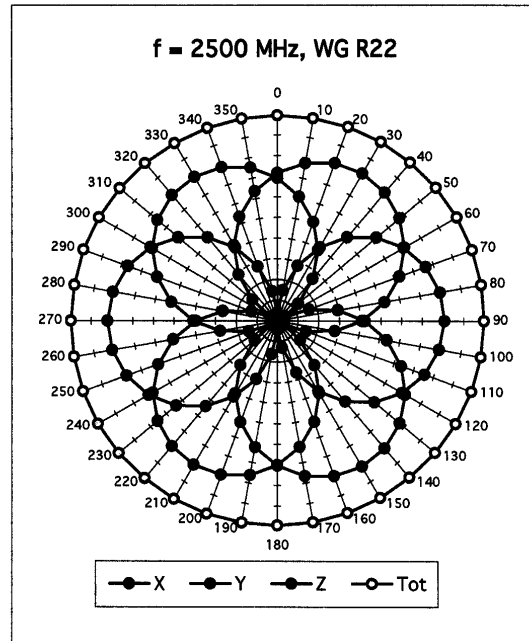
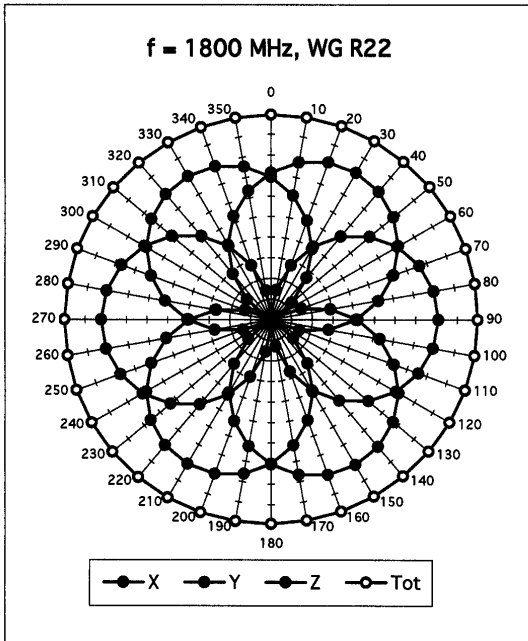

Isotropy Error (ϕ), $\theta = 0^\circ$

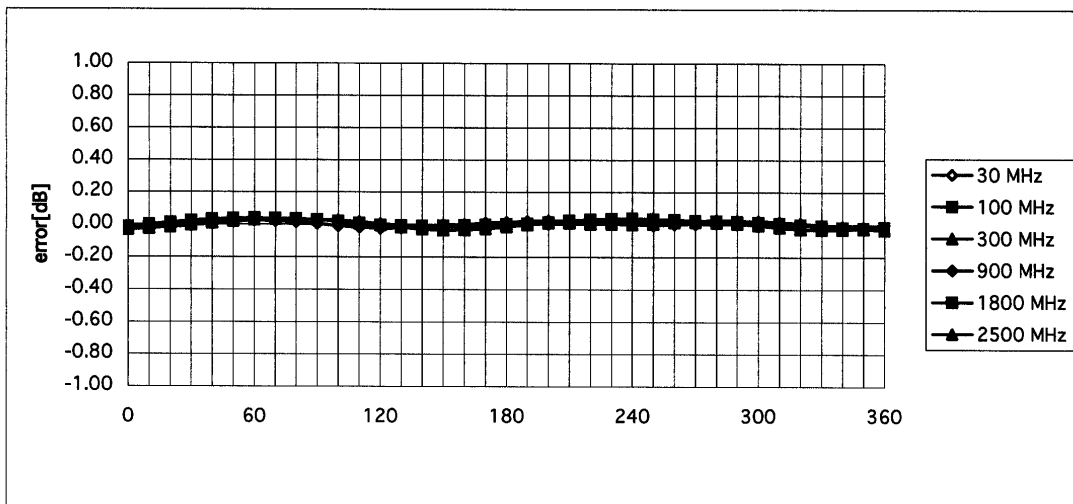

Frequency Response of E-Field

(TEM-Cell:ifi110, Waveguide R22)

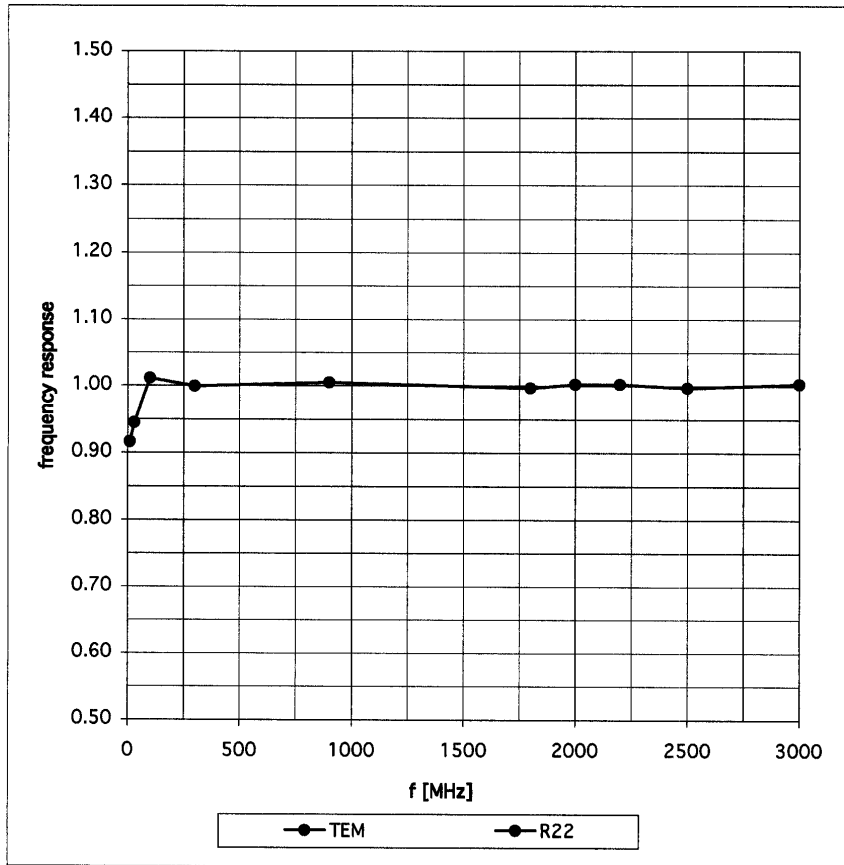

Dynamic Range f(SAR_{brain})

(Waveguide R22)

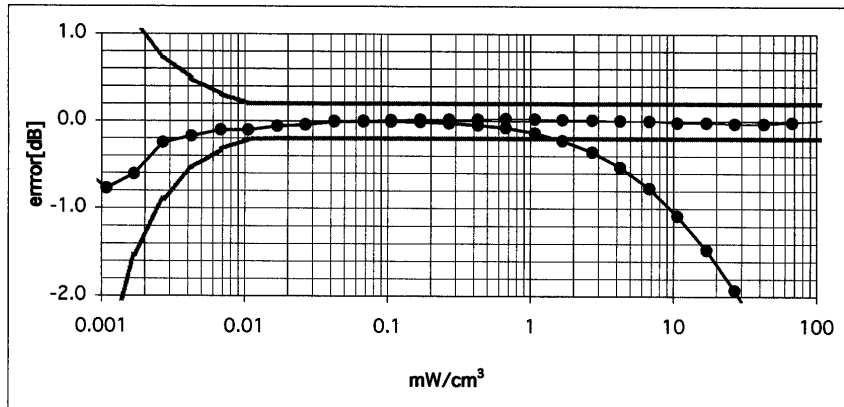
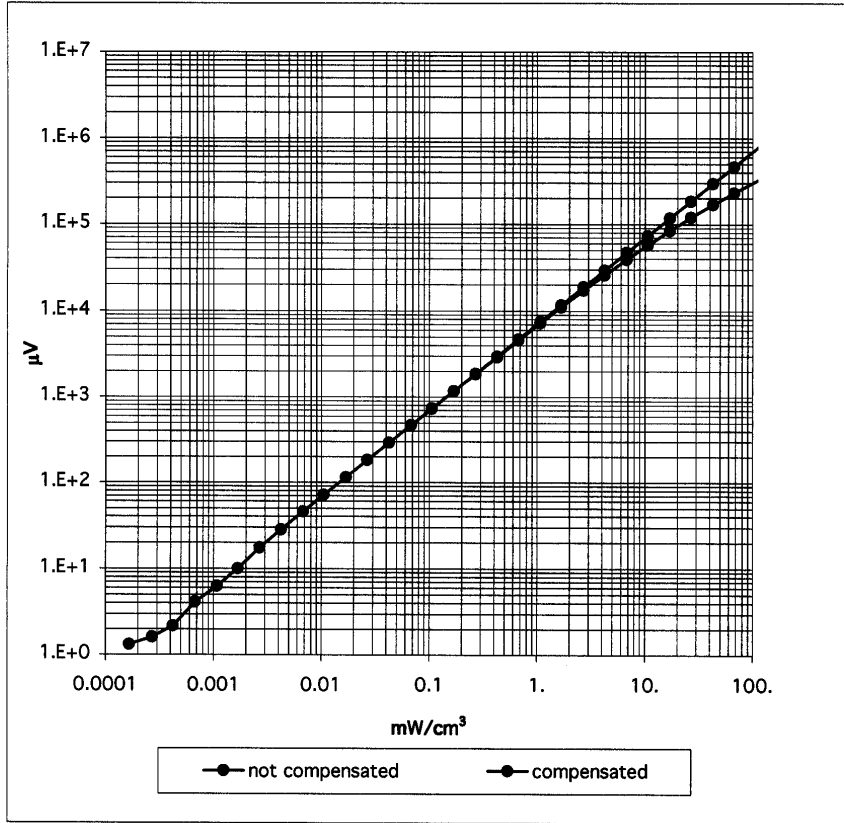

Conversion Factor Assessment

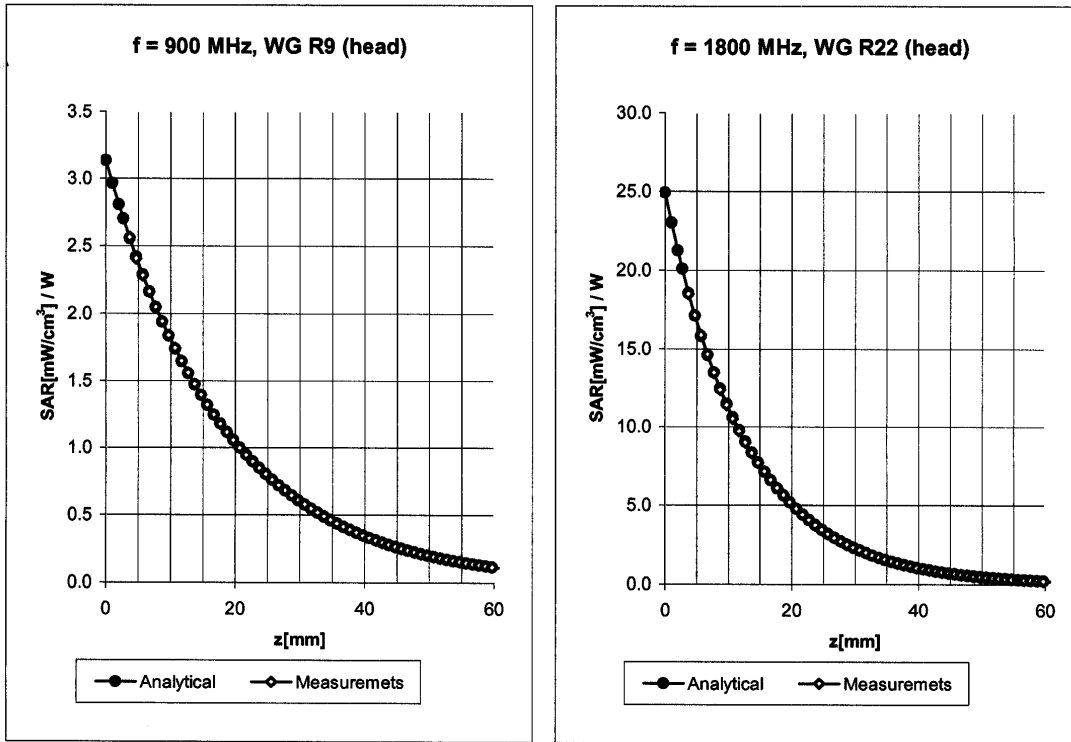

Head 900 MHz $\epsilon_r = 41.5 \pm 5\%$ $\sigma = 0.97 \pm 5\%$ mho/m

Valid for f=800-1000 MHz with Head Tissue Simulating Liquid according to EN 50361, P1528-200X

ConvF X	7.0 ± 9.5% (k=2)	Boundary effect:
ConvF Y	7.0 ± 9.5% (k=2)	Alpha 0.33
ConvF Z	7.0 ± 9.5% (k=2)	Depth 2.56

Head 1800 MHz $\epsilon_r = 40.0 \pm 5\%$ $\sigma = 1.40 \pm 5\%$ mho/m

Valid for f=1710-1910 MHz with Head Tissue Simulating Liquid according to EN 50361, P1528-200X

ConvF X	5.5 ± 9.5% (k=2)	Boundary effect:
ConvF Y	5.5 ± 9.5% (k=2)	Alpha 0.44
ConvF Z	5.5 ± 9.5% (k=2)	Depth 2.69

Conversion Factor Assessment

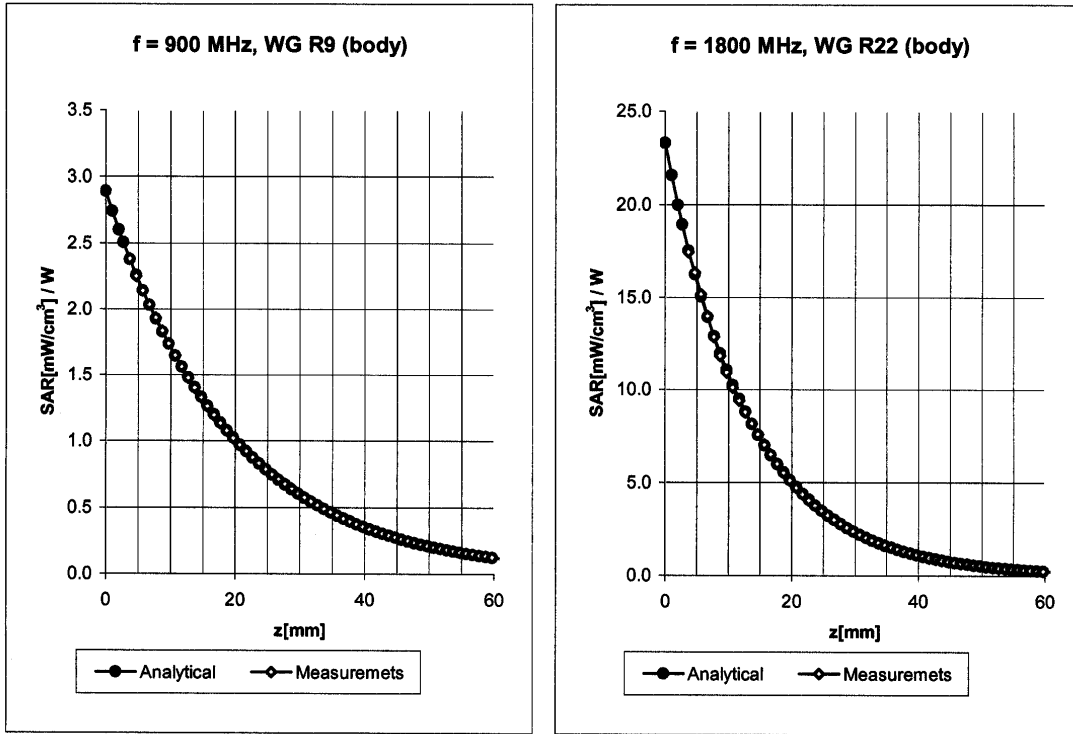

Body 900 MHz $\epsilon_r = 55.0 \pm 5\%$ $\sigma = 1.05 \pm 5\%$ mho/m

Valid for f=800-1000 MHz with Body Tissue Simulating Liquid according to OET 65 Suppl. C

ConvF X	6.8 $\pm 9.5\%$ (k=2)	Boundary effect:
ConvF Y	6.8 $\pm 9.5\%$ (k=2)	Alpha 0.34
ConvF Z	6.8 $\pm 9.5\%$ (k=2)	Depth 2.61

Body 1800 MHz $\epsilon_r = 53.3 \pm 5\%$ $\sigma = 1.52 \pm 5\%$ mho/m

Valid for f=1710-1910 MHz with Body Tissue Simulating Liquid according to OET 65 Suppl. C

ConvF X	5.0 $\pm 9.5\%$ (k=2)	Boundary effect:
ConvF Y	5.0 $\pm 9.5\%$ (k=2)	Alpha 0.52
ConvF Z	5.0 $\pm 9.5\%$ (k=2)	Depth 2.69

Conversion Factor Assessment

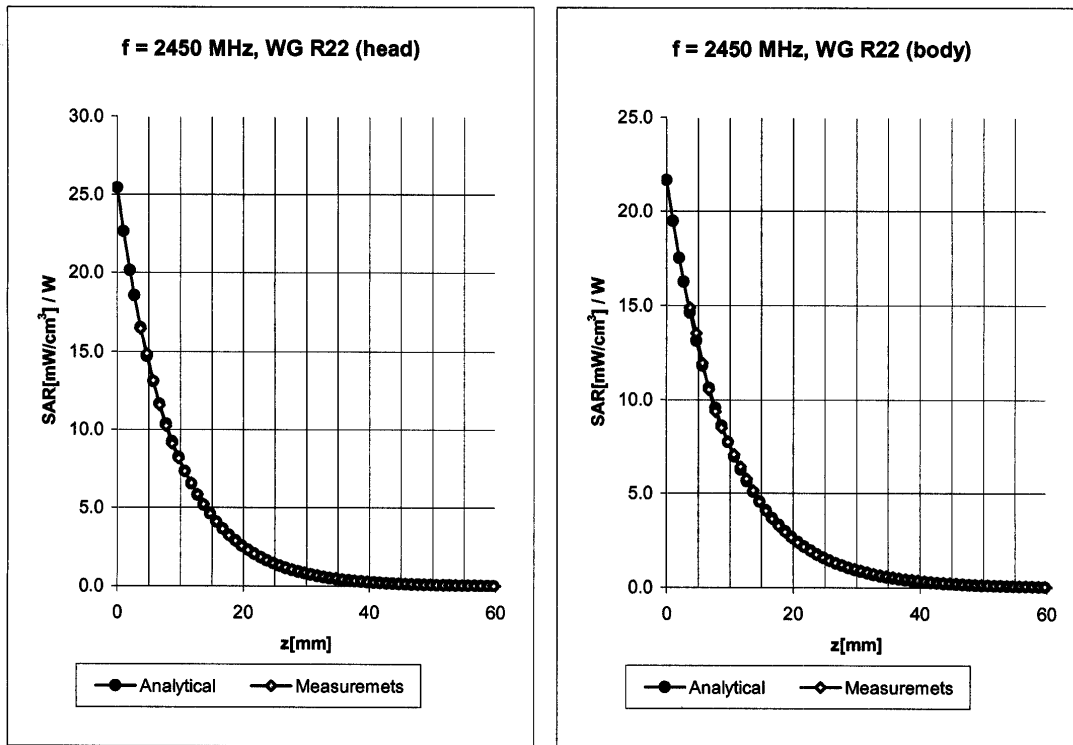

Head 2450 MHz $\epsilon_r = 39.2 \pm 5\%$ $\sigma = 1.80 \pm 5\%$ mho/m

Valid for f=2400-2500 MHz with Head Tissue Simulating Liquid according to EN 50361, P1528-200X

ConvF X	5.0 ± 8.9% (k=2)	Boundary effect:	
ConvF Y	5.0 ± 8.9% (k=2)	Alpha	0.88
ConvF Z	5.0 ± 8.9% (k=2)	Depth	1.92

Body 2450 MHz $\epsilon_r = 52.7 \pm 5\%$ $\sigma = 1.95 \pm 5\%$ mho/m

Valid for f=2400-2500 MHz with Body Tissue Simulating Liquid according to OET 65 Suppl. C

ConvF X	4.4 ± 8.9% (k=2)	Boundary effect:	
ConvF Y	4.4 ± 8.9% (k=2)	Alpha	0.90
ConvF Z	4.4 ± 8.9% (k=2)	Depth	1.87

Deviation from Isotropy in HSL

Error (θ, ϕ), $f = 900$ MHz

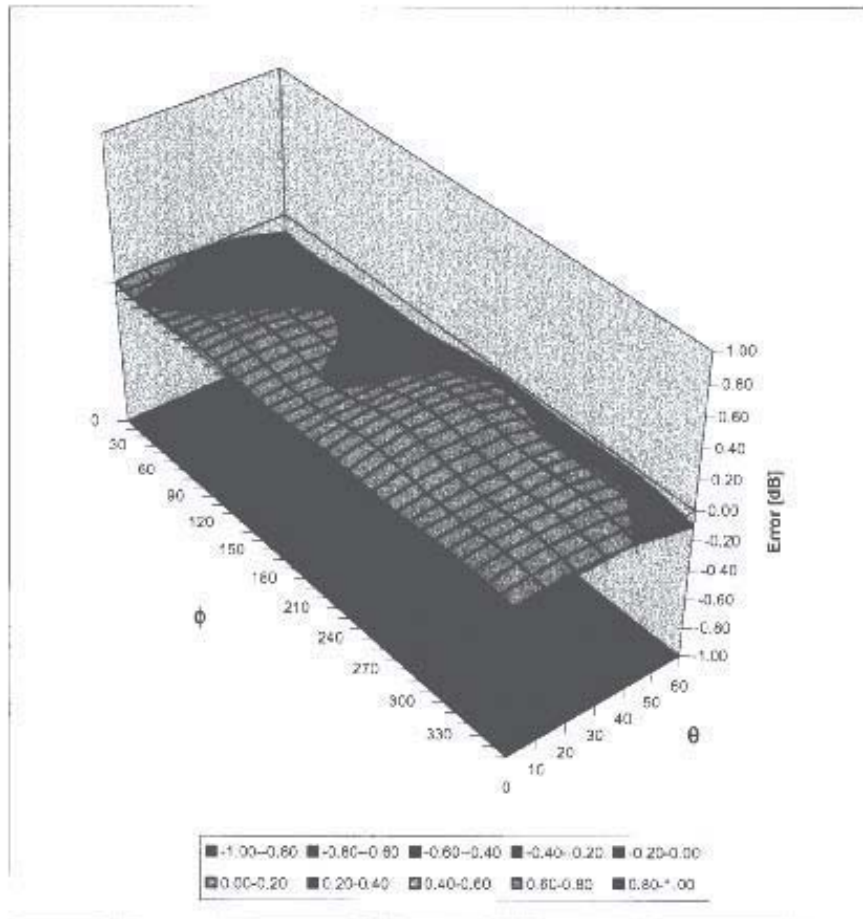

Additional Conversion Factors for Dosimetric E-Field Probe

Type:

ET3DV6

Serial Number:

1590

Place of Assessment:

Zurich

Date of Assessment:

May 19, 2003

Probe Calibration Date:

May 15, 2003

Schmid & Partner Engineering AG hereby certifies that conversion factor(s) of this probe have been evaluated on the date indicated above. The assessment was performed using the FDTD numerical code SEMCAD of Schmid & Partner Engineering AG. Since the evaluation is coupled with measured conversion factors, it has to be recalculated yearly, i.e., following the re-calibration schedule of the probe. The uncertainty of the numerical assessment is based on the extrapolation from measured value at 900 MHz or at 1800 MHz.

Assessed by:

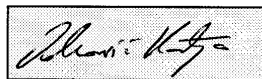

Dosimetric E-Field Probe ET3DV6 SN:1590

Conversion factor (\pm standard deviation)

150 MHz	ConvF	9.6 \pm 8%	$\epsilon_r = 52.3 \pm 5\%$ $\sigma = 0.76 \pm 5\%$ mho/m (head tissue)
300 MHz	ConvF	8.3 \pm 8%	$\epsilon_r = 45.3 \pm 5\%$ $\sigma = 0.87 \pm 5\%$ mho/m (head tissue)
450 MHz	ConvF	7.9 \pm 8%	$\epsilon_r = 43.5 \pm 5\%$ $\sigma = 0.87 \pm 5\%$ mho/m (head tissue)
150 MHz	ConvF	9.2 \pm 8%	$\epsilon_r = 61.9 \pm 5\%$ $\sigma = 0.80 \pm 5\%$ mho/m (body tissue)
450 MHz	ConvF	8.1 \pm 8%	$\epsilon_r = 56.7 \pm 5\%$ $\sigma = 0.94 \pm 5\%$ mho/m (body tissue)

Test Report S/N:	021104-474KBC
Test Date(s):	March 02, 2004
Test Type:	FCC/IC SAR Evaluation

APPENDIX E - MEASURED FLUID DIELECTRIC PARAMETERS

2450 MHz System Performance Check

Measured Fluid Dielectric Parameters (Brain)

March 2, 2004

Frequency	ϵ'	ϵ''
2.400000000 GHz	37.6171	13.7766
2.405000000 GHz	37.5942	13.7869
2.410000000 GHz	37.5625	13.7961
2.415000000 GHz	37.5253	13.8015
2.420000000 GHz	37.5109	13.8080
2.425000000 GHz	37.4976	13.8465
2.430000000 GHz	37.4819	13.8678
2.435000000 GHz	37.4717	13.8821
2.440000000 GHz	37.4480	13.8963
2.445000000 GHz	37.4076	13.9131
2.450000000 GHz	37.3687	13.9178
2.455000000 GHz	37.3479	13.9381
2.460000000 GHz	37.3378	13.9444
2.465000000 GHz	37.3187	13.9392
2.470000000 GHz	37.3142	13.9384
2.475000000 GHz	37.3066	13.9673
2.480000000 GHz	37.2866	13.9873
2.485000000 GHz	37.2869	14.0153
2.490000000 GHz	37.2627	14.0361
2.495000000 GHz	37.2349	14.0490
2.500000000 GHz	37.2169	14.0568

2450 MHz DUT Evaluation (Body)

Measured Fluid Dielectric Parameters (Muscle)

March 2, 2004

Frequency	ϵ'	ϵ''
2.400000000 GHz	50.6318	14.4957
2.405000000 GHz	50.6184	14.5333
2.410000000 GHz	50.5895	14.5606
2.415000000 GHz	50.5709	14.5901
2.420000000 GHz	50.5639	14.6351
2.425000000 GHz	50.5516	14.6539
2.430000000 GHz	50.5356	14.6664
2.435000000 GHz	50.5255	14.6864
2.440000000 GHz	50.5080	14.7120
2.445000000 GHz	50.5129	14.7288
2.450000000 GHz	50.5053	14.7499
2.455000000 GHz	50.4970	14.7611
2.460000000 GHz	50.4765	14.7800
2.465000000 GHz	50.4627	14.7981
2.470000000 GHz	50.4517	14.8092
2.475000000 GHz	50.4330	14.8227
2.480000000 GHz	50.4200	14.8257
2.485000000 GHz	50.3953	14.8396
2.490000000 GHz	50.3834	14.8488
2.495000000 GHz	50.3562	14.8662
2.500000000 GHz	50.3360	14.8860

Test Report S/N:	021104-474KBC
Test Date(s):	March 02, 2004
Test Type:	FCC/IC SAR Evaluation

APPENDIX F - SAM PHANTOM CERTIFICATE OF CONFORMITY

Schmid & Partner Engineering AG

Zeughausstrasse 43, 8004 Zurich, Switzerland, Phone +41 1 245 97 00, Fax +41 1 245 97 79

Certificate of conformity / First Article Inspection

Item	SAM Twin Phantom V4.0
Type No	QD 000 P40 BA
Series No	TP-1002 and higher
Manufacturer / Origin	Untersee Composites Hauptstr. 69 CH-8559 Fruthwilen Switzerland

Tests

The series production process used allows the limitation to test of first articles. Complete tests were made on the pre-series Type No. QD 000 P40 AA, Serial No. TP-1001 and on the series first article Type No. QD 000 P40 BA, Serial No. TP-1006. Certain parameters have been retested using further series units (called samples).

Test	Requirement	Details	Units tested
Shape	Compliance with the geometry according to the CAD model.	IT'IS CAD File (*)	First article, Samples
Material thickness	Compliant with the requirements according to the standards	2mm +/- 0.2mm in specific areas	First article, Samples
Material parameters	Dielectric parameters for required frequencies	200 MHz – 3 GHz Relative permittivity < 5 Loss tangent < 0.05.	Material sample TP 104-5
Material resistivity	The material has been tested to be compatible with the liquids defined in the standards	Liquid type HSL 1800 and others according to the standard.	Pre-series, First article

Standards

- [1] CENELEC EN 50361
- [2] IEEE P1528-200x draft 6.5
- [3] IEC PT 62209 draft 0.9
- (*) The IT'IS CAD file is derived from [2] and is also within the tolerance requirements of the shapes of [1] and [3].

Conformity

Based on the sample tests above, we certify that this item is in compliance with the uncertainty requirements of SAR measurements specified in standard [1] and draft standards [2] and [3].

Date 18.11.2001

Signature / Stamp



**Schmid & Partner
Engineering AG**



Zeughausstrasse 43, CH-8004 Zurich
Tel. +41 1 245 97 00, Fax +41 1 245 97 79

Test Report S/N:	021104-474KBC
Test Date(s):	March 02, 2004
Test Type:	FCC/IC SAR Evaluation

APPENDIX G - PLANAR PHANTOM CERTIFICATE OF CONFORMITY

2378 Westlake Road
Kelowna, B.C. Canada
V1Z-2V2



Ph. # 250-769-6848
Fax # 250-769-6334
E-mail: barskiind@shaw.ca
Web: www.bcfiberglass.com

FIBERGLASS FABRICATORS

Certificate of Conformity

Item : Flat Planar Phantom Unit # 03-01
Date: June 16, 2003
Manufacturer: Barski Industries (1985 Ltd)

Test	Requirement	Details
Shape	Compliance to geometry according to drawing	Supplied CAD drawing
Material Thickness	Compliant with the requirements	2mm +/- 0.2mm in measurement area
Material Parameters	Dielectric parameters for required frequencies Based on Dow Chemical technical data	100 MHz-5 GHz Relative permittivity < 5 Loss Tangent < 0.05

Conformity

Based on the above information, we certify this product to be compliant to the requirements specified.

Signature: 

Daniel Chailier



Fiberglass Planar Phantom - Top View



Fiberglass Planar Phantom - Front View



Fiberglass Planar Phantom - Back View



Fiberglass Planar Phantom - Bottom View

Dimensions of Fiberglass Planar Phantom

(Manufactured by Barski Industries Ltd. - Unit# 03-01)

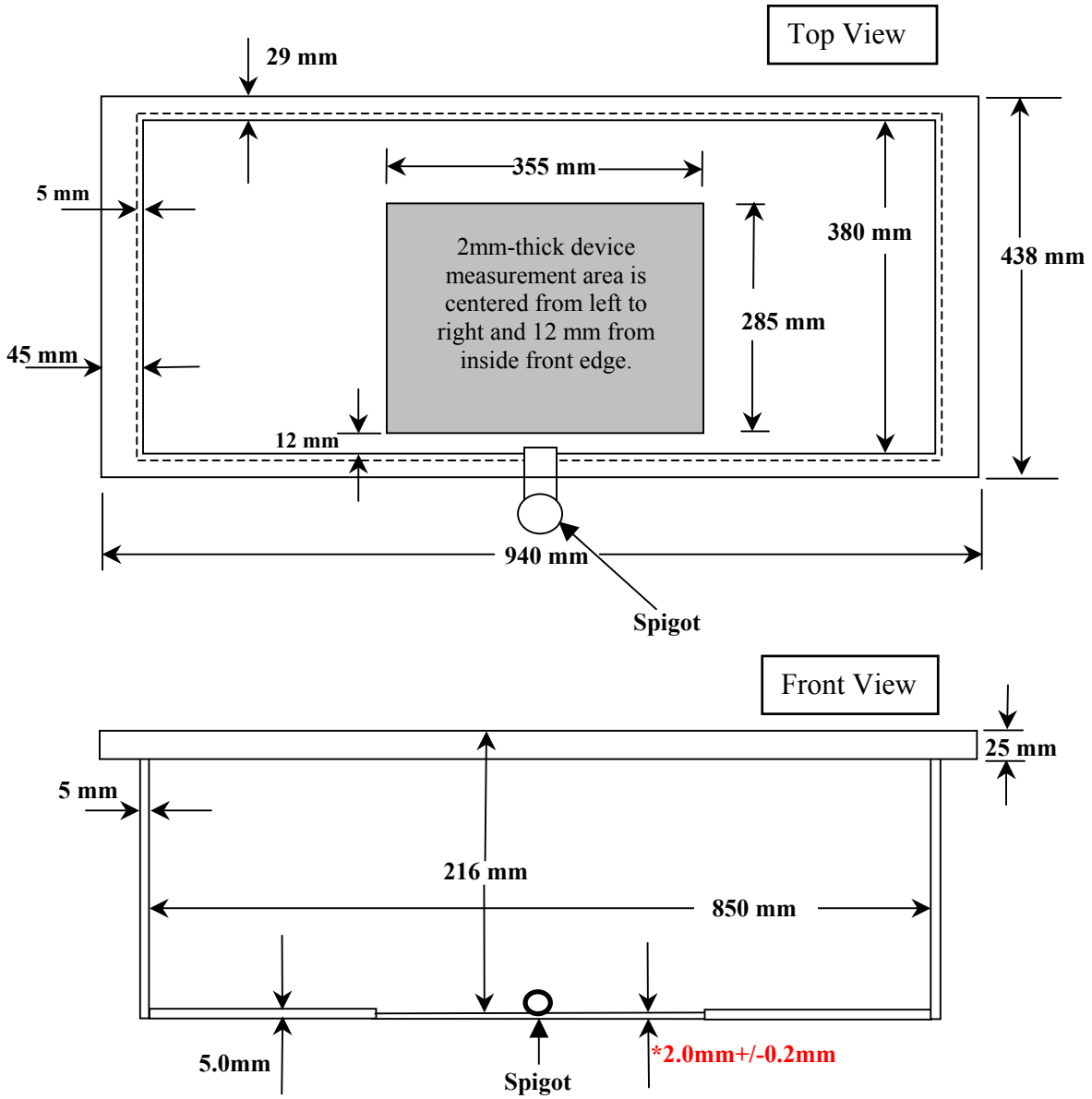

**Note: Measurements that aren't repeated for the opposite sides are the same as the side measured.
This drawing is not to scale.**

Test Report S/N:	021104-474KBC
Test Date(s):	March 02, 2004
Test Type:	FCC/IC SAR Evaluation

APPENDIX H - SAR TEST SETUP PHOTOGRAPHS

BODY SAR TEST SETUP PHOTOGRAPHS
0.0 cm Separation Distance from Front of Carry Case to Planar Phantom
(Front Side of DUT facing Front of Carry Case & Planar Phantom)
With Nylon Carry Case (P/N: 54-0644-001) & Ear-Microphone (Model: JABRA)

