



Test Report S/N:	021104-473KBC
Test Date(s):	March 05 & 08, 2004
Test Type:	FCC/IC SAR Evaluation

## APPENDIX D - PROBE CALIBRATION

Client **Celltech Labs**

CALIBRATION CERTIFICATE																															
Object(s)	ET3DV6 - SN:1590																														
Calibration procedure(s)	QA CAL-01.v2 Calibration procedure for dosimetric E-field probes																														
Calibration date:	May 15, 2003																														
Condition of the calibrated item	In Tolerance (according to the specific calibration document)																														
<p>This calibration statement documents traceability of M&amp;TE used in the calibration procedures and conformity of the procedures with the ISO/IEC 17025 international standard.</p> <p>All calibrations have been conducted in the closed laboratory facility: environment temperature 22 +/- 2 degrees Celsius and humidity &lt; 75%.</p> <p>Calibration Equipment used (M&amp;TE critical for calibration)</p> <table border="1"> <thead> <tr> <th>Model Type</th> <th>ID #</th> <th>Cal Date (Calibrated by, Certificate No.)</th> <th>Scheduled Calibration</th> </tr> </thead> <tbody> <tr> <td>RF generator HP 8684C</td> <td>US3642U01700</td> <td>4-Aug-99 (SPEAG, in house check Aug-02)</td> <td>In house check: Aug-05</td> </tr> <tr> <td>Power sensor E4412A</td> <td>MY41495277</td> <td>2-Apr-03 (METAS, No 252-0250)</td> <td>Apr-04</td> </tr> <tr> <td>Power sensor HP 8481A</td> <td>MY41092180</td> <td>18-Sep-02 (Agilent, No. 20020918)</td> <td>Sep-03</td> </tr> <tr> <td>Power meter EPM E4419B</td> <td>GB41293874</td> <td>2-Apr-03 (METAS, No 252-0250)</td> <td>Apr-04</td> </tr> <tr> <td>Network Analyzer HP 8753E</td> <td>US38432426</td> <td>3-May-00 (Agilent, No. 8702K094602)</td> <td>In house check: May 03</td> </tr> <tr> <td>Fluke Process Calibrator Type 702</td> <td>SN: 6295803</td> <td>3-Sep-01 (ELCAL, No.2360)</td> <td>Sep-03</td> </tr> </tbody> </table>				Model Type	ID #	Cal Date (Calibrated by, Certificate No.)	Scheduled Calibration	RF generator HP 8684C	US3642U01700	4-Aug-99 (SPEAG, in house check Aug-02)	In house check: Aug-05	Power sensor E4412A	MY41495277	2-Apr-03 (METAS, No 252-0250)	Apr-04	Power sensor HP 8481A	MY41092180	18-Sep-02 (Agilent, No. 20020918)	Sep-03	Power meter EPM E4419B	GB41293874	2-Apr-03 (METAS, No 252-0250)	Apr-04	Network Analyzer HP 8753E	US38432426	3-May-00 (Agilent, No. 8702K094602)	In house check: May 03	Fluke Process Calibrator Type 702	SN: 6295803	3-Sep-01 (ELCAL, No.2360)	Sep-03
Model Type	ID #	Cal Date (Calibrated by, Certificate No.)	Scheduled Calibration																												
RF generator HP 8684C	US3642U01700	4-Aug-99 (SPEAG, in house check Aug-02)	In house check: Aug-05																												
Power sensor E4412A	MY41495277	2-Apr-03 (METAS, No 252-0250)	Apr-04																												
Power sensor HP 8481A	MY41092180	18-Sep-02 (Agilent, No. 20020918)	Sep-03																												
Power meter EPM E4419B	GB41293874	2-Apr-03 (METAS, No 252-0250)	Apr-04																												
Network Analyzer HP 8753E	US38432426	3-May-00 (Agilent, No. 8702K094602)	In house check: May 03																												
Fluke Process Calibrator Type 702	SN: 6295803	3-Sep-01 (ELCAL, No.2360)	Sep-03																												
Calibrated by:	Name Nicola Vetterli	Function Technician	Signature 																												
Approved by:	Name Katja Polovic	Function Laboratory Director	Signature 																												
Date issued: May 15, 2003																															
<p>This calibration certificate is issued as an intermediate solution until the accreditation process (based on ISO/IEC 17025 International Standard) for Calibration Laboratory of Schmid &amp; Partner Engineering AG is completed.</p>																															

# Probe ET3DV6

SN:1590

Manufactured:	March 19, 2001
Last calibration:	April 26, 2002
Recalibrated:	May 15, 2003

Calibrated for DASY Systems

(Note: non-compatible with DASY2 system!)

**DASY - Parameters of Probe: ET3DV6 SN:1590****Sensitivity in Free Space**

NormX	<b>1.76</b> $\mu\text{V}/(\text{V}/\text{m})^2$
NormY	<b>1.91</b> $\mu\text{V}/(\text{V}/\text{m})^2$
NormZ	<b>1.66</b> $\mu\text{V}/(\text{V}/\text{m})^2$

**Diode Compression**

DCP X	<b>92</b>	mV
DCP Y	<b>92</b>	mV
DCP Z	<b>92</b>	mV

**Sensitivity in Tissue Simulating Liquid**

Head                      900 MHz                       $\epsilon_r = 41.5 \pm 5\%$                        $\sigma = 0.97 \pm 5\%$  mho/m

Valid for f=800-1000 MHz with Head Tissue Simulating Liquid according to EN 50361, P1528-200X

ConvF X	<b>7.0</b> $\pm 9.5\%$ (k=2)	Boundary effect:
ConvF Y	<b>7.0</b> $\pm 9.5\%$ (k=2)	Alpha <b>0.33</b>
ConvF Z	<b>7.0</b> $\pm 9.5\%$ (k=2)	Depth <b>2.56</b>

Head                      1800 MHz                       $\epsilon_r = 40.0 \pm 5\%$                        $\sigma = 1.40 \pm 5\%$  mho/m

Valid for f=1710-1910 MHz with Head Tissue Simulating Liquid according to EN 50361, P1528-200X

ConvF X	<b>5.5</b> $\pm 9.5\%$ (k=2)	Boundary effect:
ConvF Y	<b>5.5</b> $\pm 9.5\%$ (k=2)	Alpha <b>0.44</b>
ConvF Z	<b>5.5</b> $\pm 9.5\%$ (k=2)	Depth <b>2.69</b>

**Boundary Effect**

Head                      900 MHz                      Typical SAR gradient: 5 % per mm

Probe Tip to Boundary		<b>1 mm</b>	<b>2 mm</b>
SAR <sub>be</sub> [%]	Without Correction Algorithm	8.7	5.0
SAR <sub>be</sub> [%]	With Correction Algorithm	0.3	0.5

Head                      1800 MHz                      Typical SAR gradient: 10 % per mm

Probe Tip to Boundary		<b>1 mm</b>	<b>2 mm</b>
SAR <sub>be</sub> [%]	Without Correction Algorithm	12.3	8.5
SAR <sub>be</sub> [%]	With Correction Algorithm	0.2	0.1

**Sensor Offset**

Probe Tip to Sensor Center	<b>2.7</b>	mm
Optical Surface Detection	<b>1.4 <math>\pm</math> 0.2</b>	mm

### Receiving Pattern ( $\phi$ ), $\theta = 0^\circ$

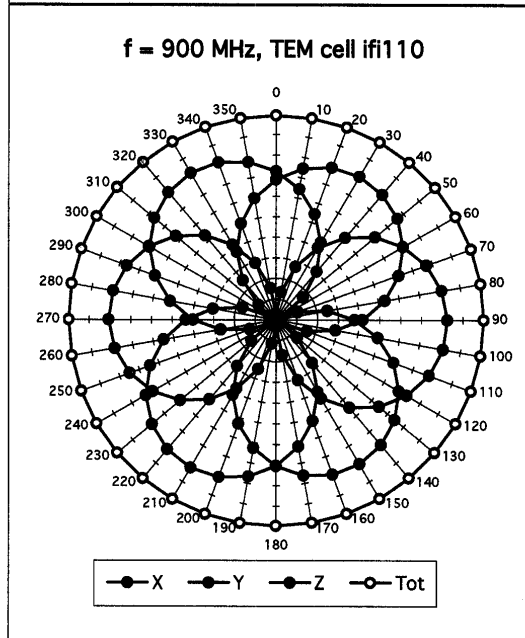
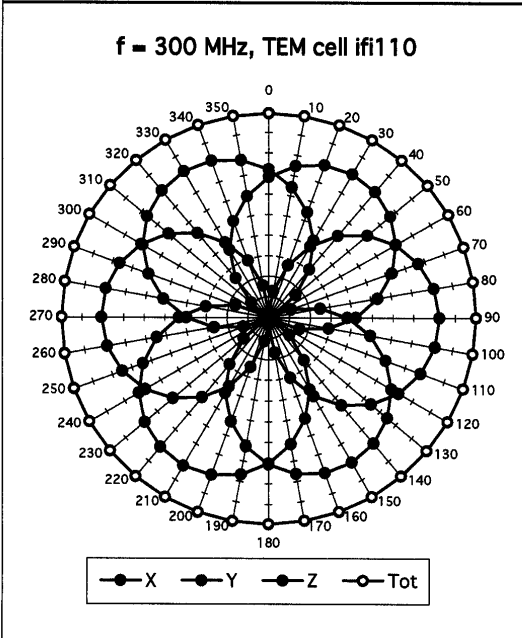
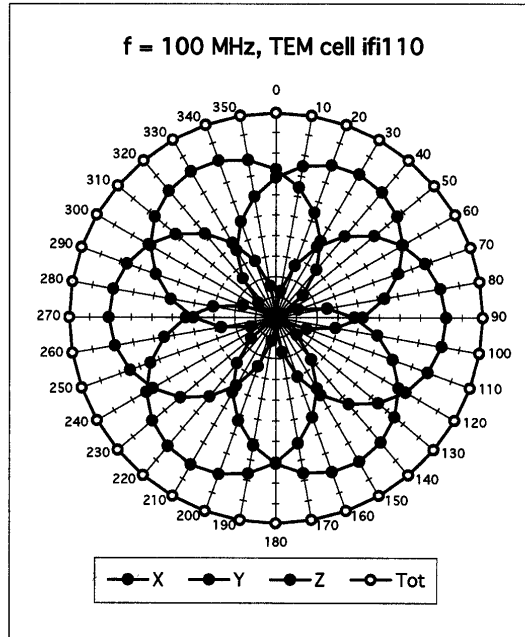
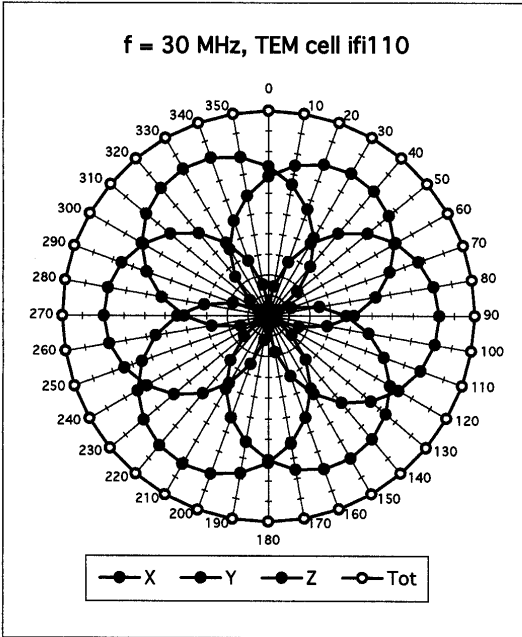

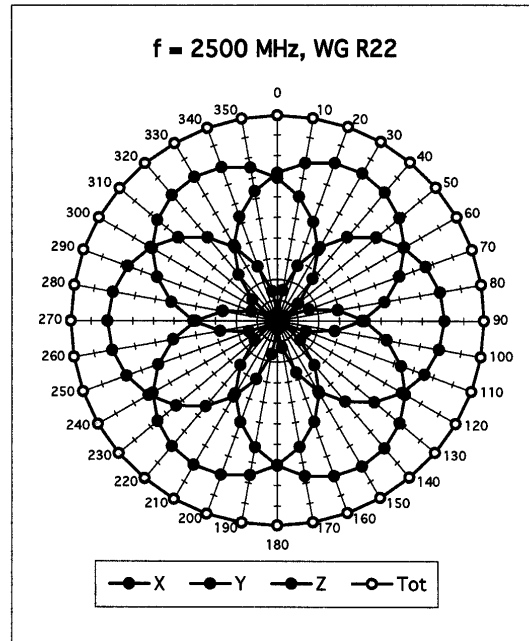
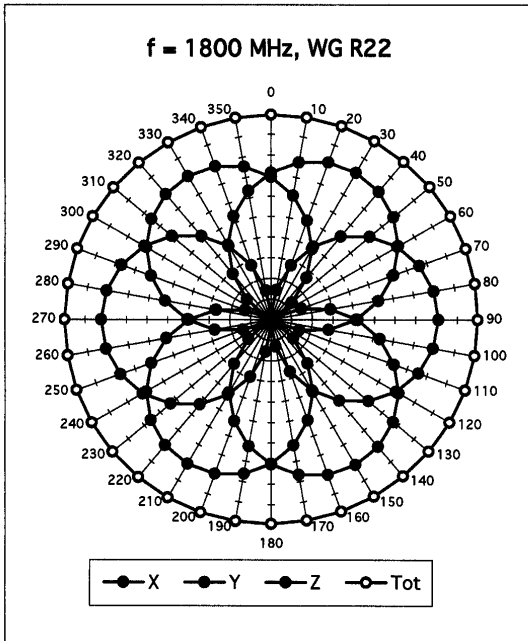

**Isotropy Error ( $\phi$ ),  $\theta = 0^\circ$**

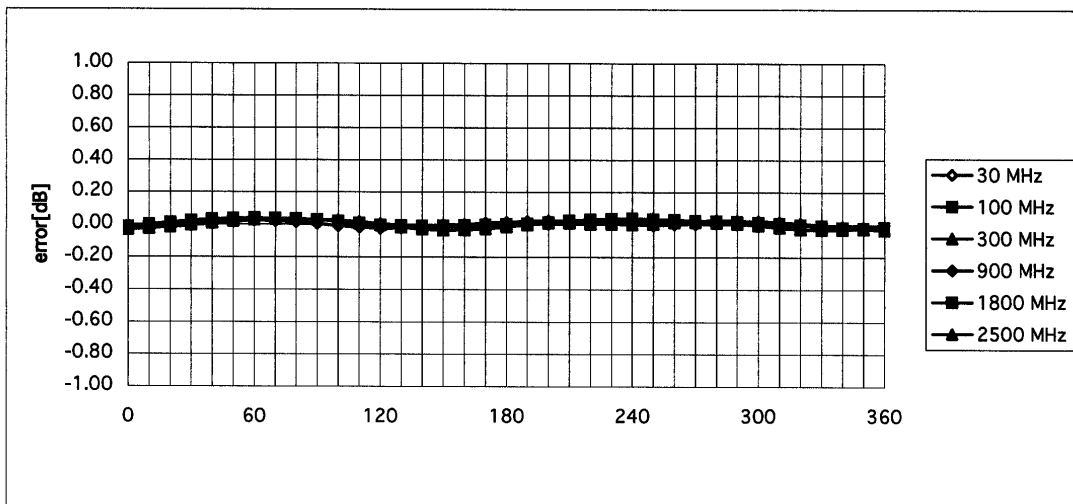

### Frequency Response of E-Field

( TEM-Cell:ifi110, Waveguide R22)

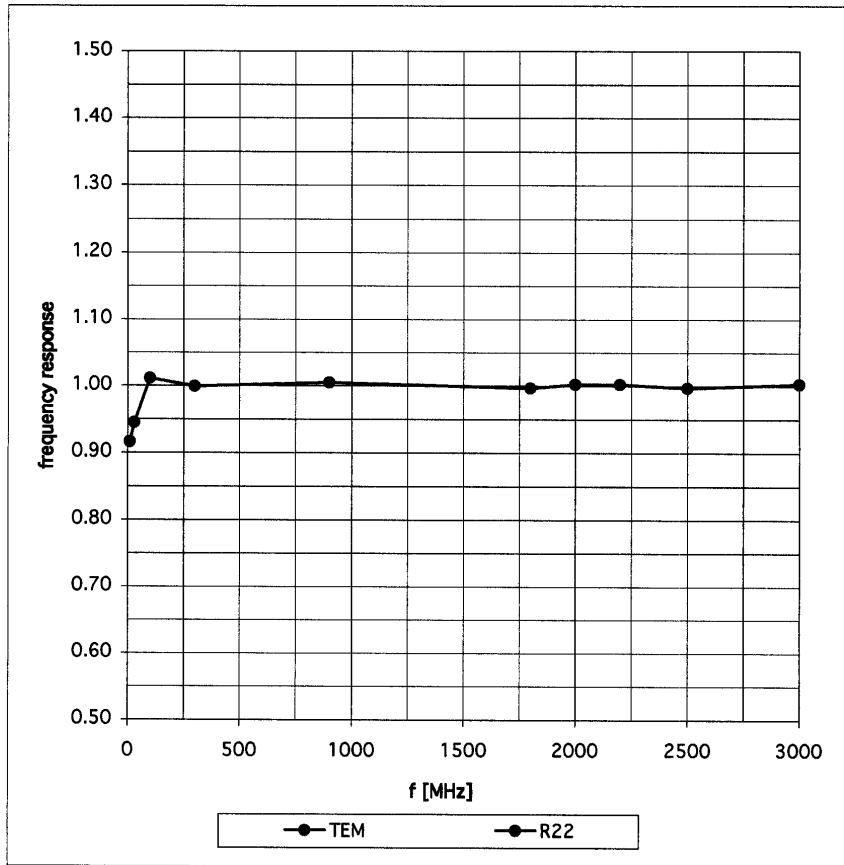

### Dynamic Range f(SAR<sub>brain</sub>)

( Waveguide R22 )

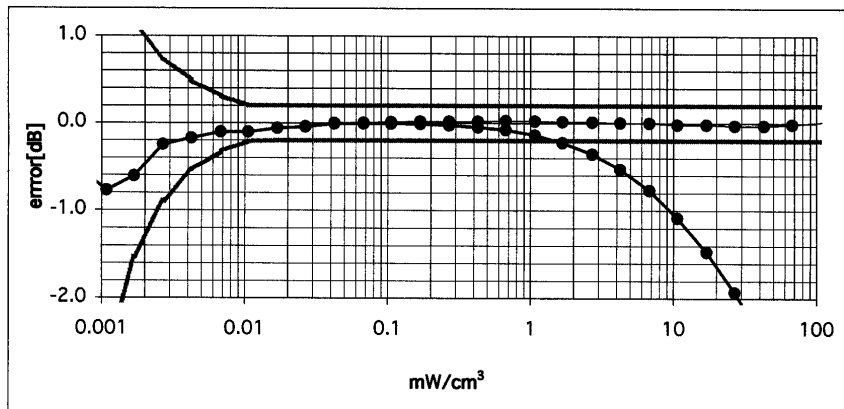
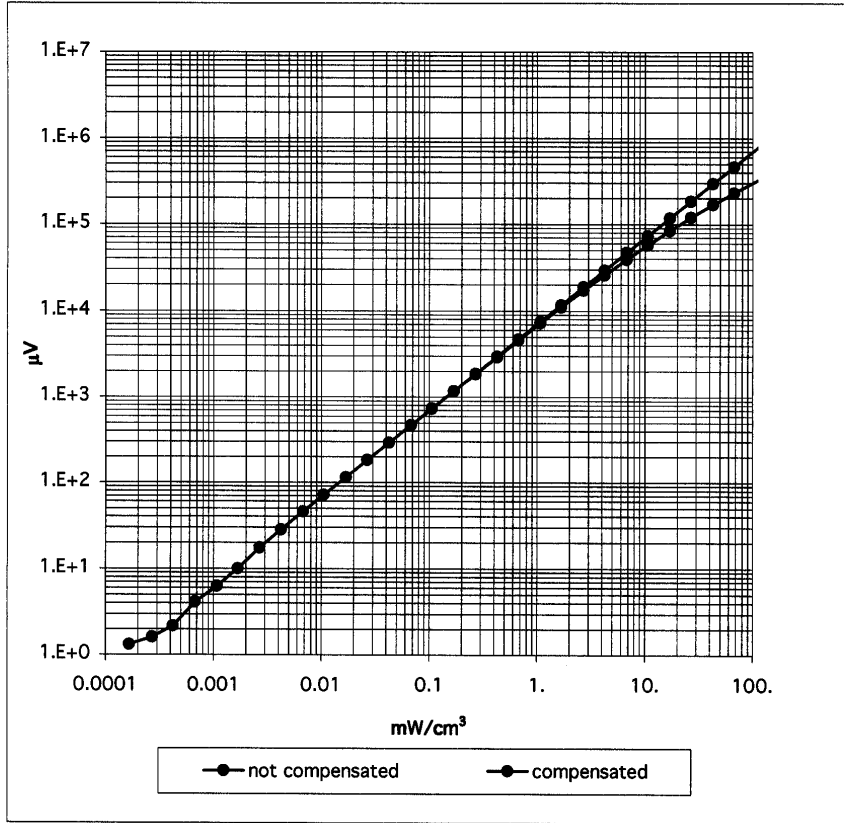



### Conversion Factor Assessment

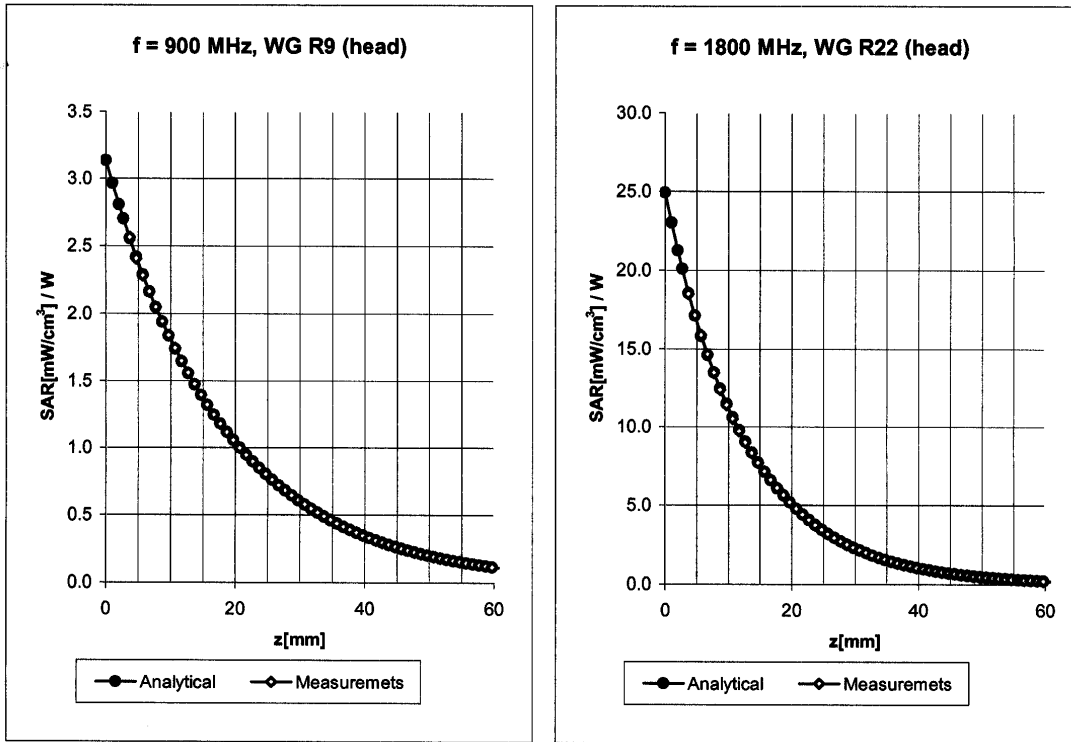

Head                      900 MHz                       $\epsilon_r = 41.5 \pm 5\%$                        $\sigma = 0.97 \pm 5\%$  mho/m

Valid for f=800-1000 MHz with Head Tissue Simulating Liquid according to EN 50361, P1528-200X

ConvF X	7.0 ± 9.5% (k=2)	Boundary effect:
ConvF Y	7.0 ± 9.5% (k=2)	Alpha <b>0.33</b>
ConvF Z	7.0 ± 9.5% (k=2)	Depth <b>2.56</b>

Head                      1800 MHz                       $\epsilon_r = 40.0 \pm 5\%$                        $\sigma = 1.40 \pm 5\%$  mho/m

Valid for f=1710-1910 MHz with Head Tissue Simulating Liquid according to EN 50361, P1528-200X

ConvF X	5.5 ± 9.5% (k=2)	Boundary effect:
ConvF Y	5.5 ± 9.5% (k=2)	Alpha <b>0.44</b>
ConvF Z	5.5 ± 9.5% (k=2)	Depth <b>2.69</b>

### Conversion Factor Assessment

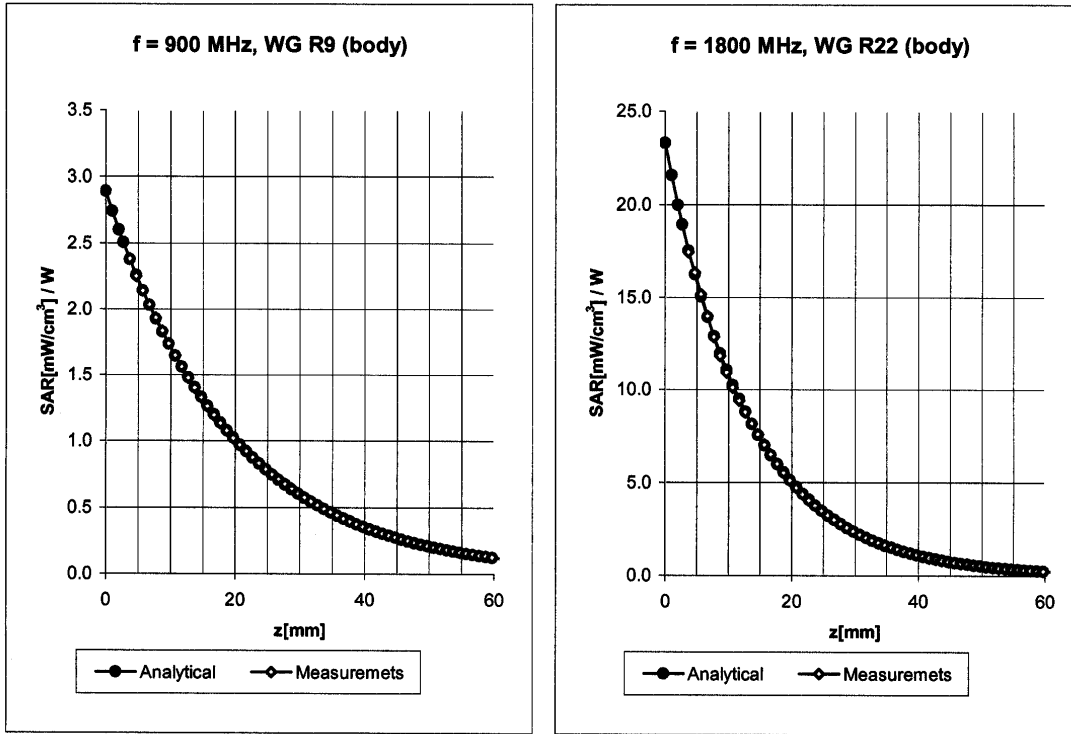

Body                      900 MHz                       $\epsilon_r = 55.0 \pm 5\%$                        $\sigma = 1.05 \pm 5\%$  mho/m

Valid for f=800-1000 MHz with Body Tissue Simulating Liquid according to OET 65 Suppl. C

ConvF X	<b>6.8</b> $\pm 9.5\%$ (k=2)	Boundary effect:
ConvF Y	<b>6.8</b> $\pm 9.5\%$ (k=2)	Alpha <b>0.34</b>
ConvF Z	<b>6.8</b> $\pm 9.5\%$ (k=2)	Depth <b>2.61</b>

Body                      1800 MHz                       $\epsilon_r = 53.3 \pm 5\%$                        $\sigma = 1.52 \pm 5\%$  mho/m

Valid for f=1710-1910 MHz with Body Tissue Simulating Liquid according to OET 65 Suppl. C

ConvF X	<b>5.0</b> $\pm 9.5\%$ (k=2)	Boundary effect:
ConvF Y	<b>5.0</b> $\pm 9.5\%$ (k=2)	Alpha <b>0.52</b>
ConvF Z	<b>5.0</b> $\pm 9.5\%$ (k=2)	Depth <b>2.69</b>

### Conversion Factor Assessment

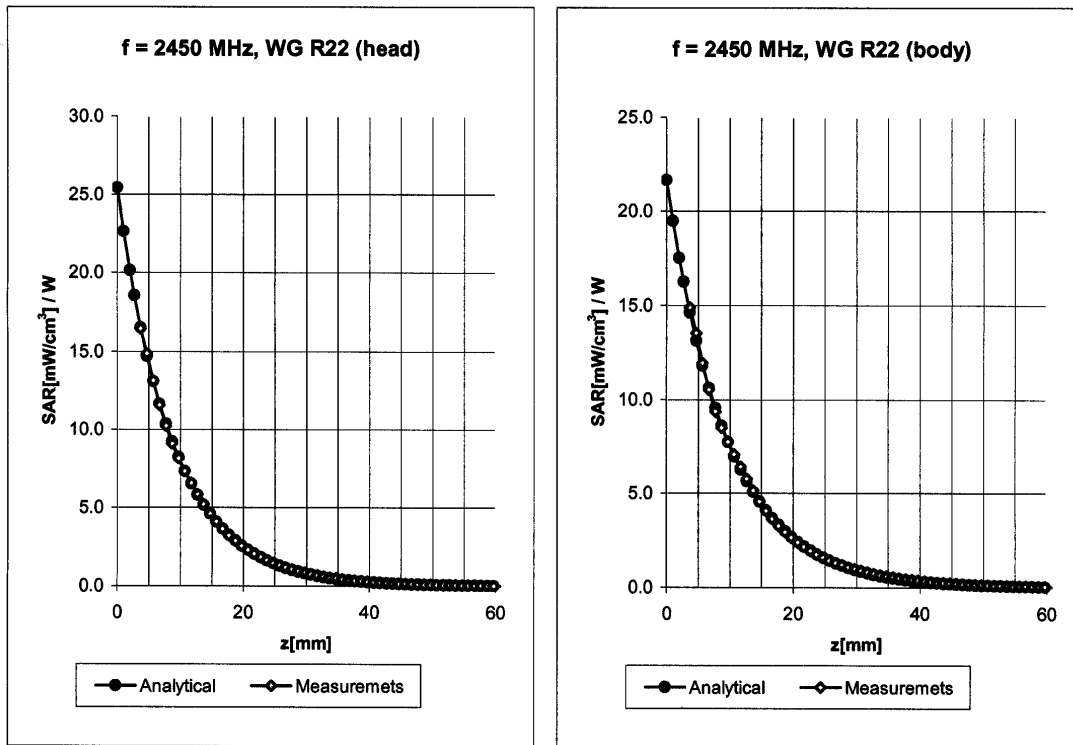

Head      2450      MHz       $\epsilon_r = 39.2 \pm 5\%$        $\sigma = 1.80 \pm 5\%$  mho/m

Valid for f=2400-2500 MHz with Head Tissue Simulating Liquid according to EN 50361, P1528-200X

ConvF X	5.0 ± 8.9% (k=2)	Boundary effect:	
ConvF Y	5.0 ± 8.9% (k=2)	Alpha	<b>0.88</b>
ConvF Z	5.0 ± 8.9% (k=2)	Depth	<b>1.92</b>

Body      2450      MHz       $\epsilon_r = 52.7 \pm 5\%$        $\sigma = 1.95 \pm 5\%$  mho/m

Valid for f=2400-2500 MHz with Body Tissue Simulating Liquid according to OET 65 Suppl. C

ConvF X	4.4 ± 8.9% (k=2)	Boundary effect:	
ConvF Y	4.4 ± 8.9% (k=2)	Alpha	<b>0.90</b>
ConvF Z	4.4 ± 8.9% (k=2)	Depth	<b>1.87</b>

### Deviation from Isotropy in HSL

Error ( $\theta, \phi$ ),  $f = 900$  MHz

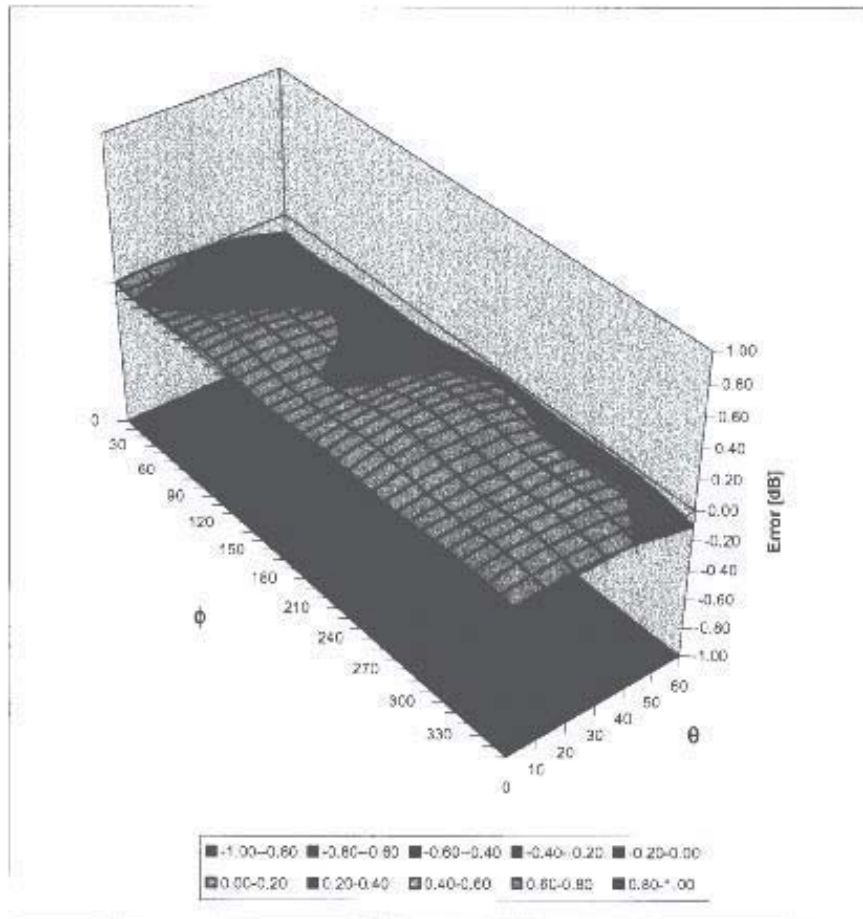

## Additional Conversion Factors for Dosimetric E-Field Probe

Type:

ET3DV6

Serial Number:

1590

Place of Assessment:

Zurich

Date of Assessment:

May 19, 2003

Probe Calibration Date:

May 15, 2003

Schmid & Partner Engineering AG hereby certifies that conversion factor(s) of this probe have been evaluated on the date indicated above. The assessment was performed using the FDTD numerical code SEMCAD of Schmid & Partner Engineering AG. Since the evaluation is coupled with measured conversion factors, it has to be recalculated yearly, i.e., following the re-calibration schedule of the probe. The uncertainty of the numerical assessment is based on the extrapolation from measured value at 900 MHz or at 1800 MHz.

Assessed by:

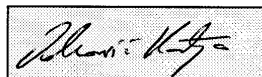

## Dosimetric E-Field Probe ET3DV6 SN:1590

Conversion factor ( $\pm$  standard deviation)

150 MHz	ConvF	9.6 $\pm$ 8%	$\epsilon_r = 52.3 \pm 5\%$ $\sigma = 0.76 \pm 5\%$ mho/m (head tissue)
300 MHz	ConvF	8.3 $\pm$ 8%	$\epsilon_r = 45.3 \pm 5\%$ $\sigma = 0.87 \pm 5\%$ mho/m (head tissue)
450 MHz	ConvF	7.9 $\pm$ 8%	$\epsilon_r = 43.5 \pm 5\%$ $\sigma = 0.87 \pm 5\%$ mho/m (head tissue)
150 MHz	ConvF	9.2 $\pm$ 8%	$\epsilon_r = 61.9 \pm 5\%$ $\sigma = 0.80 \pm 5\%$ mho/m (body tissue)
450 MHz	ConvF	8.1 $\pm$ 8%	$\epsilon_r = 56.7 \pm 5\%$ $\sigma = 0.94 \pm 5\%$ mho/m (body tissue)