



**FCC CFR47 PART 15 SUBPART E**

**DFS TEST REPORT  
FOR**

**INTEL PRO/WIRELESS 3945ABG NETWORK CONNECTION**

**MODEL NUMBER: WM3945ABG**

**FCC ID: PD9WM3945ABG**

**REPORT NUMBER: 06U10569-1**

**ISSUE DATE: OCTOBER 17, 2006**

*Prepared for*

**INTEL**

**2111 N. E. 25TH AVE**

**HILLSBORO, OR 97124**

*Prepared by*

**COMPLIANCE CERTIFICATION SERVICES**

**561F MONTEREY ROAD**

**MORGAN HILL, CA 95037, USA**

**TEL: (408) 463-0885**

**FAX: (408) 463-0888**

**NVLAP<sup>®</sup>**

**LAB CODE:200065-0**

Revision History

<u>Rev.</u>	<u>Issue Date</u>	<u>Revisions</u>	<u>Revised By</u>
--	10/17/06	Initial Issue	AI

## TABLE OF CONTENTS

<b>1. ATTESTATION OF TEST RESULTS.....</b>	<b>4</b>
<b>2. TEST METHODOLOGY .....</b>	<b>5</b>
<b>3. FACILITIES AND ACCREDITATION .....</b>	<b>5</b>
<b>4. CALIBRATION AND UNCERTAINTY.....</b>	<b>5</b>
4.1. MEASURING INSTRUMENT CALIBRATION.....	5
<b>5. EQUIPMENT UNDER TEST.....</b>	<b>6</b>
5.1. DESCRIPTION OF EUT .....	6
5.2. SOFTWARE AND FIRMWARE .....	6
<b>6. TEST AND MEASUREMENT EQUIPMENT .....</b>	<b>7</b>
<b>7. LIMITS AND RESULTS .....</b>	<b>8</b>
7.1. DYNAMIC FREQUENCY SELECTION .....	8
7.1.1. LIMITS .....	8
7.1.2. DESCRIPTION OF EUT .....	11
7.1.3. TEST AND MEASUREMENT SYSTEM .....	12
7.1.4. SETUP OF EUT AND SUPPORT EQUIPMENT .....	16
7.1.5. PLOTS OF NOISE, RADAR WAVEFORMS, AND WLAN SIGNALS.....	18
7.1.6. TEST CHANNEL AND METHOD .....	21
7.1.7. CHANNEL MOVE TIME AND CHANNEL CLOSING TRANSMISSION TIME .....	21
<b>8. SETUP PHOTOS .....</b>	<b>24</b>

# 1. ATTESTATION OF TEST RESULTS

**COMPANY NAME:** Intel  
2111 N. E. 25th Ave  
Hillsboro, OR 97124

**EUT DESCRIPTION:** 802.11 a/b/g Mini-PCI Express Network Adapter

**MODEL TESTED:** WM3945ABG

**SERIAL NUMBER:** 41W026Z1ZB4258R009

**DATE TESTED:** October 16, 2006

APPLICABLE STANDARDS	
STANDARD	TEST RESULTS
FCC PART 15 SUBPART E	NO NON-COMPLIANCE NOTED

Compliance Certification Services, Inc. tested the above equipment in accordance with the requirements set forth in the above standards. The test results show that the equipment tested is capable of demonstrating compliance with the requirements as documented in this report.

**Note:** The results documented in this report apply only to the tested sample, under the conditions and modes of operation as described herein. This document may not be altered or revised in any way unless done so by Compliance Certification Services and all revisions are duly noted in the revisions section. Any alteration of this document not carried out by Compliance Certification Services will constitute fraud and shall nullify the document. No part of this report may be used to claim product certification, approval, or endorsement by NVLAP, NIST, or any government agency.

Approved & Released For CCS By:

Tested By:



ALVIN ILARINA  
ENGINEERING MANAGER  
COMPLIANCE CERTIFICATION SERVICES

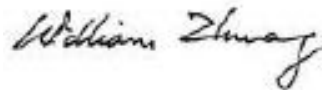

WILLIAM ZHUANG  
EMC ENGINEER  
COMPLIANCE CERTIFICATION SERVICES

## 2. TEST METHODOLOGY

The tests documented in this report were performed in accordance with ANSI C63.4-2003, FCC CFR 47 Part 2, FCC CFR 47 Part 15 and FCC 06-96 APPENDIX "COMPLIANCE MEASUREMENT PROCEDURES FOR UNLICENSED-NATIONAL INFORMATION INFRASTRUCTURE DEVICES OPERATING IN THE 5250-5350 MHz AND 5470-5725 MHz BANDS INCORPORATING DYNAMIC FREQUENCY SELECTION".

## 3. FACILITIES AND ACCREDITATION

The test sites and measurement facilities used to collect data are located at 561F Monterey Road, Morgan Hill, California, USA. The sites are constructed in conformance with the requirements of ANSI C63.4, ANSI C63.7 and CISPR Publication 22. All receiving equipment conforms to CISPR Publication 16-1, "Radio Interference Measuring Apparatus and Measurement Methods."

CCS is accredited by NVLAP, Laboratory Code 200065-0. The full scope of accreditation can be viewed at <http://www.ccsemc.com>.

## 4. CALIBRATION AND UNCERTAINTY

### 4.1. MEASURING INSTRUMENT CALIBRATION

The measuring equipment utilized to perform the tests documented in this report has been calibrated in accordance with the manufacturer's recommendations, and is traceable to recognized national standards.

## **5. EQUIPMENT UNDER TEST**

### **5.1. DESCRIPTION OF EUT**

The WM3945ABG is an 802.11 a/b/g Mini-PCI Express Network Adapter

### **5.2. SOFTWARE AND FIRMWARE**

The EUT driver software installed in the host support equipment during testing was 10.5.1.59.

The software version of the Access Point was 12.3.8JEA.

## 6. TEST AND MEASUREMENT EQUIPMENT

The following test and measurement equipment was utilized for the tests documented in this report:

TEST EQUIPMENT LIST				
Description	Manufacturer	Model	Serial Number	Cal Due
Spectrum Analyzer 3 Hz ~ 44 GHz	Agilent / HP	E4446A	US42070220	12/19/2006
Vector Signal Generator 250kHz-20GHz	Agilent / HP	E8267C	US43320336	11/2/2007

## 7. LIMITS AND RESULTS

### 7.1. DYNAMIC FREQUENCY SELECTION

#### 7.1.1. LIMITS

§15.407 (h) and FCC 06-96 APPENDIX “COMPLIANCE MEASUREMENT PROCEDURES FOR UNLICENSED-NATIONAL INFORMATION INFRASTRUCTURE DEVCIES OPERATING IN THE 5250-5350 MHz AND 5470-5725 MHz BANDS INCORPORATING DYNAMIC FREQUENCY SELECTION”.

**Table 1: Applicability of DFS requirements prior to use of a channel**

Requirement	Operational Mode		
	Master	Client (without radar detection)	Client (with radar detection)
<i>Non-Occupancy Period</i>	Yes	Not required	Yes
<i>DFS Detection Threshold</i>	Yes	Not required	Yes
<i>Channel Availability Check Time</i>	Yes	Not required	Not required
<i>Uniform Spreading</i>	Yes	Not required	Not required

**Table 2: Applicability of DFS requirements during normal operation**

Requirement	Operational Mode		
	Master	Client (without DFS)	Client (with DFS)
<i>DFS Detection Threshold</i>	Yes	Not required	Yes
<i>Channel Closing Transmission Time</i>	Yes	Yes	Yes
<i>Channel Move Time</i>	Yes	Yes	Yes



**Table 3: Interference Threshold values, Master or Client incorporating In-Service Monitoring**

Maximum Transmit Power	Value (see note)
≥ 200 milliwatt	-64 dBm
< 200 milliwatt	-62 dBm
Note 1: This is the level at the input of the receiver assuming a 0 dBi receive antenna Note 2: Throughout these test procedures an additional 1 dB has been added to the amplitude of the test transmission waveforms to account for variations in measurement equipment. This will ensure that the test signal is at or above the detection threshold level to trigger a DFS response.	

**Table 4: DFS Response requirement values**

Parameter	Value
<i>Non-occupancy period</i>	30 minutes
<i>Channel Availability Check Time</i>	60 seconds
<i>Channel Move Time</i>	10 seconds
<i>Channel Closing Transmission Time</i>	200 milliseconds + approx. 60 milliseconds over remaining 10 second period
The instant that the <i>Channel Move Time</i> and the <i>Channel Closing Transmission Time</i> begins is as follows: <ul style="list-style-type: none"> <li>• For the Short pulse radar Test Signals this instant is the end of the <i>Burst</i>.</li> <li>• For the Frequency Hopping radar Test Signal, this instant is the end of the last radar burst generated.</li> <li>• For the Long Pulse radar Test Signal this instant is the end of the 12 second period defining the radar transmission.</li> </ul> The Channel Closing Transmission Time is comprised of 200 milliseconds starting at the beginning of the Channel Move Time plus any additional intermittent control signals required to facilitate channel changes (an aggregate of approximately 60 milliseconds) during the remainder of the 10 second period. The aggregate duration of control signals will not count quiet periods in between transmissions.	

**Table 5 – Short Pulse Radar Test Waveforms**

Radar Type	Pulse Width (Microseconds)	PRI (Microseconds)	Pulses	Minimum Percentage of Successful Detection	Minimum Trials
1	1	1428	18	60%	30
2	1-5	150-230	23-29	60%	30
3	6-10	200-500	16-18	60%	30
4	11-20	200-500	12-16	60%	30
Aggregate (Radar Types 1-4)				80%	120

**Table 6 – Long Pulse Radar Test Signal**

Radar Waveform	Bursts	Pulses per Burst	Pulse Width (µsec)	Chirp Width (MHz)	PRI (µsec)	Minimum Percentage of Successful Detection	Minimum Trials
5	8-20	1-3	50-100	5-20	1000-2000	80%	30

**Table 7 – Frequency Hopping Radar Test Signal**

Radar Waveform	Pulse Width (µsec)	PRI (µsec)	Burst Length (ms)	Pulses per Hop	Hopping Rate (kHz)	Minimum Percentage of Successful Detection	Minimum Trials
6	1	333	300	9	.333	70%	30

## 7.1.2. DESCRIPTION OF EUT

### **OVERVIEW OF EUT WITH RESPECT TO §15.407 (h) REQUIREMENTS**

The EUT operates over the 5250-5350 MHz band.

The EUT is a Client Device that does not have radar detection capability. The FCC identifier for the Master Device used with it for DFS testing is LDK102056.

The maximum antenna gain of the antenna assembly is 2.86 dBi in the 5250-5350 MHz band. The highest power level is 21.2 dBm EIRP.

TPC is not required since the maximum EIRP is less than 500 mW (27 dBm).

Both of the 50-ohm antenna ports are connected to the test system via a power combiner/divider to perform conducted tests.

WLAN traffic is generated by streaming the video file TestFile.mp2 “6 ½ Magic Hours” from the Master to the Slave in full motion video mode using the media player with the V2.61 Codec package.

The EUT utilizes an 802.11a IP based architecture with a 20 MHz nominal channel bandwidth.

### **OVERVIEW OF MASTER DEVICE WITH RESPECT TO §15.407 (h) REQUIREMENTS**

The Master Device is a Cisco Aironet 1200 AG Series Access Point, FCC ID: LDK102056.

The rated output power of the Master unit is > 23dBm (EIRP). Therefore the required interference threshold level is -64 dBm.

The calibrated conducted DFS Detection Threshold level is set to -64 dBm.

### **7.1.3. TEST AND MEASUREMENT SYSTEM**

#### **SYSTEM OVERVIEW**

The measurement system is based on a conducted test method.

The short pulse and long pulse signal generating system utilizes the NTIA software and the same manufacturer / model Vector Signal Generator as the NTIA. The hopping signal generating system utilizes the simulated hopping method.

The software selects waveform parameters from within the bounds of the signal type on a random basis using uniform distribution. The short pulse types 2, 3 and 4, and the long pulse type 5 parameters are randomized at run-time. The hopping type 6 pulse parameters are fixed while the hopping sequence is based on the August 2005 NTIA Hopping Frequency List, with the initial starting point randomized at run-time.

The signal monitoring equipment consists of a spectrum analyzer with the capacity to display 8192 bins on the horizontal axis. A time-domain resolution of 2 msec / bin is achievable with a 16 second sweep time, meeting the 10 second short pulse reporting criteria. The aggregate ON time is calculated by multiplying the number of bins above a threshold during a particular observation period by the dwell time per bin, with the analyzer set to peak detection and max hold. A time-domain resolution of 3 msec / bin is achievable with a 24 second sweep time, meeting the 22 second long pulse reporting criteria and allowing a minimum of 10 seconds after the end of the long pulse waveform.

#### **FREQUENCY HOPPING SIGNAL GENERATION**

The hopping burst generator is a High Speed Digital I/O card plugged into the control computer. This card utilizes an independent hardware clock reference therefore the output pulse timing is unaffected by host computer operating system latency times.

The software selects the hopping sequence as a 100-length segment of the August 2005 NTIA hopping frequency list. This list contains 274 unique pseudorandom sequences. Each such sequence contains 475 frequencies ordered on a random without replacement basis. Each successive trial uses a contiguous 100-length segment from within each successive 475-length sequence in the list. The initial starting point within the list is randomized at run-time such that the first 100-length segment is entirely contained within the first 475-length sequence. The starting point of each successive trial is incremented by 475.

Each frequency in the 100-length segment is compared to the boundaries of the EUT Detection Bandwidth and the software creates a hopping burst pattern in accordance with Section 7.4.1.3 Method #2 Simulated Frequency Hopping Radar Waveform Generating Subsystem of FCC 06-96 APPENDIX. The frequency of the signal generator is incremented in 1 MHz steps from  $F_L$  to  $F_H$  for each successive trial. This incremental sequence is repeated as required to generate a minimum of 30 total trials and to maintain a uniform frequency distribution over the entire Detection Bandwidth.

**CONDUCTED METHOD SYSTEM BLOCK DIAGRAM**

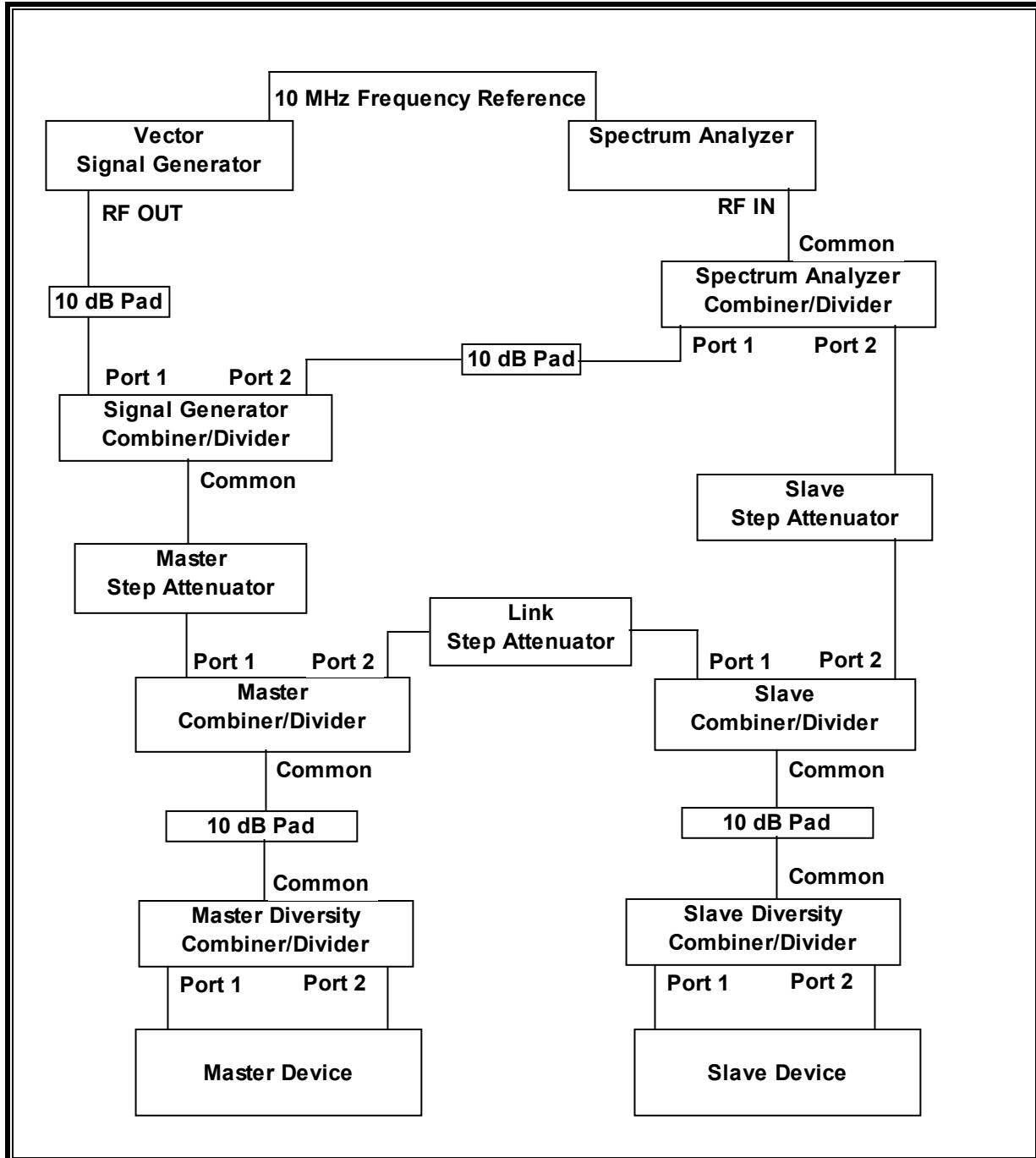

## **MEASUREMENT SYSTEM FREQUENCY REFERENCE**

Lock the signal generator and the spectrum analyzer to the same reference source as follows: Connect the 10 MHz OUT (SWITCHED) on the spectrum analyzer to the 10 MHz IN on the signal generator and set the spectrum analyzer 10 MHz Out to On.

## **SYSTEM CALIBRATION**

Adjust the Master Step Attenuator to 30 dB, the Link Step Attenuator to 70 dB, and the Slave Step Attenuator to 70 dB.

If required, disconnect the spectrum analyzer, Master Device, and Slave Device from the test system. Terminate the Common port of the Spectrum Analyzer Combiner/Divider, Port 2 of the Master Diversity Combiner/Divider, and Ports 1 and 2 of the Slave Diversity Combiner/Divider. Leave, or connect, the appropriate cable to Port 1 of the Master Diversity Combiner/Divider and connect the free end (Master Device end) of this cable to the spectrum analyzer.

Adjust the signal generator and spectrum analyzer to the center frequency of the channel to be measured. Set the signal generator to CW mode. Set the RBW of the spectrum analyzer to 10 kHz and the span to 100 kHz. Adjust the amplitude of the signal generator to yield a measured level of -64 dBm on the spectrum analyzer.

Without changing any of the instrument settings, reconnect the spectrum analyzer to the Common port of the Spectrum Analyzer Combiner/Divider, then remove the cable from Port 1 of the Master Diversity Combiner/Divider and replace this cable with a termination. Measure the amplitude and calculate the difference from -64 dBm. Adjust the Reference Level Offset of the spectrum analyzer to this difference. Confirm that the signal is displayed at -64 dBm. Readjust the RBW and VBW to 3 MHz, set the span to 10 MHz, and confirm that the signal is still displayed at -64 dBm.

This Reference Level Offset setting is used for all tests for which the Master Step Attenuator is set to 30 dB. The spectrum analyzer displays the level of the signal generator as received at the antenna ports of the Master Device. The interference detection threshold may be varied from the calibrated value of -64 dBm and the spectrum analyzer will still indicate the level as received by the Master Device.

The Link Step Attenuator and Slave Step Attenuator settings may be changed without affecting the System Calibration. The System Calibration process must be repeated for different settings of the Master Step Attenuator to determine the Reference Level Offset associated with each Master Step Attenuator setting.

### **INTERFERENCE DETECTION THRESHOLD ADJUSTMENT**

Set the signal generator to produce the specified radar waveform, trigger a burst manually and measure the amplitude on the spectrum analyzer. Readjust the amplitude of the signal generator as required so that the peak level of the waveform is at a displayed level equal to the required or desired interference detection threshold.

### **ADJUSTMENT OF DISPLAYED TRAFFIC LEVEL**

Establish a link between the Master and Slave, adjusting the Link Step Attenuator as needed to provide an adequate RSS level at the Master and Slave devices. Stream the video test file to generate WLAN traffic. Adjust the Slave Step Attenuator so that the WLAN traffic level from the Slave, as displayed on the spectrum analyzer, is at lower amplitude than the radar detection threshold.

Confirm that the displayed traffic is from the Slave Device by changing the setting of the Slave Step Attenuator and verifying that the displayed traffic level changes accordingly. Confirm that the displayed traffic does not include Master Device traffic by changing the setting of the Master Step Attenuator and the Link Step Attenuator and verifying that the displayed traffic level does not change. Reset all Step Attenuators to their previous settings.

If the above conditions cannot be met, use a different setting of the Master Step Attenuator, performing a new System Calibration and Interference Detection Threshold Adjustment as required for the new Master Step Attenuator setting.

### 7.1.4. SETUP OF EUT AND SUPPORT EQUIPMENT

#### SUPPORT EQUIPMENT

PERIPHERAL SUPPORT EQUIPMENT LIST				
Description	Manufacturer	Model	Serial Number	FCC ID
AC Adapter	Delta	34-1977-03	PZT0628359656	DoC
Access Point	Cisco	Aironet 1200 AG	FTX1035B0EB	LDK102056
Laptop	IBM	ThinkPad X60	AA-GH38D	DoC
AC Adapter	IBM	92P1154	9IW0529000190	DoC
Laptop	Dell	Latitude D610	433598	DoC
AC Adapter	Dell	PA-1900-02D	CN-09T215-48010-38P-1AC8	DoC

#### I/O CABLES

I/O CABLE LIST					
Cable No.	Port	# of Identical Ports	Connector Type	Cable Type	Cable Length
1	AC	1	US 115V	Direct Plug	0m
2	DC	1	DC	Un-shielded	2m
3	AC	1	US 115V	Un-shielded	1m
4	DC	1	DC	Un-shielded	2m
5	Ethernet	1	RJ45	Un-shielded	2m
6	Serial	1	USB to DIN	Shielded	2.5m
7	AC	1	US 115V	Un-shielded	2m
8	DC	1	DC	Un-shielded	2m



**TEST SETUP**

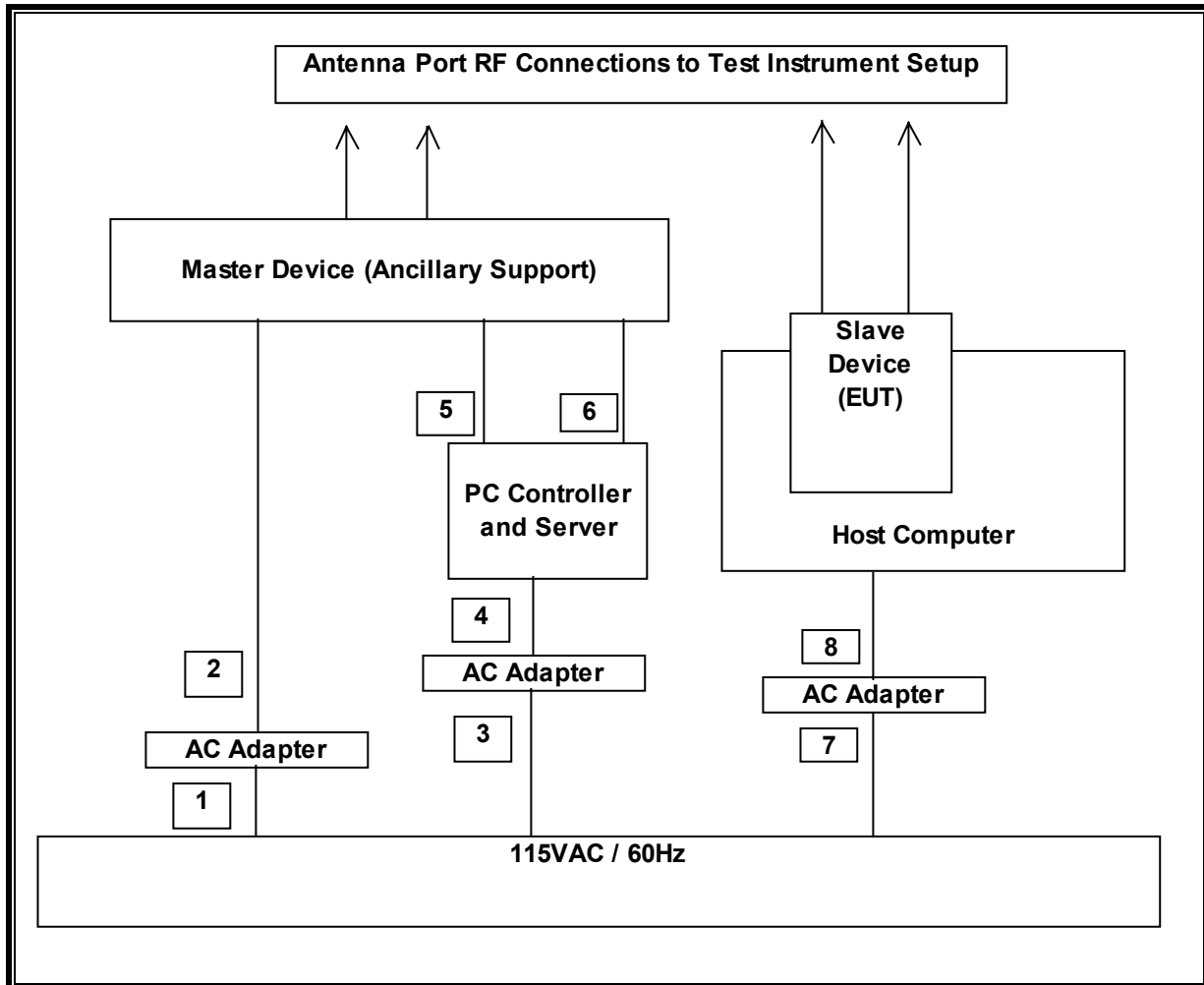

### 7.1.5. PLOTS OF NOISE, RADAR WAVEFORMS, AND WLAN SIGNALS

#### PLOT OF SYSTEM NOISE FLOOR

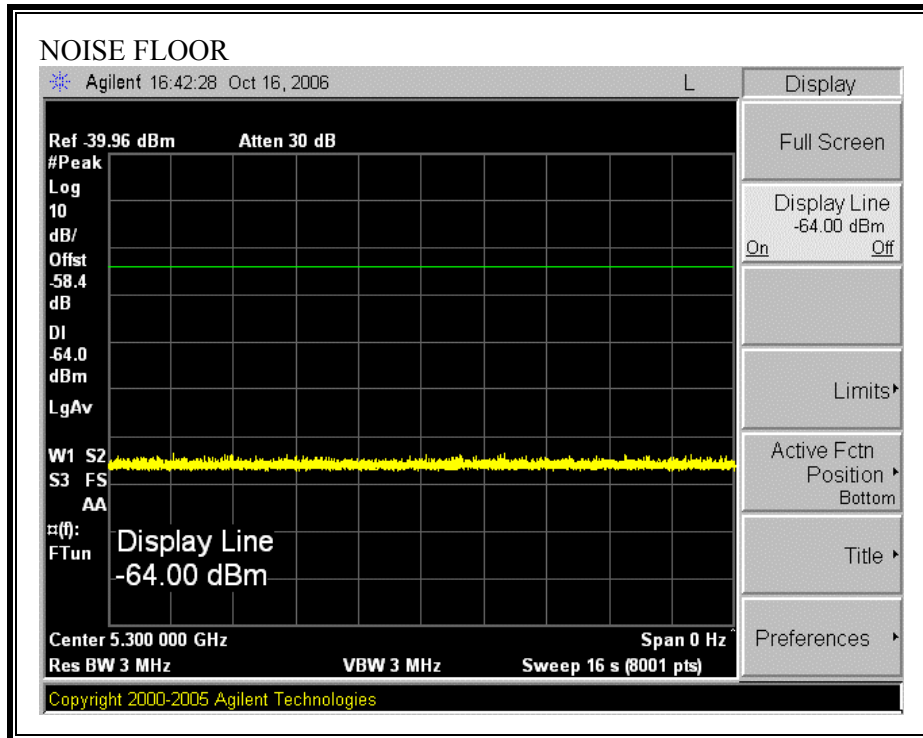

**PLOTS OF RADAR WAVEFORM**

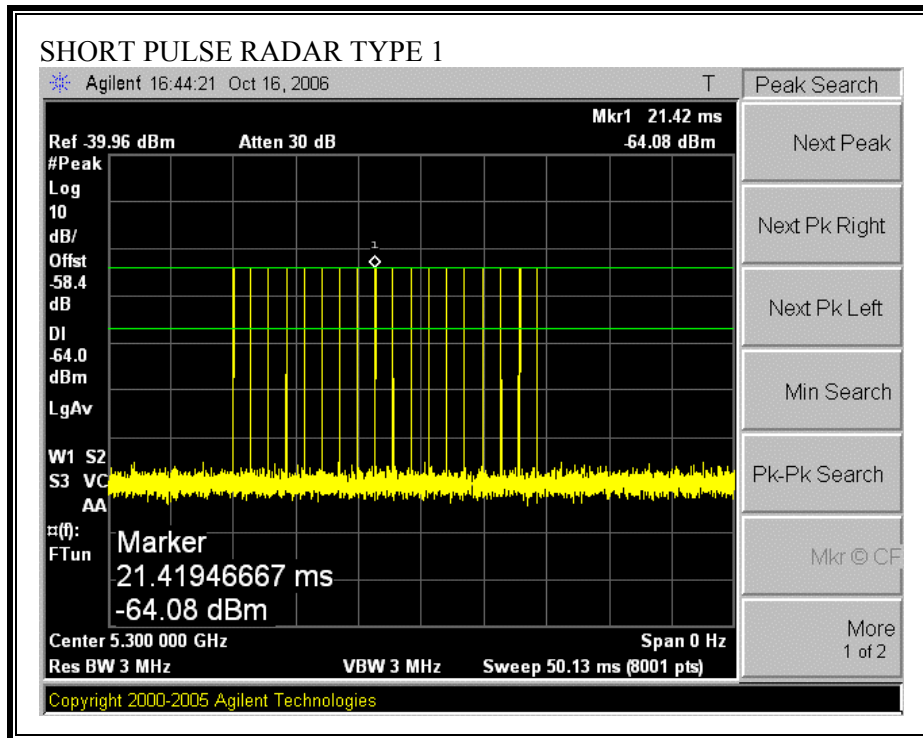

**PLOT OF WLAN TRAFFIC FROM SLAVE**

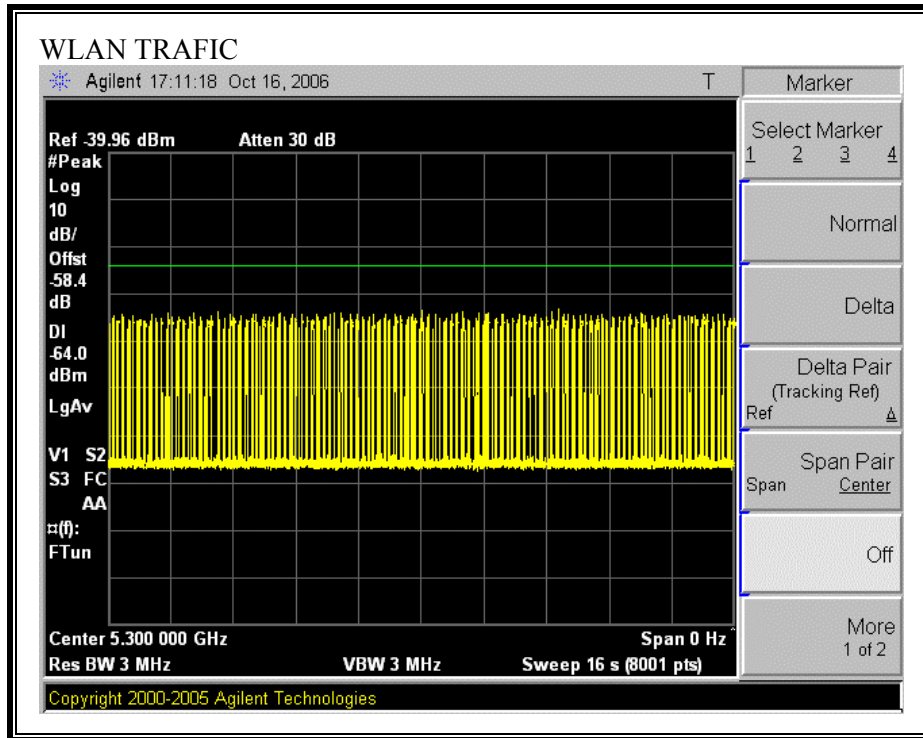

### **7.1.6. TEST CHANNEL AND METHOD**

All tests were performed at a channel center frequency of 5300 MHz utilizing a conducted test method.

### **7.1.7. CHANNEL MOVE TIME AND CHANNEL CLOSING TRANSMISSION TIME**

#### **GENERAL REPORTING NOTES**

The reference marker is set at the end of last radar pulse.

The delta marker is set at the end of the last WLAN transmission following the radar pulse. This delta is the channel move time.

The aggregate channel closing transmission time is calculated as follows:

Aggregate Transmission Time =  
(Number of analyzer bins showing transmission) \* (dwell time per bin)

The observation period over which the aggregate time is calculated  
Begins at (Reference Marker + 200 msec)  
and  
Ends no earlier than (Reference Marker + 10 sec).

**TYPE 1 CHANNEL MOVE TIME RESULTS**

No non-compliance noted:

Channel Move Time (s)	Limit (s)
0.000	10

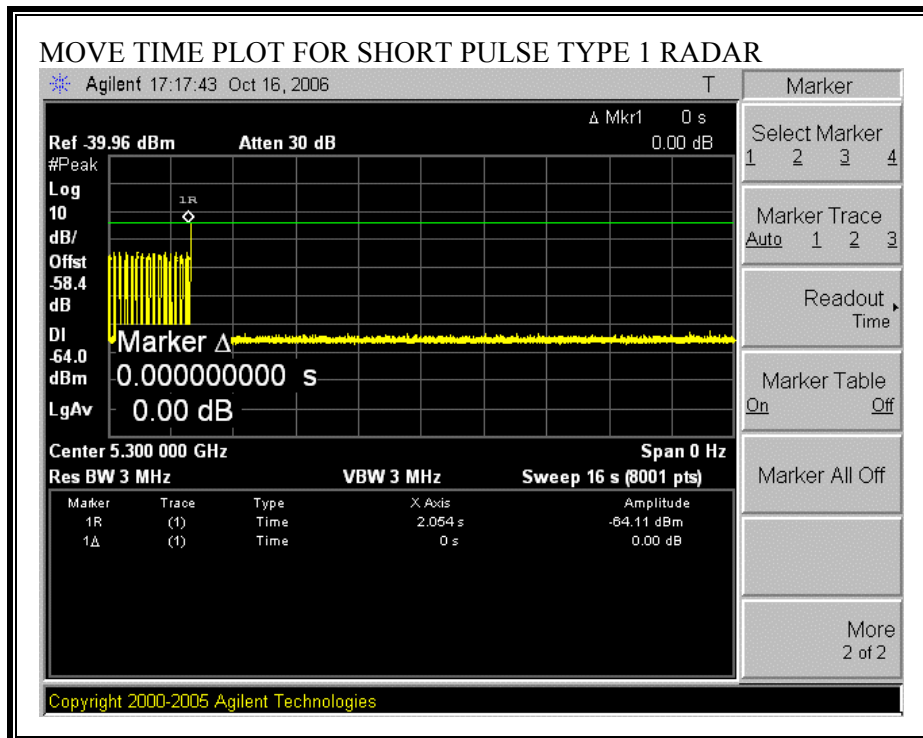

**TYPE 1 CHANNEL CLOSING TRANSMISSION TIME RESULTS**

No non-compliance noted:

Aggregate Transmission Time (ms)	Limit (ms)	Margin (ms)
0.00	60	60.00

Only intermittent transmissions are observed during the aggregate monitoring period.

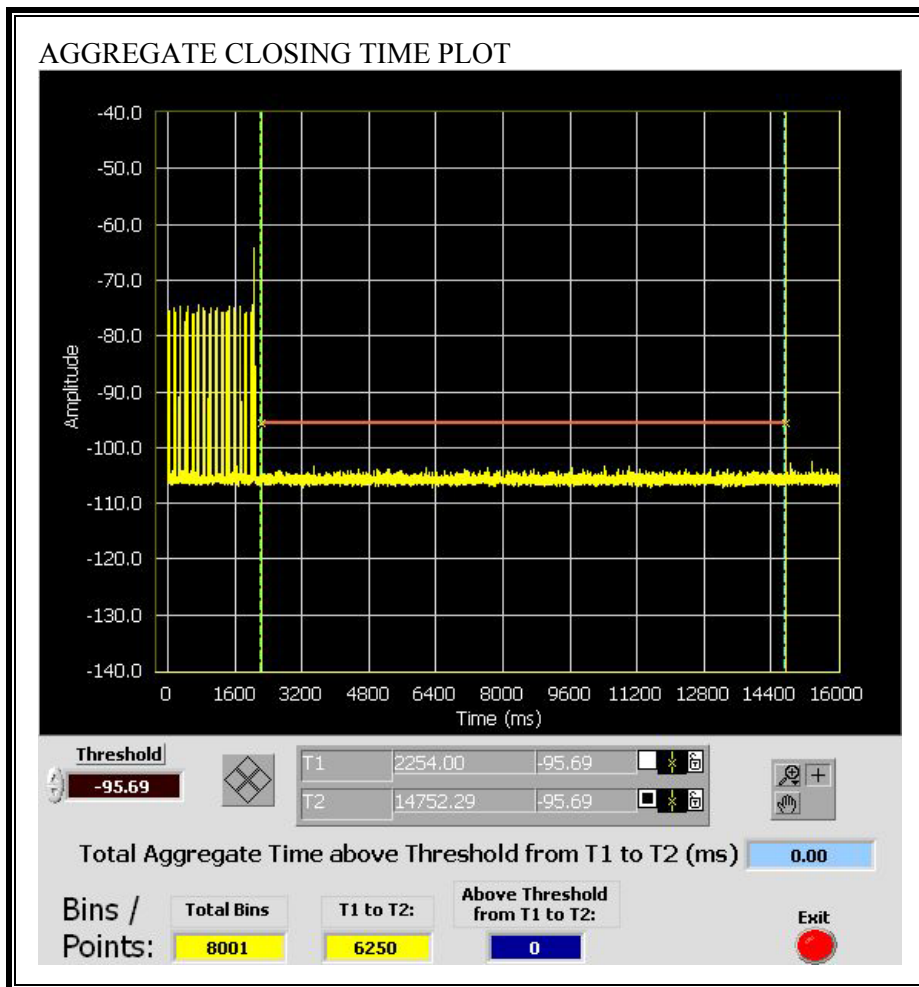

## 8. SETUP PHOTOS

### DYNAMIC FREQUENCY SELECTION MEASUREMENT SETUP

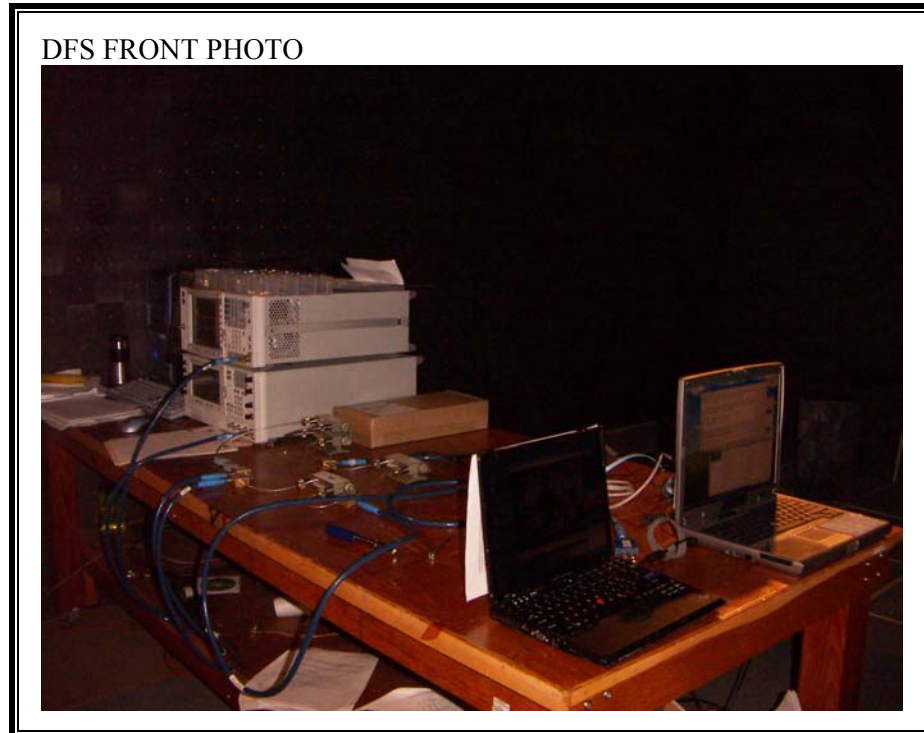



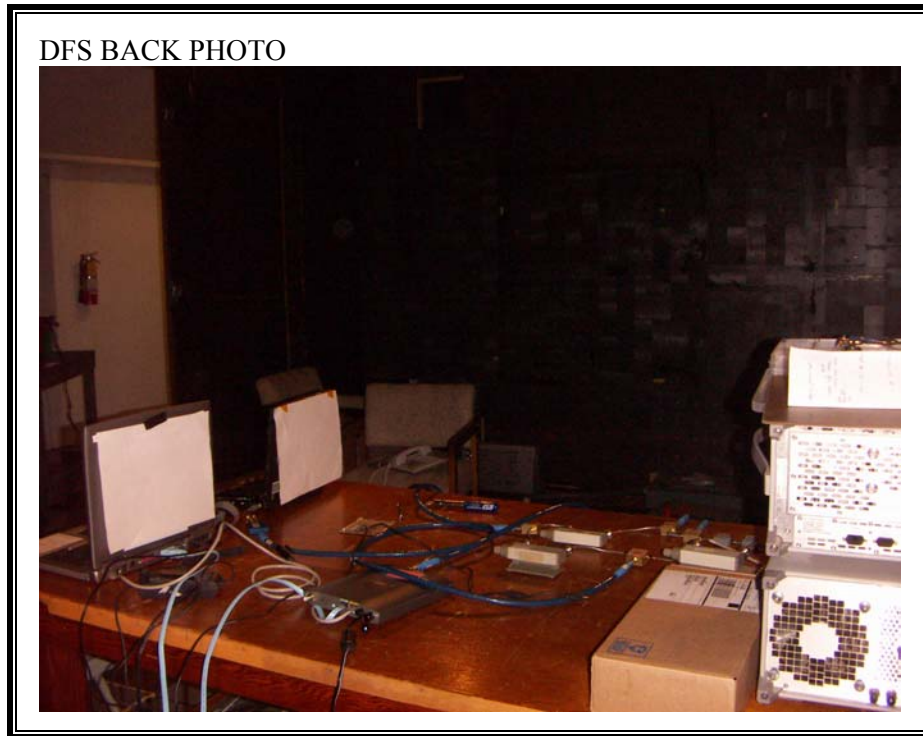

**END OF REPORT**