



# FCC TEST REPORT

**REPORT NO.:** RF941201H04

**MODEL NO.:** WUA-2340

**RECEIVED:** Dec. 01, 2005

**TESTED:** Dec. 06 to 08, 2005

**ISSUED:** Dec. 09, 2005

**APPLICANT:** D-LINK Corporation

**ADDRESS:** No.8, Li-shing 7th Rd. Science-based Industrial Park, Hsinchu, Taiwan. R.O.C.

**ISSUED BY:** Advance Data Technology Corporation

**LAB LOCATION:** No. 81-1, Lu Liao Keng, 9 Ling, Wu Lung Tsuen, Chiung Lin Hsiang, Hsin Chu Hsien, Taiwan, R.O.C.

This test report consists of 74 pages in total. It may be duplicated completely for legal use with the approval of the applicant. It should not be reproduced except in full, without the written approval of our laboratory. The client should not use it to claim product endorsement by CNLA, A2LA or any government agencies. The test results in the report only apply to the tested sample. The test results in this report are traceable to the national or international standards.



0536  
ILAC MRA



No. 2177-01



## Table of Contents

1	CERTIFICATION .....	4
2	SUMMARY OF TEST RESULTS .....	5
3	GENERAL INFORMATION .....	6
3.1	GENERAL DESCRIPTION OF EUT .....	6
3.2	DESCRIPTION OF TEST MODES .....	7
3.3	TEST MODE APPLICABILITY AND TESTED CHANNEL DETAIL: .....	8
3.4	GENERAL DESCRIPTION OF APPLIED STANDARDS.....	10
3.5	DESCRIPTION OF SUPPORT UNITS .....	11
3.6	CONFIGURATION OF SYSTEM UNDER TEST .....	12
4	TEST TYPES AND RESULTS .....	13
4.1	CONDUCTED EMISSION MEASUREMENT .....	13
4.1.1	LIMITS OF CONDUCTED EMISSION MEASUREMENT .....	13
4.1.2	TEST INSTRUMENTS.....	13
4.1.3	TEST PROCEDURES .....	14
4.1.4	TEST SETUP .....	14
4.1.5	EUT OPERATING CONDITIONS .....	15
4.1.6	TEST RESULTS .....	16
4.2	RADIATED EMISSION MEASUREMENT .....	18
4.2.1	LIMITS OF RADIATED EMISSION MEASUREMENT .....	18
4.2.2	TEST INSTRUMENTS.....	19
4.2.3	TEST PROCEDURES .....	20
4.2.4	TEST SETUP .....	21
4.2.5	EUT OPERATING CONDITIONS .....	22
4.2.6	TEST RESULTS .....	23
4.2.7	TEST RESULTS – DSSS.....	25
4.2.8	TEST RESULTS – OFDM.....	28
4.3	6dB BANDWIDTH MEASUREMENT .....	32
4.3.1	LIMITS OF 6DB BANDWIDTH MEASUREMENT .....	32
4.3.2	TEST INSTRUMENTS.....	32
4.3.3	TEST PROCEDURE.....	33
4.3.4	TEST SETUP .....	33



4.3.5 EUT OPERATING CONDITIONS ..... 33

4.3.6 TEST RESULTS –DSSS..... 34

4.3.7 TEST RESULTS-OFDM ..... 37

4.4 MAXIMUM PEAK OUTPUT POWER ..... 42

4.4.1 LIMITS OF MAXIMUM PEAK OUTPUT POWER MEASUREMENT ..... 42

4.4.2 TEST INSTRUMENTS..... 42

4.4.3 TEST PROCEDURES ..... 43

4.4.4 TEST SETUP ..... 43

4.4.5 EUT OPERATING CONDITIONS ..... 43

4.4.6 TEST RESULTS – DSSS..... 44

4.4.7 TEST RESULTS –OFDM..... 45

4.5 POWER SPECTRAL DENSITY MEASUREMENT ..... 46

4.5.1 LIMITS OF POWER SPECTRAL DENSITY MEASUREMENT..... 46

4.5.2 TEST INSTRUMENTS..... 46

4.5.3 TEST PROCEDURE..... 47

4.5.4 TEST SETUP ..... 47

4.5.5 EUT OPERATING CONDITIONS ..... 47

4.5.6 TEST RESULTS –DSSS..... 48

4.5.7 TEST RESULTS –OFDM..... 51

4.6 BAND EDGES MEASUREMENT ..... 56

4.6.1 LIMITS OF BAND EDGES MEASUREMENT ..... 56

4.6.2 TEST INSTRUMENTS..... 56

4.6.3 TEST PROCEDURE..... 56

4.6.4 EUT OPERATING CONDITION..... 56

4.6.5 TEST RESULTS – DSSS..... 57

4.6.6 TEST RESULTS –OFDM..... 61

4.7 ANTENNA REQUIREMENT ..... 69

4.7.1 STANDARD APPLICABLE ..... 69

4.7.2 ANTENNA CONNECTED CONSTRUCTION ..... 69

5 PHOTOGRAPHS OF THE TEST CONFIGURATION ..... 70

6 INFORMATION ON THE TESTING LABORATORIES ..... 73

APPENDIX-A..... A-1



## 1 CERTIFICATION

**PRODUCT :** Wireless USB Adapter  
**BRAND NAME :** D-Link  
**MODEL NO. :** WUA-2340  
**TESTED:** Dec. 06 to 08, 2005  
**APPLICANT :** D-LINK Corporation  
**TEST ITEM:** ENGINEERING SAMPLE  
**STANDARDS :** 47 CFR Part 15, Subpart C (Section 15.247),  
ANSI C63.4-2003

The above equipment (Model: WUA-2340) has been tested by **Advance Data Technology Corporation**, and found compliance with the requirement of the above standards. The test record, data evaluation & Equipment Under Test (EUT) configurations represented herein are true and accurate accounts of the measurements of the sample's EMC characteristics under the conditions specified in this report.

**PREPARED BY :** Carol Liao , **DATE:** Dec. 09, 2005  
( Carol Liao )

**TECHNICAL ACCEPTANCE :** Hank Chung , **DATE:** Dec. 09, 2005  
Responsible for RF ( Hank Chung )

**APPROVED BY :** May Chen , **DATE:** Dec. 09, 2005  
( May Chen, Deputy Manager )



## 2 SUMMARY OF TEST RESULTS

The EUT has been tested according to the following specifications:

<b>APPLIED STANDARD: 47 CFR Part 15, Subpart C</b>			
<b>Standard Section</b>	<b>Test Type and Limit</b>	<b>Result</b>	<b>REMARK</b>
15.207	AC Power Conducted Emission	PASS	Meet the requirement of limit Minimum passing margin is -13.72 dB at 0.998 MHz
15.247(a)(2)	Spectrum Bandwidth of a Direct Sequence Spread Spectrum System Limit: min. 500kHz	PASS	Meet the requirement of limit
15.247(b)	Maximum Peak Output Power Limit: max. 30dBm	PASS	Meet the requirement of limit
15.247(c)	Transmitter Radiated Emissions Limit: Table 15.209	PASS	Meet the requirement of limit Minimum passing margin is -2.7 dB at 2016.00 MHz
15.247(d)	Power Spectral Density Limit: max. 8dBm	PASS	Meet the requirement of limit
15.247(c)	Band Edge Measurement Limit: 20 dB less than the peak value of fundamental frequency	PASS	Meet the requirement of limit



### 3 GENERAL INFORMATION

#### 3.1 GENERAL DESCRIPTION OF EUT

<b>PRODUCT</b>	Wireless USB Adapter
<b>MODEL NO.</b>	WUA-2340
<b>POWER SUPPLY</b>	DC 5V from host equipment
<b>MODULATION TYPE</b>	CCK, DQPSK, DBPSK for DSSS 64QAM, 16QAM, QPSK, BPSK for OFDM
<b>RADIO TECHNOLOGY</b>	DSSS, OFDM
<b>TRANSFER RATE</b>	802.11b: 11/5.5/2/1Mbps 802.11g: 54/48/36/24/18/12/9/6Mbps (Turbo mode: up to 108Mbps *see Note 3)
<b>FREQUENCY RANGE</b>	802.11b & 802.11g: 2412 ~ 2462MHz
<b>NUMBER OF CHANNEL</b>	802.11b & 802.11g: 11 (1 for 802.11g Turbo mode)
<b>CHANNEL SPACING</b>	802.11b & 802.11g: 5MHz
<b>OUTPUT POWER</b>	802.11b: 51.286mW 802.11g: 79.433mW
<b>ANTENNA TYPE</b>	Printed antenna with -2.0dBi antenna gain
<b>DATA CABLE</b>	USB cradle (Shielded 1.5m)
<b>INTERFACE</b>	USB
<b>ASSOCIATED DEVICES</b>	cradle

#### NOTE:

1. The EUT operates in both the 2.4GHz Bands and compatibility with 802.11b, 802.11g technology.
2. The EUT is capable of providing data rates of up to 108 Mbps in 802.11g Turbo mode depending upon reception quality.
3. The above EUT information was declared by the manufacturer and for more detailed features description, please refer to the manufacturer's specifications or User's Manual.



### 3.2 DESCRIPTION OF TEST MODES

Operated in 2400 ~ 2483.5MHz band:

For 802.11b/g normal mode: Eleven channels are provided to this EUT.

Channel	Frequency	Channel	Frequency
1	2412 MHz	7	2442 MHz
2	2417 MHz	8	2447 MHz
3	2422 MHz	9	2452 MHz
4	2427 MHz	10	2457 MHz
5	2432 MHz	11	2462 MHz
6	2437 MHz		

For 802.11g turbo mode: One channel is provided to this EUT

Channel	Frequency
6	2437 MHz



**3.3 TEST MODE APPLICABILITY AND TESTED CHANNEL DETAIL:**

EUT configure mode	Applicable to				Description
	PLC	RE<1G	RE≥1G	APCM	
-	X	X	X	X	NA

Where PLC: Power Line Conducted Emission RE<1G RE: Radiated Emission below 1GHz  
 RE≥1G: Radiated Emission above 1GHz APCM: Antenna Port Conducted Measurement

**Power Line Conducted Emission Test:**

- Pre-Scan has been conducted to determine the worst-case mode from all possible combinations between available modulations, data rates and antenna ports (if EUT with antenna diversity architecture).
- Following channel(s) was (were) selected for the final test as listed below.

Mode	Available Channel	Tested Channel	Modulation Technology	Modulation Type	Data Rate (Mbps)
802.11g	1 to 11	11	OFDM	BPSK	6

- The EUT was pre-tested in chamber as the following test modes:

Test Mode	Power
Mode 1	With USB cradle
Mode 2	Without USB cradle

Mode 1, the worse case one, was chosen for final test.

**Radiated Emission Test (Below 1 GHz):**

- Pre-Scan has been conducted to determine the worst-case mode from all possible combinations between available modulations, data rates and antenna ports (if EUT with antenna diversity architecture).
- Following channel(s) was (were) selected for the final test as listed below.

Mode	Available Channel	Tested Channel	Modulation Technology	Modulation Type	Data Rate (Mbps)
802.11g	1 to 11	11	OFDM	BPSK	6

- The EUT was tested with the following modes:

Test Mode	Description
Mode 1	Without USB cradle
Mode 2	With USB cradle





**Radiated Emission Test (Above 1 GHz):**

- Pre-Scan has been conducted to determine the worst-case mode from all possible combinations between available modulations, data rates and antenna ports (if EUT with antenna diversity architecture).
- Following channel(s) was (were) selected for the final test as listed below.

Mode	Available Channel	Tested Channel	Modulation Technology	Modulation Type	Data Rate (Mbps)
802.11b	1 to 11	1, 6, 11	DSSS	CCK	11
802.11g	1 to 11	1, 6, 11	OFDM	BPSK	6
802.11g turbo	6	6	OFDM	BPSK	12

- The EUT was pre-tested in chamber as the following test modes:

Test Mode	Power
Mode 1	With USB cradle
Mode 2	Without USB cradle

Mode 1, the worse case one, was chosen for final test.

**Bandedge Measurement:**

- Pre-Scan has been conducted to determine the worst-case mode from all possible combinations between available modulations, data rates and antenna ports (if EUT with antenna diversity architecture).
- Following channel(s) was (were) selected for the final test as listed below.

Mode	Available Channel	Tested Channel	Modulation Technology	Modulation Type	Data Rate (Mbps)
802.11b	1 to 11	1, 11	DSSS	CCK	11
802.11g	1 to 11	1, 11	OFDM	BPSK	6
802.11g turbo	6	6	OFDM	BPSK	12

**Antenna Port Conducted Measurement:**

- Pre-Scan has been conducted to determine the worst-case mode from all possible combinations between available modulations, data rates and antenna ports (if EUT with antenna diversity architecture).
- Following channel(s) was (were) selected for the final test as listed below.

Mode	Available Channel	Tested Channel	Modulation Technology	Modulation Type	Data Rate (Mbps)
802.11b	1 to 11	1, 6, 11	DSSS	CCK	11
802.11g	1 to 11	1, 6, 11	OFDM	BPSK	6
802.11g turbo	6	6	OFDM	BPSK	12



### **3.4 GENERAL DESCRIPTION OF APPLIED STANDARDS**

The EUT is a Wireless USB Adapter. According to the specifications of the manufacturer, it must comply with the requirements of the following standards:

**47 CFR Part 15, Subpart C. (15.247)**  
**ANSI C63.4 : 2003**

All tests have been performed and recorded as per the above standards.

**NOTE:** The EUT is also considered as a kind of computer peripheral, because the connection to computer is necessary for typical use. It has been verified to comply with the requirements of 47 CFR Part 15, Subpart B, Class B (DoC). The test report has been issued separately.



### 3.5 DESCRIPTION OF SUPPORT UNITS

The EUT has been tested as an independent unit together with other necessary accessories or support units. The following support units or accessories were used to form a representative test configuration during the tests.

No.	Product	Brand	Model No.	Serial No.	FCC ID
1	NOTEBOOK COMPUTER	DELL	PP05L	CN-04Y212-48643- 38E-0145	NA
2	PRINTER	HP	C2642A	MY79F1C3MZ	B94C2642X
3	MODEM	ACEEX	1414	0206026775	IFAXDM1414

No.	Signal cable description
1	NA
2	1.8 m braid shielded wire, terminated with DB25 and Centronics connector via metallic frame, w/o core.
3	1.3 m braid shielded wire, terminated with DB25 and DB9 connector via metallic frame, w/o core

Note: 1. All power cords of the above support units are unshielded (1.8m).

### 3.6 CONFIGURATION OF SYSTEM UNDER TEST

#### Without USB cradle

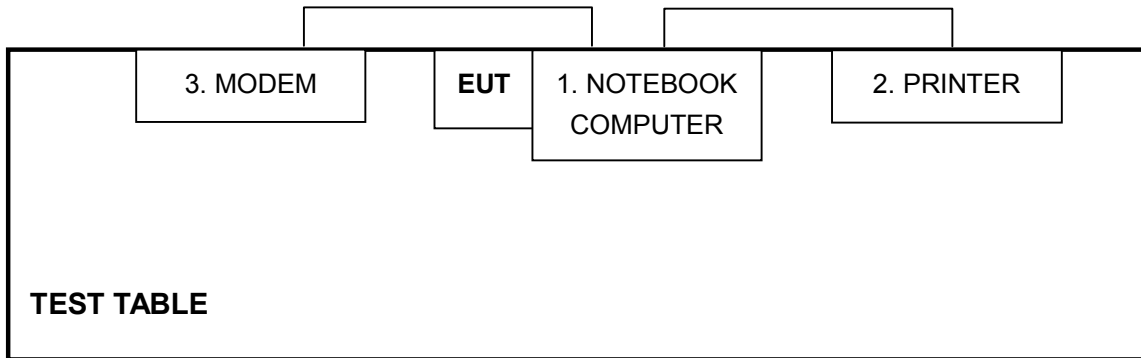

#### With USB cradle

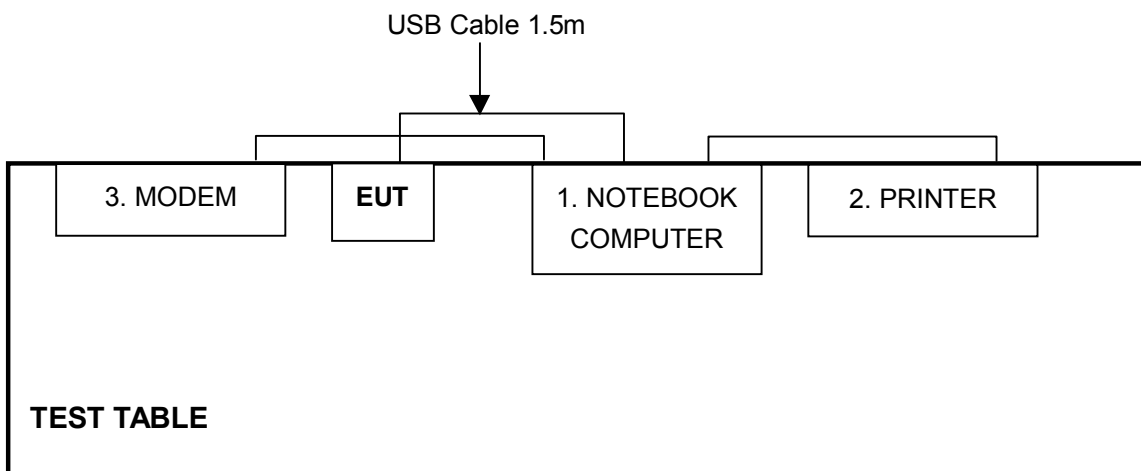

**NOTE:** 1. Please refer to the photos of test configuration in Item 5 also.



## 4 TEST TYPES AND RESULTS

### 4.1 CONDUCTED EMISSION MEASUREMENT

#### 4.1.1 LIMITS OF CONDUCTED EMISSION MEASUREMENT

FREQUENCY OF EMISSION (MHz)	CONDUCTED LIMIT (dB $\mu$ V)	
	Quasi-peak	Average
0.15-0.5	66 to 56	56 to 46
0.5-5	56	46
5-30	60	50

**NOTE:**

1. The lower limit shall apply at the transition frequencies.
2. All emanations from a class B digital device or system, including any network of conductors and apparatus connected thereto, shall not exceed the level of field strengths specified above.

#### 4.1.2 TEST INSTRUMENTS

DESCRIPTION & MANUFACTURER	MODEL NO.	SERIAL NO.	CALIBRATED UNTIL
Test Receiver	ESCS 30	100375	Sep. 19, 2006
Line-Impedance Stabilization Network(for EUT)	ENV-216	100071	Nov. 10, 2006
ROHDE & SCHWARZ LISN	ESH3-Z5	848773/004	Oct. 24, 2006
RF Signal Cable	RG233	COBCAB9K-30MHz	Dec. 10, 2005
Impedance-stabilization-network	ENY 41	838119/024	Jan. 09, 2006
Impedance-stabilization-network	ENY 22	837497/019	Jan. 09, 2006
Current Probe	SMZ11	18001	Jul. 13, 2006
Current Probe	SMZ11	18013	Jul. 13, 2006

- NOTE: 1. The calibration interval of the above test instruments is 12 months and the calibrations are traceable to NML/ROC and NIST/USA.  
 2. The test was performed in ADT Shielded Room No. B.  
 3. The VCCI Con B Registration No. is C-2193.

#### 4.1.3 TEST PROCEDURES

- a. The EUT/HOST was placed 0.4 meters from the conducting wall of the shielded room with EUT/HOST being connected to the power mains through a line impedance stabilization network (LISN). Other support units were connected to the power mains through another LISN. The two LISNs provide 50 ohm/ 50uH of coupling impedance for the measuring instrument.
- b. Both lines of the power mains connected to the EUT/HOST were checked for maximum conducted interference.
- c. The frequency range from 150 kHz to 30 MHz was searched. Emission levels over 10dB under the prescribed limits could not be reported

#### 4.1.4 TEST SETUP

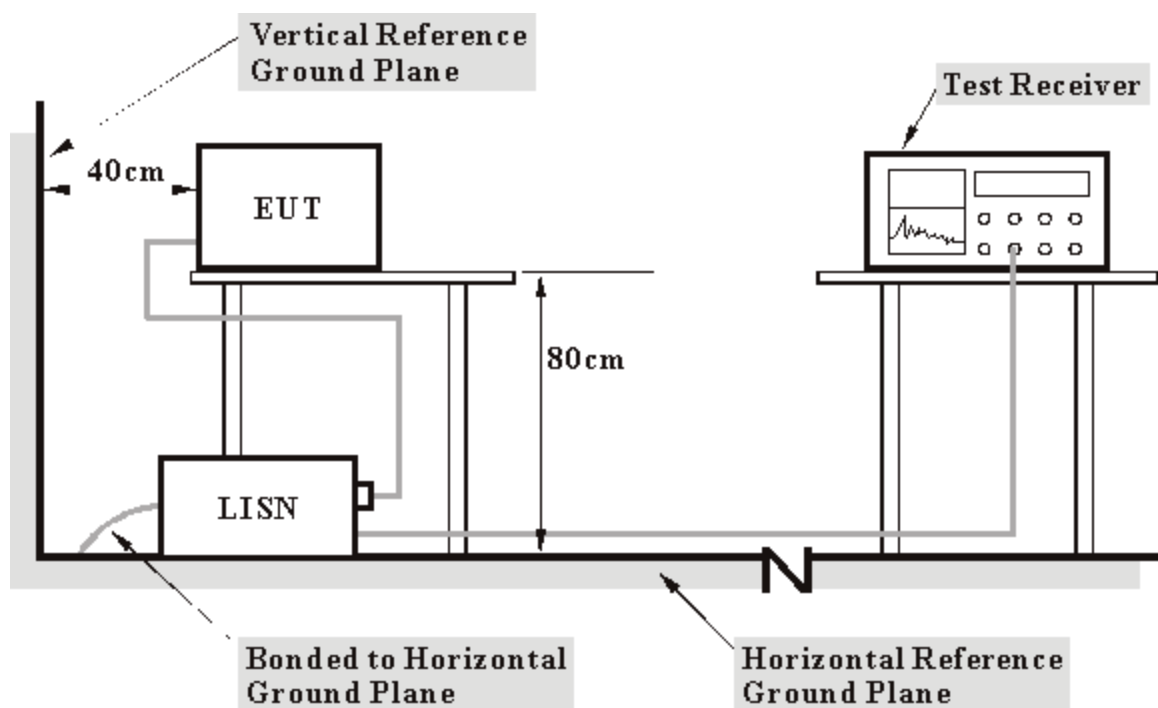

- Note:**
1. Support units were connected to second LISN.
  2. Both of LISNs (AMIN) 80 cm from EUT and at the least 80 cm from other units and other metal planes support units.

For the actual test configuration, please refer to the related item – Photographs of the Test Configuration.



#### 4.1.5 EUT OPERATING CONDITIONS

- a. Connect the EUT with the support unit 1 (Notebook computer) which placed on a testing table.
- b. The support unit 1 (Notebook computer) ran a test program "Art 52 Build 10" to enable EUT under transmission condition continuously.
- c. Notebook computer sends "H" messages to modem.
- d. Notebook computer sends "H" messages to printer, and the printer prints them on paper.



4.1.6 TEST RESULTS

EUT	Wireless USB Adapter	MODEL NO.	WUA-2340
TEST MODE	Channel 11	6dB BANDWIDTH	9 kHz
INPUT POWER	120Vac, 60 Hz	PHASE	Line (L)
ENVIRONMENTAL CONDITIONS	22 deg. C, 63% RH, 973 hPa	TESTED BY:	Eric Lee

No	Freq. [MHz]	Corr. Factor (dB)	Reading Value		Emission Level		Limit		Margin	
			[dB (uV)]		[dB (uV)]		[dB (uV)]		(dB)	
			Q.P.	AV.	Q.P.	AV.	Q.P.	AV.	Q.P.	AV.
1	0.170	9.38	31.30	-	40.68	-	64.98	54.98	-24.30	-
2	0.291	9.20	30.08	-	39.28	-	60.51	50.51	-21.22	-
3	0.369	9.20	33.34	-	42.54	-	58.53	48.53	-15.99	-
4	1.029	9.24	28.23	-	37.47	-	56.00	46.00	-18.53	-
5	1.810	9.23	27.29	-	36.52	-	56.00	46.00	-19.48	-
6	11.328	9.56	21.06	-	30.62	-	60.00	50.00	-29.38	-

- REMARKS:**
1. Q.P. and AV. are abbreviations of quasi-peak and average individually.
  2. "-": The Quasi-peak reading value also meets average limit and measurement with the average detector is unnecessary.
  3. The emission levels of other frequencies were very low against the limit.
  4. Margin value = Emission level - Limit value
  5. Correction factor = Insertion loss + Cable loss
  6. Emission Level = Correction Factor + Reading Value.

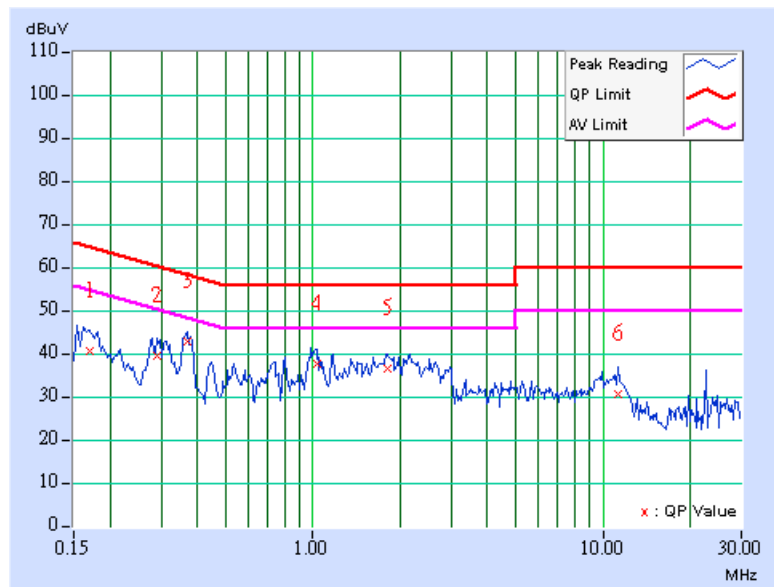





<b>EUT</b>	Wireless USB Adapter	<b>MODEL NO.</b>	WUA-2340
<b>TEST MODE</b>	Channel 11	<b>6dB BANDWIDTH</b>	9 kHz
<b>INPUT POWER</b>	120Vac, 60 Hz	<b>PHASE</b>	Neutral (N)
<b>ENVIRONMENTAL CONDITIONS</b>	22 deg. C, 63% RH, 973 hPa	<b>TESTED BY:</b> Eric Lee	

No	Freq. [MHz]	Corr. Factor (dB)	Reading Value		Emission Level		Limit		Margin	
			[dB (uV)]		[dB (uV)]		[dB (uV)]		(dB)	
			Q.P.	AV.	Q.P.	AV.	Q.P.	AV.	Q.P.	AV.
1	0.298	9.21	34.40	-	43.61	-	60.29	50.29	-16.68	-
2	0.998	9.21	33.07	-	42.28	-	56.00	46.00	-13.72	-
3	1.170	9.23	32.09	-	41.32	-	56.00	46.00	-14.68	-
4	1.443	9.25	31.98	-	41.23	-	56.00	46.00	-14.77	-
5	1.806	9.28	32.30	-	41.58	-	56.00	46.00	-14.42	-
6	2.650	9.35	29.40	-	38.75	-	56.00	46.00	-17.25	-

- REMARKS:**
1. Q.P. and AV. are abbreviations of quasi-peak and average individually.
  2. "-": The Quasi-peak reading value also meets average limit and measurement with the average detector is unnecessary.
  3. The emission levels of other frequencies were very low against the limit.
  4. Margin value = Emission level - Limit value
  5. Correction factor = Insertion loss + Cable loss
  6. Emission Level = Correction Factor + Reading Value.

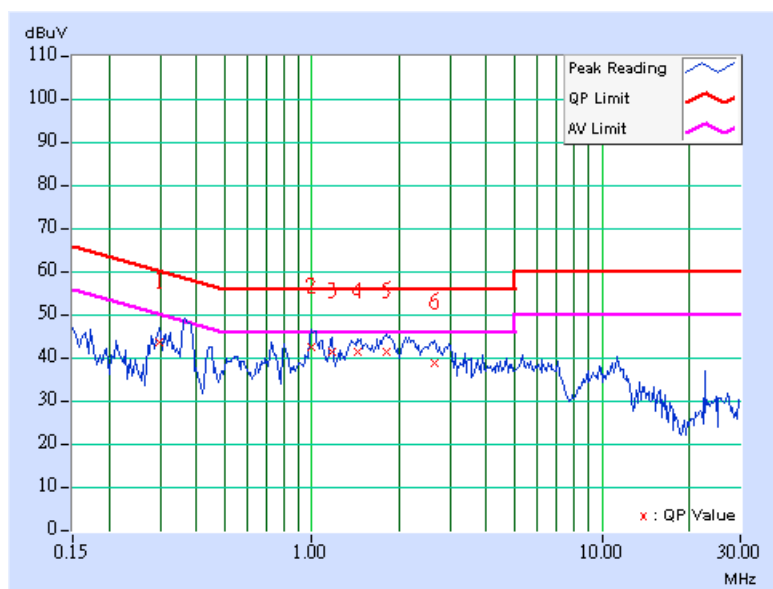



## 4.2 RADIATED EMISSION MEASUREMENT

### 4.2.1 LIMITS OF RADIATED EMISSION MEASUREMENT

Emissions radiated outside of the specified bands, shall be according to the general radiated limits in 15.209 as following:

Frequencies (MHz)	Field strength (microvolts/meter)	Measurement distance (meters)
0.009-0.490	2400/F(kHz)	300
0.490-1.705	24000/F(kHz)	30
1.705-30.0	30	30
30-88	100	3
88-216	150	3
216-960	200	3
Above 960	500	3

**NOTE:**

1. The lower limit shall apply at the transition frequencies.
2. Emission level (dBuV/m) = 20 log Emission level (uV/m).
3. As shown in 15.35(b), for frequencies above 1000MHz, the field strength limits are based on average detector, however, the peak field strength of any emission shall not exceed the maximum permitted average limits, specified above by more than 20dB under any condition of modulation.



## 4.2.2 TEST INSTRUMENTS

DESCRIPTION & MANUFACTURER	MODEL NO.	SERIAL NO.	CALIBRATED UNTIL
ADVANTEST Spectrum Analyzer	R3271A	85060311	July 07, 2006
HP Pre_Amplifier	8449B	3008A01922	Oct. 02, 2006
ROHDE & SCHWARZ Test Receiver	ESCS30	100287	Dec. 08, 2005
CHASE Broadband Antenna	VULB9168	138	Dec. 21, 2005
Schwarzbeck Horn_Antenna	BBHA9120	D124	Dec. 11, 2005
Schwarzbeck Horn_Antenna	BBHA 9170	BBHA9170153	Jan. 30, 2006
SCHWARZBECK Biconical Antenna	VHBA9123	459	Jun. 26, 2006
SCHWARZBECK Periodic Antenna	UPA6108	1148	Jun. 26, 2006
RF Switches (ARNITSU)	CS-201	1565157	NA
RF CABLE (Chaintek) 1GHz-20GHz	SF102	22054-2	Nov. 16. 2006
RF Cable(RICHTEC)	9913-30M	STCCAB-30M-1GHz-021	Jul. 16, 2006
Software	ADT_Radiated_V 5.14	NA	NA
CHANCE MOST Antenna Tower	AT-100	0203	NA
CHANCE MOST Turn Table	TT-100	0203	NA

Note: 1. The calibration interval of the above test instruments is 12 months (36 months for Periodic Antenna) and the calibrations are traceable to NML/ROC and NIST/USA.

2. The horn antenna and HP preamplifier (model: 8449B) are used only for the measurement of emission frequency above 1GHz if tested.
3. The test was performed in ADT Open Site No. C.
4. The FCC Site Registration No. is 656396.
5. The VCCI Site Registration No. is R-1626.
6. The CANADA Site Registration No. is IC 4824-3.
7. The following table is for the measurement uncertainty, which is calculated as per the document CISPR 16-4. This uncertainty represents an expanded uncertainty expressed at approximately the 95% confidence level using a coverage factor of k=2.

Measurement	Value
Radiated emissions (30MHz-1GHz)	2.98 dB
Radiated emissions (1GHz ~18GHz)	2.21 dB
Radiated emissions (18GHz ~20GHz)	1.88 dB



#### 4.2.3 TEST PROCEDURES

- a. The EUT was placed on the top of a rotating table 0.8 meters above the ground at a 10 meter open area test site. The table was rotated 360 degrees to determine the position of the highest radiation.
- b. The EUT was set 3 meters away from the interference-receiving antenna, which was mounted on the top of a variable-height antenna tower.
- c. The antenna is a broadband antenna, and its height is varied from one meter to four meters above the ground to determine the maximum value of the field strength. Both horizontal and vertical polarizations of the antenna are set to make the measurement.
- d. For each suspected emission, the EUT was arranged to its worst case and then the antenna was tuned to heights from 1 meter to 4 meters and the rotatable table was turned from 0 degrees to 360 degrees to find the maximum reading.
- e. The test-receiver system was set to Peak Detect Function and Specified Bandwidth with Maximum Hold Mode.
- f. If the emission level of the EUT in peak mode was 10 dB lower than the limit specified, then testing could be stopped and the peak values of the EUT would be reported. Otherwise the emissions that did not have 10 dB margin would be re-tested one by one using peak, quasi-peak or average method as specified and then reported in a data sheet.

**NOTE:**

1. The resolution bandwidth and video bandwidth of test receiver/spectrum analyzer is 120kHz for Peak detection (PK) and Quasi-peak detection (QP) at frequency below 1GHz.
2. The resolution bandwidth and video bandwidth of test receiver/spectrum analyzer is 1 MHz for Peak detection at frequency above 1GHz.
3. The resolution bandwidth of test receiver/spectrum analyzer is 1 MHz and the video bandwidth is 10 Hz for Average detection (AV) at frequency above 1GHz.

#### 4.2.4 TEST SETUP

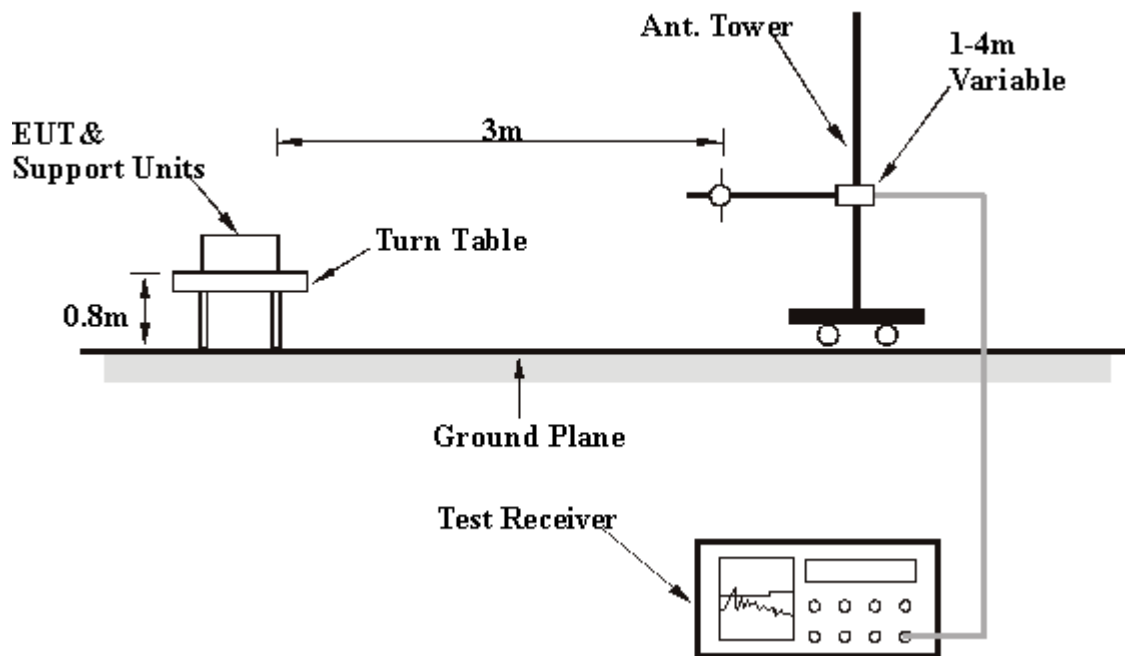

For the actual test configuration, please refer to the related item – Photographs of the Test Configuration.



#### 4.2.5 EUT OPERATING CONDITIONS

##### **For Without USB cradle**

- a. Plug the EUT into the support unit 1 (Notebook computer) which placed on a testing table.
- b. The support unit 1 (Notebook computer) ran a test program “Art 52 Build 10” to enable EUT under transmission condition continuously at specific channel frequency.
- c. Notebook computer sends "H" messages to modem.
- d. Notebook computer sends "H" messages to printer, and the printer prints them on paper.

##### **For With USB cradle**

- a. Connect the EUT with the support unit 1 (Notebook computer) which placed on a testing table.
- b. The support unit 1 (Notebook computer) ran a test program “Art 52 Build 10” to enable EUT under transmission condition continuously.
- c. Notebook computer sends "H" messages to modem.
- d. Notebook computer sends "H" messages to printer, and the printer prints them on paper.

## 4.2.6 TEST RESULTS

## Below 1GHz Worst-Case Data

<b>EUT</b>	Wireless USB Adapter		
<b>MODEL</b>	WUA-2340	<b>TEST MODE</b>	Mode 1
<b>MODE</b>	Channel 11	<b>FREQUENCY RANGE</b>	30-1000 MHz
<b>INPUT POWER (SYSTEM)</b>	120Vac, 60 Hz	<b>DETECTOR FUNCTION &amp; BANDWIDTH</b>	Quasi-Peak, 120kHz
<b>ENVIRONMENTAL CONDITIONS</b>	27 deg. C, 53%RH, 973 hPa	<b>TESTED BY</b>	Tony Chen

**ANTENNA POLARITY & TEST DISTANCE: HORIZONTAL AT 3 M**

No.	Freq. (MHz)	Emission Level (dBuV/m)	Limit (dBuV/m)	Margin (dB)	Antenna Height (m)	Table Angle (Degree)	Raw Value (dBuV)	Correction Factor (dB/m)
1	67.56	19.30 QP	40.00	-20.70	1.24 H	321	6.70	12.60
2	266.98	20.30 QP	46.00	-25.70	1.65 H	149	5.90	14.40
3	480.00	27.50 QP	46.00	-18.50	1.42 H	139	7.10	20.40
4	560.00	30.10 QP	46.00	-15.90	1.48 H	14	7.60	22.50
5	760.00	28.20 QP	46.00	-17.80	1.29 H	281	1.80	26.40
6	839.99	32.70 QP	46.00	-13.30	1.10 H	286	5.40	27.30
7	920.00	31.20 QP	46.00	-14.80	1.00 H	291	3.00	28.30
8	960.00	29.10 QP	46.00	-16.90	1.03 H	75	0.20	28.90

**ANTENNA POLARITY & TEST DISTANCE: VERTICAL AT 3 M**

No.	Freq. (MHz)	Emission Level (dBuV/m)	Limit (dBuV/m)	Margin (dB)	Antenna Height (m)	Table Angle (Degree)	Raw Value (dBuV)	Correction Factor (dB/m)
1	67.56	27.80 QP	40.00	-12.20	1.01 V	307	15.20	12.60
2	266.98	28.40 QP	46.00	-17.60	1.01 V	190	13.90	14.40
3	480.00	28.00 QP	46.00	-18.00	1.05 V	350	7.60	20.40
4	560.00	27.60 QP	46.00	-18.40	1.01 V	262	5.00	22.50
5	760.00	31.60 QP	46.00	-14.40	1.00 V	157	5.20	26.40
6	840.00	29.90 QP	46.00	-16.10	1.19 V	12	2.60	27.30
7	920.00	31.60 QP	46.00	-14.40	1.33 V	286	3.30	28.30
8	999.99	29.40 QP	54.00	-24.60	1.19 V	83	0.50	28.90

- REMARKS:**
1. Emission level(dBuV/m)=Raw Value(dBuV) + Correction Factor(dB/m)
  2. Correction Factor(dB/m) = Antenna Factor (dB/m) + Cable Factor (dB)
  3. The other emission levels were very low against the limit.
  4. Margin value = Emission level – Limit value.



<b>EUT</b>	Wireless USB Adapter		
<b>MODEL</b>	WUA-2340	<b>TEST MODE</b>	Mode 2
<b>MODE</b>	Channel 11	<b>FREQUENCY RANGE</b>	30-1000 MHz
<b>INPUT POWER (SYSTEM)</b>	120Vac, 60 Hz	<b>DETECTOR FUNCTION &amp; BANDWIDTH</b>	Quasi-Peak, 120kHz
<b>ENVIRONMENTAL CONDITIONS</b>	27 deg. C, 53%RH, 973 hPa	<b>TESTED BY</b>	Tony Chen

#### ANTENNA POLARITY & TEST DISTANCE: HORIZONTAL AT 3 M

No.	Freq. (MHz)	Emission Level (dBuV/m)	Limit (dBuV/m)	Margin (dB)	Antenna Height (m)	Table Angle (Degree)	Raw Value (dBuV)	Correction Factor (dB/m)
1	67.53	19.10 QP	40.00	-20.90	1.30 H	97	6.50	12.60
2	266.98	21.40 QP	46.00	-24.60	1.51 H	153	7.00	14.40
3	480.00	27.90 QP	46.00	-18.10	2.16 H	74	7.50	20.40
4	560.00	28.60 QP	46.00	-17.40	2.04 H	101	6.10	22.50
5	600.00	27.60 QP	46.00	-18.40	1.70 H	90	4.10	23.50
6	760.00	34.40 QP	46.00	-11.60	1.14 H	48	7.90	26.40
7	800.00	30.30 QP	46.00	-15.70	1.30 H	110	3.60	26.60
8	839.99	37.30 QP	46.00	-8.70	1.17 H	271	10.00	27.30
9	920.00	35.40 QP	46.00	-10.60	1.12 H	269	7.10	28.30
10	1000.00	32.30 QP	54.00	-21.70	1.08 H	271	3.40	28.90

#### ANTENNA POLARITY & TEST DISTANCE: VERTICAL AT 3 M

No.	Freq. (MHz)	Emission Level (dBuV/m)	Limit (dBuV/m)	Margin (dB)	Antenna Height (m)	Table Angle (Degree)	Raw Value (dBuV)	Correction Factor (dB/m)
1	67.56	31.10 QP	40.00	-8.90	1.07 V	27	18.50	12.60
2	266.98	29.70 QP	46.00	-16.30	1.14 V	133	15.30	14.40
3	480.00	25.90 QP	46.00	-20.10	1.16 V	1	5.50	20.40
4	560.00	29.70 QP	46.00	-16.30	1.00 V	10	7.20	22.50
5	600.00	25.80 QP	46.00	-20.20	1.10 V	136	2.30	23.50
6	760.00	31.30 QP	46.00	-14.70	1.12 V	230	4.90	26.40
7	800.00	26.60 QP	46.00	-19.40	1.00 V	156	0.00	26.60
8	840.00	35.00 QP	46.00	-11.00	1.08 V	255	7.70	27.30
9	920.00	30.90 QP	46.00	-15.10	1.11 V	217	2.60	28.30
10	999.99	29.50 QP	54.00	-24.50	1.68 V	245	0.60	28.90

- REMARKS:**
1. Emission level(dBuV/m)=Raw Value(dBuV) + Correction Factor(dB/m)
  2. Correction Factor(dB/m) = Antenna Factor (dB/m) + Cable Factor (dB)
  3. The other emission levels were very low against the limit.
  4. Margin value = Emission level – Limit value.





## 4.2.7 TEST RESULTS – DSSS

## 802.11b DSSS modulation

<b>EUT</b>	Wireless USB Adapter	<b>MODEL</b>	WUA-2340
<b>MODE</b>	Channel 1	<b>FREQUENCY RANGE</b>	1000~25000MHz
<b>INPUT POWER (SYSTEM)</b>	120Vac, 60 Hz	<b>DETECTOR FUNCTION &amp; BANDWIDTH</b>	Peak (PK) Average (AV) 1 MHz
<b>ENVIRONMENTAL CONDITIONS</b>	20 deg. C, 65%RH, 973 hPa	<b>TESTED BY</b>	Eric Lee

**ANTENNA POLARITY & TEST DISTANCE: HORIZONTAL AT 3 M**

No.	Freq. (MHz)	Emission Level (dBuV/m)	Limit (dBuV/m)	Margin (dB)	Antenna Height (m)	Table Angle (Degree)	Raw Value (dBuV)	Correction Factor (dB/m)
1	2016.00	44.40 PK	74.00	-29.60	1.33 H	140	16.10	28.30
1	2016.00	41.00 AV	54.00	-13.00	1.33 H	140	12.70	28.30
2	2387.00	48.10 PK	74.00	-25.90	1.02 H	214	15.30	32.80
2	2387.00	35.50 AV	54.00	-18.50	1.02 H	214	2.70	32.80
3	2390.00	56.90 PK	74.00	-17.10	1.00 H	214	23.20	33.70
3	2390.00	33.10 AV	54.00	-20.90	1.00 H	214	-0.60	33.70
4	*2412.00	95.70 PK			1.11 H	20	65.90	29.80
4	*2412.00	88.10 AV			1.11 H	20	58.30	29.80
5	4824.00	44.90 PK	74.00	-29.10	1.00 H	265	9.80	35.10
5	4824.00	36.90 AV	54.00	-17.10	1.00 H	265	1.80	35.10
6	7236.00	47.00 PK	74.00	-27.00	1.12 H	69	6.50	40.50
6	7236.00	38.20 AV	54.00	-15.80	1.12 H	69	-2.30	40.50

**ANTENNA POLARITY & TEST DISTANCE: VERTICAL AT 3 M**

No.	Freq. (MHz)	Emission Level (dBuV/m)	Limit (dBuV/m)	Margin (dB)	Antenna Height (m)	Table Angle (Degree)	Raw Value (dBuV)	Correction Factor (dB/m)
1	2016.00	48.70 PK	74.00	-25.30	1.37 V	96	20.40	28.30
1	2016.00	46.90 AV	54.00	-7.10	1.37 V	96	18.60	28.30
2	2387.00	67.60 PK	74.00	-6.40	1.11 V	245	34.80	32.80
2	2387.00	42.80 AV	54.00	-11.20	1.11 V	245	10.00	32.80
3	2390.00	66.40 PK	74.00	-7.60	1.52 V	202	32.70	33.70
3	2390.00	40.70 AV	54.00	-13.30	1.52 V	202	7.00	33.70
4	*2412.00	104.20 PK			1.10 V	121	74.40	29.80
4	*2412.00	95.70 AV			1.10 V	121	65.90	29.80
5	4824.00	51.80 PK	74.00	-22.20	1.32 V	95	16.70	35.10
5	4824.00	43.60 AV	54.00	-10.40	1.32 V	95	8.50	35.10
6	7236.00	50.00 PK	74.00	-24.00	1.25 V	24	9.50	40.50
6	7236.00	43.40 AV	54.00	-10.60	1.25 V	24	2.90	40.50

**REMARKS:**

1. Emission level(dBuV/m)=Raw Value(dBuV) + Correction Factor(dB/m)
2. Correction Factor(dB/m) = Antenna Factor (dB/m) + Cable Factor (dB)
3. The other emission levels were very low against the limit.
4. Margin value = Emission level – Limit value.
5. The limit value is defined as per 15.247
6. “ \* “ : Fundamental frequency



<b>EUT</b>	Wireless USB Adapter	<b>MODEL</b>	WUA-2340
<b>MODE</b>	Channel 6	<b>FREQUENCY RANGE</b>	1000~25000MHz
<b>INPUT POWER (SYSTEM)</b>	120Vac, 60 Hz	<b>DETECTOR FUNCTION &amp; BANDWIDTH</b>	Peak (PK) Average (AV) 1 MHz
<b>ENVIRONMENTAL CONDITIONS</b>	20 deg. C, 65%RH, 973 hPa	<b>TESTED BY</b>	Eric Lee

#### ANTENNA POLARITY & TEST DISTANCE: HORIZONTAL AT 3 M

No.	Freq. (MHz)	Emission Level (dBuV/m)	Limit (dBuV/m)	Margin (dB)	Antenna Height (m)	Table Angle (Degree)	Raw Value (dBuV)	Correction Factor (dB/m)
1	2016.00	43.10 PK	74.00	-30.90	1.36 H	62	14.80	28.30
1	2016.00	40.80 AV	54.00	-13.20	1.36 H	62	12.50	28.30
2	*2437.00	96.10 PK			1.13 H	18	66.20	29.90
2	*2437.00	88.80 AV			1.13 H	18	58.90	29.90
3	4874.00	45.30 PK	74.00	-28.70	1.30 H	31	10.00	35.30
3	4874.00	38.30 AV	54.00	-15.70	1.30 H	31	3.00	35.30
4	7311.00	48.80 PK	74.00	-25.20	1.20 H	72	8.10	40.70
4	7311.00	39.30 AV	54.00	-14.70	1.20 H	72	-1.40	40.70

#### ANTENNA POLARITY & TEST DISTANCE: VERTICAL AT 3 M

No.	Freq. (MHz)	Emission Level (dBuV/m)	Limit (dBuV/m)	Margin (dB)	Antenna Height (m)	Table Angle (Degree)	Raw Value (dBuV)	Correction Factor (dB/m)
1	2016.00	48.80 PK	74.00	-25.20	1.38 V	100	20.50	28.30
1	2016.00	47.10 AV	54.00	-6.90	1.38 V	100	18.80	28.30
2	*2437.00	104.70 PK			1.11 V	34	74.80	29.90
2	*2437.00	95.70 AV			1.11 V	34	65.80	29.90
3	4874.00	52.80 PK	74.00	-21.20	1.28 V	101	17.50	35.30
3	4874.00	44.10 AV	54.00	-9.90	1.28 V	101	8.80	35.30
4	7311.00	51.80 PK	74.00	-22.20	1.41 V	170	11.10	40.70
4	7311.00	42.40 AV	54.00	-11.60	1.41 V	170	1.70	40.70

- REMARKS:**
1. Emission level(dBuV/m)=Raw Value(dBuV) + Correction Factor(dB/m)
  2. Correction Factor(dB/m) = Antenna Factor (dB/m) + Cable Factor (dB)
  3. The other emission levels were very low against the limit.
  4. Margin value = Emission level – Limit value.
  5. The limit value is defined as per 15.247
  6. " \* " : Fundamental frequency



<b>EUT</b>	Wireless USB Adapter	<b>MODEL</b>	WUA-2340
<b>MODE</b>	Channel 11	<b>FREQUENCY RANGE</b>	1000~25000MHz
<b>INPUT POWER (SYSTEM)</b>	120Vac, 60 Hz	<b>DETECTOR FUNCTION &amp; BANDWIDTH</b>	Peak (PK) Average (AV) 1 MHz
<b>ENVIRONMENTAL CONDITIONS</b>	20 deg. C, 65%RH, 973 hPa	<b>TESTED BY</b>	Eric Lee

#### ANTENNA POLARITY & TEST DISTANCE: HORIZONTAL AT 3 M

No.	Freq. (MHz)	Emission Level (dBuV/m)	Limit (dBuV/m)	Margin (dB)	Antenna Height (m)	Table Angle (Degree)	Raw Value (dBuV)	Correction Factor (dB/m)
1	2016.00	44.00 PK	74.00	-30.00	1.33 H	137	15.70	28.30
1	2016.00	40.00 AV	54.00	-14.00	1.33 H	137	11.70	28.30
2	*2462.00	96.10 PK			1.12 H	18	66.10	30.00
2	*2462.00	88.20 AV			1.12 H	18	58.20	30.00
3	2483.50	56.90 PK	74.00	-17.10	1.25 H	85	26.80	30.10
3	2483.50	30.70 AV	54.00	-23.30	1.25 H	85	0.60	30.10
4	2487.00	58.10 PK	74.00	-15.90	1.07 H	45	28.00	30.10
4	2487.00	32.60 AV	54.00	-21.40	1.07 H	45	2.50	30.10
5	4924.00	45.40 PK	74.00	-28.60	1.20 H	39	9.80	35.50
5	4924.00	36.40 AV	54.00	-17.60	1.20 H	39	0.80	35.50
6	7386.00	48.20 PK	74.00	-25.80	1.00 H	109	7.40	40.80
6	7386.00	38.50 AV	54.00	-15.50	1.00 H	109	-2.30	40.80

#### ANTENNA POLARITY & TEST DISTANCE: VERTICAL AT 3 M

No.	Freq. (MHz)	Emission Level (dBuV/m)	Limit (dBuV/m)	Margin (dB)	Antenna Height (m)	Table Angle (Degree)	Raw Value (dBuV)	Correction Factor (dB/m)
1	2016.00	48.20 PK	74.00	-25.80	1.10 V	5	19.90	28.30
1	2016.00	45.90 AV	54.00	-8.10	1.10 V	5	17.60	28.30
2	*2462.00	104.60 PK			1.09 V	18	74.60	30.00
2	*2462.00	95.90 AV			1.09 V	18	65.90	30.00
3	2483.50	65.40 PK	74.00	-8.60	1.08 V	258	35.30	30.10
3	2483.50	38.40 AV	54.00	-15.60	1.08 V	258	8.30	30.10
4	2487.00	66.60 PK	74.00	-7.40	1.01 V	21	36.50	30.10
4	2487.00	40.40 AV	54.00	-13.60	1.01 V	21	10.20	30.10
5	4924.00	54.70 PK	74.00	-19.30	1.52 V	247	19.10	35.50
5	4924.00	43.60 AV	54.00	-10.40	1.52 V	247	8.00	35.50
6	7386.00	52.30 PK	74.00	-21.70	1.25 V	24	11.50	40.80
6	7386.00	43.80 AV	54.00	-10.20	1.25 V	24	3.00	40.80

- REMARKS:**
1. Emission level(dBuV/m)=Raw Value(dBuV) + Correction Factor(dB/m)
  2. Correction Factor(dB/m) = Antenna Factor (dB/m) + Cable Factor (dB)
  3. The other emission levels were very low against the limit.
  4. Margin value = Emission level – Limit value.
  5. The limit value is defined as per 15.247
  6. “ \* ” : Fundamental frequency



#### 4.2.8 TEST RESULTS – OFDM 802.11g Normal OFDM modulation

<b>EUT</b>	Wireless USB Adapter	<b>MODEL</b>	WUA-2340
<b>MODE</b>	Channel 1	<b>FREQUENCY RANGE</b>	1000~25000MHz
<b>INPUT POWER (SYSTEM)</b>	120Vac, 60 Hz	<b>DETECTOR FUNCTION &amp; BANDWIDTH</b>	Peak (PK) Average (AV) 1 MHz
<b>ENVIRONMENTAL CONDITIONS</b>	20 deg. C, 65%RH, 973 hPa	<b>TESTED BY</b>	Eric Lee

#### ANTENNA POLARITY & TEST DISTANCE: HORIZONTAL AT 3 M

No.	Freq. (MHz)	Emission Level (dBuV/m)	Limit (dBuV/m)	Margin (dB)	Antenna Height (m)	Table Angle (Degree)	Raw Value (dBuV)	Correction Factor (dB/m)
1	2016.00	47.90 PK	74.00	-26.10	1.20 H	50	19.60	28.30
1	2016.00	45.10 AV	54.00	-8.90	1.20 H	50	16.80	28.30
2	2390.00	53.90 PK	74.00	-20.10	1.25 H	42	20.20	33.70
2	2390.00	40.90 AV	54.00	-13.10	1.25 H	42	7.20	33.70
3	*2412.00	92.70 PK			1.13 H	18	62.90	29.80
3	*2412.00	84.60 AV			1.13 H	18	54.80	29.80
4	4824.00	44.40 PK	74.00	-29.60	1.78 H	161	9.30	35.10
4	4824.00	35.50 AV	54.00	-18.50	1.78 H	161	0.40	35.10
5	7236.00	46.30 PK	74.00	-27.70	1.00 H	331	5.80	40.50
5	7236.00	38.10 AV	54.00	-15.90	1.00 H	331	-2.40	40.50

#### ANTENNA POLARITY & TEST DISTANCE: VERTICAL AT 3 M

No.	Freq. (MHz)	Emission Level (dBuV/m)	Limit (dBuV/m)	Margin (dB)	Antenna Height (m)	Table Angle (Degree)	Raw Value (dBuV)	Correction Factor (dB/m)
1	2016.00	48.80 PK	74.00	-25.20	1.09 V	350	20.50	28.30
1	2016.00	47.00 AV	54.00	-7.00	1.09 V	350	18.70	28.30
2	2390.00	61.00 PK	74.00	-13.00	1.01 V	247	27.30	33.70
2	2390.00	47.70 AV	54.00	-6.30	1.01 V	247	14.00	33.70
3	*2412.00	99.80 PK			1.84 V	15	70.00	29.80
3	*2412.00	91.40 AV			1.84 V	15	61.60	29.80
4	4824.00	55.10 PK	74.00	-18.90	1.00 V	246	20.00	35.10
4	4824.00	42.60 AV	54.00	-11.40	1.00 V	246	7.50	35.10
5	7236.00	52.30 PK	74.00	-21.70	1.16 V	115	11.80	40.50
5	7236.00	40.30 AV	54.00	-13.70	1.16 V	115	-0.20	40.50

- REMARKS:**
1. Emission level(dBuV/m)=Raw Value(dBuV) + Correction Factor(dB/m)
  2. Correction Factor(dB/m) = Antenna Factor (dB/m) + Cable Factor (dB)
  3. The other emission levels were very low against the limit.
  4. Margin value = Emission level – Limit value.
  5. The limit value is defined as per 15.247
  6. " \* " : Fundamental frequency



<b>EUT</b>	Wireless USB Adapter	<b>MODEL</b>	WUA-2340
<b>MODE</b>	Channel 6	<b>FREQUENCY RANGE</b>	1000~25000MHz
<b>INPUT POWER (SYSTEM)</b>	120Vac, 60 Hz	<b>DETECTOR FUNCTION &amp; BANDWIDTH</b>	Peak (PK) Average (AV) 1 MHz
<b>ENVIRONMENTAL CONDITIONS</b>	20 deg. C, 65%RH, 973 hPa	<b>TESTED BY</b>	Eric Lee

#### ANTENNA POLARITY & TEST DISTANCE: HORIZONTAL AT 3 M

No.	Freq. (MHz)	Emission Level (dBuV/m)	Limit (dBuV/m)	Margin (dB)	Antenna Height (m)	Table Angle (Degree)	Raw Value (dBuV)	Correction Factor (dB/m)
1	2016.00	48.70 PK	74.00	-25.30	1.20 H	58	20.40	28.30
1	2016.00	45.10 AV	54.00	-8.90	1.20 H	58	16.80	28.30
2	*2437.00	93.20 PK			1.19 H	20	63.30	29.90
2	*2437.00	86.10 AV			1.19 H	20	56.20	29.90
3	4874.00	45.70 PK	74.00	-28.30	1.68 H	78	10.40	35.30
3	4874.00	35.10 AV	54.00	-18.90	1.68 H	78	-0.20	35.30
4	7311.00	48.80 PK	74.00	-25.20	1.09 H	41	8.10	40.70
4	7311.00	38.60 AV	54.00	-15.40	1.09 H	41	-2.10	40.70

#### ANTENNA POLARITY & TEST DISTANCE: VERTICAL AT 3 M

No.	Freq. (MHz)	Emission Level (dBuV/m)	Limit (dBuV/m)	Margin (dB)	Antenna Height (m)	Table Angle (Degree)	Raw Value (dBuV)	Correction Factor (dB/m)
1	2016.00	52.10 PK	74.00	-21.90	1.98 V	68	23.80	28.30
1	2016.00	49.70 AV	54.00	-4.30	1.98 V	68	21.40	28.30
2	*2437.00	100.00 PK			1.91 V	15	70.10	29.90
2	*2437.00	91.10 AV			1.91 V	15	61.20	29.90
3	4874.00	55.10 PK	74.00	-18.90	2.00 V	50	19.80	35.30
3	4874.00	43.20 AV	54.00	-10.80	2.00 V	50	7.90	35.30
4	7311.00	49.90 PK	74.00	-24.10	1.99 V	311	9.20	40.70
4	7311.00	41.80 AV	54.00	-12.20	1.99 V	311	1.10	40.70

- REMARKS:**
1. Emission level(dBuV/m)=Raw Value(dBuV) + Correction Factor(dB/m)
  2. Correction Factor(dB/m) = Antenna Factor (dB/m) + Cable Factor (dB)
  3. The other emission levels were very low against the limit.
  4. Margin value = Emission level – Limit value.
  5. The limit value is defined as per 15.247
  6. “ \* “ : Fundamental frequency



<b>EUT</b>	Wireless USB Adapter	<b>MODEL</b>	WUA-2340
<b>MODE</b>	Channel 11	<b>FREQUENCY RANGE</b>	1000~25000MHz
<b>INPUT POWER (SYSTEM)</b>	120Vac, 60 Hz	<b>DETECTOR FUNCTION &amp; BANDWIDTH</b>	Peak (PK) Average (AV) 1 MHz
<b>ENVIRONMENTAL CONDITIONS</b>	20 deg. C, 65%RH, 973 hPa	<b>TESTED BY</b>	Eric Lee

#### ANTENNA POLARITY & TEST DISTANCE: HORIZONTAL AT 3 M

No.	Freq. (MHz)	Emission Level (dBuV/m)	Limit (dBuV/m)	Margin (dB)	Antenna Height (m)	Table Angle (Degree)	Raw Value (dBuV)	Correction Factor (dB/m)
1	2016.00	49.60 PK	74.00	-24.40	1.16 H	60	21.30	28.30
1	2016.00	46.50 AV	54.00	-7.50	1.16 H	60	18.20	28.30
2	*2462.00	92.30 PK			1.20 H	12	62.30	30.00
2	*2462.00	85.90 AV			1.20 H	12	55.90	30.00
3	2483.50	53.00 PK	74.00	-21.00	1.10 H	219	22.90	30.10
3	2483.50	43.40 AV	54.00	-10.60	1.10 H	219	13.20	30.10
4	4924.00	44.30 PK	74.00	-29.70	1.21 H	69	8.70	35.50
4	4924.00	36.10 AV	54.00	-17.90	1.21 H	69	0.50	35.50
5	7386.00	47.10 PK	74.00	-26.90	1.18 H	100	6.30	40.80
5	7386.00	37.30 AV	54.00	-16.70	1.18 H	100	-3.50	40.80

#### ANTENNA POLARITY & TEST DISTANCE: VERTICAL AT 3 M

No.	Freq. (MHz)	Emission Level (dBuV/m)	Limit (dBuV/m)	Margin (dB)	Antenna Height (m)	Table Angle (Degree)	Raw Value (dBuV)	Correction Factor (dB/m)
1	2016.00	54.20 PK	74.00	-19.80	1.16 V	1	25.90	28.30
1	<b>2016.00</b>	<b>51.30 AV</b>	<b>54.00</b>	<b>-2.70</b>	<b>1.16 V</b>	<b>1</b>	<b>22.90</b>	<b>28.30</b>
2	*2462.00	99.90 PK			1.89 V	14	69.90	30.00
2	*2462.00	91.00 AV			1.89 V	14	61.00	30.00
3	2483.50	60.60 PK	74.00	-13.40	1.25 V	256	30.50	30.10
3	2483.50	48.50 AV	54.00	-5.50	1.25 V	256	18.30	30.10
4	4924.00	54.90 PK	74.00	-19.10	2.14 V	44	19.30	35.50
4	4924.00	42.40 AV	54.00	-11.60	2.14 V	44	6.80	35.50
5	7386.00	52.60 PK	74.00	-21.40	2.00 V	316	11.80	40.80
5	7386.00	41.10 AV	54.00	-12.90	2.00 V	316	0.30	40.80

- REMARKS:**
1. Emission level(dBuV/m)=Raw Value(dBuV) + Correction Factor(dB/m)
  2. Correction Factor(dB/m) = Antenna Factor (dB/m) + Cable Factor (dB)
  3. The other emission levels were very low against the limit.
  4. Margin value = Emission level – Limit value.
  5. The limit value is defined as per 15.247
  6. “ \* “ : Fundamental frequency



### 802.11g Turbo OFDM modulation

<b>EUT</b>	Wireless USB Adapter	<b>MODEL</b>	WUA-2340
<b>MODE</b>	Channel 6	<b>FREQUENCY RANGE</b>	1000~25000MHz
<b>INPUT POWER (SYSTEM)</b>	120Vac, 60 Hz	<b>DETECTOR FUNCTION &amp; BANDWIDTH</b>	Peak (PK) Average (AV) 1 MHz
<b>ENVIRONMENTAL CONDITIONS</b>	20 deg. C, 65%RH, 973 hPa	<b>TESTED BY</b>	Eric Lee

#### ANTENNA POLARITY & TEST DISTANCE: HORIZONTAL AT 3 M

No.	Freq. (MHz)	Emission Level (dBuV/m)	Limit (dBuV/m)	Margin (dB)	Antenna Height (m)	Table Angle (Degree)	Raw Value (dBuV)	Correction Factor (dB/m)
1	2016.00	45.80 PK	74.00	-28.20	1.29 H	86	17.50	28.30
1	2016.00	42.70 AV	54.00	-11.30	1.29 H	86	14.40	28.30
2	2390.00	44.80 PK	74.00	-29.20	1.00 H	325	11.10	33.70
2	2390.00	40.80 AV	54.00	-13.20	1.00 H	325	7.10	33.70
3	*2437.00	91.70 PK			1.23 H	211	61.80	29.90
3	*2437.00	84.90 AV			1.23 H	211	55.00	29.90
4	2483.50	42.90 PK	74.00	-31.10	1.40 H	28	12.80	30.10
4	2483.50	38.80 AV	54.00	-15.20	1.40 H	28	8.70	30.10
5	4874.00	44.70 PK	74.00	-29.30	1.23 H	69	9.40	35.30
5	4874.00	37.30 AV	54.00	-16.70	1.23 H	69	2.00	35.30
6	7311.00	47.90 PK	74.00	-26.10	1.19 H	20	7.20	40.70
6	7311.00	38.80 AV	54.00	-15.20	1.19 H	20	-1.90	40.70

#### ANTENNA POLARITY & TEST DISTANCE: VERTICAL AT 3 M

No.	Freq. (MHz)	Emission Level (dBuV/m)	Limit (dBuV/m)	Margin (dB)	Antenna Height (m)	Table Angle (Degree)	Raw Value (dBuV)	Correction Factor (dB/m)
1	2016.00	49.70 PK	74.00	-24.30	1.89 V	50	21.40	28.30
1	2016.00	43.80 AV	54.00	-10.20	1.89 V	50	15.50	28.30
2	2390.00	51.10 PK	74.00	-22.90	1.25 V	24	17.50	33.70
2	2390.00	45.70 AV	54.00	-8.30	1.25 V	24	12.00	33.70
3	*2437.00	98.10 PK			1.89 V	20	68.20	29.90
3	*2437.00	89.80 AV			1.89 V	20	59.90	29.90
4	2483.50	51.30 PK	74.00	-22.70	1.50 V	2	21.20	30.10
4	2483.50	43.70 AV	54.00	-10.30	1.50 V	2	13.60	30.10
5	4874.00	51.80 PK	74.00	-22.20	1.53 V	8	16.50	35.30
5	4874.00	42.50 AV	54.00	-11.50	1.53 V	8	7.20	35.30
6	7311.00	51.20 PK	74.00	-22.80	1.43 V	360	10.50	40.70
6	7311.00	43.40 AV	54.00	-10.60	1.43 V	360	2.70	40.70

- REMARKS:**
1. Emission level(dBuV/m)=Raw Value(dBuV) + Correction Factor(dB/m)
  2. Correction Factor(dB/m) = Antenna Factor (dB/m) + Cable Factor (dB)
  3. The other emission levels were very low against the limit.
  4. Margin value = Emission level – Limit value.
  5. The limit value is defined as per 15.247
  6. “ \* ” : Fundamental frequency



### 4.3 6dB BANDWIDTH MEASUREMENT

#### 4.3.1 LIMITS OF 6dB BANDWIDTH MEASUREMENT

The minimum of 6dB Bandwidth Measurement is 0.5 MHz.

#### 4.3.2 TEST INSTRUMENTS

Description & Manufacturer	Model No.	Serial No.	Calibrated Until
R&S SPECTRUM ANALYZER	FSP40	100036	Nov. 23, 2006

**NOTE:**

- 1.The measurement uncertainty is less than +/- 2.6dB, which is calculated as per the NAMAS document NIS81.
- 2.The calibration interval of the above test instruments is 12 months and the calibrations are traceable to NML/ROC and NIST/USA.



#### 4.3.3 TEST PROCEDURE

The transmitter output was connected to the spectrum analyzer through an attenuator. The bandwidth of the fundamental frequency was measured by spectrum analyzer with 100 kHz RBW and 100 kHz VBW. The 6 dB bandwidth is defined as the total spectrum the power of which is higher than peak power minus 6 dB.

#### 4.3.4 TEST SETUP

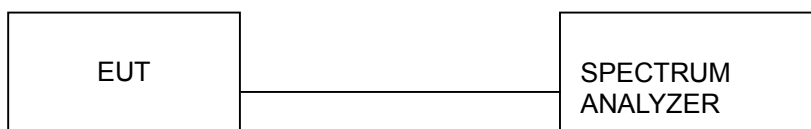

For the actual test configuration, please refer to the related Item – Photographs of the Test Configuration.

#### 4.3.5 EUT OPERATING CONDITIONS

The software provided by client to enable the EUT under transmission condition continuously at lowest, middle and highest channel frequencies individually.



## 4.3.6 TEST RESULTS –DSSS

**802.11b DSSS modulation**

<b>EUT</b>	Wireless USB Adapter		
<b>MODEL</b>	WUA-2340	<b>ENVIRONMENTAL CONDITIONS</b>	20 deg. C, 60%RH, 973 hPa
<b>INPUT POWER (SYSTEM)</b>	120Vac, 60 Hz	<b>TESTED BY</b>	Eric Lee

<b>CHANNEL</b>	<b>CHANNEL FREQUENCY (MHz)</b>	<b>6 dB BANDWIDTH (MHz)</b>	<b>MINIMUM LIMIT (MHz)</b>	<b>PASS/FAIL</b>
1	2412	11.97	0.5	PASS
6	2437	11.76	0.5	PASS
11	2462	11.20	0.5	PASS



CH1

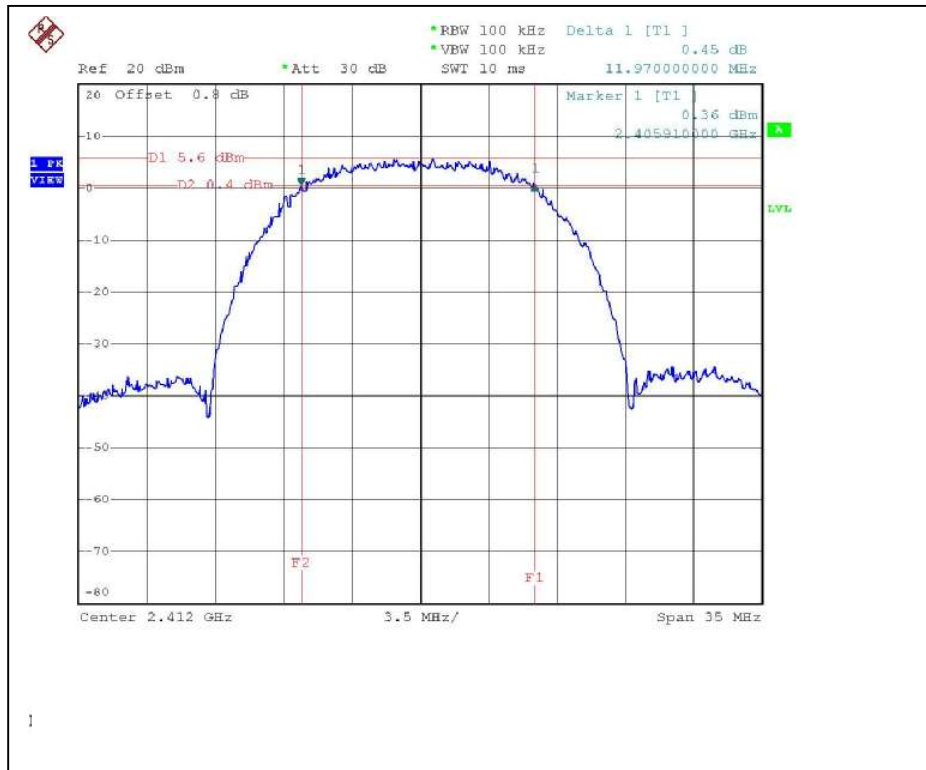

CH6

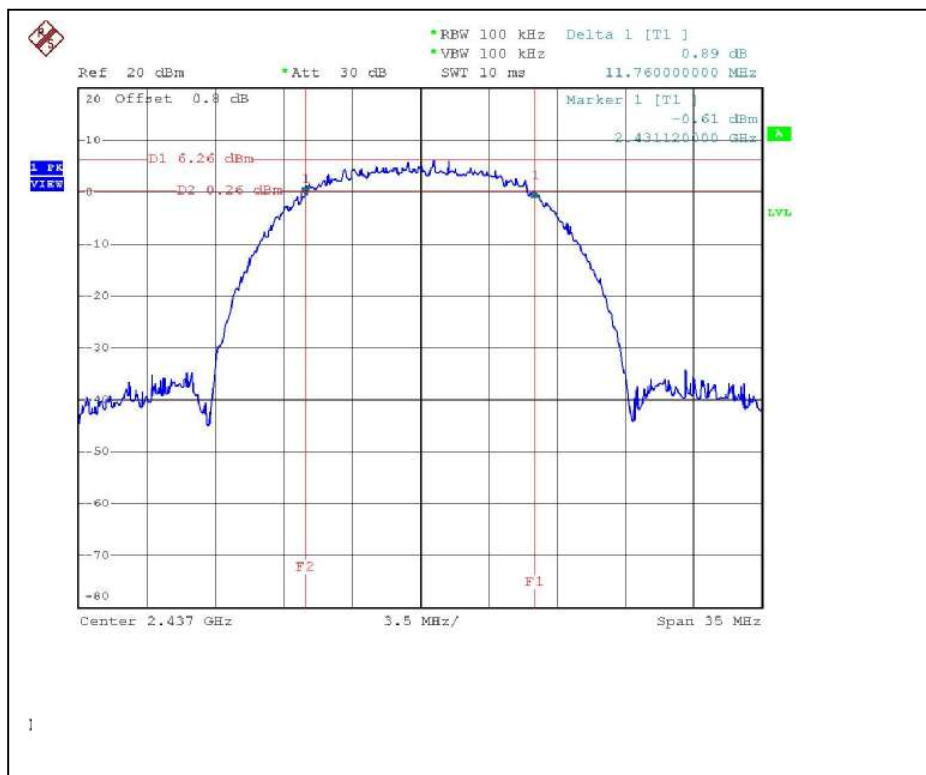



CH11

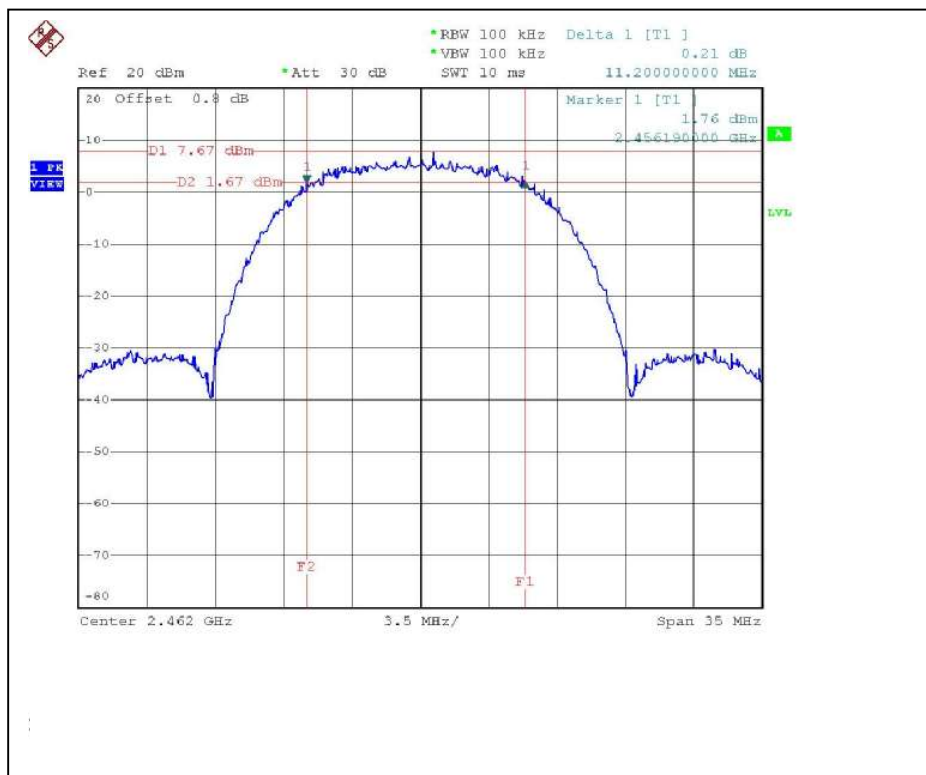



## 4.3.7 TEST RESULTS-OFDM

**802.11g Normal OFDM modulation**

<b>EUT</b>	Wireless USB Adapter		
<b>MODEL</b>	WUA-2340	<b>ENVIRONMENTAL CONDITIONS</b>	20 deg. C, 60%RH, 973 hPa
<b>INPUT POWER (SYSTEM)</b>	120Vac, 60 Hz	<b>TESTED BY</b>	Eric Lee

<b>CHANNEL</b>	<b>CHANNEL FREQUENCY (MHz)</b>	<b>6 dB BANDWIDTH (MHz)</b>	<b>MINIMUM LIMIT (MHz)</b>	<b>PASS/FAIL</b>
1	2412	16.38	0.5	PASS
6	2437	16.38	0.5	PASS
11	2462	16.38	0.5	PASS



CH1

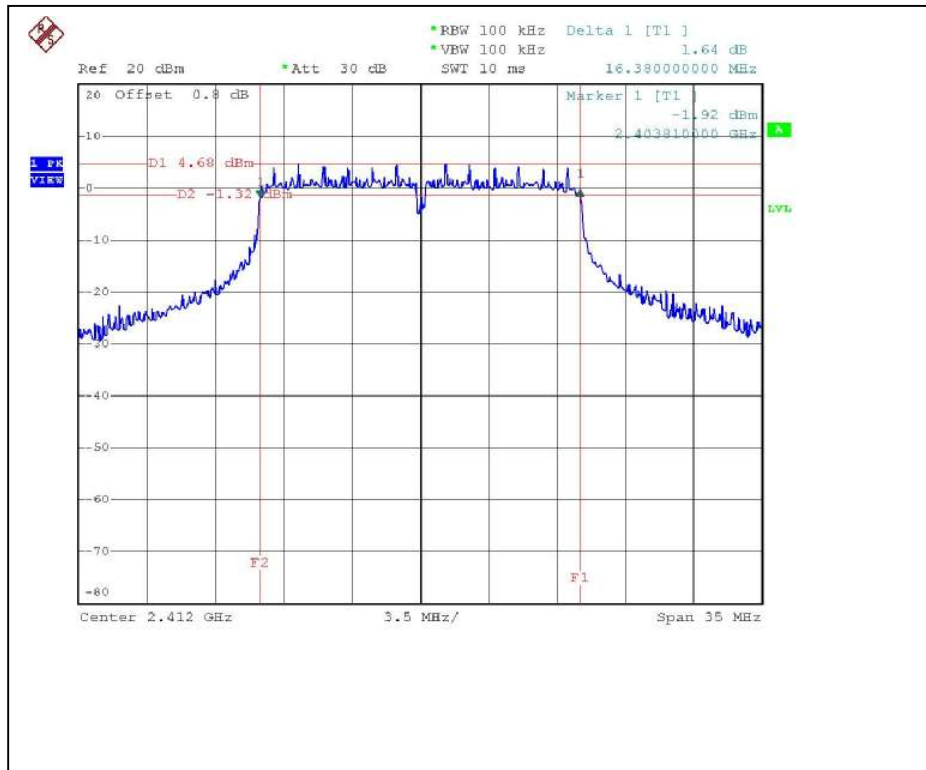

CH6

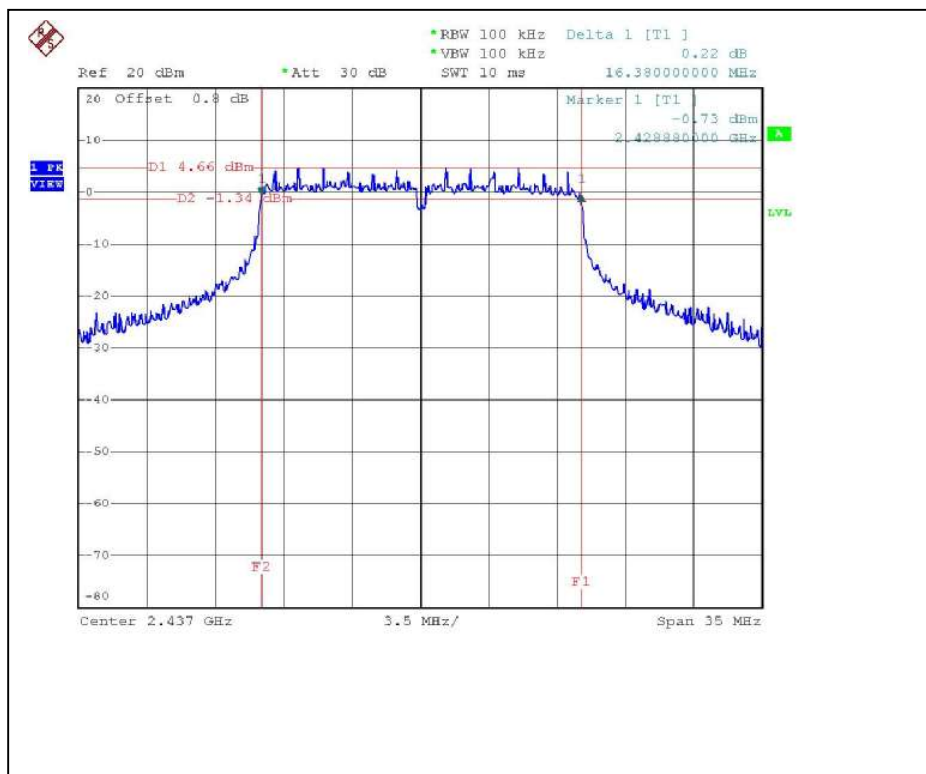



CH11

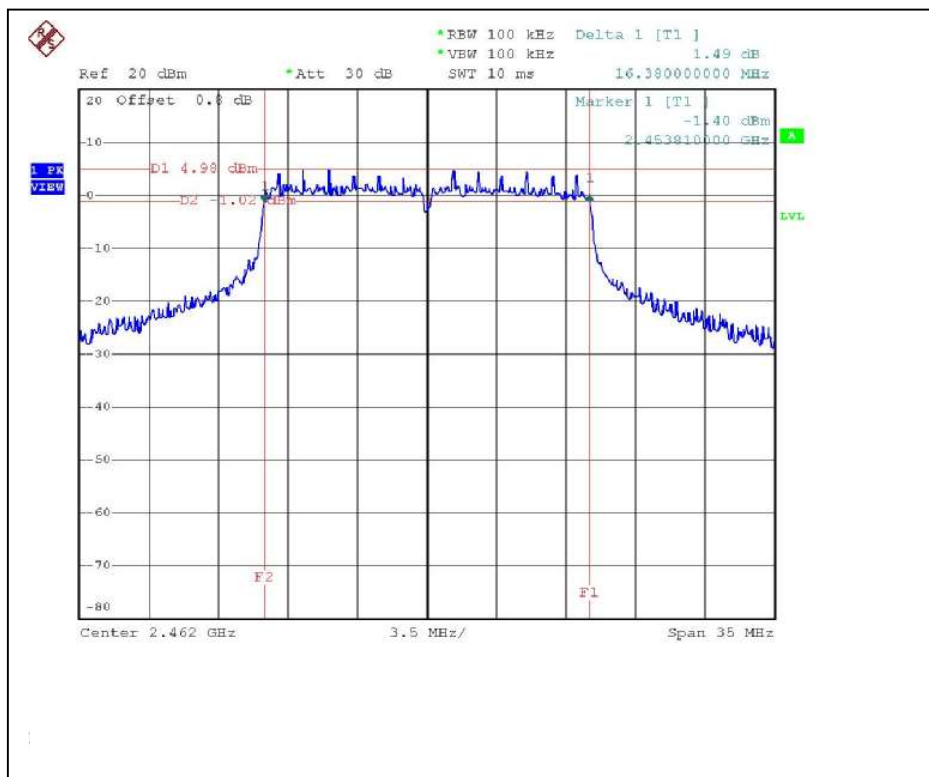



**802.11g Turbo OFDM modulation**

<b>EUT</b>	Wireless USB Adapter		
<b>MODEL</b>	WUA-2340	<b>ENVIRONMENTAL CONDITIONS</b>	20 deg. C, 60%RH, 973 hPa
<b>INPUT POWER (SYSTEM)</b>	120Vac, 60 Hz	<b>TESTED BY</b>	Eric Lee

<b>CHANNEL</b>	<b>CHANNEL FREQUENCY (MHz)</b>	<b>6 dB BANDWIDTH (MHz)</b>	<b>MINIMUM LIMIT (MHz)</b>	<b>PASS/FAIL</b>
6	2437	32.52	0.5	PASS





CH6

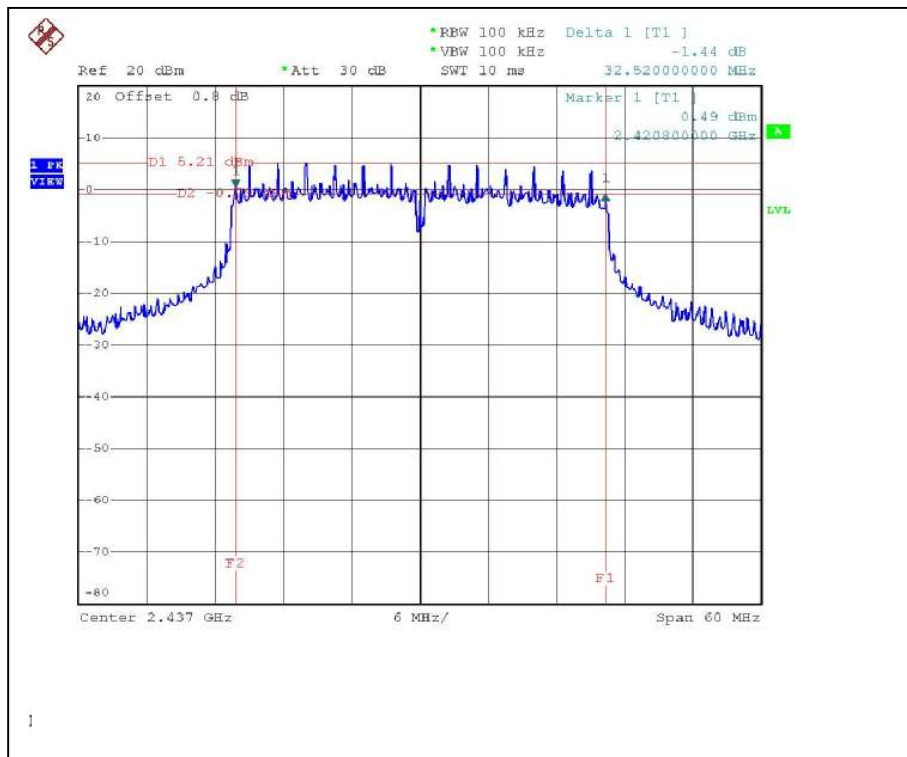

#### 4.4 MAXIMUM PEAK OUTPUT POWER

##### 4.4.1 LIMITS OF MAXIMUM PEAK OUTPUT POWER MEASUREMENT

The Maximum Peak Output Power Measurement is 30dBm.

##### 4.4.2 TEST INSTRUMENTS

Description & Manufacturer	Model No.	Serial No.	Calibrated Until
R&S SPECTRUM ANALYZER	FSP40	100036	Nov. 23, 2006
Agilent SIGNAL GENERATOR	E8257C	MY43320668	Dec. 07, 2006
TEKTRONIX OSCILLOSCOPE	TDS380	B016335	Jun. 22, 2006
NARDA DETECTOR	4503A	FSCM99899	NA

**NOTE:**

The calibration interval of the above test instruments is 12 months and the calibrations are traceable to NML/ROC and NIST/USA.



#### 4.4.3 TEST PROCEDURES

1. A detector was used on the output port of the EUT. An oscilloscope was used to read the peak response of the detector.
2. Replaced the EUT by the signal generator. The center frequency of the S.G was adjusted to the center frequency of the measured channel.
3. Adjusted the power to have the same peak reading on oscilloscope. Record the power level.

#### 4.4.4 TEST SETUP

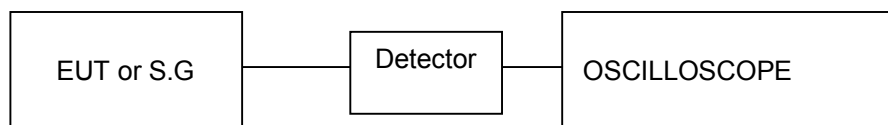

#### 4.4.5 EUT OPERATING CONDITIONS

Same as Item 4.3.5



## 4.4.6 TEST RESULTS – DSSS

**802.11b DSSS modulation**

<b>EUT</b>	Wireless USB Adapter		
<b>MODEL</b>	WUA-2340	<b>ENVIRONMENTAL CONDITIONS</b>	20 deg. C, 60%RH, 973 hPa
<b>INPUT POWER (SYSTEM)</b>	120Vac, 60 Hz	<b>TESTED BY</b>	Eric Lee

<b>CHANNEL</b>	<b>CHANNEL FREQUENCY (MHz)</b>	<b>PEAK POWER OUTPUT (mW)</b>	<b>PEAK POWER OUTPUT (dBm)</b>	<b>PEAK POWER LIMIT (dBm)</b>	<b>PASS/FAIL</b>
1	2412	51.286	17.10	30	PASS
6	2437	50.699	17.05	30	PASS
11	2462	50.816	17.06	30	PASS



## 4.4.7 TEST RESULTS –OFDM

**802.11g Normal OFDM modulation**

<b>EUT</b>	Wireless USB Adapter		
<b>MODEL</b>	WUA-2340	<b>ENVIRONMENTAL CONDITIONS</b>	20 deg. C, 60%RH, 973 hPa
<b>INPUT POWER (SYSTEM)</b>	120Vac, 60 Hz	<b>TESTED BY</b>	Eric Lee

CHANNEL	CHANNEL FREQUENCY (MHz)	PEAK POWER OUTPUT (mW)	PEAK POWER OUTPUT (dBm)	PEAK POWER LIMIT (dBm)	PASS/FAIL
1	2412	77.268	18.88	30	PASS
6	2437	79.433	19.00	30	PASS
11	2462	78.343	18.94	30	PASS

**802.11g Turbo OFDM modulation**

<b>EUT</b>	Wireless USB Adapter		
<b>MODEL</b>	WUA-2340	<b>ENVIRONMENTAL CONDITIONS</b>	20 deg. C, 60%RH, 973 hPa
<b>INPUT POWER (SYSTEM)</b>	120Vac, 60 Hz	<b>TESTED BY</b>	Eric Lee

CHANNEL	CHANNEL FREQUENCY (MHz)	PEAK POWER OUTPUT (mW)	PEAK POWER OUTPUT (dBm)	PEAK POWER LIMIT (dBm)	PASS/FAIL
6	2437	77.625	18.90	30	PASS



## 4.5 POWER SPECTRAL DENSITY MEASUREMENT

### 4.5.1 LIMITS OF POWER SPECTRAL DENSITY MEASUREMENT

The Maximum of Power Spectral Density Measurement is 8dBm.

### 4.5.2 TEST INSTRUMENTS

Description & Manufacturer	Model No.	Serial No.	Calibrated Until
R&S SPECTRUM ANALYZER	FSP40	100036	Nov. 23, 2006

**NOTE:**

- 1.The measurement uncertainty is less than +/- 2.6dB, which is calculated as per the NAMAS document NIS81.
- 2.The calibration interval of the above test instruments is 12 months and the calibrations are traceable to NML/ROC and NIST/USA.

#### 4.5.3 TEST PROCEDURE

The transmitter output was connected to the spectrum analyzer through an attenuator, the bandwidth of the fundamental frequency was measured with the spectrum analyzer using 3 kHz RBW and 30 kHz VBW, set sweep time=span/3kHz. The power spectral density was measured and recorded. The sweep time is allowed to be longer than span/3KHz for a full response of the mixer in the spectrum analyzer.

#### 4.5.4 TEST SETUP

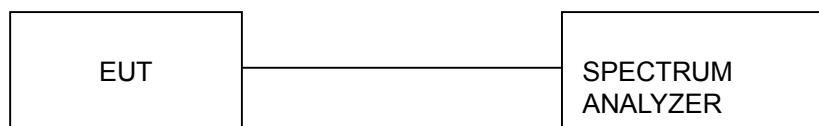

#### 4.5.5 EUT OPERATING CONDITIONS

Same as 4.3.5



## 4.5.6 TEST RESULTS –DSSS

**802.11b DSSS modulation**

<b>EUT</b>	Wireless USB Adapter		
<b>MODEL</b>	WUA-2340	<b>ENVIRONMENTAL CONDITIONS</b>	20 deg. C, 60%RH, 973 hPa
<b>INPUT POWER (SYSTEM)</b>	120Vac, 60 Hz	<b>TESTED BY</b>	Eric Lee

<b>CHANNEL NUMBER</b>	<b>CHANNEL FREQUENCY (MHz )</b>	<b>RF POWER LEVEL IN 3 KHz BW (dBm)</b>	<b>MAXIMUM LIMIT (dBm)</b>	<b>PASS/FAIL</b>
1	2412	-3.94	8	PASS
6	2437	-5.18	8	PASS
11	2462	-6.19	8	PASS





CH1

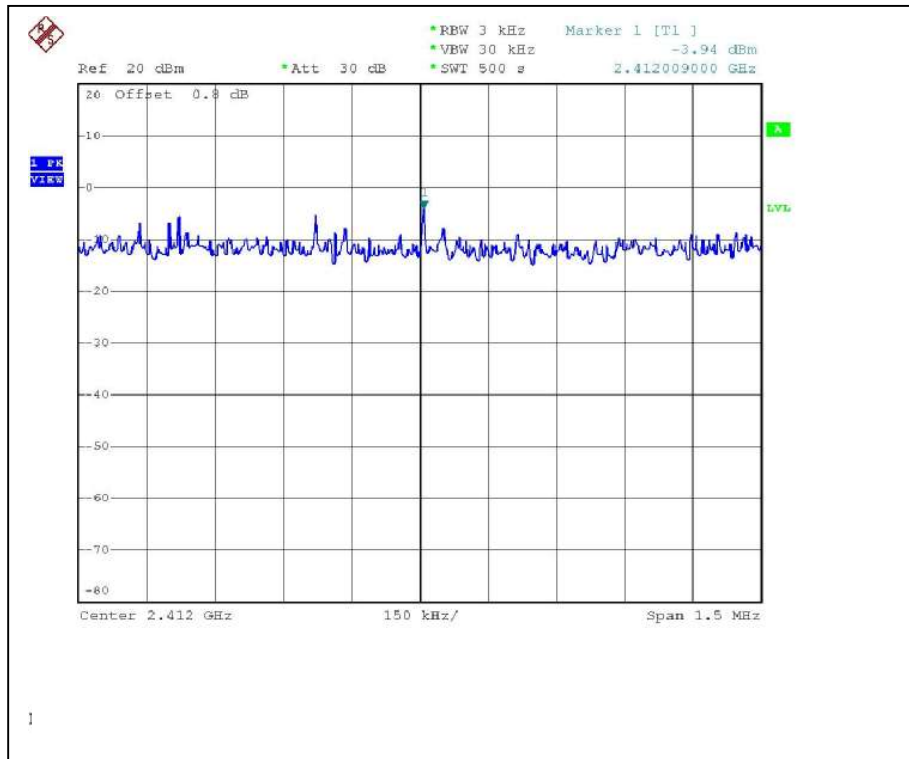

CH6

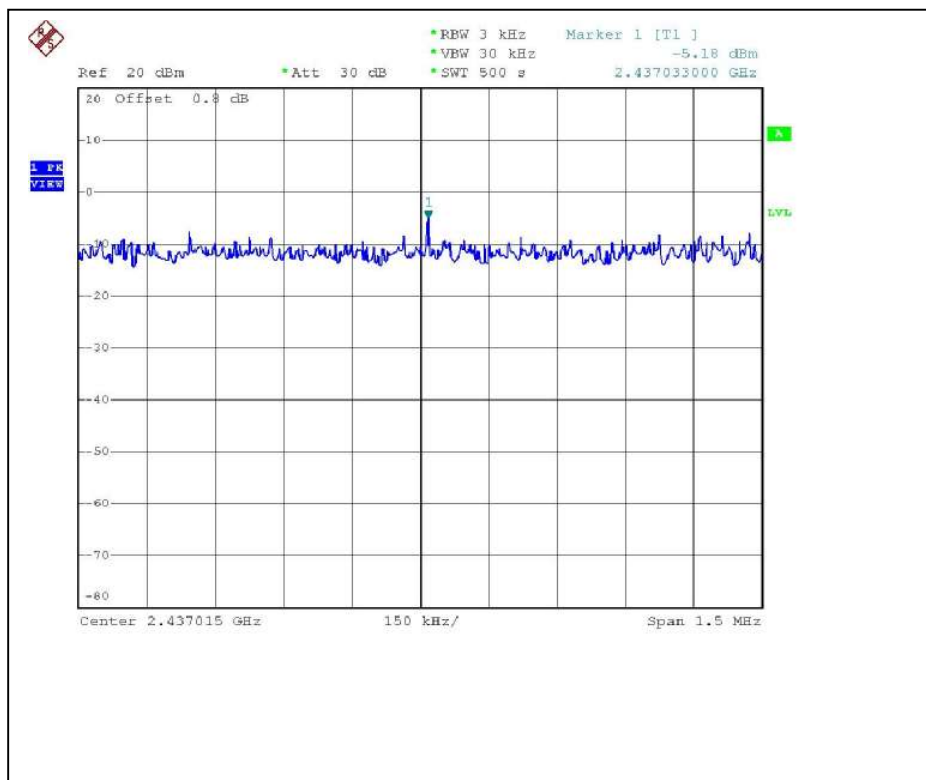



CH11

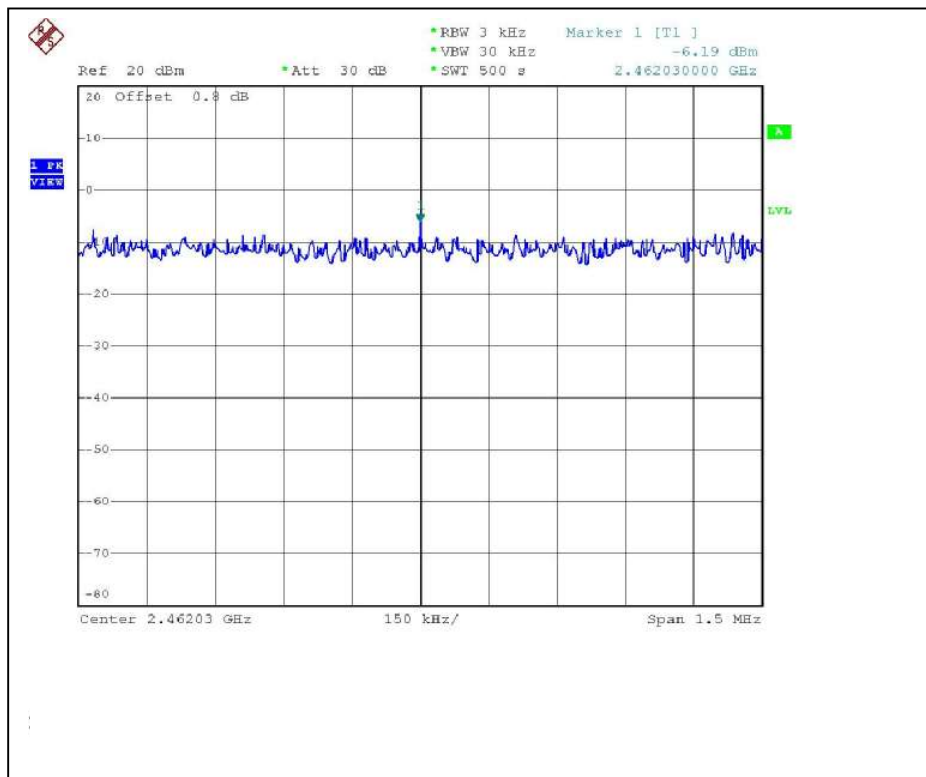



## 4.5.7 TEST RESULTS –OFDM

**802.11g Normal OFDM modulation**

<b>EUT</b>	Wireless USB Adapter		
<b>MODEL</b>	WUA-2340	<b>ENVIRONMENTAL CONDITIONS</b>	20 deg. C, 60%RH, 973 hPa
<b>INPUT POWER (SYSTEM)</b>	120Vac, 60 Hz	<b>TESTED BY</b>	Eric Lee

<b>CHANNEL NUMBER</b>	<b>CHANNEL FREQUENCY (MHz )</b>	<b>RF POWER LEVEL IN 3 KHz BW (dBm)</b>	<b>MAXIMUM LIMIT (dBm)</b>	<b>PASS/FAIL</b>
1	2412	-7.17	8	PASS
6	2437	-6.86	8	PASS
11	2462	-6.98	8	PASS



CH1

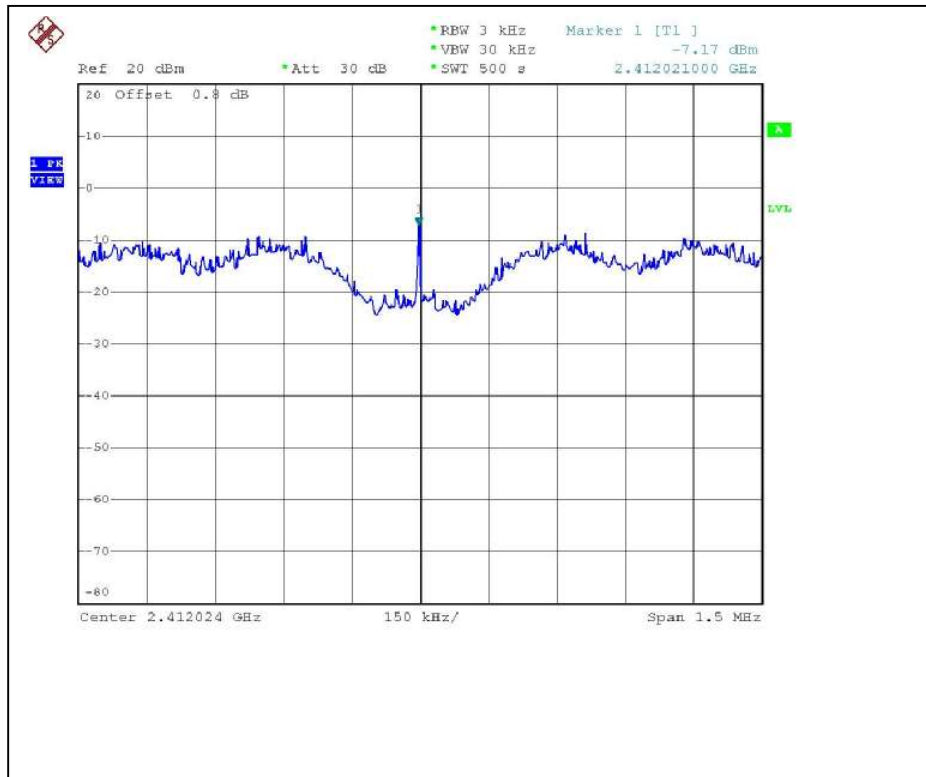

CH6

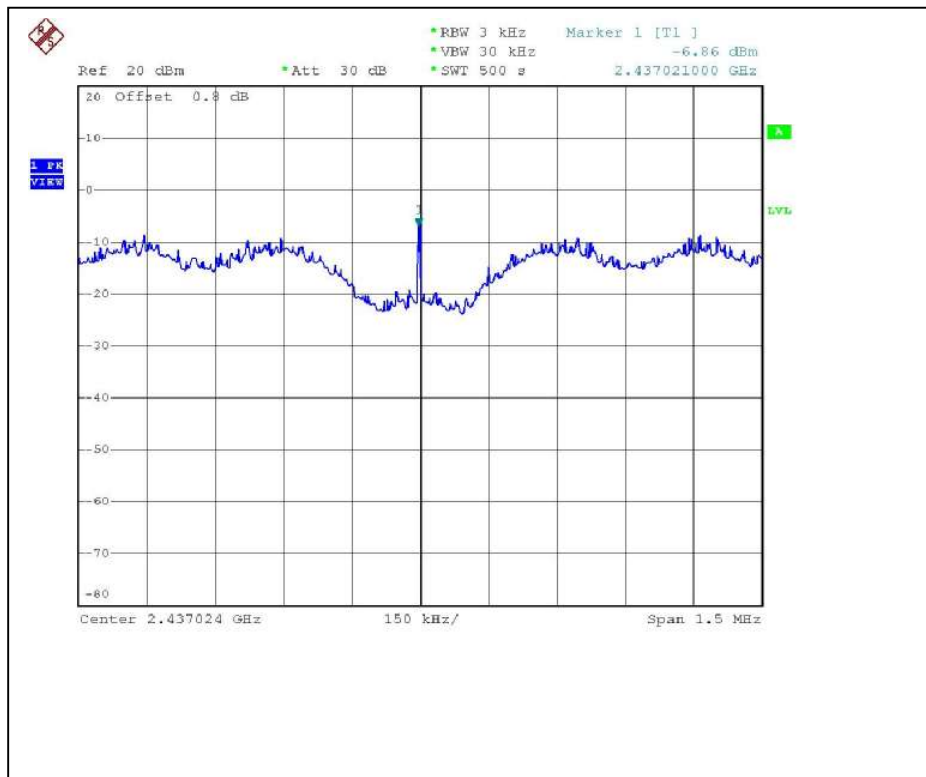



CH11

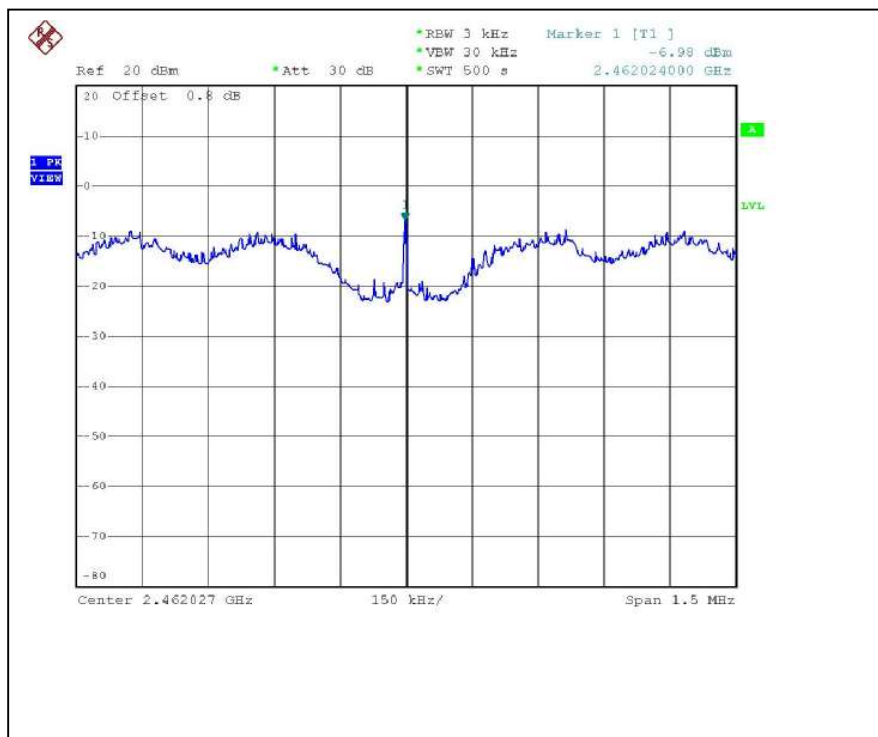

**802.11g Turbo OFDM modulation**

<b>EUT</b>	Wireless USB Adapter		
<b>MODEL</b>	WUA-2340	<b>ENVIRONMENTAL CONDITIONS</b>	20 deg. C, 60%RH, 973 hPa
<b>INPUT POWER (SYSTEM)</b>	120Vac, 60 Hz	<b>TESTED BY</b>	Eric Lee

<b>CHANNEL NUMBER</b>	<b>CHANNEL FREQUENCY (MHz )</b>	<b>RF POWER LEVEL IN 3 KHz BW (dBm)</b>	<b>MAXIMUM LIMIT (dBm)</b>	<b>PASS/FAIL</b>
6	2437	-7.13	8	PASS



CH6

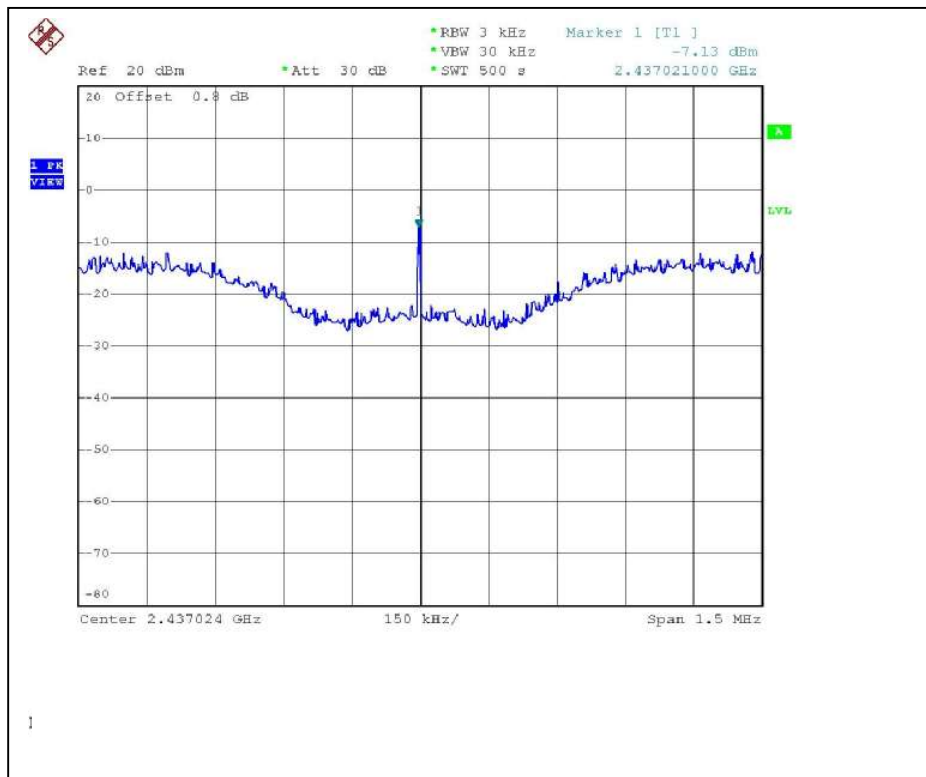



## 4.6 BAND EDGES MEASUREMENT

### 4.6.1 LIMITS OF BAND EDGES MEASUREMENT

Below  $-20\text{dB}$  of the highest emission level of operating band (in 1MHz Resolution Bandwidth).

### 4.6.2 TEST INSTRUMENTS

Description & Manufacturer	Model No.	Serial No.	Calibrated Until
R&S SPECTRUM ANALYZER	FSP40	100036	Nov. 23, 2006

**NOTE:**

- 1.The measurement uncertainty is less than  $\pm 2.6\text{dB}$ , which is calculated as per the NAMAS document NIS81.
- 2.The calibration interval of the above test instruments is 12 months and the calibrations are traceable to NML/ROC and NIST/USA.

### 4.6.3 TEST PROCEDURE

The transmitter output was connected to the spectrum analyzer via a low lose cable. Set RBW spectrum analyzer to 1 MHz and set VBW spectrum analyzer to 10 Hz with suitable frequency span including 1 MHz bandwidth from band edge. The band edges was measured and recorded.

The spectrum plots (Peak RBW=VBW=100kHz ; Average RBW=1MHz, VBW=10Hz) are attached on the following pages.

### 4.6.4 EUT OPERATING CONDITION

Same as Item 4.3.5





#### 4.6.5 TEST RESULTS – DSSS

The spectrum plots are attached on the following page. D1 line indicates the highest level, D2 line indicates the 20dB offset below D1. It shows compliance with the requirement in part 15.247(C).

Note - The delta method is only used up to 2 MHz away from the restricted bandage, The radiated emissions which located in other restricted frequency band, the result, please refer to 4.2.

##### **NOTE (Peak):**

The band edge emission plot of DSSS technique on the following first page show 52.8dB delta between carrier maximum power and local maximum emission in restrict band (2.3900GHz). The emission of carrier strength list in the test result of channel 1 at the item 4.2 is 104.2dBuV/m, so the maximum field strength in restrict band is  $104.2-52.8=51.4$ dBuV/m which is under 74 dBuV/m limit.

The band edge emission plot of DSSS technique on the following first page shows 52.77dB delta between carrier maximum power and local maximum emission in restrict band (2.4835GHz). The emission of carrier strength list in the test result of channel 11 at the item 4.2 is 104.6dBuV/m, so the maximum field strength in restrict band is  $104.6-52.77=51.83$ dBuV/m which is under 74 dBuV/m limit.

##### **NOTE (Average):**

The band edge emission plot of DSSS technique on the following second page shows 55.01dB delta between carrier maximum power and local maximum emission in restrict band (2.3900GHz). The emission of carrier strength list in the test result of channel 1 at the item 4.2 is 95.7dBuV/m, so the maximum field strength in restrict band is  $95.7-55.01=40.69$ dBuV/m which is under 54 dBuV/m limit.

The band edge emission plot of DSSS technique on the following second page shows 57.5dB delta between carrier maximum power and local maximum emission in restrict band (2.4835GHz). The emission of carrier strength list in the test result of channel 11 at the item 4.2 is 95.9dBuV/m, so the maximum field strength in restrict band is  $95.9-57.5=38.4$ dBuV/m which is under 54 dBuV/m limit.



CH1

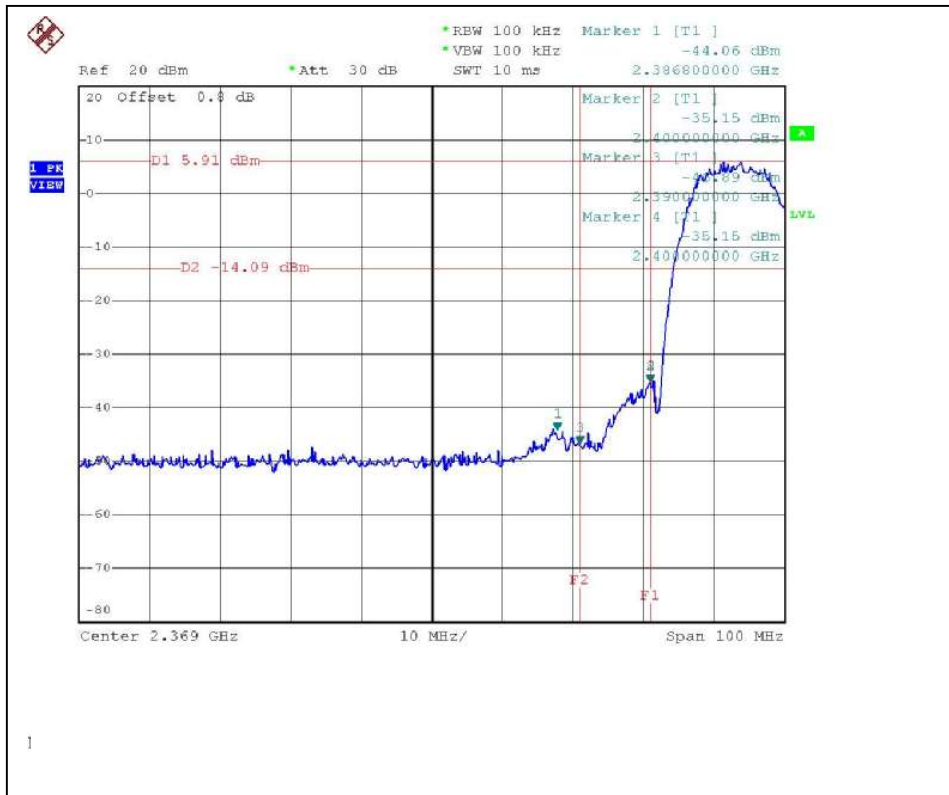

CH11

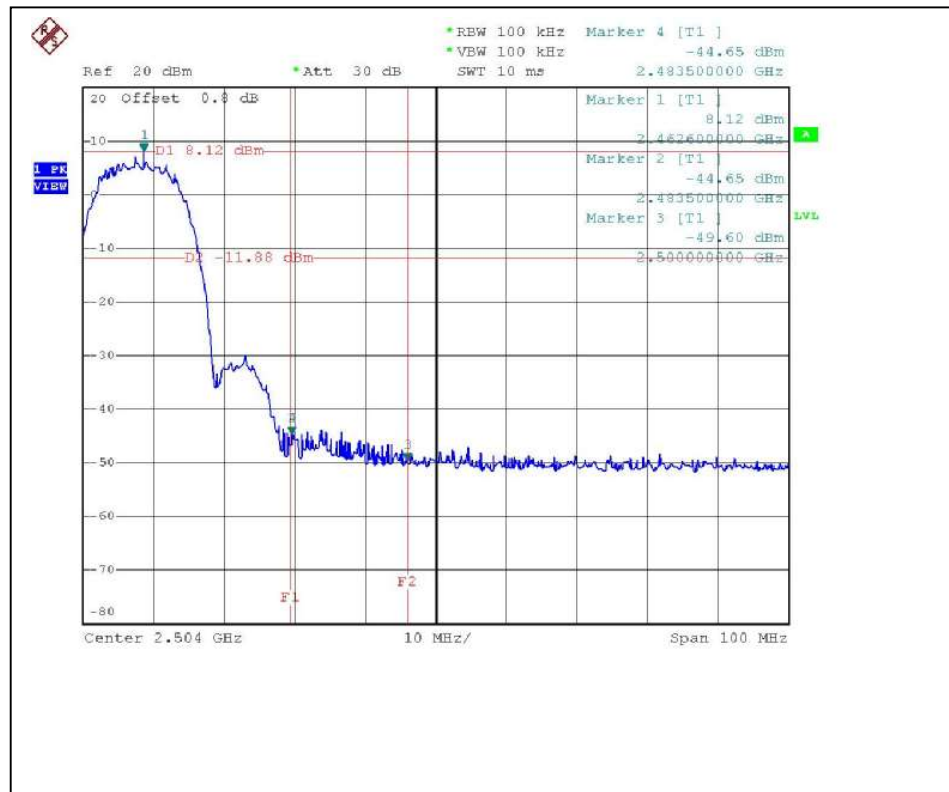



CH1

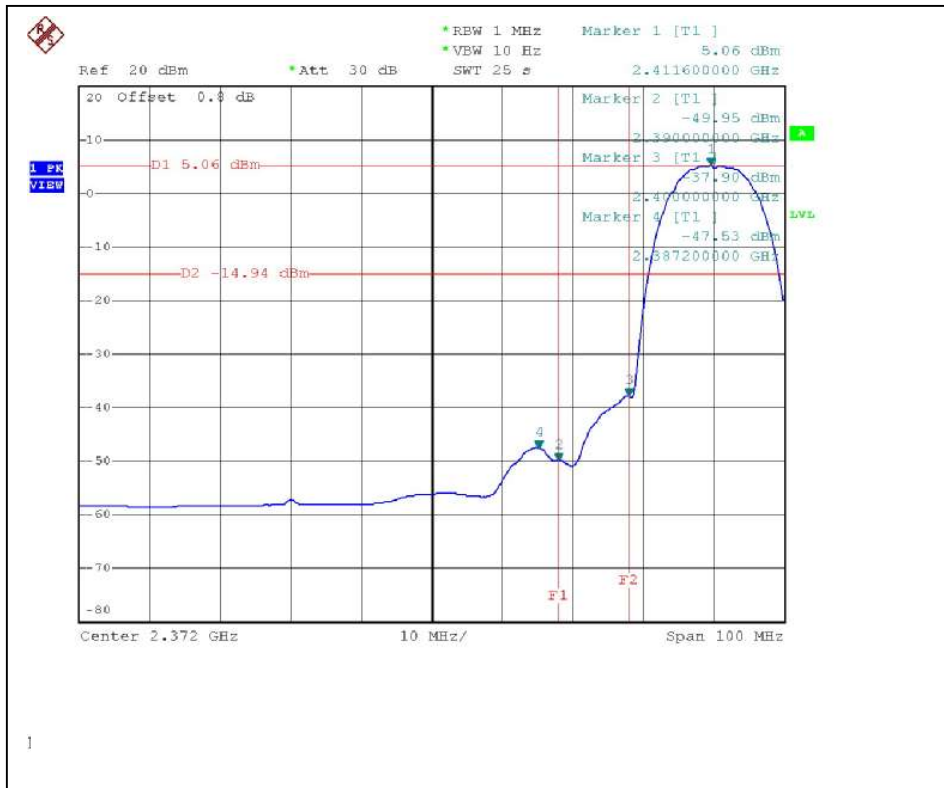

CH11

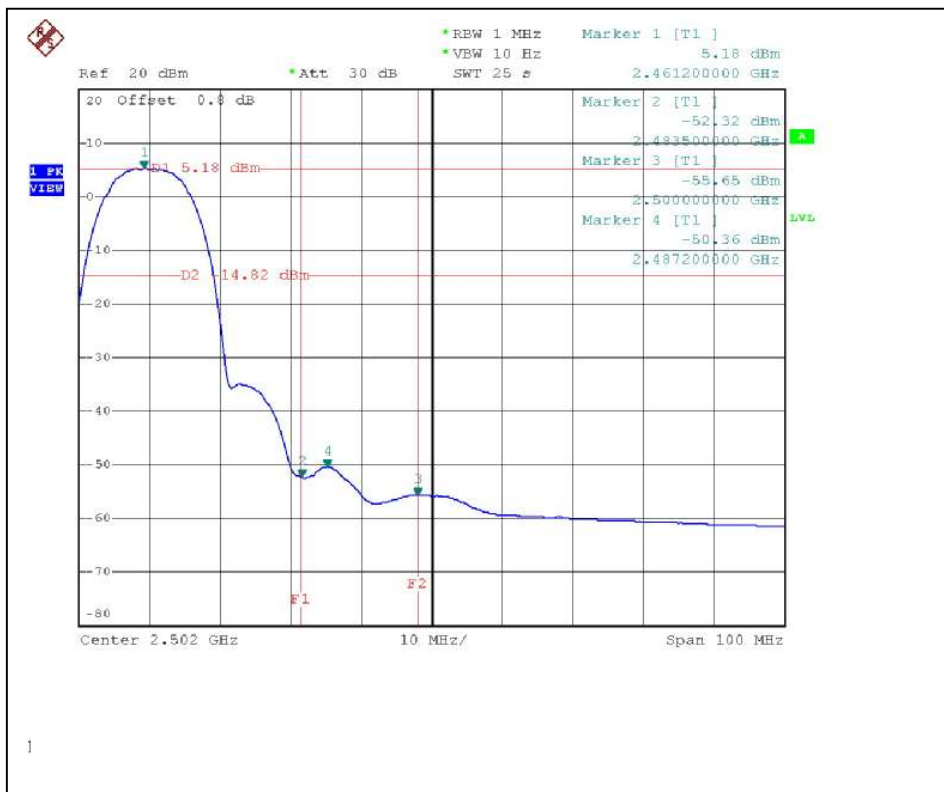



CH1

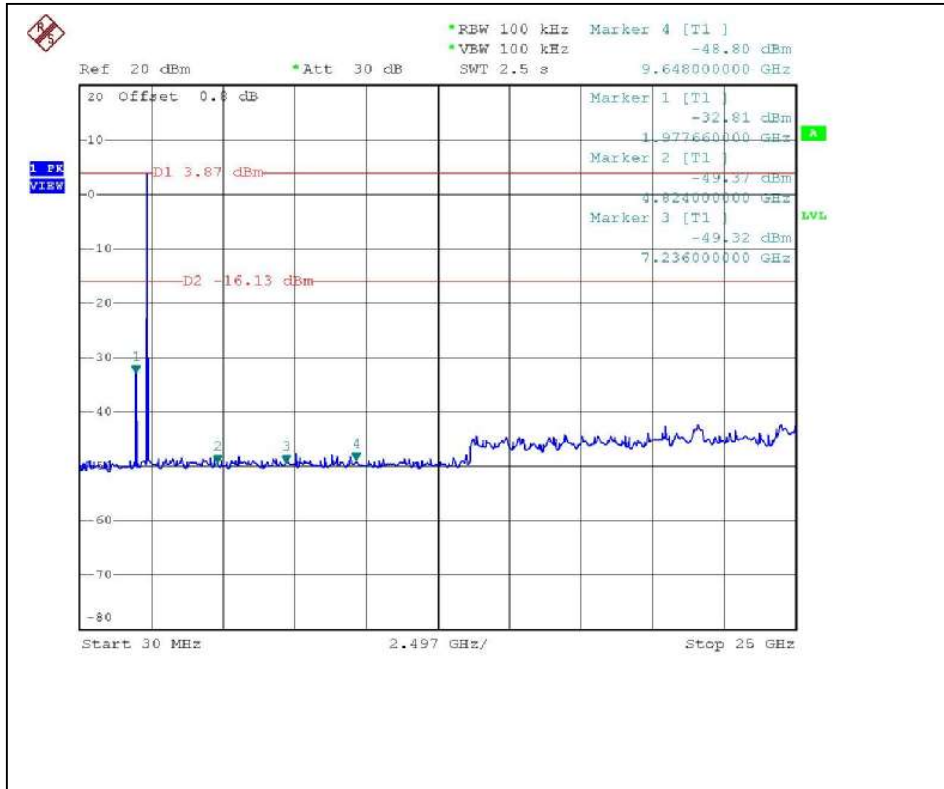

CH11

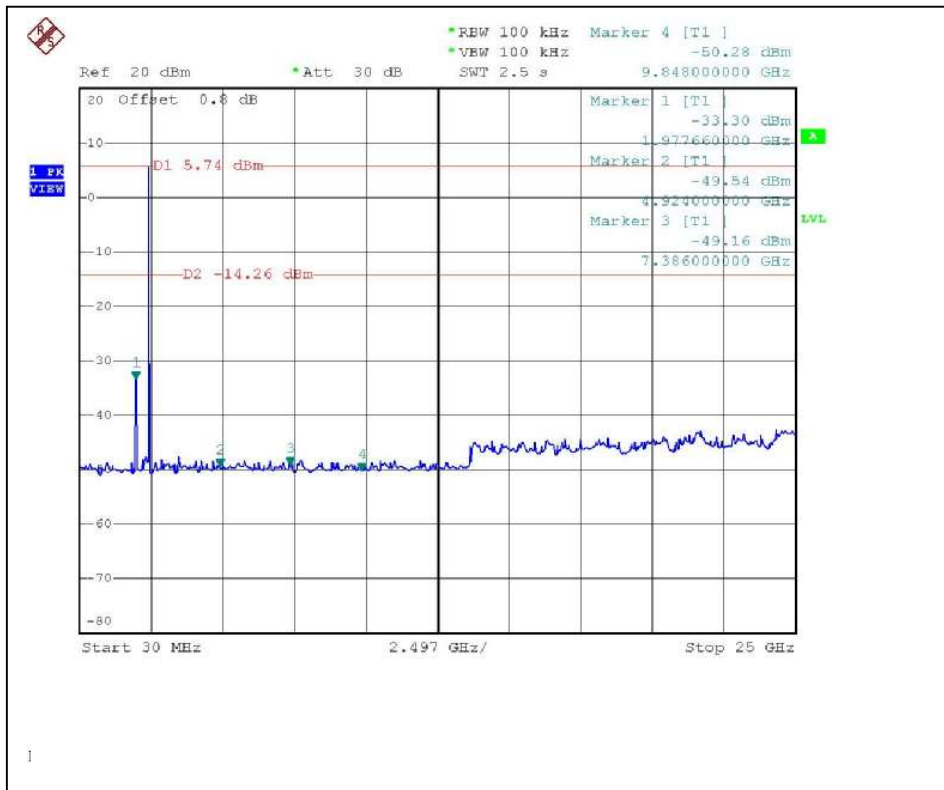



#### 4.6.6 TEST RESULTS –OFDM

The spectrum plots are attached on the following page. D1 line indicates the highest level, D2 line indicates the 20dB offset below D1. It shows compliance with the requirement in part 15.247(C).

Note - The delta method is only used up to 2 MHz away from the restricted bandage, The radiated emissions which located in other restricted frequency band, the result, please refer to 4.2.

##### **NOTE (Peak):**

The band edge emission plot of OFDM technique on the following first page show 38.77dB delta between carrier maximum power and local maximum emission in restrict band (2.3900GHz). The emission of carrier strength list in the test result of channel 1 at the item 4.2 is 99.8dBuV/m, so the maximum field strength in restrict band is  $99.8-38.77=61.03$ dBuV/m which is under 74 dBuV/m limit.

The band edge emission plot of OFDM technique on the following first page shows 39.32dB delta between carrier maximum power and local maximum emission in restrict band (2.4835GHz). The emission of carrier strength list in the test result of channel 11 at the item 4.2 is 99.9dBuV/m, so the maximum field strength in restrict band is  $99.9-39.32=60.58$ dBuV/m which is under 74 dBuV/m limit.

##### **NOTE (Average):**

The band edge emission plot of OFDM technique on the following second page shows 43.7dB delta between carrier maximum power and local maximum emission in restrict band (2.3900GHz). The emission of carrier strength list in the test result of channel 1 at the item 4.2 is 91.4dBuV/m, so the maximum field strength in restrict band is  $91.4-43.7=47.70$ dBuV/m which is under 54 dBuV/m limit.

The band edge emission plot of OFDM technique on the following second page shows 42.54dB delta between carrier maximum power and local maximum emission in restrict band (2.4835GHz). The emission of carrier strength list in the test result of channel 11 at the item 4.2 is 91.0dBuV/m, so the maximum field strength in restrict band is  $91.0-42.54=48.46$ dBuV/m which is under 54 dBuV/m limit.



CH1

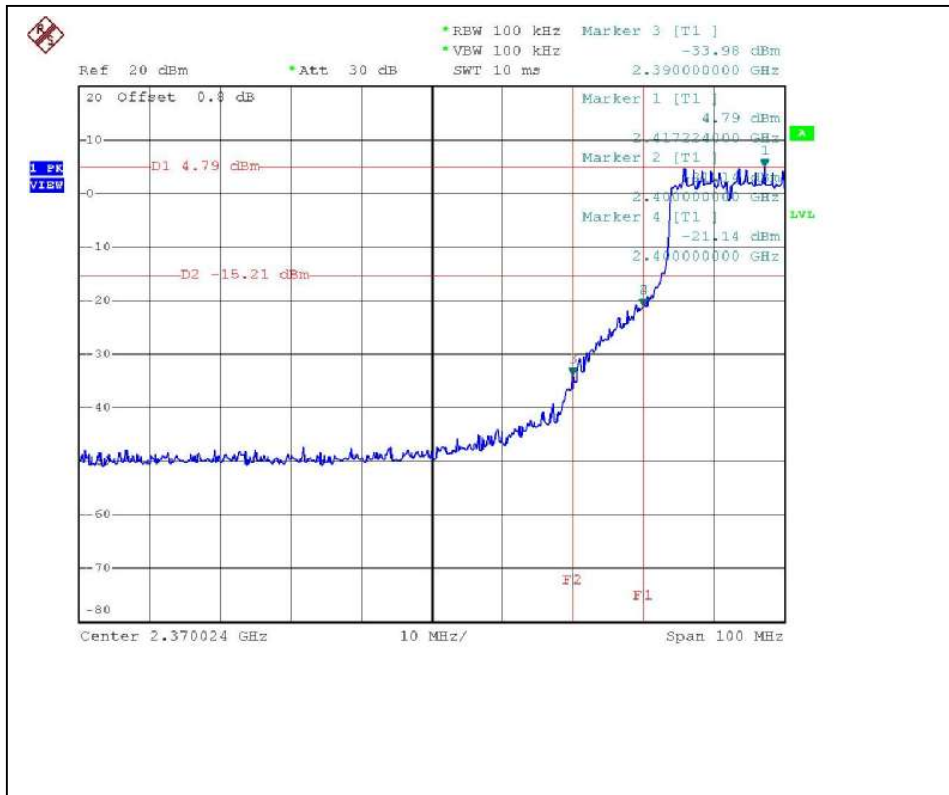

CH11

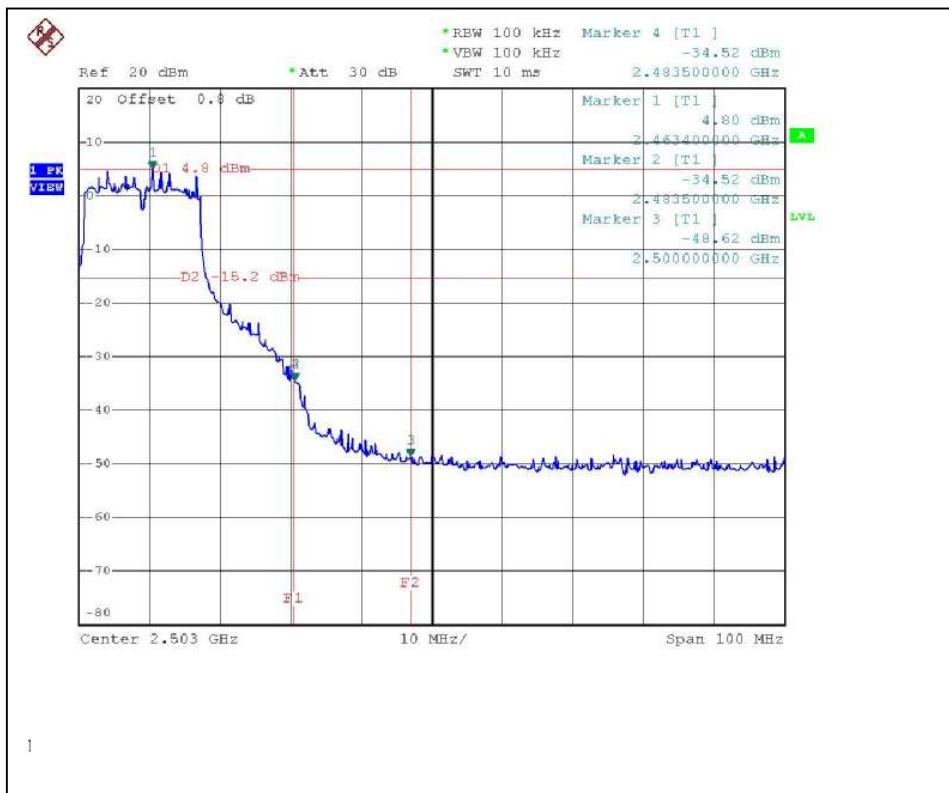



CH1

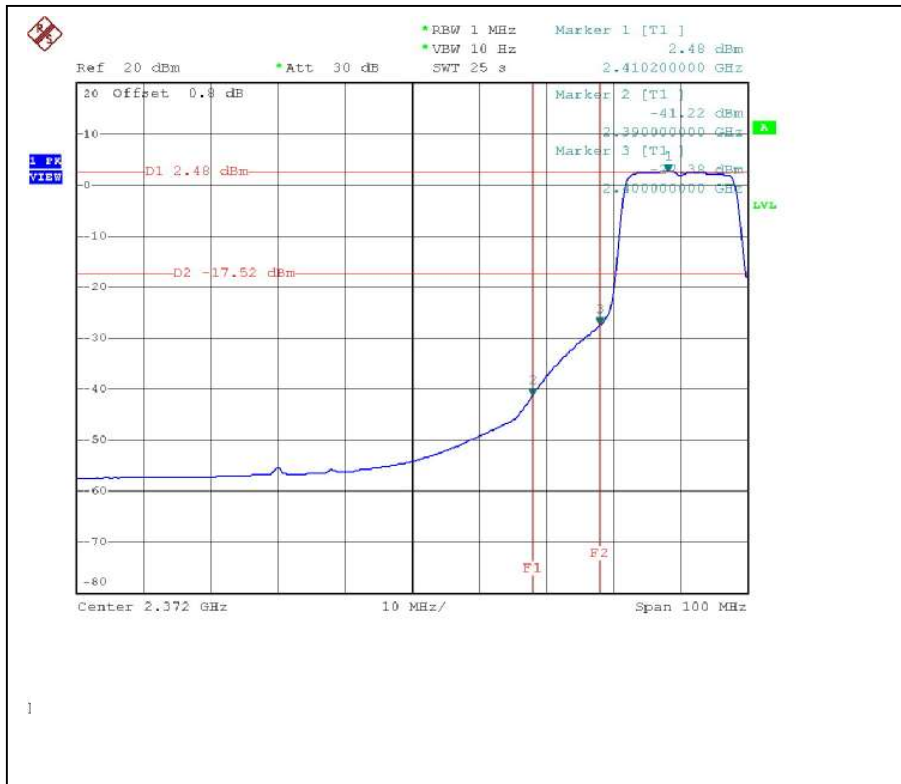

CH11

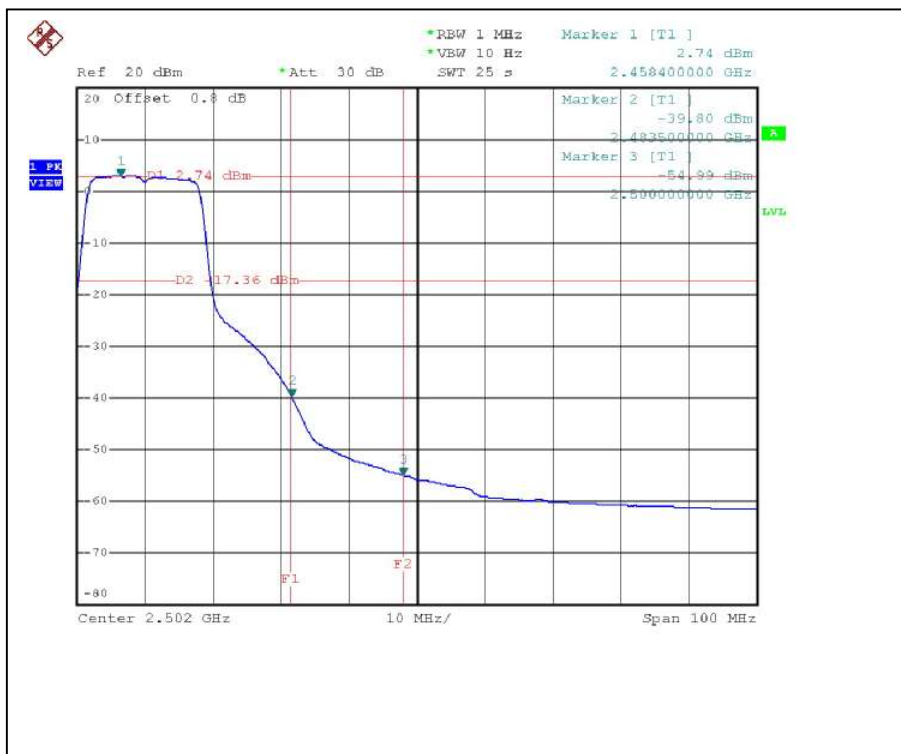



CH1

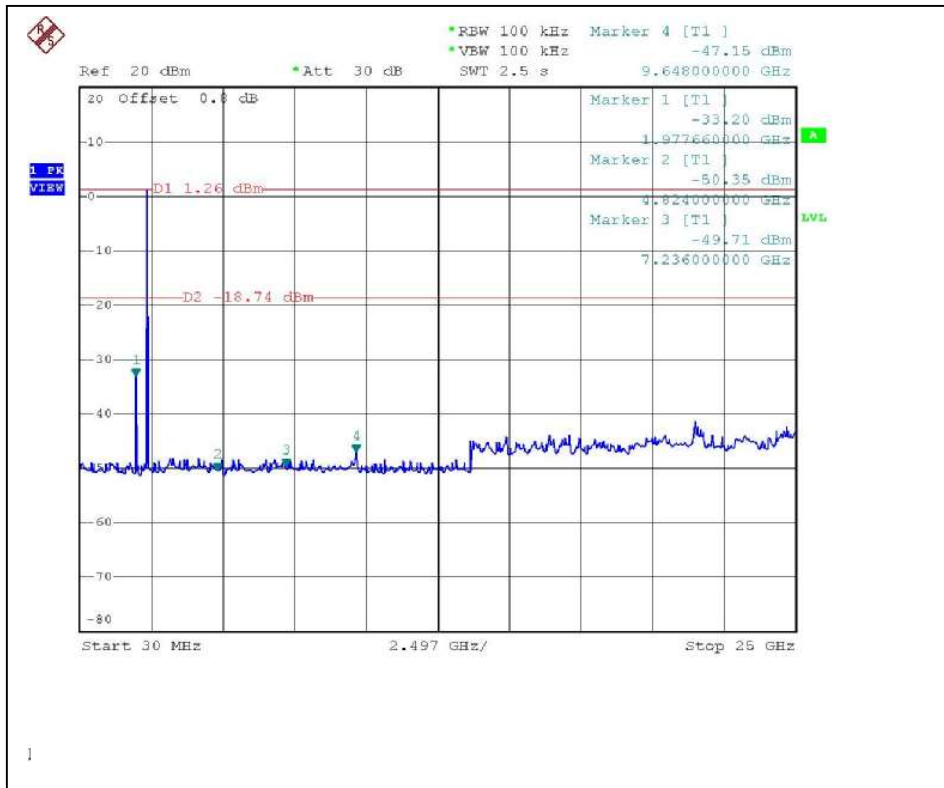

CH11

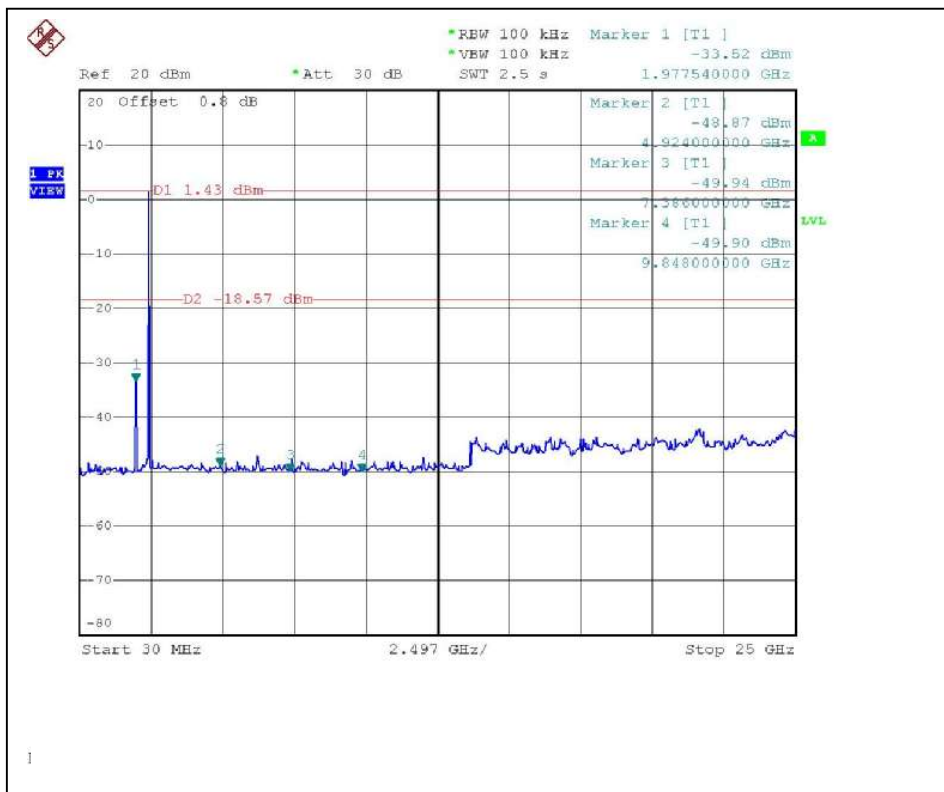





## 802.11g Turbo OFDM modulation

The spectrum plots are attached on the following page. D1 line indicates the highest level, D2 line indicates the 20dB offset below D1. It shows compliance with the requirement in part 15.247(C).

Note - The delta method is only used up to 2 MHz away from the restricted bandage, The radiated emissions which located in other restricted frequency band, the result, please refer to 4.2.

### NOTE (Peak):

The band edge emission plot of OFDM technique on the following first page show 46.95dB delta between carrier maximum power and local maximum emission in restrict band (2.3900GHz). The emission of carrier strength list in the test result of channel 6 at the item 4.2 is 98.1dBuV/m, so the maximum field strength in restrict band is  $98.1 - 46.95 = 51.15$  dBuV/m which is under 74 dBuV/m limit.

The band edge emission plot of OFDM technique on the following first page shows 46.79dB delta between carrier maximum power and local maximum emission in restrict band (2.4835GHz). The emission of carrier strength list in the test result of channel 6 at the item 4.2 is 98.1dBuV/m, so the maximum field strength in restrict band is  $98.1 - 46.79 = 51.31$  dBuV/m which is under 74 dBuV/m limit.

### NOTE (Average):

The band edge emission plot of OFDM technique on the following second page shows 44.09dB delta between carrier maximum power and local maximum emission in restrict band (2.3900GHz). The emission of carrier strength list in the test result of channel 6 at the item 4.2 is 89.8dBuV/m, so the maximum field strength in restrict band is  $89.8 - 44.09 = 45.71$  dBuV/m which is under 54 dBuV/m limit.

The band edge emission plot of OFDM technique on the following second page shows 46.05dB delta between carrier maximum power and local maximum emission in restrict band (2.4835GHz). The emission of carrier strength list in the test result of channel 6 at the item 4.2 is 89.8dBuV/m, so the maximum field strength in restrict band is  $89.8 - 46.05 = 43.75$  dBuV/m which is under 54 dBuV/m limit.



CH6

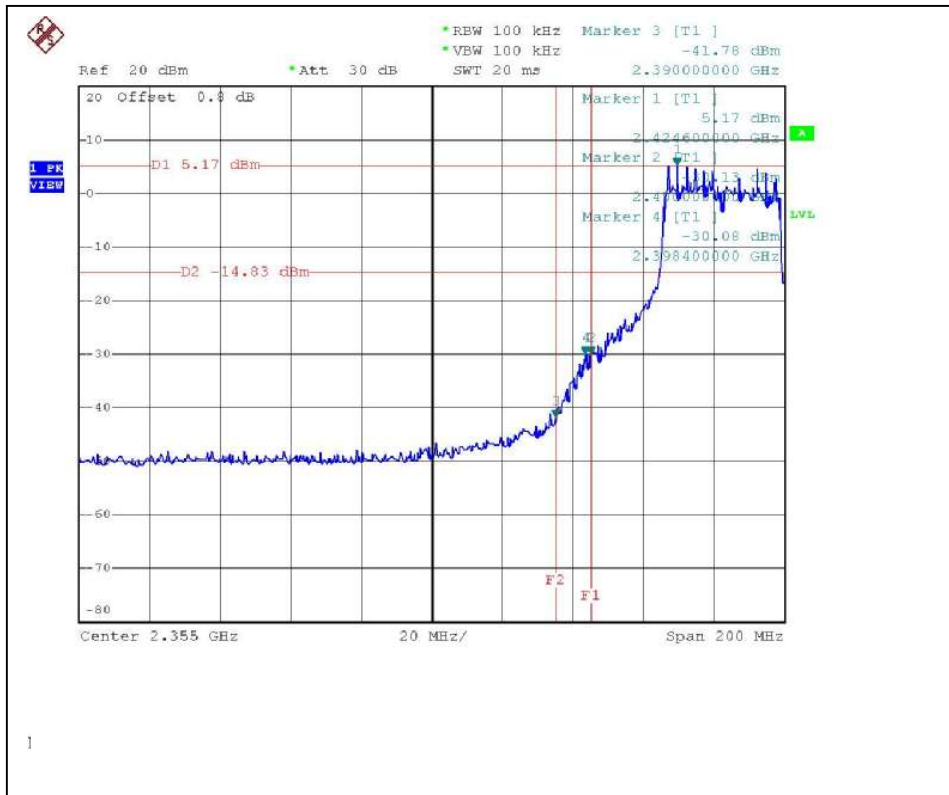

CH6

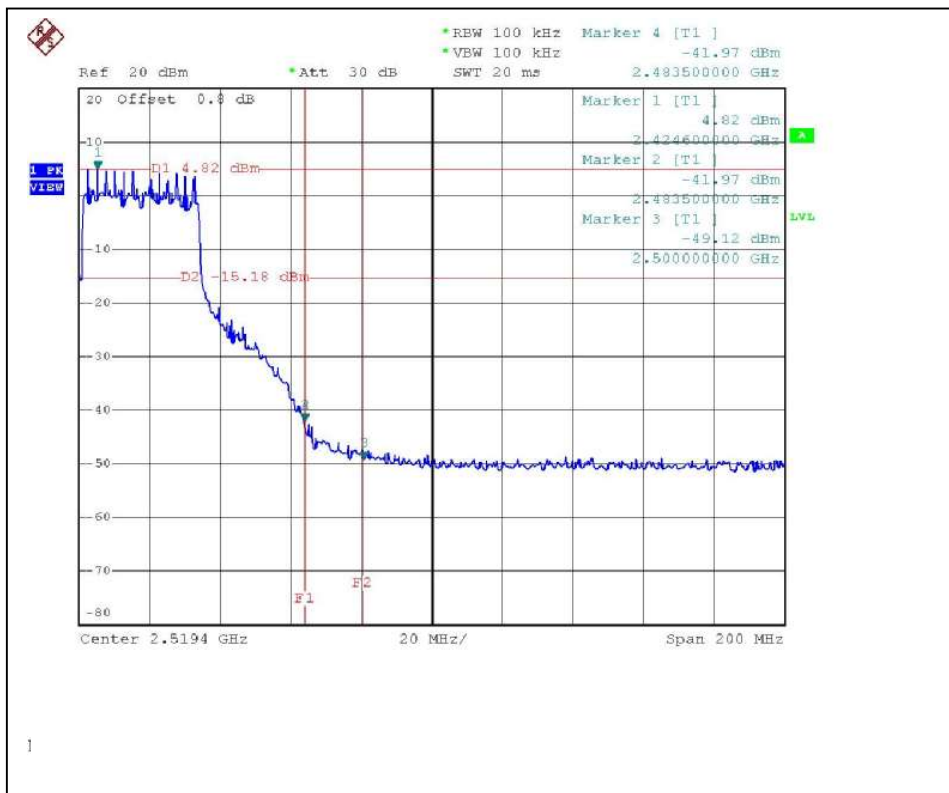



CH6

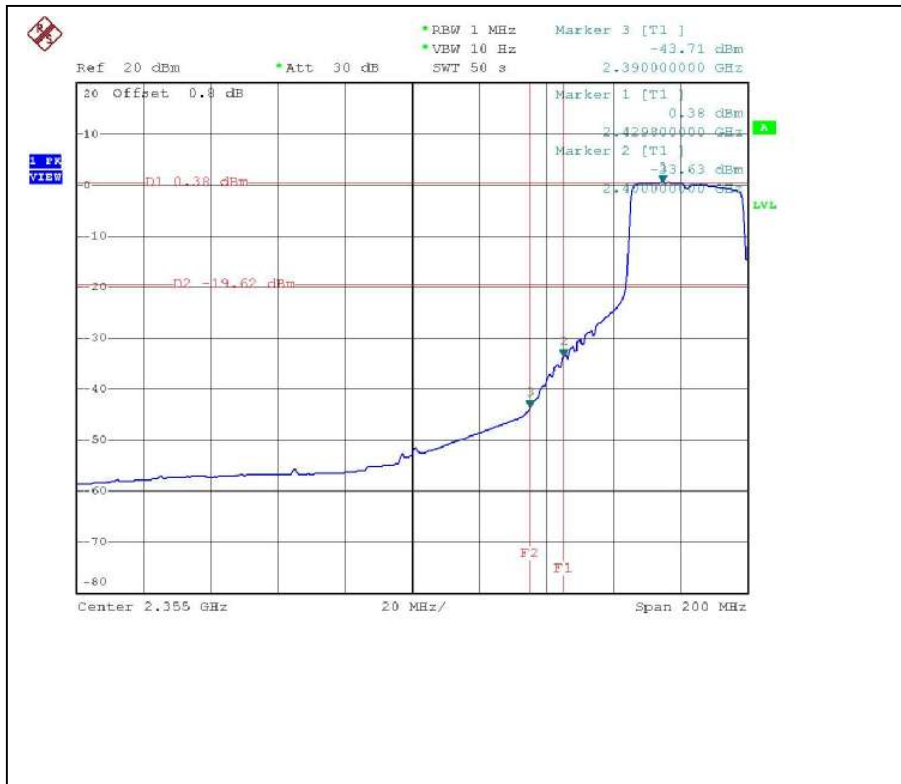

CH6

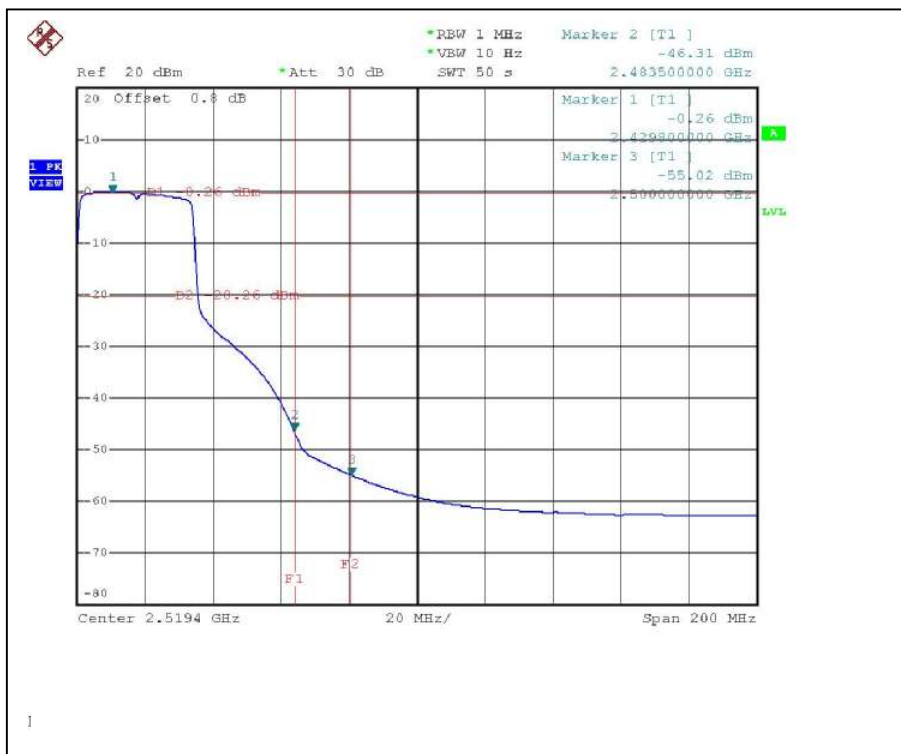



CH6

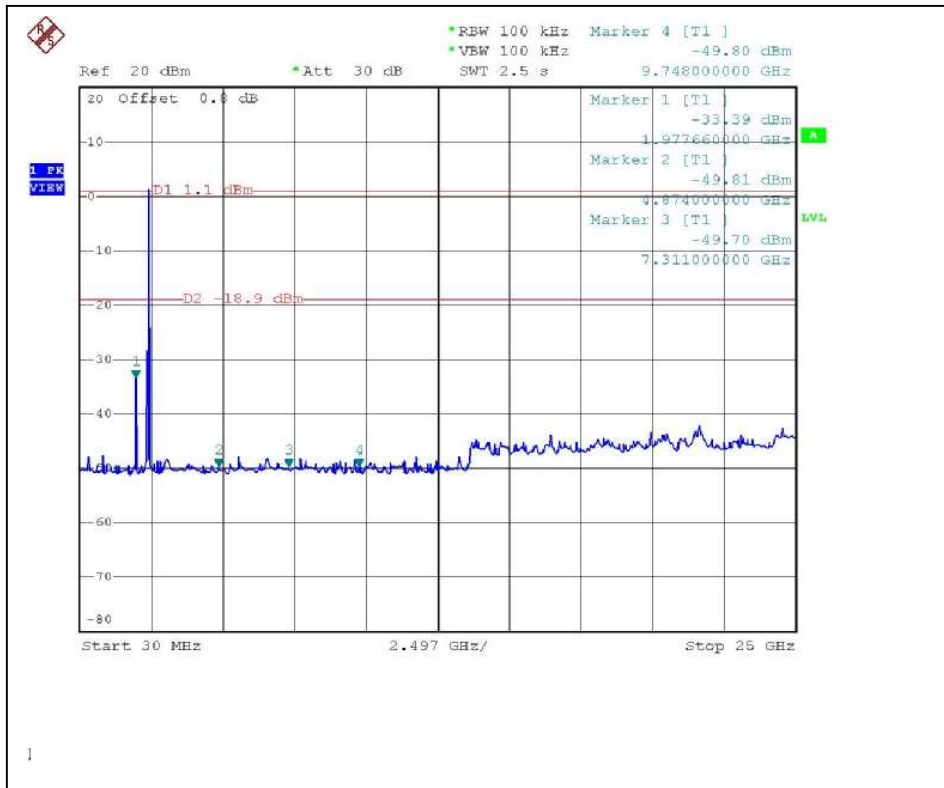



## **4.7 ANTENNA REQUIREMENT**

### **4.7.1 STANDARD APPLICABLE**

For intentional device, according to FCC 47 CFR Section 15.203, an intentional radiator shall be designed to ensure that no antenna other than that furnished by the responsible party shall be used with the device.

And according to FCC 47 CFR Section 15.247 (b), if transmitting antennas of directional gain greater than 6dBi are used, the power shall be reduced by the amount in dB that the directional gain of the antenna exceeds 6dBi.

### **4.7.2 ANTENNA CONNECTED CONSTRUCTION**

The antenna used in this product is printed antenna without connector. The maximum Gain of the antenna is  $-2.0\text{dBi}$ .

## 5 PHOTOGRAPHS OF THE TEST CONFIGURATION CONDUCTED EMISSION TEST (WITH USB CRADLE)



### RADIATED EMISSION TEST (WITHOUT USB CRADLE)



### RADIATED EMISSION TEST (WITH USB CRADLE)

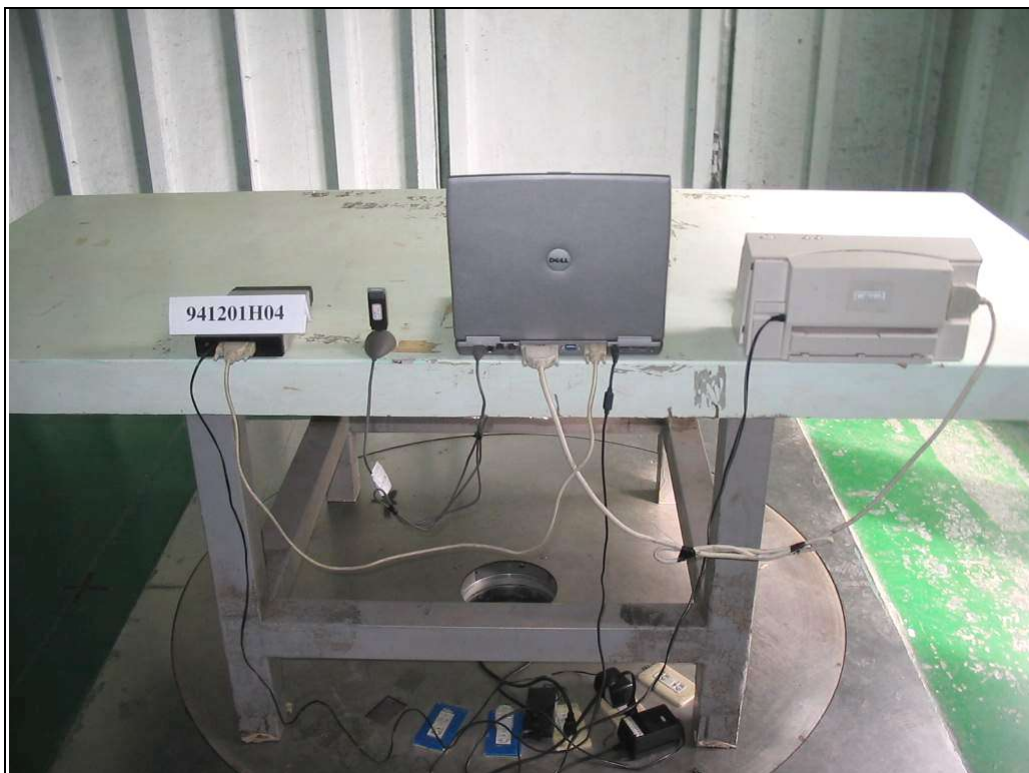





## 6 INFORMATION ON THE TESTING LABORATORIES

We, ADT Corp., were founded in 1988 to provide our best service in EMC, Radio, Telecom and Safety consultation. Our laboratories are accredited and approved by the following approval agencies according to ISO/IEC 17025:

<b>USA</b>	FCC, NVLAP, UL, A2LA
<b>Germany</b>	TUV Rheinland
<b>Japan</b>	VCCI
<b>Norway</b>	NEMKO
<b>Canada</b>	INDUSTRY CANADA, CSA
<b>R.O.C.</b>	CNLA, BSMI, DGT
<b>Netherlands</b>	Telefication
<b>Singapore</b>	PSB, GOST-ASIA (MOU)
<b>Russia</b>	CERTIS (MOU)

Copies of accreditation certificates of our laboratories obtained from approval agencies can be downloaded from our web site: [www.adt.com.tw/index.5/phtml](http://www.adt.com.tw/index.5/phtml).

If you have any comments, please feel free to contact us at the following:

**Linko EMC/RF Lab:**

Tel: 886-2-26052180

Fax: 886-2-26052943

**Hsin Chu EMC/RF Lab:**

Tel: 886-3-5935343

Fax: 886-3-5935342

**Hwa Ya EMC/RF/Safety/Telecom Lab:**

Tel: 886-3-3183232

Fax: 886-3-3185050

**Email:** [service@adt.com.tw](mailto:service@adt.com.tw)

**Web Site:** [www.adt.com.tw](http://www.adt.com.tw)

The address and road map of all our labs can be found in our web site also.



## **APPENDIX-A**

### **MODIFICATIONS RECORDERS FOR ENGINEERING CHANGES TO THE EUT BY THE LAB**

No any modifications are made to the EUT by the lab during the test.