

FCC SAR TEST REPORT

APPLICANT : D-Link Corporation
EQUIPMENT : 4G/LTE Mobile Router
BRAND NAME : D-Link
Model Name : DWR-932C
FCC ID : KA2WR932CF1
STANDARD : FCC 47 CFR Part 2 (2.1093)

We, Sporton International (Kunshan) Inc., would like to declare that the tested sample has been evaluated in accordance with the test procedures and has been in compliance with the applicable technical standards.

The test results in this report apply exclusively to the tested model / sample. Without written approval of Sporton International (Kunshan) Inc., the test report shall not be reproduced except in full.



Reviewed by: Nick Hu / Supervisor

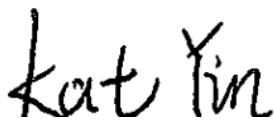

Approved by: Kat Yin / Manager



Sporton International (Kunshan) Inc.
No. 1098, Pengxi North Road, Kunshan Economic Development Zone Jiangsu Province 215300
People's Republic of China



Table of Contents

1. Statement of Compliance	4
2. Administration Data	5
3. Guidance Applied	5
4. Equipment Under Test (EUT) Information	6
4.1 General Information	6
4.2 General LTE SAR Test and Reporting Considerations	7
5. RF Exposure Limits	8
5.1 Uncontrolled Environment.....	8
5.2 Controlled Environment.....	8
6. Specific Absorption Rate (SAR)	9
6.1 Introduction	9
6.2 SAR Definition.....	9
7. System Description and Setup	10
7.1 E-Field Probe	11
7.2 Data Acquisition Electronics (DAE)	11
7.3 Phantom.....	12
7.4 Device Holder.....	13
8. Measurement Procedures	14
8.1 Spatial Peak SAR Evaluation.....	14
8.2 Power Reference Measurement.....	15
8.3 Area Scan	15
8.4 Zoom Scan.....	16
8.5 Volume Scan Procedures.....	16
8.6 Power Drift Monitoring.....	16
9. Test Equipment List	17
10. System Verification	18
10.1 Tissue Simulating Liquids.....	18
10.2 Tissue Verification	19
10.3 System Performance Check Results.....	20
11. RF Exposure Positions	21
11.1 Wireless Router.....	21
12. UMTS/LTE Output Power (Unit: dBm)	22
13. WiFi Output Power (Unit: dBm)	27
14. Antenna Location	28
15. SAR Test Results	29
15.1 Body SAR	30
15.2 Repeated SAR Measurement	33
16. Simultaneous Transmission Analysis	34
16.1 Body Exposure Conditions	35
17. Uncertainty Assessment	36
18. References	37
Appendix A. Plots of System Performance Check	
Appendix B. Plots of High SAR Measurement	
Appendix C. DASYS Calibration Certificate	
Appendix D. Test Setup Photos	
Appendix E. Conducted RF Output Power Table	



History of this test report

Report No.	Version	Description	Issued Date
FA140123	Rev. 01	Initial issue of report	Jun. 18, 2021



1. Statement of Compliance

The maximum results of Specific Absorption Rate (SAR) found during testing for **D-Link Corporation, 4G/LTE Mobile Router, DWR-932C**, are as follows.

Highest Standalone 1g SAR Summary				
Equipment Class	Frequency Band		Body(Separation 10mm)	Highest Simultaneous Transmission 1g SAR (W/kg)
			1g SAR (W/kg)	
Licensed	WCDMA	Band V	1.08	1.38
	LTE	Band 4	0.65	
		Band 5	0.91	
		Band 7	1.12	
DTS	WLAN	2.4GHz WLAN	0.17	1.38
Date of Testing:		2021/5/20 ~ 2021/5/24		

Declaration of Conformity:
The test results with all measurement uncertainty excluded are presented in accordance with the regulation limits or requirements declared by manufacturers.
Comments and Explanations:
The declared of product specification for EUT presented in the report are provided by the manufacturer, and the manufacturer takes all the responsibilities for the accuracy of product specification.

This device is in compliance with Specific Absorption Rate (SAR) for general population/uncontrolled exposure limits (1.6 W/kg for Partial-Body 1g SAR) specified in FCC 47 CFR part 2 (2.1093) and ANSI/IEEE C95.1-1992, and had been tested in accordance with the measurement methods and procedures specified in IEEE 1528-2013 and FCC KDB publications



2. Administration Data

Sporton International (Kunshan) Inc. is accredited to ISO/IEC 17025:2017 by American Association for Laboratory Accreditation with Certificate Number 5145.02.

Testing Laboratory		
Test Firm	Sporton International (Kunshan) Inc.	
Test Site Location	No. 1098, Pengxi North Road, Kunshan Economic Development Zone Jiangsu Province 215300 People's Republic of China TEL : +86-512-57900158 FAX : +86-512-57900958	
Test Site No.	FCC Designation No.	FCC Test Firm Registration No.
	CN1257	314309

Applicant	
Company Name	D-Link Corporation
Address	No.289, Xinhua 3rd Rd., Neihu District, Taipei 11494, Taiwan, R.O.C.

Manufacturer	
Company Name	D-Link Corporation
Address	No.289, Xinhua 3rd Rd., Neihu District, Taipei 11494, Taiwan, R.O.C.

3. Guidance Applied

The Specific Absorption Rate (SAR) testing specification, method, and procedure for this device is in accordance with the following standards:

- FCC 47 CFR Part 2 (2.1093)
- ANSI/IEEE C95.1-1992
- IEEE 1528-2013
- FCC KDB 865664 D01 SAR Measurement 100 MHz to 6 GHz v01r04
- FCC KDB 865664 D02 SAR Reporting v01r02
- FCC KDB 447498 D01 General RF Exposure Guidance v06
- FCC KDB 248227 D01 802.11 Wi-Fi SAR v02r02
- FCC KDB 941225 D01 3G SAR Procedures v03r01
- FCC KDB 941225 D05 SAR for LTE Devices v02r05
- FCC KDB 941225 D06 Hotspot Mode SAR v02r01

4. Equipment Under Test (EUT) Information

4.1 General Information

Product Feature & Specification	
Equipment Name	4G/LTE Mobile Router
Brand Name	D-Link
Model Name	DWR-932C
FCC ID	KA2WR932CF1
IMEI Code	352247049856629
Wireless Technology and Frequency Range	WCDMA Band V: 824 MHz ~ 849 MHz LTE Band 4: 1710 MHz ~ 1755 MHz LTE Band 5: 824 MHz ~ 849 MHz LTE Band 7: 2500 MHz ~ 2570 MHz WLAN 2.4GHz Band: 2400 MHz ~ 2483.5 MHz
Mode	RMC 12.2Kbps HSDPA HSUPA DC-HSDPA HSPA+ (16QAM uplink is not supported) LTE: QPSK, 16QAM WLAN 2.4GHz 802.11b/g/n HT20/HT40
HW Version	F1
SW Version	01.04.WW
EUT Stage	Production Unit
Remark:	
1. This device does not support voice function.	



4.2 General LTE SAR Test and Reporting Considerations

Summarized necessary items addressed in KDB 941225 D05 v02r05																																																															
FCC ID	KA2WR932CF1																																																														
Equipment Name	4G/LTE Mobile Router																																																														
Operating Frequency Range of each LTE transmission band	LTE Band 4: 1710 MHz ~ 1755 MHz LTE Band 5: 824 MHz ~ 849 MHz LTE Band 7: 2500 MHz ~ 2570 MHz																																																														
Channel Bandwidth	LTE Band 4: 1.4MHz, 3MHz, 5MHz, 10MHz, 15MHz, 20MHz LTE Band 5: 1.4MHz, 3MHz, 5MHz, 10MHz LTE Band 7: 5MHz, 10MHz, 15MHz, 20MHz																																																														
uplink modulations used	QPSK / 16QAM																																																														
LTE release	R8, Cat 4																																																														
CA support	Not Supported																																																														
LTE Voice / Data requirements	Data only																																																														
LTE MPR permanently built-in by design	Table 6.2.3-1: Maximum Power Reduction (MPR) for Power Class 1, 2 and 3																																																														
	<table border="1"> <thead> <tr> <th rowspan="2">Modulation</th> <th colspan="6">Channel bandwidth / Transmission bandwidth (N_{RB})</th> <th rowspan="2">MPR (dB)</th> </tr> <tr> <th>1.4 MHz</th> <th>3.0 MHz</th> <th>5 MHz</th> <th>10 MHz</th> <th>15 MHz</th> <th>20 MHz</th> </tr> </thead> <tbody> <tr> <td>QPSK</td> <td>> 5</td> <td>> 4</td> <td>> 8</td> <td>> 12</td> <td>> 16</td> <td>> 18</td> <td>≤ 1</td> </tr> <tr> <td>16 QAM</td> <td>≤ 5</td> <td>≤ 4</td> <td>≤ 8</td> <td>≤ 12</td> <td>≤ 16</td> <td>≤ 18</td> <td>≤ 1</td> </tr> <tr> <td>16 QAM</td> <td>> 5</td> <td>> 4</td> <td>> 8</td> <td>> 12</td> <td>> 16</td> <td>> 18</td> <td>≤ 2</td> </tr> <tr> <td>64 QAM</td> <td>≤ 5</td> <td>≤ 4</td> <td>≤ 8</td> <td>≤ 12</td> <td>≤ 16</td> <td>≤ 18</td> <td>≤ 2</td> </tr> <tr> <td>64 QAM</td> <td>> 5</td> <td>> 4</td> <td>> 8</td> <td>> 12</td> <td>> 16</td> <td>> 18</td> <td>≤ 3</td> </tr> <tr> <td>256 QAM</td> <td colspan="6" style="text-align: center;">≥ 1</td> <td>≤ 5</td> </tr> </tbody> </table>	Modulation	Channel bandwidth / Transmission bandwidth (N _{RB})						MPR (dB)	1.4 MHz	3.0 MHz	5 MHz	10 MHz	15 MHz	20 MHz	QPSK	> 5	> 4	> 8	> 12	> 16	> 18	≤ 1	16 QAM	≤ 5	≤ 4	≤ 8	≤ 12	≤ 16	≤ 18	≤ 1	16 QAM	> 5	> 4	> 8	> 12	> 16	> 18	≤ 2	64 QAM	≤ 5	≤ 4	≤ 8	≤ 12	≤ 16	≤ 18	≤ 2	64 QAM	> 5	> 4	> 8	> 12	> 16	> 18	≤ 3	256 QAM	≥ 1						≤ 5
	Modulation		Channel bandwidth / Transmission bandwidth (N _{RB})							MPR (dB)																																																					
		1.4 MHz	3.0 MHz	5 MHz	10 MHz	15 MHz	20 MHz																																																								
	QPSK	> 5	> 4	> 8	> 12	> 16	> 18	≤ 1																																																							
	16 QAM	≤ 5	≤ 4	≤ 8	≤ 12	≤ 16	≤ 18	≤ 1																																																							
16 QAM	> 5	> 4	> 8	> 12	> 16	> 18	≤ 2																																																								
64 QAM	≤ 5	≤ 4	≤ 8	≤ 12	≤ 16	≤ 18	≤ 2																																																								
64 QAM	> 5	> 4	> 8	> 12	> 16	> 18	≤ 3																																																								
256 QAM	≥ 1						≤ 5																																																								
LTE A-MPR	In the base station simulator configuration, Network Setting value is set to NS_01 to disable A-MPR during SAR testing and the LTE SAR tests was transmitting on all TTI frames (Maximum TTI)																																																														
Spectrum plots for RB configuration	A properly configured base station simulator was used for the SAR and power measurement; therefore, spectrum plots for each RB allocation and offset configuration are not included in the SAR report.																																																														

Transmission (H, M, L) channel numbers and frequencies in each LTE band												
LTE Band 4												
	Bandwidth 1.4 MHz		Bandwidth 3 MHz		Bandwidth 5 MHz		Bandwidth 10 MHz		Bandwidth 15 MHz		Bandwidth 20 MHz	
	Ch. #	Freq. (MHz)	Ch. #	Freq. (MHz)	Ch. #	Freq. (MHz)	Ch. #	Freq. (MHz)	Ch. #	Freq. (MHz)	Ch. #	Freq. (MHz)
L	19957	1710.7	19965	1711.5	19975	1712.5	20000	1715	20025	1717.5	20050	1720
M	20175	1732.5	20175	1732.5	20175	1732.5	20175	1732.5	20175	1732.5	20175	1732.5
H	20393	1754.3	20385	1753.5	20375	1752.5	20350	1750	20325	1747.5	20300	1745
LTE Band 5												
	Bandwidth 1.4 MHz		Bandwidth 3 MHz		Bandwidth 5 MHz		Bandwidth 10 MHz					
	Ch. #	Freq. (MHz)	Ch. #	Freq. (MHz)	Ch. #	Freq. (MHz)	Ch. #	Freq. (MHz)	Ch. #	Freq. (MHz)	Ch. #	Freq. (MHz)
L	20407	824.7	20415	825.5	20425	826.5	20425	826.5	20450	829		
M	20525	836.5	20525	836.5	20525	836.5	20525	836.5	20525	836.5		
H	20643	848.3	20635	847.5	20625	846.5	20625	846.5	20600	844		
LTE Band 7												
	Bandwidth 5 MHz		Bandwidth 10 MHz		Bandwidth 15 MHz		Bandwidth 20 MHz					
	Ch. #	Freq. (MHz)	Ch. #	Freq. (MHz)	Ch. #	Freq. (MHz)	Ch. #	Freq. (MHz)	Ch. #	Freq. (MHz)	Ch. #	Freq. (MHz)
L	20775	2502.5	20800	2505	20825	2507.5	20850	2510				
M	21100	2535	21100	2535	21100	2535	21100	2535				
H	21425	2567.5	21400	2565	21375	2562.5	21350	2560				

5. RF Exposure Limits

5.1 Uncontrolled Environment

Uncontrolled Environments are defined as locations where there is the exposure of individuals who have no knowledge or control of their exposure. The general population/uncontrolled exposure limits are applicable to situations in which the general public may be exposed or in which persons who are exposed as a consequence of their employment may not be made fully aware of the potential for exposure or cannot exercise control over their exposure. Members of the general public would come under this category when exposure is not employment-related; for example, in the case of a wireless transmitter that exposes persons in its vicinity.

5.2 Controlled Environment

Controlled Environments are defined as locations where there is exposure that may be incurred by persons who are aware of the potential for exposure, (i.e. as a result of employment or occupation). In general, occupational/controlled exposure limits are applicable to situations in which persons are exposed as a consequence of their employment, who have been made fully aware of the potential for exposure and can exercise control over their exposure. The exposure category is also applicable when the exposure is of a transient nature due to incidental passage through a location where the exposure levels may be higher than the general population/uncontrolled limits, but the exposed person is fully aware of the potential for exposure and can exercise control over his or her exposure by leaving the area or by some other appropriate means.

Limits for Occupational/Controlled Exposure (W/kg)

Whole-Body	Partial-Body	Hands, Wrists, Feet and Ankles
0.4	8.0	20.0

Limits for General Population/Uncontrolled Exposure (W/kg)

Whole-Body	Partial-Body	Hands, Wrists, Feet and Ankles
0.08	1.6	4.0

Whole-Body SAR is averaged over the entire body, partial-body SAR is averaged over any 1gram of tissue defined as a tissue volume in the shape of a cube. SAR for hands, wrists, feet and ankles is averaged over any 10 grams of tissue defined as a tissue volume in the shape of a cube.

6. Specific Absorption Rate (SAR)

6.1 Introduction

SAR is related to the rate at which energy is absorbed per unit mass in an object exposed to a radio field. The SAR distribution in a biological body is complicated and is usually carried out by experimental techniques or numerical modeling. The standard recommends limits for two tiers of groups, occupational/controlled and general population/uncontrolled, based on a person's awareness and ability to exercise control over his or her exposure. In general, occupational/controlled exposure limits are higher than the limits for general population/uncontrolled.

6.2 SAR Definition

The SAR definition is the time derivative (rate) of the incremental energy (dW) absorbed by (dissipated in) an incremental mass (dm) contained in a volume element (dv) of a given density (ρ). The equation description is as below:

$$SAR = \frac{d}{dt} \left(\frac{dW}{dm} \right) = \frac{d}{dt} \left(\frac{dW}{\rho dv} \right)$$

SAR is expressed in units of Watts per kilogram (W/kg)

$$SAR = \frac{\sigma |E|^2}{\rho}$$

Where: σ is the conductivity of the tissue, ρ is the mass density of the tissue and E is the RMS electrical field strength.

7. System Description and Setup

The DASY system used for performing compliance tests consists of the following items:

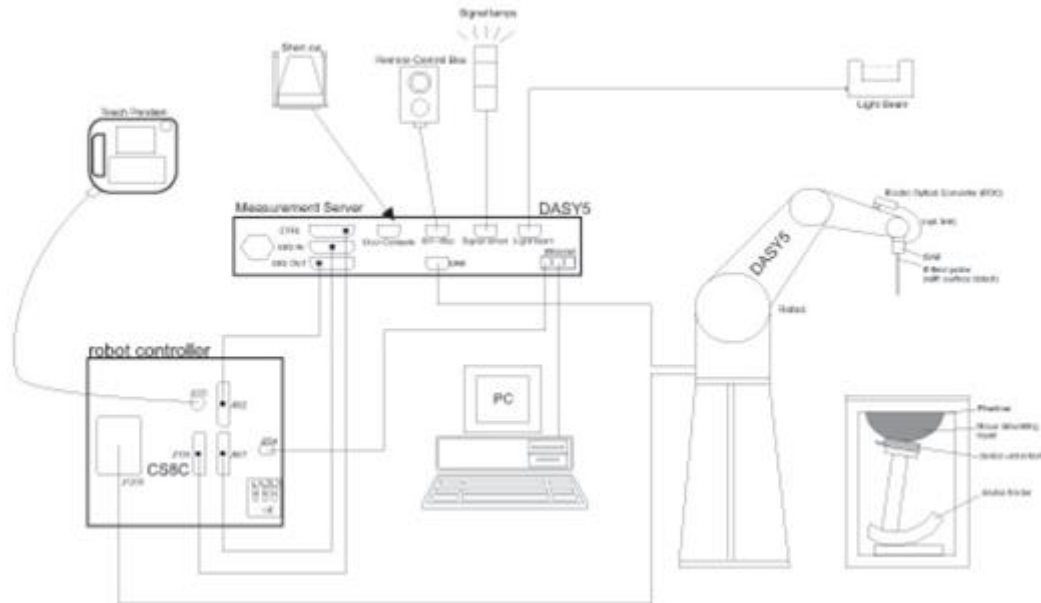

- A standard high precision 6-axis robot with controller, teach pendant and software. An arm extension for accommodating the data acquisition electronics (DAE).
- An isotropic Field probe optimized and calibrated for the targeted measurement.
- A data acquisition electronics (DAE) which performs the signal amplification, signal multiplexing, AD-conversion, offset measurements, mechanical surface detection, collision detection, etc. The unit is battery powered with standard or rechargeable batteries. The signal is optically transmitted to the EOC.
- The Electro-optical converter (EOC) performs the conversion from optical to electrical signals for the digital communication to the DAE. To use optical surface detection, a special version of the EOC is required. The EOC signal is transmitted to the measurement server.
- The function of the measurement server is to perform the time critical tasks such as signal filtering, control of the robot operation and fast movement interrupts.
- The Light Beam used is for probe alignment. This improves the (absolute) accuracy of the probe positioning.
- A computer running WinXP or Win7 and the DASY5 software.
- Remote control and teach pendant as well as additional circuitry for robot safety such as warning lamps, etc.
- The phantom, the device holder and other accessories according to the targeted measurement.

7.1 E-Field Probe

The SAR measurement is conducted with the dosimetric probe (manufactured by SPEAG).The probe is specially designed and calibrated for use in liquid with high permittivity. The dosimetric probe has special calibration in liquid at different frequency. This probe has a built in optical surface detection system to prevent from collision with phantom.

<ES3DV3 Probe>

Construction	Symmetric design with triangular core Interleaved sensors Built-in shielding against static charges PEEK enclosure material (resistant to organic solvents, e.g., DGBE)	
Frequency	10 MHz – 4 GHz; Linearity: ±0.2 dB (30 MHz – 4 GHz)	
Directivity	±0.2 dB in TSL (rotation around probe axis) ±0.3 dB in TSL (rotation normal to probe axis)	
Dynamic Range	5 μW/g – >100 mW/g; Linearity: ±0.2 dB	
Dimensions	Overall length: 337 mm (tip: 20 mm) Tip diameter: 3.9 mm (body: 12 mm) Distance from probe tip to dipole centers: 3.0 mm	

7.2 Data Acquisition Electronics (DAE)

The data acquisition electronics (DAE) consists of a highly sensitive electrometer-grade preamplifier with auto-zeroing, a channel and gain-switching multiplexer, a fast 16 bit AD-converter and a command decoder and control logic unit. Transmission to the measurement server is accomplished through an optical downlink for data and status information as well as an optical uplink for commands and the clock.

The input impedance of the DAE is 200 MOhm; the inputs are symmetrical and floating. Common mode rejection is above 80 dB.



Fig 5.1 Photo of DAE

7.3 Phantom

<SAM Twin Phantom>

Shell Thickness	2 ± 0.2 mm; Center ear point: 6 ± 0.2 mm	
Filling Volume	Approx. 25 liters	
Dimensions	Length: 1000 mm; Width: 500 mm; Height: adjustable feet	
Measurement Areas	Left Hand, Right Hand, Flat Phantom	

The bottom plate contains three pair of bolts for locking the device holder. The device holder positions are adjusted to the standard measurement positions in the three sections. A white cover is provided to tap the phantom during off-periods to prevent water evaporation and changes in the liquid parameters. On the phantom top, three reference markers are provided to identify the phantom position with respect to the robot.

<ELI Phantom>

Shell Thickness	2 ± 0.2 mm (sagging: <1%)	
Filling Volume	Approx. 30 liters	
Dimensions	Major ellipse axis: 600 mm Minor axis: 400 mm	

The ELI phantom is intended for compliance testing of handheld and body-mounted wireless devices in the frequency range of 30 MHz to 6 GHz. ELI4 is fully compatible with standard and all known tissue simulating liquids.

7.4 Device Holder

<Mounting Device for Hand-Held Transmitter>

In combination with the Twin SAM V5.0/V5.0c or ELI phantoms, the Mounting Device for Hand-Held Transmitters enables rotation of the mounted transmitter device to specified spherical coordinates. At the heads, the rotation axis is at the ear opening. Transmitter devices can be easily and accurately positioned according to IEC 62209-1, IEEE 1528, FCC, or other specifications. The device holder can be locked for positioning at different phantom sections (left head, right head, flat). And upgrade kit to Mounting Device to enable easy mounting of wider devices like big smart-phones, e-books, small tablets, etc. It holds devices with width up to 140 mm.



Mounting Device for Hand-Held Transmitters



Mounting Device Adaptor for Wide-Phones

<Mounting Device for Laptops and other Body-Worn Transmitters>

The extension is lightweight and made of POM, acrylic glass and foam. It fits easily on the upper part of the mounting device in place of the phone positioned. The extension is fully compatible with the SAM Twin and ELI phantoms.



Mounting Device for Laptops

8. Measurement Procedures

The measurement procedures are as follows:

<Conducted power measurement>

- (a) For WWAN power measurement, use base station simulator to configure EUT WWAN transmission in conducted connection with RF cable, at maximum power in each supported wireless interface and frequency band.
- (b) Read the WWAN RF power level from the base station simulator.
- (c) For WLAN/BT power measurement, use engineering software to configure EUT WLAN/BT continuously transmission, at maximum RF power in each supported wireless interface and frequency band
- (d) Connect EUT RF port through RF cable to the power meter, and measure WLAN/BT output power

<SAR measurement>

- (a) Use base station simulator to configure EUT WWAN transmission in radiated connection, and engineering software to configure EUT WLAN/BT continuously transmission, at maximum RF power, in the highest power channel.
- (b) Place the EUT in the positions as Appendix D demonstrates.
- (c) Set scan area, grid size and other setting on the DASY software.
- (d) Measure SAR results for the highest power channel on each testing position.
- (e) Find out the largest SAR result on these testing positions of each band
- (f) Measure SAR results for other channels in worst SAR testing position if the reported SAR of highest power channel is larger than 0.8 W/kg

According to the test standard, the recommended procedure for assessing the peak spatial-average SAR value consists of the following steps:

- (a) Power reference measurement
- (b) Area scan
- (c) Zoom scan
- (d) Power drift measurement

8.1 Spatial Peak SAR Evaluation

The procedure for spatial peak SAR evaluation has been implemented according to the test standard. It can be conducted for 1g and 10g, as well as for user-specific masses. The DASY software includes all numerical procedures necessary to evaluate the spatial peak SAR value.

The base for the evaluation is a "cube" measurement. The measured volume must include the 1g and 10g cubes with the highest averaged SAR values. For that purpose, the center of the measured volume is aligned to the interpolated peak SAR value of a previously performed area scan.

The entire evaluation of the spatial peak values is performed within the post-processing engine (SEMCAD). The system always gives the maximum values for the 1g and 10g cubes. The algorithm to find the cube with highest averaged SAR is divided into the following stages:

- (a) Extraction of the measured data (grid and values) from the Zoom Scan
- (b) Calculation of the SAR value at every measurement point based on all stored data (A/D values and measurement parameters)
- (c) Generation of a high-resolution mesh within the measured volume
- (d) Interpolation of all measured values from the measurement grid to the high-resolution grid
- (e) Extrapolation of the entire 3-D field distribution to the phantom surface over the distance from sensor to surface
- (f) Calculation of the averaged SAR within masses of 1g and 10g

8.2 Power Reference Measurement

The Power Reference Measurement and Power Drift Measurements are for monitoring the power drift of the device under test in the batch process. The minimum distance of probe sensors to surface determines the closest measurement point to phantom surface. This distance cannot be smaller than the distance of sensor calibration points to probe tip as defined in the probe properties.

8.3 Area Scan

The area scan is used as a fast scan in two dimensions to find the area of high field values, before doing a fine measurement around the hot spot. The sophisticated interpolation routines implemented in DASY software can find the maximum found in the scanned area, within a range of the global maximum. The range (in dB0 is specified in the standards for compliance testing. For example, a 2 dB range is required in IEEE standard 1528 and IEC 62209 standards, whereby 3 dB is a requirement when compliance is assessed in accordance with the ARIB standard (Japan), if only one zoom scan follows the area scan, then only the absolute maximum will be taken as reference. For cases where multiple maximums are detected, the number of zoom scans has to be increased accordingly.

Area scan parameters extracted from FCC KDB 865664 D01v01r04 SAR measurement 100 MHz to 6 GHz.

	≤ 3 GHz	> 3 GHz
Maximum distance from closest measurement point (geometric center of probe sensors) to phantom surface	5 ± 1 mm	$\frac{1}{2} \cdot \delta \cdot \ln(2) \pm 0.5$ mm
Maximum probe angle from probe axis to phantom surface normal at the measurement location	30° ± 1°	20° ± 1°
Maximum area scan spatial resolution: $\Delta x_{Area}, \Delta y_{Area}$	≤ 2 GHz: ≤ 15 mm 2 – 3 GHz: ≤ 12 mm	3 – 4 GHz: ≤ 12 mm 4 – 6 GHz: ≤ 10 mm
	When the x or y dimension of the test device, in the measurement plane orientation, is smaller than the above, the measurement resolution must be ≤ the corresponding x or y dimension of the test device with at least one measurement point on the test device.	

8.4 Zoom Scan

Zoom scans are used assess the peak spatial SAR values within a cubic averaging volume containing 1 gram and 10 gram of simulated tissue. The zoom scan measures points (refer to table below) within a cube shoes base faces are centered on the maxima found in a preceding area scan job within the same procedure. When the measurement is done, the zoom scan evaluates the averaged SAR for 1 gram and 10 gram and displays these values next to the job's label.

Zoom scan parameters extracted from FCC KDB 865664 D01v01r04 SAR measurement 100 MHz to 6 GHz.

		≤ 3 GHz	> 3 GHz	
Maximum zoom scan spatial resolution: $\Delta x_{Zoom}, \Delta y_{Zoom}$		≤ 2 GHz: ≤ 8 mm 2 – 3 GHz: ≤ 5 mm*	3 – 4 GHz: ≤ 5 mm* 4 – 6 GHz: ≤ 4 mm*	
Maximum zoom scan spatial resolution, normal to phantom surface	uniform grid: $\Delta z_{Zoom}(n)$	≤ 5 mm	3 – 4 GHz: ≤ 4 mm 4 – 5 GHz: ≤ 3 mm 5 – 6 GHz: ≤ 2 mm	
	graded grid	$\Delta z_{Zoom}(1)$: between 1 st two points closest to phantom surface	≤ 4 mm	3 – 4 GHz: ≤ 3 mm 4 – 5 GHz: ≤ 2.5 mm 5 – 6 GHz: ≤ 2 mm
		$\Delta z_{Zoom}(n>1)$: between subsequent points	$\leq 1.5 \cdot \Delta z_{Zoom}(n-1)$	
Minimum zoom scan volume	x, y, z	≥ 30 mm	3 – 4 GHz: ≥ 28 mm 4 – 5 GHz: ≥ 25 mm 5 – 6 GHz: ≥ 22 mm	
Note: δ is the penetration depth of a plane-wave at normal incidence to the tissue medium; see draft standard IEEE P1528-2011 for details. * When zoom scan is required and the <i>reported</i> SAR from the <i>area scan based 1-g SAR estimation</i> procedures of KDB 447498 is ≤ 1.4 W/kg, ≤ 8 mm, ≤ 7 mm and ≤ 5 mm zoom scan resolution may be applied, respectively, for 2 GHz to 3 GHz, 3 GHz to 4 GHz and 4 GHz to 6 GHz.				

8.5 Volume Scan Procedures

The volume scan is used for assess overlapping SAR distributions for antennas transmitting in different frequency bands. It is equivalent to an oversized zoom scan used in standalone measurements. The measurement volume will be used to enclose all the simultaneous transmitting antennas. For antennas transmitting simultaneously in different frequency bands, the volume scan is measured separately in each frequency band. In order to sum correctly to compute the 1g aggregate SAR, the EUT remain in the same test position for all measurements and all volume scan use the same spatial resolution and grid spacing. When all volume scan were completed, the software, SEMCAD postprocessor can combine and subsequently superpose these measurement data to calculating the multiband SAR.

8.6 Power Drift Monitoring

All SAR testing is under the EUT install full charged battery and transmit maximum output power. In DASy measurement software, the power reference measurement and power drift measurement procedures are used for monitoring the power drift of EUT during SAR test. Both these procedures measure the field at a specified reference position before and after the SAR testing. The software will calculate the field difference in dB. If the power drifts more than 5%, the SAR will be retested.



9. Test Equipment List

Manufacturer	Name of Equipment	Type/Model	Serial Number	Calibration	
				Last Cal.	Due Date
SPEAG	835MHz System Validation Kit	D835V2	4d258	2020/5/7	2023/5/6
SPEAG	1750MHz System Validation Kit	D1750V2	1090	2019/3/27	2022/3/25
SPEAG	2450MHz System Validation Kit	D2450V2	908	2019/3/25	2022/3/23
SPEAG	2600MHz System Validation Kit	D2600V2	1061	2020/11/26	2021/11/25
SPEAG	Data Acquisition Electronics	DAE4	1279	2020/8/25	2021/8/24
SPEAG	Dosimetric E-Field Probe	ES3DV3	3279	2020/6/2	2021/6/1
SPEAG	SAM Twin Phantom	SAM Twin	TP-1697	NCR	NCR
SPEAG	Phone Positioner	N/A	N/A	NCR	NCR
Anritsu	Radio Communication Analyzer	MT8821C	6201432831	2021/4/13	2022/4/12
Agilent	ENA Series Network Analyzer	E5071C	MY46106933	2020/8/1	2021/7/31
SPEAG	Dielectric Probe Kit	DAK-3.5	1144	2020/12/2	2021/12/1
Anritsu	Vector Signal Generator	MG3710A	6201682672	2021/1/7	2022/1/6
Rohde & Schwarz	Power Meter	NRVD	102081	2020/8/13	2021/8/12
Rohde & Schwarz	Power Sensor	NRV-Z5	100538	2020/8/13	2021/8/12
Rohde & Schwarz	Power Sensor	NRV-Z5	100539	2020/8/13	2021/8/12
EXA	Spectrum Analyzer	FSV7	101632	2021/1/7	2022/1/6
Testo	Hygrometer	608-H1	1241332088	2021/1/7	2022/1/6
FLUKE	DIGITAC THERMOMETER	51II	97240029	2020/8/14	2021/8/13
BONN	POWER AMPLIFIER	BLMA 0830-3	087193A	Note 1	
BONN	POWER AMPLIFIER	BLMA 2060-2	087193B	Note 1	
Agilent	Dual Directional Coupler	778D	20500	Note 1	
Agilent	Dual Directional Coupler	11691D	MY48151020	Note 1	
ARRA	Power Divider	A3200-2	N/A	Note 1	
MCL	Attenuation1	BW-S10W5+	N/A	Note 1	
MCL	Attenuation2	BW-S10W5+	N/A	Note 1	
MCL	Attenuation3	BW-S10W5+	N/A	Note 1	

Note:

1. Prior to system verification and validation, the path loss from the signal generator to the system check source and the power meter, which includes the amplifier, cable, attenuator and directional coupler, was measured by the network analyzer. The reading of the power meter was offset by the path loss difference between the path to the power meter and the path to the system check source to monitor the actual power level fed to the system check source.
2. Referring to KDB 865664 D01v01r04, the dipole calibration interval can be extended to 3 years with justification. The dipoles are also not physically damaged, or repaired during the interval.
3. The justification data of dipole can be found in appendix C. The return loss is < -20dB, within 20% of prior calibration, the impedance is within 5 ohm of prior calibration.

10. System Verification

10.1 Tissue Simulating Liquids

For the measurement of the field distribution inside the SAM phantom with DASYS, the phantom must be filled with around 25 liters of homogeneous body tissue simulating liquid. For body SAR testing, the liquid height from the center of the flat phantom to the liquid top surface is larger than 15 cm, which is shown in Fig. 11.1.

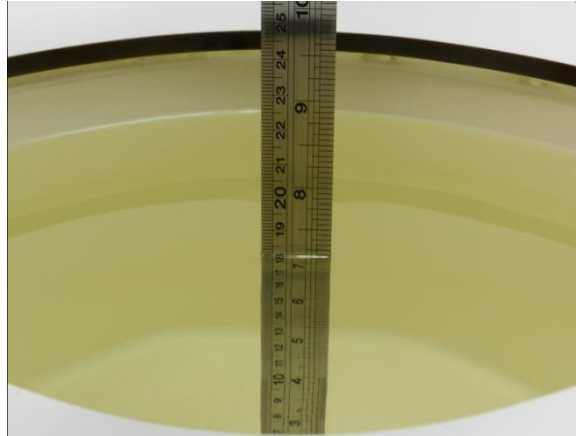

Fig 11.1 Photo of Liquid Height for Body SAR

10.2 Tissue Verification

The following tissue formulations are provided for reference only as some of the parameters have not been thoroughly verified. The composition of ingredients may be modified accordingly to achieve the desired target tissue parameters required for routine SAR evaluation.

Frequency (MHz)	Water (%)	Sugar (%)	Cellulose (%)	Salt (%)	Preventol (%)	DGBE (%)	Conductivity (σ)	Permittivity (ϵ_r)
For Head								
835	40.3	57.9	0.2	1.4	0.2	0	0.90	41.5
1800, 1900, 2000	55.2	0	0	0.3	0	44.5	1.40	40.0
2450	55.0	0	0	0	0	45.0	1.80	39.2
2600	54.8	0	0	0.1	0	45.1	1.96	39.0

<Tissue Dielectric Parameter Check Results>

Frequency (MHz)	Tissue Type	Liquid Temp. (°C)	Conductivity (σ)	Permittivity (ϵ_r)	Conductivity Target (σ)	Permittivity Target (ϵ_r)	Delta (σ) (%)	Delta (ϵ_r) (%)	Limit (%)	Date
835	Head	22.7	0.938	42.434	0.90	41.50	4.22	2.25	±5	2021/5/20
1750	Head	22.6	1.344	39.253	1.37	40.10	-1.90	-2.11	±5	2021/5/22
2450	Head	22.8	1.824	39.156	1.80	39.20	1.33	-0.11	±5	2021/5/23
2600	Head	22.6	2.014	40.602	1.96	39.00	2.76	4.11	±5	2021/5/24

10.3 System Performance Check Results

Comparing to the original SAR value provided by SPEAG, the verification data should be within its specification of 10 %. Below table shows the target SAR and measured SAR after normalized to 1W input power. The table below indicates the system performance check can meet the variation criterion and the plots can be referred to Appendix A of this report.

Date	Frequency (MHz)	Tissue Type	Input Power (mW)	Dipole S/N	Probe S/N	DAE S/N	Measured 1g SAR (W/kg)	Targeted 1g SAR (W/kg)	Normalized 1g SAR (W/kg)	Deviation (%)
2021/5/20	835	Head	50	4d258	3279	1279	0.503	9.44	10.06	6.57
2021/5/22	1750	Head	50	1090	3279	1279	1.840	36.40	36.80	1.10
2021/5/23	2450	Head	50	908	3279	1279	2.740	52.80	54.80	3.79
2021/5/24	2600	Head	50	1061	3279	1279	2.990	56.60	59.80	5.65

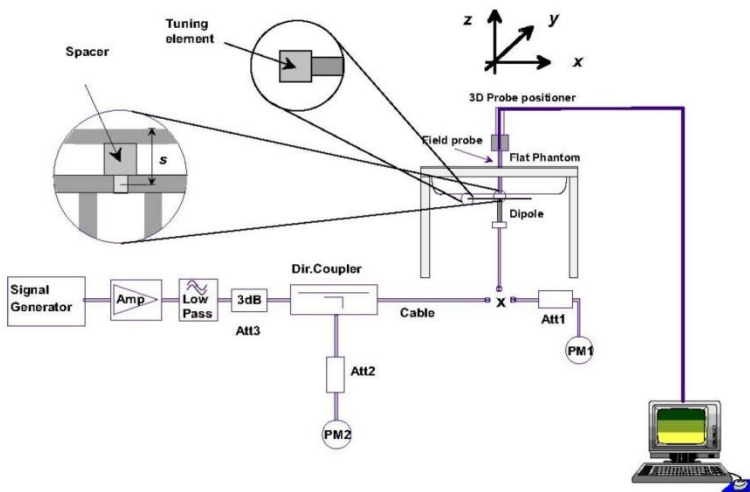

Fig 8.3.1 System Performance Check Setup



Fig 8.3.2 Setup Photo



11. RF Exposure Positions

11.1 Wireless Router

Some battery-operated handsets have the capability to transmit and receive user through simultaneous transmission of WIFI simultaneously with a separate licensed transmitter. The FCC has provided guidance in FCC KDB Publication 941225 D06 v02r01 where SAR test considerations for handsets (L x W \geq 9 cm x 5 cm) are based on a composite test separation distance of 10mm from the front, back and edges of the device containing transmitting antennas within 2.5cm of their edges, determined from general mixed use conditions for this type of devices. Since the hotspot SAR results may overlap with the body-worn accessory SAR requirements, the more conservative configurations can be considered, thus excluding some body-worn accessory SAR tests.

When the user enables the personal wireless router functions for the handset, actual operations include simultaneous transmission of both the WIFI transmitter and another licensed transmitter. Both transmitters often do not transmit at the same transmitting frequency and thus cannot be evaluated for SAR under actual use conditions due to the limitations of the SAR assessment probes. Therefore, SAR must be evaluated for each frequency transmission and mode separately and spatially summed with the WIFI transmitter according to FCC KDB Publication 447498 D01v06 publication procedures. The "Portable Hotspot" feature on the handset was NOT activated during SAR assessments, to ensure the SAR measurements were evaluated for a single transmission frequency RF signal at a time.

<EUT Setup Photos>

Please refer to Appendix D for the test setup photos.

12. UMTS/LTE Output Power (Unit: dBm)

The detailed conducted power table can refer to Appendix E.

<WCDMA Conducted Power>

1. The following tests were conducted according to the test requirements outlines in 3GPP TS 34.121 specification.
2. The procedures in KDB 941225 D01v03r01 are applied for 3GPP Rel. 6 HSPA to configure the device in the required sub-test mode(s) to determine SAR test exclusion.
3. For DC-HSDPA, the device was configured according to the H-Set 12, Fixed Reference Channel (FRC) configuration in Table C.8.1.12 of 3GPP TS 34.121-1, with the primary and the secondary serving HS-DSCH Cell enabled during the power measurement.

A summary of these settings are illustrated below:

HSDPA Setup Configuration:

- a. The EUT was connected to Base Station Agilent E5515C referred to the Setup Configuration.
- b. The RF path losses were compensated into the measurements.
- c. A call was established between EUT and Base Station with following setting:
 - i. Set Gain Factors (β_c and β_d) and parameters were set according to each
 - ii. Specific sub-test in the following table, C10.1.4, quoted from the TS 34.121
 - iii. Set RMC 12.2Kbps + HSDPA mode.
 - iv. Set Cell Power = -86 dBm
 - v. Set HS-DSCH Configuration Type to FRC (H-set 1, QPSK)
 - vi. Select HSDPA Uplink Parameters
 - vii. Set Delta ACK, Delta NACK and Delta CQI = 8
 - viii. Set Ack-Nack Repetition Factor to 3
 - ix. Set CQI Feedback Cycle (k) to 4 ms
 - x. Set CQI Repetition Factor to 2
 - xi. Power Ctrl Mode = All Up bits
- d. The transmitted maximum output power was recorded.

Table C.10.1.4: β values for transmitter characteristics tests with HS-DPCCH

Sub-test	β_c	β_d	β_d (SF)	β_c/β_d	β_{hs} (Note 1, Note 2)	CM (dB) (Note 3)	MPR (dB) (Note 3)
1	2/15	15/15	64	2/15	4/15	0.0	0.0
2	12/15 (Note 4)	15/15 (Note 4)	64	12/15 (Note 4)	24/15	1.0	0.0
3	15/15	8/15	64	15/8	30/15	1.5	0.5
4	15/15	4/15	64	15/4	30/15	1.5	0.5

Note 1: $\Delta_{ACK}, \Delta_{NACK}$ and $\Delta_{CQI} = 30/15$ with $\beta_{hs} = 30/15 * \beta_c$.

Note 2: For the HS-DPCCH power mask requirement test in clause 5.2C, 5.7A, and the Error Vector Magnitude (EVM) with HS-DPCCH test in clause 5.13.1A, and HSDPA EVM with phase discontinuity in clause 5.13.1AA, Δ_{ACK} and $\Delta_{NACK} = 30/15$ with $\beta_{hs} = 30/15 * \beta_c$, and $\Delta_{CQI} = 24/15$ with $\beta_{hs} = 24/15 * \beta_c$.

Note 3: CM = 1 for $\beta_c/\beta_d = 12/15, \beta_{hs}/\beta_c = 24/15$. For all other combinations of DPCCH, DPCH and HS-DPCCH the MPR is based on the relative CM difference. This is applicable for only UEs that support HSDPA in release 6 and later releases.

Note 4: For subtest 2 the β_c/β_d ratio of 12/15 for the TFC during the measurement period (TF1, TF0) is achieved by setting the signalled gain factors for the reference TFC (TF1, TF1) to $\beta_c = 11/15$ and $\beta_d = 15/15$.

Setup Configuration

HSUPA Setup Configuration:

- a. The EUT was connected to Base Station Agilent E5515C referred to the Setup Configuration.
- b. The RF path losses were compensated into the measurements.
- c. A call was established between EUT and Base Station with following setting * :
 - i. Call Configs = 5.2B, 5.9B, 5.10B, and 5.13.2B with QPSK
 - ii. Set the Gain Factors (β_c and β_d) and parameters (AG Index) were set according to each specific sub-test in the following table, C11.1.3, quoted from the TS 34.121
 - iii. Set Cell Power = -86 dBm
 - iv. Set Channel Type = 12.2k + HSPA
 - v. Set UE Target Power
 - vi. Power Ctrl Mode= Alternating bits
 - vii. Set and observe the E-TFCl
 - viii. Confirm that E-TFCl is equal to the target E-TFCl of 75 for sub-test 1, and other subtest's E-TFCl
- d. The transmitted maximum output power was recorded.

Table C.11.1.3: β values for transmitter characteristics tests with HS-DPCCH and E-DCH

Sub-test	β_c	β_d	β_d (SF)	β_c/β_d	β_{HS} (Note1)	β_{ec}	β_{ed} (Note 4) (Note 5)	β_{ed} (SF)	β_{ed} (Codes)	CM (dB) (Note 2)	MPR (dB) (Note 2) (Note 6)	AG Index (Note 5)	E-TFCl
1	11/15 (Note 3)	15/15 (Note 3)	64	11/15 (Note 3)	22/15	209/25	1309/225	4	1	1.0	0.0	20	75
2	6/15	15/15	64	6/15	12/15	12/15	94/75	4	1	3.0	2.0	12	67
3	15/15	9/15	64	15/9	30/15	30/15	$\beta_{ed1}: 47/15$ $\beta_{ed2}: 47/15$	4 4	2	2.0	1.0	15	92
4	2/15	15/15	64	2/15	4/15	2/15	56/75	4	1	3.0	2.0	17	71
5	15/15	0	-	-	5/15	5/15	47/15	4	1	1.0	0.0	12	67

Note 1: For sub-test 1 to 4, Δ_{ACK} , Δ_{NACK} and $\Delta_{CQI} = 30/15$ with $\beta_{hs} = 30/15 * \beta_c$. For sub-test 5, Δ_{ACK} , Δ_{NACK} and $\Delta_{CQI} = 5/15$ with $\beta_{hs} = 5/15 * \beta_c$.

Note 2: CM = 1 for $\beta_c/\beta_d = 12/15$, $\beta_{hs}/\beta_c = 24/15$. For all other combinations of DPDCH, DPCCH, HS-DPCCH, E-DPDCH and E-DPCCH the MPR is based on the relative CM difference.

Note 3: For subtest 1 the β_c/β_d ratio of 11/15 for the TFC during the measurement period (TF1, TF0) is achieved by setting the signalled gain factors for the reference TFC (TF1, TF1) to $\beta_c = 10/15$ and $\beta_d = 15/15$.

Note 4: In case of testing by UE using E-DPDCH Physical Layer category 1, Sub-test 3 is omitted according to TS25.306 Table 5.1g.

Note 5: β_{ed} can not be set directly; it is set by Absolute Grant Value.

Note 6: For subtests 2, 3 and 4, UE may perform E-DPDCH power scaling at max power which could results in slightly smaller MPR values.

Setup Configuration

DC-HSDPA 3GPP release 8 Setup Configuration:

- a. The EUT was connected to Base Station Agilent E5515C referred to the Setup Configuration below
- b. The RF path losses were compensated into the measurements.
- c. A call was established between EUT and Base Station with following setting:
 - i. Set RMC 12.2Kbps + HSDPA mode.
 - ii. Set Cell Power = -25 dBm
 - iii. Set HS-DSCH Configuration Type to FRC (H-set 12, QPSK)
 - iv. Select HSDPA Uplink Parameters
 - v. Set Gain Factors (β_c and β_d) and parameters were set according to each Specific sub-test in the following table, C10.1.4, quoted from the TS 34.121
 - a). Subtest 1: $\beta_c/\beta_d=2/15$
 - b). Subtest 2: $\beta_c/\beta_d=12/15$
 - c). Subtest 3: $\beta_c/\beta_d=15/8$
 - d). Subtest 4: $\beta_c/\beta_d=15/4$
 - vi. Set Delta ACK, Delta NACK and Delta CQI = 8
 - vii. Set Ack-Nack Repetition Factor to 3
 - viii. Set CQI Feedback Cycle (k) to 4 ms
 - ix. Set CQI Repetition Factor to 2
 - x. Power Ctrl Mode = All Up bits
- d. The transmitted maximum output power was recorded.

The following tests were conducted according to the test requirements outlines in 3GPP TS 34.121 specification. A summary of these settings are illustrated below:

C.8.1.12 Fixed Reference Channel Definition H-Set 12

Table C.8.1.12: Fixed Reference Channel H-Set 12

Parameter	Unit	Value
Nominal Avg. Inf. Bit Rate	kbps	60
Inter-TTI Distance	TTI's	1
Number of HARQ Processes	Processes	6
Information Bit Payload (N_{INF})	Bits	120
Number Code Blocks	Blocks	1
Binary Channel Bits Per TTI	Bits	960
Total Available SML's in UE	SML's	19200
Number of SML's per HARQ Proc.	SML's	3200
Coding Rate		0.15
Number of Physical Channel Codes	Codes	1
Modulation		QPSK
Note 1: The RMC is intended to be used for DC-HSDPA mode and both cells shall transmit with identical parameters as listed in the table. Note 2: Maximum number of transmission is limited to 1, i.e., retransmission is not allowed. The redundancy and constellation version 0 shall be used.		

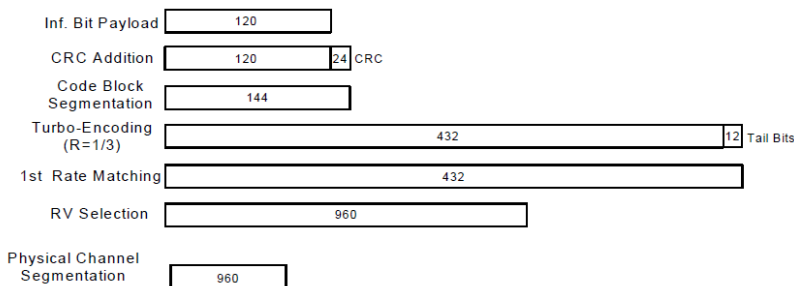

Figure C.8.19: Coding rate for Fixed reference Channel H-Set 12 (QPSK)

Setup Configuration



<WCDMA Conducted Power>

General Note:

1. Per KDB 941225 D01v03r01, for SAR testing is measured using a 12.2 kbps RMC with TPC bits configured to all "1's".
2. Per KDB 941225 D01v03r01, RMC 12.2kbps setting is used to evaluate SAR. The maximum output power and tune-up tolerance specified for production units in HSDPA / HSUPA / DC-HSDPA is $\leq \frac{1}{4}$ dB higher than RMC 12.2Kbps or when the highest reported SAR of the RMC12.2Kbps is scaled by the ratio of specified maximum output power and tune-up tolerance of HSDPA / HSUPA / DC-HSDPA to RMC12.2Kbps and the adjusted SAR is ≤ 1.2 W/kg, SAR measurement is not required for HSDPA / HSUPA / DC-HSDPA, and according to the following RF output power, the output power results of the secondary modes (HSDPA / HSUPA / DC-HSDPA) are less than $\frac{1}{4}$ dB higher than the primary modes; therefore, SAR measurement is not required for HSDPA / HSUPA / DC-HSDPA.



<LTE Conducted Power>

General Note:

1. Anritsu MT8820C base station simulator was used to setup the connection with EUT; the frequency band, channel bandwidth, RB allocation configuration, modulation type are set in the base station simulator to configure EUT transmitting at maximum power and at different configurations which are requested to be reported to FCC, for conducted power measurement and SAR testing.
2. Per KDB 941225 D05v02r05, when a properly configured base station simulator is used for the SAR and power measurements, spectrum plots for each RB allocation and offset configuration is not required.
3. Per KDB 941225 D05v02r05, start with the largest channel bandwidth and measure SAR for QPSK with 1 RB allocation, using the RB offset and required test channel combination with the highest maximum output power for RB offsets at the upper edge, middle and lower edge of each required test channel.
4. Per KDB 941225 D05v02r05, 50% RB allocation for QPSK SAR testing follows 1RB QPSK allocation procedure.
5. Per KDB 941225 D05v02r05, For QPSK with 100% RB allocation, SAR is not required when the highest maximum output power for 100 % RB allocation is less than the highest maximum output power in 50% and 1 RB allocations and the highest reported SAR for 1 RB and 50% RB allocation are ≤ 0.8 W/kg. Otherwise, SAR is measured for the highest output power channel; and if the reported SAR is > 1.45 W/kg, the remaining required test channels must also be tested.
6. Per KDB 941225 D05v02r05, 16QAM output power for each RB allocation configuration is $>$ not $\frac{1}{2}$ dB higher than the same configuration in QPSK and the reported SAR for the QPSK configuration is ≤ 1.45 W/kg; Per KDB 941225 D05v02r05, 16QAM SAR testing is not required.
7. Per KDB 941225 D05v02r05, Smaller bandwidth output power for each RB allocation configuration is $>$ not $\frac{1}{2}$ dB higher than the same configuration in the largest supported bandwidth, and the reported SAR for the largest supported bandwidth is ≤ 1.45 W/kg; Per KDB 941225 D05v02r05, smaller bandwidth SAR testing is not required.
8. For LTE B4 / B5 the maximum bandwidth does not support three non-overlapping channels, per KDB 941225 D05v02r05, when a device supports overlapping channel assignment in a channel bandwidth configuration, the middle channel of the group of overlapping channels should be selected for testing.

13. WiFi Output Power (Unit: dBm)

General Note:

1. Per KDB 248227 D01v02r02, SAR test reduction is determined according to 802.11 transmission mode configurations and certain exposure conditions with multiple test positions. In the 2.4 GHz band, separate SAR procedures are applied to DSSS and OFDM configurations to simplify DSSS test requirements. For OFDM, in both 2.4 and 5 GHz bands, an initial test configuration must be determined for each standalone and aggregated frequency band, according to the transmission mode configuration with the highest maximum output power specified for production units to perform SAR measurements. If the same highest maximum output power applies to different combinations of channel bandwidths, modulations and data rates, additional procedures are applied to determine which test configurations require SAR measurement. When applicable, an initial test position may be applied to reduce the number of SAR measurements required for next to the ear, UMPC mini-tablet or hotspot mode configurations with multiple test positions.
2. For 2.4 GHz 802.11b DSSS, either the initial test position procedure for multiple exposure test positions or the DSSS procedure for fixed exposure position is applied; these are mutually exclusive. For 2.4 GHz and 5 GHz OFDM configurations, the initial test configuration is applied to measure SAR using either the initial test position procedure for multiple exposure test position configurations or the initial test configuration procedures for fixed exposure test conditions. Based on the reported SAR of the measured configurations and maximum output power of the transmission mode configurations that are not included in the initial test configuration, the subsequent test configuration and initial test position procedures are applied to determine if SAR measurements are required for the remaining OFDM transmission configurations. In general, the number of test channels that require SAR measurement is minimized based on maximum output power measured for the test sample(s).
3. For OFDM transmission configurations in the 2.4 GHz and 5 GHz bands, When the same maximum power is specified for multiple transmission modes in a frequency band, the largest channel bandwidth, lowest order modulation, lowest data rate and lowest order 802.11a/g/n/ac mode is used for SAR measurement, on the highest measured output power channel for each frequency band.
4. DSSS and OFDM configurations are considered separately according to the required SAR procedures. SAR is measured in the initial test position using the 802.11 transmission mode configuration required by the DSSS procedure or initial test configuration and subsequent test configuration(s) according to the OFDM procedures.18 The initial test position procedure is described in the following:
 - a. When the reported SAR of the initial test position is ≤ 0.4 W/kg, further SAR measurement is not required for the other test positions in that exposure configuration and 802.11 transmission mode combinations within the frequency band or aggregated band.
 - b. When the reported SAR of the test position is > 0.4 W/kg, SAR is repeated for the 802.11 transmission mode configuration tested in the initial test position to measure the subsequent next closet/smallest test separation distance and maximum coupling test position on the highest maximum output power channel, until the report SAR is ≤ 0.8 W/kg or all required test position are tested.
 - c. For all positions/configurations, when the reported SAR is > 0.8 W/kg, SAR is measured for these test positions/configurations on the subsequent next highest measured output power channel(s) until the reported SAR is ≤ 1.2 W/kg or all required channels are tested.

14. Antenna Location

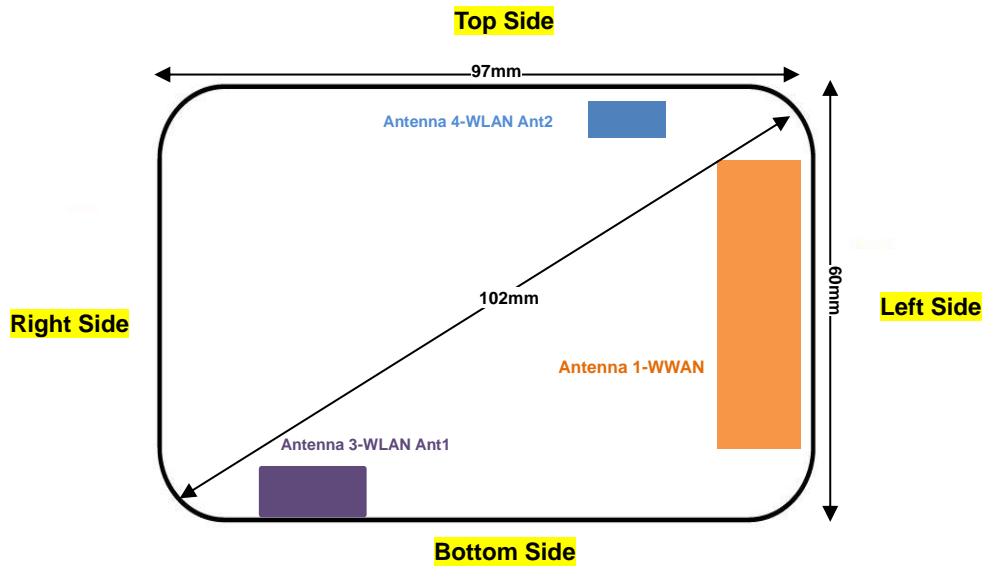

Back View

Distance of the Antenna to the EUT surface/edge						
Antennas	Back	Front	Top Side	Bottom Side	Right Side	Left Side
Antenna 1-WWAN	≤ 25mm	≤ 25mm	≤ 25mm	≤ 25mm	>25mm	≤ 25mm
Antenna 3- WLAN Ant1	≤ 25mm	≤ 25mm	>25mm	≤ 25mm	≤ 25mm	>25mm
Antenna 4- WLAN Ant2	≤ 25mm	≤ 25mm	≤ 25mm	>25mm	>25mm	>25mm

Positions for SAR tests; Hotspot mode						
Antennas	Back	Front	Top Side	Bottom Side	Right Side	Left Side
Antenna 1-WWAN	Yes	Yes	Yes	Yes	No	Yes
Antenna 3- WLAN Ant1	Yes	Yes	No	Yes	Yes	No
Antenna 4- WLAN Ant2	Yes	Yes	Yes	No	No	No

General Note:

- Referring to KDB 941225 D06 v02r01, when the overall device length and width are ≥ 9cm*5cm, the test distance is 10 mm. SAR must be measured for all sides and surfaces with a transmitting antenna located within 25mm from that surface or edge

15. SAR Test Results

General Note:

1. Per KDB 447498 D01v06, the reported SAR is the measured SAR value adjusted for maximum tune-up tolerance.
 - a. Tune-up scaling Factor = tune-up limit power (mW) / EUT RF power (mW), where tune-up limit is the maximum rated power among all production units.
 - b. For SAR testing of WLAN signal with non-100% duty cycle, the measured SAR is scaled-up by the duty cycle scaling factor which is equal to "1/(duty cycle)"
 - c. For WWAN: Reported SAR(W/kg)= Measured SAR(W/kg)*Tune-up Scaling Factor
 - d. For WLAN: Reported SAR(W/kg)= Measured SAR(W/kg)* Duty Cycle scaling factor * Tune-up scaling factor
2. Per KDB 447498 D01v06, for each exposure position, testing of other required channels within the operating mode of a frequency band is not required when the *reported* 1-g or 10-g SAR for the mid-band or highest output power channel is:
 - ≤ 0.8 W/kg or 2.0 W/kg, for 1-g or 10-g respectively, when the transmission band is ≤ 100 MHz
 - ≤ 0.6 W/kg or 1.5 W/kg, for 1-g or 10-g respectively, when the transmission band is between 100 MHz and 200 MHz
 - ≤ 0.4 W/kg or 1.0 W/kg, for 1-g or 10-g respectively, when the transmission band is ≥ 200 MHz
3. Per KDB 865664 D01v01r04, for each frequency band, repeated SAR measurement is required only when the measured SAR is ≥ 0.8 W/kg.

UMTS Note:

1. Per KDB 941225 D01v03r01, for SAR testing is measured using a 12.2 kbps RMC with TPC bits configured to all "1's".
2. Per KDB 941225 D01v03r01, RMC 12.2kbps setting is used to evaluate SAR. The maximum output power and tune-up tolerance specified for production units in HSDPA / HSUPA / DC-HSDPA. is $\leq \frac{1}{4}$ dB higher than RMC 12.2Kbps or when the highest reported SAR of the RMC12.2Kbps is scaled by the ratio of specified maximum output power and tune-up tolerance of HSDPA / HSUPA / DC-HSDPA. to RMC12.2Kbps and the adjusted SAR is ≤ 1.2 W/kg, SAR measurement is not required for HSDPA / HSUPA / DC-HSDPA, and according to the following RF output power, the output power results of the secondary modes (HSUPA, HSDPA, DC-HSDPA.) are less than $\frac{1}{4}$ dB higher than the primary modes; therefore, SAR measurement is not required for HSDPA / HSUPA / DC-HSDPA.

LTE Note:

1. Per KDB 941225 D05v02r05, start with the largest channel bandwidth and measure SAR for QPSK with 1 RB allocation, using the RB offset and required test channel combination with the highest maximum output power for RB offsets at the upper edge, middle and lower edge of each required test channel.
2. Per KDB 941225 D05v02r05, 50% RB allocation for QPSK SAR testing follows 1RB QPSK allocation procedure.
3. Per KDB 941225 D05v02r05, For QPSK with 100% RB allocation, SAR is not required when the highest maximum output power for 100 % RB allocation is less than the highest maximum output power in 50% and 1 RB allocations and the highest reported SAR for 1 RB and 50% RB allocation are ≤ 0.8 W/kg. Otherwise, SAR is measured for the highest output power channel; and if the reported SAR is > 1.45 W/kg, the remaining required test channels must also be tested.
4. Per KDB 941225 D05v02r05, 16QAM output power for each RB allocation configuration is $> \text{not } \frac{1}{2}$ dB higher than the same configuration in QPSK and the reported SAR for the QPSK configuration is ≤ 1.45 W/kg; Per KDB 941225 D05v02r05, 16QAM SAR testing is not required.
5. Per KDB 941225 D05v02r05, Smaller bandwidth output power for each RB allocation configuration is $> \text{not } \frac{1}{2}$ dB higher than the same configuration in the largest supported bandwidth, and the reported SAR for the largest supported bandwidth is ≤ 1.45 W/kg; Per KDB 941225 D05v02r05, smaller bandwidth SAR testing is not required.
6. For LTE B4 / B5 the maximum bandwidth does not support three non-overlapping channels, per KDB 941225 D05v02r05, when a device supports overlapping channel assignment in a channel bandwidth configuration, the middle channel of the group of overlapping channels should be selected for testing.

WLAN Note:

1. Per KDB 248227 D01v02r02, for 2.4GHz 802.11g/n SAR testing is not required when the highest reported SAR for DSSS is adjusted by the ratio of OFDM to DSSS specified maximum output power and the adjusted SAR is ≤ 1.2 W/kg.
2. When the reported SAR of the test position is > 0.4 W/kg, SAR is repeated for the 802.11 transmission mode configuration tested in the initial test position to measure the subsequent next closet/smallest test separation distance and maximum coupling test position on the highest maximum output power channel, until the report SAR is ≤ 0.8 W/kg or all required test position are tested.
3. For all positions / configurations, when the reported SAR is > 0.8 W/kg, SAR is measured for these test positions / configurations on the subsequent next highest measured output power channel(s) until the reported SAR is ≤ 1.2 W/kg or all required channels are tested.
4. During SAR testing the WLAN transmission was verified using a spectrum analyzer.

15.1 Body SAR

<WCDMA SAR>

Plot No.	Band	Mode	Test Position	Gap (mm)	Antenna	Ch.	Freq. (MHz)	Average Power (dBm)	Tune-Up Limit (dBm)	Tune-up Scaling Factor	Power Drift (dB)	Measured 1g SAR (W/kg)	Reported 1g SAR (W/kg)
	WCDMA V	RMC 12.2Kbps	Front	10mm	Ant 1	4182	836.4	22.48	23.00	1.127	0.03	0.900	1.014
01	WCDMA V	RMC 12.2Kbps	Front	10mm	Ant 1	4132	826.4	22.42	23.00	1.143	-0.05	0.945	1.080
	WCDMA V	RMC 12.2Kbps	Front	10mm	Ant 1	4233	846.6	22.35	23.00	1.161	-0.06	0.705	0.819
	WCDMA V	RMC 12.2Kbps	Back	10mm	Ant 1	4182	836.4	22.48	23.00	1.127	0.1	0.744	0.839
	WCDMA V	RMC 12.2Kbps	Back	10mm	Ant 1	4132	826.4	22.42	23.00	1.143	-0.05	0.698	0.798
	WCDMA V	RMC 12.2Kbps	Back	10mm	Ant 1	4233	846.6	22.35	23.00	1.161	-0.06	0.711	0.826
	WCDMA V	RMC 12.2Kbps	Left Side	10mm	Ant 1	4182	836.4	22.48	23.00	1.127	0.01	0.193	0.218
	WCDMA V	RMC 12.2Kbps	Top Side	10mm	Ant 1	4182	836.4	22.48	23.00	1.127	0.08	0.469	0.529
	WCDMA V	RMC 12.2Kbps	Bottom Side	10mm	Ant 1	4182	836.4	22.48	23.00	1.127	-0.09	0.386	0.435



<FDD LTE SAR>

Plot No.	Band	BW (MHz)	Modulation	RB Size	RB offset	Test Position	Gap (mm)	Antenna	Ch.	Freq. (MHz)	Average Power (dBm)	Tune-Up Limit (dBm)	Tune-up Scaling Factor	Power Drift (dB)	Measured 1g SAR (W/kg)	Reported 1g SAR (W/kg)
	LTE Band 4	20M	QPSK	1	0	Front	10mm	Ant 1	20175	1732.5	23.17	24.00	1.211	0.04	0.385	0.466
	LTE Band 4	20M	QPSK	50	0	Front	10mm	Ant 1	20175	1732.5	22.10	23.00	1.230	0.08	0.388	0.477
02	LTE Band 4	20M	QPSK	1	0	Back	10mm	Ant 1	20175	1732.5	23.17	24.00	1.211	-0.04	0.537	0.650
	LTE Band 4	20M	QPSK	50	0	Back	10mm	Ant 1	20175	1732.5	22.10	23.00	1.230	0.02	0.462	0.568
	LTE Band 4	20M	QPSK	1	0	Left Side	10mm	Ant 1	20175	1732.5	23.17	24.00	1.211	-0.05	0.230	0.278
	LTE Band 4	20M	QPSK	50	0	Left Side	10mm	Ant 1	20175	1732.5	22.10	23.00	1.230	0.01	0.193	0.237
	LTE Band 4	20M	QPSK	1	0	Top Side	10mm	Ant 1	20175	1732.5	23.17	24.00	1.211	0.03	0.083	0.100
	LTE Band 4	20M	QPSK	50	0	Top Side	10mm	Ant 1	20175	1732.5	22.10	23.00	1.230	0.05	0.086	0.106
	LTE Band 4	20M	QPSK	1	0	Bottom Side	10mm	Ant 1	20175	1732.5	23.17	24.00	1.211	-0.02	0.172	0.208
	LTE Band 4	20M	QPSK	50	0	Bottom Side	10mm	Ant 1	20175	1732.5	22.10	23.00	1.230	0.05	0.148	0.182
	LTE Band 5	10M	QPSK	1	0	Front	10mm	Ant 1	20525	836.5	21.76	22.50	1.186	0.01	0.752	0.891
	LTE Band 5	10M	QPSK	25	0	Front	10mm	Ant 1	20525	836.5	20.53	21.50	1.250	0.08	0.572	0.715
	LTE Band 5	10M	QPSK	50	0	Front	10mm	Ant 1	20525	836.5	20.58	21.50	1.236	-0.06	0.569	0.703
03	LTE Band 5	10M	QPSK	1	0	Back	10mm	Ant 1	20525	836.5	21.76	22.50	1.186	0.03	0.769	0.911
	LTE Band 5	10M	QPSK	25	0	Back	10mm	Ant 1	20525	836.5	20.53	21.50	1.250	0.14	0.579	0.724
	LTE Band 5	10M	QPSK	50	0	Back	10mm	Ant 1	20525	836.5	20.58	21.50	1.236	0.02	0.571	0.706
	LTE Band 5	10M	QPSK	1	0	Left Side	10mm	Ant 1	20525	836.5	21.76	22.50	1.186	-0.07	0.136	0.162
	LTE Band 5	10M	QPSK	25	0	Left Side	10mm	Ant 1	20525	836.5	20.53	21.50	1.250	0.02	0.104	0.130
	LTE Band 5	10M	QPSK	1	0	Top Side	10mm	Ant 1	20525	836.5	21.76	22.50	1.186	0.17	0.396	0.470
	LTE Band 5	10M	QPSK	25	0	Top Side	10mm	Ant 1	20525	836.5	20.53	21.50	1.250	0.05	0.276	0.345
	LTE Band 5	10M	QPSK	1	0	Bottom Side	10mm	Ant 1	20525	836.5	21.76	22.50	1.186	-0.06	0.322	0.381
	LTE Band 5	10M	QPSK	25	0	Bottom Side	10mm	Ant 1	20525	836.5	20.53	21.50	1.250	-0.09	0.238	0.298
	LTE Band 7	20M	QPSK	1	0	Front	10mm	Ant 1	21100	2535	19.81	20.50	1.172	-0.09	0.850	0.997
	LTE Band 7	20M	QPSK	1	0	Front	10mm	Ant 1	20850	2510	19.67	20.50	1.211	0.02	0.837	1.014
04	LTE Band 7	20M	QPSK	1	0	Front	10mm	Ant 1	21350	2560	19.76	20.50	1.186	-0.04	0.946	1.122
	LTE Band 7	20M	QPSK	50	0	Front	10mm	Ant 1	21100	2535	18.68	19.50	1.208	0.15	0.701	0.846
	LTE Band 7	20M	QPSK	50	0	Front	10mm	Ant 1	20850	2510	18.36	19.50	1.300	-0.01	0.641	0.833
	LTE Band 7	20M	QPSK	50	0	Front	10mm	Ant 1	21350	2560	18.52	19.50	1.253	0.08	0.772	0.967
	LTE Band 7	20M	QPSK	100	0	Front	10mm	Ant 1	21100	2535	18.53	19.50	1.250	0.16	0.701	0.876
	LTE Band 7	20M	QPSK	1	0	Back	10mm	Ant 1	21100	2535	19.81	20.50	1.172	-0.02	0.456	0.535
	LTE Band 7	20M	QPSK	50	0	Back	10mm	Ant 1	21100	2535	18.68	19.50	1.208	0.07	0.370	0.447
	LTE Band 7	20M	QPSK	1	0	Left Side	10mm	Ant 1	21100	2535	19.81	20.50	1.172	-0.14	0.468	0.549
	LTE Band 7	20M	QPSK	50	0	Left Side	10mm	Ant 1	21100	2535	18.68	19.50	1.208	-0.11	0.469	0.567
	LTE Band 7	20M	QPSK	1	0	Top Side	10mm	Ant 1	21100	2535	19.81	20.50	1.172	0.05	0.052	0.061
	LTE Band 7	20M	QPSK	50	0	Top Side	10mm	Ant 1	21100	2535	18.68	19.50	1.208	0.15	0.042	0.051
	LTE Band 7	20M	QPSK	1	0	Bottom Side	10mm	Ant 1	21100	2535	19.81	20.50	1.172	0.11	0.292	0.343
	LTE Band 7	20M	QPSK	50	0	Bottom Side	10mm	Ant 1	21100	2535	18.68	19.50	1.208	-0.06	0.240	0.290



<WLAN 2.4GHz SAR>

Plot No.	Band	Mode	Test Position	Gap (mm)	Antenna	Ch.	Freq. (MHz)	Average Power (dBm)	Tune-Up Limit (dBm)	Tune-up Scaling Factor	Duty Cycle %	Duty Cycle Scaling Factor	Power Drift (dB)	Measured 1g SAR (W/kg)	Reported 1g SAR (W/kg)
05	WLAN2.4GHz	802.11b 1Mbps	Front	10mm	Ant 3	11	2462	14.39	15.00	1.151	100	1.000	-0.02	0.143	0.165
	WLAN2.4GHz	802.11b 1Mbps	Back	10mm	Ant 3	11	2462	14.39	15.00	1.151	100	1.000	0.03	0.093	0.107
	WLAN2.4GHz	802.11b 1Mbps	Right Side	10mm	Ant 3	11	2462	14.39	15.00	1.151	100	1.000	0.01	0.005	0.006
	WLAN2.4GHz	802.11b 1Mbps	Bottom Side	10mm	Ant 3	11	2462	14.39	15.00	1.151	100	1.000	0.03	0.099	0.114
	WLAN2.4GHz	802.11b 1Mbps	Front	10mm	Ant 4	6	2437	14.28	15.00	1.180	100	1.000	-0.05	0.075	0.089
	WLAN2.4GHz	802.11b 1Mbps	Back	10mm	Ant 4	6	2437	14.28	15.00	1.180	100	1.000	-0.02	0.048	0.057
	WLAN2.4GHz	802.11b 1Mbps	Top Side	10mm	Ant 4	6	2437	14.28	15.00	1.180	100	1.000	-0.05	0.087	0.102

15.2 Repeated SAR Measurement

Plot No.	Band	BW (MHz)	Modulation	RB Size	RB offset	Mode	Test Position	Gap (mm)	Antenna	Ch.	Freq. (MHz)	Average Power (dBm)	Tune-Up Limit (dBm)	Tune-up Scaling Factor	Power Drift (dB)	Measured 1g SAR (W/kg)	Ratio	Reported 1g SAR (W/kg)
1st	WCDMA V	-	-	-	-	RMC 12.2Kbps	Front	10mm	Ant 1	4132	826.4	22.42	23.00	1.143	-0.05	0.945	1	1.080
2nd	WCDMA V	-	-	-	-	RMC 12.2Kbps	Front	10mm	Ant 1	4132	826.4	22.42	23.00	1.143	0.01	0.921	1.026	1.053
1st	LTE Band 7	20M	QPSK	1	0	-	Front	10mm	Ant 1	21350	2560	19.76	20.50	1.186	-0.04	0.946	1	1.122
2nd	LTE Band 7	20M	QPSK	1	0	-	Front	10mm	Ant 1	21350	2560	19.76	20.50	1.186	0.07	0.932	1.015	1.105

General Note:

1. Per KDB 865664 D01v01r04, for each frequency band, repeated SAR measurement is required only when the measured SAR is $\geq 0.8W/kg$.
2. Per KDB 865664 D01v01r04, if the ratio among the repeated measurement is ≤ 1.2 and the measured SAR $< 1.45W/kg$, only one repeated measurement is required.
3. The ratio is the difference in percentage between original and repeated *measured* SAR.
4. All measurement SAR result is scaled-up to account for tune-up tolerance and is compliant.

16. Simultaneous Transmission Analysis

No.	Simultaneous Transmission Configurations	Body
1.	WWAN+WLAN Ant 3	Yes
2.	WWAN+ WLAN Ant 3+4	Yes
3.	MIMO WLAN Ant 3+4	Yes

General Note:

1. EUT will choose each WCDMA and LTE according to the network signal condition; therefore, they will not operate simultaneously at any moment.
2. For SAR testing was performed on single antenna RF power in SISO mode is larger or equal to the single antenna RF power in MIMO mode, and for RF exposure assessment of MIMO mode simultaneous transmission exclusion analysis was performed with SAR test results of each antenna in SISO mode.
3. The reported SAR summation is calculated based on the same configuration and test position.
4. According to the EUT character, WLAN Ant 3 and WLAN Ant 4 can transmit simultaneously.
5. According to the EUT character, WWAN and WLAN Ant 4 cannot transmit simultaneously.
6. For simultaneously analysis, since the SAR summation of 3 transmitters can cover others combination of 2 transmitters, therefore in this section did not additional to evaluate 2TX combination of simultaneously transmission.
7. All licensed modes share the same antenna part and cannot transmit simultaneously.
8. Per KDB 447498 D01v06, simultaneous transmission SAR is compliant if,
 - i) Scalar SAR summation < 1.6W/kg.
 - ii) $SPLSR = (SAR1 + SAR2)^{1.5} / (\text{min. separation distance, mm})$, and the peak separation distance is determined from the square root of $[(x1-x2)^2 + (y1-y2)^2 + (z1-z2)^2]$, where (x1, y1, z1) and (x2, y2, z2) are the coordinates of the extrapolated peak SAR locations in the zoom scan.
 - iii) If $SPLSR \leq 0.04$ for 1g SAR, simultaneously transmission SAR measurement is not necessary.
 - iv) Simultaneously transmission SAR measurement, and the reported multi-band 1g SAR < 1.6W/kg.

16.1 Body Exposure Conditions

WWAN Band		Exposure Position	1	2	3	1+2+3
			WWAN	2.4GHz WLAN Ant 3	2.4GHz WLAN Ant 4	Summed
			1g SAR (W/kg)	1g SAR (W/kg)	1g SAR (W/kg)	1g SAR (W/kg)
WCDMA	WCDMA V Ant 1	Front	1.080	0.165	0.089	1.33
		Back	0.839	0.107	0.057	1.00
		Left side	0.218			0.22
		Right side		0.006		0.01
		Top side	0.529		0.102	0.63
		Bottom side	0.435	0.114		0.55
LTE	LTE B4 Ant 1	Front	0.477	0.165	0.089	0.73
		Back	0.650	0.107	0.057	0.81
		Left side	0.278			0.28
		Right side		0.006		0.01
		Top side	0.106		0.102	0.21
		Bottom side	0.208	0.114		0.32
	LTE B5 Ant 1	Front	0.891	0.165	0.089	1.15
		Back	0.911	0.107	0.057	1.08
		Left side	0.162			0.16
		Right side		0.006		0.01
		Top side	0.470		0.102	0.57
		Bottom side	0.381	0.114		0.50
	LTE B7 Ant 1	Front	1.122	0.165	0.089	1.38
		Back	0.535	0.107	0.057	0.70
		Left side	0.567			0.57
		Right side		0.006		0.01
		Top side	0.061		0.102	0.16
		Bottom side	0.343	0.114		0.46

Test Engineer : Nick Hu, Hank Chang, Yuankai Kong



17. Uncertainty Assessment

Per KDB 865664 D01 SAR measurement 100MHz to 6GHz, when the highest measured 1-g SAR within a frequency band is < 1.5 W/kg. The expanded SAR measurement uncertainty must be $\leq 30\%$, for a confidence interval of $k = 2$. If these conditions are met, extensive SAR measurement uncertainty analysis described in IEEE Std 1528-2013 is not required in SAR reports submitted for equipment approval. For this device, the highest measured 1-g SAR is less 1.5W/kg. Therefore, the measurement uncertainty table is not required in this report.



18. References

- [1] FCC 47 CFR Part 2 "Frequency Allocations and Radio Treaty Matters; General Rules and Regulations"
- [2] ANSI/IEEE Std. C95.1-1992, "IEEE Standard for Safety Levels with Respect to Human Exposure to Radio Frequency Electromagnetic Fields, 3 kHz to 300 GHz", September 1992
- [3] IEEE Std. 1528-2013, "IEEE Recommended Practice for Determining the Peak Spatial-Average Specific Absorption Rate (SAR) in the Human Head from Wireless Communications Devices: Measurement Techniques", Sep 2013
- [4] SPEAG DASY System Handbook
- [5] FCC KDB 865664 D01 v01r04, "SAR Measurement Requirements for 100 MHz to 6 GHz", Aug 2015.
- [6] FCC KDB 865664 D02 v01r02, "RF Exposure Compliance Reporting and Documentation Considerations" Oct 2015.
- [7] FCC KDB 447498 D01 v06, "Mobile and Portable Device RF Exposure Procedures and Equipment Authorization Policies", Oct 2015
- [8] FCC KDB 248227 D01 v02r02, "SAR Guidance for IEEE 802.11 (WiFi) Transmitters", Oct 2015.
- [9] FCC KDB 941225 D01 v03r01, "3G SAR MEAUREMENT PROCEDURES", Oct 2015
- [10] FCC KDB 941225 D05 v02r05, "SAR Evaluation Considerations for LTE Devices", Dec 2015
- [11] FCC KDB 941225 D06 v02r01, "SAR Evaluation Procedures for Portable Devices with Wireless Router Capabilities", Oct 2015.

-----THE END-----



Appendix A. Plots of System Performance Check

The plots are shown as follows.

System Check_Head_835MHz

DUT: D835V2 - SN:4d258

Communication System: UID 0, CW (0); Frequency: 835 MHz; Duty Cycle: 1:1

Medium: HSL_835 Medium parameters used: $f = 835 \text{ MHz}$; $\sigma = 0.938 \text{ S/m}$; $\epsilon_r = 42.434$; $\rho = 1000 \text{ kg/m}^3$

Ambient Temperature : 23.2 °C; Liquid Temperature : 22.7 °C

DASY5 Configuration:

- Probe: ES3DV3 - SN3279; ConvF(6.25, 6.25, 6.25) @ 835 MHz; Calibrated: 2020.6.2
- Sensor-Surface: 3mm (Mechanical Surface Detection)
- Electronics: DAE4 Sn1279; Calibrated: 2020.8.25
- Phantom: SAM Twin Phantom; Type: SAM Twin; Serial: TP-1697
- Measurement SW: DASY52, Version 52.10 (4); SEMCAD X Version 14.6.14 (7483)

Pin=50mW/Area Scan (61x61x1): Interpolated grid: $dx=1.500 \text{ mm}$, $dy=1.500 \text{ mm}$
 Maximum value of SAR (interpolated) = 0.677 W/kg

Pin=50mW/Zoom Scan (5x5x7)/Cube 0: Measurement grid: $dx=8\text{mm}$, $dy=8\text{mm}$, $dz=5\text{mm}$
 Reference Value = 27.46 V/m; Power Drift = -0.04 dB
 Peak SAR (extrapolated) = 0.763 W/kg
SAR(1 g) = 0.503 W/kg; SAR(10 g) = 0.336 W/kg.
 Maximum value of SAR (measured) = 0.671 W/kg

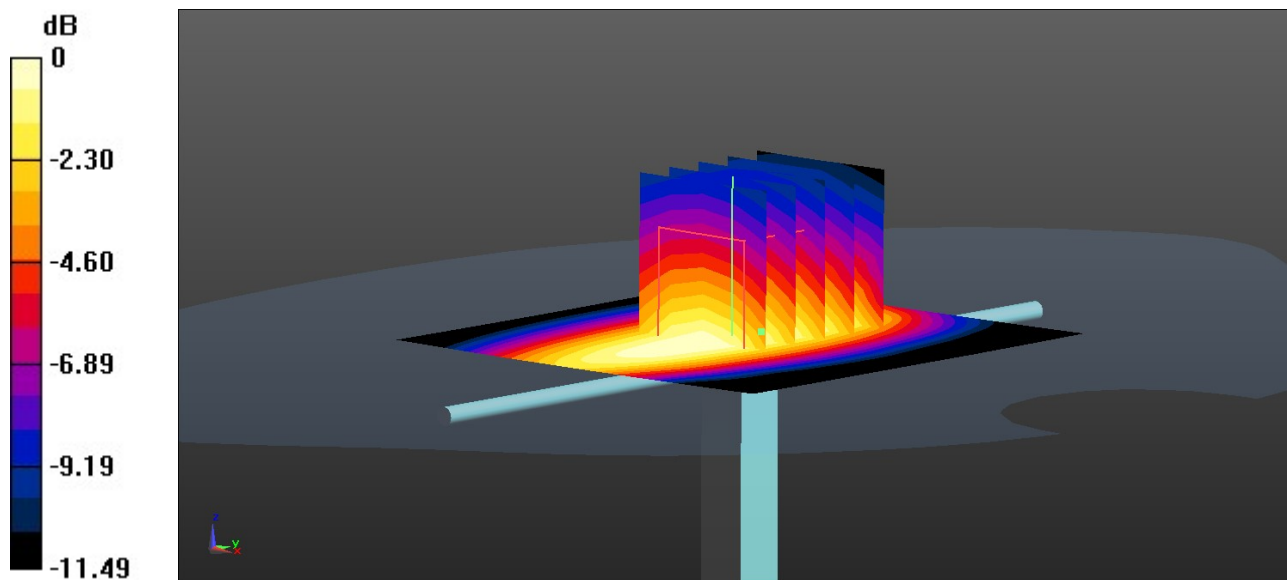

0 dB = 0.671 W/kg = -1.73 dBW/kg

System Check_Head_1750MHz

DUT: D1750V2 - SN:1090

Communication System: UID 0, CW (0); Frequency: 1750 MHz; Duty Cycle: 1:1

Medium: HSL_1750 Medium parameters used: $f = 1750$ MHz; $\sigma = 1.344$ S/m; $\epsilon_r = 39.253$; $\rho = 1000$ kg/m³

Ambient Temperature : 23.1 °C; Liquid Temperature : 22.6 °C

DASY5 Configuration:

- Probe: ES3DV3 - SN3279; ConvF(5.4, 5.4, 5.4) @ 1750 MHz; Calibrated: 2020.6.2
- Sensor-Surface: 3mm (Mechanical Surface Detection)
- Electronics: DAE4 Sn1279; Calibrated: 2020.8.25
- Phantom: SAM Twin Phantom; Type: SAM Twin; Serial: TP-1697
- Measurement SW: DASY52, Version 52.10 (4); SEMCAD X Version 14.6.14 (7483)

Pin=50mW/Area Scan (61x61x1): Interpolated grid: dx=1.500 mm, dy=1.500 mm
Maximum value of SAR (interpolated) = 2.32 W/kg

Pin=50mW/Zoom Scan (5x5x7)/Cube 0: Measurement grid: dx=8mm, dy=8mm, dz=5mm

Reference Value = 42.61 V/m; Power Drift = -0.02 dB

Peak SAR (extrapolated) = 3.24 W/kg

SAR(1 g) = 1.84 W/kg; SAR(10 g) = 0.996 W/kg

Maximum value of SAR (measured) = 2.31 W/kg

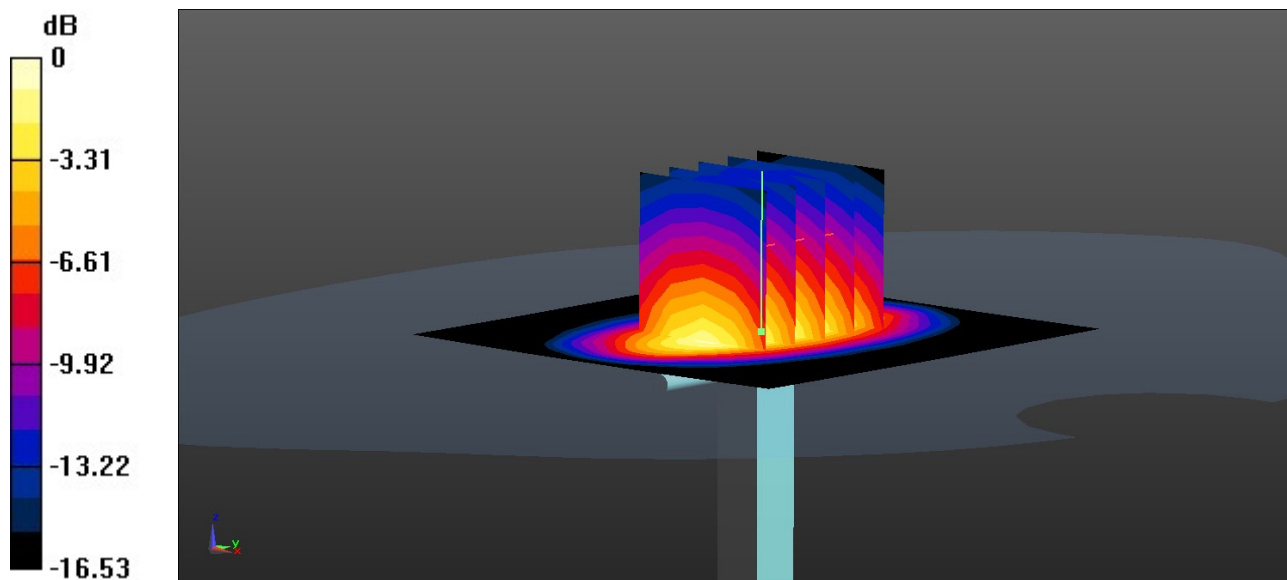

0 dB = 2.31 W/kg = 3.64 dBW/kg

System Check_Head_2450MHz

DUT: D2450V2 - SN:908

Communication System: UID 0, CW (0); Frequency: 2450 MHz; Duty Cycle: 1:1
 Medium: HSL 2450 Medium parameters used: $f = 2450$ MHz; $\sigma = 1.824$ S/m; $\epsilon_r = 39.156$; $\rho = 1000$ kg/m³

Ambient Temperature : 23.2 °C; Liquid Temperature : 22.8 °C

DASY5 Configuration:

- Probe: ES3DV3 - SN3279; ConvF(4.71, 4.71, 4.71) @ 2450 MHz; Calibrated: 2020.6.2
- Sensor-Surface: 3mm (Mechanical Surface Detection)
- Electronics: DAE4 Sn1279; Calibrated: 2020.8.25
- Phantom: SAM Twin Phantom; Type: SAM Twin; Serial: TP-1697
- Measurement SW: DASY52, Version 52.10 (4); SEMCAD X Version 14.6.14 (7483)

Pin=50mW/Area Scan (71x71x1): Interpolated grid: dx=1.200 mm, dy=1.200 mm
 Maximum value of SAR (interpolated) = 3.75 W/kg

Pin=50mW/Zoom Scan (7x7x7)/Cube 0: Measurement grid: dx=5mm, dy=5mm, dz=5mm
 Reference Value = 42.62 V/m; Power Drift = 0.01 dB
 Peak SAR (extrapolated) = 5.43 W/kg
SAR(1 g) = 2.74 W/kg; SAR(10 g) = 1.32 W/kg
 Maximum value of SAR (measured) = 3.59 W/kg

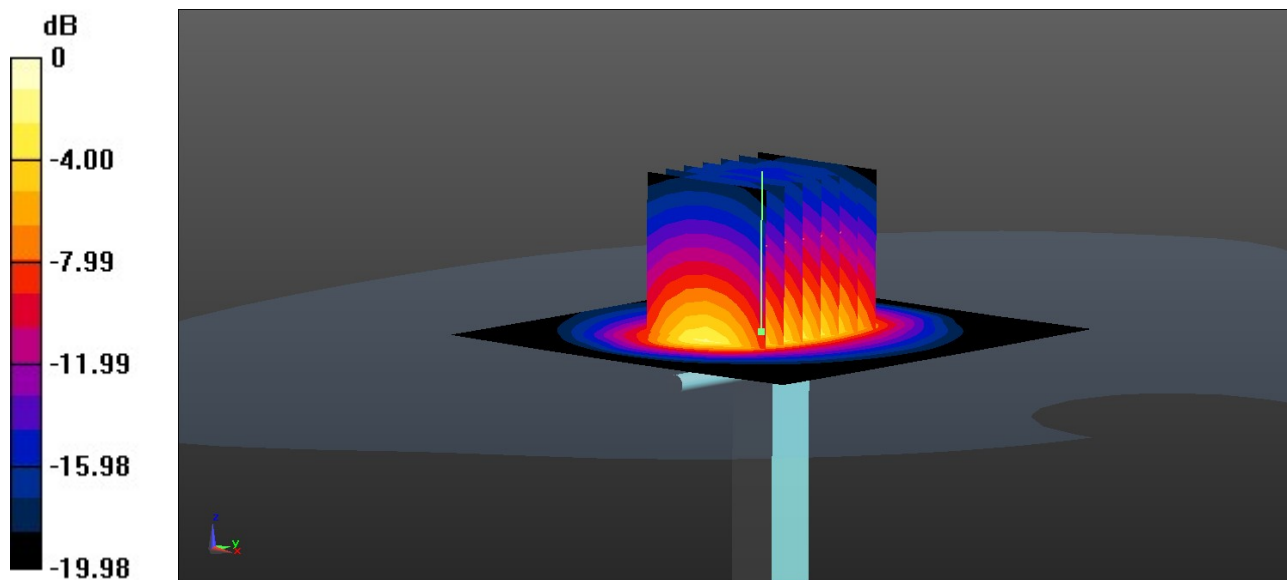

0 dB = 3.59 W/kg = 5.55 dBW/kg

System Check_Head_2600MHz

DUT: D2600V2 - SN:1061

Communication System: UID 0, CW (0); Frequency: 2600 MHz; Duty Cycle: 1:1

Medium: HSL 2600 Medium parameters used: $f = 2600$ MHz; $\sigma = 2.014$ S/m; $\epsilon_r = 40.602$; $\rho = 1000$ kg/m³

Ambient Temperature : 23.3 °C; Liquid Temperature : 22.6 °C

DASY5 Configuration:

- Probe: ES3DV3 - SN3279; ConvF(4.54, 4.54, 4.54) @ 2600 MHz; Calibrated: 2020.6.2
- Sensor-Surface: 3mm (Mechanical Surface Detection)
- Electronics: DAE4 Sn1279; Calibrated: 2020.8.25
- Phantom: SAM Twin Phantom; Type: SAM Twin; Serial: TP-1697
- Measurement SW: DASY52, Version 52.10 (4); SEMCAD X Version 14.6.14 (7483)

Pin=50mW/Area Scan (71x71x1): Interpolated grid: dx=1.200 mm, dy=1.200 mm
Maximum value of SAR (interpolated) = 4.06 W/kg

Pin=50mW/Zoom Scan (7x7x7)/Cube 0: Measurement grid: dx=5mm, dy=5mm, dz=5mm
Reference Value = 45.28 V/m; Power Drift = 0.07 dB
Peak SAR (extrapolated) = 6.16 W/kg
SAR(1 g) = 2.99 W/kg; SAR(10 g) = 1.38 W/kg
Maximum value of SAR (measured) = 3.96 W/kg

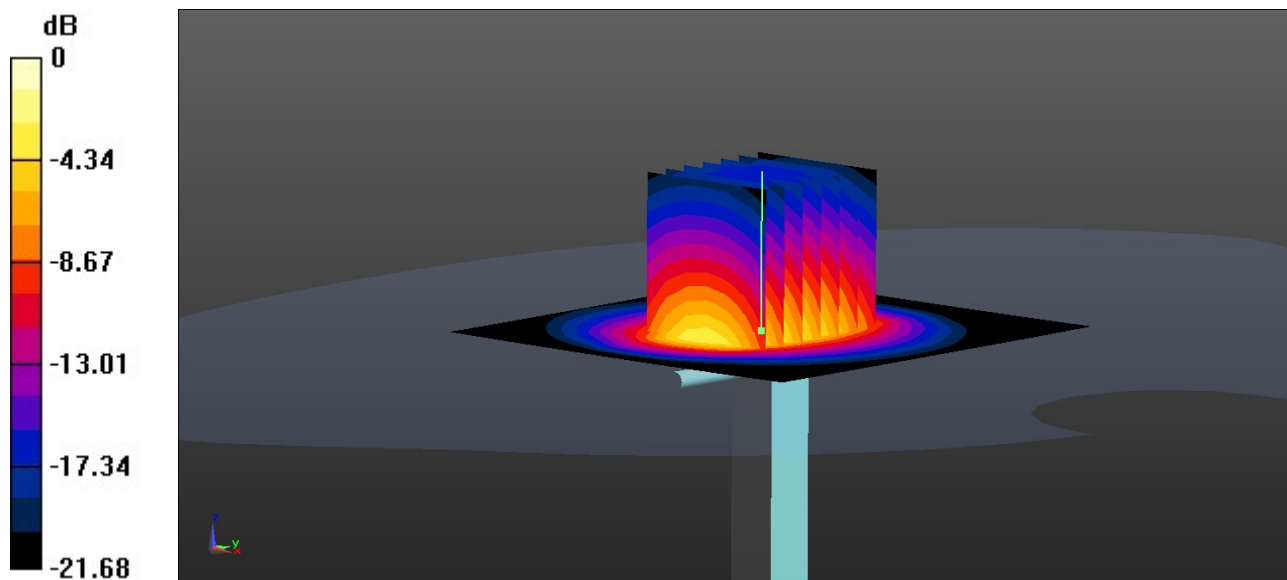

0 dB = 3.96 W/kg = 5.98 dBW/kg



Appendix B. Plots of SAR Measurement

The plots are shown as follows.

01_WCDMA V_RMC 12.2Kbps_Front_10mm_Ch4132

Communication System: UID 0, WCDMA (0); Frequency: 826.4 MHz; Duty Cycle: 1:1
 Medium: HSL_835 Medium parameters used: $f = 826.4$ MHz; $\sigma = 0.934$ S/m; $\epsilon_r = 42.467$; $\rho = 1000$ kg/m³
 Ambient Temperature : 23.2 °C; Liquid Temperature : 22.7 °C

DASY5 Configuration:

- Probe: ES3DV3 - SN3279; ConvF(6.25, 6.25, 6.25) @ 826.4 MHz; Calibrated: 2020.6.2
- Sensor-Surface: 3mm (Mechanical Surface Detection)
- Electronics: DAE4 Sn1279; Calibrated: 2020.8.25
- Phantom: SAM Twin Phantom; Type: SAM Twin; Serial: TP-1697
- Measurement SW: DASY52, Version 52.10 (4); SEMCAD X Version 14.6.14 (7483)

Area Scan (61x101x1): Interpolated grid: dx=1.500 mm, dy=1.500 mm
 Maximum value of SAR (interpolated) = 1.09 W/kg

Zoom Scan (5x5x7)/Cube 0: Measurement grid: dx=8mm, dy=8mm, dz=5mm
 Reference Value = 35.73 V/m; Power Drift = -0.05 dB
 Peak SAR (extrapolated) = 1.28 W/kg
SAR(1 g) = 0.945 W/kg; SAR(10 g) = 0.678 W/kg
 Maximum value of SAR (measured) = 1.06 W/kg

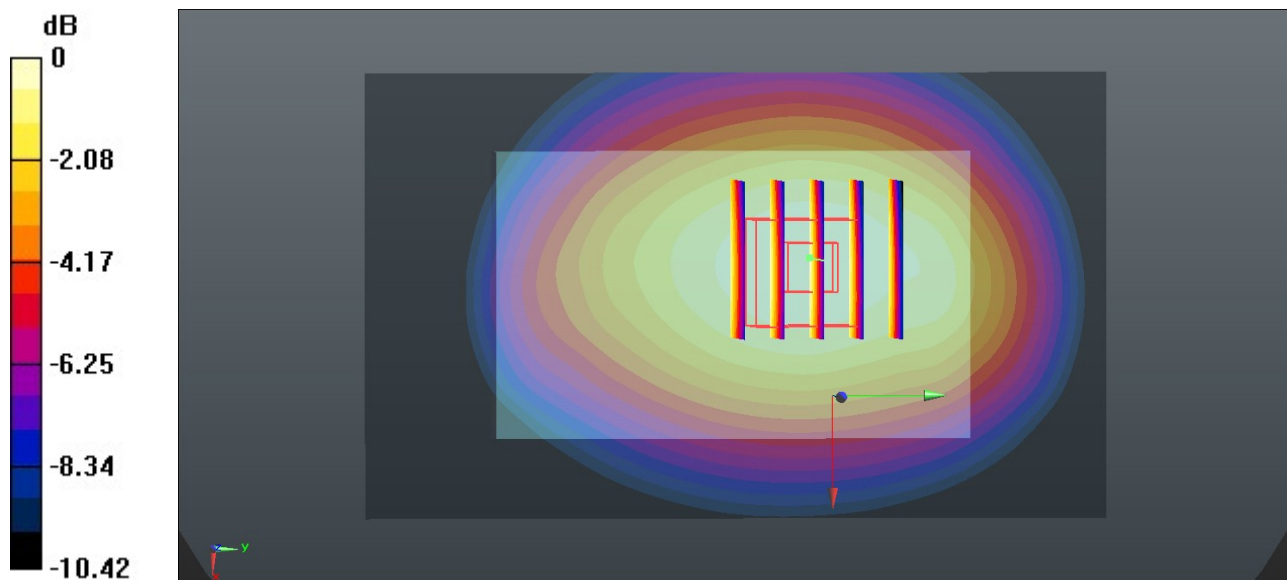

0 dB = 1.06 W/kg = 0.25 dBW/kg

02_LTE Band 4_20M_QPSK_1RB_0Offset_Back_10mm_Ch20175

Communication System: UID 0, LTE-FDD (0); Frequency: 1732.5 MHz; Duty Cycle: 1:1
Medium: HSL_1750 Medium parameters used: $f = 1733$ MHz; $\sigma = 1.335$ S/m; $\epsilon_r = 39.271$; $\rho = 1000$ kg/m³

Ambient Temperature : 23.1 °C; Liquid Temperature : 22.6 °C

DASY5 Configuration:

- Probe: ES3DV3 - SN3279; ConvF(5.4, 5.4, 5.4) @ 1732.5 MHz; Calibrated: 2020.6.2
- Sensor-Surface: 3mm (Mechanical Surface Detection)
- Electronics: DAE4 Sn1279; Calibrated: 2020.8.25
- Phantom: SAM Twin Phantom; Type: SAM Twin; Serial: TP-1697
- Measurement SW: DASY52, Version 52.10 (4); SEMCAD X Version 14.6.14 (7483)

Area Scan (61x101x1): Interpolated grid: dx=1.500 mm, dy=1.500 mm

Maximum value of SAR (interpolated) = 0.624 W/kg

Zoom Scan (5x5x7)/Cube 0: Measurement grid: dx=8mm, dy=8mm, dz=5mm

Reference Value = 22.26 V/m; Power Drift = -0.04 dB

Peak SAR (extrapolated) = 0.761 W/kg

SAR(1 g) = 0.537 W/kg; SAR(10 g) = 0.361 W/kg

Maximum value of SAR (measured) = 0.613 W/kg

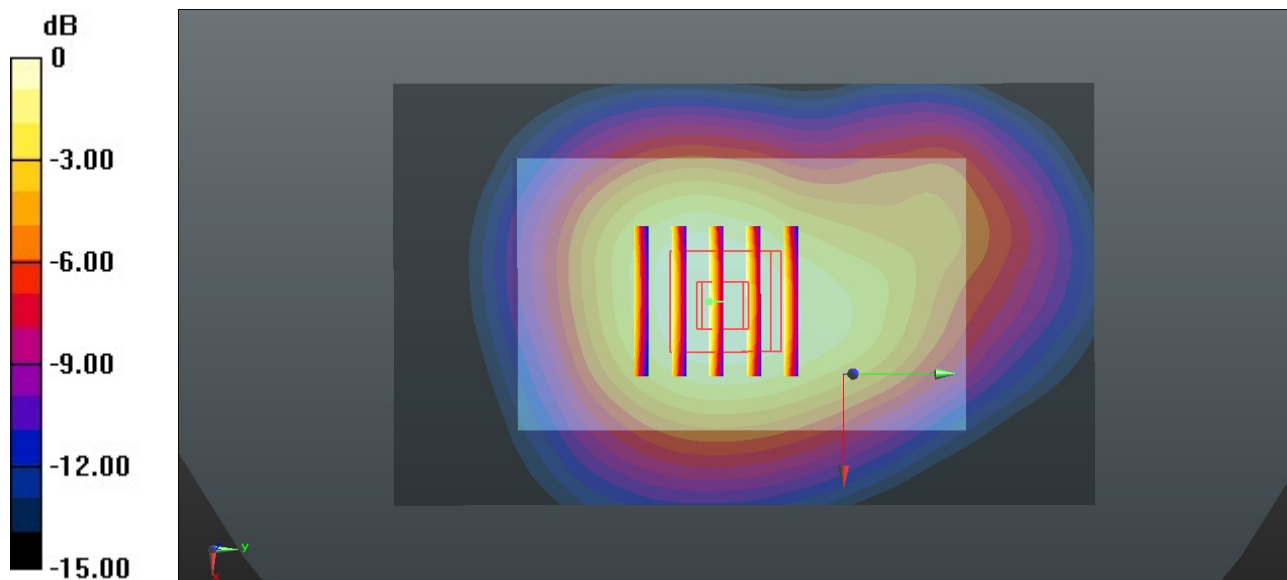

0 dB = 0.613 W/kg = -2.13 dBW/kg

03_LTE Band 5_10M_QPSK_1RB_0Offset_Back_10mm_Ch20525

Communication System: UID 0, LTE-FDD (0); Frequency: 836.5 MHz; Duty Cycle: 1:1
Medium: HSL_835 Medium parameters used: $f = 836.5$ MHz; $\sigma = 0.939$ S/m; $\epsilon_r = 42.444$; $\rho = 1000$ kg/m³

Ambient Temperature : 23.2 °C; Liquid Temperature : 22.7 °C

DASY5 Configuration:

- Probe: ES3DV3 - SN3279; ConvF(6.25, 6.25, 6.25) @ 836.5 MHz; Calibrated: 2020.6.2
- Sensor-Surface: 3mm (Mechanical Surface Detection)
- Electronics: DAE4 Sn1279; Calibrated: 2020.8.25
- Phantom: SAM Twin Phantom; Type: SAM Twin; Serial: TP-1697
- Measurement SW: DASY52, Version 52.10 (4); SEMCAD X Version 14.6.14 (7483)

Area Scan (61x101x1): Interpolated grid: dx=1.500 mm, dy=1.500 mm

Maximum value of SAR (interpolated) = 0.882 W/kg

Zoom Scan (5x5x7)/Cube 0: Measurement grid: dx=8mm, dy=8mm, dz=5mm

Reference Value = 33.96 V/m; Power Drift = 0.03 dB

Peak SAR (extrapolated) = 1.20 W/kg

SAR(1 g) = 0.769 W/kg; SAR(10 g) = 0.543 W/kg

Maximum value of SAR (measured) = 0.872 W/kg

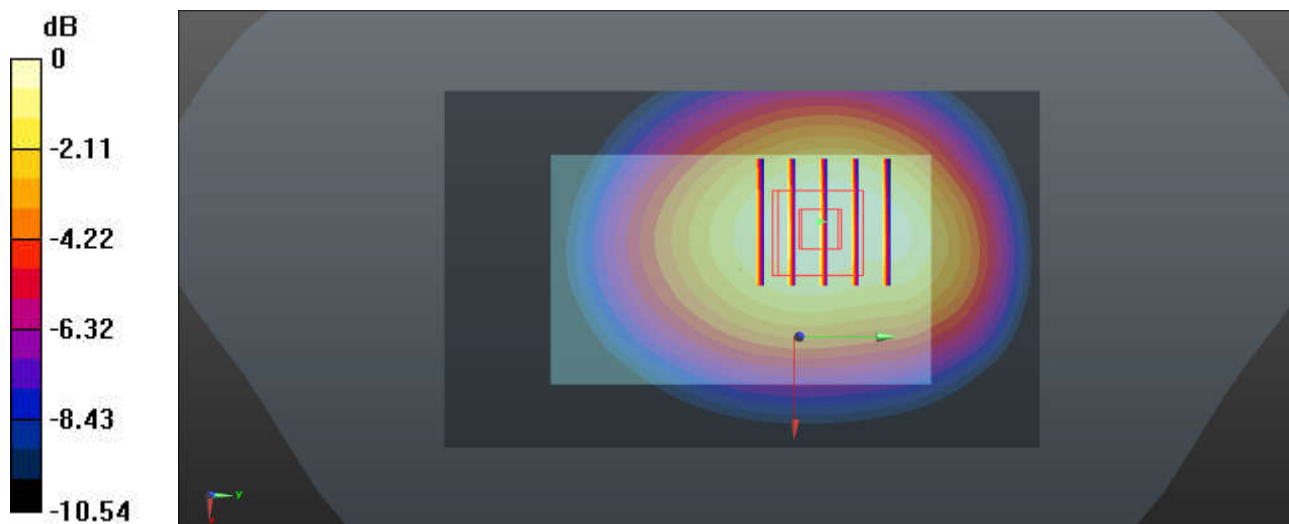

0 dB = 0.872 W/kg = -0.59 dBW/kg

04_LTE Band 7_20M_QPSK_1RB_0Offset_Front_10mm_Ch21350

Communication System: UID 0, LTE-FDD (0); Frequency: 2560 MHz; Duty Cycle: 1:1
 Medium: HSL_2600 Medium parameters used: $f = 2560$ MHz; $\sigma = 1.981$ S/m; $\epsilon_r = 40.664$; $\rho = 1000$ kg/m³
 Ambient Temperature : 23.3 °C; Liquid Temperature : 22.6 °C

DASY5 Configuration:

- Probe: ES3DV3 - SN3279; ConvF(4.54, 4.54, 4.54) @ 2560 MHz; Calibrated: 2020.6.2
- Sensor-Surface: 3mm (Mechanical Surface Detection)
- Electronics: DAE4 Sn1279; Calibrated: 2020.8.25
- Phantom: SAM Twin Phantom; Type: SAM Twin; Serial: TP-1697
- Measurement SW: DASY52, Version 52.10 (4); SEMCAD X Version 14.6.14 (7483)

Area Scan (71x121x1): Interpolated grid: dx=1.200 mm, dy=1.200 mm
 Maximum value of SAR (interpolated) = 1.15 W/kg

Zoom Scan (7x7x7)/Cube 0: Measurement grid: dx=5mm, dy=5mm, dz=5mm
 Reference Value = 24.33 V/m; Power Drift = -0.04 dB
 Peak SAR (extrapolated) = 1.75 W/kg
SAR(1 g) = 0.946 W/kg; SAR(10 g) = 0.501 W/kg
 Maximum value of SAR (measured) = 1.17 W/kg

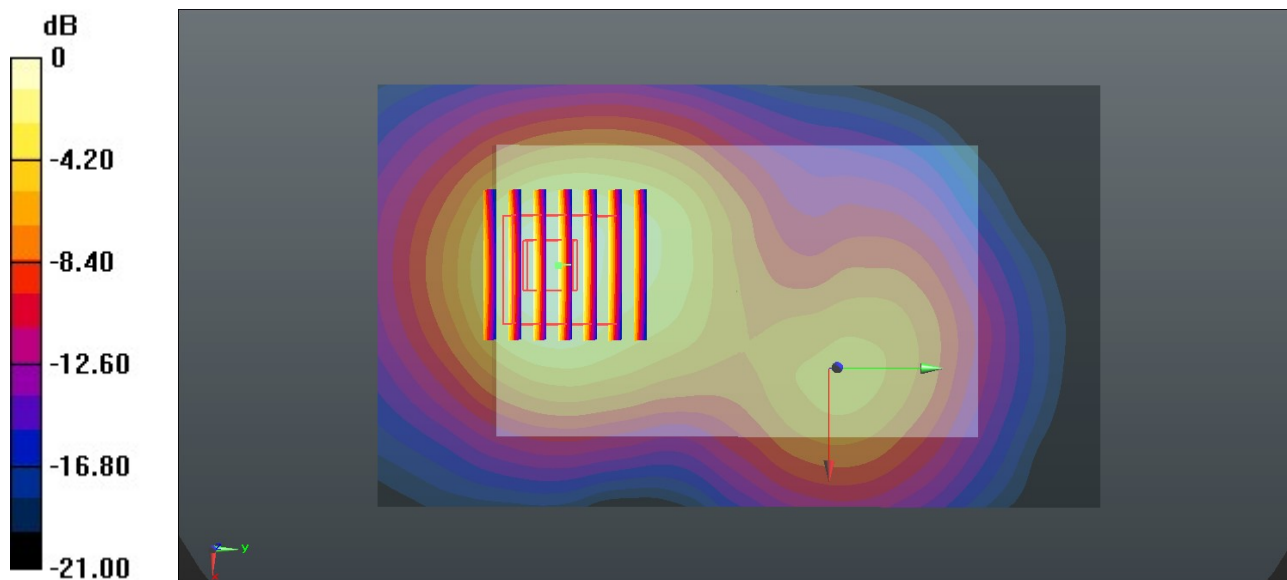

0 dB = 1.17 W/kg = 0.68 dBW/kg

05_WLAN2.4GHz_802.11b 1Mbps_Front_10mm_Ch11

Communication System: UID 0, 802.11b (0); Frequency: 2462 MHz; Duty Cycle: 1:1
 Medium: HSL_2450 Medium parameters used: $f = 2462$ MHz; $\sigma = 1.833$ S/m; $\epsilon_r = 39.139$; $\rho = 1000$ kg/m³
 Ambient Temperature : 23.2 °C; Liquid Temperature : 22.8 °C

- DASY5 Configuration:
- Probe: ES3DV3 - SN3279; ConvF(4.71, 4.71, 4.71) @ 2462 MHz; Calibrated: 2020.6.2
 - Sensor-Surface: 3mm (Mechanical Surface Detection)
 - Electronics: DAE4 Sn1279; Calibrated: 2020.8.25
 - Phantom: SAM Twin Phantom; Type: SAM Twin; Serial: TP-1697
 - Measurement SW: DASY52, Version 52.10 (4); SEMCAD X Version 14.6.14 (7483)

Area Scan (71x111x1): Interpolated grid: dx=1.200 mm, dy=1.200 mm
 Maximum value of SAR (interpolated) = 0.186 W/kg

Zoom Scan (7x7x7)/Cube 0: Measurement grid: dx=5mm, dy=5mm, dz=5mm
 Reference Value = 10.19 V/m; Power Drift = -0.02 dB
 Peak SAR (extrapolated) = 0.243 W/kg
SAR(1 g) = 0.143 W/kg; SAR(10 g) = 0.080 W/kg
 Maximum value of SAR (measured) = 0.175 W/kg

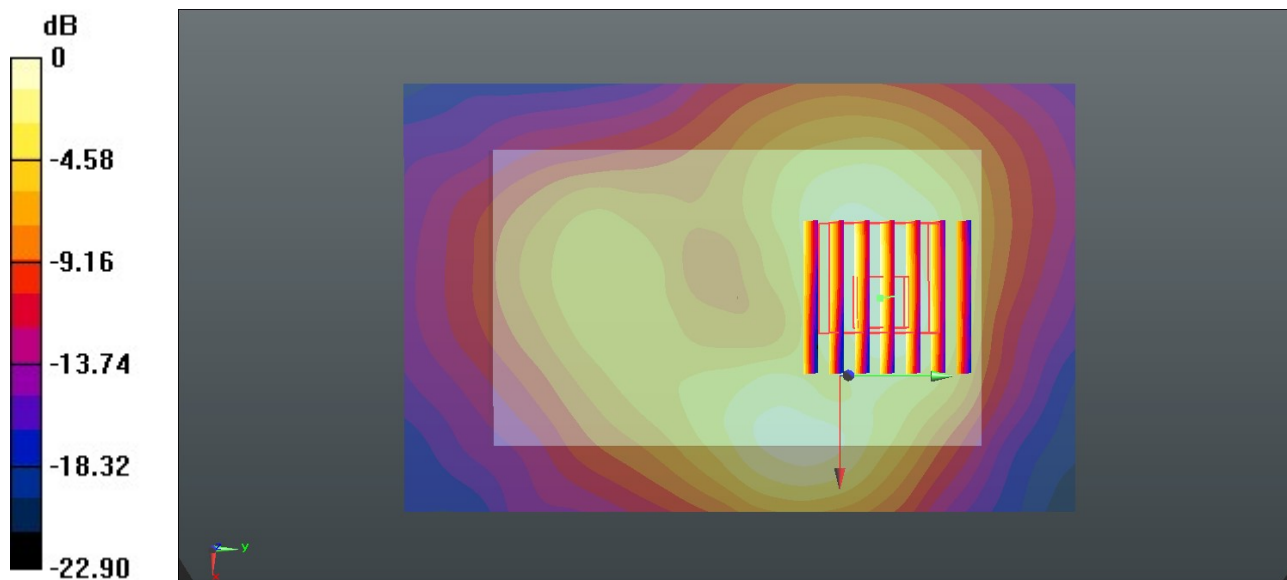

0 dB = 0.175 W/kg = -7.57 dBW/kg



Appendix C. DAS Y Calibration Certificate

The DAS Y calibration certificates are shown as follows.



Accredited by the Swiss Accreditation Service (SAS)
The Swiss Accreditation Service is one of the signatories to the EA
Multilateral Agreement for the recognition of calibration certificates

Accreditation No.: **SCS 0108**

Client **Sporton**

Certificate No: **D835V2-4d258_May20**

CALIBRATION CERTIFICATE

Object: **D835V2 - SN:4d258**

Calibration procedure(s): **QA CAL-05.v11
Calibration Procedure for SAR Validation Sources between 0.7-3 GHz**

Calibration date: **May 07, 2020**

This calibration certificate documents the traceability to national standards, which realize the physical units of measurements (SI).
The measurements and the uncertainties with confidence probability are given on the following pages and are part of the certificate.

All calibrations have been conducted in the closed laboratory facility: environment temperature (22 ± 3)°C and humidity < 70%.

Calibration Equipment used (M&TE critical for calibration)

Primary Standards	ID #	Cal Date (Certificate No.)	Scheduled Calibration
Power meter NRP	SN: 104778	01-Apr-20 (No. 217-03100/03101)	Apr-21
Power sensor NRP-Z91	SN: 103244	01-Apr-20 (No. 217-03100)	Apr-21
Power sensor NRP-Z91	SN: 103245	01-Apr-20 (No. 217-03101)	Apr-21
Reference 20 dB Attenuator	SN: BH9394 (20k)	31-Mar-20 (No. 217-03106)	Apr-21
Type-N mismatch combination	SN: 310982 / 06327	31-Mar-20 (No. 217-03104)	Apr-21
Reference Probe EX3DV4	SN: 7349	31-Dec-19 (No. EX3-7349_Dec19)	Dec-20
DAE4	SN: 601	27-Dec-19 (No. DAE4-601_Dec19)	Dec-20

Secondary Standards	ID #	Check Date (in house)	Scheduled Check
Power meter E4419B	SN: GB39512475	30-Oct-14 (in house check Feb-19)	In house check: Oct-20
Power sensor HP 8481A	SN: US37292783	07-Oct-15 (in house check Oct-18)	In house check: Oct-20
Power sensor HP 8481A	SN: MY41092317	07-Oct-15 (in house check Oct-18)	In house check: Oct-20
RF generator R&S SMT-06	SN: 100972	15-Jun-15 (in house check Oct-18)	In house check: Oct-20
Network Analyzer Agilent E8358A	SN: US41080477	31-Mar-14 (in house check Oct-19)	In house check: Oct-20

Calibrated by:	Name Jeffrey Katzman	Function Laboratory Technician	Signature
Approved by:	Name Katja Pokovic	Function Technical Manager	Signature

Issued: May 7, 2020

This calibration certificate shall not be reproduced except in full without written approval of the laboratory.



Accredited by the Swiss Accreditation Service (SAS)

The Swiss Accreditation Service is one of the signatories to the EA Multilateral Agreement for the recognition of calibration certificates

Accreditation No.: **SCS 0108**

Glossary:

TSL	tissue simulating liquid
ConvF	sensitivity in TSL / NORM x,y,z
N/A	not applicable or not measured

Calibration is Performed According to the Following Standards:

- IEEE Std 1528-2013, "IEEE Recommended Practice for Determining the Peak Spatial-Averaged Specific Absorption Rate (SAR) in the Human Head from Wireless Communications Devices: Measurement Techniques", June 2013
- IEC 62209-1, "Measurement procedure for the assessment of Specific Absorption Rate (SAR) from hand-held and body-mounted devices used next to the ear (frequency range of 300 MHz to 6 GHz)", July 2016
- IEC 62209-2, "Procedure to determine the Specific Absorption Rate (SAR) for wireless communication devices used in close proximity to the human body (frequency range of 30 MHz to 6 GHz)", March 2010
- KDB 865664, "SAR Measurement Requirements for 100 MHz to 6 GHz"

Additional Documentation:

- DASY4/5 System Handbook

Methods Applied and Interpretation of Parameters:

- Measurement Conditions:** Further details are available from the Validation Report at the end of the certificate. All figures stated in the certificate are valid at the frequency indicated.
- Antenna Parameters with TSL:** The dipole is mounted with the spacer to position its feed point exactly below the center marking of the flat phantom section, with the arms oriented parallel to the body axis.
- Feed Point Impedance and Return Loss:** These parameters are measured with the dipole positioned under the liquid filled phantom. The impedance stated is transformed from the measurement at the SMA connector to the feed point. The Return Loss ensures low reflected power. No uncertainty required.
- Electrical Delay:** One-way delay between the SMA connector and the antenna feed point. No uncertainty required.
- SAR measured:** SAR measured at the stated antenna input power.
- SAR normalized:** SAR as measured, normalized to an input power of 1 W at the antenna connector.
- SAR for nominal TSL parameters:** The measured TSL parameters are used to calculate the nominal SAR result.

The reported uncertainty of measurement is stated as the standard uncertainty of measurement multiplied by the coverage factor $k=2$, which for a normal distribution corresponds to a coverage probability of approximately 95%.

Measurement Conditions

DASY system configuration, as far as not given on page 1.

DASY Version	DASY5	V52.10.4
Extrapolation	Advanced Extrapolation	
Phantom	Modular Flat Phantom	
Distance Dipole Center - TSL	15 mm	with Spacer
Zoom Scan Resolution	dx, dy, dz = 5 mm	
Frequency	835 MHz \pm 1 MHz	

Head TSL parameters

The following parameters and calculations were applied.

	Temperature	Permittivity	Conductivity
Nominal Head TSL parameters	22.0 °C	41.5	0.90 mho/m
Measured Head TSL parameters	(22.0 \pm 0.2) °C	42.2 \pm 6 %	0.92 mho/m \pm 6 %
Head TSL temperature change during test	< 0.5 °C	----	----

SAR result with Head TSL

SAR averaged over 1 cm ³ (1 g) of Head TSL	Condition	
SAR measured	250 mW input power	2.39 W/kg
SAR for nominal Head TSL parameters	normalized to 1W	9.44 W/kg \pm 17.0 % (k=2)

SAR averaged over 10 cm ³ (10 g) of Head TSL	condition	
SAR measured	250 mW input power	1.55 W/kg
SAR for nominal Head TSL parameters	normalized to 1W	6.13 W/kg \pm 16.5 % (k=2)

Appendix (Additional assessments outside the scope of SCS 0108)

Antenna Parameters with Head TSL

Impedance, transformed to feed point	51.0 Ω - 2.5 j Ω
Return Loss	- 31.5 dB

General Antenna Parameters and Design

Electrical Delay (one direction)	1.387 ns
----------------------------------	----------

After long term use with 100W radiated power, only a slight warming of the dipole near the feedpoint can be measured.

The dipole is made of standard semirigid coaxial cable. The center conductor of the feeding line is directly connected to the second arm of the dipole. The antenna is therefore short-circuited for DC-signals. On some of the dipoles, small end caps are added to the dipole arms in order to improve matching when loaded according to the position as explained in the "Measurement Conditions" paragraph. The SAR data are not affected by this change. The overall dipole length is still according to the Standard.

No excessive force must be applied to the dipole arms, because they might bend or the soldered connections near the feedpoint may be damaged.

Additional EUT Data

Manufactured by	SPEAG
-----------------	-------

DASY5 Validation Report for Head TSL

Date: 07.05.2020

Test Laboratory: SPEAG, Zurich, Switzerland

DUT: Dipole 835 MHz; Type: D835V2; Serial: D835V2 - SN:4d258

Communication System: UID 0 - CW; Frequency: 835 MHz

Medium parameters used: $f = 835$ MHz; $\sigma = 0.92$ S/m; $\epsilon_r = 42.2$; $\rho = 1000$ kg/m³

Phantom section: Flat Section

Measurement Standard: DASY5 (IEEE/IEC/ANSI C63.19-2011)

DASY52 Configuration:

- Probe: EX3DV4 - SN7349; ConvF(9.89, 9.89, 9.89) @ 835 MHz; Calibrated: 31.12.2019
- Sensor-Surface: 1.4mm (Mechanical Surface Detection)
- Electronics: DAE4 Sn601; Calibrated: 27.12.2019
- Phantom: Flat Phantom 4.9 (front); Type: QD 00L P49 AA; Serial: 1001
- DASY52 52.10.4(1527); SEMCAD X 14.6.14(7483)

Dipole Calibration for Head Tissue/Pin=250 mW, d=15mm/Zoom Scan (7x7x7)/Cube 0:

Measurement grid: dx=5mm, dy=5mm, dz=5mm

Reference Value = 62.60 V/m; Power Drift = 0.04 dB

Peak SAR (extrapolated) = 3.55 W/kg

SAR(1 g) = 2.39 W/kg; SAR(10 g) = 1.55 W/kg

Smallest distance from peaks to all points 3 dB below = 16 mm

Ratio of SAR at M2 to SAR at M1 = 67%

Maximum value of SAR (measured) = 3.16 W/kg

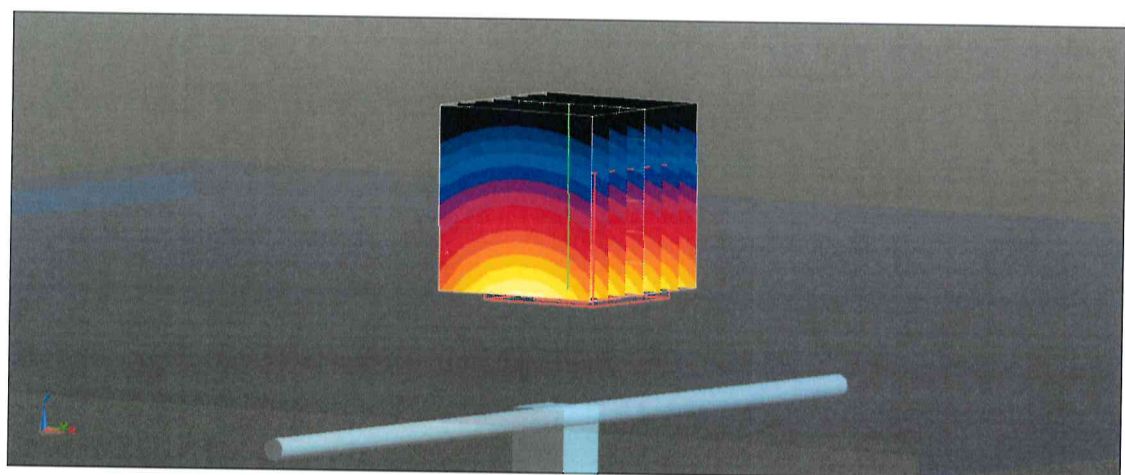
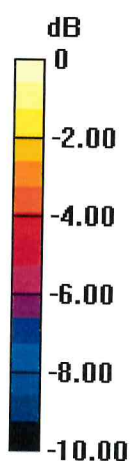

0 dB = 3.16 W/kg = 5.00 dBW/kg