



FCC RF Test Report

APPLICANT : D-Link Corporation
EQUIPMENT : HSPA+ USB Adapter
BRAND NAME : D-Link
MODEL NAME : DWM-157
FCC ID : KA2WM157B1
STANDARD : FCC 47 CFR Part 2, 22(H), 24(E)
CLASSIFICATION : PCS Licensed Transmitter (PCB)

The product was received on Nov. 20, 2012 and completely tested on Dec. 26, 2012. We, SPORTON INTERNATIONAL INC., would like to declare that the tested sample has been evaluated in accordance with the procedures given in ANSI / TIA / EIA-603-C-2004 and shown compliance with the applicable technical standards.

The test results in this report apply exclusively to the tested model / sample. Without written approval of SPORTON INTERNATIONAL INC., the test report shall not be reproduced except in full.

Reviewed by:

Jones Tsai / Manager



SPORTON INTERNATIONAL INC.

No. 52, Hwa Ya 1st Rd., Hwa Ya Technology Park, Kwei-Shan Hsiang, Tao Yuan Hsien, Taiwan, R.O.C.



TABLE OF CONTENTS

REVISION HISTORY..... 3
SUMMARY OF TEST RESULT 4
1 GENERAL DESCRIPTION 5
1.1 Applicant..... 5
1.2 Manufacturer 5
1.3 Feature of Equipment Under Test..... 5
1.4 Product Specification of Equipment Under Test 6
1.5 Maximum ERP/EIRP Power, Frequency Tolerance, and Emission Designator 7
1.6 Testing Site..... 7
1.7 Applied Standards 8
2 TEST CONFIGURATION OF EQUIPMENT UNDER TEST 9
2.1 Test Mode..... 9
2.2 Connection Diagram of Test System 11
2.3 Support Unit used in test configuration and system 11
2.4 Measurement Results Explanation Example 12
3 TEST RESULT 13
3.1 Conducted Output Power Measurement..... 13
3.2 Peak-to-Average Ratio 15
3.3 Effective Radiated Power and Effective Isotropic Radiated Power Measurement 23
3.4 99% Occupied Bandwidth and 26dB Bandwidth Measurement..... 29
3.5 Band Edge Measurement..... 49
3.6 Conducted Spurious Emission Measurement 62
3.7 Field Strength of Spurious Radiation Measurement 78
3.8 Frequency Stability Measurement..... 93
4 LIST OF MEASURING EQUIPMENT 98
5 UNCERTAINTY OF EVALUATION 99
APPENDIX A. PHOTOGRAPHS OF EUT
APPENDIX B. SETUP PHOTOGRAPHS



REVISION HISTORY

REPORT NO.	VERSION	DESCRIPTION	ISSUED DATE
FG2N2009-02	Rev. 01	Initial issue of report	Jan. 09, 2013



SUMMARY OF TEST RESULT

Report Section	FCC Rule	IC Rule	Description	Limit	Result	Remark
3.1	§2.1046	N/A	Conducted Output Power	N/A	PASS	-
3.2	§24.232(d)	RSS-133(6.4)	Peak-to-Average Ratio	< 13 dB	PASS	-
3.3	§22.913(a)(2)	RSS-132(4.4) SRSP-503(5.1.3)	Effective Radiated Power	< 7 Watts	PASS	-
3.3	§24.232(c)	RSS-133 (6.4) SRSP-510(5.1.2)	Equivalent Isotropic Radiated Power	< 2 Watts	PASS	-
3.4	§2.1049 §22.917(a) §24.238(a)	RSS-GEN(4.6.1) RSS-132 (4.5) RSS-133(6.5)	Occupied Bandwidth	N/A	PASS	-
3.5	§2.1051 §22.917(a) §24.238(a)	RSS-132 (4.5.1) RSS-133 (6.5.1)	Band Edge Measurement	< 43+10log ₁₀ (P[Watts])	PASS	-
3.6	§2.1051 §22.917(a) §24.238(a)	RSS-132 (4.5.1) RSS-133 (6.5.1)	Conducted Spurious Emission	< 43+10log ₁₀ (P[Watts])	PASS	-
3.7	§2.1053 §22.917(a) §24.238(a)	RSS-132 (4.5.1) RSS-133 (6.5.1)	Field Strength of Spurious Radiation	< 43+10log ₁₀ (P[Watts])	PASS	Under limit 25.67 dB at 5640.000 MHz
3.8	§2.1055 §22.355 §24.235	RSS-132(4.3) RSS-133(6.3)	Frequency Stability for Temperature & Voltage	< 2.5 ppm	PASS	-



1 General Description

1.1 Applicant

D-Link Corporation

No. 289, Sinhu 3rd Rd., Neihu District, Taipei City 114, Taiwan

1.2 Manufacturer

D-Link Corporation

No. 289, Sinhu 3rd Rd., Neihu District, Taipei City 114, Taiwan

1.3 Feature of Equipment Under Test

Product Feature	
Equipment	HSPA+ USB Adapter
Brand Name	D-Link
Model Name	DWM-157
FCC ID	KA2WM157B1
EUT supports Radios application	GSM/EGPRS/WCDMA/HSPA
HW Version	B1
SW Version	v2.0.0LA2
EUT Stage	Identical Prototype

Remark: The above EUT's information was declared by manufacturer. Please refer to the specifications or user's manual for more detailed description.



1.4 Product Specification of Equipment Under Test

Product Specification subjective to this standard	
Tx Frequency	GSM850: 824.2 MHz ~ 848.8 MHz GSM1900: 1850.2 MHz ~ 1909.8MHz WCDMA Band V: 826.4 MHz ~ 846.6 MHz WCDMA Band II: 1852.4 MHz ~ 1907.6 MHz
Rx Frequency	GSM850: 869.2 MHz ~ 893.8 MHz GSM1900: 1930.2 MHz ~ 1989.8 MHz WCDMA Band V: 871.4 MHz ~ 891.6 MHz WCDMA Band II: 1932.4 MHz ~ 1987.6 MHz
Maximum Output Power to Antenna	GSM850 : 31.50 dBm GSM1900 : 28.29 dBm WCDMA Band V : 21.52 dBm WCDMA Band II : 21.36 dBm
Antenna Type	Fixed Internal Antenna
Antenna Gain	GSM850: -1.0dBi GSM1900: -1.5dBi WCDMA Band V: -1.0dBi WCDMA Band II: -1.5dB
Type of Modulation	GPRS: GMSK EDGE: 8PSK WCDMA: QPSK (Uplink) HSPA : QPSK (Uplink) (Rel. 7 - DL 21Mbps; UL 5.76Mbps)



1.5 Maximum ERP/EIRP Power, Frequency Tolerance, and Emission Designator

FCC Rule	System	Type of Modulation	Maximum ERP/EIRP (W)	Frequency Tolerance (% , Hz, ppm)	Emission Designator
Part 22	GSM850 GPRS 8	GMSK	0.1879	0.04 ppm	250KGXW
Part 22	GSM850 EDGE 8	GMSK / 8PSK	0.1567	0.05 ppm	246KG7W
Part 22	WCDMA Band V RMC 12.2Kbps	QPSK	0.0195	0.03 ppm	4M22F9W
Part 24	GSM1900 GPRS 8	GMSK	0.1089	0.02 ppm	246KGXW
Part 24	GSM1900 EDGE 8	GMSK / 8PSK	0.0753	0.03 ppm	250KG7W
Part 24	WCDMA Band II RMC 12.2Kbps	QPSK	0.0226	0.01 ppm	4M20F9W

1.6 Testing Site

Test Site	SPORTON INTERNATIONAL INC.		
Test Site Location	No. 52, Hwa Ya 1 st Rd., Hwa Ya Technology Park, Kwei-Shan Hsiang, Tao Yuan Hsien, Taiwan, R.O.C. TEL: +886-3-327-3456 FAX: +886-3-328-4978		
Test Site No.	Sporton Site No.		FCC/IC Registration No.
	TH02-HY	03CH07-HY	722060/4086B-1



1.7 Applied Standards

According to the specifications of the manufacturer, the EUT must comply with the requirements of the following standards:

- ♦ Preliminary Guidance for Receiving Applications for Certification of 3G Device. May 9, 2006.
- ♦ FCC 47 CFR Part 2, 22(H), 24(E)
- ♦ ANSI / TIA / EIA-603-C-2004
- ♦ FCC KDB 971168 D01 Power Meas. License Digital Systems v01

Remark:

1. All test items were verified and recorded according to the standards and without any deviation during the test.
2. This EUT has also been tested and complied with the requirements of FCC Part 15, Subpart B, recorded in a separate test report.

2 Test Configuration of Equipment Under Test

2.1 Test Mode

During all testing, EUT is in link mode with base station emulator at maximum power level. The spurious emission measurements were carried out in semi-anechoic chamber with 3-meter test range.

Frequency range investigated for radiated emission is as follows:

1. 30 MHz to 9000 MHz for GSM850 and WCDMA Band V.
2. 30 MHz to 19000 MHz for GSM1900 and WCDMA Band II.

Test Modes		
Band	Radiated TCs	Conducted TCs
GSM 850	<ul style="list-style-type: none"> ■ GPRS 8 Link ■ EDGE 8 Link 	<ul style="list-style-type: none"> ■ GPRS 8 Link ■ EDGE 8 Link
GSM 1900	<ul style="list-style-type: none"> ■ GPRS 8 Link ■ EDGE 8 Link 	<ul style="list-style-type: none"> ■ GPRS 8 Link ■ EDGE 8 Link
WCDMA Band V	<ul style="list-style-type: none"> ■ RMC 12.2Kbps Link 	<ul style="list-style-type: none"> ■ RMC 12.2Kbps Link
WCDMA Band II	<ul style="list-style-type: none"> ■ RMC 12.2Kbps Link 	<ul style="list-style-type: none"> ■ RMC 12.2Kbps Link

Note: The maximum power levels are GPRS multi-slot class 8 mode for GMSK link, EDGE multi-slot class 8 mode for 8PSK link, RMC 12.2Kbps mode for WCDMA band V, and RMC 12.2Kbps mode for WCDMA band II, only these modes were used for all tests.



The conducted power tables are as follows:

Conducted Power (*Unit: dBm)						
Band	GSM850			GSM1900		
Channel	128	189	251	512	661	810
Frequency	824.2	836.4	848.8	1850.2	1880.0	1909.8
GPRS 8	31.27	31.50	31.33	28.29	28.24	28.15
GPRS 10	30.76	31.00	30.82	27.86	27.81	27.71
GPRS 12	28.75	28.97	28.84	25.99	25.88	25.78
EGPRS 8	28.34	28.64	28.50	26.43	26.35	26.27
EGPRS 10	27.01	27.51	27.37	25.39	25.30	25.26
EGPRS 12	23.41	23.66	23.55	22.07	22.07	22.02

Conducted Power (*Unit: dBm)						
Band	WCDMA Band V			WCDMA Band II		
Channel	4132	4182	4233	9262	9400	9538
Frequency	826.4	836.4	846.6	1852.4	1880.0	1907.6
RMC 12.2K	21.52	21.49	21.38	21.36	21.16	21.15
HSDPA Subtest-1	20.51	20.45	20.31	20.31	20.18	20.16
HSDPA Subtest-2	20.49	20.44	20.31	20.30	20.12	20.09
HSDPA Subtest-3	20.09	20.02	19.87	19.79	19.68	19.66
HSDPA Subtest-4	19.99	19.92	19.85	19.74	19.65	19.63
DC-HSDPA Subtest-1	20.45	20.42	20.30	20.27	20.10	20.06
DC-HSDPA Subtest-2	20.39	20.38	20.28	20.24	20.07	20.03
DC-HSDPA Subtest-3	20.10	20.00	19.83	19.73	19.56	19.55
DC-HSDPA Subtest-4	19.98	19.91	19.82	19.70	19.51	19.49
HSUPA Subtest-1	20.06	20.01	19.91	19.88	19.74	19.70
HSUPA Subtest-2	18.55	18.52	18.43	18.41	18.27	18.25
HSUPA Subtest-3	19.62	19.56	19.43	19.46	19.33	19.29
HSUPA Subtest-4	18.22	18.18	18.15	18.02	17.91	17.88
HSUPA Subtest-5	20.69	20.63	20.45	20.40	20.26	20.22
HSPA+ (16QAM) Subtest-1	20.50	20.46	20.39	20.28	20.13	20.10

2.2 Connection Diagram of Test System

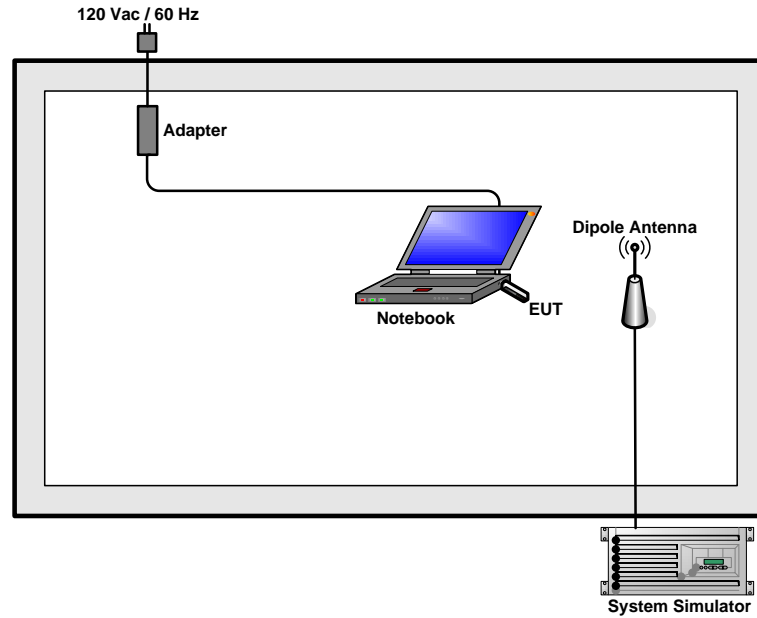

2.3 Support Unit used in test configuration and system

Item	Equipment	Trade Name	Model No.	FCC ID	Data Cable	Power Cord
1.	System Simulator	R&S	CMU 200	N/A	N/A	Unshielded, 1.8 m
2.	Notebook	DELL	Latitude E6320	FCC DoC	N/A	AC I/P: Unshielded, 1.2 m DC O/P: Shielded, 1.8 m



2.4 Measurement Results Explanation Example

For all conducted test items:

The offset level is set in the spectrum analyzer to compensate the RF cable loss and attenuator factor between EUT conducted output port and spectrum analyzer. With the offset compensation, the spectrum analyzer reading level is exactly the EUT RF output level.

The spectrum analyzer offset is derived from RF cable loss and attenuator factor.

Offset = RF cable loss + attenuator factor.

Following shows an offset computation example with cable loss 4.2 dB and 10dB attenuator.

Example :

$$\begin{aligned} \text{Offset(dB)} &= \text{RF cable loss(dB)} + \text{attenuator factor(dB)}. \\ &= 4.2 + 10 = 14.2 \text{ (dB)} \end{aligned}$$

3 Test Result

3.1 Conducted Output Power Measurement

3.1.1 Description of the Conducted Output Power Measurement

A base station simulator was used to establish communication with the EUT. Its parameters were set to transmit the maximum power on the EUT. The measured power in the radio frequency on the transmitter output terminals shall be reported.

3.1.2 Measuring Instruments

See list of measuring instruments of this test report.

3.1.3 Test Procedures

1. The transmitter output port was connected to base station.
2. The RF output of EUT was connected to the spectrum analyzer by RF cable and attenuator. The path loss was compensated to the results for each measurement.
3. Set EUT at maximum power through base station.
4. Select lowest, middle, and highest channels for each band and different modulation.
5. Measure the maximum burst average power for GSM and maximum average power for other modulation signal.

3.1.4 Test Setup



3.1.5 Test Result of Conducted Output Power

Cellular Band									
Modes	GSM850 (GPRS 8)			GSM850 (EDGE 8)			WCDMA Band V (RMC 12.2Kbps)		
Channel	128 (Low)	189 (Mid)	251 (High)	128 (Low)	189 (Mid)	251 (High)	4132 (Low)	4182 (Mid)	4233 (High)
Frequency (MHz)	824.2	836.4	848.8	824.2	836.4	848.8	826.4	836.4	846.6
Conducted Power (dBm)	31.27	31.50	31.33	28.34	28.64	28.50	21.52	21.49	21.38
Conducted Power (Watts)	1.3397	1.4125	1.3583	0.6823	0.7311	0.7079	0.1419	0.1409	0.1374

PCS Band									
Modes	GSM1900 (GPRS 8)			GSM1900 (EDGE 8)			WCDMA Band II (RMC 12.2Kbps)		
Channel	512 (Low)	661 (Mid)	810 (High)	512 (Low)	661 (Mid)	810 (High)	9262 (Low)	9400 (Mid)	9538 (High)
Frequency (MHz)	1850.2	1880	1909.8	1850.2	1880	1909.8	1852.4	1880	1907.6
Conducted Power (dBm)	28.29	28.24	28.15	26.43	26.35	26.27	21.36	21.16	21.15
Conducted Power (Watts)	0.6745	0.6668	0.6531	0.4395	0.4315	0.4236	0.1368	0.1306	0.1303

Note: maximum burst average power for GSM, and maximum average power for WCDMA.

3.2 Peak-to-Average Ratio

3.2.1 Description of the PAR Measurement

The peak-to-average ratio (PAR) of the transmission may not exceed 13 dB.

3.2.2 Measuring Instruments

See list of measuring instruments of this test report.

3.2.3 Test Procedures

1. The EUT was connected to Spectrum Analyzer and Base Station via power divider.
2. The RF output of EUT was connected to the spectrum analyzer by RF cable and attenuator. The path loss was compensated to the results for each measurement.
3. For GSM/EGPRS operating modes:
 - a. Set the RBW = 1MHz, VBW = 1MHz, Peak detector in spectrum analyzer.
 - b. Set EUT in maximum power output, and triggered the burst signal.
 - c. Measured respectively the Peak level and Mean level, and the deviation was recorded as Peak to Average Ratio.
4. For UMTS operating modes:
 - a. Set the CCDF (Complementary Cumulative Distribution Function) option in spectrum analyzer.
 - b. The highest RF powers were measured and recorded the maximum PAPR level associated with a probability of 0.1 %.

3.2.4 Test Setup

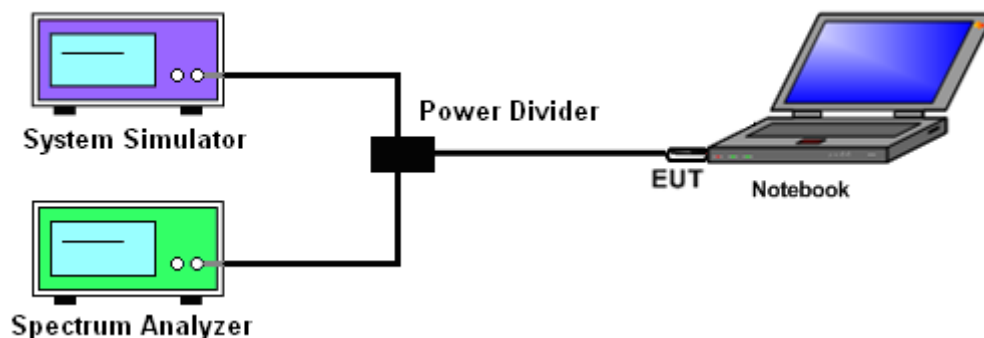



3.2.5 Test Result of Peak-to-Average Ratio

PCS Band									
Modes	GSM1900 (GPRS 8)			GSM1900 (EDGE 8)			WCDMA Band II (RMC 12.2Kbps)		
Channel	512 (Low)	661 (Mid)	810 (High)	512 (Low)	661 (Mid)	810 (High)	9262 (Low)	9400 (Mid)	9538 (High)
Frequency (MHz)	1850.2	1880	1909.8	1850.2	1880	1909.8	1852.4	1880	1907.6
Peak-to-Average Ratio (dB)	0.09	0.08	0.10	0.47	0.40	0.52	3.28	3.32	3.32



3.2.6 Test Result (Plots) of Peak-to-Average Ratio

Band :	GSM 1900	Test Mode :	GPRS 8 Link
--------	----------	-------------	-------------

Peak-to-Average Ratio on Channel 512 (1850.2 MHz)

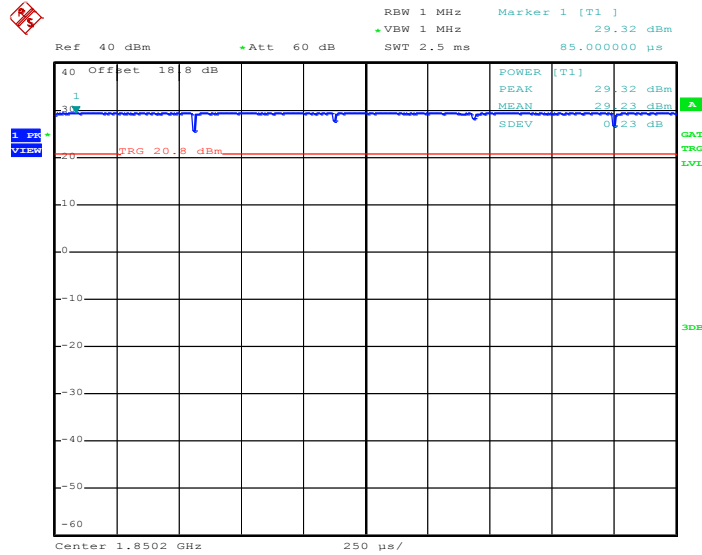

Date: 19.DEC.2012 04:24:57

Peak-to-Average Ratio on Channel 661 (1880.0 MHz)

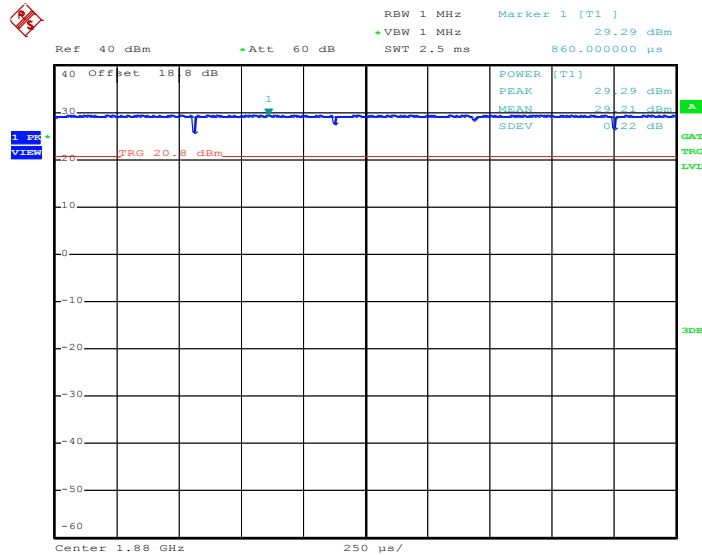

Date: 19.DEC.2012 04:24:23



Peak-to-Average Ratio on Channel 810 (1909.8 MHz)

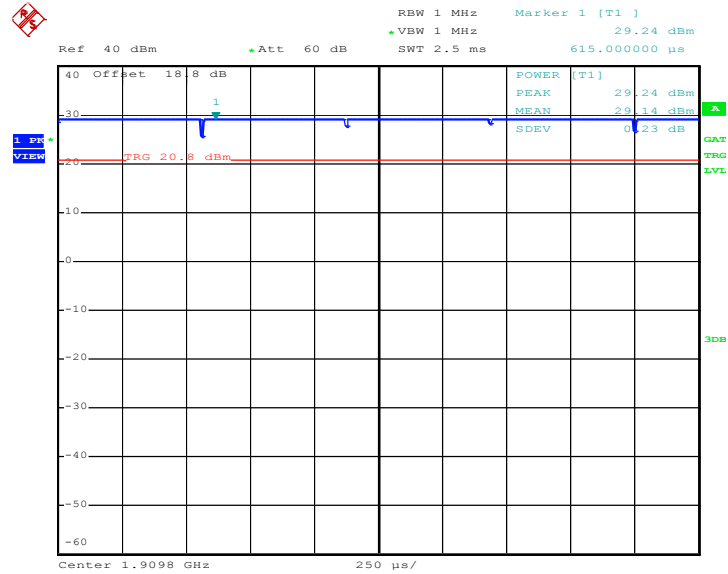

Date: 19.DEC.2012 04:25:37



Band :	GSM 1900	Test Mode :	EDGE 8 Link
---------------	----------	--------------------	-------------

Peak-to-Average Ratio on Channel 512 (1850.2 MHz)

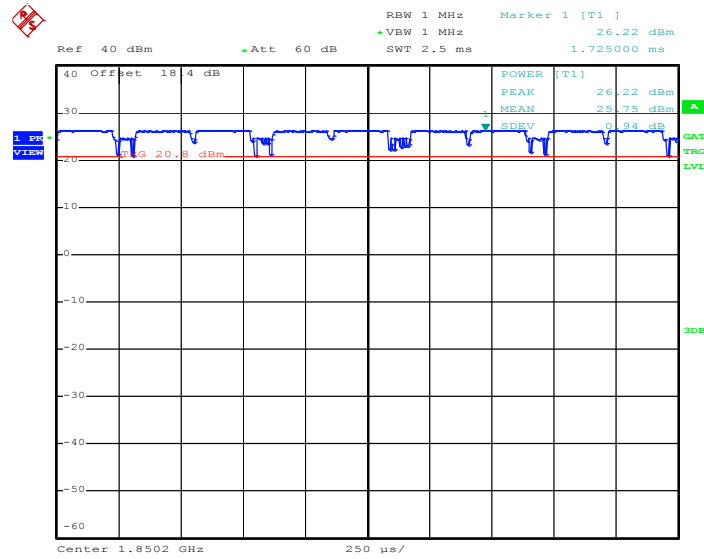

Date: 19.DEC.2012 03:56:48

Peak-to-Average Ratio on Channel 661 (1880.0 MHz)

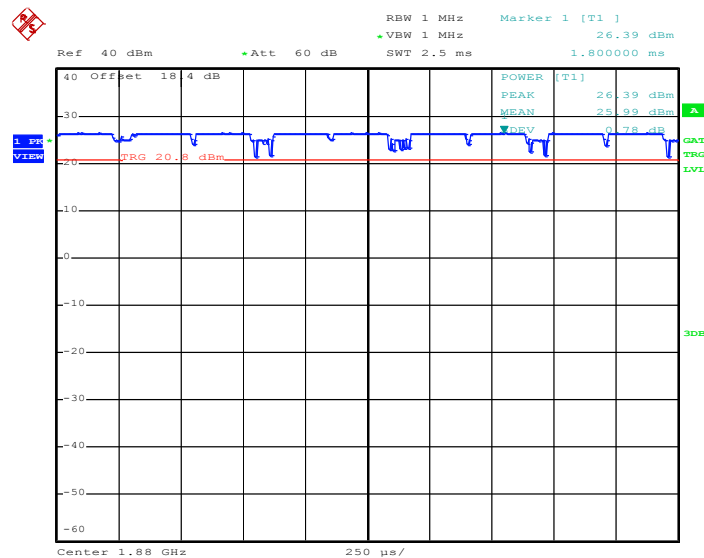

Date: 19.DEC.2012 03:56:23



Peak-to-Average Ratio on Channel 810 (1909.8 MHz)

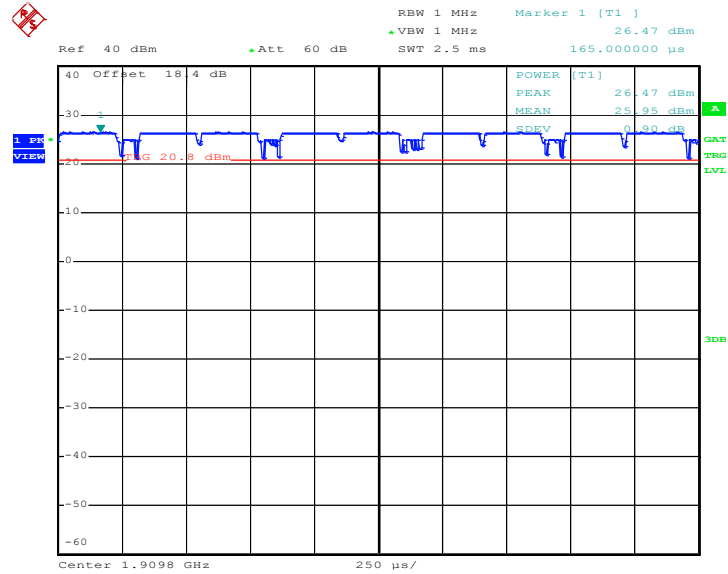

Date: 19.DEC.2012 03:57:17



Band :	WCDMA Band II	Test Mode :	RMC 12.2Kbps Link
---------------	---------------	--------------------	-------------------

Peak-to-Average Ratio on Channel 9262 (1852.4 MHz)

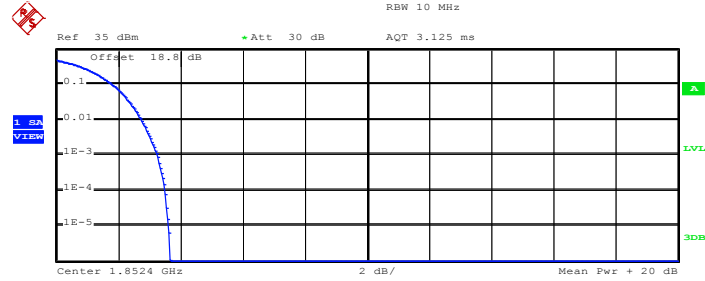

Complementary Cumulative Distribution Function (100000 samples)

Trace 1

Mean	22.76 dBm
Peak	26.44 dBm
Crest	3.68 dB
10 %	1.80 dB
1 %	2.76 dB
.1 %	3.28 dB
.01 %	3.52 dB

Date: 19.DEC.2012 05:08:08

Peak-to-Average Ratio on Channel 9400 (1880.0 MHz)

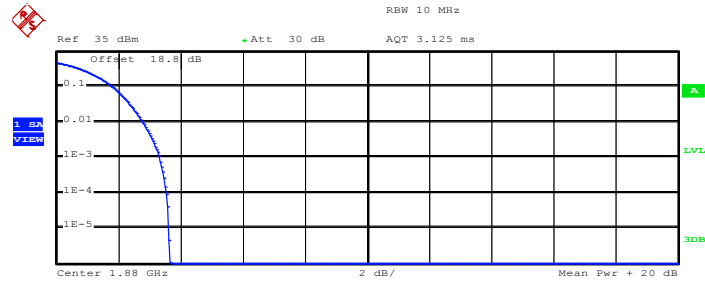

Complementary Cumulative Distribution Function (100000 samples)

Trace 1

Mean	22.16 dBm
Peak	25.80 dBm
Crest	3.64 dB
10 %	1.84 dB
1 %	2.80 dB
.1 %	3.32 dB
.01 %	3.56 dB

Date: 19.DEC.2012 05:07:16



Peak-to-Average Ratio on Channel 9538 (1907.6 MHz)

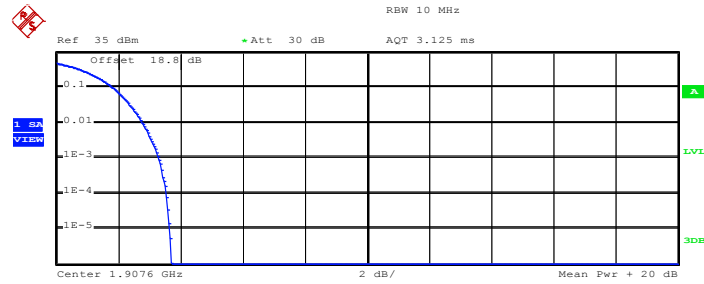

Complementary Cumulative Distribution Function (100000 samples)

Trace 1	
Mean	22.44 dBm
Peak	26.15 dBm
Crest	3.71 dB
10 %	1.84 dB
1 %	2.76 dB
.1 %	3.32 dB
.01 %	3.56 dB

Date: 19.DEC.2012 05:09:06



3.3 Effective Radiated Power and Effective Isotropic Radiated Power Measurement

3.3.1 Description of the ERP/EIRP Measurement

The substitution method, in ANSI / TIA / EIA-603-C-2004, was used for ERP/EIRP measurement, and the spectrum analyzer configuration follows KDB 971168 D01 Power Meas. License Digital Systems v01. The ERP of mobile transmitters must not exceed 7 Watts and the EIRP of mobile transmitters are limited to 2 Watts.

3.3.2 Measuring Instruments

See list of measuring instruments of this test report.

3.3.3 Test Procedures

1. The EUT was placed on a non-conductive rotating platform with 0.8 meter height in a semi-anechoic chamber. The radiated emission at the fundamental frequency was measured at 3 m with a test antenna and a spectrum analyzer with RBW= 1MHz, VBW= 3MHz for GSM, RBW= 100 KHz, VBW= 300 KHz, used channel power option with bandwidth=5MHz for WCDMA, and RMS detector settings per section 4.0 of KDB 971168 D01.
2. During the measurement, the EUT was enforced in maximum power and linked with a base station. The highest emission was recorded from analyzer power level (LVL) from the 360 degrees rotation of the turntable and the test antenna raised and lowered over a range from 1 to 4 meters in both horizontally and vertically polarized orientations.
3. Effective Isotropic Radiated Power (EIRP) was measured by substitution method according to TIA/EIA-603-C. The EUT was replaced by dipole antenna (substitution antenna) at same location, and then a known power from S.G. was applied into the dipole antenna through a Tx cable, and then recorded the maximum Analyzer reading through raised and lowered the test antenna. The correction factor (in dB) = S.G. - Tx Cable loss + Substitution antenna gain - Analyzer reading. Then the EUT's EIRP was calculated with the correction factor, $EIRP = LVL + \text{Correction factor}$ and $ERP = EIRP - 2.15$.

3.3.4 Test Setup

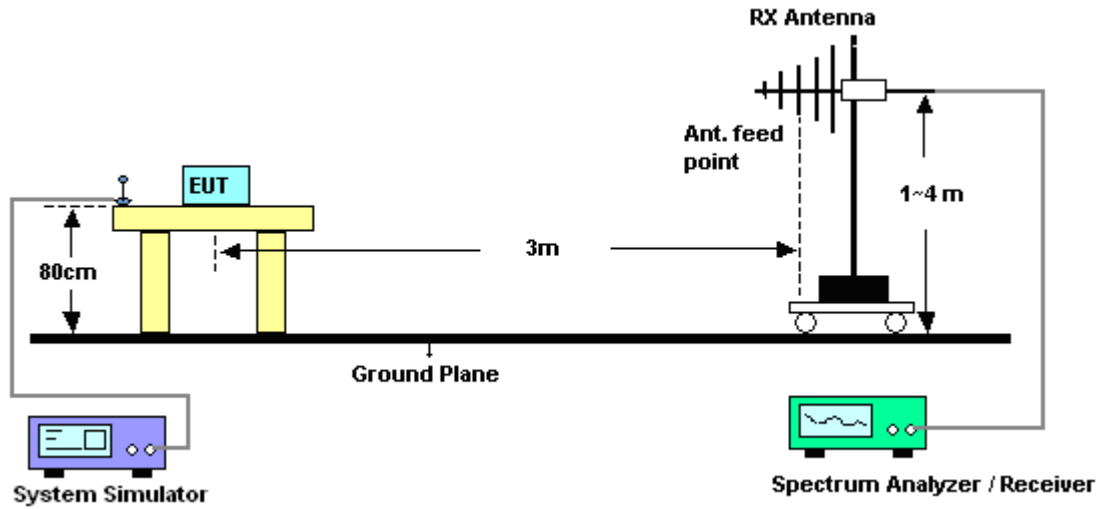



3.3.5 Test Result of ERP

GSM850 (GPRS 8) Radiated Power ERP				
Horizontal Polarization				
Frequency (MHz)	LVL (dBm)	Correction Factor (dB)	ERP (dBm)	ERP (W)
824.2	-4.12	28.65	22.38	0.1730
836.4	-4.43	28.91	22.33	0.1710
848.8	-4.79	29.68	22.74	0.1879
Vertical Polarization				
Frequency (MHz)	LVL (dBm)	Correction Factor (dB)	ERP (dBm)	ERP (W)
824.2	-9.72	32.95	21.08	0.1282
836.4	-9.51	32.5	20.84	0.1213
848.8	-9.38	32.88	21.35	0.1365

* ERP = LVL (dBm) + Correction Factor (dB) – 2.15

GSM850 (EDGE 8) Radiated Power ERP				
Horizontal Polarization				
Frequency (MHz)	LVL (dBm)	Correction Factor (dB)	ERP (dBm)	ERP (W)
824.2	-5.10	28.65	21.40	0.1380
836.4	-5.62	28.91	21.14	0.1300
848.8	-5.58	29.68	21.95	0.1567
Vertical Polarization				
Frequency (MHz)	LVL (dBm)	Correction Factor (dB)	ERP (dBm)	ERP (W)
824.2	-11.60	32.95	19.20	0.0832
836.4	-11.56	32.5	18.79	0.0757
848.8	-10.87	32.88	19.86	0.0968

* ERP = LVL (dBm) + Correction Factor (dB) – 2.15



WCDMA Band V (RMC 12.2Kbps) Radiated Power ERP				
Horizontal Polarization				
Frequency (MHz)	LVL (dBm)	Correction Factor (dB)	ERP (dBm)	ERP (W)
826.40	-14.38	29.14	12.61	0.0182
836.40	-14.67	29.2	12.38	0.0173
846.60	-14.82	29.88	12.91	0.0195
Vertical Polarization				
Frequency (MHz)	LVL (dBm)	Correction Factor (dB)	ERP (dBm)	ERP (W)
826.40	-19.40	33.11	11.56	0.0143
836.40	-19.18	32.7	11.37	0.0137
846.60	-18.89	32.76	11.72	0.0149

* ERP = LVL (dBm) + Correction Factor (dB) – 2.15

3.3.6 Test Result of EIRP

GSM1900 (GPRS 8) Radiated Power EIRP				
Horizontal Polarization				
Frequency (MHz)	LVL (dBm)	Correction Factor (dB)	EIRP (dBm)	EIRP (W)
1850.2	-22.79	43.16	20.37	0.1089
1880.0	-23.11	43.11	20.00	0.1000
1909.8	-23.84	43.14	19.30	0.0851
Vertical Polarization				
Frequency (MHz)	LVL (dBm)	Correction Factor (dB)	EIRP (dBm)	EIRP (W)
1850.2	-25.95	44.81	18.86	0.0769
1880.0	-28.11	46.82	18.71	0.0743
1909.8	-28.86	47.16	18.30	0.0676

* EIRP = LVL (dBm) + Correction Factor (dB)

GSM1900 (EDGE 8) Radiated Power EIRP				
Horizontal Polarization				
Frequency (MHz)	LVL (dBm)	Correction Factor (dB)	EIRP (dBm)	EIRP (W)
1850.2	-24.39	43.16	18.77	0.0753
1880.0	-24.75	43.11	18.36	0.0685
1909.8	-25.16	43.14	17.98	0.0628
Vertical Polarization				
Frequency (MHz)	LVL (dBm)	Correction Factor (dB)	EIRP (dBm)	EIRP (W)
1850.2	-27.34	44.81	17.47	0.0558
1880.0	-29.40	46.82	17.42	0.0552
1909.8	-30.30	47.16	16.86	0.0485

* EIRP = LVL (dBm) + Correction Factor (dB)



WCDMA Band II (RMC 12.2Kbps) Radiated Power EIRP				
Horizontal Polarization				
Frequency (MHz)	LVL (dBm)	Correction Factor (dB)	EIRP (dBm)	EIRP (W)
1852.40	-29.64	43.18	13.54	0.0226
1880.00	-29.57	43.03	13.46	0.0222
1907.60	-30.63	43.05	12.42	0.0175
Vertical Polarization				
Frequency (MHz)	LVL (dBm)	Correction Factor (dB)	EIRP (dBm)	EIRP (W)
1852.40	-34.03	46.23	12.20	0.0166
1880.00	-34.62	46.69	12.07	0.0161
1907.60	-34.65	45.82	11.17	0.0131

* EIRP = LVL (dBm) + Correction Factor (dB)

3.4 99% Occupied Bandwidth and 26dB Bandwidth Measurement

3.4.1 Description of 99% Occupied Bandwidth and 26dB Bandwidth Measurement

The 99% occupied bandwidth is the width of a frequency band such that, below the lower and above the upper frequency limits, the mean powers emitted are each equal to a specified percentage 0.5% of the total mean transmitted power.

The emission bandwidth is defined as the width of the signal between two points, located at the 2 sides of the carrier frequency, outside of which all emissions are attenuated at least 26 dB below the transmitter power.

3.4.2 Measuring Instruments

See list of measuring instruments of this test report.

3.4.3 Test Procedures

1. The EUT was connected to Spectrum Analyzer and Base Station via power divider.
2. The RF output of EUT was connected to the spectrum analyzer by RF cable and attenuator. The path loss was compensated to the results for each measurement.
3. The 99% occupied bandwidth and 26 dB bandwidth of the middle channel for the highest RF powers were measured.

3.4.4 Test Setup

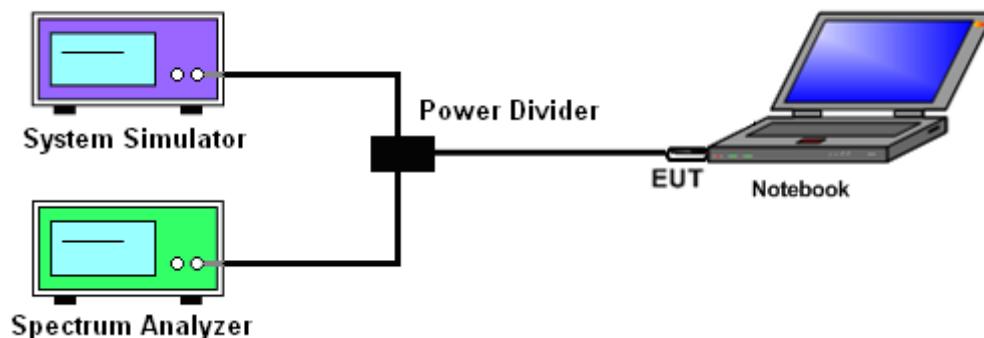

3.4.5 Test Result of Occupied Bandwidth and 26dB Bandwidth

Cellular Band						
Modes	GSM850 (GPRS 8)			GSM850 (EDGE 8)		
Channel	128 (Low)	189 (Mid)	251 (High)	128 (Low)	189 (Mid)	251 (High)
Frequency (MHz)	824.2	836.4	848.8	824.2	836.4	848.8
99% OBW (KHz)	244.00	244.00	250.00	246.00	244.00	246.00
26dB BW (KHz)	316.00	322.00	320.00	308.00	308.00	308.00

PCS Band						
Modes	GSM1900 (GPRS 8)			GSM1900 (EDGE 8)		
Channel	512 (Low)	661 (Mid)	810 (High)	512 (Low)	661 (Mid)	810 (High)
Frequency (MHz)	1850.2	1880	1909.8	1850.2	1880	1909.8
99% OBW (KHz)	246.00	244.00	246.00	248.00	250.00	246.00
26dB BW (KHz)	322.00	320.00	316.00	310.00	318.00	314.00

Cellular Band			
Modes	WCDMA Band V (RMC 12.2Kbps)		
Channel	4132 (Low)	4182 (Mid)	4233 (High)
Frequency (MHz)	826.4	836.4	846.6
99% OBW (MHz)	4.22	4.16	4.18
26dB BW (MHz)	4.70	4.70	4.70

PCS Band			
Modes	WCDMA Band II (RMC 12.2Kbps)		
Channel	9262 (Low)	9400 (Mid)	9538 (High)
Frequency (MHz)	1852.4	1880	1907.6
99% OBW (MHz)	4.20	4.18	4.16
26dB BW (MHz)	4.68	4.68	4.68



3.4.6 Test Result (Plots) of Occupied Bandwidth and 26dB Bandwidth

Band :	GSM 850	Test Mode :	GPRS 8 Link
--------	---------	-------------	-------------

99% Occupied Bandwidth Plot on Channel 128 (824.2 MHz)

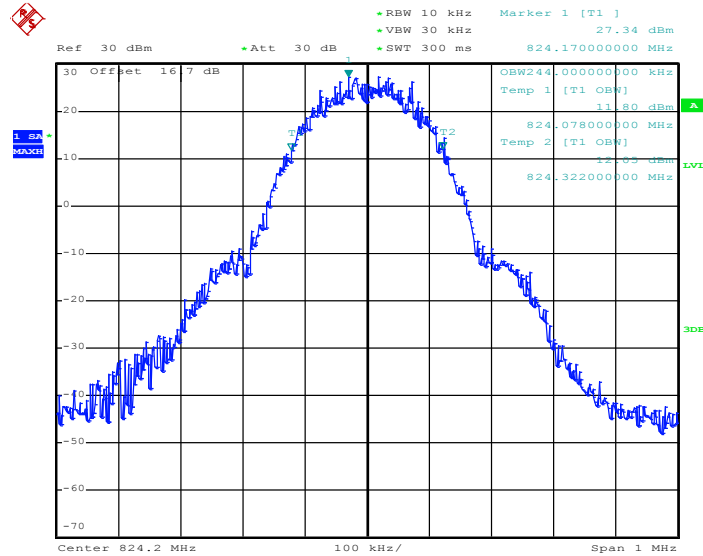

Date: 19.DEC.2012 01:44:45

26dB Bandwidth Plot on Channel 128 (824.2 MHz)

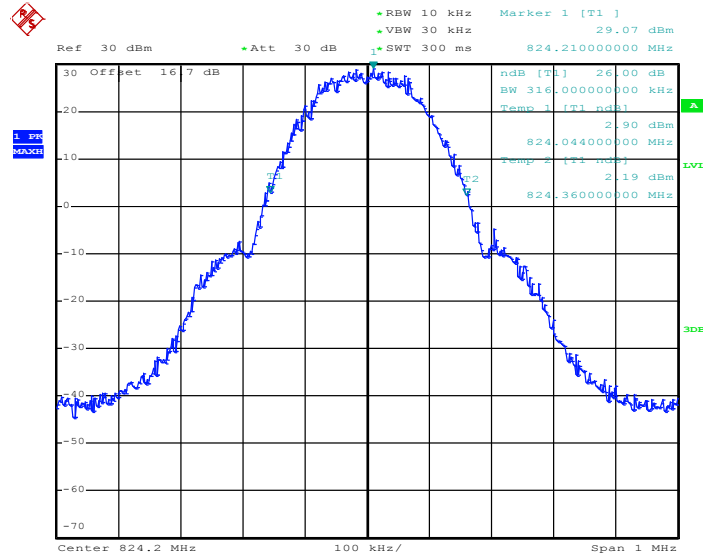

Date: 19.DEC.2012 01:22:17



99% Occupied Bandwidth Plot on Channel 189 (836.4 MHz)

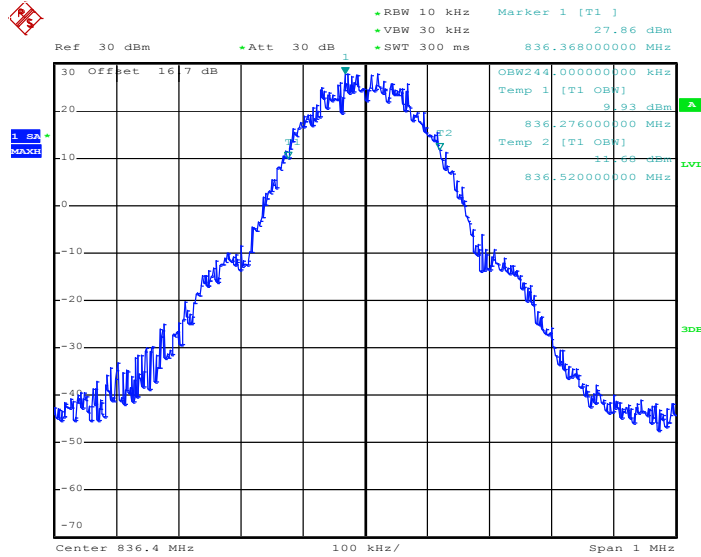

Date: 19.DEC.2012 01:46:15

26dB Bandwidth Plot on Channel 189 (836.4 MHz)

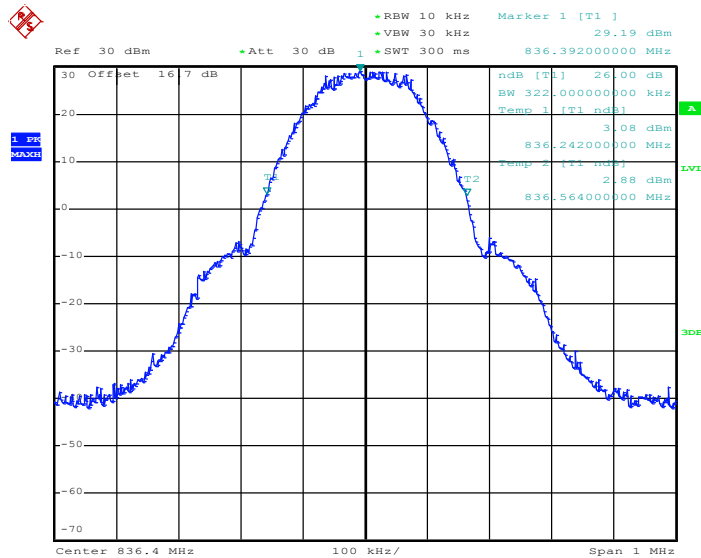

Date: 19.DEC.2012 01:21:34



99% Occupied Bandwidth Plot on Channel 251 (848.8 MHz)

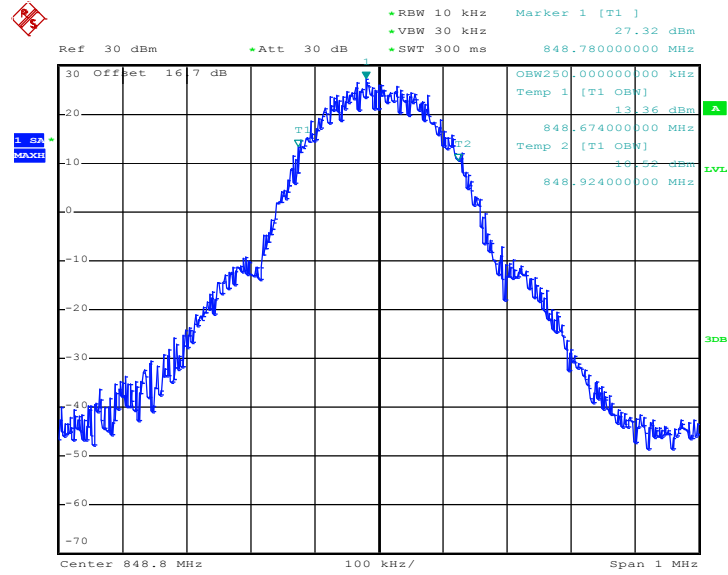

Date: 19.DEC.2012 01:47:44

26dB Bandwidth Plot on Channel 251 (848.8 MHz)

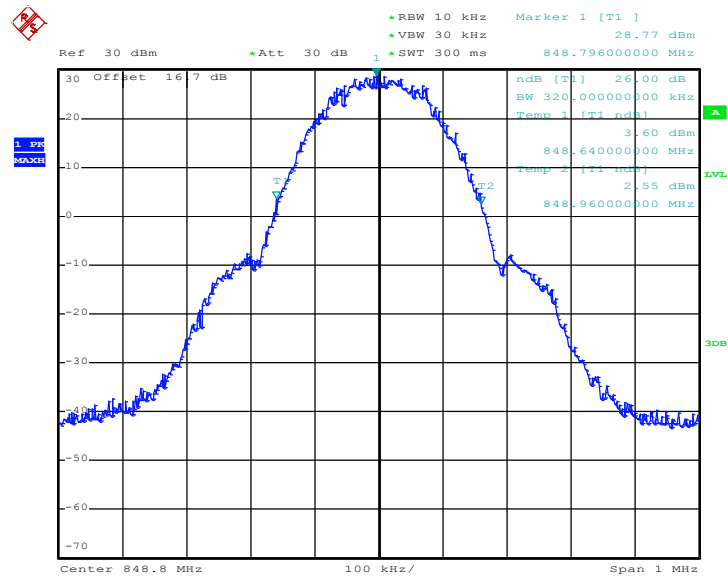

Date: 19.DEC.2012 01:23:04



Band :	GSM 850	Test Mode :	EDGE 8 Link
--------	---------	-------------	-------------

99% Occupied Bandwidth Plot on Channel 128 (824.2 MHz)

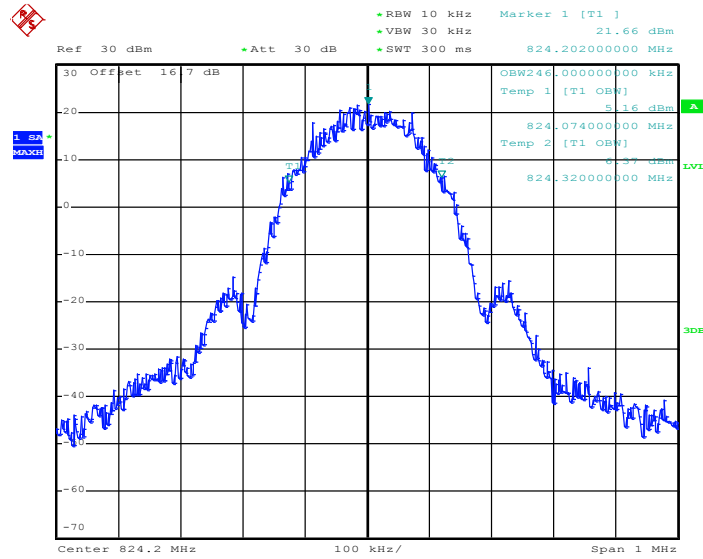

Date: 19.DEC.2012 03:13:05

26dB Bandwidth Plot on Channel 128 (824.2 MHz)

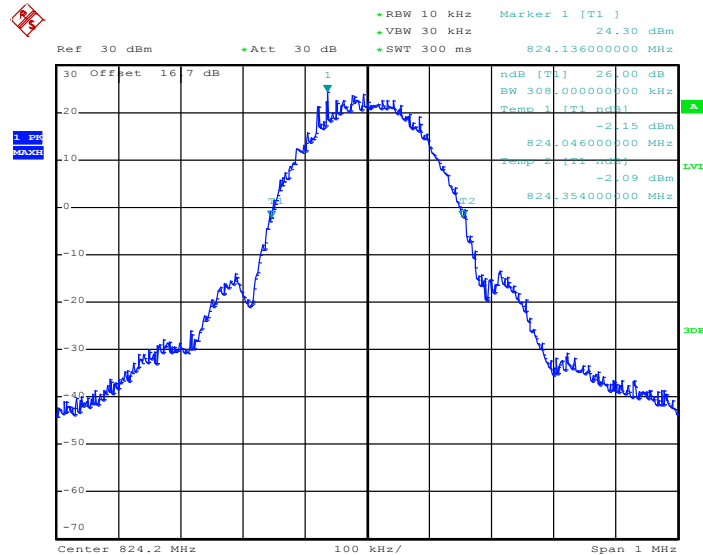

Date: 19.DEC.2012 03:07:44



99% Occupied Bandwidth Plot on Channel 189 (836.4 MHz)

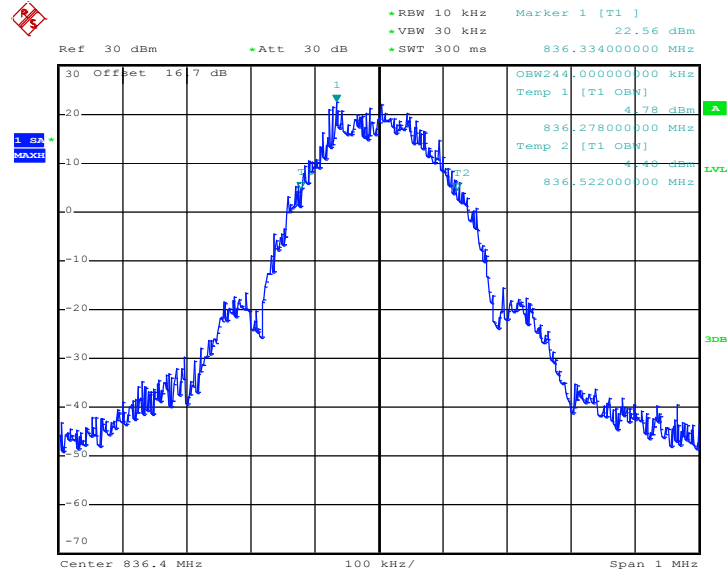

Date: 19.DEC.2012 03:14:34

26dB Bandwidth Plot on Channel 189 (836.4 MHz)

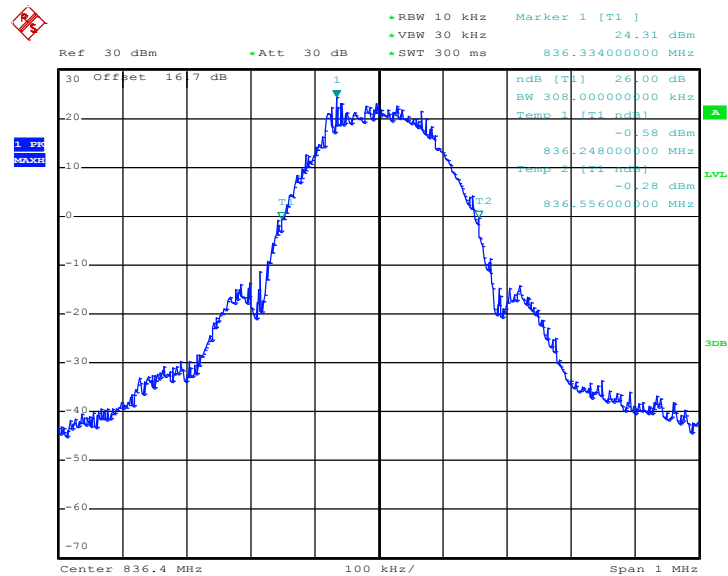

Date: 19.DEC.2012 03:09:13



99% Occupied Bandwidth Plot on Channel 251 (848.8 MHz)

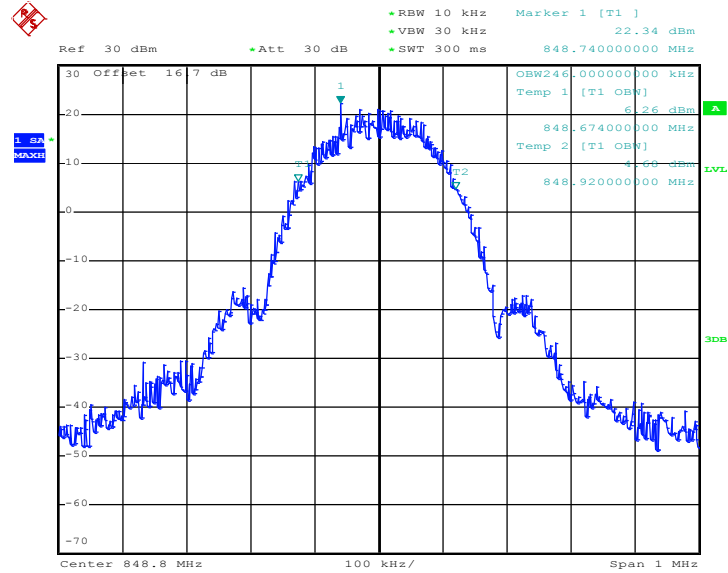

Date: 19.DEC.2012 03:16:03

26dB Bandwidth Plot on Channel 251 (848.8 MHz)

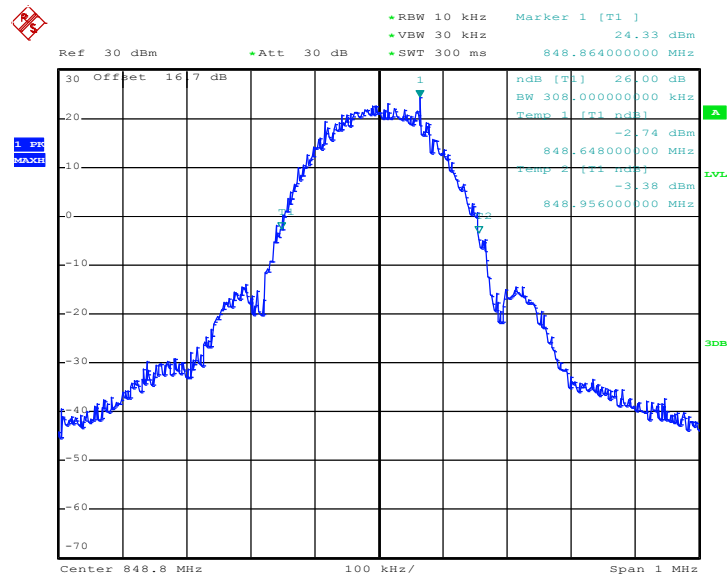

Date: 19.DEC.2012 03:10:41



Band :	GSM 1900	Test Mode :	GPRS 8 Link
---------------	----------	--------------------	-------------

99% Occupied Bandwidth Plot on Channel 512 (1850.2 MHz)

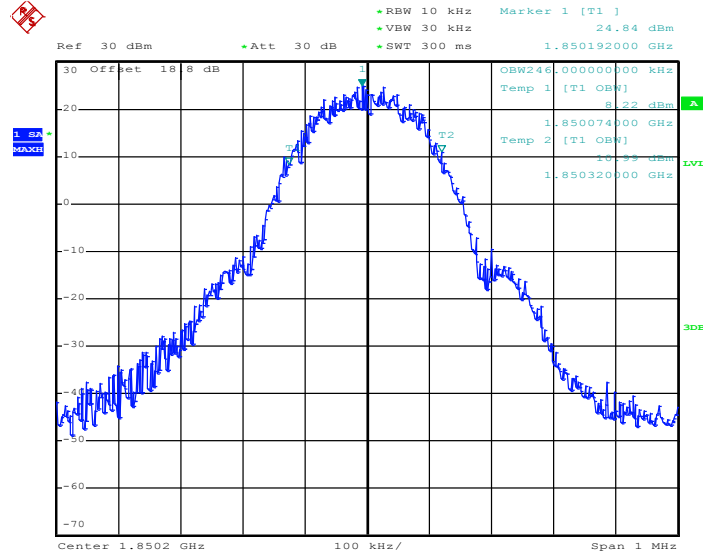

Date: 19.DEC.2012 04:42:50

26dB Bandwidth Plot on Channel 512 (1850.2 MHz)

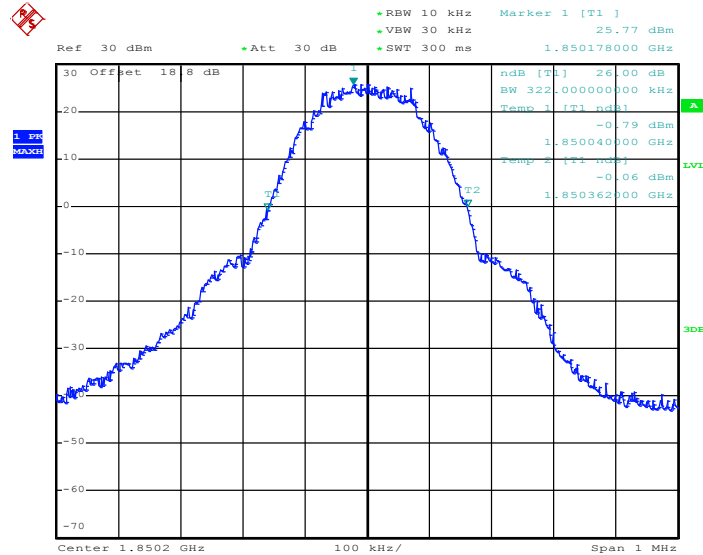

Date: 19.DEC.2012 04:38:07



99% Occupied Bandwidth Plot on Channel 661 (1880.0 MHz)

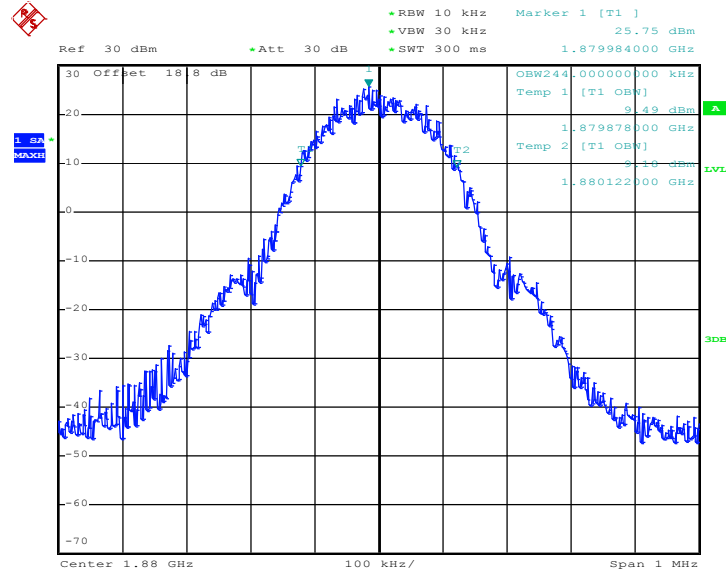

Date: 19.DEC.2012 04:44:19

26dB Bandwidth Plot on Channel 661 (1880.0 MHz)

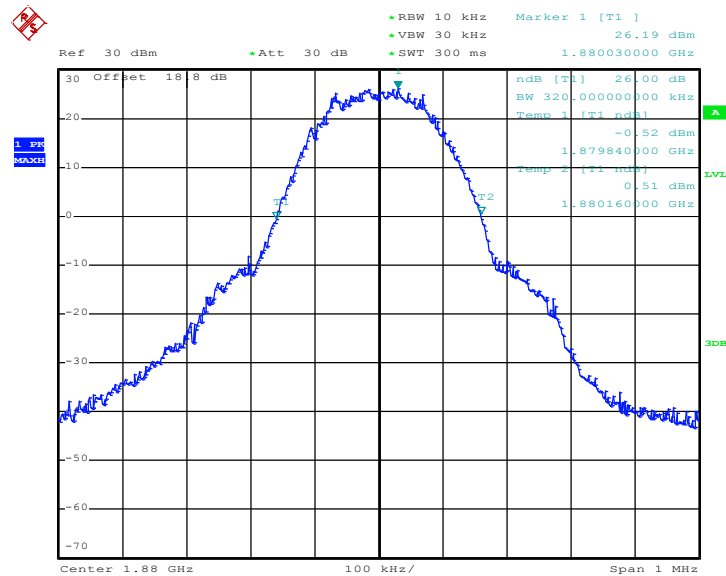

Date: 19.DEC.2012 04:39:36



99% Occupied Bandwidth Plot on Channel 810 (1909.8 MHz)

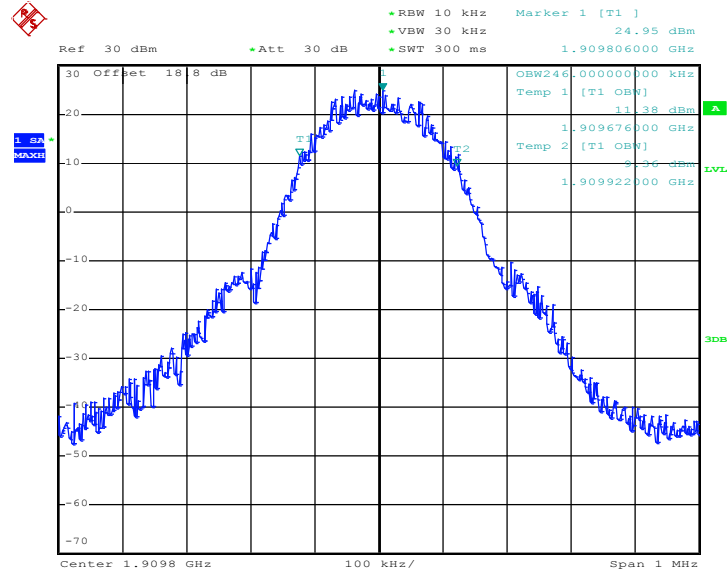

Date: 19.DEC.2012 04:45:49

26dB Bandwidth Plot on Channel 810 (1909.8 MHz)

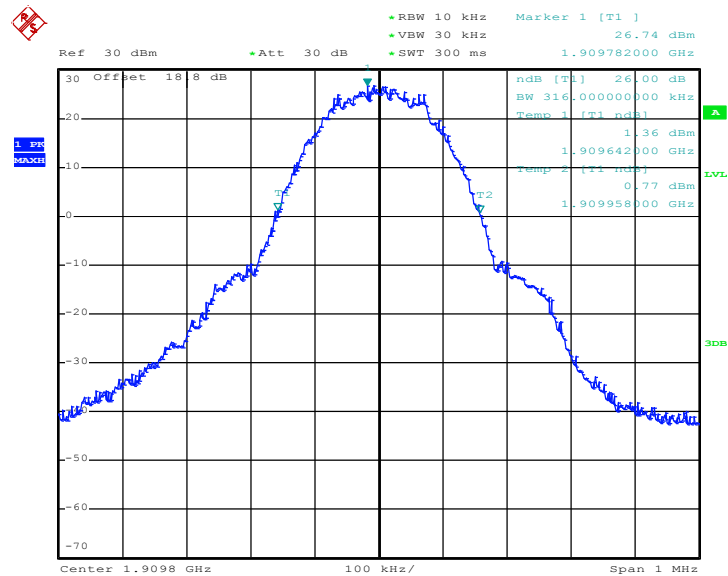

Date: 19.DEC.2012 04:41:05



Band :	GSM 1900	Test Mode :	EDGE 8 Link
---------------	----------	--------------------	-------------

99% Occupied Bandwidth Plot on Channel 512 (1850.2 MHz)

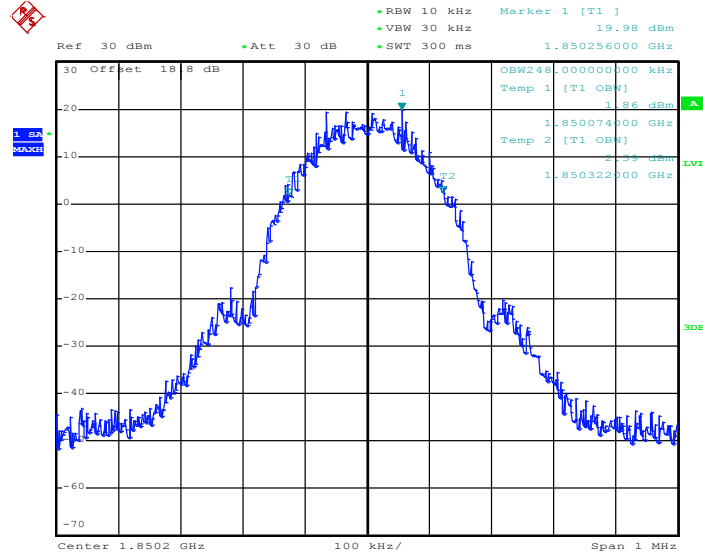

Date: 19.DEC.2012 04:08:41

26dB Bandwidth Plot on Channel 512 (1850.2 MHz)

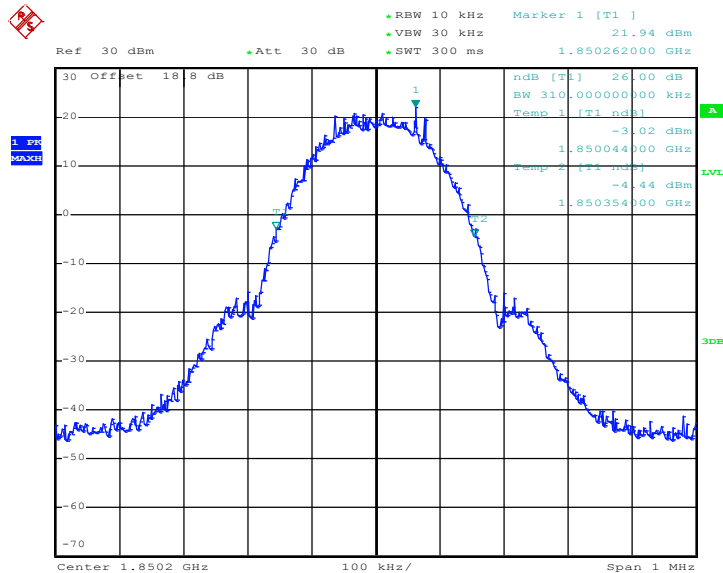

Date: 19.DEC.2012 04:03:50



99% Occupied Bandwidth Plot on Channel 661 (1880.0 MHz)

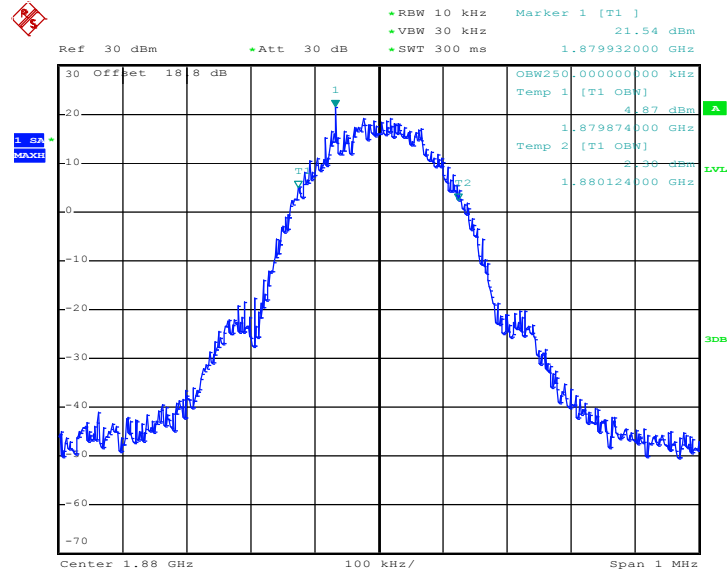

Date: 19.DEC.2012 04:10:10

26dB Bandwidth Plot on Channel 661 (1880.0 MHz)

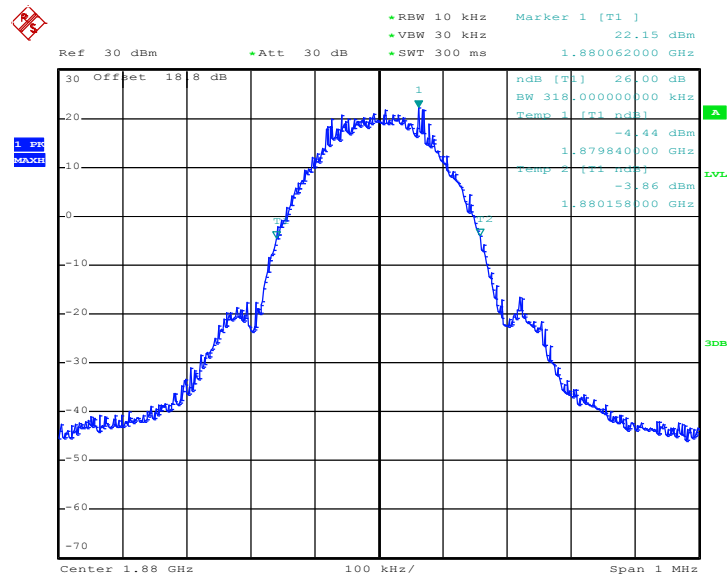

Date: 19.DEC.2012 04:05:19



99% Occupied Bandwidth Plot on Channel 810 (1909.8 MHz)

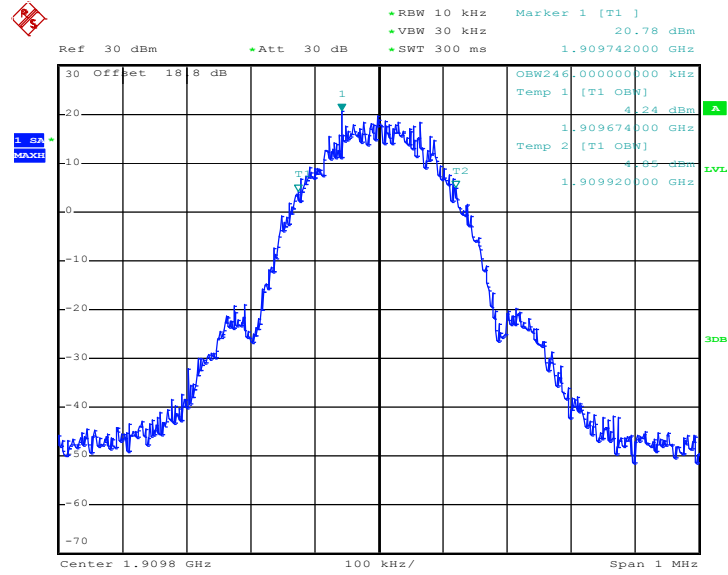

Date: 19.DEC.2012 04:11:39

26dB Bandwidth Plot on Channel 810 (1909.8 MHz)

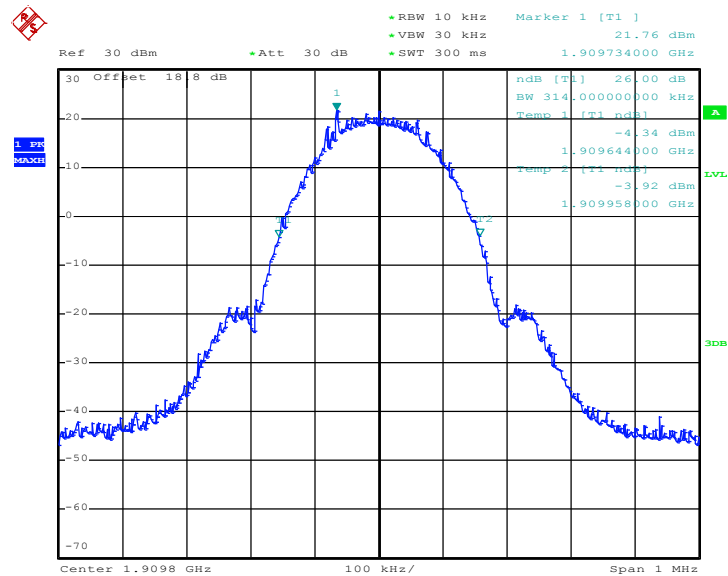

Date: 19.DEC.2012 04:06:49



Band :	WCDMA Band V	Test Mode :	RMC 12.2Kbps Link
---------------	--------------	--------------------	-------------------

99% Occupied Bandwidth Plot on Channel 4132 (826.4 MHz)

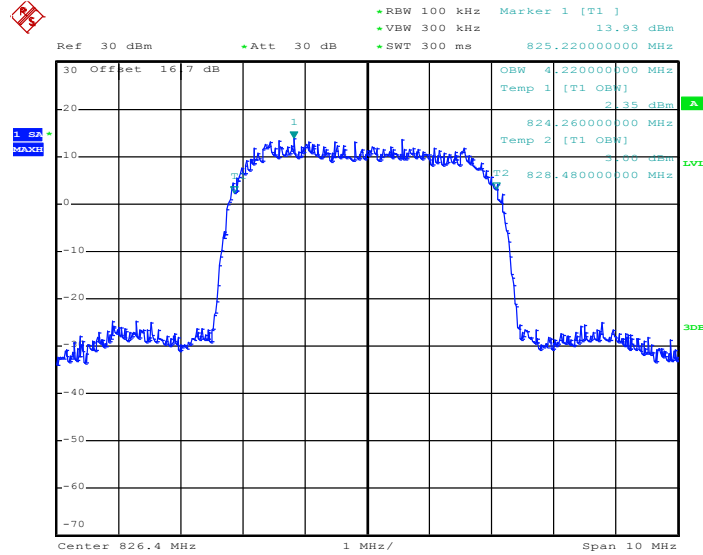

Date: 19.DEC.2012 05:51:31

26dB Bandwidth Plot on Channel 4132 (826.4 MHz)

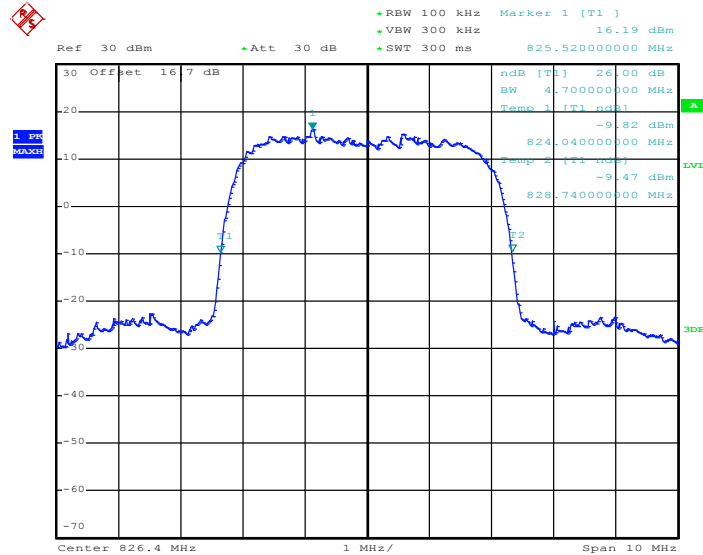

Date: 19.DEC.2012 05:50:12



99% Occupied Bandwidth Plot on Channel 4182 (836.4 MHz)

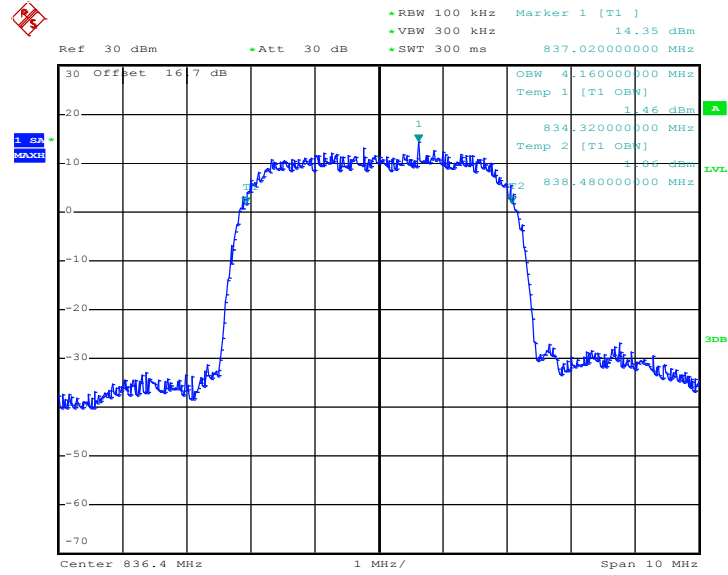

Date: 19.DEC.2012 05:51:57

26dB Bandwidth Plot on Channel 4182 (836.4 MHz)

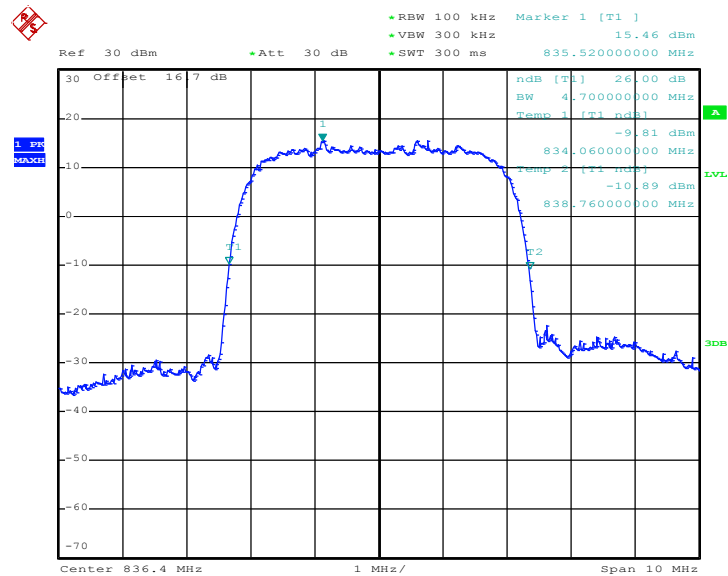

Date: 19.DEC.2012 05:50:38



99% Occupied Bandwidth Plot on Channel 4233 (846.6 MHz)

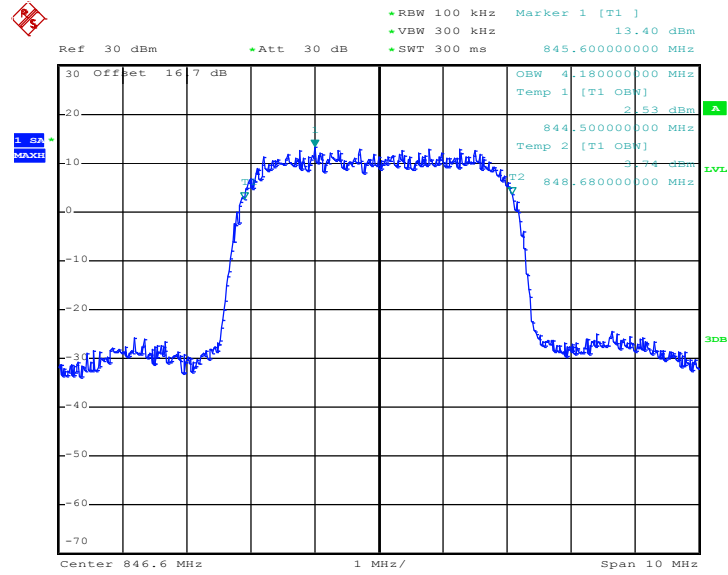

Date: 19.DEC.2012 05:52:22

26dB Bandwidth Plot on Channel 4233 (846.6 MHz)

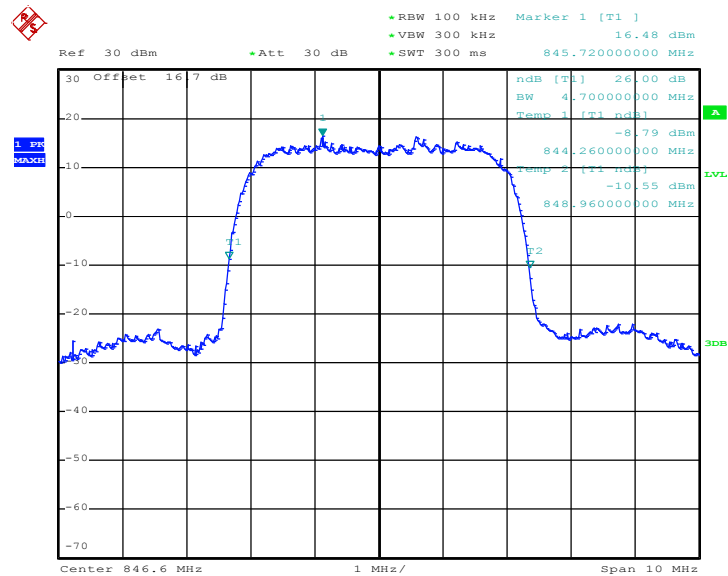

Date: 19.DEC.2012 05:51:04



Band :	WCDMA Band II	Test Mode :	RMC 12.2Kbps Link
---------------	---------------	--------------------	-------------------

99% Occupied Bandwidth Plot on Channel 9262 (1852.4 MHz)

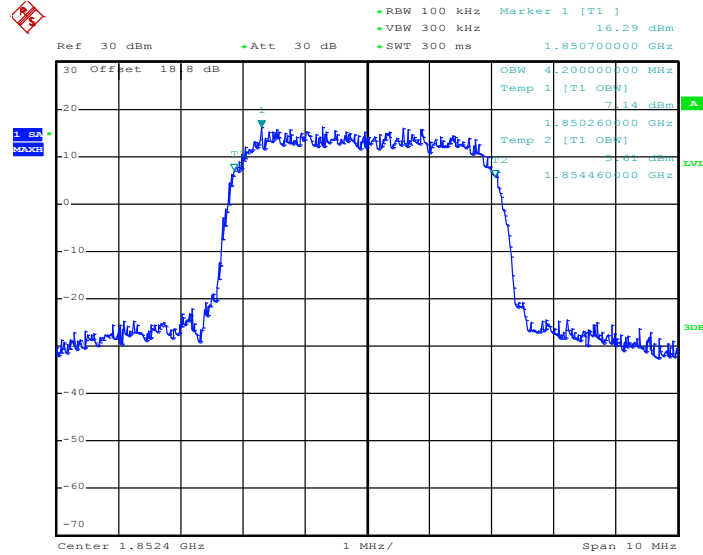

Date: 19.DEC.2012 05:18:14

26dB Bandwidth Plot on Channel 9262 (1852.4 MHz)

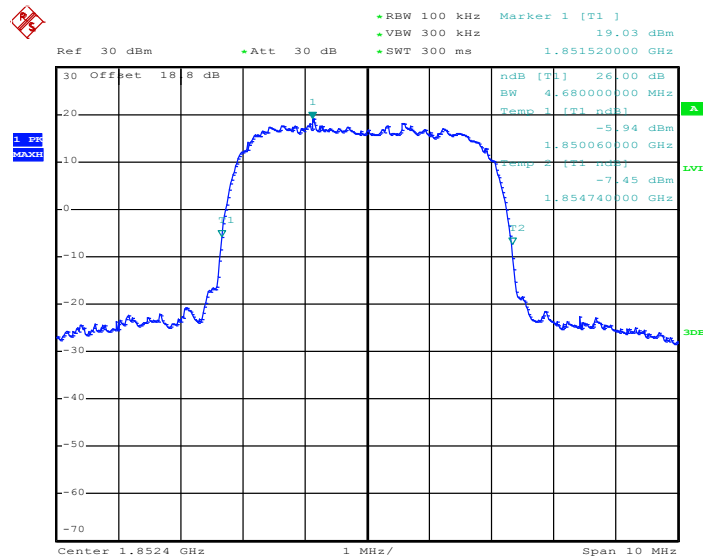

Date: 19.DEC.2012 05:33:28



99% Occupied Bandwidth Plot on Channel 9400 (1880.0 MHz)

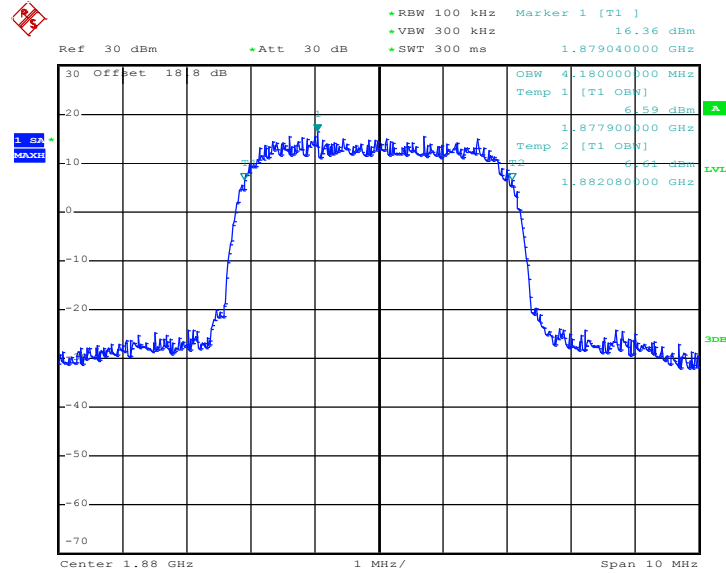

Date: 19.DEC.2012 05:18:40

26dB Bandwidth Plot on Channel 9400 (1880.0 MHz)

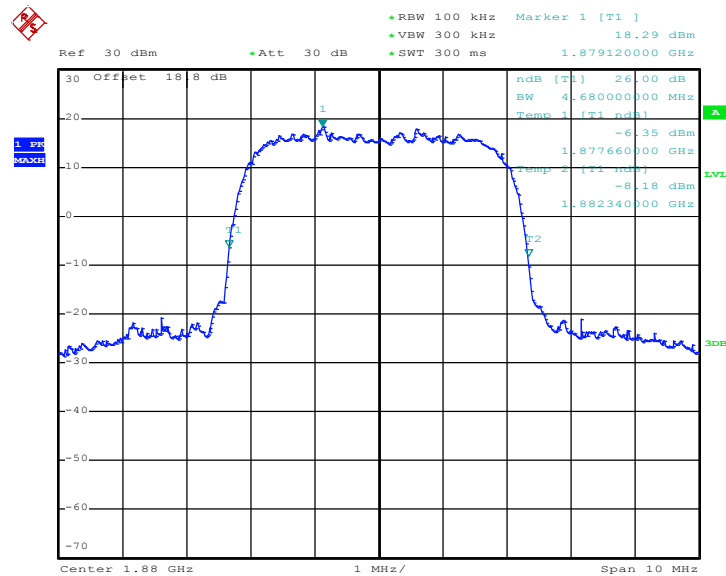

Date: 19.DEC.2012 05:33:54



99% Occupied Bandwidth Plot on Channel 9538 (1907.6 MHz)

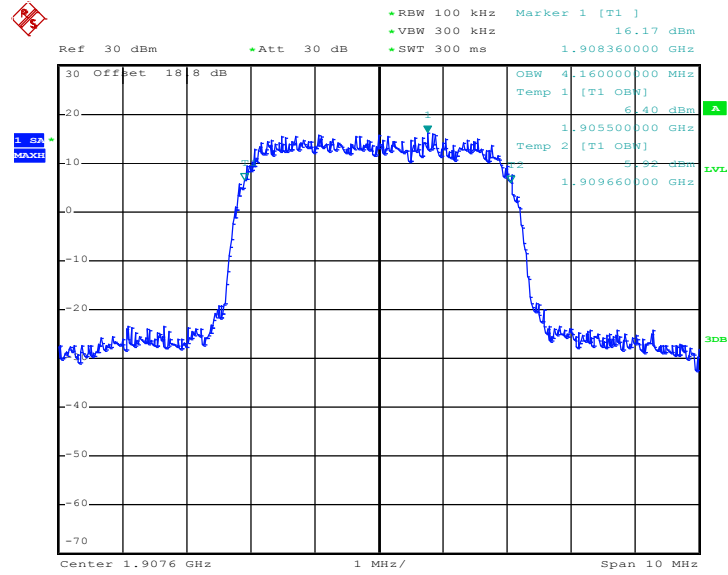

Date: 19.DEC.2012 05:19:05

26dB Bandwidth Plot on Channel 9538 (1907.6 MHz)

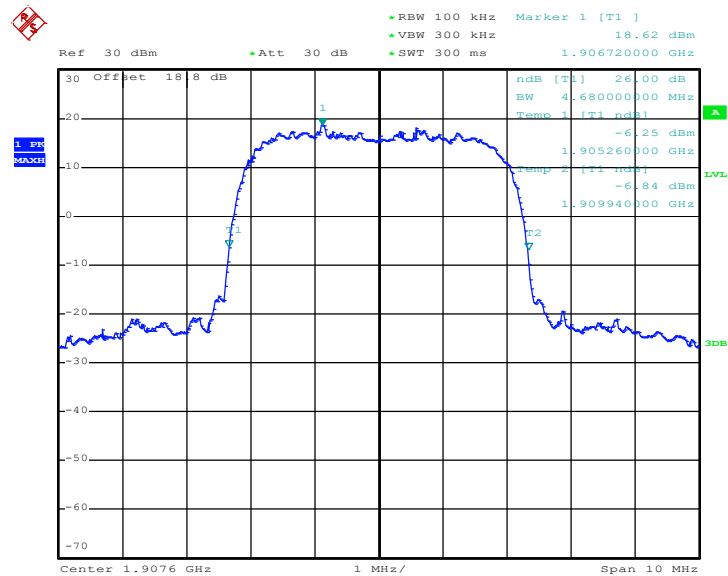

Date: 19.DEC.2012 05:34:20

3.5 Band Edge Measurement

3.5.1 Description of Band Edge Measurement

The power of any emission outside of the authorized operating frequency ranges must be lower than the transmitter power (P) by a factor of at least $43 + 10 \log (P)$ dB.

3.5.2 Measuring Instruments

See list of measuring instruments of this test report.

3.5.3 Test Procedures

1. The EUT was connected to Spectrum Analyzer and Base Station via power divider.
2. The RF output of EUT was connected to the spectrum analyzer by RF cable and attenuator. The path loss was compensated to the results for each measurement.
3. The band edges of low and high channels for the highest RF powers were measured. Setting RBW as roughly BW/100.
4. The RF fundamental frequency should be excluded against the limit line in the operating frequency band.
5. The limit line is derived from $43 + 10\log(P)$ dB below the transmitter power P(Watts)

$$= P(W) - [43 + 10\log(P)] \text{ (dB)}$$

$$= [30 + 10\log(P)] \text{ (dBm)} - [43 + 10\log(P)] \text{ (dB)}$$

$$= -13\text{dBm}.$$

3.5.4 Test Setup

<Conducted Band Edge >

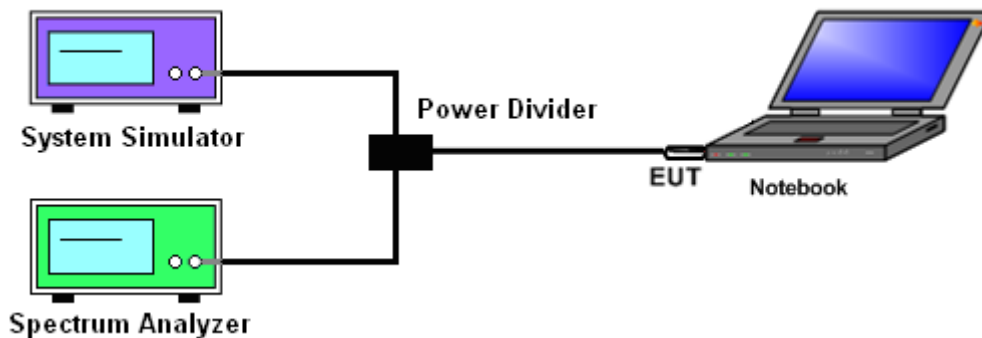



3.5.5 Test Result (Plots) of Conducted Band Edge

Band :	GSM850	Test Mode :	GPRS 8 Link
Correction Factor :	0.31dB	Maximum 26dB Bandwidth :	0.322MHz
Band Edge :	-16.73dBm	Measurement Value :	-17.04dBm

Lower Band Edge Plot on Channel 128 (824.2 MHz)

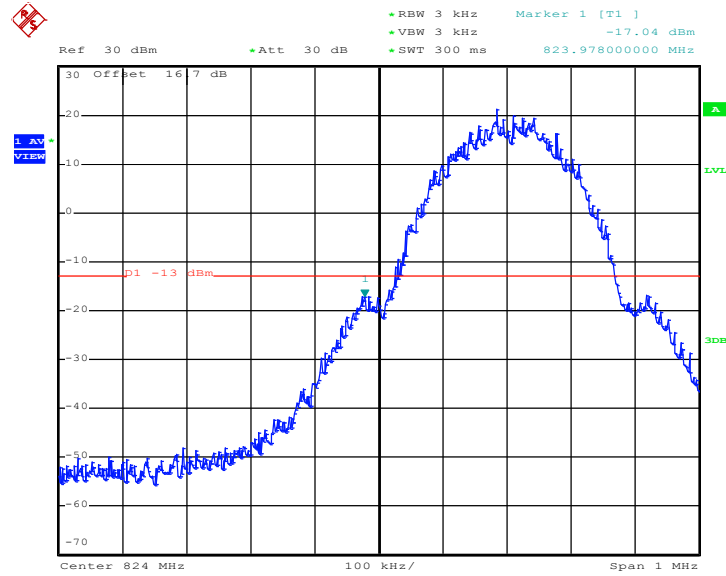

Date: 19.DEC.2012 01:49:20

1. Correction Factor(dB)= 10log(1% Emission BW/RBW)
 2. Band Edge= Measurement Value + Correction Factor(dB)
- For example, -17.04dBm + 0.31dB = -16.73dBm



Band :	GSM850	Test Mode :	GPRS 8 Link
Correction Factor :	0.31 dB	Maximum 26dB Bandwidth :	0.322MHz
Band Edge :	-18.03dBm	Measurement Value :	-18.34dBm

Higher Band Edge Plot on Channel 251 (848.8 MHz)

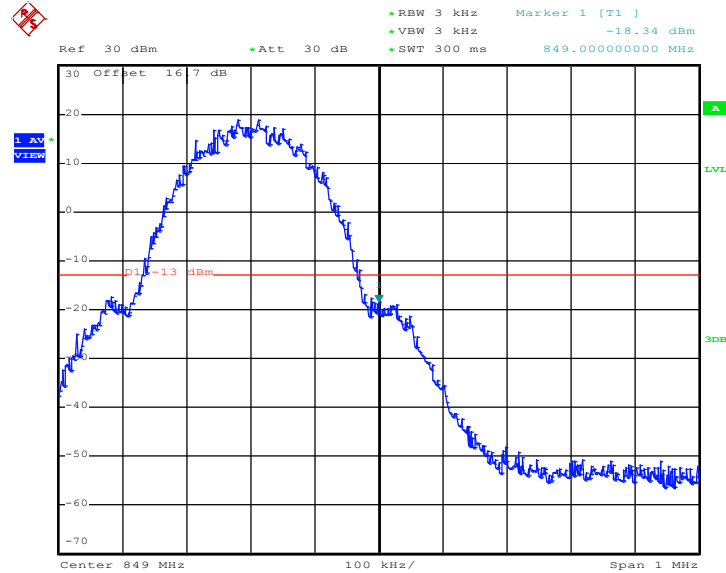

Date: 19.DEC.2012 01:50:48

1. Correction Factor(dB)= $10\log(1\% \text{ Emission BW/RBW})$
2. Band Edge= Measurement Value + Correction Factor(dB)



Band :	GSM850	Test Mode :	EDGE 8 Link
Correction Factor :	0.11dB	Maximum 26dB Bandwidth :	0.308MHz
Band Edge :	-23.54dBm	Measurement Value :	-23.65dBm

Lower Band Edge Plot on Channel 128 (824.2 MHz)

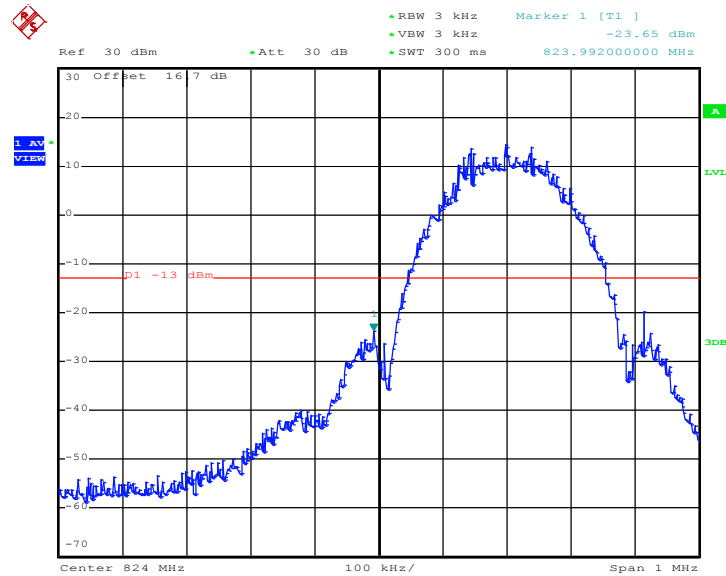

Date: 19.DEC.2012 03:20:09

1. Correction Factor(dB)= $10\log(1\% \text{ Emission BW/RBW})$
2. Band Edge= Measurement Value + Correction Factor(dB)



Band :	GSM850	Test Mode :	EDGE 8 Link
Correction Factor :	0.11dB	Maximum 26dB Bandwidth :	3.08MHz
Band Edge :	-24.58dBm	Measurement Value :	-24.69dBm

Higher Band Edge Plot on Channel 251 (848.8 MHz)

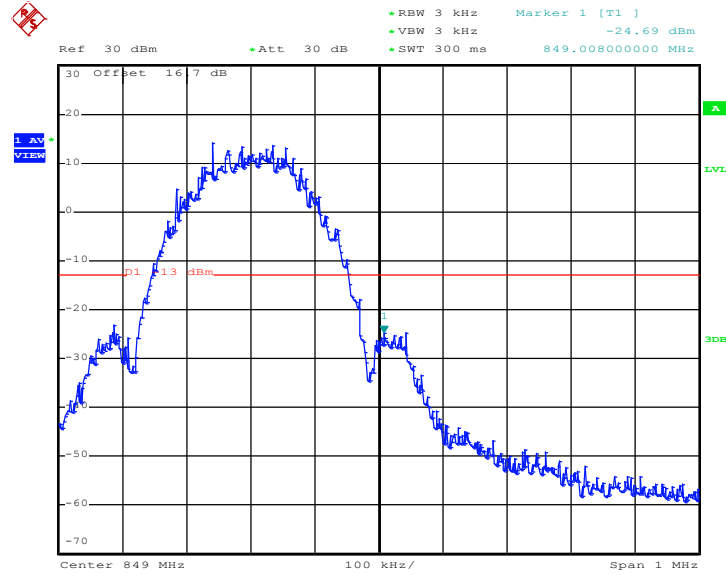

Date: 19.DEC.2012 03:21:38

1. Correction Factor(dB)= $10\log(1\% \text{ Emission BW/RBW})$
2. Band Edge= Measurement Value + Correction Factor(dB)



Band :	GSM1900	Test Mode :	GPRS 8 Link
Correction Factor :	0.31dB	Maximum 26dB Bandwidth :	0.322MHz
Band Edge :	-19.75dBm	Measurement Value :	-20.06dBm

Lower Band Edge Plot on Channel 512 (1850.2 MHz)

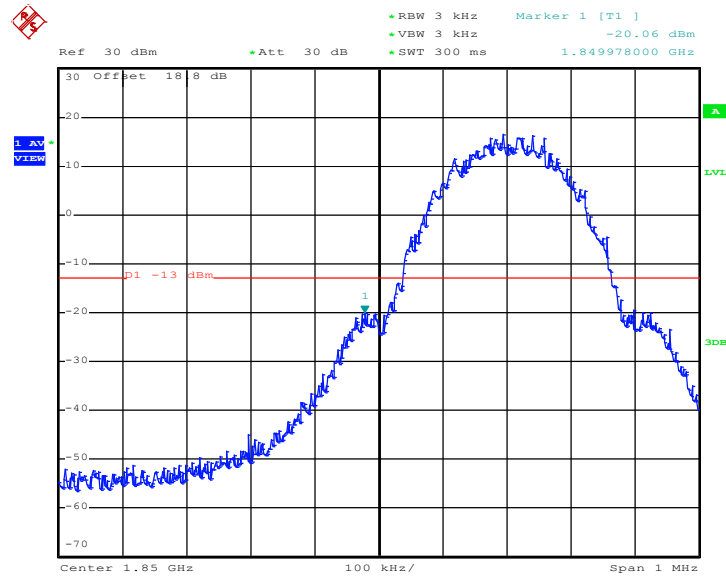

Date: 19.DEC.2012 04:47:43

1. Correction Factor(dB)= 10log(1% Emission BW/RBW)
2. Band Edge= Measurement Value + Correction Factor(dB)



Band :	GSM1900	Test Mode :	GPRS 8 Link
Correction Factor :	0.31dB	Maximum 26dB Bandwidth :	0.322MHz
Band Edge :	-19.66dBm	Measurement Value :	-19.97dBm

Higher Band Edge Plot on Channel 810 (1909.8 MHz)

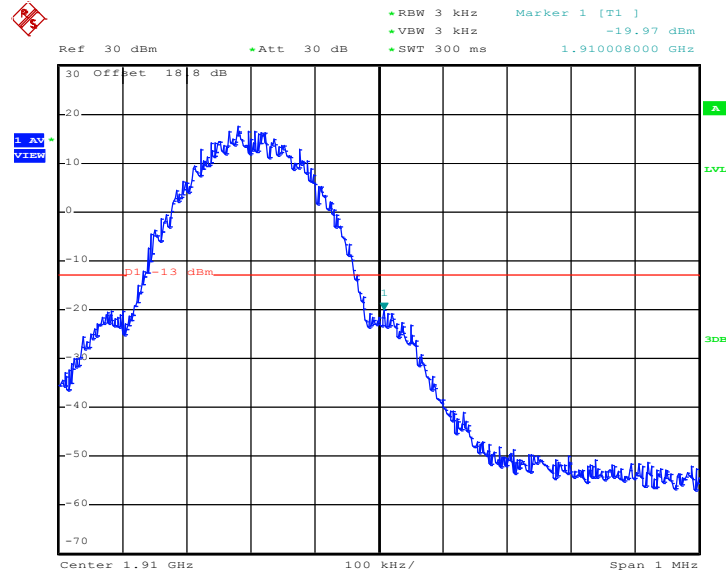

Date: 19.DEC.2012 04:49:12

1. Correction Factor(dB)= $10\log(1\% \text{ Emission BW/RBW})$
2. Band Edge= Measurement Value + Correction Factor(dB)



Band :	GSM1900	Test Mode :	EDGE 8 Link
Correction Factor :	0.25dB	Maximum 26dB Bandwidth :	0.318MHz
Band Edge :	-23.34dBm	Measurement Value :	-23.59dBm

Lower Band Edge Plot on Channel 512 (1850.2 MHz)

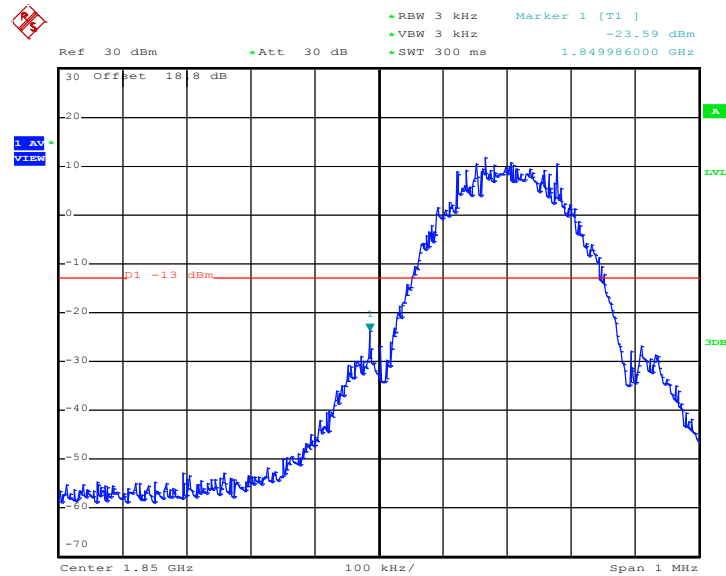

Date: 19.DEC.2012 04:13:25

1. Correction Factor(dB)= 10log(1% Emission BW/RBW)
2. Band Edge= Measurement Value + Correction Factor(dB)



Band :	GSM1900	Test Mode :	EDGE 8 Link
Correction Factor :	0.25dB	Maximum 26dB Bandwidth :	0.318MHz
Band Edge :	-25.63dBm	Measurement Value :	-25.88dBm

Higher Band Edge Plot on Channel 810 (1909.8 MHz)

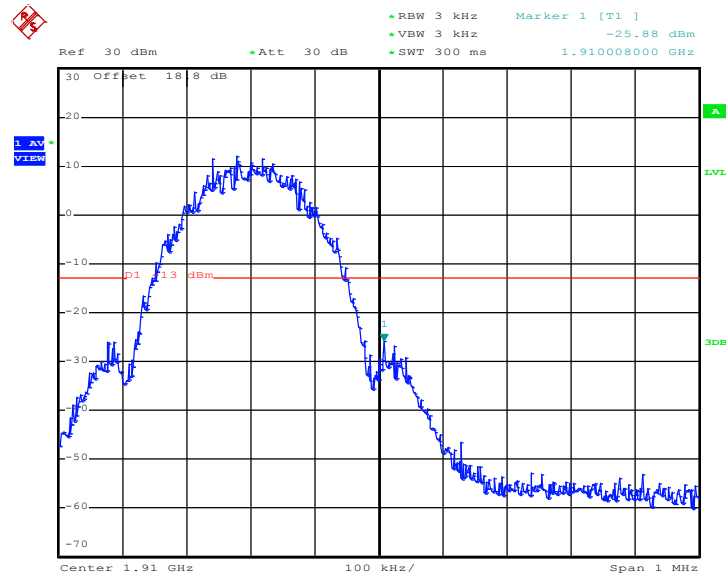

Date: 19.DEC.2012 04:14:54

1. Correction Factor(dB)= 10log(1% Emission BW/RBW)
2. Band Edge= Measurement Value + Correction Factor(dB)



Band :	WCDMA Band V	Test Mode :	RMC 12.2Kbps Link
Correction Factor :	-3.28dB	Maximum 26dB Bandwidth :	4.70MHz
Band Edge :	-28.42dBm	Measurement Value :	-25.14dBm

Lower Band Edge Plot on Channel 4132 (826.4 MHz)

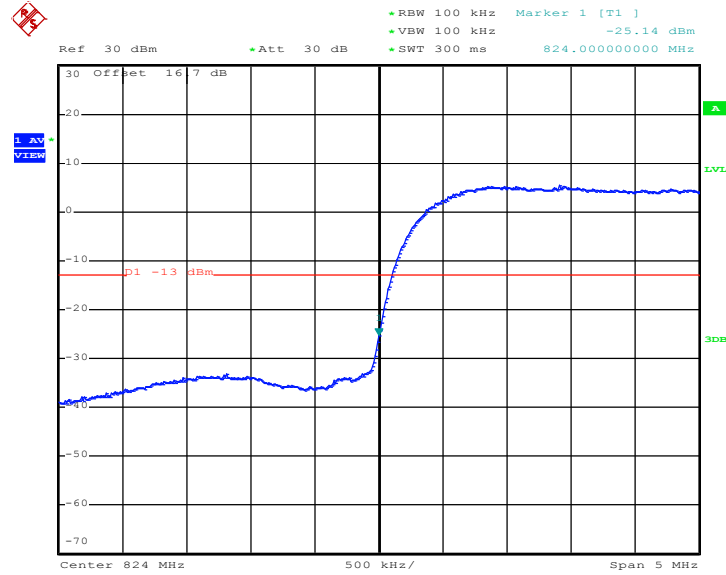

Date: 19.DEC.2012 05:52:49

1. Correction Factor(dB)= $10\log(1\% \text{ Emission BW/RBW})$
2. Band Edge= Measurement Value + Correction Factor(dB)



Band :	WCDMA Band V	Test Mode :	RMC 12.2Kbps Link
Correction Factor :	-3.28dB	Maximum 26dB Bandwidth :	4.70MHz
Band Edge :	-28.68dBm	Measurement Value :	-25.40dBm

Higher Band Edge Plot on Channel 4233 (846.6 MHz)

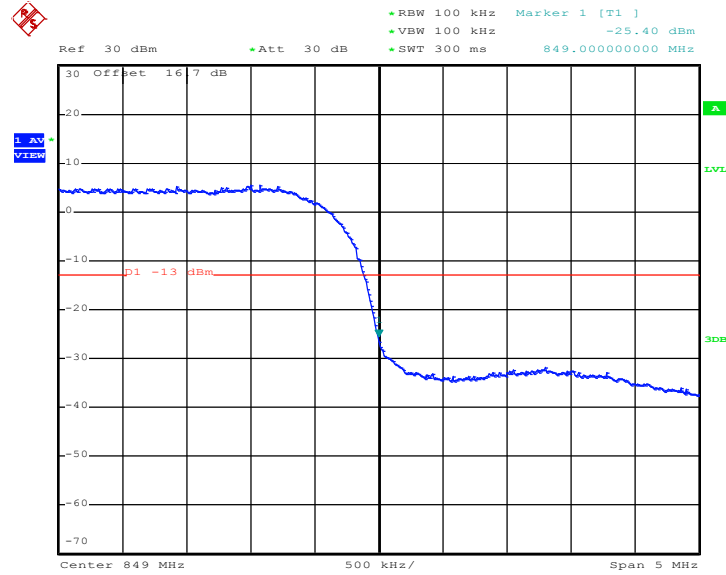

Date: 19.DEC.2012 05:53:15

1. Correction Factor(dB)= 10log(1% Emission BW/RBW)
2. Band Edge= Measurement Value + Correction Factor(dB)



Band :	WCDMA Band II	Test Mode :	RMC 12.2Kbps Link
Correction Factor :	-3.30dB	Maximum 26dB Bandwidth :	4.68MHz
Band Edge :	-27.42dBm	Measurement Value :	-24.12dBm

Lower Band Edge Plot on Channel 9262 (1852.4 MHz)

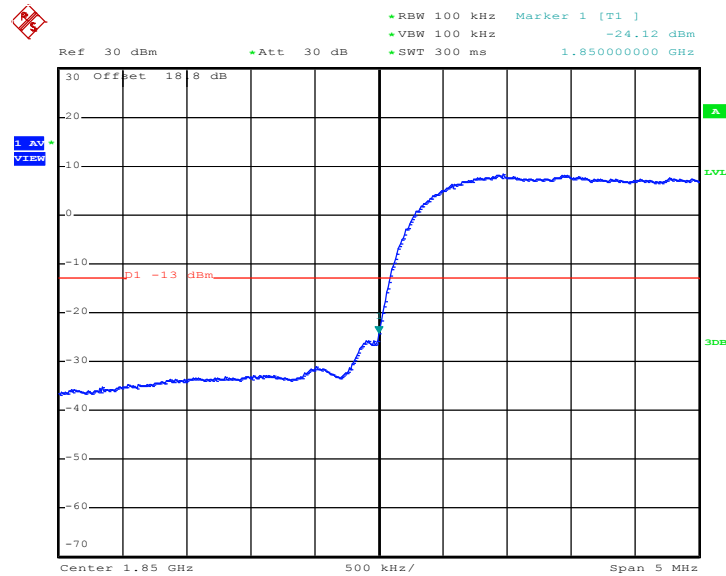

Date: 19.DEC.2012 05:30:32

1. Correction Factor(dB)= $10\log(1\% \text{ Emission BW/RBW})$
2. Band Edge= Measurement Value + Correction Factor(dB)



Band :	WCDMA Band II	Test Mode :	RMC 12.2Kbps Link
Correction Factor :	-3.30dB	Maximum 26dB Bandwidth :	4.68MHz
Band Edge :	-28.49dBm	Measurement Value :	-25.19dBm

Higher Band Edge Plot on Channel 9538 (1907.6 MHz)

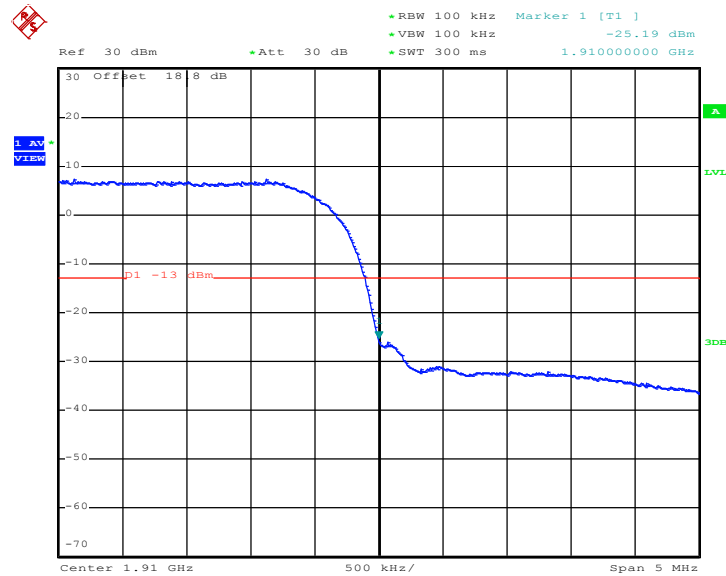

Date: 19.DEC.2012 05:30:58

1. Correction Factor(dB)= $10\log(1\% \text{ Emission BW/RBW})$
2. Band Edge= Measurement Value + Correction Factor(dB)

3.6 Conducted Spurious Emission Measurement

3.6.1 Description of Conducted Spurious Emission Measurement

The power of any emission outside of the authorized operating frequency ranges must be lower than the transmitter power (P) by a factor of at least $43 + 10 \log (P)$ dB.

It is measured by means of a calibrated spectrum analyzer and scanned from 30 MHz up to a frequency including its 10th harmonic.

3.6.2 Measuring Instruments

See list of measuring instruments of this test report.

3.6.3 Test Procedures

1. The EUT was connected to spectrum analyzer and base station via power divider.
2. The RF output of EUT was connected to the spectrum analyzer by RF cable and attenuator. The path loss was compensated to the results for each measurement.
3. The middle channel for the highest RF power within the transmitting frequency was measured.
4. The conducted spurious emission for the whole frequency range was taken.

3.6.4 Test Setup

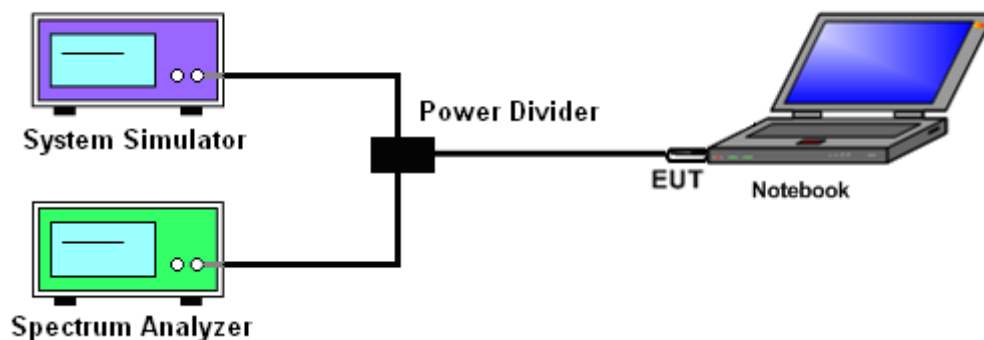



3.6.5 Test Result (Plots) of Conducted Spurious Emission

Band :	GSM850	Channel :	CH189
Test Mode :	GPRS 8 Link	Frequency :	836.4 MHz

Conducted Spurious Emission Plot between 30MHz ~ 1GHz

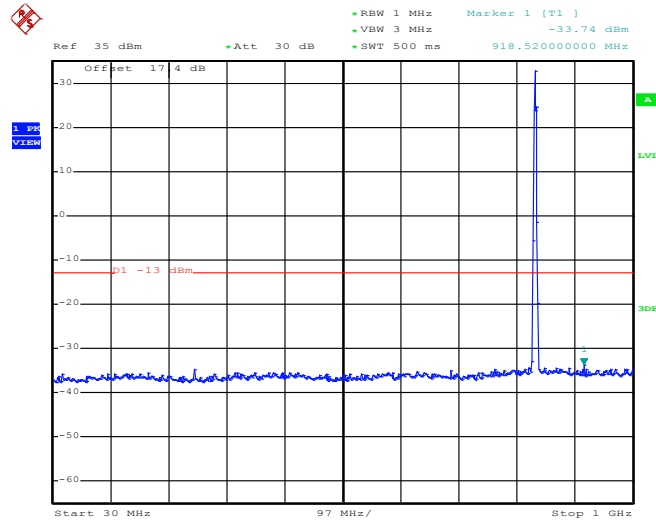

Date: 19.DEC.2012 00:44:02

Conducted Spurious Emission Plot between 1GHz ~ 3GHz

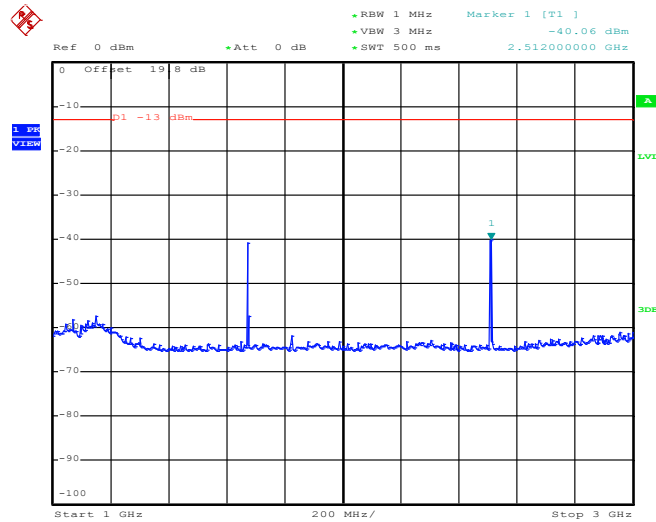

Date: 19.DEC.2012 00:44:20



Conducted Spurious Emission Plot between 3GHz ~ 7GHz

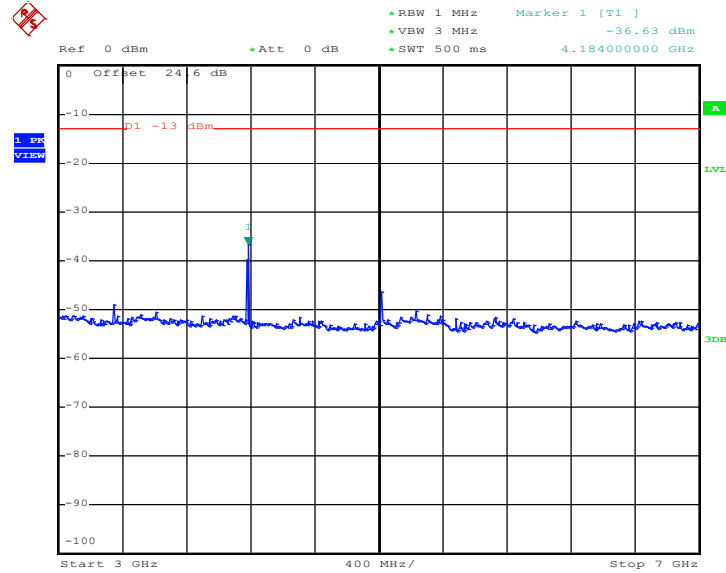

Date: 19.DEC.2012 00:44:32

Conducted Spurious Emission Plot between 7GHz ~ 9GHz

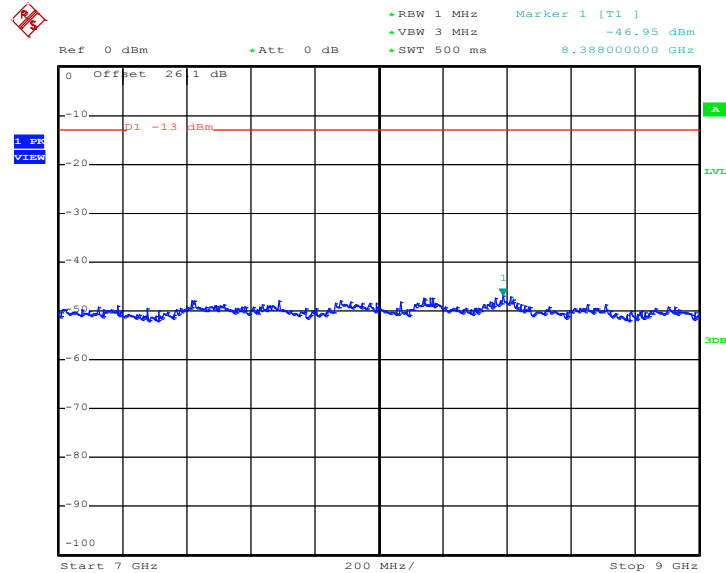

Date: 19.DEC.2012 00:44:44



Band :	GSM850	Channel :	CH189
Test Mode :	EDGE 8 Link	Frequency :	836.4 MHz

Conducted Spurious Emission Plot between 30MHz ~ 1GHz

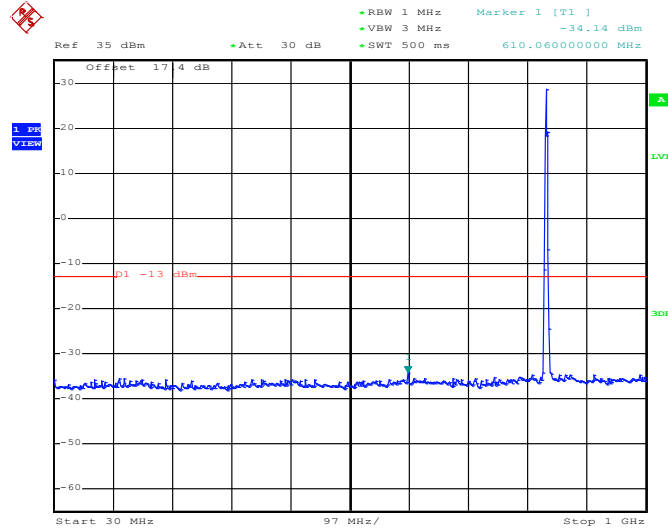

Date: 19.DEC.2012 03:03:14

Conducted Spurious Emission Plot between 1GHz ~ 3GHz

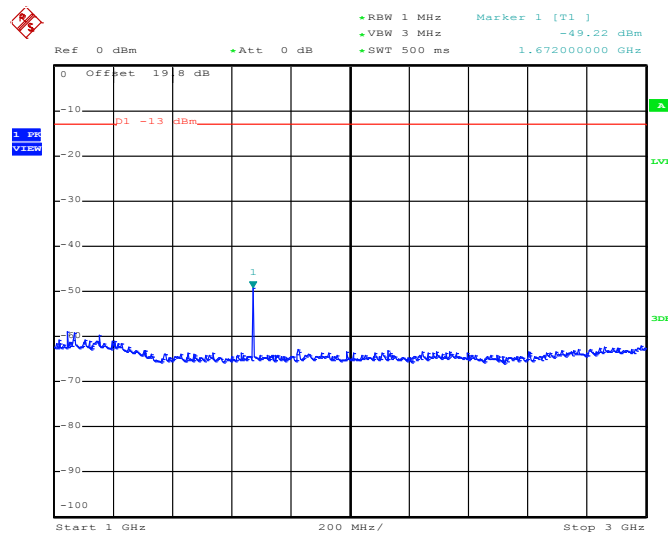

Date: 19.DEC.2012 03:03:28



Conducted Spurious Emission Plot between 3GHz ~ 7GHz

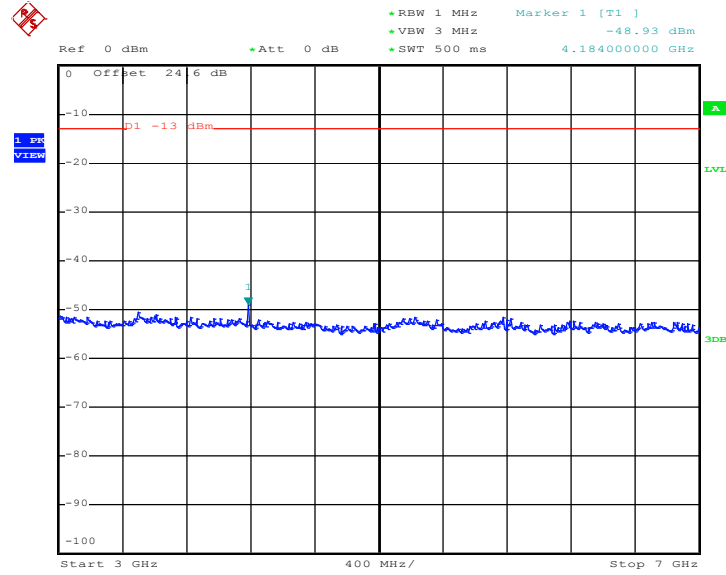

Date: 19.DEC.2012 03:03:37

Conducted Spurious Emission Plot between 7GHz ~ 9GHz

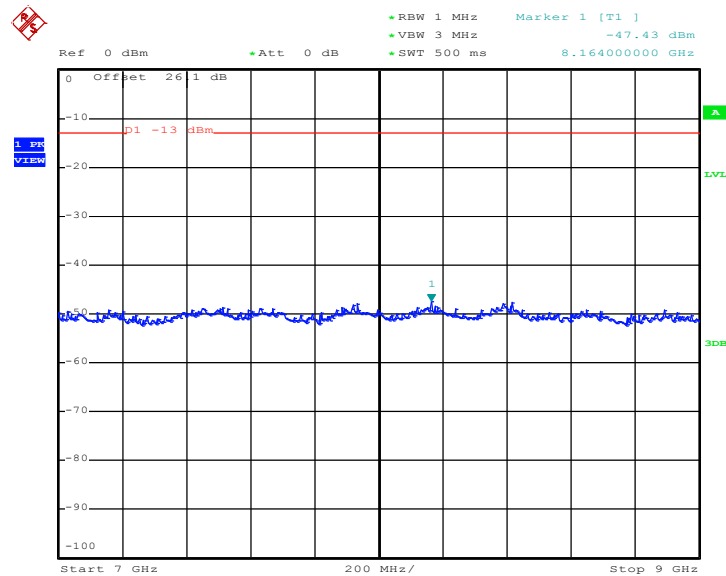

Date: 19.DEC.2012 03:03:47



Band :	GSM1900	Channel :	CH661
Test Mode :	GPRS 8 Link	Frequency :	1880.0 MHz

Conducted Spurious Emission Plot between 30MHz ~ 1GHz

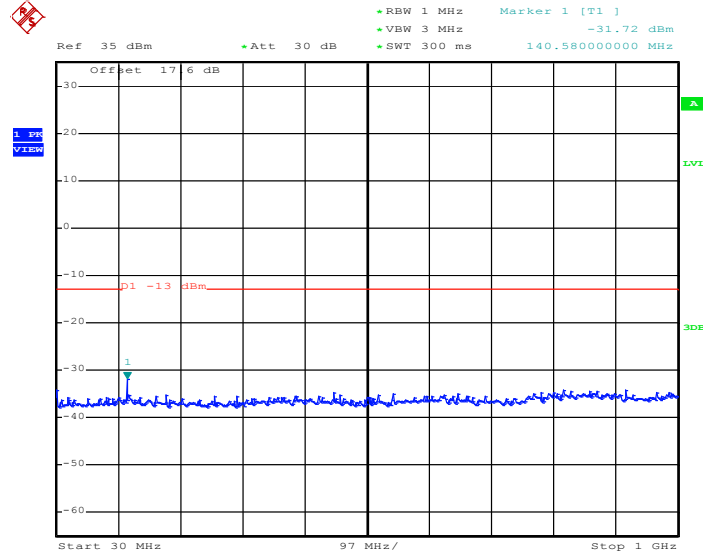

Date: 19.DEC.2012 04:33:59

Conducted Spurious Emission Plot between 1GHz ~ 3GHz

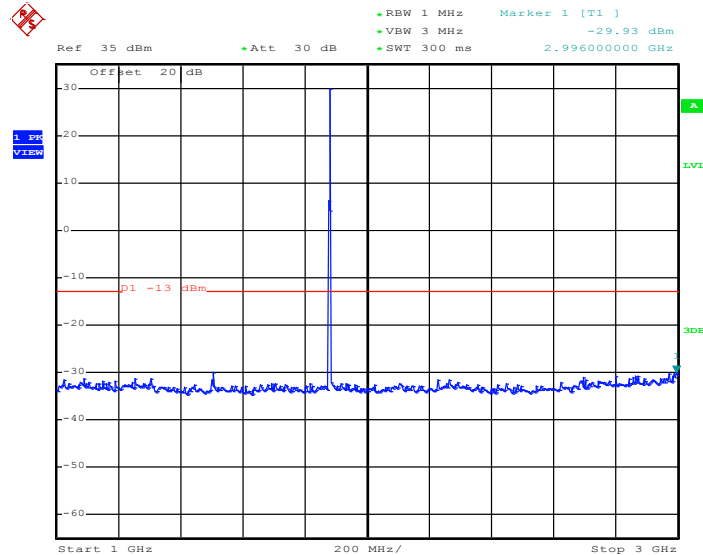

Date: 19.DEC.2012 04:34:08



Conducted Spurious Emission Plot between 3GHz ~ 7GHz

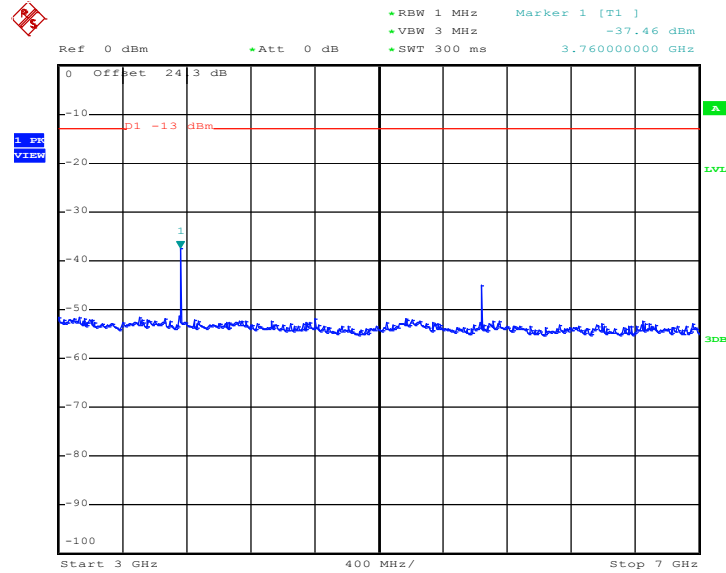

Date: 19.DEC.2012 04:34:25

Conducted Emission Plot between 7GHz ~ 13.6GHz

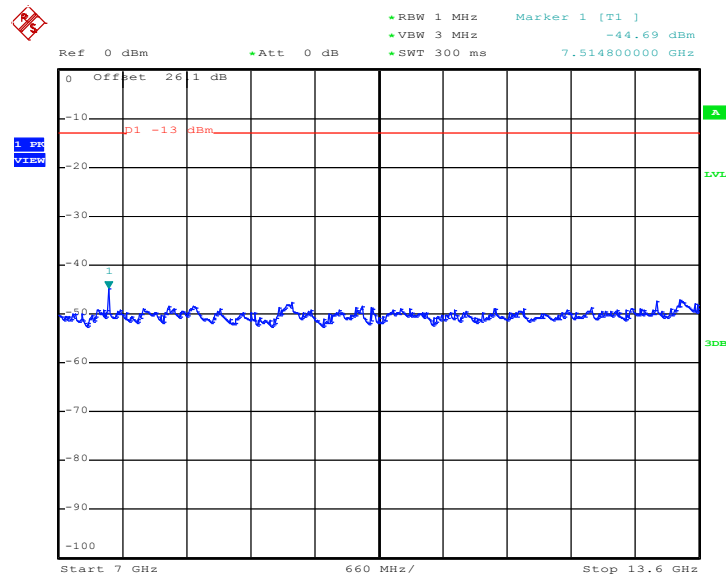

Date: 19.DEC.2012 04:34:34



Conducted Spurious Emission Plot between 13.6GHz ~ 19.1GHz

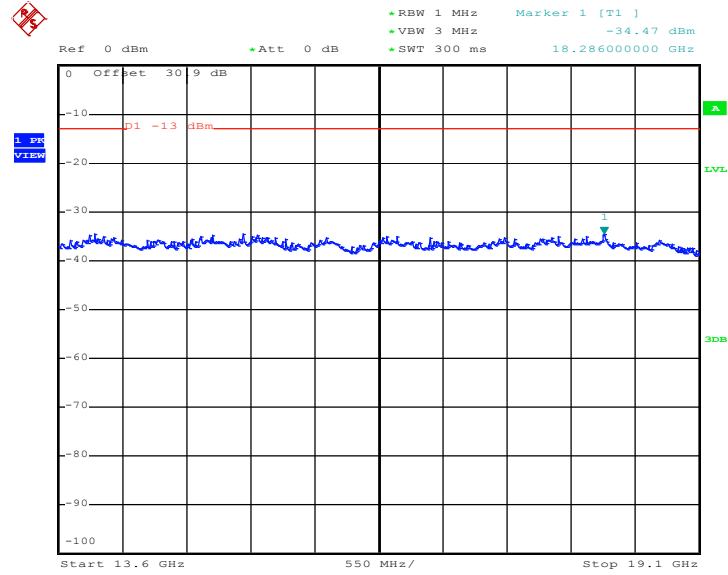

Date: 19.DEC.2012 04:34:44



Band :	GSM1900	Channel :	CH661
Test Mode :	EDGE 8 Link	Frequency :	1880.0 MHz

Conducted Spurious Emission Plot between 30MHz ~ 1GHz

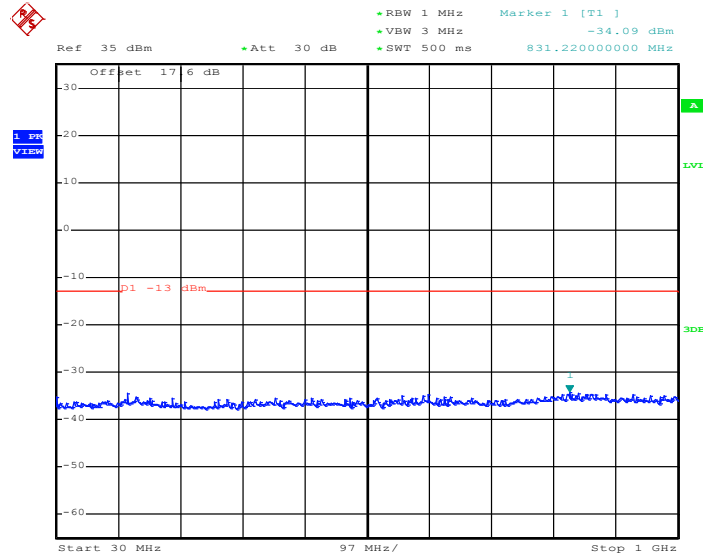

Date: 19.DEC.2012 03:41:18

Conducted Spurious Emission Plot between 1GHz ~ 3GHz

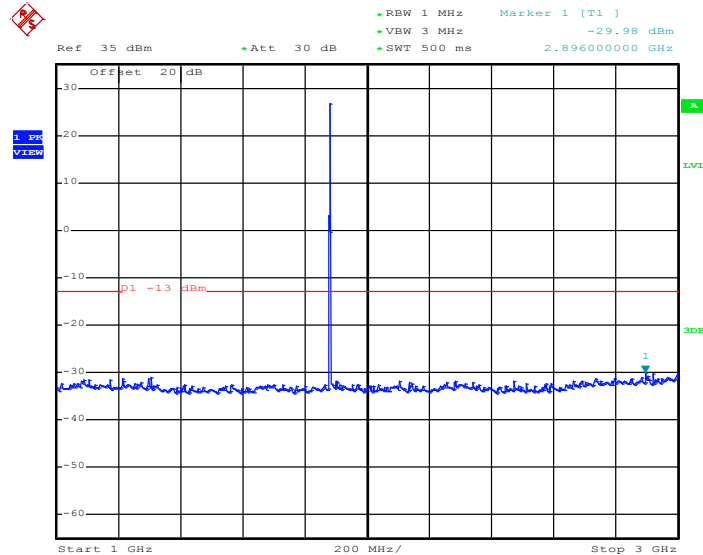

Date: 19.DEC.2012 03:41:27



Conducted Spurious Emission Plot between 3GHz ~ 7GHz

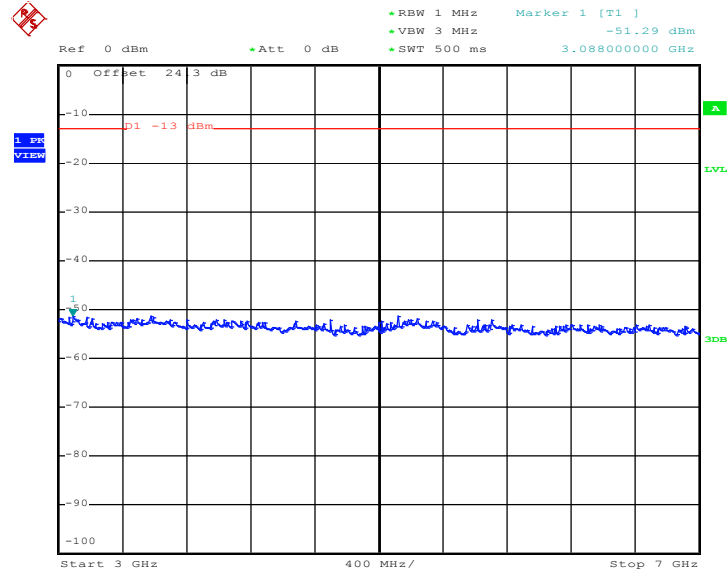

Date: 19.DEC.2012 03:41:41

Conducted Spurious Emission Plot between 7GHz ~ 13.6GHz

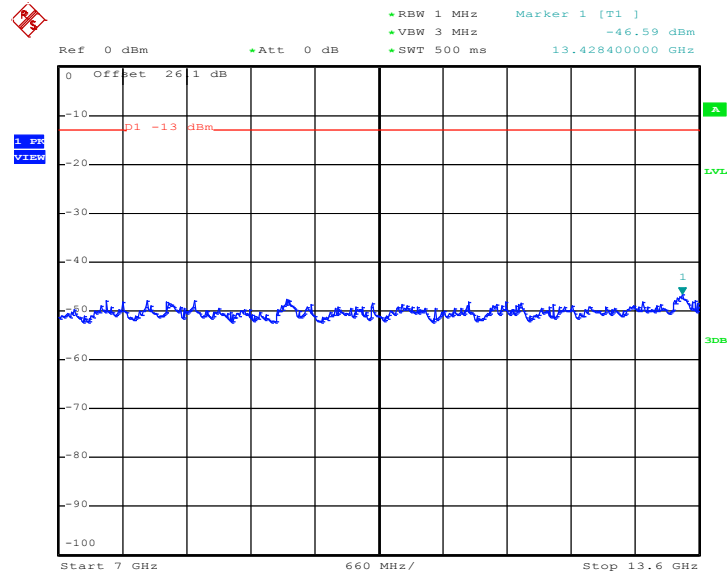

Date: 19.DEC.2012 03:41:51



Conducted Spurious Emission Plot between 13.6GHz ~ 19.1GHz

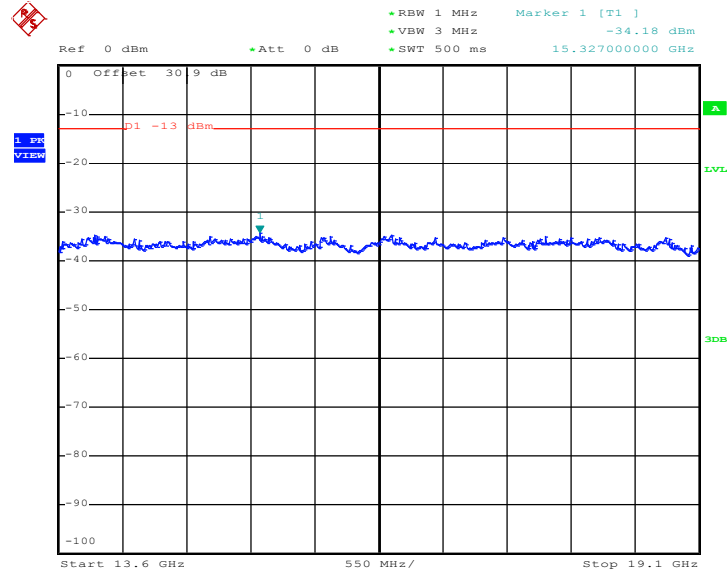

Date: 19.DEC.2012 03:42:00



Band :	WCDMA Band V	Channel :	CH4182
Test Mode :	RMC 12.2Kbps Link	Frequency :	836.4 MHz

Conducted Spurious Emission Plot between 30MHz ~ 1GHz

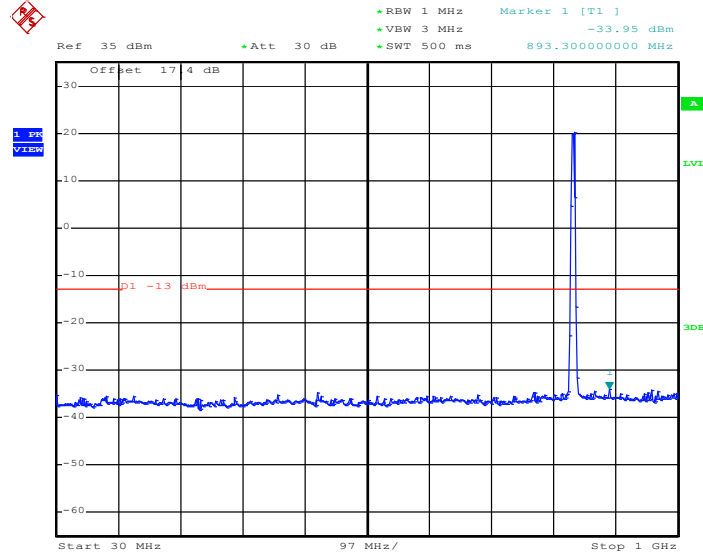

Date: 19.DEC.2012 21:39:25

Conducted Spurious Emission Plot between 1GHz ~ 3GHz

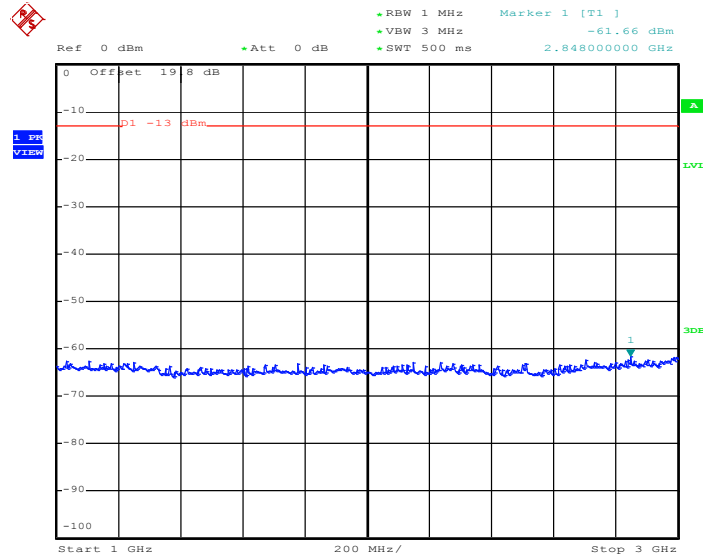

Date: 19.DEC.2012 21:39:39



Conducted Spurious Emission Plot between 3GHz ~ 7GHz

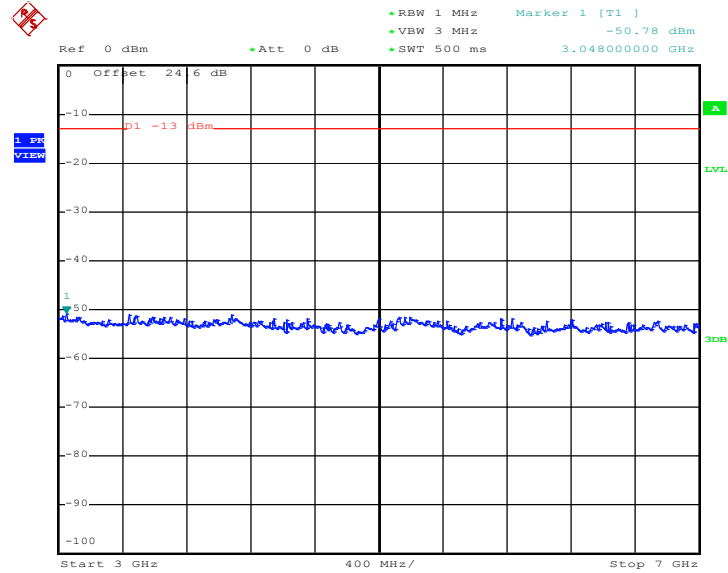

Date: 19.DEC.2012 21:39:48

Conducted Spurious Emission Plot between 7GHz ~ 9GHz

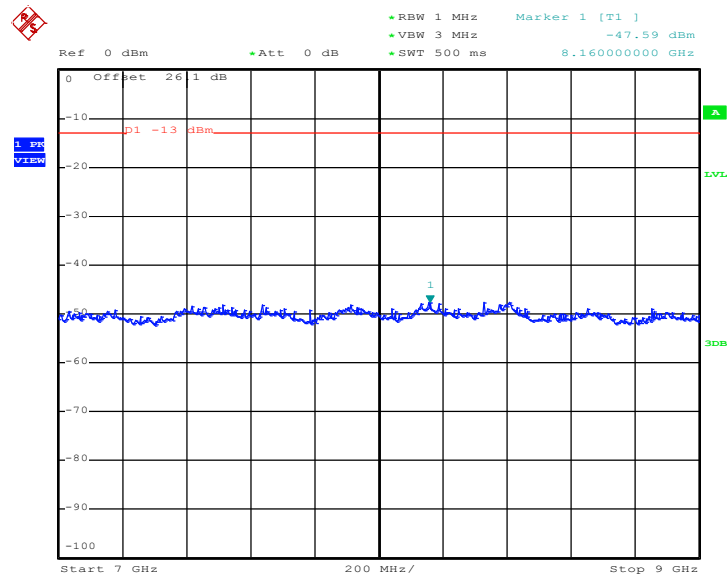

Date: 19.DEC.2012 21:39:58



Band :	WCDMA Band II	Channel :	CH9400
Test Mode :	RMC 12.2Kbps Link	Frequency :	1880.0 MHz

Conducted Spurious Emission Plot between 30MHz ~ 1GHz

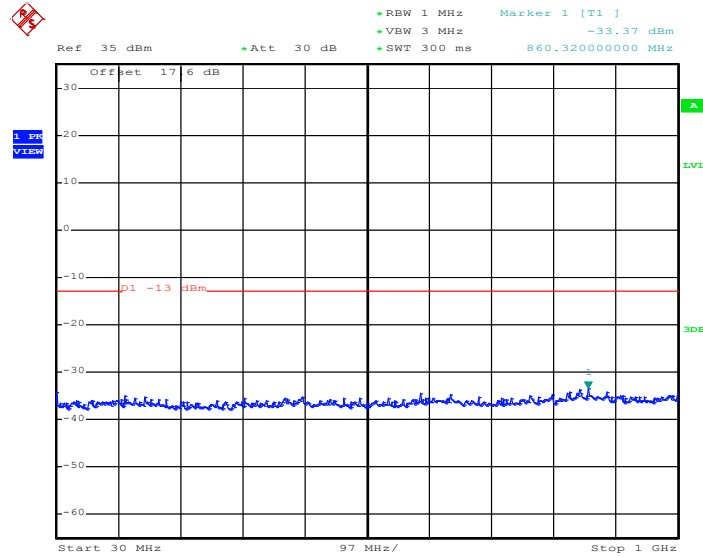

Date: 19.DEC.2012 05:10:45

Conducted Spurious Emission Plot between 1GHz ~ 3GHz

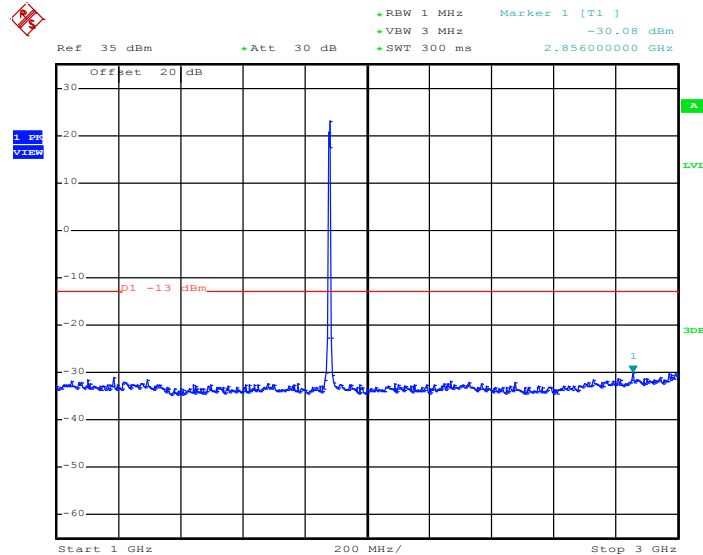

Date: 19.DEC.2012 05:10:55



Conducted Spurious Emission Plot between 3GHz ~ 7GHz

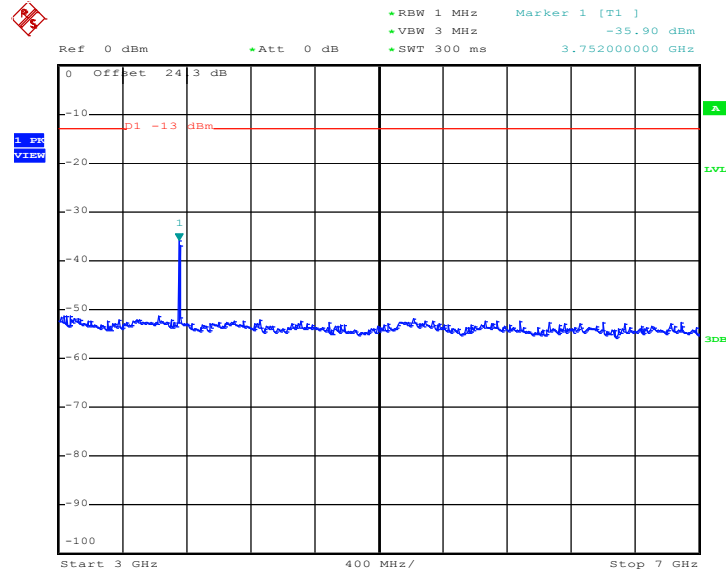

Date: 19.DEC.2012 05:11:08

Conducted Spurious Emission Plot between 7GHz ~ 13.6GHz

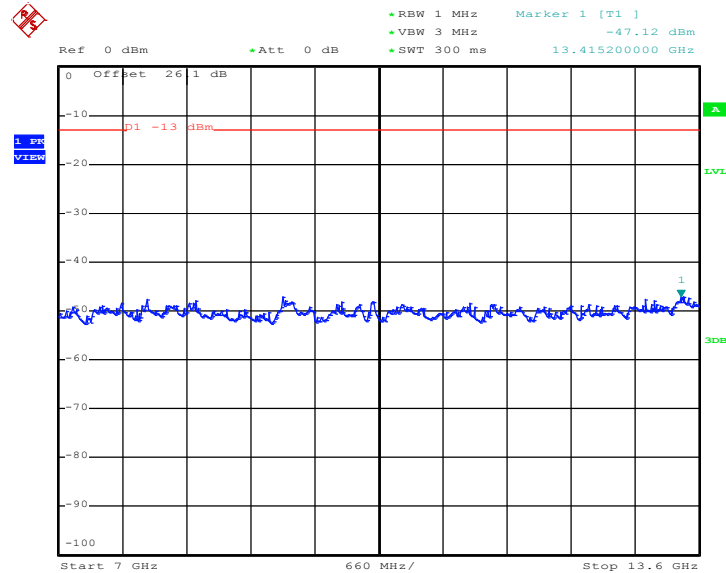

Date: 19.DEC.2012 05:11:17



Conducted Spurious Emission Plot between 13.6GHz ~ 19.1GHz

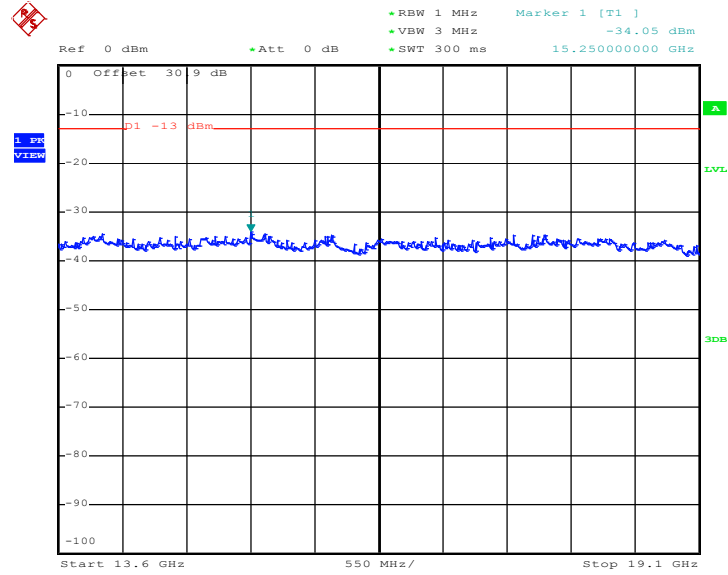

Date: 19.DEC.2012 05:11:26



3.7 Field Strength of Spurious Radiation Measurement

3.7.1 Description of Field Strength of Spurious Radiated Measurement

The power of any emission outside of the authorized operating frequency ranges must be attenuated below the transmitter power (P) by a factor of at least $43 + 10 \log (P)$ dB. The spectrum is scanned from 30 MHz up to a frequency including its 10th harmonic.

3.7.2 Measuring Instruments

See list of measuring instruments of this test report.

3.7.3 Test Procedures

1. The EUT was placed on a rotatable wooden table with 0.8 meter above ground.
2. The EUT was set 3 meters from the receiving antenna, which was mounted on the antenna tower.
3. The table was rotated 360 degrees to determine the position of the highest spurious emission.
4. The height of the receiving antenna is varied between one meter and four meters to search the maximum spurious emission for both horizontal and vertical polarizations.
5. Make the measurement with the spectrum analyzer's RBW = 1MHz, VBW = 3MHz, taking the record of maximum spurious emission.
6. A horn antenna was substituted in place of the EUT and was driven by a signal generator.
7. Tune the output power of signal generator to the same emission level with EUT maximum spurious emission.
8. Taking the record of output power at antenna port.
9. Repeat step 7 to step 8 for another polarization.
10. The RF fundamental frequency should be excluded against the limit line in the operating frequency band.
11. The limit line is derived from $43 + 10\log(P)$ dB below the transmitter power P(Watts)
 $= P(W) - [43 + 10\log(P)]$ (dB)
 $= [30 + 10\log(P)]$ (dBm) - $[43 + 10\log(P)]$ (dB)
 $= -13\text{dBm}$.
12. EIRP (dBm) = S.G. Power – Tx Cable Loss + Tx Antenna Gain
13. ERP (dBm) = EIRP - 2.15

3.7.4 Test Setup

For radiated emissions below 30MHz

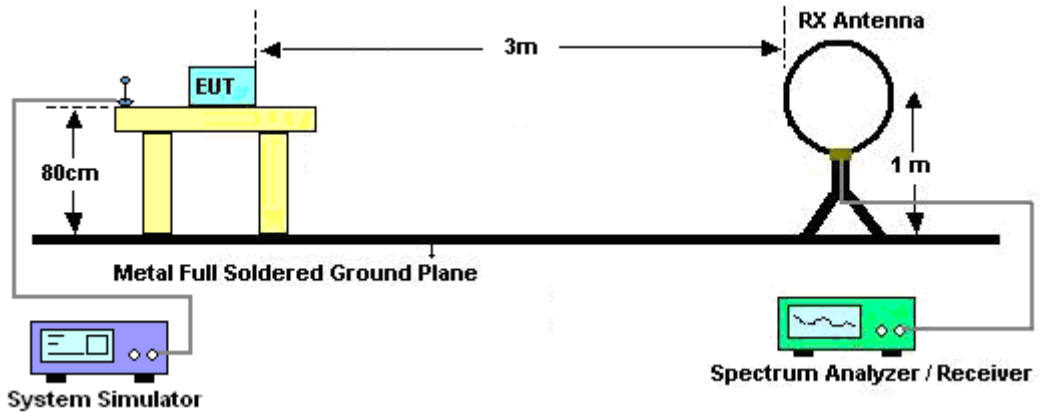

For radiated emissions from 30MHz to 1GHz

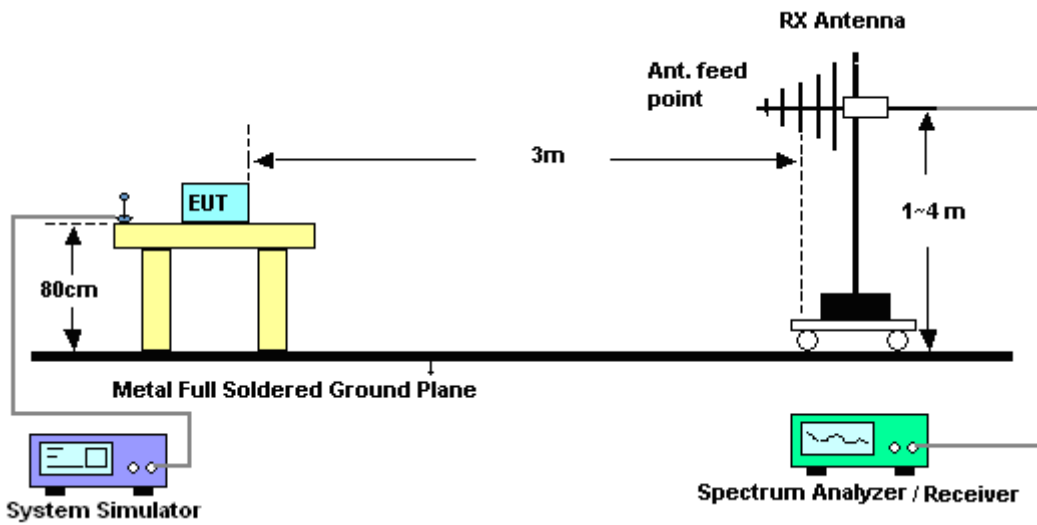

For radiated emissions above 1GHz

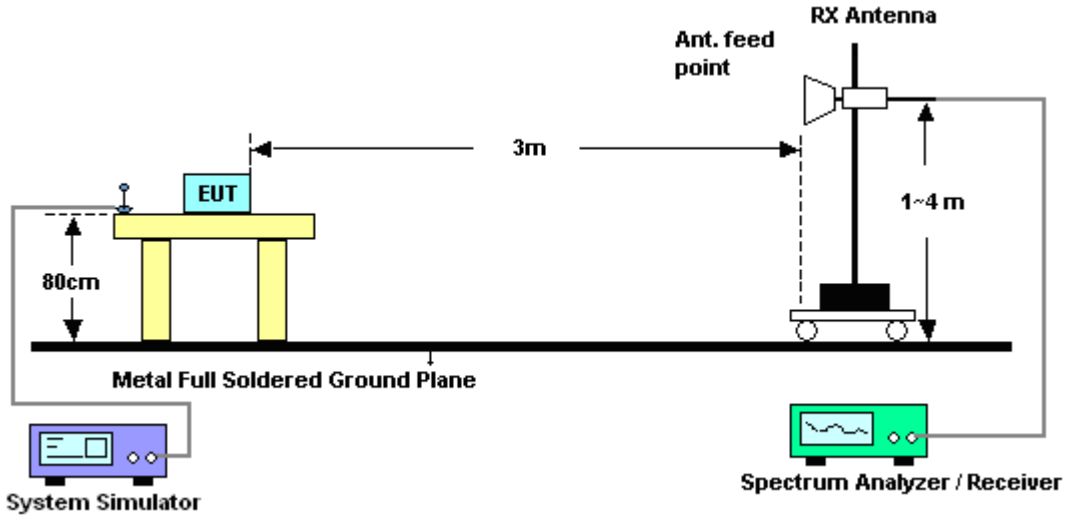

3.7.5 Test Results of Radiated Emissions (9 KHz ~ 30 MHz)

The low frequency, which started from 9 KHz to 30MHz, was pre-scanned and the result which was 20dB lower than the limit line was not reported.



3.7.6 Test Result of Field Strength of Spurious Radiated

Band :	GSM850	Temperature :	23~24°C
Test Mode :	GPRS 8 Link	Relative Humidity :	49~50%
Test Engineer :	Marlboro Hsu and Ivan Chiang	Polarization :	Horizontal
Remark :	Spurious emissions within 30-1000MHz were found more than 20dB below limit line.		

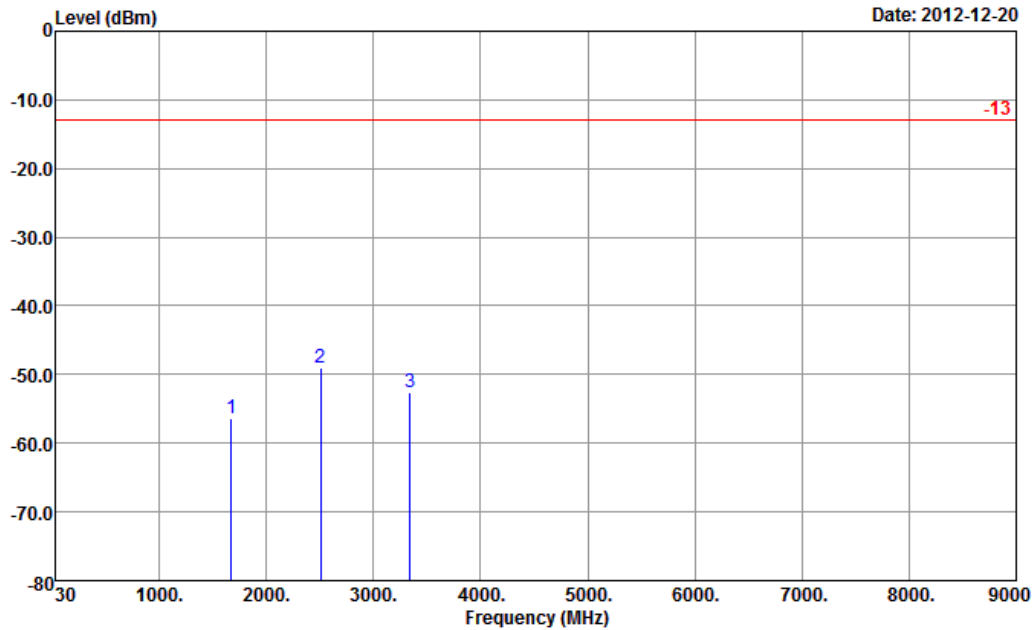

Site : 03CH07-HY
 Condition : -13 HF-EIRP(080306) HORIZONTAL
 Power : From System(Used NB)

Frequency (MHz)	ERP (dBm)	Limit (dBm)	Over Limit (dB)	SPA Reading (dBm)	S.G. Power (dBm)	TX Cable loss (dB)	TX Antenna Gain (dBi)	Polarization (H/V)	Result
1672	-56.39	-13	-43.39	-65.41	-58.11	1.62	5.49	H	Pass
2509	-49.09	-13	-36.09	-62.4	-51.06	2.1	6.22	H	Pass
3345	-52.56	-13	-39.56	-66.69	-55.45	3.03	8.07	H	Pass



Band :	GSM850	Temperature :	23~24°C
Test Mode :	GPRS 8 Link	Relative Humidity :	49~50%
Test Engineer :	Marlboro Hsu and Ivan Chiang	Polarization :	Vertical
Remark :	Spurious emissions within 30-1000MHz were found more than 20dB below limit line.		

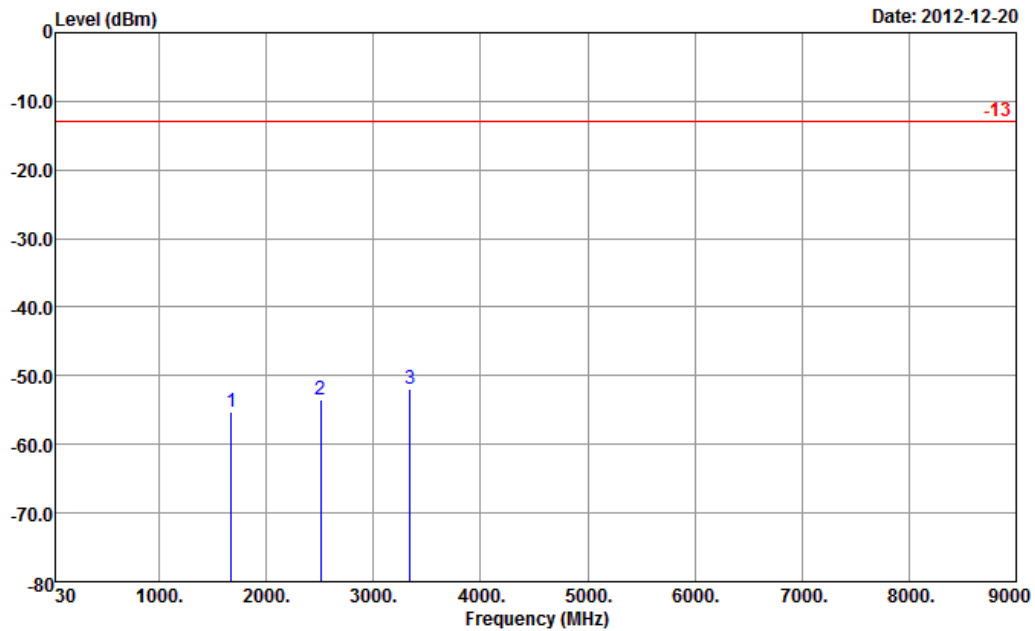

Site : 03CH07-HY
 Condition : -13 HF-EIRP(080306) VERTICAL
 Power : From System(Used NB)

Frequency (MHz)	ERP (dBm)	Limit (dBm)	Over Limit (dB)	SPA Reading (dBm)	S.G. Power (dBm)	TX Cable loss (dB)	TX Antenna Gain (dBi)	Polarization (H/V)	Result
1672	-55.37	-13	-42.37	-66.59	-57.09	1.62	5.49	V	Pass
2509	-53.46	-13	-40.46	-67.41	-55.43	2.1	6.22	V	Pass
3345	-51.83	-13	-38.83	-67.49	-54.72	3.03	8.07	V	Pass



Band :	GSM850	Temperature :	23~24°C
Test Mode :	EDGE 8 Link	Relative Humidity :	49~50%
Test Engineer :	Marlboro Hsu and Ivan Chiang	Polarization :	Horizontal
Remark :	Spurious emissions within 30-1000MHz were found more than 20dB below limit line.		

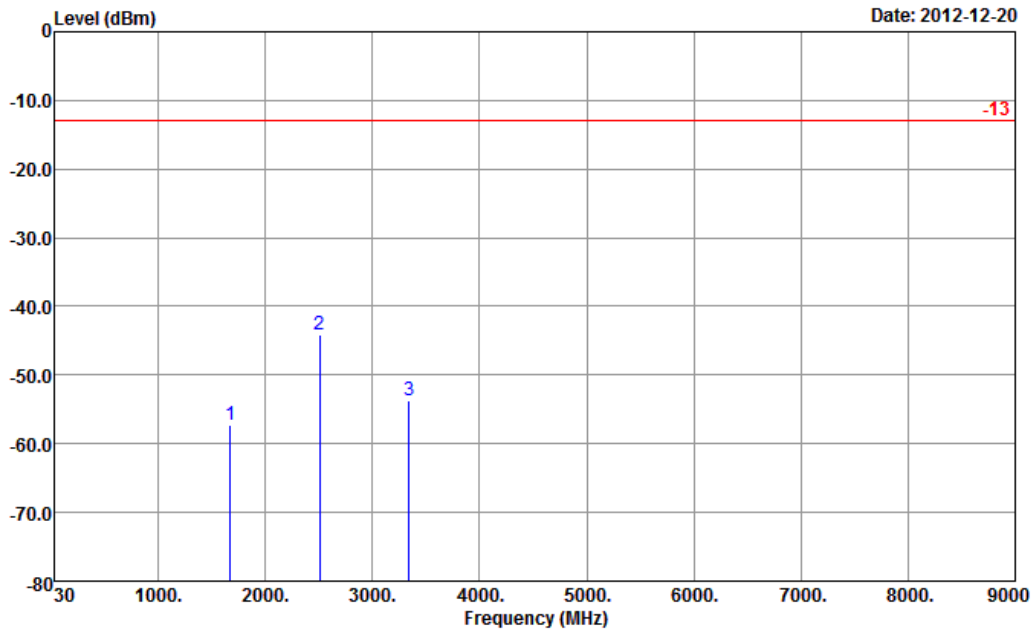

Site : 03CH07-HY
 Condition : -13 HF-EIRP(080306) HORIZONTAL
 Power : From System(Used NB)

Frequency (MHz)	ERP (dBm)	Limit (dBm)	Over Limit (dB)	SPA Reading (dBm)	S.G. Power (dBm)	TX Cable loss (dB)	TX Antenna Gain (dBi)	Polarization (H/V)	Result
1672	-57.36	-13	-44.36	-66.33	-59.08	1.62	5.49	H	Pass
2509	-44.06	-13	-31.06	-57.41	-46.03	2.1	6.22	H	Pass
3345	-53.73	-13	-40.73	-67.86	-56.62	3.03	8.07	H	Pass



Band :	GSM850	Temperature :	23~24°C
Test Mode :	EDGE 8 Link	Relative Humidity :	49~50%
Test Engineer :	Marlboro Hsu and Ivan Chiang	Polarization :	Vertical
Remark :	Spurious emissions within 30-1000MHz were found more than 20dB below limit line.		

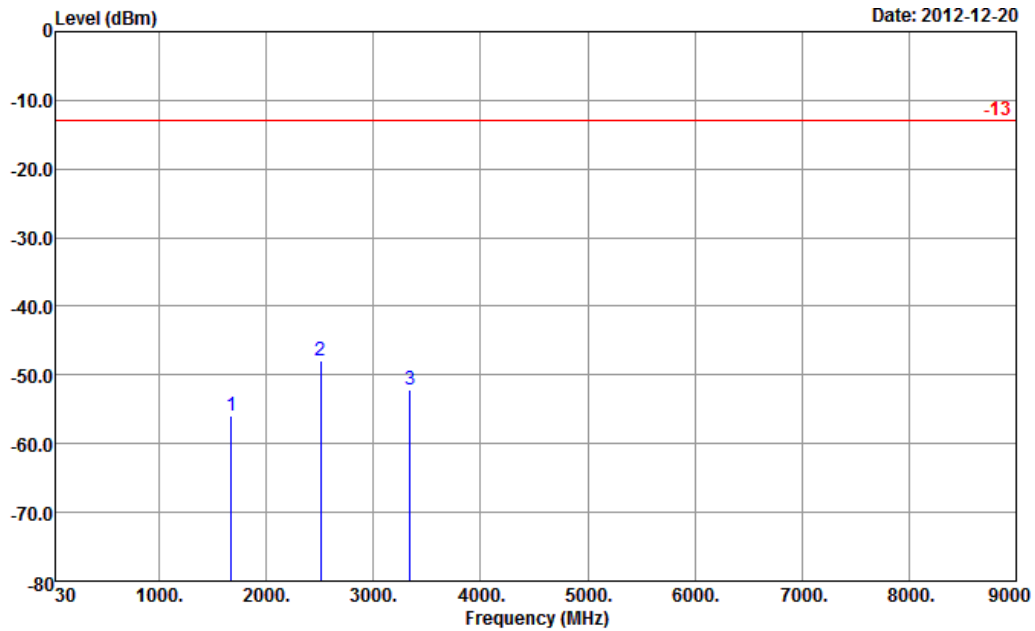

Site : 03CH07-HY
 Condition : -13 HF-EIRP(080306) VERTICAL
 Power : From System(Used NB)

Frequency (MHz)	ERP (dBm)	Limit (dBm)	Over Limit (dB)	SPA Reading (dBm)	S.G. Power (dBm)	TX Cable loss (dB)	TX Antenna Gain (dBi)	Polarization (H/V)	Result
1672	-55.90	-13	-42.90	-67.12	-57.62	1.62	5.49	V	Pass
2509	-47.91	-13	-34.91	-60.76	-49.88	2.1	6.22	V	Pass
3345	-52.11	-13	-39.11	-67.76	-55	3.03	8.07	V	Pass



Band :	GSM1900	Temperature :	23~24°C
Test Mode :	GPRS 8 Link	Relative Humidity :	49~50%
Test Engineer :	Marlboro Hsu and Ivan Chiang	Polarization :	Horizontal
Remark :	Spurious emissions within 30-1000MHz were found more than 20dB below limit line.		

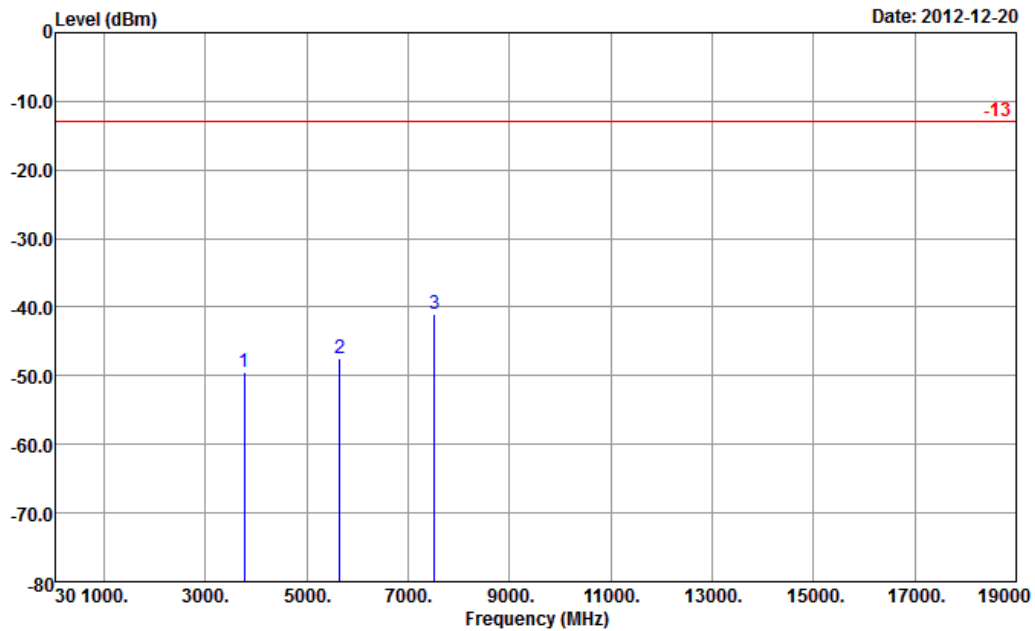

Site : 03CH07-HY
 Condition : -13 HF-EIRP(080306) HORIZONTAL
 Power : From System(Used NB)

Frequency (MHz)	EIRP (dBm)	Limit (dBm)	Over Limit (dB)	SPA Reading (dBm)	S.G. Power (dBm)	TX Cable loss (dB)	TX Antenna Gain (dBi)	Polarization (H/V)	Result
3760	-49.44	-13	-36.44	-64.81	-55.74	2.51	8.81	H	Pass
5640	-47.43	-13	-34.43	-68.26	-55.14	2.99	10.70	H	Pass
7520	-41.08	-13	-28.08	-68.4	-49.61	3.59	12.12	H	Pass



Band :	GSM1900	Temperature :	23~24°C
Test Mode :	GPRS 8 Link	Relative Humidity :	49~50%
Test Engineer :	Marlboro Hsu and Ivan Chiang	Polarization :	Vertical
Remark :	Spurious emissions within 30-1000MHz were found more than 20dB below limit line.		

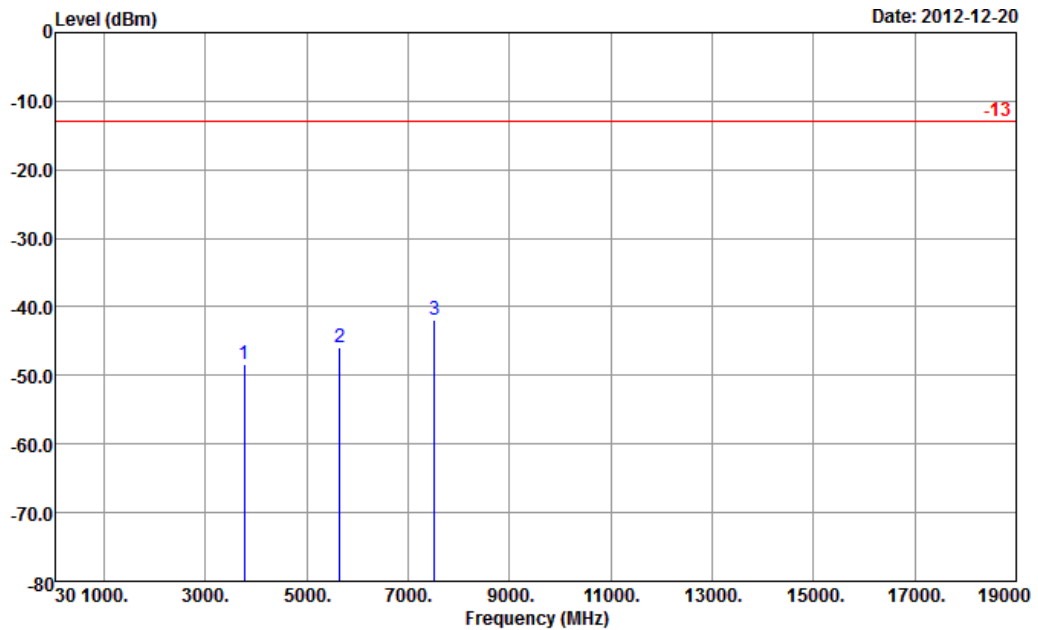

Site : 03CH07-HY
 Condition : -13 HF-EIRP(080306) VERTICAL
 Power : From System(Used NB)

Frequency (MHz)	EIRP (dBm)	Limit (dBm)	Over Limit (dB)	SPA Reading (dBm)	S.G. Power (dBm)	TX Cable loss (dB)	TX Antenna Gain (dBi)	Polarization (H/V)	Result
3760	-48.28	-13	-35.28	-64.67	-54.58	2.51	8.81	V	Pass
5640	-46.01	-13	-33.01	-66.61	-53.72	2.99	10.70	V	Pass
7520	-41.80	-13	-28.80	-68.99	-50.33	3.59	12.12	V	Pass



Band :	GSM1900	Temperature :	23~24°C
Test Mode :	EDGE 8 Link	Relative Humidity :	49~50%
Test Engineer :	Marlboro Hsu and Ivan Chiang	Polarization :	Horizontal
Remark :	Spurious emissions within 30-1000MHz were found more than 20dB below limit line.		

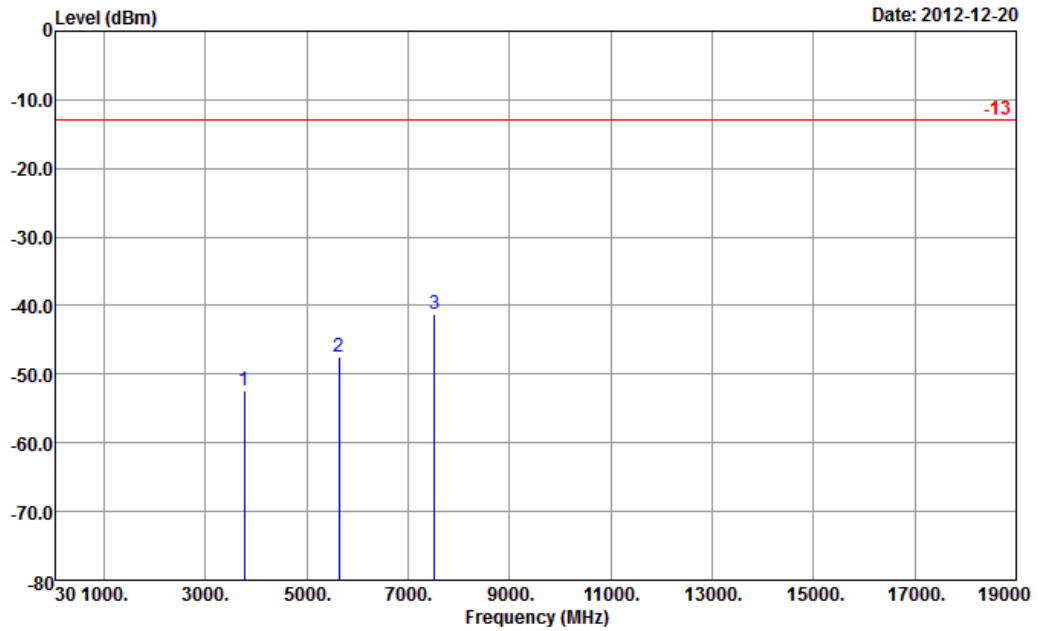

Site : 03CH07-HY
 Condition : -13 HF-EIRP(080306) HORIZONTAL
 Power : From System(Used NB)

Frequency (MHz)	EIRP (dBm)	Limit (dBm)	Over Limit (dB)	SPA Reading (dBm)	S.G. Power (dBm)	TX Cable loss (dB)	TX Antenna Gain (dBi)	Polarization (H/V)	Result
3760	-52.40	-13	-39.40	-67.92	-58.7	2.51	8.81	H	Pass
5636	-47.52	-13	-34.52	-68.34	-55.23	2.99	10.70	H	Pass
7520	-41.19	-13	-28.19	-68.52	-49.72	3.59	12.12	H	Pass



Band :	GSM1900	Temperature :	23~24°C
Test Mode :	EDGE 8 Link	Relative Humidity :	49~50%
Test Engineer :	Marlboro Hsu and Ivan Chiang	Polarization :	Vertical
Remark :	Spurious emissions within 30-1000MHz were found more than 20dB below limit line.		

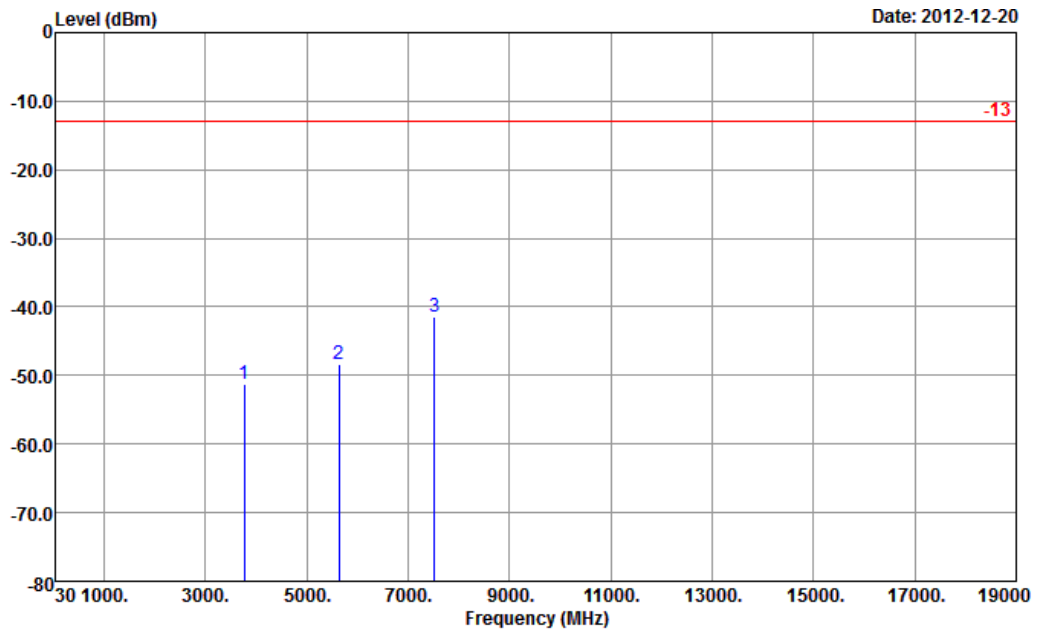

Site : 03CH07-HY
 Condition : -13 HF-EIRP(080306) VERTICAL
 Power : From System(Used NB)

Frequency (MHz)	EIRP (dBm)	Limit (dBm)	Over Limit (dB)	SPA Reading (dBm)	S.G. Power (dBm)	TX Cable loss (dB)	TX Antenna Gain (dBi)	Polarization (H/V)	Result
3760	-51.24	-13	-38.24	-67.64	-57.54	2.51	8.81	V	Pass
5636	-48.36	-13	-35.36	-68.96	-56.07	2.99	10.70	V	Pass
7520	-41.47	-13	-28.47	-68.56	-50	3.59	12.12	V	Pass



Band :	WCDMA Band V	Temperature :	23~24°C
Test Mode :	RMC 12.2Kbps Link	Relative Humidity :	49~50%
Test Engineer :	Marlboro Hsu and Ivan Chiang	Polarization :	Horizontal
Remark :	Spurious emissions within 30-1000MHz were found more than 20dB below limit line.		

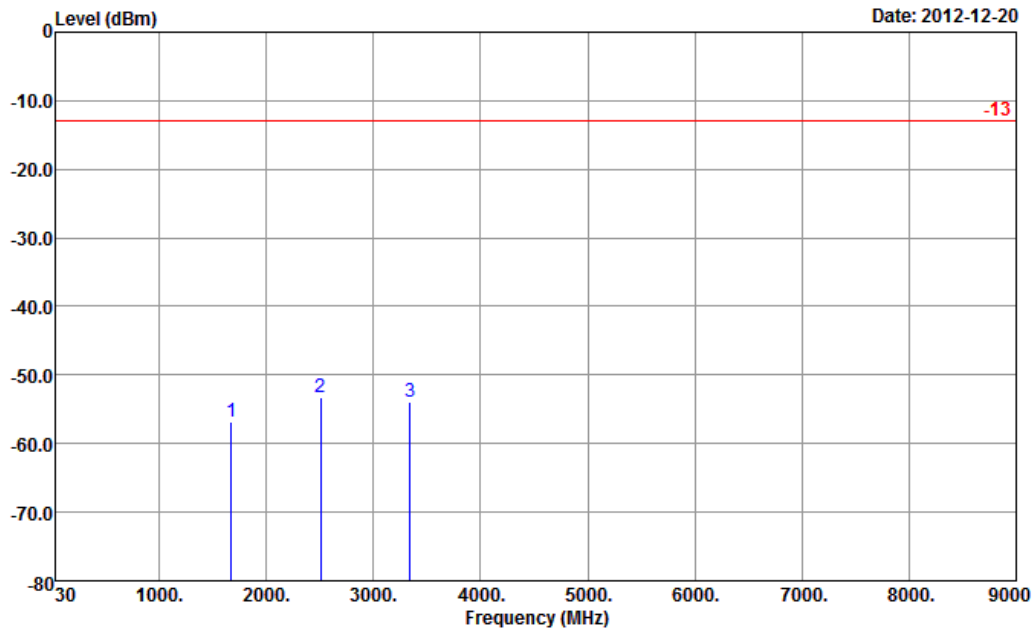

Site : 03CH07-HY
 Condition : -13 HF-EIRP(080306) HORIZONTAL
 Power : From System(Used NB)

Frequency (MHz)	ERP (dBm)	Limit (dBm)	Over Limit (dB)	SPA Reading (dBm)	S.G. Power (dBm)	TX Cable loss (dB)	TX Antenna Gain (dBi)	Polarization (H/V)	Result
1672	-56.86	-13	-43.86	-65.9	-58.58	1.62	5.49	H	Pass
2509	-53.15	-13	-40.15	-66.5	-55.12	2.1	6.22	H	Pass
3345	-53.85	-13	-40.85	-68.04	-56.74	3.03	8.07	H	Pass



Band :	WCDMA Band V	Temperature :	23~24°C
Test Mode :	RMC 12.2Kbps Link	Relative Humidity :	49~50%
Test Engineer :	Marlboro Hsu and Ivan Chiang	Polarization :	Vertical
Remark :	Spurious emissions within 30-1000MHz were found more than 20dB below limit line.		

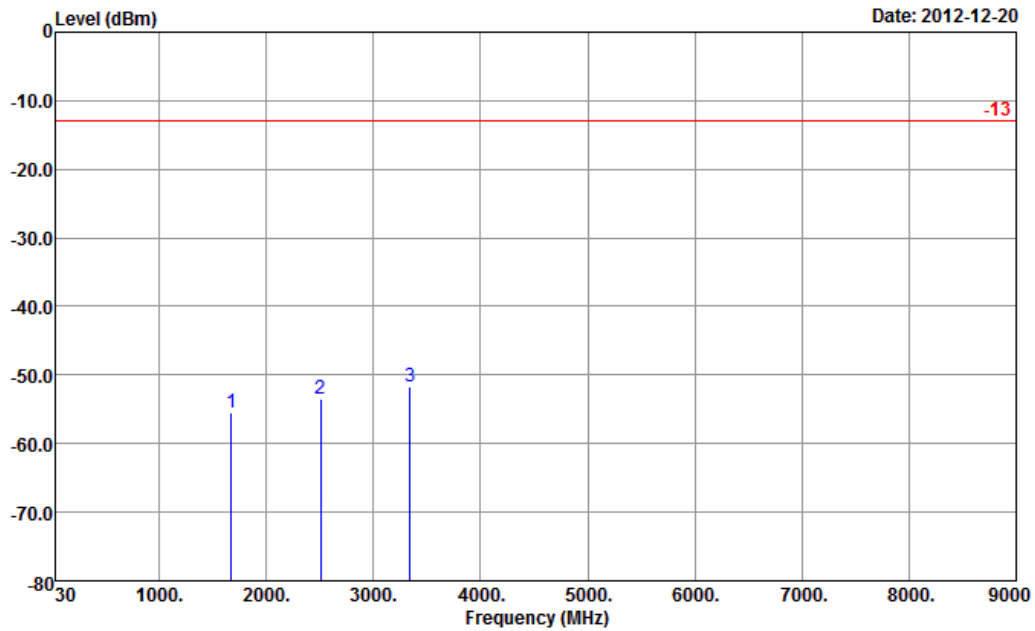

Site : 03CH07-HY
 Condition : -13 HF-EIRP(080306) VERTICAL
 Power : From System(Used NB)

Frequency (MHz)	ERP (dBm)	Limit (dBm)	Over Limit (dB)	SPA Reading (dBm)	S.G. Power (dBm)	TX Cable loss (dB)	TX Antenna Gain (dBi)	Polarization (H/V)	Result
1672	-55.54	-13	-42.54	-66.77	-57.26	1.62	5.49	V	Pass
2509	-53.44	-13	-40.44	-67.25	-55.41	2.1	6.22	V	Pass
3345	-51.68	-13	-38.68	-67.29	-54.57	3.03	8.07	V	Pass



Band :	WCDMA Band II	Temperature :	23~24°C
Test Mode :	RMC 12.2Kbps Link	Relative Humidity :	49~50%
Test Engineer :	Marlboro Hsu and Ivan Chiang	Polarization :	Horizontal
Remark :	Spurious emissions within 30-1000MHz were found more than 20dB below limit line.		

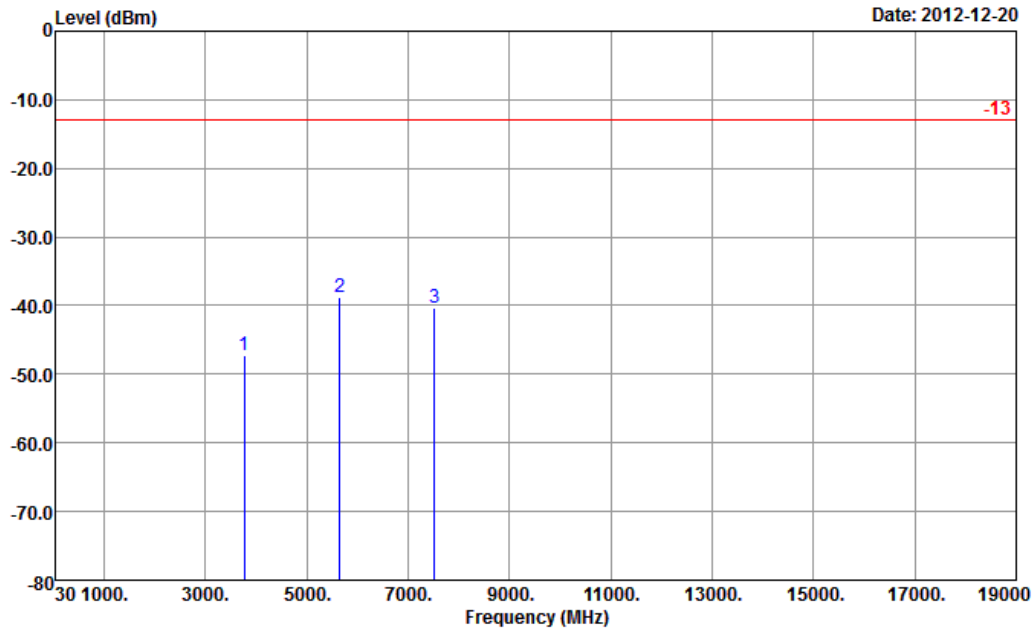

Site : 03CH07-HY
 Condition : -13 HF-EIRP(080306) HORIZONTAL
 Power : From System(Used NB)

Frequency (MHz)	EIRP (dBm)	Limit (dBm)	Over Limit (dB)	SPA Reading (dBm)	S.G. Power (dBm)	TX Cable loss (dB)	TX Antenna Gain (dBi)	Polarization (H/V)	Result
3756	-47.26	-13	-34.26	-62.84	-53.56	2.51	8.81	H	Pass
5640	-38.67	-13	-25.67	-59.74	-46.38	2.99	10.70	H	Pass
7520	-40.34	-13	-27.34	-67.7	-48.87	3.59	12.12	H	Pass



Band :	WCDMA Band II	Temperature :	23~24°C
Test Mode :	RMC 12.2Kbps Link	Relative Humidity :	49~50%
Test Engineer :	Marlboro Hsu and Ivan Chiang	Polarization :	Vertical
Remark :	Spurious emissions within 30-1000MHz were found more than 20dB below limit line.		

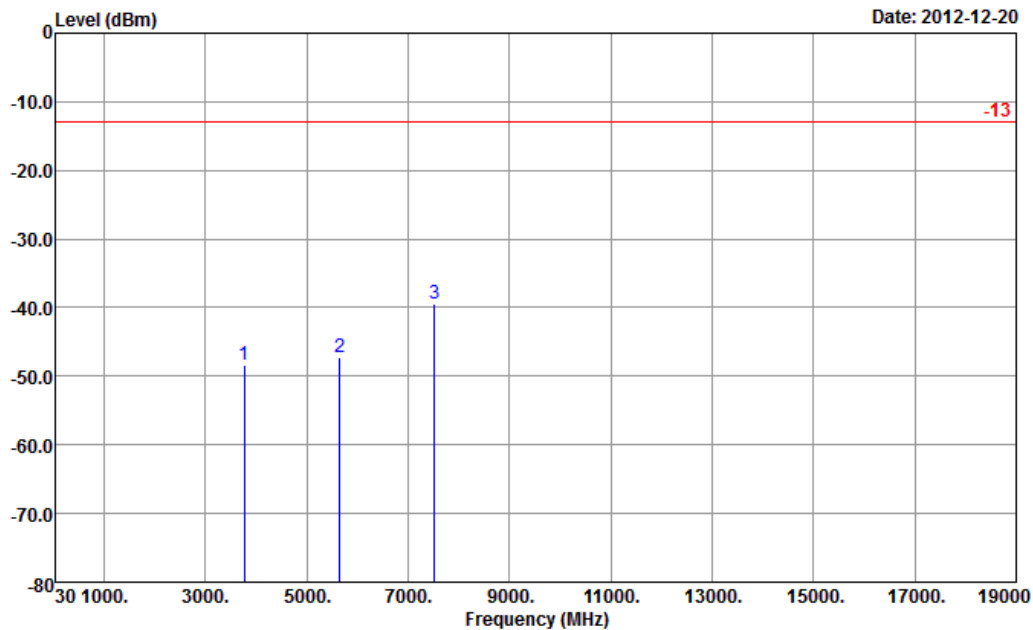

Site : 03CH07-HY
 Condition : -13 HF-EIRP(080306) VERTICAL
 Power : From System(Used NB)

Frequency (MHz)	EIRP (dBm)	Limit (dBm)	Over Limit (dB)	SPA Reading (dBm)	S.G. Power (dBm)	TX Cable loss (dB)	TX Antenna Gain (dBi)	Polarization (H/V)	Result
3760	-48.39	-13	-35.39	-64.91	-54.69	2.51	8.81	V	Pass
5640	-47.30	-13	-34.30	-67.89	-55.01	2.99	10.70	V	Pass
7520	-39.35	-13	-26.35	-66.48	-47.88	3.59	12.12	V	Pass

3.8 Frequency Stability Measurement

3.8.1 Description of Frequency Stability Measurement

The frequency stability shall be measured by variation of ambient temperature and variation of primary supply voltage to ensure that the fundamental emission stays within the authorized frequency block. The frequency stability of the transmitter shall be maintained within $\pm 0.00025\%$ ($\pm 2.5\text{ppm}$) of the center frequency.

3.8.2 Measuring Instruments

See list of measuring instruments of this test report.

3.8.3 Test Procedures for Temperature Variation

1. The EUT was set up in the thermal chamber and connected with the base station.
2. With power OFF, the temperature was decreased to -30°C and the EUT was stabilized before testing. Power was applied and the maximum change in frequency was recorded within one minute.
3. With power OFF, the temperature was raised in 10°C step up to 50°C . The EUT was stabilized at each step for at least half an hour. Power was applied and the maximum frequency change was recorded within one minute.
4. If the EUT cannot be turned on at -30°C , the testing lowest temperature will be raised in 10°C step until the EUT can be turned on.

3.8.4 Test Procedures for Voltage Variation

1. The EUT was placed in a temperature chamber at $25\pm 5^{\circ}\text{C}$ and connected with the base station.
2. The power supply voltage to the EUT was varied from BEP to 115% of the nominal value measured at the input to the EUT.
3. The variation in frequency was measured for the worst case.

3.8.5 Test Setup

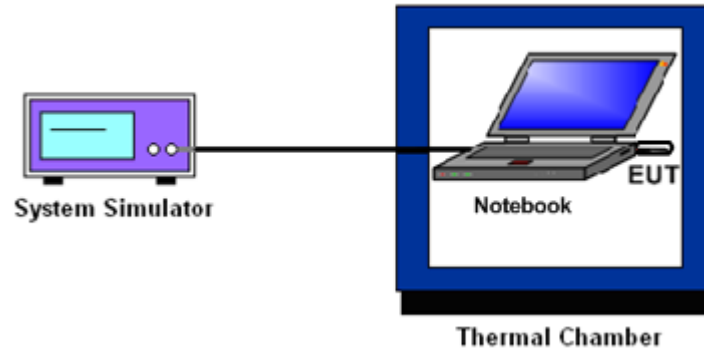



3.8.6 Test Result of Temperature Variation

Band :	GSM 850	Channel :	189
Limit (ppm) :	2.5	Frequency :	836.4 MHz

Temperature (°C)	GPRS 8		EDGE 8		Result
	Freq. Dev. (Hz)	Deviation (ppm)	Freq. Dev. (Hz)	Deviation (ppm)	
-30	-24	-0.03	-40	-0.05	PASS
-20	-23	-0.03	-35	-0.04	
-10	-30	-0.04	-31	-0.04	
0	-31	-0.04	-34	-0.04	
10	-23	-0.03	-33	-0.04	
20	-27	-0.03	-36	-0.04	
30	-22	-0.03	-34	-0.04	
40	-24	-0.03	-30	-0.04	
50	-35	-0.04	-28	-0.03	

Band :	GSM 1900	Channel :	661
Limit (ppm) :	2.5	Frequency :	1880.0 MHz

Temperature (°C)	GPRS 8		EDGE 8		Result
	Freq. Dev. (Hz)	Deviation (ppm)	Freq. Dev. (Hz)	Deviation (ppm)	
-30	-21	-0.01	-31	-0.02	PASS
-20	-23	-0.01	-33	-0.02	
-10	-30	-0.02	-27	-0.01	
0	-32	-0.02	-30	-0.02	
10	-36	-0.02	-38	-0.02	
20	-38	-0.02	-39	-0.02	
30	-37	-0.02	-48	-0.03	
40	-42	-0.02	-42	-0.02	
50	-44	-0.02	-51	-0.03	



Band :	WCDMA Band V	Channel :	4182
Limit (ppm) :	2.5	Frequency :	836.4 MHz

Temperature (°C)	RMC 12.2Kbps		Result
	Freq. Dev. (Hz)	Deviation (ppm)	
-30	13	0.02	PASS
-20	16	0.02	
-10	-17	-0.02	
0	19	0.02	
10	16	0.02	
20	18	0.02	
30	20	0.02	
40	22	0.03	
50	24	0.03	

Band :	WCDMA Band II	Channel :	9400
Limit (ppm) :	2.5	Frequency :	1880.0 MHz

Temperature (°C)	RMC 12.2Kbps		Result
	Freq. Dev. (Hz)	Deviation (ppm)	
-30	4	0.00	PASS
-20	6	0.00	
-10	5	0.00	
0	7	0.00	
10	9	0.00	
20	10	0.01	
30	11	0.01	
40	13	0.01	
50	14	0.01	



3.8.7 Test Result of Voltage Variation

Band & Channel	Mode	Voltage (Volt)	Freq. Dev. (Hz)	Deviation (ppm)	Limit (ppm)	Result
GSM 850 CH189	GPRS 8	5	-21	-0.02	2.5	PASS
		4.75	-23	-0.03		
		5.25	-31	-0.04		
	EDGE 8	5	-21	-0.02		
		4.75	-34	-0.04		
		5.25	-37	-0.04		
GSM 1900 CH661	GPRS 8	5	-30	-0.02		
		4.75	-38	-0.02		
		5.25	-42	-0.02		
	EDGE 8	5	-29	-0.02		
		4.75	-35	-0.02		
		5.25	-37	-0.02		
WCDMA Band V CH4182	RMC 12.2Kbps	5	18	0.02		
		4.75	16	0.02		
		5.25	20	0.02		
WCDMA Band II CH9400	RMC 12.2Kbps	5	12	0.01		
		4.75	11	0.01		
		5.25	12	0.01		

Note: Normal Voltage = 5V.



4 List of Measuring Equipment

Instrument	Manufacturer	Model No.	Serial No.	Characteristics	Calibration Date	Test Date	Due Date	Remark
System Simulator	R&S	CMU200	117995	N/A	Jul. 30, 2012	Dec. 19, 2012	Jul. 29, 2013	Conducted (TH02-HY)
Spectrum Analyzer	R&S	FSP40	100055	9kHz~40GHz	Jun. 06, 2012	Dec. 19, 2012	Jun. 05, 2013	Conducted (TH02-HY)
Thermal Chamber	Ten Billion	TTH-D3SP	TBN-930701	N/A	Jul. 23, 2012	Dec. 19, 2012	Jul. 22, 2013	Conducted (TH02-HY)
Bilog Antenna	Schaffner	CBL6111C	2726	30MHz ~ 1GHz	Oct. 06, 2012	Dec. 20, 2012 ~ Dec. 26, 2012	Oct. 05, 2013	Radiation (03CH07-HY)
Spectrum Analyzer	Rohde & Schwarz	FSP30	101067	9KHz ~ 30GHz	Nov. 30, 2012	Dec. 20, 2012 ~ Dec. 26, 2012	Nov. 29, 2013	Radiation (03CH07-HY)
Double Ridge Horn Antenna	ESCO	3117	00075962	1GHz ~ 18GHz	Aug. 22, 2012	Dec. 20, 2012 ~ Dec. 26, 2012	Aug. 21, 2013	Radiation (03CH07-HY)
Preamplifier	Agilent	8449B	3008A02362	1GHz~ 26.5GHz	Dec. 01, 2012	Dec. 20, 2012 ~ Dec. 26, 2012	Nov. 30, 2013	Radiation (03CH07-HY)
Pre Amplifier	MITEQ	AMF-7D-00 101800-30-1	159088	1GHz ~ 18GHz	Mar. 10, 2012	Dec. 20, 2012 ~ Dec. 26, 2012	Mar. 09, 2013	Radiation (03CH07-HY)
Pre Amplifier	COM-POWER	PA-103A	161241	10-1000MHz. 32dB.GAIN	Feb. 27, 2012	Dec. 20, 2012 ~ Dec. 26, 2012	Feb. 26, 2013	Radiation (03CH07-HY)
EMI Test Receiver	Rohde & Schwarz	ESCI 7	100724	9kHz~7GHz	Sep. 03, 2012	Dec. 20, 2012 ~ Dec. 26, 2012	Sep. 02, 2013	Radiation (03CH07-HY)
SHF-EHF Horn Antenna	SCHWARZBECK	BBHA 9170	BBHA917025 1	15GHz ~ 40GHz	Sep. 28, 2012	Dec. 20, 2012 ~ Dec. 26, 2012	Sep. 27, 2013	Radiation (03CH07-HY)
Loop Antenna	R&S	HFH2-Z2	860004/001	9KHz ~ 30MHz	Jul. 03, 2012	Dec. 20, 2012 ~ Dec. 26, 2012	Jul. 02, 2013	Radiation (03CH07-HY)
System Simulator	R&S	CMU200	117997	N/A	Aug. 22, 2011	Dec. 20, 2012 ~ Dec. 26, 2012	Aug. 21, 2013	Radiation (03CH07-HY)



5 Uncertainty of Evaluation

Uncertainty of Radiated Emission Measurement (30 MHz ~ 1000 MHz)

Measuring Uncertainty for a Level of Confidence of 95% ($U = 2Uc(y)$)	2.54
---	------

Uncertainty of Radiated Emission Measurement (1 GHz ~ 40 GHz)

Measuring Uncertainty for a Level of Confidence of 95% ($U = 2Uc(y)$)	4.72
---	------



Appendix A. Photographs of EUT

Please refer to Sporton report number EP2N2009-02 as below.