

## DFS Test Report

**Report No.:** RF170801C12A

**FCC ID:** KA2WL6620APSA1

**Test Model:** DWL-6620APS

**Received Date:** Aug. 01, 2017

**Test Date:** Jun. 01, 2018

**Issued Date:** Jun. 04, 2018

**Applicant:** D-Link Corporation

**Address:** 17595 Mt. Herrmann, Fountain Valley, California, United States, 92708

**Issued By:** Bureau Veritas Consumer Products Services (H.K.) Ltd., Taoyuan Branch

**Lab Address:** No. 47-2, 14th Ling, Chia Pau Vil., Lin Kou Dist., New Taipei City, Taiwan, R.O.C.

**Test Location:** No. 19, Hwa Ya 2nd Rd., Wen Hwa Vil., Kwei Shan Dist., Taoyuan City 33383, TAIWAN (R.O.C.)

**FCC Registration /** 788550 / TW0003

**Designation Number:**



This report is for your exclusive use. Any copying or replication of this report to or for any other person or entity, or use of our name or trademark, is permitted only with our prior written permission. This report sets forth our findings solely with respect to the test samples identified herein. The results set forth in this report are not indicative or representative of the quality or characteristics of the lot from which a test sample was taken or any similar or identical product specifically and expressly noted. Our report includes all of the tests requested by you and the results thereof based upon the information that you provided to us. You have 60 days from date of issuance of this report to notify us of any material error or omission caused by our negligence, provided, however, that such notice shall be in writing and shall specifically address the issue you wish to raise. A failure to raise such issue within the prescribed time shall constitute your unqualified acceptance of the completeness of this report, the tests conducted and the correctness of the report contents. Unless specific mention, the uncertainty of measurement has been explicitly taken into account to declare the compliance or non-compliance to the specification. The report must not be used by the client to claim product certification, approval, or endorsement by TAF or any government agencies.

## Table of Contents

<b>Release Control Record</b> .....	<b>3</b>
<b>1 Certificate of Conformity</b> .....	<b>4</b>
<b>2 EUT Information</b> .....	<b>5</b>
2.1 Operating Frequency Bands and Mode of EUT.....	5
2.2 EUT Software and Firmware Version.....	5
2.3 Description of Available Antennas to the EUT .....	5
2.4 EUT Maximum Conducted Power.....	6
2.5 EUT Maximum E.I.R.P. Power .....	8
2.6 Transmit Power Control (TPc).....	10
2.7 Statement of Manufacturer.....	10
<b>3 U-NII DFS Rule Requirements</b> .....	<b>11</b>
3.1 Working Modes and Required Test Items .....	11
3.2 Test Limits And Radar Signal Parameters .....	12
<b>4 Test &amp; Support Equipment List</b> .....	<b>15</b>
4.1 Test Instruments.....	15
4.2 Description of Support Units .....	15
<b>5 Test Procedure</b> .....	<b>16</b>
5.1 DFS Measurement System.....	16
5.2 Calibration of DFS Detection Threshold Level.....	17
5.3 Deviation from Test Standard.....	17
5.4 Radiated Test Setup Configuration .....	18
5.4.1 Master Mode.....	18
<b>6 Test Results</b> .....	<b>19</b>
6.1 Summary of Test Results .....	19
6.2 Test Results.....	20
6.2.1 Test Mode .....	20
6.2.2 U-NII Detection Bandwidth .....	25
6.2.3 Channel Availability Check Time .....	31
6.2.4 Channel Closing Transmission and Channel Move Time.....	33
6.2.5 Non- Occupancy Period .....	42
6.2.6 Uniform Spreading.....	45
6.2.7 Transmit power control (TPC) .....	45
<b>7 Information on the Testing Laboratories</b> .....	<b>46</b>

### Release Control Record

Issue No.	Description	Date Issued
RF170801C12A	Original release.	Jun. 04, 2018

## 1 Certificate of Conformity

**Product:** Unified AC Concurrent Dual-band PoE Access Point

**Brand:** D-Link Corporation

**Test Model:** DWL-6620APS

**Sample Status:** Identical Prototype

**Applicant:** D-Link Corporation

**Test Date:** Jun. 01, 2018

**Standards:** FCC Part 15, Subpart E (Section 15.407)  
KDB 905462 D02 UNII DFS Compliance Procedures New Rules v02

The above equipment has been tested by **Bureau Veritas Consumer Products Services (H.K.) Ltd., Taoyuan Branch**, and found compliance with the requirement of the above standards. The test record, data evaluation & Equipment Under Test (EUT) configurations represented herein are true and accurate accounts of the measurements of the sample's RF characteristics under the conditions specified in this report.

**Prepared by :**     Alice Ho     , **Date:**     Jun. 04, 2018      
Alice Ho / Specialist

**Approved by :**     Bruce Chen     , **Date:**     Jun. 04, 2018      
Bruce Chen / Project Engineer

## 2 EUT Information

### 2.1 Operating Frequency Bands and Mode of EUT

Table 1: Operating Frequency Bands and Mode of EUT

Operational Mode	Operating Frequency Range	
	5250~5350MHz	5470~5725MHz
Master	✓	✓

### 2.2 EUT Software and Firmware Version

Table 2: The EUT Software/Firmware Version

No.	Product	Test Model No.	Software/Firmware Version
1	Unified AC Concurrent Dual-band PoE Access Point	DWL-6620APS	Firmware Version: 4.7.0.10DFS05

### 2.3 Description of Available Antennas to the EUT

Table 3: Antenna List

ANT No.	Antenna Type	Operation Frequency Range (MHz)	Gain (dBi)
1	Smart Ant	5250-5350	6.1
1	Smart Ant	5470-5725	6.1
2	Smart Ant	5250-5350	6.1
2	Smart Ant	5470-5725	6.1

Maximum Correlated Directional Gain =  $10 \log[(10^{G1/20} + 10^{G2/20} + \dots + 10^{GN/20})^2 / N_{ANT}]$  dBi

Note: 5470~5725MHz Directional Gain = 9.11 dBi

## 2.4 EUT Maximum Conducted Power

Table 4: The Measured Conducted Output Power

CDD Mode

### 802.11a

Ant No.	Frequency Band (MHz)	MAX. Power	
		Output Power(dBm)	Output Power(mW)
1	5250~5350	19.99	99.829
1	5470~5725	20.26	106.092

### 802.11n HT20

Ant No.	Frequency Band (MHz)	MAX. Power	
		Output Power(dBm)	Output Power(mW)
1	5250~5350	20.75	118.972
1	5470~5725	21.39	137.573

### 802.11n HT40

Ant No.	Frequency Band (MHz)	MAX. Power	
		Output Power(dBm)	Output Power(mW)
1	5250~5350	22.69	185.899
1	5470~5725	22.93	196.546

### 802.11ac VHT80

Ant No.	Frequency Band (MHz)	MAX. Power	
		Output Power(dBm)	Output Power(mW)
1	5250~5350	18.86	76.919
1	5470~5725	22.89	194.612

Beamforming Mode

802.11ac VHT20

Ant No.	Frequency Band (MHz)	MAX. Power	
		Output Power(dBm)	Output Power(mW)
1	5250~5350	17.74	59.429
1	5470~5725	18.38	68.865

802.11ac VHT40

Ant No.	Frequency Band (MHz)	MAX. Power	
		Output Power(dBm)	Output Power(mW)
1	5250~5350	19.68	92.897
1	5470~5725	19.92	98.175

802.11ac VHT80

Ant No.	Frequency Band (MHz)	MAX. Power	
		Output Power(dBm)	Output Power(mW)
1	5250~5350	15.85	38.459
1	5470~5725	19.88	97.275

## 2.5 EUT Maximum E.I.R.P. Power

Table 5: The EIRP Output Power List

### CDD Mode

#### 802.11a

Ant No.	Frequency Band (MHz)	MAX. Power	
		Output Power(dBm)	Output Power(mW)
1	5250~5350	26.09	406.443
1	5470~5725	26.36	432.514

#### 802.11n HT20

Ant No.	Frequency Band (MHz)	MAX. Power	
		Output Power(dBm)	Output Power(mW)
1	5250~5350	26.85	484.172
1	5470~5725	27.49	561.048

#### 802.11n HT40

Ant No.	Frequency Band (MHz)	MAX. Power	
		Output Power(dBm)	Output Power(mW)
1	5250~5350	28.79	756.833
1	5470~5725	29.03	799.834

#### 802.11ac VHT80

Ant No.	Frequency Band (MHz)	MAX. Power	
		Output Power(dBm)	Output Power(mW)
1	5250~5350	24.96	313.329
1	5470~5725	28.99	792.501



Beamforming Mode

802.11ac VHT20

Ant No.	Frequency Band (MHz)	MAX. Power	
		Output Power(dBm)	Output Power(mW)
1	5250~5350	26.85	484.172
1	5470~5725	27.49	561.048

802.11ac VHT40

Ant No.	Frequency Band (MHz)	MAX. Power	
		Output Power(dBm)	Output Power(mW)
1	5250~5350	28.79	756.833
1	5470~5725	29.03	799.834

802.11ac VHT80

Ant No.	Frequency Band (MHz)	MAX. Power	
		Output Power(dBm)	Output Power(mW)
1	5250~5350	24.96	313.329
1	5470~5725	28.99	792.501

## 2.6 Transmit Power Control (TPC)

U-NII devices operating in the 5.25-5.35 GHz band and the 5.47-5.725 GHz band shall employ a TPC mechanism. The U-NII device is required to have the capability to operate at least 6 dB below the mean EIRP value of 30 dBm. A TPC mechanism is not required for systems with an e.i.r.p. of less than 500 mW.

Maximum EIRP of this device is 799.834mW which greater than 500mW, therefore it's require TPC function.

The UUT can adjust a transmitter's output power based on the signal level present at the receiver. TPC is auto controlled by software

## 2.7 Statement of Manufacturer

Manufacturer statement confirming that information regarding the parameters of the detected Radar Waveforms is not available to the end user.

### 3 U-NII DFS Rule Requirements

#### 3.1 Working Modes and Required Test Items

The manufacturer shall state whether the UUT is capable of operating as a Master and/or a Client. If the UUT is capable of operating in more than one operating mode then each operating mode shall be tested separately. See tables 6 and 7 for the applicability of DFS requirements for each of the operational modes.

Table 6: Applicability of DFS Requirements Prior To Use a Channel

Requirement	Operational Mode		
	Master	Client without radar detection	Client with radar detection
Non-Occupancy Period	✓	✓ note	✓
DFS Detection Threshold	✓	Not required	✓
Channel Availability Check Time	✓	Not required	Not required
U-NII Detection Bandwidth	✓	Not required	✓

Note: Per KDB 905462 D03 UNII Clients Without Radar Detection New Rules v01r02 section (b)(5/6), If the client moves with the master, the device is considered compliant if nothing appears in the client non-occupancy period test. For devices that shut down (rather than moving channels), no beacons should appear. An analyzer plot that contains a single 30-minute sweep on the original channel.

Table 7: Applicability of DFS Requirements during Normal Operation.

Requirement	Operational Mode	
	Master or Client with radar detection	Client without radar detection
DFS Detection Threshold	✓	Not required
Channel Closing Transmission Time	✓	✓
Channel Move Time	✓	✓
U-NII Detection Bandwidth	✓	Not required

Additional requirements for devices with multiple bandwidth modes	Master or Client with radar detection	Client without radar detection
U-NII Detection Bandwidth and Statistical Performance Check	All BW modes must be tested	Not required
Channel Move Time and Channel Closing Transmission Time	Test using widest BW mode available	Test using the widest BW mode available for the link
All other tests	Any single BW mode	Not required

Note: Frequencies selected for statistical performance check (Section 7.8.4) should include several frequencies within the radar detection bandwidth and frequencies near the edge of the radar detection bandwidth. For 802.11 devices it is suggested to select frequencies in each of the bonded 20 MHz channels and the channel center frequency.

### 3.2 Test Limits And Radar Signal Parameters

#### Detection Threshold Values

Table 8: DFS Detection Thresholds For Master Devices And Client Devices With Radar Detection

Maximum Transmit Power	Value (See Notes 1, 2, and 3)
EIRP $\geq$ 200 milliwatt	-64 dBm
EIRP < 200 milliwatt and power spectral density < 10 dBm/MHz	-62 dBm
EIRP < 200 milliwatt that do not meet the power spectral density requirement	-64 dBm

Note 1: This is the level at the input of the receiver assuming a 0 dBi receive antenna.  
 Note 2: Throughout these test procedures an additional 1 dB has been added to the amplitude of the test transmission waveforms to account for variations in measurement equipment. This will ensure that the test signal is at or above the detection threshold level to trigger a DFS response.  
 Note3: EIRP is based on the highest antenna gain. For MIMO devices refer to KDB Publication 662911 D01.

Table 9: DFS Response Requirement Values

Parameter	Value
Non-occupancy period	Minimum 30 minutes
Channel Availability Check Time	60 seconds
Channel Move Time	10 seconds See Note 1.
Channel Closing Transmission Time	200 milliseconds + an aggregate of 60 milliseconds over remaining 10 second period. See Notes 1 and 2.
U-NII Detection Bandwidth	Minimum 100% of the U-NII 99% transmission power bandwidth. See Note 3

Note 1: Channel Move Time and the Channel Closing Transmission Time should be performed with Radar Type 0. The measurement timing begins at the end of the Radar Type 0 burst.  
 Note 2: The Channel Closing Transmission Time is comprised of 200 milliseconds starting at the beginning of the Channel Move Time plus any additional intermittent control signals required to facilitate a Channel move (an aggregate of 60 milliseconds) during the remainder of the 10 second period. The aggregate duration of control signals will not count quiet periods in between transmissions.  
 Note 3: During the U-NII Detection Bandwidth detection test, radar type 0 should be used. For each frequency step the minimum percentage of detection is 90 percent. Measurements are performed with no data traffic.

### Parameters of DFS Test Signals

Step intervals of 0.1 microsecond for Pulse Width, 1 microsecond for PRI, 1 MHz for chirp width and 1 for the number of pulses will be utilized for the random determination of specific test waveforms.

Table 10: Short Pulse Radar Test Waveforms

Radar Type	Pulse Width (μsec)	PRI (μsec)	Number of Pulses	Minimum Percentage of Successful Detection	Minimum Number of Trials
0	1	1428	18	See Note 1	See Note 1
1	1	Test A: 15 unique PRI values randomly selected from the list of 23 PRI values in Table 5a	$\text{Roundup} \left\{ \begin{array}{l} \left( \frac{1}{360} \right) \cdot \\ \left( \frac{19 \cdot 10^6}{\text{PRI}_{\mu\text{sec}}} \right) \end{array} \right\}$	60%	30
		Test B: 15 unique PRI values randomly selected within the range of 518-3066 μ sec, with a minimum increment of 1 μ sec, excluding PRI values selected in Test A			
2	1-5	150-230	23-29	60%	30
3	6-10	200-500	16-18	60%	30
4	11-20	200-500	12-16	60%	30
Aggregate (Radar Types 1-4)				80%	120
Note 1: Short Pulse Radar Type 0 should be used for the detection bandwidth test, channel move time, and channel closing time tests.					

**Table 11: Long Pulse Radar Test Waveform**

Radar Type	Pulse Width (μsec)	Chirp Width (MHz)	PRI (μsec)	Number Of Pulses Per Burst	Number Of Bursts	Minimum Percentage Of Successful Detection	Minimum Number Of Trials
5	50-100	5-20	1000-2000	1-3	8-20	80%	30

Three subsets of trials will be performed with a minimum of ten trials per subset. The subset of trials differ in where the Long Pulse Type 5 Signal is tuned in frequency.

- a) the Channel center frequency
- b) tuned frequencies such that 90% of the Long Pulse Type 5 frequency modulation is within the low edge of the UUT Occupied Bandwidth
- c) tuned frequencies such that 90% of the Long Pulse Type 5 frequency modulation is within the high edge of the UUT Occupied Bandwidth

It include 10 trails for every subset, the formula as below,

For subset case 1: the center frequency of the signal generator will remain fixed at the center of the UUT Channel.

For subset case 2: to retain 90% frequency overlap between the radar signal and the UUT Occupied Bandwidth, the center frequency of the signal generator will vary for each of the ten trials in subset case 2. The center frequency of the signal generator for each trial is calculated by:

$$FL+(0.4*Chirp\ Width\ [in\ MHz])$$

For subset case 3: to retain 90% frequency overlap between the radar signal and the UUT Occupied Bandwidth, the center frequency of the signal generator will vary for each of the ten trials in subset case 3. The center frequency of the signal generator for each trial is calculated by:

$$FH-(0.4*Chirp\ Width\ [in\ MHz])$$

**Table 12: Frequency Hopping Radar Test Waveform**

Radar Type	Pulse Width (μsec)	PRI (μsec)	Pulses per Hop	Hopping Rate (kHz)	Hopping Sequence Length (msec)	Minimum Percentage Of Successful Detection	Minimum Number Of Trials
6	1	333	9	0.333	300	70%	30

#### 4 Test & Support Equipment List

##### 4.1 Test Instruments

Table 13: Test Instruments List

Description	Model No.	Brand	Date Of Calibration	Due Date Of Calibration
Spectrum analyzer	ESR	R&S	2018/03/01	2019/02/28
Signal generator	8645A	Agilent	2017/08/11	2018/08/10
Horn antenna	BBHA 9120 D	Schwarzbeck	2017/12/14	2018/12/13
RF coaxial cable	CA3501-3501-G.90(3m) & CA3501-3501-F.90(2m)	INFINET	2017/08/21	2018/08/20

##### 4.2 Description of Support Units

Table 14: Support Unit Information.

No.	Product	Brand	Model No.	FCC ID
1	WiFi USB Adapter	NETGEAR	A6210	PY313400249

**NOTE:** This device was functioned as a  Master  Slave device during the DFS test.

## 5 Test Procedure

### 5.1 DFS Measurement System

A complete DFS Measurement System consists of two subsystems: (1) the Radar Signal Generating Subsystem and (2) the Traffic Monitoring Subsystem. The control PC is necessary for generating the Radar waveforms in Table 10, 11 and 12. The traffic monitoring subsystem is specified to the type of unit under test (UUT).

#### Radiated Setup Configuration of DFS Measurement System

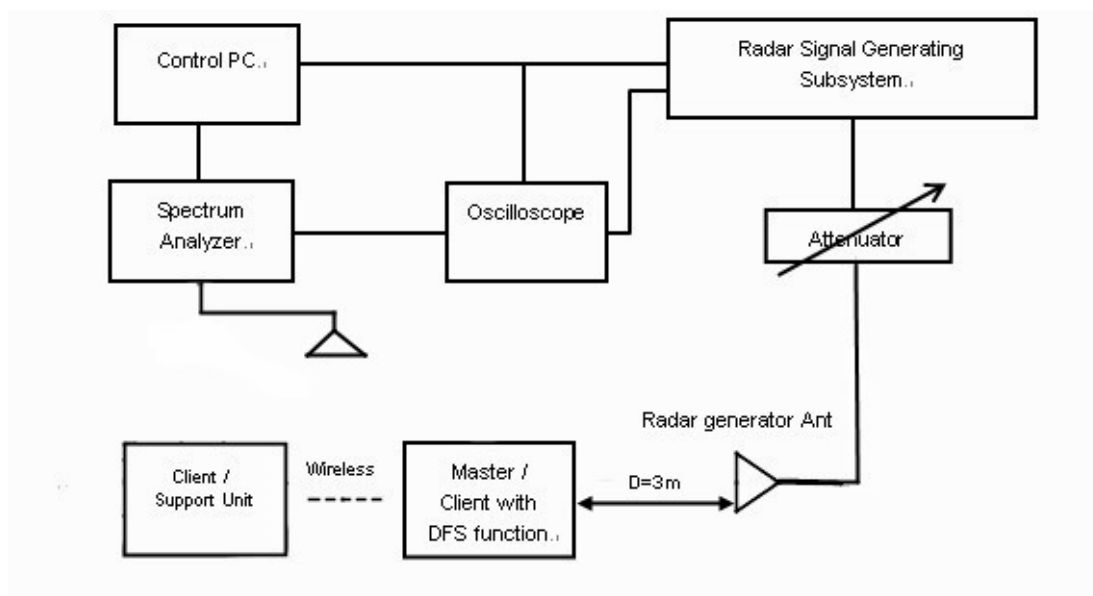

System testing will be performed with channel-loading using means appropriate to the data types that are used by the unlicensed device. The following requirements apply:

	a) The data file must be of a type that is typical for the device (i.e., MPEG-2, MPEG-4, WAV, MP3, MP4, AVI, etc.) and must generally be transmitting in a streaming mode.
	b) Software to ping the client is permitted to simulate data transfer but must have random ping intervals.
V	c) Timing plots are required with calculations demonstrating a minimum channel loading of approximately 17% or greater.
	d) Unicast or Multicast protocols are preferable but other protocols may be used. The appropriate protocol used must be described in the test procedures.



## 5.2 Calibration of DFS Detection Threshold Level

The measured channel is 5500MHz, 5510MHz and 5530MHz. The radar signal was the same as transmitted channels, and injected into the antenna of AP (master) or Client Device with Radar Detection, measured the channel closing transmission time and channel move time. The calibrated conducted detection threshold level is set to -64dBm. The tested level is lower than required level hence it provides margin to the limit.

### Radiated setup configuration of Calibration of DFS Detection Threshold Level

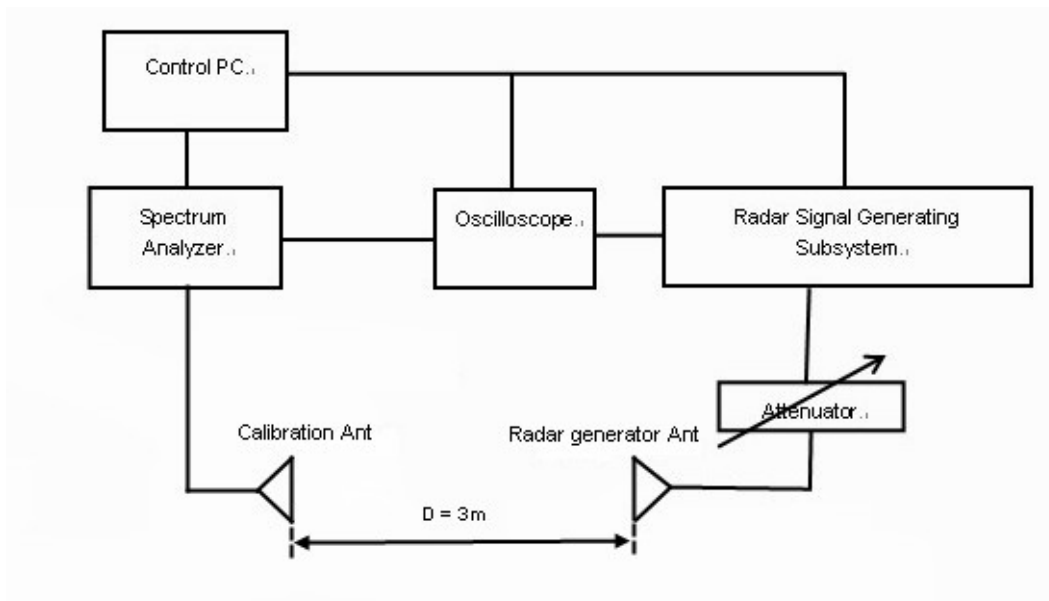

## 5.3 Deviation from Test Standard

No deviation.

## 5.4 Radiated Test Setup Configuration

### 5.4.1 Master Mode

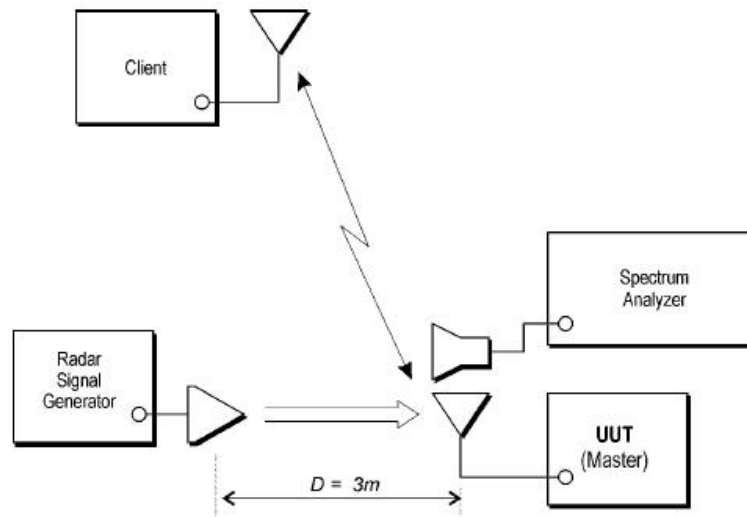

The EUT is a U-NII Device operating in Master mode. The radar test signals are injected into the Master Device.

## 6 Test Results

### 6.1 Summary of Test Results

Clause	Test Parameter	Remarks	Pass/Fail
15.407	DFS Detection Threshold	Applicable	Pass
15.407	U-NII Detection Bandwidth	Applicable	Pass
15.407	Channel Availability Check Time	Applicable	Pass
15.407	Channel Move Time	Applicable	Pass
15.407	Channel Closing Transmission Time	Applicable	Pass
15.407	Non- Occupancy Period	Applicable	Pass
15.407	Uniform Spreading	Applicable	Pass

## 6.2 Test Results

### 6.2.1 Test Mode

Master with injection at the Master. (Radar Test Waveforms are injected into the Master.)

### DFS Detection Threshold

For detection threshold level of -64dBm, the required Radar Signal at antenna port was set to -64dBm. The tested level is lower than required level for 1dB, hence it provides margin to the limit.

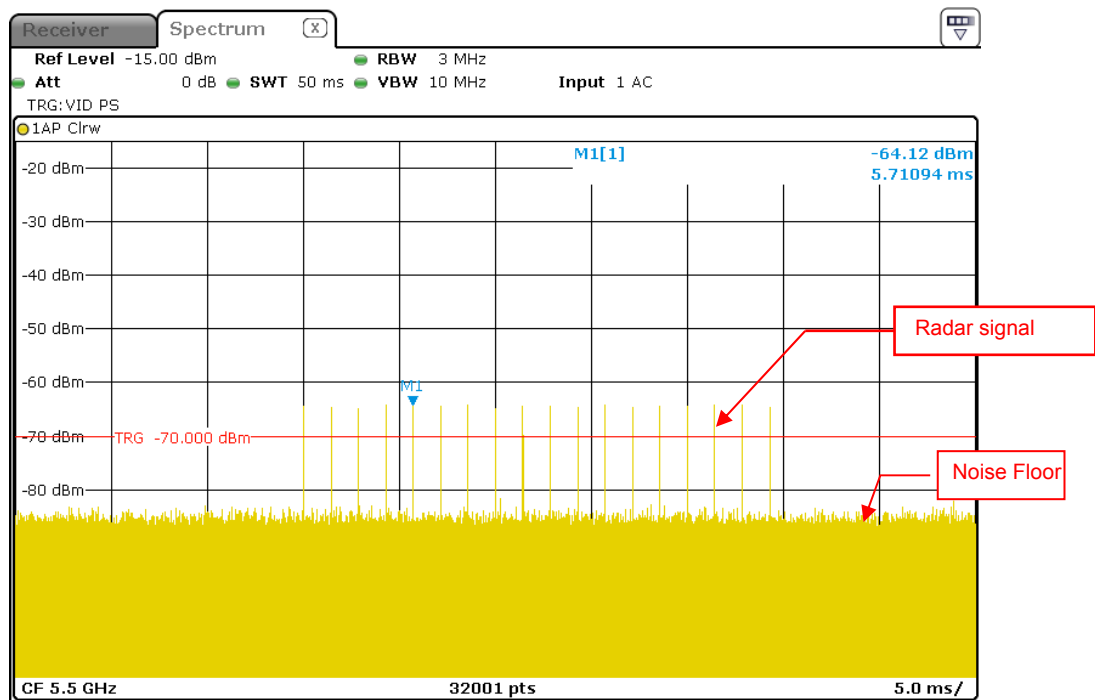

Radar Signal 0

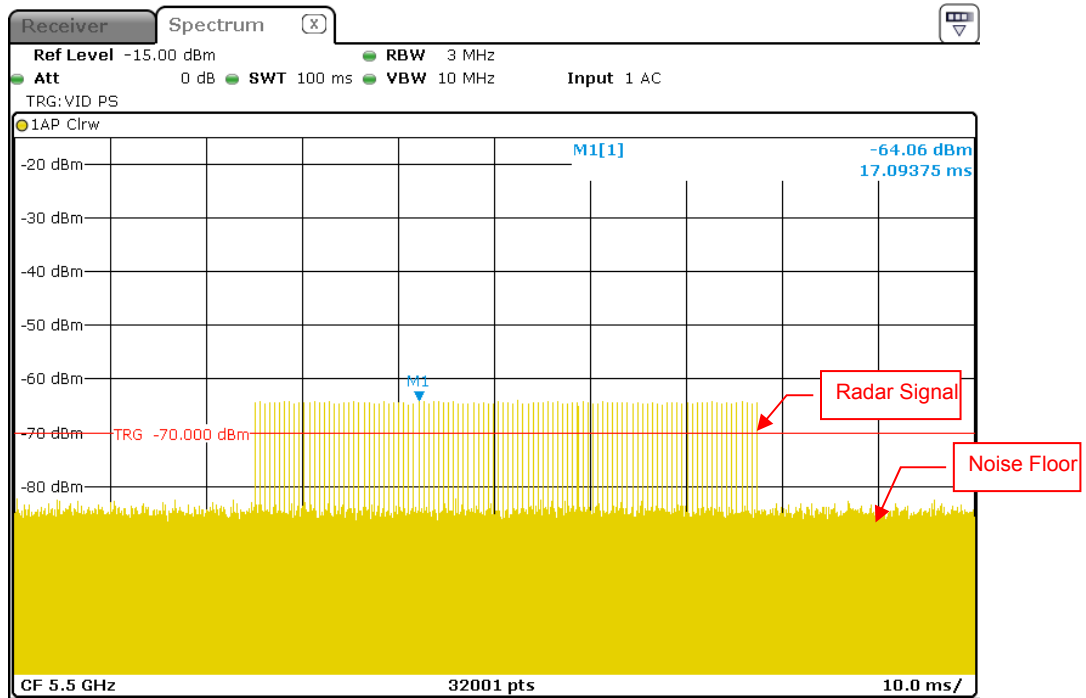

Radar Signal 1 (Test A)

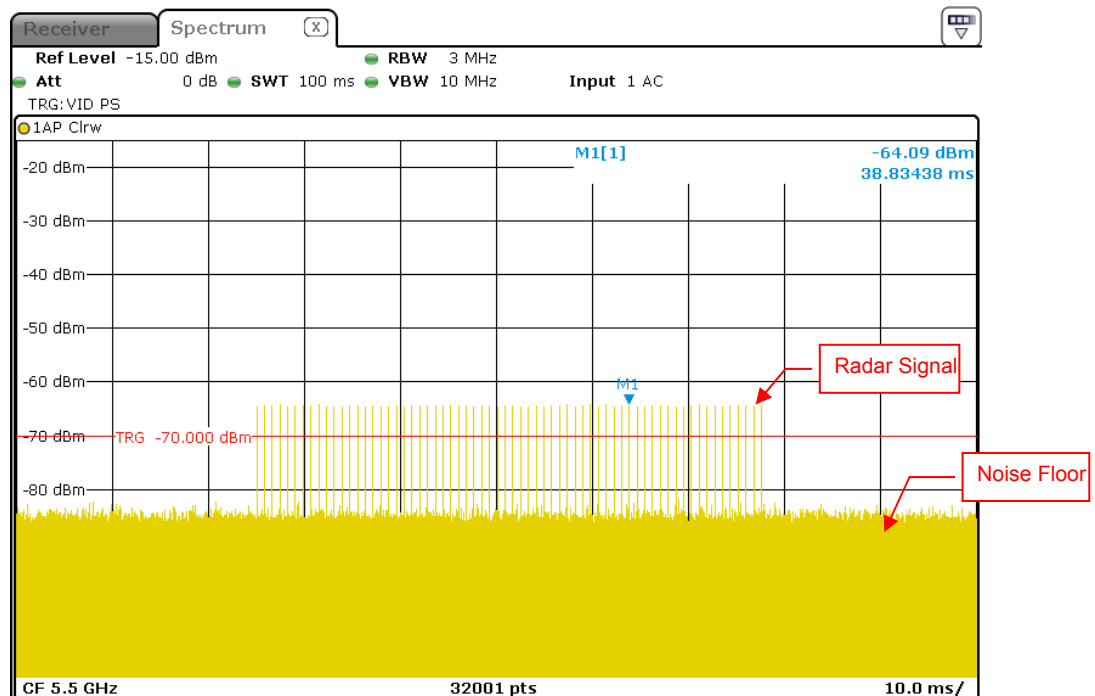

Radar Signal 1 (Test B)

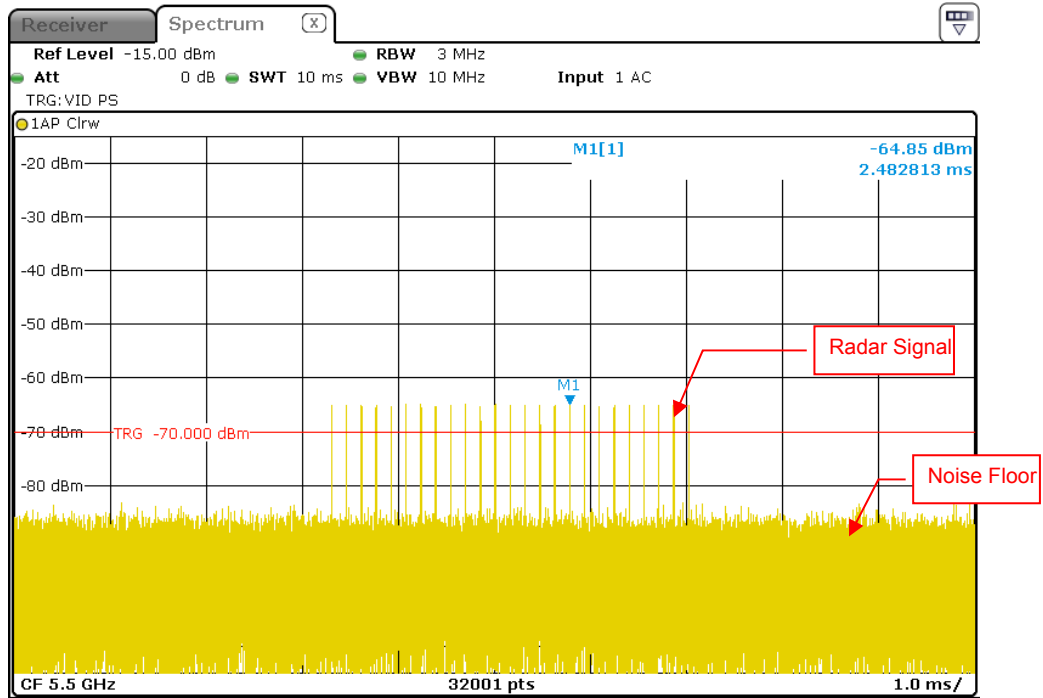

Radar Signal 2

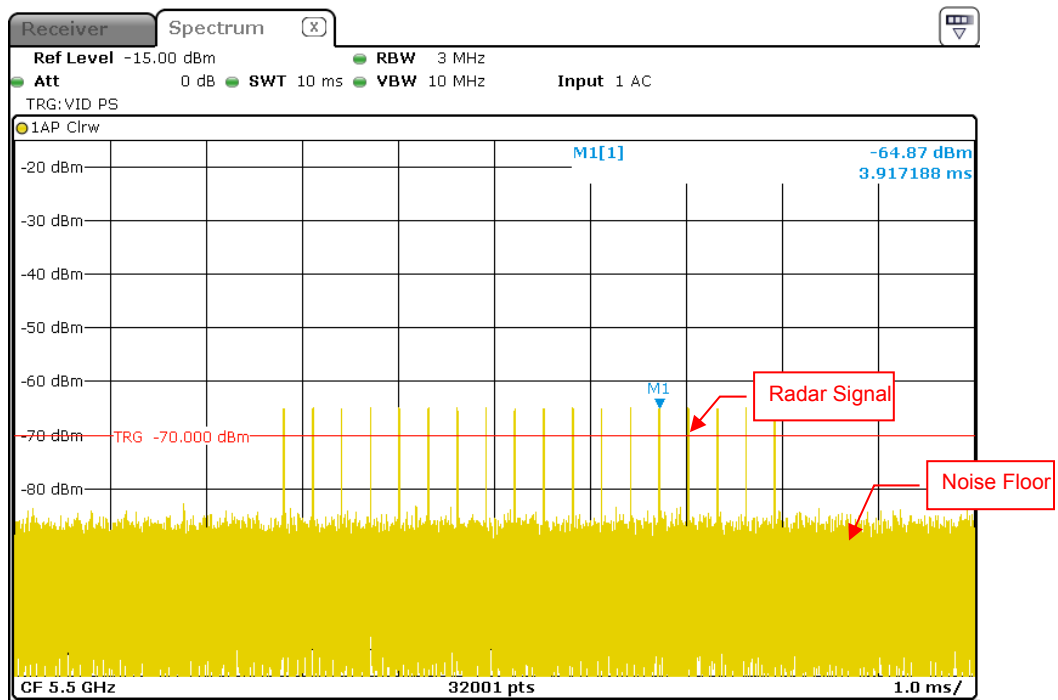

Radar Signal 3

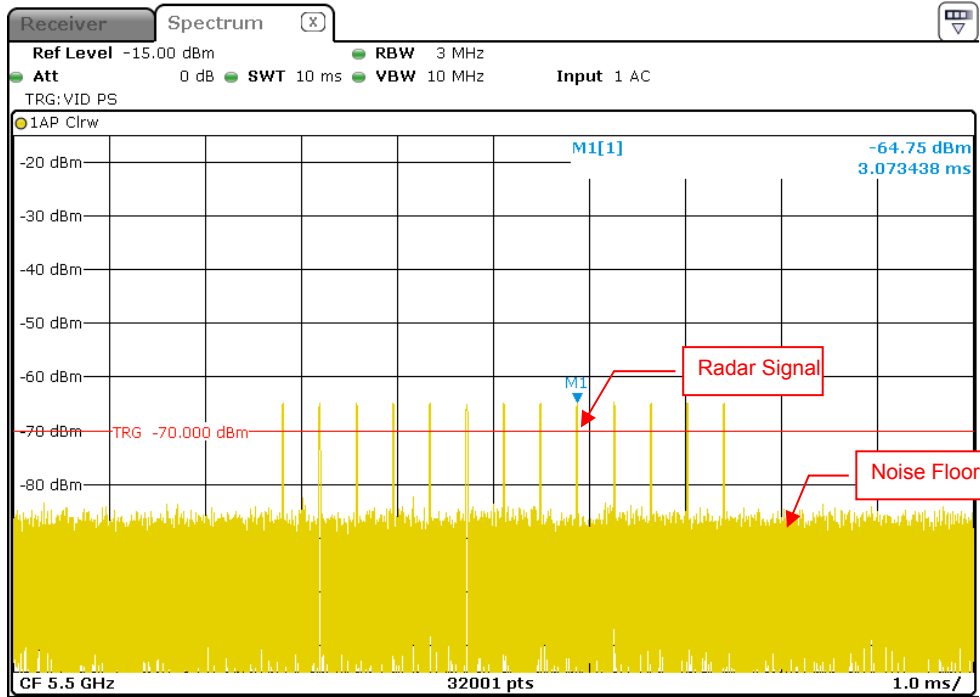

Radar Signal 4

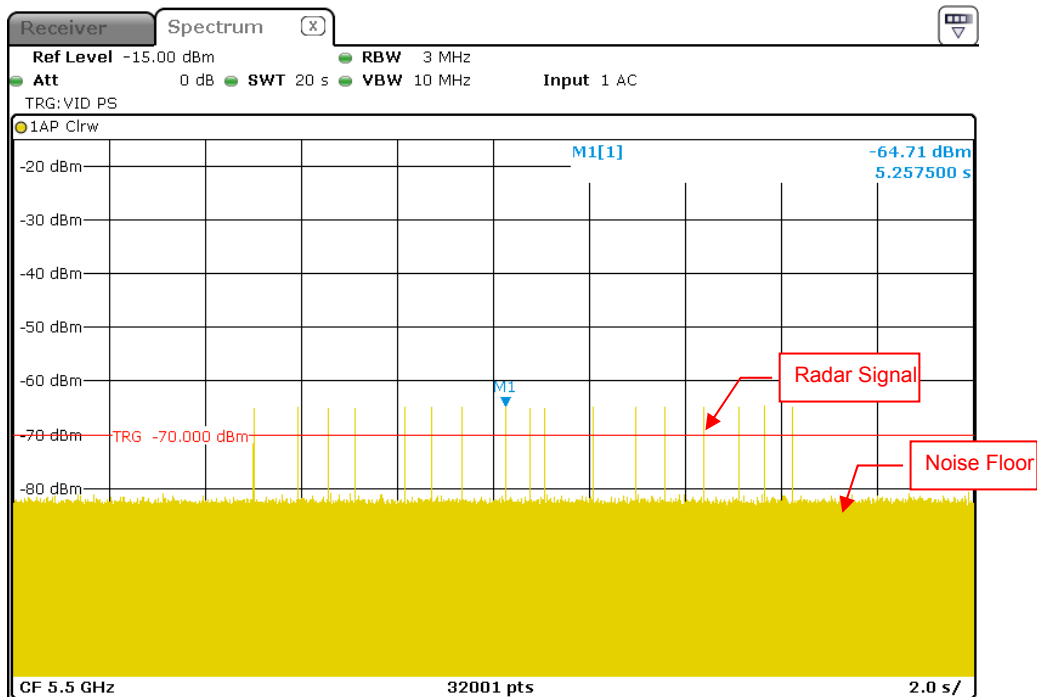

Radar Signal 5

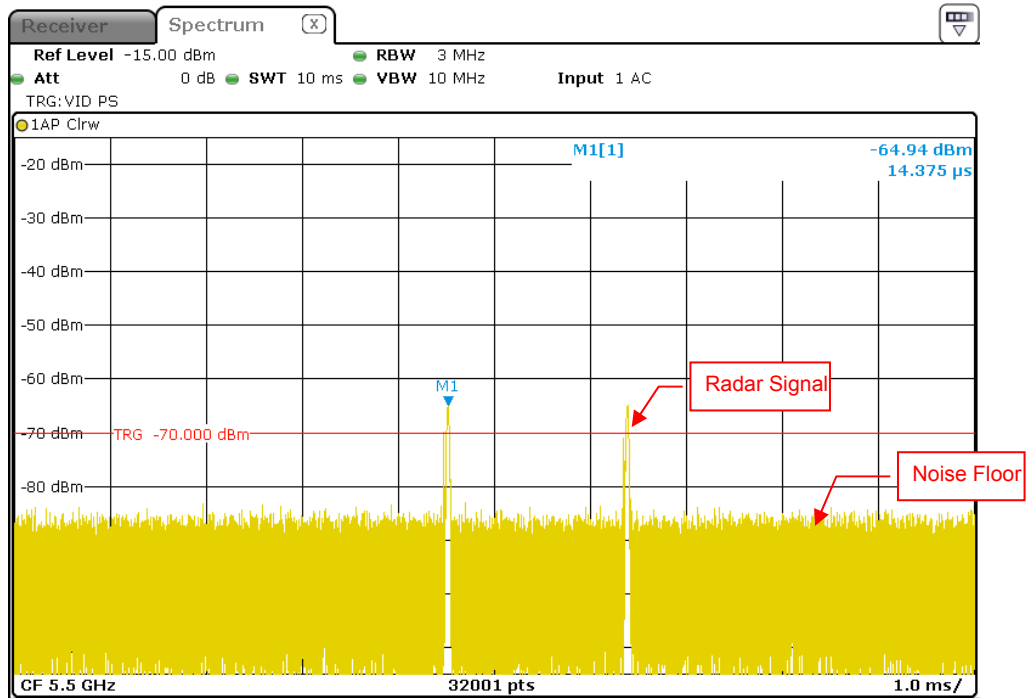

Single Burst of Radar Signal 5

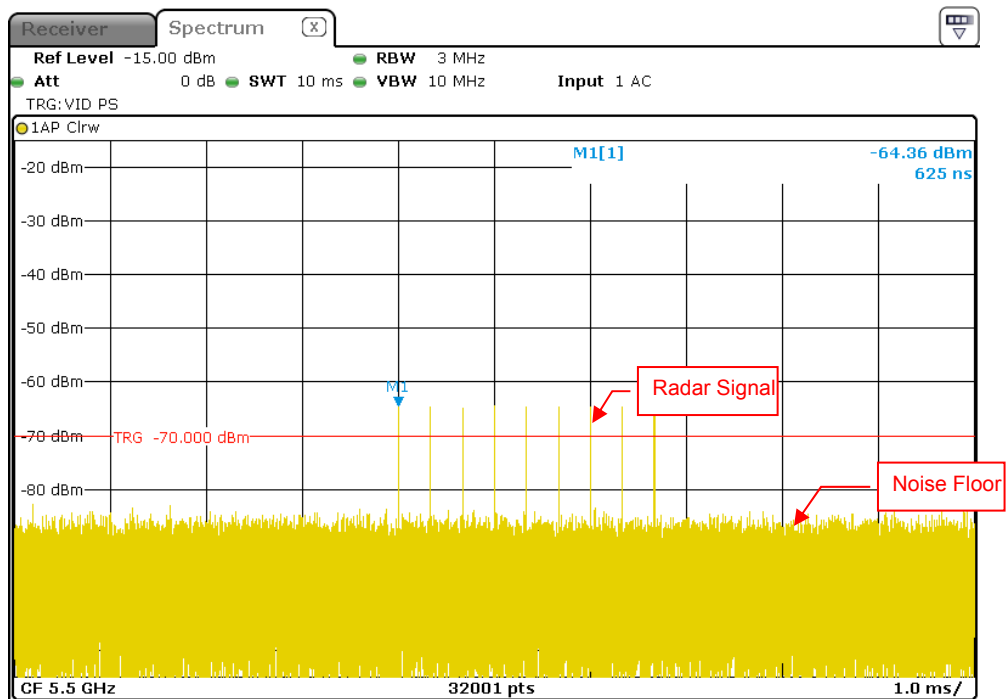

Radar Signal 6



### 6.2.2 U-NII Detection Bandwidth IEEE 802.11ac VHT20

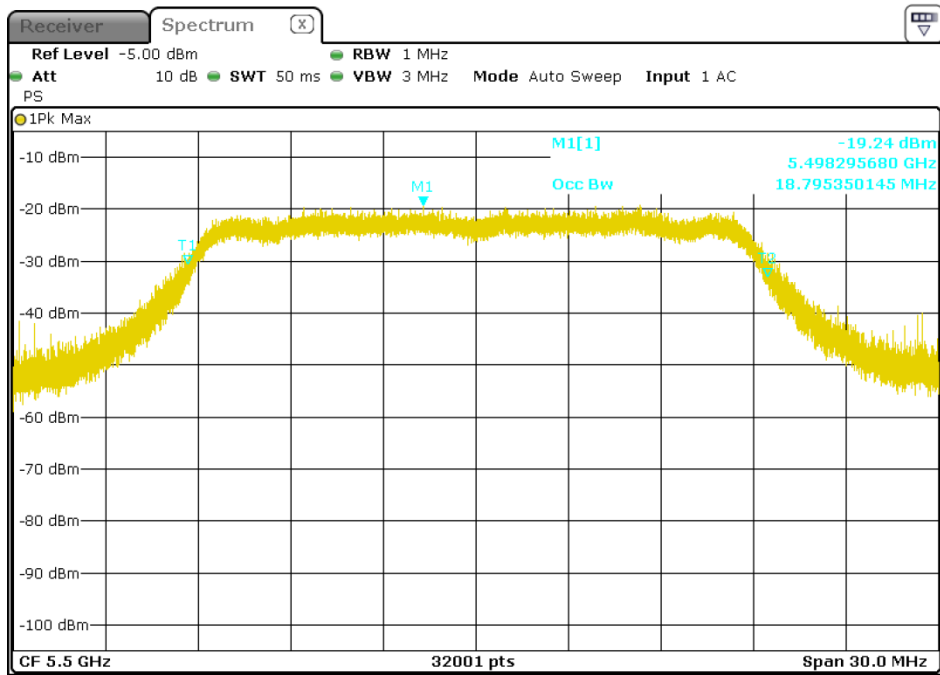

U-NII 99% Channel bandwidth

### IEEE 802.11ac VHT40

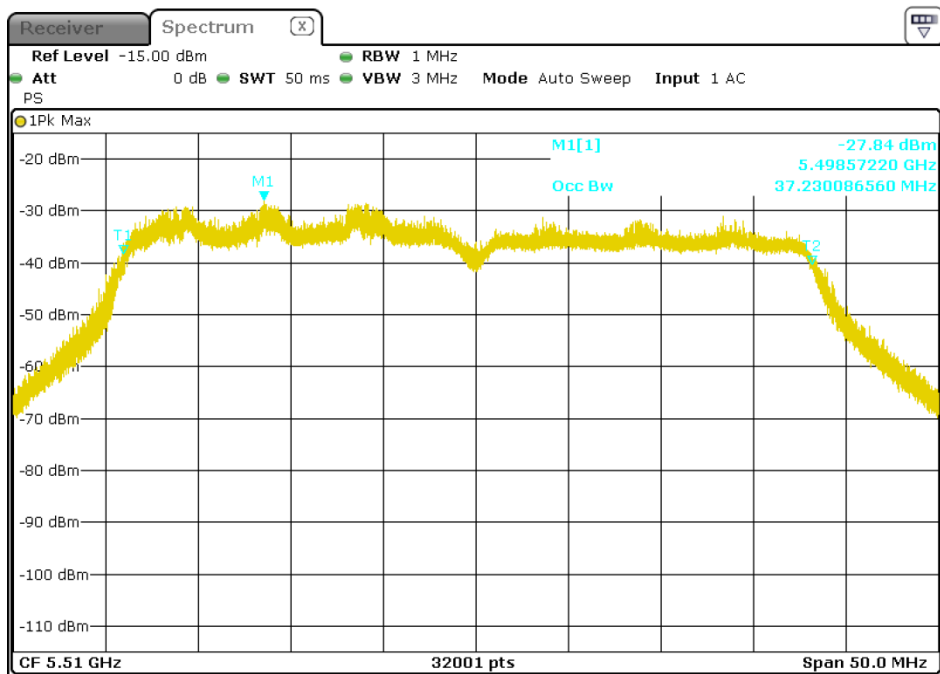

U-NII 99% Channel bandwidth

# IEEE 802.11ac VHT80

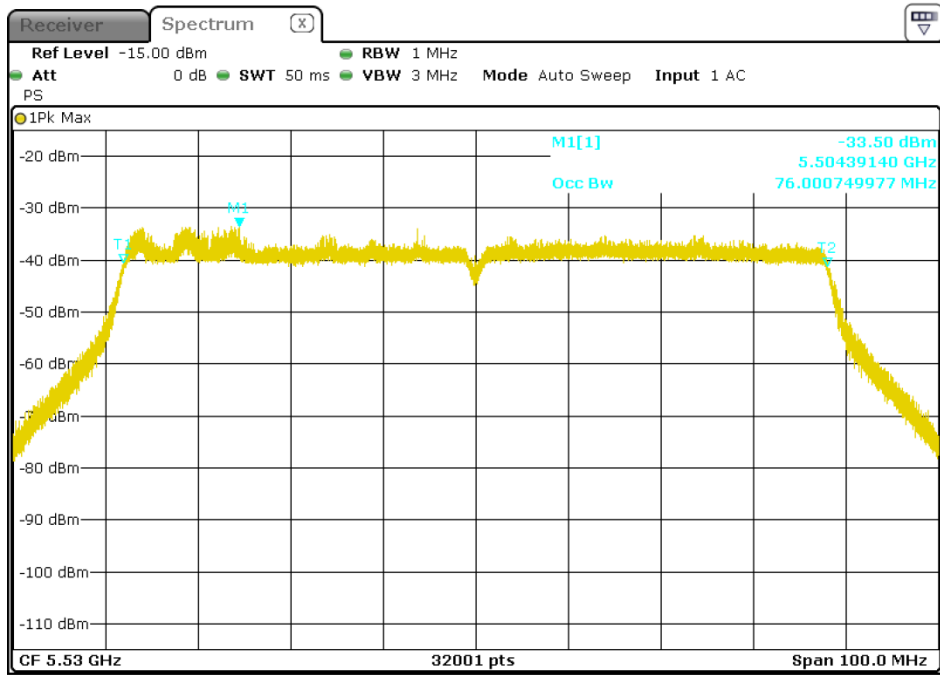

U-NII 99% Channel bandwidth

Detection Bandwidth Test - IEEE 802.11ac VHT20

Radar Type 0

EUT Frequency: 5500MHz

EUT 99% Power bandwidth: 18.79MHz

Detection bandwidth limit (100% of EUT 99% Power bandwidth): 18.79MHz

Detection bandwidth (5510(FH) – 5490(FL)) : 20MHz

Test Result : Pass

Radar Frequency (MHz)	Trial Number / Detection										Detection Rate (%)
	1	2	3	4	5	6	7	8	9	10	
5489	N	N	N	N	N	N	N	N	N	N	0
5490 (FL)	Y	Y	Y	Y	Y	Y	Y	Y	Y	Y	100
5491	Y	Y	Y	Y	Y	Y	Y	Y	Y	Y	100
5492	Y	Y	Y	Y	Y	Y	Y	Y	Y	Y	100
5493	Y	Y	Y	Y	Y	Y	Y	Y	Y	Y	100
5494	Y	Y	Y	Y	Y	Y	Y	Y	Y	Y	100
5495	Y	Y	Y	Y	Y	Y	Y	Y	Y	Y	100
5496	Y	Y	Y	Y	Y	Y	Y	Y	Y	Y	100
5497	Y	Y	Y	Y	Y	Y	Y	Y	Y	Y	100
5498	Y	Y	Y	Y	Y	Y	Y	Y	Y	Y	100
5499	Y	Y	Y	Y	Y	Y	Y	Y	Y	Y	100
5500	Y	Y	Y	Y	Y	Y	Y	Y	Y	Y	100
5501	Y	Y	Y	Y	Y	Y	Y	Y	Y	Y	100
5502	Y	Y	Y	Y	Y	Y	Y	Y	Y	Y	100
5503	Y	Y	Y	Y	Y	Y	Y	Y	Y	Y	100
5504	Y	Y	Y	Y	Y	Y	Y	Y	Y	Y	100
5505	Y	Y	Y	Y	Y	Y	Y	Y	Y	Y	100
5506	Y	Y	Y	Y	Y	Y	Y	Y	Y	Y	100
5507	Y	Y	Y	Y	Y	Y	Y	Y	Y	Y	100
5508	Y	Y	Y	Y	Y	Y	Y	Y	Y	Y	100
5509	Y	Y	Y	Y	Y	Y	Y	Y	Y	Y	100
5510 (FH)	Y	Y	Y	Y	Y	Y	Y	Y	Y	Y	100
5511	N	N	N	N	N	N	N	N	Y	Y	20

Detection Bandwidth Test - IEEE 802.11ac VHT40

Radar Type 0

EUT Frequency: 5510MHz

EUT 99% Power bandwidth: 37.23MHz

Detection bandwidth limit (100% of EUT 99% Power bandwidth): 37.23MHz

Detection bandwidth (5530(FH) – 5490(FL)) : 40MHz

Test Result : Pass

Radar Frequency (MHz)	Trial Number / Detection										Detection Rate (%)
	1	2	3	4	5	6	7	8	9	10	
5489	N	N	N	N	N	N	N	N	N	N	0
5490 (FL)	Y	Y	Y	Y	Y	Y	Y	Y	Y	Y	100
5491	Y	Y	Y	Y	Y	Y	Y	Y	Y	Y	100
5492	Y	Y	Y	Y	Y	Y	Y	Y	Y	Y	100
5493	Y	Y	Y	Y	Y	Y	Y	Y	Y	Y	100
5494	Y	Y	Y	Y	Y	Y	Y	Y	Y	Y	100
5495	Y	Y	Y	Y	Y	Y	Y	Y	Y	Y	100
5496	Y	Y	Y	Y	Y	Y	Y	Y	Y	Y	100
5497	Y	Y	Y	Y	Y	Y	Y	Y	Y	Y	100
5498	Y	Y	Y	Y	Y	Y	Y	Y	Y	Y	100
5499	Y	Y	Y	Y	Y	Y	Y	Y	Y	Y	100
5500	Y	Y	Y	Y	Y	Y	Y	Y	Y	Y	100
5501	Y	Y	Y	Y	Y	Y	Y	Y	Y	Y	100
5502	Y	Y	Y	Y	Y	Y	Y	Y	Y	Y	100
5503	Y	Y	Y	Y	Y	Y	Y	Y	Y	Y	100
5504	Y	Y	Y	Y	Y	Y	Y	Y	Y	Y	100
5505	Y	Y	Y	Y	Y	Y	Y	Y	Y	Y	100
5506	Y	Y	Y	Y	Y	Y	Y	Y	Y	Y	100
5507	Y	Y	Y	Y	Y	Y	Y	Y	Y	Y	100
5508	Y	Y	Y	Y	Y	Y	Y	Y	Y	Y	100
5509	Y	Y	Y	Y	Y	Y	Y	Y	Y	Y	100
5510	Y	Y	Y	Y	Y	Y	Y	Y	Y	Y	100
5511	Y	Y	Y	Y	Y	Y	Y	Y	Y	Y	100
5512	Y	Y	Y	Y	Y	Y	Y	Y	Y	Y	100
5513	Y	Y	Y	Y	Y	Y	Y	Y	Y	Y	100
5514	Y	Y	Y	Y	Y	Y	Y	Y	Y	Y	100
5515	Y	Y	Y	Y	Y	Y	Y	Y	Y	Y	100
5516	Y	Y	Y	Y	Y	Y	Y	Y	Y	Y	100
5517	Y	Y	Y	Y	Y	Y	Y	Y	Y	Y	100
5518	Y	Y	Y	Y	Y	Y	Y	Y	Y	Y	100
5519	Y	Y	Y	Y	Y	Y	Y	Y	Y	Y	100
5520	Y	Y	Y	Y	Y	Y	Y	Y	Y	Y	100
5521	Y	Y	Y	Y	Y	Y	Y	Y	Y	Y	100
5522	Y	Y	Y	Y	Y	Y	Y	Y	Y	Y	100
5523	Y	Y	Y	Y	Y	Y	Y	Y	Y	Y	100
5524	Y	Y	Y	Y	Y	Y	Y	Y	Y	Y	100
5525	Y	Y	Y	Y	Y	Y	Y	Y	Y	Y	100
5526	Y	Y	Y	Y	Y	Y	Y	Y	Y	Y	100
5527	Y	Y	Y	Y	Y	Y	Y	Y	Y	Y	100
5528	Y	Y	Y	Y	Y	Y	Y	Y	Y	Y	100
5529	Y	Y	Y	Y	Y	Y	Y	Y	Y	Y	100
5530 (FH)	Y	Y	Y	Y	Y	Y	Y	Y	Y	Y	100
5531	N	N	N	N	N	N	N	N	N	N	0

Detection Bandwidth Test - IEEE 802.11ac VHT80

Radar Type 0

EUT Frequency: 5530MHz

EUT 99% Power bandwidth: 76MHz

Detection bandwidth limit (100% of EUT 99% Power bandwidth): 76MHz

Detection bandwidth (5329(FH) – 5250(FL)) : 80MHz

Test Result : Pass

Radar Frequency (MHz)	Trial Number / Detection										Detection Rate (%)
	1	2	3	4	5	6	7	8	9	10	
5489	N	N	N	N	N	N	N	N	N	N	0
5490(FL)	Y	Y	Y	Y	Y	Y	Y	Y	Y	Y	100
5491	Y	Y	Y	Y	Y	Y	Y	Y	Y	Y	100
5492	Y	Y	Y	Y	Y	Y	Y	Y	Y	Y	100
5493	Y	Y	Y	Y	Y	Y	Y	Y	Y	Y	100
5494	Y	Y	Y	Y	Y	Y	Y	Y	Y	Y	100
5495	Y	Y	Y	Y	Y	Y	Y	Y	Y	Y	100
5496	Y	Y	Y	Y	Y	Y	Y	Y	Y	Y	100
5497	Y	Y	Y	Y	Y	Y	Y	Y	Y	Y	100
5498	Y	Y	Y	Y	Y	Y	Y	Y	Y	Y	100
5499	Y	Y	Y	Y	Y	Y	Y	Y	Y	Y	100
5500	Y	Y	Y	Y	Y	Y	Y	Y	Y	Y	100
5501	Y	Y	Y	Y	Y	Y	Y	Y	Y	Y	100
5502	Y	Y	Y	Y	Y	Y	Y	Y	Y	Y	100
5503	Y	Y	Y	Y	Y	Y	Y	Y	Y	Y	100
5504	Y	Y	Y	Y	Y	Y	Y	Y	Y	Y	100
5505	Y	Y	Y	Y	Y	Y	Y	Y	Y	Y	100
5506	Y	Y	Y	Y	Y	Y	Y	Y	Y	Y	100
5507	Y	Y	Y	Y	Y	Y	Y	Y	Y	Y	100
5508	Y	Y	Y	Y	Y	Y	Y	Y	Y	Y	100
5509	Y	Y	Y	Y	Y	Y	Y	Y	Y	Y	100
5510	Y	Y	Y	Y	Y	Y	Y	Y	Y	Y	100
5511	Y	Y	Y	Y	Y	Y	Y	Y	Y	Y	100
5512	Y	Y	Y	Y	Y	Y	Y	Y	Y	Y	100
5513	Y	Y	Y	Y	Y	Y	Y	Y	Y	Y	100
5514	Y	Y	Y	Y	Y	Y	Y	Y	Y	Y	100
5515	Y	Y	Y	Y	Y	Y	Y	Y	Y	Y	100
5516	Y	Y	Y	Y	Y	Y	Y	Y	Y	Y	100
5517	Y	Y	Y	Y	Y	Y	Y	Y	Y	Y	100
5518	Y	Y	Y	Y	Y	Y	Y	Y	Y	Y	100
5519	Y	Y	Y	Y	Y	Y	Y	Y	Y	Y	100
5520	Y	Y	Y	Y	Y	Y	Y	Y	Y	Y	100
5521	Y	Y	Y	Y	Y	Y	Y	Y	Y	Y	100
5522	Y	Y	Y	Y	Y	Y	Y	Y	Y	Y	100
5523	Y	Y	Y	Y	Y	Y	Y	Y	Y	Y	100
5524	Y	Y	Y	Y	Y	Y	Y	Y	Y	Y	100
5525	Y	Y	Y	Y	Y	Y	Y	Y	Y	Y	100
5526	Y	Y	Y	Y	Y	Y	Y	Y	Y	Y	100
5527	Y	Y	Y	Y	Y	Y	Y	Y	Y	Y	100
5528	Y	Y	Y	Y	Y	Y	Y	Y	Y	Y	100
5529	Y	Y	Y	Y	Y	Y	Y	Y	Y	Y	100
5530	Y	Y	Y	Y	Y	Y	Y	Y	Y	Y	100
5531	Y	Y	Y	Y	Y	Y	Y	Y	Y	Y	100
5532	Y	Y	Y	Y	Y	Y	Y	Y	Y	Y	100

5533	Y	Y	Y	Y	Y	Y	Y	Y	Y	Y	100
5534	Y	Y	Y	Y	Y	Y	Y	Y	Y	Y	100
5535	Y	Y	Y	Y	Y	Y	Y	Y	Y	Y	100
5536	Y	Y	Y	Y	Y	Y	Y	Y	Y	Y	100
5537	Y	Y	Y	Y	Y	Y	Y	Y	Y	Y	100
5538	Y	Y	Y	Y	Y	Y	Y	Y	Y	Y	100
5539	Y	Y	Y	Y	Y	Y	Y	Y	Y	Y	100
5540	Y	Y	Y	Y	Y	Y	Y	Y	Y	Y	100
5541	Y	Y	Y	Y	Y	Y	Y	Y	Y	Y	100
5542	Y	Y	Y	Y	Y	Y	Y	Y	Y	Y	100
5543	Y	Y	Y	Y	Y	Y	Y	Y	Y	Y	100
5544	Y	Y	Y	Y	Y	Y	Y	Y	Y	Y	100
5545	Y	Y	Y	Y	Y	Y	Y	Y	Y	Y	100
5546	Y	Y	Y	Y	Y	Y	Y	Y	Y	Y	100
5547	Y	Y	Y	Y	Y	Y	Y	Y	Y	Y	100
5548	Y	Y	Y	Y	Y	Y	Y	Y	Y	Y	100
5549	Y	Y	Y	Y	Y	Y	Y	Y	Y	Y	100
5550	Y	Y	Y	Y	Y	Y	Y	Y	Y	Y	100
5551	Y	Y	Y	Y	Y	Y	Y	Y	Y	Y	100
5552	Y	Y	Y	Y	Y	Y	Y	Y	Y	Y	100
5553	Y	Y	Y	Y	Y	Y	Y	Y	Y	Y	100
5554	Y	Y	Y	Y	Y	Y	Y	Y	Y	Y	100
5555	Y	Y	Y	Y	Y	Y	Y	Y	Y	Y	100
5556	Y	Y	Y	Y	Y	Y	Y	Y	Y	Y	100
5557	Y	Y	Y	Y	Y	Y	Y	Y	Y	Y	100
5558	Y	Y	Y	Y	Y	Y	Y	Y	Y	Y	100
5559	Y	Y	Y	Y	Y	Y	Y	Y	Y	Y	100
5560	Y	Y	Y	Y	Y	Y	Y	Y	Y	Y	100
5561	Y	Y	Y	Y	Y	Y	Y	Y	Y	Y	100
5562	Y	Y	Y	Y	Y	Y	Y	Y	Y	Y	100
5563	Y	Y	Y	Y	Y	Y	Y	Y	Y	Y	100
5564	Y	Y	Y	Y	Y	Y	Y	Y	Y	Y	100
5565	Y	Y	Y	Y	Y	Y	Y	Y	Y	Y	100
5566	Y	Y	Y	Y	Y	Y	Y	Y	Y	Y	100
5567	Y	Y	Y	Y	Y	Y	Y	Y	Y	Y	100
5568	Y	Y	Y	Y	Y	Y	Y	Y	Y	Y	100
5569	Y	Y	Y	Y	Y	Y	Y	Y	Y	Y	100
5570(FH)	Y	Y	Y	Y	Y	Y	Y	Y	Y	Y	100
5571	N	N	N	N	N	N	N	N	N	N	0

### 6.2.3 Channel Availability Check Time

If the EUT successfully detected the radar burst, it should be observed as the EUT has no transmissions occurred until the EUT starts transmitting on another channel.

Timing of Radar Signal	Observation	
	EUT	Spectrum Analyzer
Within 1 to 6 second	Detected	No transmissions
Within 54 to 60 second	Detected	No transmissions

### Initial Channel Availability Check Time Channel Availability Check

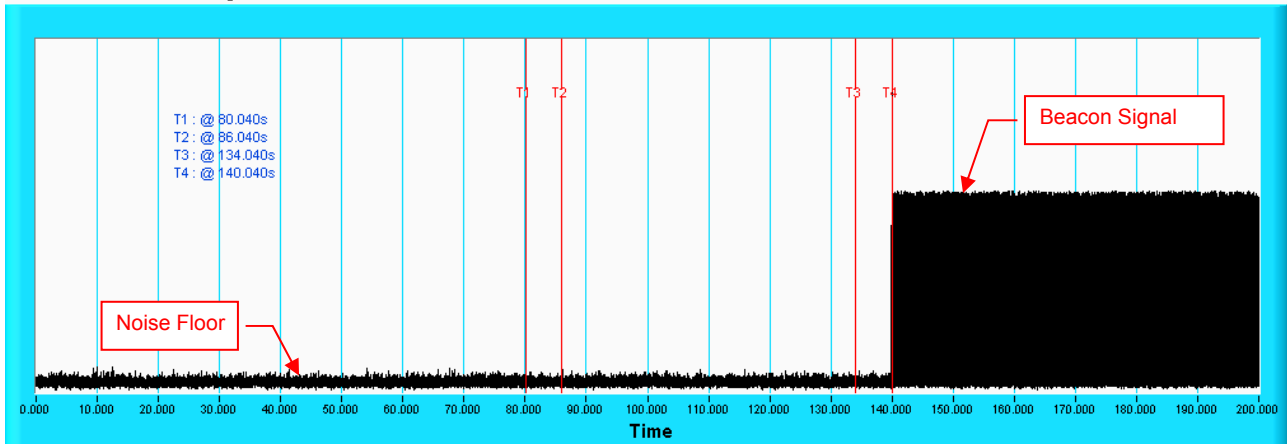

Note: T1 denotes the end of power-up time period is 80.04<sup>th</sup> second. T4 denotes the end of Channel Availability Check time is 140.04<sup>th</sup> second. Channel Availability Check time is equal to ( T4 – T1 ) 60 seconds.  
**Radar Burst at the Beginning of the Channel Availability Check Time**

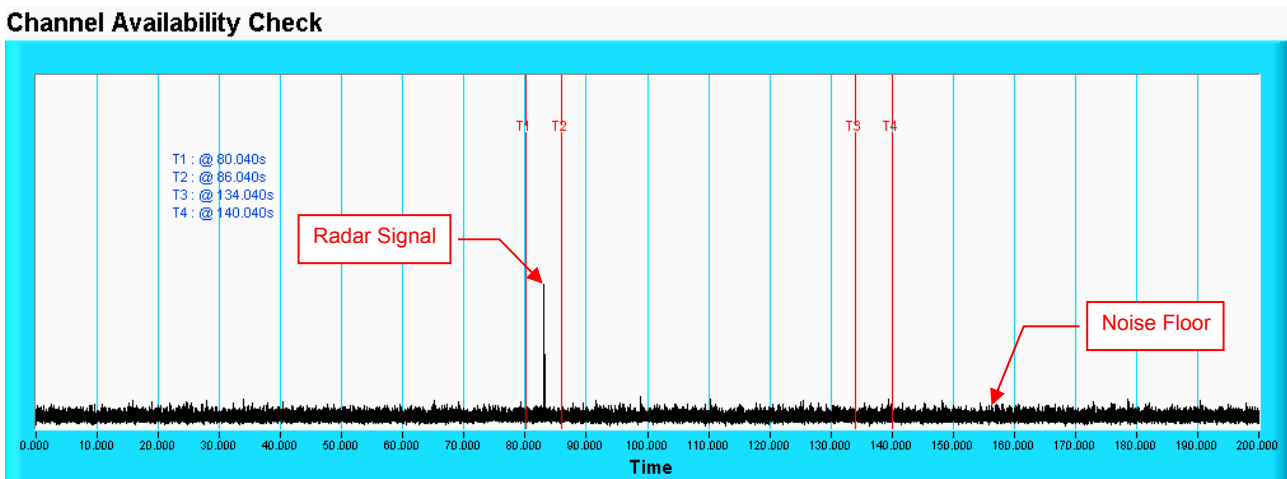

Note: T1 denotes the end of power up time period is 80.04<sup>th</sup> second. T2 denotes 86.04<sup>th</sup> second, the radar burst was commenced within a 6 second window starting from the end of power-up sequence. T4 denotes the 140.04<sup>th</sup> second.

### Radar Burst at the End of the Channel Availability Check Time

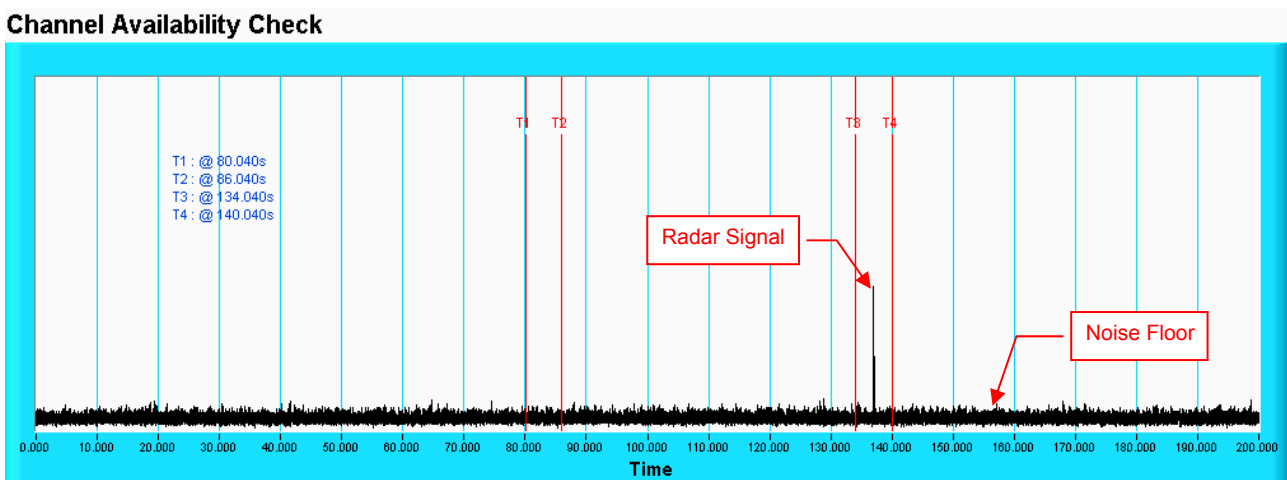

Note: T1 denotes the end of power up time period is 80.04<sup>th</sup> second. T3 denotes 134.04<sup>th</sup> second and radar burst was commenced within 54<sup>th</sup> second to 60<sup>th</sup> second window starting from the end of power-up sequence. T4 denotes the 140.04<sup>th</sup> second.



## 6.2.4 Channel Closing Transmission and Channel Move Time

### Wireless Traffic Loading IEEE 802.11ac VHT20 Duty Cycle

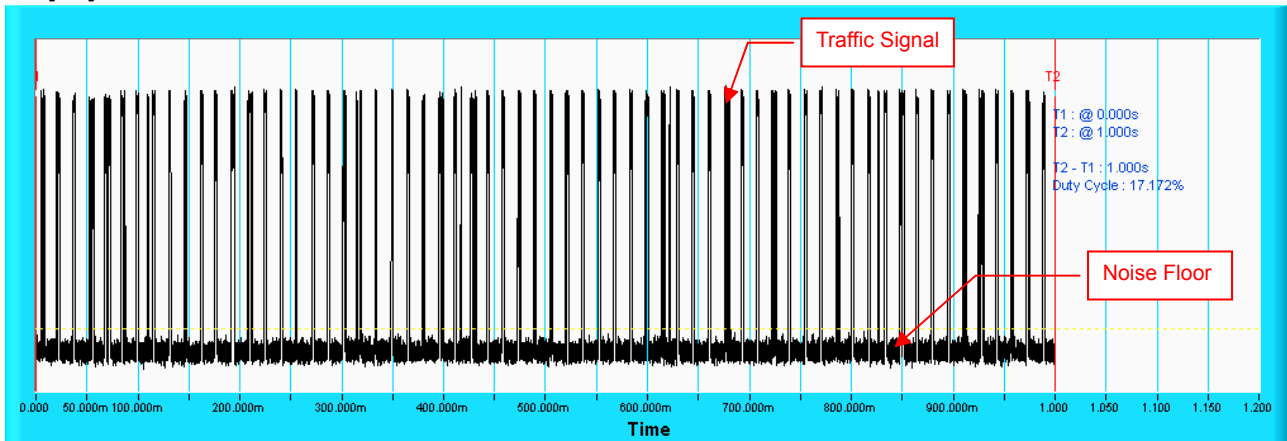

### IEEE 802.11ac VHT40 Duty Cycle

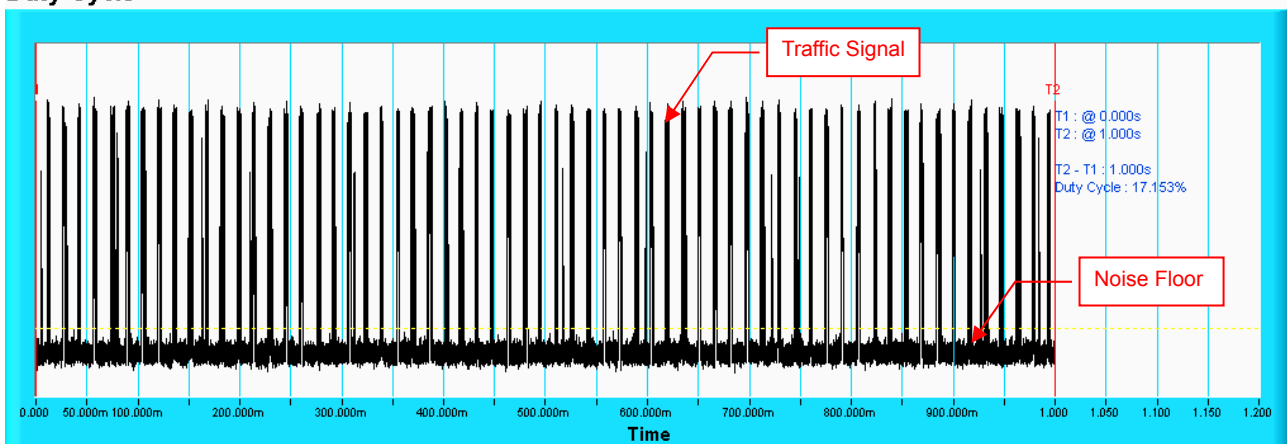

### IEEE 802.11ac VHT80 Duty Cycle

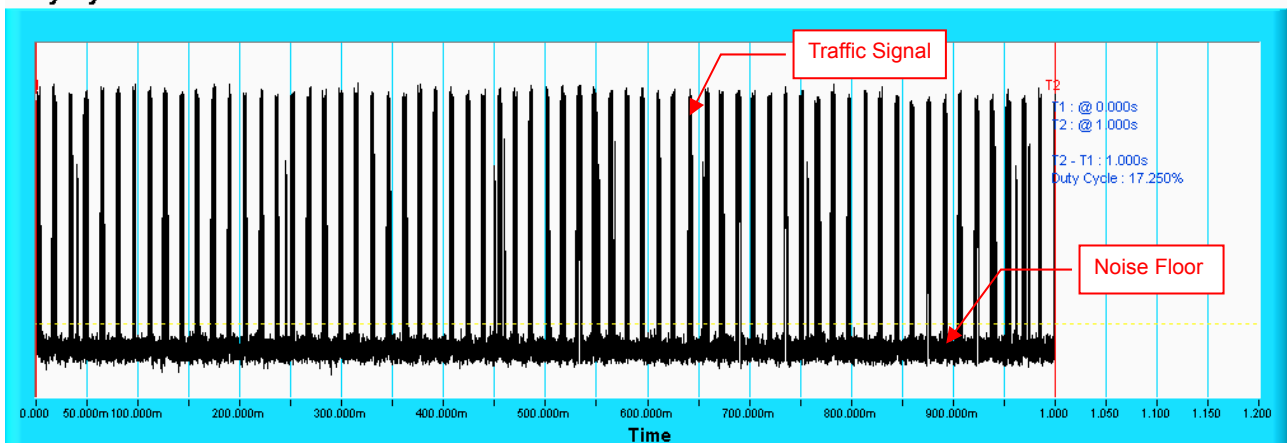

**Radar signal 0**  
**IEEE 802.11ac VHT80**  
**Channel Closing Transmission Time & Channel Move Time**

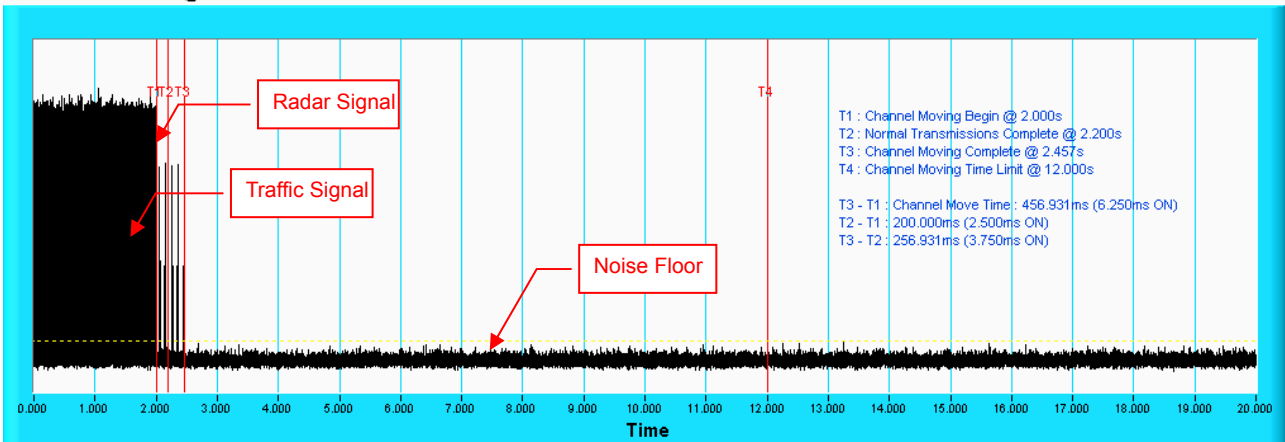

Note: T1 denotes the start of Channel Move Time upon the end of the last Radar burst. T2 denotes the data transmission time of 200ms from T1. T3 denotes the end of Channel Move Time. T4 denotes the 10 second from T1 to observe the aggregate duration of transmissions.

**Channel Closing Transmission Time & Channel Move Time**

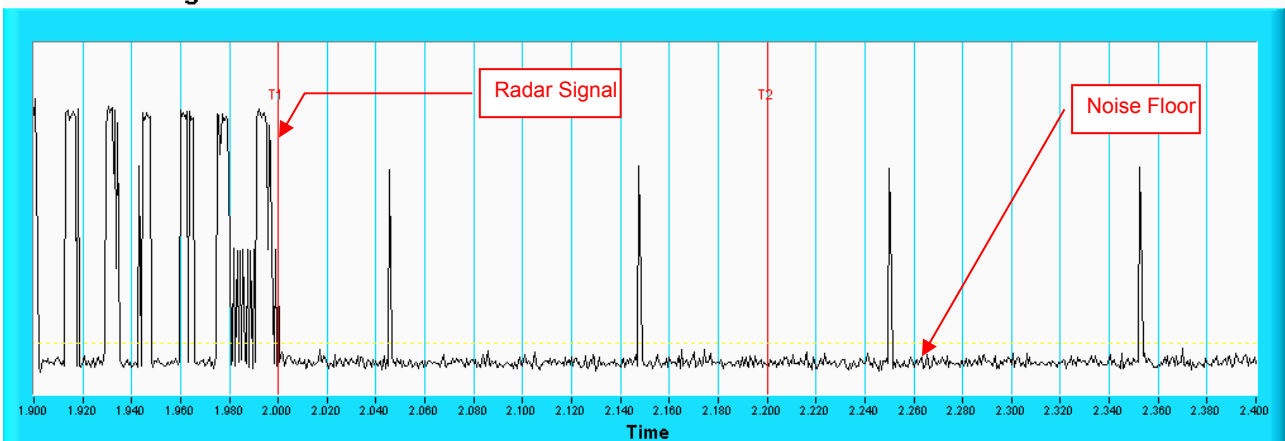

Note: Zoom-in of the first 500ms after radar signal applied.

**Radar signal 1**  
**IEEE 802.11ac VHT80**  
**Channel Closing Transmission Time & Channel Move Time**

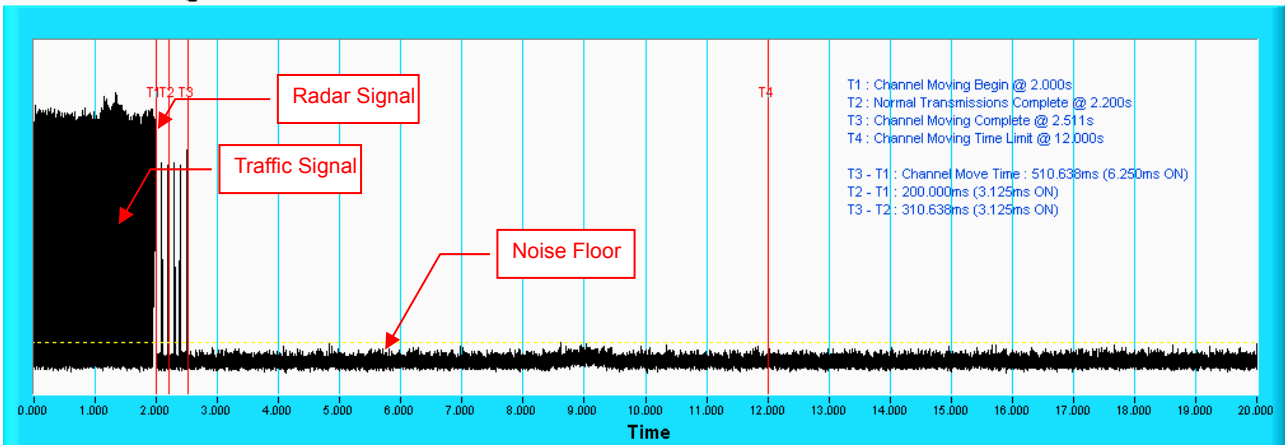

Note: T1 denotes the start of Channel Move Time upon the end of the last Radar burst. T2 denotes the data transmission time of 200ms from T1. T3 denotes the end of Channel Move Time. T4 denotes the 10 second from T1 to observe the aggregate duration of transmissions.

**Channel Closing Transmission Time & Channel Move Time**

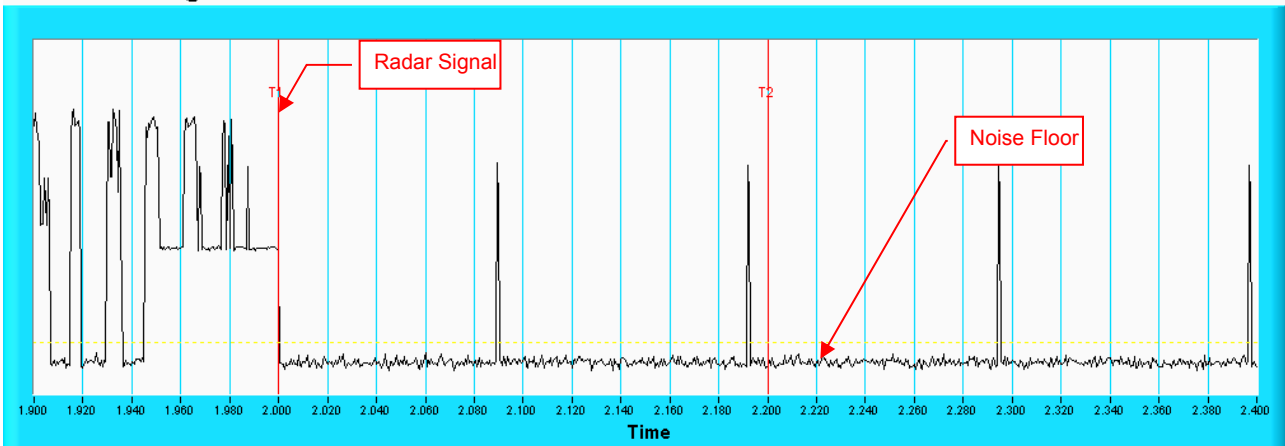

Note: Zoom-in of the first 500ms after radar signal applied.

**Radar signal 2**  
**IEEE 802.11ac VHT80**  
**Channel Closing Transmission Time & Channel Move Time**

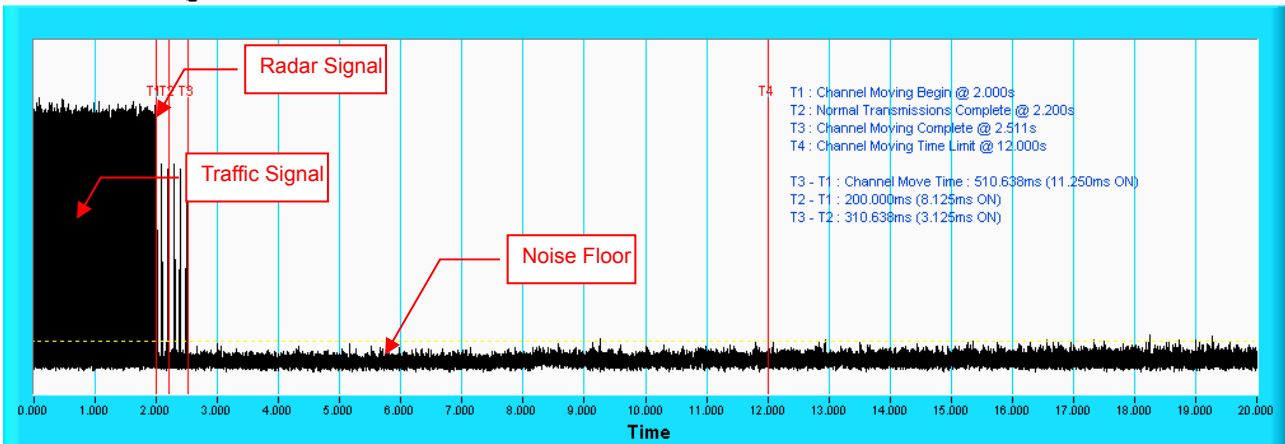

Note: T1 denotes the start of Channel Move Time upon the end of the last Radar burst. T2 denotes the data transmission time of 200ms from T1. T3 denotes the end of Channel Move Time. T4 denotes the 10 second from T1 to observe the aggregate duration of transmissions.

**Channel Closing Transmission Time & Channel Move Time**

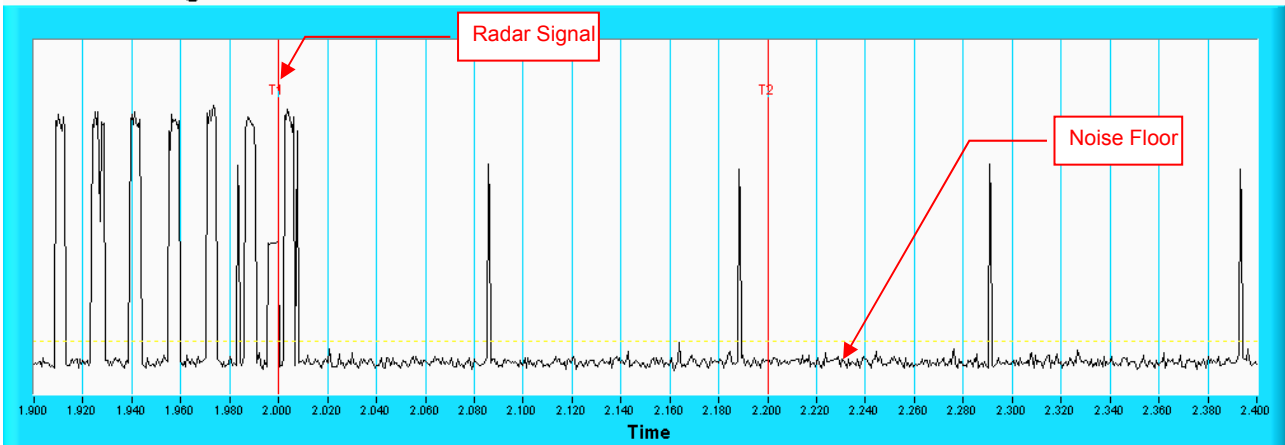

Note: Zoom-in of the first 500ms after radar signal applied.

**Radar signal 3**  
**IEEE 802.11ac VHT80**  
**Channel Closing Transmission Time & Channel Move Time**

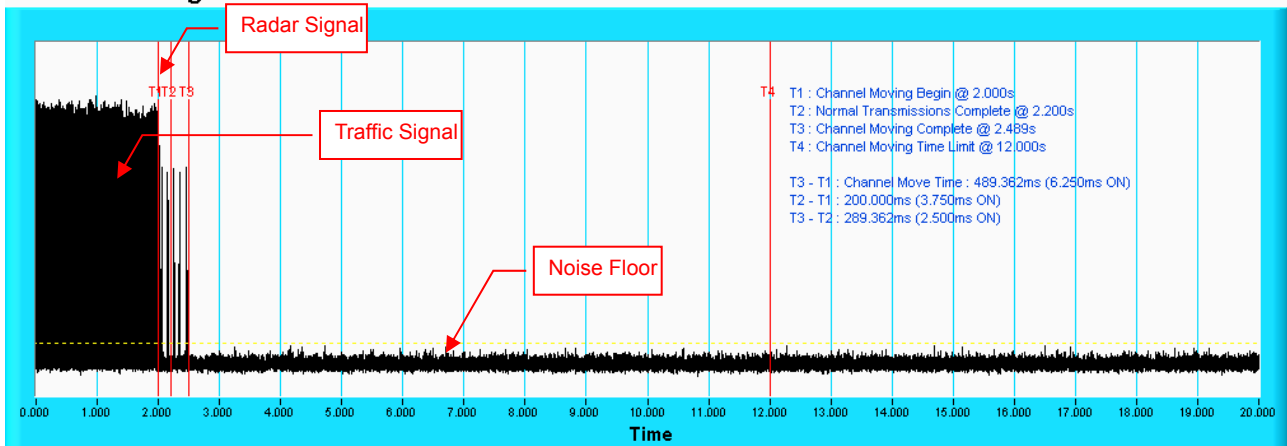

Note: T1 denotes the start of Channel Move Time upon the end of the last Radar burst. T2 denotes the data transmission time of 200ms from T1. T3 denotes the end of Channel Move Time. T4 denotes the 10 second from T1 to observe the aggregate duration of transmissions.

**Channel Closing Transmission Time & Channel Move Time**

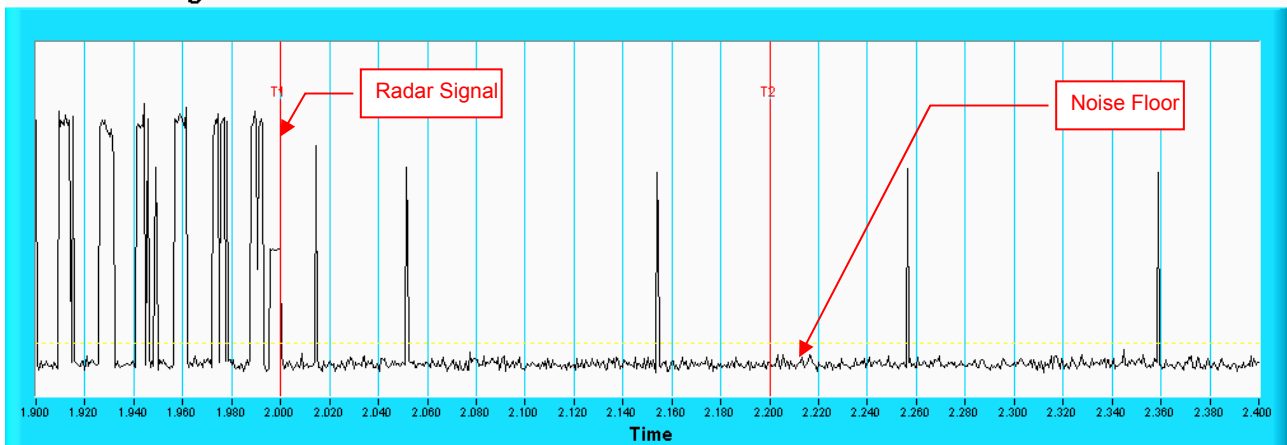

Note: Room-in of the first 500ms after radar signal applied.

**Radar signal 4**  
**IEEE 802.11ac VHT80**  
**Channel Closing Transmission Time & Channel Move Time**

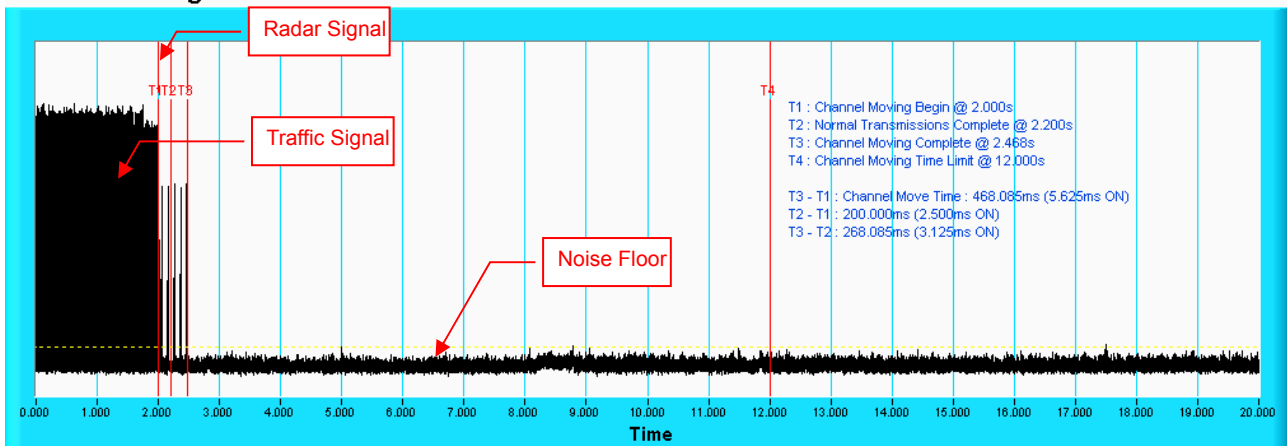

Note: T1 denotes the start of Channel Move Time upon the end of the last Radar burst. T2 denotes the data transmission time of 200ms from T1. T3 denotes the end of Channel Move Time. T4 denotes the 10 second from T1 to observe the aggregate duration of transmissions.

**Channel Closing Transmission Time & Channel Move Time**

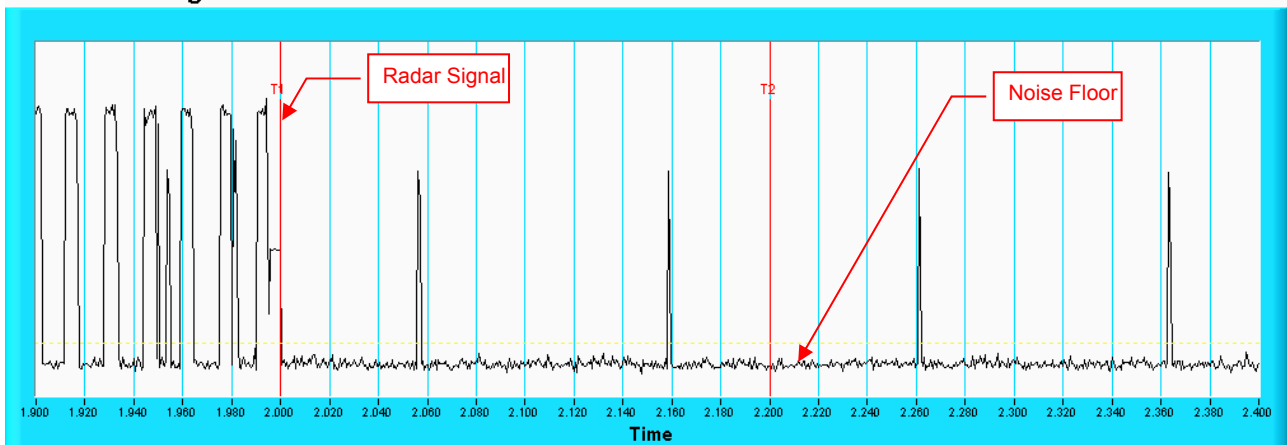

Note: Room-in of the first 500ms after radar signal applied.

**IEEE 802.11ac VHT20**

Table 1: Short Pulse Radar Test Waveforms.

Radar Type	Pulse Width (μsec)	PRI (μsec)	Number of Pulses	Number of Trials(Times)	Percentage of Successful Detection (%)
1	1	Test A: 15 unique PRI values randomly selected from the list of 23 PRI values in Table 5a	Roundup $\left\{ \begin{matrix} \left( \frac{1}{360} \right) \cdot \\ \left( \frac{19 \cdot 10^6}{PRI_{\mu sec}} \right) \end{matrix} \right\}$	30	96.67
		Test B: 15 unique PRI values randomly selected within the range of 518-3066 μ sec, with a minimum increment of 1 μ sec, excluding PRI values selected in Test A			
2	1-5	150-230	23-29	30	86.67
3	6-10	200-500	16-18	30	76.67
4	11-20	200-500	12-16	30	86.67
Aggregate (Radar Types 1-4)				120	86.67

Table 2: Long Pulse Radar Test Waveform

Radar Type	Pulse Width (μsec)	Chirp Width (MHz)	PRI (μsec)	Number of Pulses per Burst	Number of Bursts	Number of Trials(Times)	Percentage of Successful Detection (%)
5	50-100	5-20	1000-2000	1-3	8-20	30	90

Table 3: Frequency Hopping Radar Test Waveform

Radar Type	Pulse Width (μsec)	PRI (μsec)	Pulses per Hop	Hopping Rate (kHz)	Hopping Sequence Length (msec)	Number of Trials(Times)	Percentage of Successful Detection (%)
6	1	333	9	0.333	300	30	100

The Detailed Radar pattern and Statistical Performance showed in Annex A.

**IEEE 802.11ac VHT40**

Table 1: Short Pulse Radar Test Waveforms.

Radar Type	Pulse Width (μsec)	PRI (μsec)	Number of Pulses	Number of Trials(Times)	Percentage of Successful Detection (%)
1	1	Test A: 15 unique PRI values randomly selected from the list of 23 PRI values in Table 5a	Roundup $\left\{ \begin{array}{l} \left( \frac{1}{360} \right) \cdot \\ \left( \frac{19 \cdot 10^6}{\text{PRI}_{\mu\text{sec}}} \right) \end{array} \right\}$	30	100
		Test B: 15 unique PRI values randomly selected within the range of 518-3066 μ sec, with a minimum increment of 1 μ sec, excluding PRI values selected in Test A			
2	1-5	150-230	23-29	30	96.67
3	6-10	200-500	16-18	30	83.33
4	11-20	200-500	12-16	30	66.67
Aggregate (Radar Types 1-4)				120	86.67

Table 2: Long Pulse Radar Test Waveform

Radar Type	Pulse Width (μsec)	Chirp Width (MHz)	PRI (μsec)	Number of Pulses per Burst	Number of Bursts	Number of Trials(Times)	Percentage of Successful Detection (%)
5	50-100	5-20	1000-2000	1-3	8-20	30	100

Table 3: Frequency Hopping Radar Test Waveform

Radar Type	Pulse Width (μsec)	PRI (μsec)	Pulses per Hop	Hopping Rate (kHz)	Hopping Sequence Length (msec)	Number of Trials(Times)	Percentage of Successful Detection (%)
6	1	333	9	0.333	300	30	100

The Detailed Radar pattern and Statistical Performance showed in Annex A.



**IEEE 802.11ac VHT80**

Table 1: Short Pulse Radar Test Waveforms.

Radar Type	Pulse Width (μsec)	PRI (μsec)	Number of Pulses	Number of Trials(Times)	Percentage of Successful Detection (%)
1	1	Test A: 15 unique PRI values randomly selected from the list of 23 PRI values in Table 5a	Roundup $\left\{ \begin{array}{l} \left( \frac{1}{360} \right) \cdot \\ \left( \frac{19 \cdot 10^6}{\text{PRI}_{\mu\text{sec}}} \right) \end{array} \right\}$	30	100
		Test B: 15 unique PRI values randomly selected within the range of 518-3066 μ sec, with a minimum increment of 1 μ sec, excluding PRI values selected in Test A			
2	1-5	150-230	23-29	30	93.33
3	6-10	200-500	16-18	30	93.33
4	11-20	200-500	12-16	30	80
Aggregate (Radar Types 1-4)				120	91.67

Table 2: Long Pulse Radar Test Waveform

Radar Type	Pulse Width (μsec)	Chirp Width (MHz)	PRI (μsec)	Number of Pulses per Burst	Number of Bursts	Number of Trials(Times)	Percentage of Successful Detection (%)
5	50-100	5-20	1000-2000	1-3	8-20	30	100

Table 3: Frequency Hopping Radar Test Waveform

Radar Type	Pulse Width (μsec)	PRI (μsec)	Pulses per Hop	Hopping Rate (kHz)	Hopping Sequence Length (msec)	Number of Trials(Times)	Percentage of Successful Detection (%)
6	1	333	9	0.333	300	30	100

The Detailed Radar pattern and Statistical Performance showed in Annex A.

## 6.2.5 Non- Occupancy Period

### Associate test:

During the 30 minutes observation time, UUT did not make any transmissions on a channel after a radar signal was detected on that channel by either the Channel Availability Check or the In-Service Monitoring.

- 1) EUT (Client) links with master on 5500MHz.

Waveform of EUT links up with Master

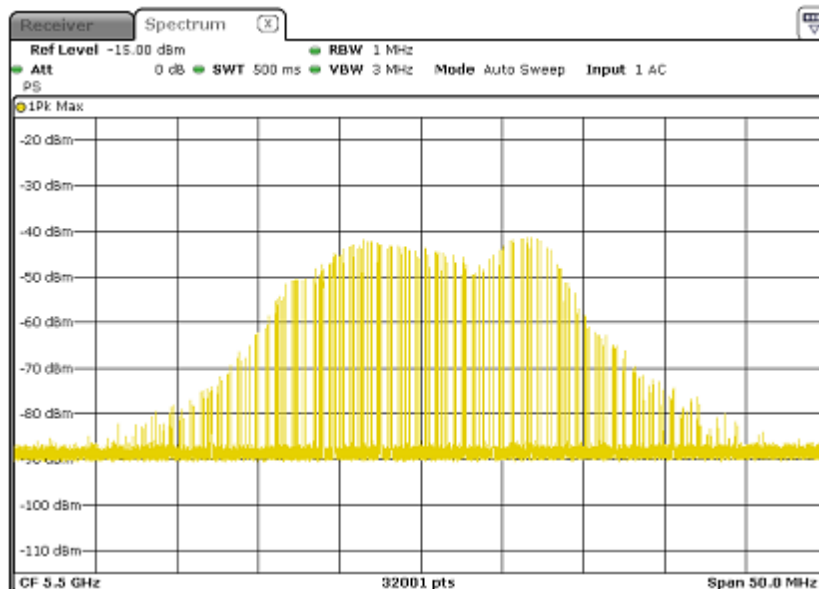

- 2) Client plays specified files via master.

Waveform of transmission

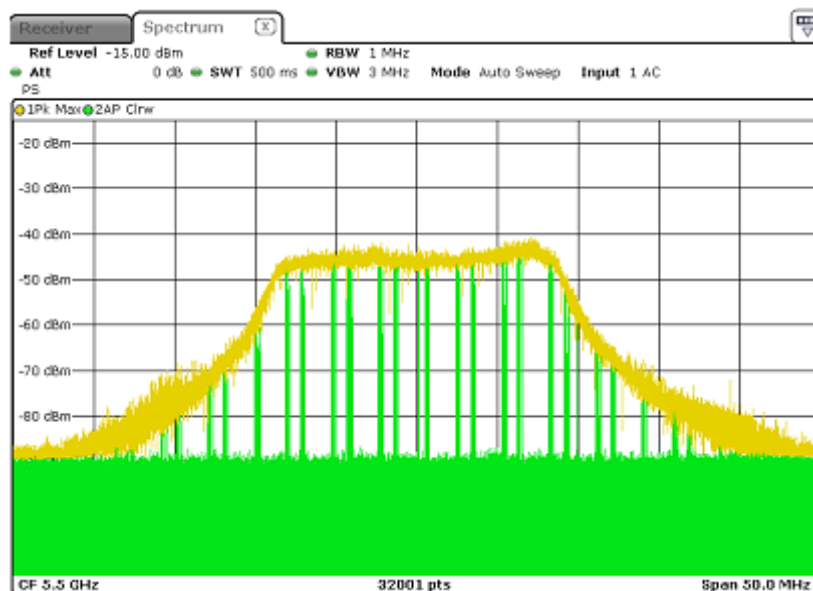

3) Radar signal is applied to the Master device and WiFi traffic signal stop immediately.

Radar 0

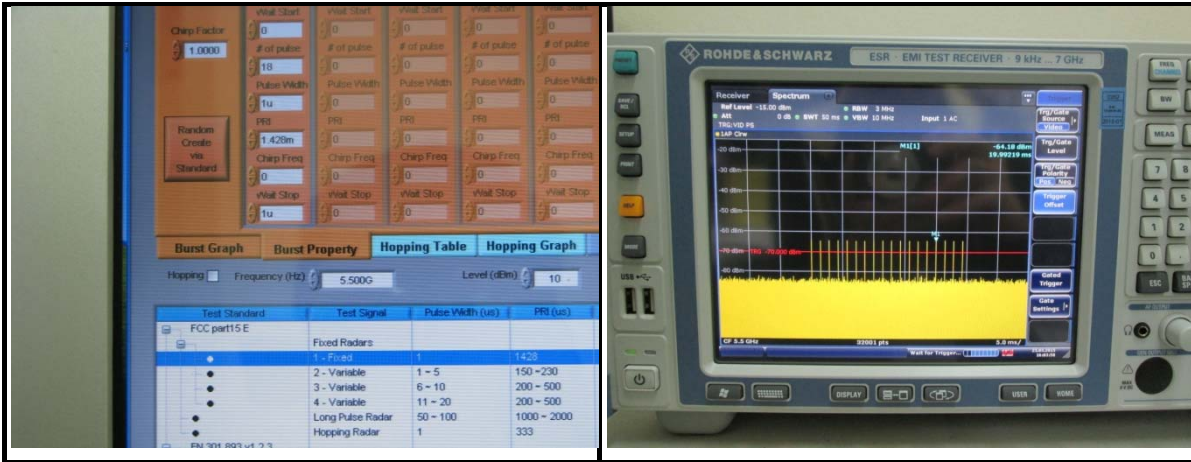

Radar 1

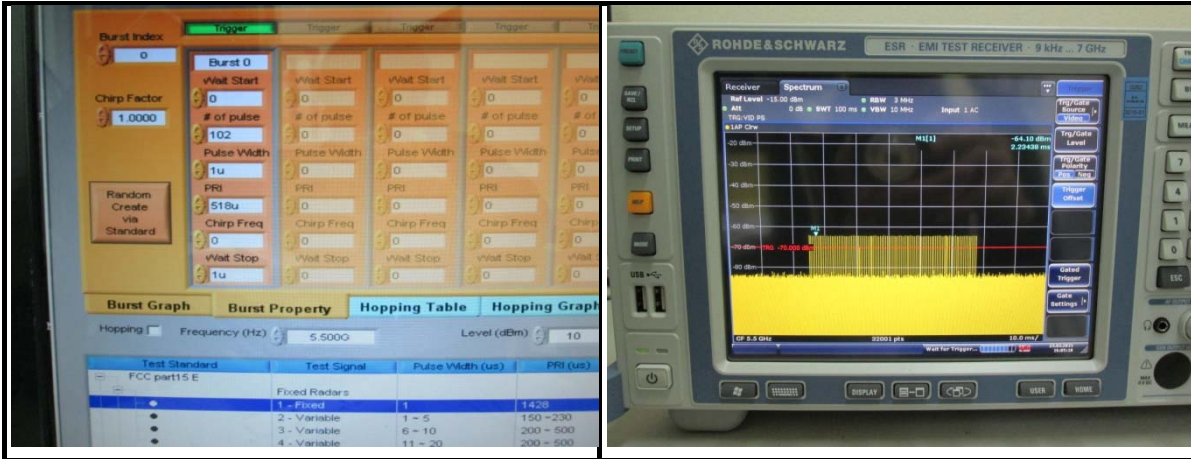

Radar 2



### Radar 3

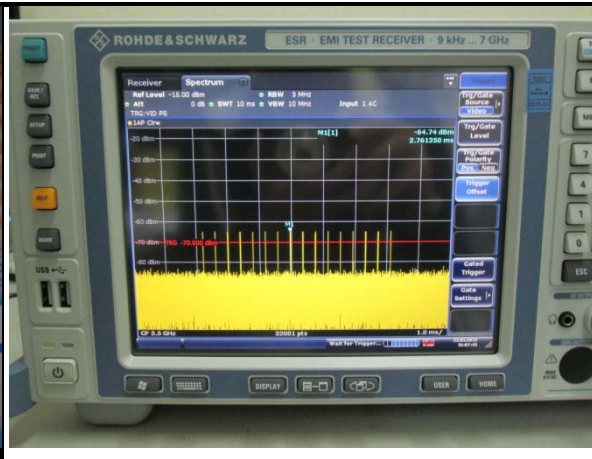

### Radar 4

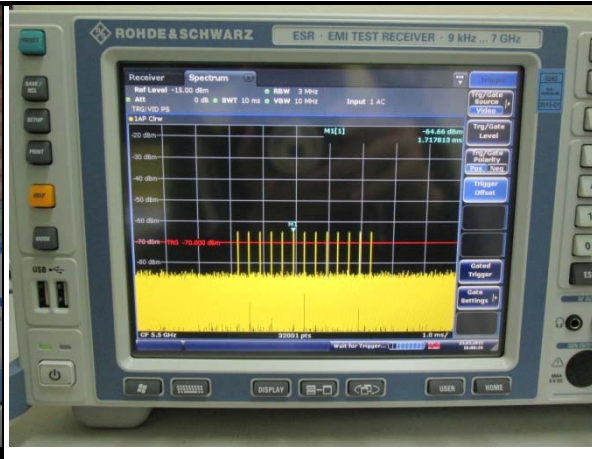
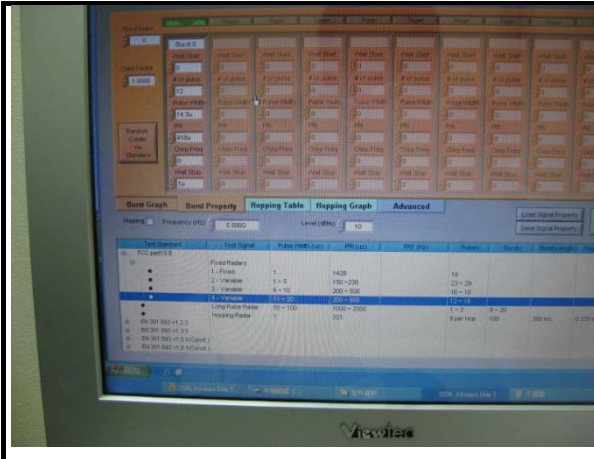

### Radar 5

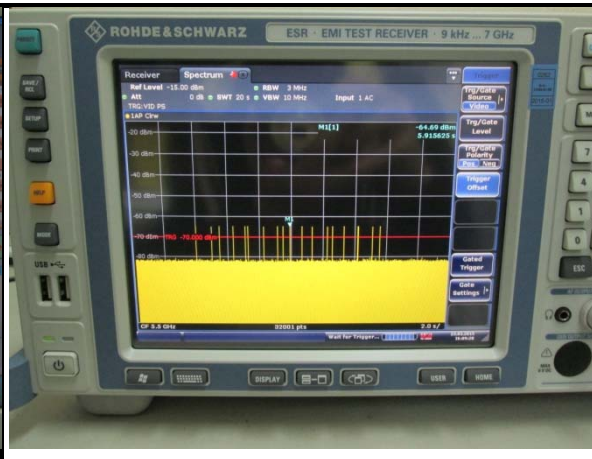
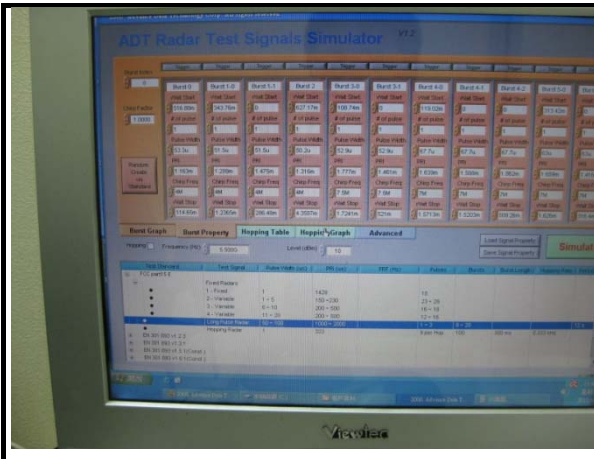

### Radar 6

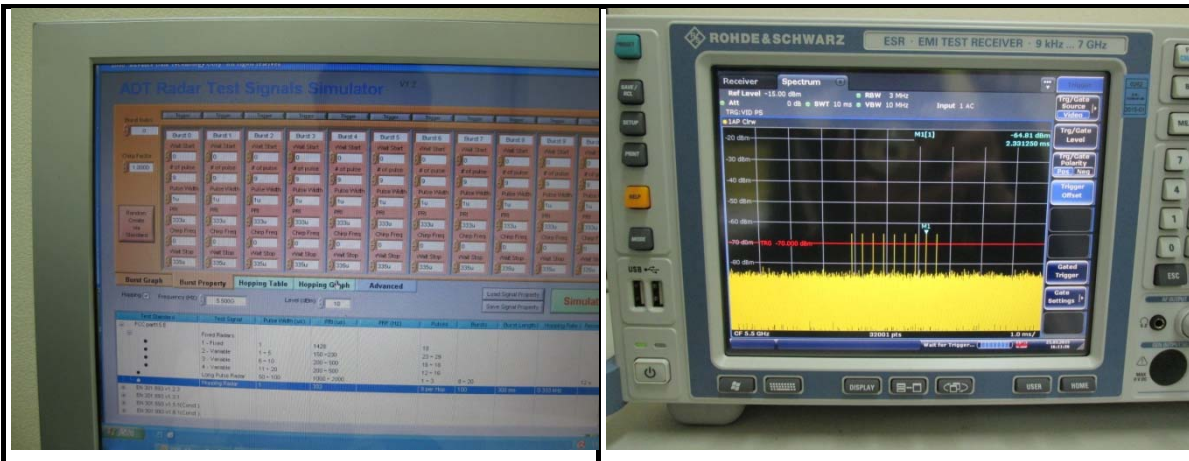

4) 5300MHz has been monitored in 30 minutes period. In this period, no any transmission occurs.

Plot of 30minutes period

### 802.11ac VHT20

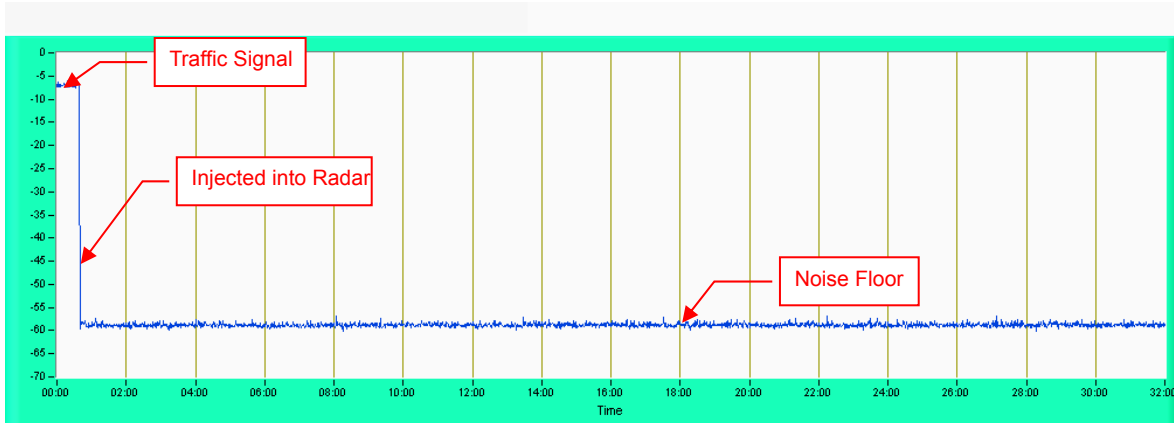

Note: Test setup are shown on Test setup photo.pdf

#### 6.2.6 Uniform Spreading

The intention of the uniform spreading is to provide, on aggregate, a uniform loading of the spectrum. The EUT randomly select next output channel without any bias or fixed pattern, so that all channels in DFS bands (5250 MHz to 5350 MHz) will be used equally.

#### 6.2.7 Transmit power control (TPC)

TPC	E.I.R.P	FCC 15.407(h)(1)
√	> 500mW	The TPC mechanism is required for system with an E.I.R.P. of above 500mW
	< 500mW	The TPC mechanism is not required for system with an E.I.R.P. of less 500mW

## 7 Information on the Testing Laboratories

We, Bureau Veritas Consumer Products Services (H.K.) Ltd., Taoyuan Branch, were founded in 1988 to provide our best service in EMC, Radio, Telecom and Safety consultation. Our laboratories are FCC recognized accredited test firms and accredited and approved according to ISO/IEC 17025.

If you have any comments, please feel free to contact us at the following:

**Linko EMC/RF Lab**

Tel: 886-2-26052180  
Fax: 886-2-26051924

**Hsin Chu EMC/RF/Telecom Lab**

Tel: 886-3-6668565  
Fax: 886-3-6668323

**Hwa Ya EMC/RF/Safety Lab:**

Tel: 886-3-3183232  
Fax: 886-3-3270892

**Email:** [service.adt@tw.bureauveritas.com](mailto:service.adt@tw.bureauveritas.com)

**Web Site:** [www.bureauveritas-adt.com](http://www.bureauveritas-adt.com)

The address and road map of all our labs can be found in our web site also.

--- END ---

**Annex-A**

**Annex A.1 : The Detailed Radar pattern and Statistical Performance**

**IEEE 802.11ac VHT20**

Type 1 Radar Statistical Performances						
Trial #	Pulse Repetition Frequency Number(1 to 23)	PRF(Pulse per seconds)	Pulses per Burst	PRI ( $\mu$ sec)	Radar Frequency (MHz)	Detection
1	22	1066.1	57	938	5493	Yes
2	10	1432.7	76	698	5502	Yes
3	6	1618.1	86	618	5504	Yes
4	2	1858.7	99	538	5494	Yes
5	19	1139	61	878	5495	Yes
6	23	326.2	18	3066	5507	No
7	7	1567.4	83	638	5509	Yes
8	21	1089.3	58	918	5503	Yes
9	17	1193.3	63	838	5499	Yes
10	18	1165.6	62	858	5497	Yes
11	15	1253.1	67	798	5501	Yes
12	11	1392.8	74	718	5505	Yes
13	4	1730.1	92	578	5491	Yes
14	5	1672.2	89	598	5500	Yes
15	3	1792.1	95	558	5508	Yes
16		394.3	21	2536	5496	Yes
17		1035.2	55	966	5492	Yes
18		1209.2	64	827	5498	Yes
19		399.8	22	2501	5506	Yes
20		385.4	21	2595	5497	Yes
21		897.7	48	1114	5508	Yes
22		768.0	41	1302	5507	Yes
23		328.4	18	3045	5501	Yes
24		615.8	33	1624	5503	Yes
25		347.5	19	2878	5506	Yes
26		973.7	52	1027	5493	Yes
27		402.4	22	2485	5498	Yes
28		625.0	33	1600	5496	Yes
29		853.2	46	1172	5509	Yes
30		849.6	45	1177	5494	Yes
Detection Rate: 96.67 %						

Type 2 Radar Statistical Performances					
Trial #	Pulses per Burst	Pulse Width ( $\mu$ sec)	PRI ( $\mu$ sec)	Radar Frequency (MHz)	Detection
1	26	3.2	179	5491	Yes
2	23	1.1	207	5497	Yes
3	24	2.1	230	5493	No
4	29	4.8	200	5492	Yes
5	28	3.9	214	5494	Yes
6	26	2.9	222	5496	Yes
7	26	3.2	204	5503	Yes
8	25	2.5	192	5498	Yes
9	26	3.1	164	5505	Yes
10	23	1.2	156	5507	Yes
11	27	3.9	210	5508	Yes
12	29	4.6	201	5502	Yes
13	26	3.2	162	5504	Yes
14	25	2.2	197	5509	Yes
15	29	4.5	163	5501	Yes
16	26	3	203	5506	Yes
17	29	5	168	5499	Yes
18	25	2.4	217	5495	Yes
19	26	2.9	191	5500	Yes
20	25	2.3	166	5499	No
21	27	3.7	150	5496	Yes
22	25	2.2	176	5493	Yes
23	29	4.9	195	5503	Yes
24	26	2.9	202	5495	Yes
25	25	2.5	178	5498	Yes
26	23	1.1	206	5507	No
27	27	3.8	155	5504	No
28	29	4.7	157	5501	Yes
29	25	2.4	224	5508	Yes
30	28	4.2	159	5500	Yes
					Detection Rate: 86.67 %



Type 3 Radar Statistical Performances					
Trial #	Pulses per Burst	Pulse Width ( $\mu$ sec)	PRI ( $\mu$ sec)	Radar Frequency (MHz)	Detection
1	17	8.2	355	5498	Yes
2	16	6.1	487	5492	Yes
3	16	7.1	344	5500	No
4	18	9.8	288	5508	Yes
5	18	8.9	230	5495	No
6	17	7.9	432	5496	Yes
7	17	8.2	207	5497	Yes
8	17	7.5	443	5491	Yes
9	17	8.1	439	5504	No
10	16	6.2	223	5501	Yes
11	18	8.9	208	5494	Yes
12	18	9.6	463	5503	Yes
13	17	8.2	441	5493	No
14	16	7.2	323	5502	No
15	18	9.5	297	5499	Yes
16	17	8	412	5505	Yes
17	18	10	324	5506	Yes
18	17	7.4	271	5509	No
19	17	7.9	349	5507	Yes
20	16	7.3	409	5504	Yes
21	18	8.7	373	5491	Yes
22	16	7.2	254	5500	Yes
23	18	9.9	274	5494	Yes
24	17	7.9	278	5506	Yes
25	17	7.5	317	5502	Yes
26	16	6.1	260	5492	Yes
27	18	8.8	211	5493	Yes
28	18	9.7	272	5503	Yes
29	17	7.4	264	5498	No
30	18	9.2	284	5508	Yes
					Detection Rate: 76.67 %

Type 4 Radar Statistical Performances					
Trial #	Pulses per Burst	Pulse Width ( $\mu$ sec)	PRI ( $\mu$ sec)	Radar Frequency (MHz)	Detection
1	14	16	355	5506	Yes
2	12	11.3	487	5495	Yes
3	13	13.5	344	5501	Yes
4	16	19.4	288	5507	Yes
5	15	17.5	230	5492	Yes
6	14	15.3	432	5499	No
7	14	15.9	207	5497	Yes
8	13	14.3	443	5496	Yes
9	14	15.8	439	5498	Yes
10	12	11.5	223	5500	Yes
11	15	17.4	208	5509	Yes
12	16	19	463	5504	Yes
13	14	16	441	5494	Yes
14	13	13.8	323	5493	No
15	16	18.9	297	5505	Yes
16	14	15.5	412	5503	Yes
17	16	19.9	324	5502	Yes
18	13	14.1	271	5491	Yes
19	14	15.2	349	5508	Yes
20	13	13.8	409	5507	Yes
21	15	17.1	373	5499	Yes
22	13	13.8	254	5497	Yes
23	16	19.8	274	5491	Yes
24	14	15.3	278	5495	Yes
25	13	14.5	317	5506	Yes
26	12	11.3	260	5504	Yes
27	15	17.3	211	5503	No
28	16	19.2	272	5500	Yes
29	13	14.2	264	5492	No
30	15	18.2	284	5493	Yes
					Detection Rate: 86.67 %

Type 5 Radar Statistical Performances		
Trial #	Test Signal Name	Detection
1	LP_Signal_01	Yes
2	LP_Signal_02	Yes
3	LP_Signal_03	Yes
4	LP_Signal_04	Yes
5	LP_Signal_05	Yes
6	LP_Signal_06	Yes
7	LP_Signal_07	Yes
8	LP_Signal_08	Yes
9	LP_Signal_09	Yes
10	LP_Signal_10	Yes
11	LP_Signal_11	Yes
12	LP_Signal_12	No
13	LP_Signal_13	No
14	LP_Signal_14	Yes
15	LP_Signal_15	Yes
16	LP_Signal_16	Yes
17	LP_Signal_17	Yes
18	LP_Signal_18	Yes
19	LP_Signal_19	Yes
20	LP_Signal_20	No
21	LP_Signal_21	Yes
22	LP_Signal_22	Yes
23	LP_Signal_23	Yes
24	LP_Signal_24	Yes
25	LP_Signal_25	Yes
26	LP_Signal_26	Yes
27	LP_Signal_27	Yes
28	LP_Signal_28	Yes
29	LP_Signal_29	Yes
30	LP_Signal_30	Yes
		<b>Detection Rate: 90 %</b>

Long Pulse Radar Test Signal						
Test Signal Name: LP_Signal_01						
Number of Bursts in Trial: 17						
Chrip Center Frequency: 5500MHz						
Burst	Pulse	Chrip	Number of	PRI-1 (us)	PRI-2 (us)	PRI-3 (us)

	Width (us)	Width (MHz)	Pulses per Burst			
1	85.3	16	3	1590.0	1009.0	1631.0
2	60.1	16	1	1810.0	-	-
3	71.4	16	2	1177.0	1818.0	-
4	81.5	16	2	1846.0	1439.0	-
5	61.2	16	1	1330.0	-	-
6	75.9	16	2	1070.0	1778.0	-
7	95.5	16	3	1207.0	1585.0	1839.0
8	86.3	16	3	1174.0	1154.0	1900.0
9	52.1	16	1	1906.0	-	-
10	91.1	16	3	1628.0	1455.0	1251.0
11	98.5	16	3	1256.0	1484.0	1697.0
12	96.6	16	3	1134.0	1008.0	1845.0
13	85.3	16	3	1496.0	1181.0	1873.0
14	55.7	16	1	1762.0	-	-
15	65.1	16	1	1722.0	-	-
16	76.9	16	2	1223.0	1482.0	-
17	97.2	16	3	1958.0	1899.0	1898.0

Long Pulse Radar Test Signal						
Test Signal Name: LP_Signal_02						
Number of Bursts in Trial: 10						
Chirp Center Frequency: 5500MHz						
Burst	Pulse Width (us)	Chirp Width (MHz)	Number of Pulses per Burst	PRI-1 (us)	PRI-2 (us)	PRI-3 (us)
1	69.6	8	2	1094.0	1287.0	-
2	51.9	8	1	1701.0	-	-
3	87.4	8	3	1564.0	1236.0	1690.0
4	89.6	8	3	1453.0	1739.0	1476.0
5	85.6	8	3	1687.0	1053.0	1740.0
6	56.8	8	1	1395.0	-	-
7	52.4	8	1	1911.0	-	-
8	74.9	8	2	1835.0	1197.0	-
9	83.9	8	3	1592.0	1755.0	1147.0
10	65.5	8	1	1113.0	-	-

Long Pulse Radar Test Signal						
Test Signal Name: LP_Signal_03						

Number of Bursts in Trial: 13						
Chirp Center Frequency: 5500MHz						
Burst	Pulse Width (us)	Chirp Width (MHz)	Number of Pulses per Burst	PRI-1 (us)	PRI-2 (us)	PRI-3 (us)
1	84.5	11	3	1296.0	1001.0	1945.0
2	69.4	11	2	1149.0	1199.0	-
3	50.7	11	1	1016.0	-	-
4	74.6	11	2	1487.0	1362.0	-
5	88.1	11	3	1610.0	1471.0	1510.0
6	76.7	11	2	1922.0	1806.0	-
7	53.5	11	1	1872.0	-	-
8	98.9	11	3	1929.0	1893.0	1015.0
9	84.1	11	3	1821.0	1284.0	1242.0
10	86.8	11	3	1397.0	1787.0	1158.0
11	71.8	11	2	1696.0	1731.0	-
12	66.3	11	1	1853.0	-	-
13	53.9	11	1	1889.0	-	-

Long Pulse Radar Test Signal						
Test Signal Name: LP_Signal_04						
Number of Bursts in Trial: 16						
Chirp Center Frequency: 5500MHz						
Burst	Pulse Width (us)	Chirp Width (MHz)	Number of Pulses per Burst	PRI-1 (us)	PRI-2 (us)	PRI-3 (us)
1	58.9	15	1	1279.0	-	-
2	87.3	15	3	1143.0	1203.0	1752.0
3	67.3	15	2	1785.0	1051.0	-
4	72.7	15	2	1732.0	1953.0	-
5	87.3	15	3	1621.0	1087.0	1491.0
6	72.3	15	2	1437.0	1970.0	-
7	53.3	15	1	1630.0	-	-
8	80.4	15	2	1868.0	1469.0	-
9	68.2	15	2	1798.0	1071.0	-
10	74.6	15	2	1591.0	1292.0	-
11	72.7	15	2	1159.0	1306.0	-
12	81.6	15	2	1577.0	1187.0	-
13	54.7	15	1	1865.0	-	-
14	56.7	15	1	1152.0	-	-

15	69.7	15	2	1276.0	1096.0	-
16	99.7	15	3	1502.0	1708.0	1723.0

Long Pulse Radar Test Signal						
Test Signal Name: LP_Signal_05						
Number of Bursts in Trial: 10						
Chirp Center Frequency: 5500MHz						
Burst	Pulse Width (us)	Chirp Width (MHz)	Number of Pulses per Burst	PRI-1 (us)	PRI-2 (us)	PRI-3 (us)
1	53.2	8	1	1418.0	-	-
2	69.0	8	2	1336.0	1720.0	-
3	56.6	8	1	1268.0	-	-
4	77.3	8	2	1760.0	1137.0	-
5	60.3	8	1	1006.0	-	-
6	60.9	8	1	1140.0	-	-
7	66.8	8	2	1229.0	1525.0	-
8	51.3	8	1	1930.0	-	-
9	66.5	8	1	1100.0	-	-
10	60.4	8	1	1274.0	-	-

Long Pulse Radar Test Signal						
Test Signal Name: LP_Signal_06						
Number of Bursts in Trial: 14						
Chirp Center Frequency: 5500MHz						
Burst	Pulse Width (us)	Chirp Width (MHz)	Number of Pulses per Burst	PRI-1 (us)	PRI-2 (us)	PRI-3 (us)
1	69.8	13	2	1769.0	1921.0	-
2	81.7	13	2	1944.0	1878.0	-
3	56.9	13	1	1561.0	-	-
4	81.1	13	2	1983.0	1975.0	-
5	90.1	13	3	1568.0	1914.0	1456.0
6	75.4	13	2	1857.0	1372.0	-
7	53.2	13	1	1634.0	-	-
8	98.0	13	3	1021.0	1272.0	1370.0
9	78.4	13	2	1547.0	1148.0	-
10	52.2	13	1	1201.0	-	-
11	68.2	13	2	1038.0	1936.0	-
12	84.2	13	3	1183.0	1034.0	1649.0

13	65.1	13	1	1110.0	-	-
14	52.6	13	1	1599.0	-	-

Long Pulse Radar Test Signal						
Test Signal Name: LP_Signal_07						
Number of Bursts in Trial: 19						
Chirp Center Frequency: 5500MHz						
Burst	Pulse Width (us)	Chirp Width (MHz)	Number of Pulses per Burst	PRI-1 (us)	PRI-2 (us)	PRI-3 (us)
1	80.6	19	2	1385.0	1357.0	-
2	85.2	19	3	1604.0	1083.0	1583.0
3	66.3	19	1	1859.0	-	-
4	94.8	19	3	1363.0	1405.0	1505.0
5	78.1	19	2	1478.0	1107.0	-
6	93.0	19	3	1939.0	1374.0	1406.0
7	83.3	19	2	1549.0	1562.0	-
8	69.9	19	2	1081.0	1157.0	-
9	83.9	19	3	1475.0	1024.0	1996.0
10	99.2	19	3	1195.0	1557.0	1409.0
11	80.8	19	2	1192.0	1172.0	-
12	67.7	19	2	1124.0	1315.0	-
13	65.2	19	1	1099.0	-	-
14	89.1	19	3	1956.0	1770.0	1551.0
15	93.6	19	3	1440.0	1415.0	1753.0
16	98.1	19	3	1998.0	1951.0	1167.0
17	70.4	19	2	1711.0	1468.0	-
18	66.0	19	1	1811.0	-	-
19	56.2	19	1	1803.0	-	-

Long Pulse Radar Test Signal						
Test Signal Name: LP_Signal_08						
Number of Bursts in Trial: 17						
Chirp Center Frequency: 5500MHz						
Burst	Pulse Width (us)	Chirp Width (MHz)	Number of Pulses per Burst	PRI-1 (us)	PRI-2 (us)	PRI-3 (us)
1	76.8	16	2	1188.0	1695.0	-
2	52.4	16	1	1912.0	-	-
3	71.6	16	2	1586.0	1413.0	-

4	73.5	16	2	1744.0	1141.0	-
5	87.2	16	3	1026.0	1703.0	1072.0
6	84.6	16	3	1171.0	1233.0	1346.0
7	97.4	16	3	1000.0	1163.0	1340.0
8	78.4	16	2	1840.0	1673.0	-
9	56.8	16	1	1891.0	-	-
10	78.4	16	2	2000.0	1122.0	-
11	67.4	16	2	1291.0	1028.0	-
12	81.5	16	2	1298.0	1948.0	-
13	69.1	16	2	1486.0	1079.0	-
14	53.8	16	1	1943.0	-	-
15	53.9	16	1	1611.0	-	-
16	96.7	16	3	1938.0	1622.0	1768.0
17	75.2	16	2	1543.0	1663.0	-

Long Pulse Radar Test Signal						
Test Signal Name: LP_Signal_09						
Number of Bursts in Trial: 8						
Chirp Center Frequency: 5500MHz						
Burst	Pulse Width (us)	Chirp Width (MHz)	Number of Pulses per Burst	PRI-1 (us)	PRI-2 (us)	PRI-3 (us)
1	94.7	5	3	1414.0	1714.0	1681.0
2	72.0	5	2	1266.0	1765.0	-
3	73.2	5	2	1605.0	1420.0	-
4	73.6	5	2	1801.0	1391.0	-
5	77.1	5	2	1883.0	1994.0	-
6	100.0	5	3	1102.0	1522.0	1289.0
7	97.9	5	3	1874.0	1368.0	1049.0
8	57.8	5	1	1657.0	-	-

Long Pulse Radar Test Signal						
Test Signal Name: LP_Signal_10						
Number of Bursts in Trial: 18						
Chirp Center Frequency: 5500MHz						
Burst	Pulse Width (us)	Chirp Width (MHz)	Number of Pulses per Burst	PRI-1 (us)	PRI-2 (us)	PRI-3 (us)
1	50.2	18	1	1949.0	-	-
2	72.4	18	2	1862.0	1990.0	-



3	60.1	18	1	1317.0	-	-
4	64.2	18	1	1483.0	-	-
5	54.3	18	1	1325.0	-	-
6	80.3	18	2	1130.0	1337.0	-
7	81.9	18	2	1710.0	1980.0	-
8	52.2	18	1	1025.0	-	-
9	77.9	18	2	1518.0	1528.0	-
10	88.4	18	3	1940.0	1313.0	1104.0
11	50.2	18	1	1572.0	-	-
12	59.0	18	1	1972.0	-	-
13	61.7	18	1	1932.0	-	-
14	79.1	18	2	1669.0	1238.0	-
15	60.2	18	1	1210.0	-	-
16	80.8	18	2	1428.0	1979.0	-
17	64.6	18	1	1259.0	-	-
18	76.5	18	2	1467.0	1954.0	-

Long Pulse Radar Test Signal						
Test Signal Name: LP_Signal_11						
Number of Bursts in Trial: 20						
Chirp Center Frequency: 5498.55 MHz						
Burst	Pulse Width (us)	Chirp Width (MHz)	Number of Pulses per Burst	PRI-1 (us)	PRI-2 (us)	PRI-3 (us)
1	91.6	20	3	1851.0	1870.0	1103.0
2	66.5	20	1	1258.0	-	-
3	67.7	20	2	1910.0	1261.0	-
4	61.6	20	1	1382.0	-	-
5	63.8	20	1	1767.0	-	-
6	61.2	20	1	1973.0	-	-
7	92.4	20	3	1849.0	1293.0	1675.0
8	68.4	20	2	1523.0	1719.0	-
9	53.3	20	1	1702.0	-	-
10	98.4	20	3	1981.0	1444.0	1058.0
11	92.9	20	3	1650.0	1498.0	1115.0
12	82.7	20	2	1957.0	1888.0	-
13	99.7	20	3	1331.0	1255.0	1916.0
14	52.4	20	1	1078.0	-	-
15	73.7	20	2	1678.0	1682.0	-
16	65.6	20	1	1033.0	-	-

17	87.0	20	3	1757.0	1443.0	1205.0
18	62.2	20	1	1212.0	-	-
19	87.2	20	3	1354.0	1022.0	1919.0
20	64.1	20	1	1709.0	-	-

Long Pulse Radar Test Signal						
Test Signal Name: LP_Signal_12						
Number of Bursts in Trial: 20						
Chrip Center Frequency: 5498.15 MHz						
Burst	Pulse Width (us)	Chrip Width (MHz)	Number of Pulses per Burst	PRI-1 (us)	PRI-2 (us)	PRI-3 (us)
1	52.4	19	1	1795.0	-	-
2	98.1	19	3	1461.0	1116.0	1160.0
3	85.5	19	3	1063.0	1301.0	1665.0
4	79.2	19	2	1559.0	1689.0	-
5	91.3	19	3	1730.0	1060.0	1435.0
6	65.5	19	1	1228.0	-	-
7	53.7	19	1	1632.0	-	-
8	87.7	19	3	1850.0	1098.0	1037.0
9	63.5	19	1	1479.0	-	-
10	65.5	19	1	1947.0	-	-
11	61.8	19	1	1389.0	-	-
12	92.4	19	3	1239.0	1848.0	1360.0
13	59.0	19	1	1451.0	-	-
14	50.6	19	1	1202.0	-	-
15	58.4	19	1	1432.0	-	-
16	81.4	19	2	1538.0	1288.0	-
17	90.2	19	3	1512.0	1758.0	1007.0
18	88.6	19	3	1623.0	1314.0	1286.0
19	58.5	19	1	1294.0	-	-
20	98.9	19	3	1842.0	1540.0	1984.0

Long Pulse Radar Test Signal						
Test Signal Name: LP_Signal_13						
Number of Bursts in Trial: 17						
Chrip Center Frequency: 5496.95 MHz						
Burst	Pulse Width (us)	Chrip Width (MHz)	Number of Pulses per Burst	PRI-1 (us)	PRI-2 (us)	PRI-3 (us)

1	71.8	16	2	1813.0	1217.0	-
2	86.0	16	3	1366.0	1305.0	1245.0
3	76.9	16	2	1404.0	1563.0	-
4	83.5	16	3	1925.0	1472.0	1625.0
5	59.4	16	1	1582.0	-	-
6	95.3	16	3	1128.0	1658.0	1858.0
7	88.7	16	3	1886.0	1364.0	1601.0
8	97.8	16	3	1164.0	1297.0	1823.0
9	85.3	16	3	1782.0	1282.0	1995.0
10	96.1	16	3	1086.0	1064.0	1521.0
11	92.2	16	3	1318.0	1069.0	1931.0
12	98.1	16	3	1367.0	1042.0	1986.0
13	93.7	16	3	1170.0	1946.0	1917.0
14	50.4	16	1	1578.0	-	-
15	74.0	16	2	1736.0	1606.0	-
16	93.5	16	3	1379.0	1380.0	1855.0
17	81.0	16	2	1361.0	1877.0	-

Long Pulse Radar Test Signal						
Test Signal Name: LP_Signal_14						
Number of Bursts in Trial: 9						
Chirp Center Frequency: 5492.95 MHz						
Burst	Pulse Width (us)	Chirp Width (MHz)	Number of Pulses per Burst	PRI-1 (us)	PRI-2 (us)	PRI-3 (us)
1	88.5	6	3	1642.0	1371.0	1896.0
2	70.4	6	2	1792.0	1531.0	-
3	98.3	6	3	1793.0	1817.0	1427.0
4	57.5	6	1	1776.0	-	-
5	54.7	6	1	1609.0	-	-
6	54.8	6	1	1575.0	-	-
7	87.9	6	3	1271.0	1684.0	1506.0
8	86.6	6	3	1721.0	1429.0	1904.0
9	50.4	6	1	1383.0	-	-

Long Pulse Radar Test Signal						
Test Signal Name: LP_Signal_15						
Number of Bursts in Trial: 11						
Chirp Center Frequency: 5494.15 MHz						
Burst	Pulse	Chirp	Number of	PRI-1 (us)	PRI-2 (us)	PRI-3 (us)

	Width (us)	Width (MHz)	Pulses per Burst			
1	73.7	9	2	1635.0	1909.0	-
2	99.1	9	3	1756.0	1959.0	1618.0
3	94.1	9	3	1136.0	1745.0	1655.0
4	92.4	9	3	1529.0	1214.0	1125.0
5	75.5	9	2	1047.0	1672.0	-
6	98.4	9	3	1588.0	1112.0	1206.0
7	53.6	9	1	1089.0	-	-
8	88.3	9	3	1097.0	1533.0	1108.0
9	92.4	9	3	1834.0	1847.0	1715.0
10	66.4	9	1	1106.0	-	-
11	71.1	9	2	1602.0	1410.0	-

Long Pulse Radar Test Signal						
Test Signal Name: LP_Signal_16						
Number of Bursts in Trial: 14						
Chirp Center Frequency: 5495.75 MHz						
Burst	Pulse Width (us)	Chirp Width (MHz)	Number of Pulses per Burst	PRI-1 (us)	PRI-2 (us)	PRI-3 (us)
1	52.0	13	1	1333.0	-	-
2	69.8	13	2	1636.0	1836.0	-
3	96.0	13	3	1080.0	1640.0	1866.0
4	76.9	13	2	1173.0	1408.0	-
5	55.9	13	1	1927.0	-	-
6	52.3	13	1	1923.0	-	-
7	67.5	13	2	1962.0	1594.0	-
8	73.4	13	2	1698.0	1791.0	-
9	63.7	13	1	1982.0	-	-
10	98.8	13	3	1942.0	1013.0	1537.0
11	58.5	13	1	1867.0	-	-
12	76.6	13	2	1969.0	1262.0	-
13	64.9	13	1	1005.0	-	-
14	50.3	13	1	1285.0	-	-

Long Pulse Radar Test Signal						
Test Signal Name: LP_Signal_17						
Number of Bursts in Trial: 20						
Chirp Center Frequency: 5498.55 MHz						

Burst	Pulse Width (us)	Chirp Width (MHz)	Number of Pulses per Burst	PRI-1 (us)	PRI-2 (us)	PRI-3 (us)
1	51.6	20	1	1457.0	-	-
2	68.1	20	2	1741.0	1308.0	-
3	60.2	20	1	1216.0	-	-
4	91.4	20	3	1987.0	1913.0	1822.0
5	67.0	20	2	1645.0	1662.0	-
6	81.2	20	2	1960.0	1661.0	-
7	89.1	20	3	1127.0	1589.0	1121.0
8	97.0	20	3	1554.0	1558.0	1492.0
9	59.0	20	1	1241.0	-	-
10	71.6	20	2	1812.0	1349.0	-
11	89.7	20	3	1807.0	1875.0	1273.0
12	53.6	20	1	1614.0	-	-
13	92.9	20	3	1612.0	1666.0	1310.0
14	70.5	20	2	1644.0	1797.0	-
15	93.8	20	3	1215.0	1997.0	1465.0
16	94.4	20	3	1316.0	1726.0	1264.0
17	55.3	20	1	1885.0	-	-
18	58.1	20	1	1566.0	-	-
19	57.6	20	1	1788.0	-	-
20	72.3	20	2	1257.0	1569.0	-

Long Pulse Radar Test Signal						
Test Signal Name: LP_Signal_18						
Number of Bursts in Trial: 13						
Chirp Center Frequency: 5494.95 MHz						
Burst	Pulse Width (us)	Chirp Width (MHz)	Number of Pulses per Burst	PRI-1 (us)	PRI-2 (us)	PRI-3 (us)
1	79.0	11	2	1894.0	1433.0	-
2	68.7	11	2	1182.0	1481.0	-
3	74.5	11	2	1499.0	1600.0	-
4	71.4	11	2	1277.0	1146.0	-
5	51.6	11	1	1321.0	-	-
6	52.4	11	1	1895.0	-	-
7	87.4	11	3	1402.0	1219.0	1508.0
8	64.4	11	1	1680.0	-	-
9	72.8	11	2	1027.0	1218.0	-

10	51.6	11	1	1424.0	-	-
11	65.1	11	1	1045.0	-	-
12	72.4	11	2	1511.0	1320.0	-
13	79.1	11	2	1386.0	1270.0	-

Long Pulse Radar Test Signal

Test Signal Name: LP\_Signal\_19

Number of Bursts in Trial: 8

Chirp Center Frequency: 5492.55 MHz

Burst	Pulse Width (us)	Chirp Width (MHz)	Number of Pulses per Burst	PRI-1 (us)	PRI-2 (us)	PRI-3 (us)
1	92.0	5	3	1764.0	1111.0	1501.0
2	73.9	5	2	1869.0	1447.0	-
3	80.3	5	2	1617.0	1179.0	-
4	93.5	5	3	1120.0	1446.0	1693.0
5	97.0	5	3	1032.0	1011.0	1633.0
6	75.3	5	2	1335.0	1841.0	-
7	85.3	5	3	1759.0	1355.0	1458.0
8	82.0	5	2	1040.0	1725.0	-

Long Pulse Radar Test Signal

Test Signal Name: LP\_Signal\_20

Number of Bursts in Trial: 17

Chirp Center Frequency: 5496.95 MHz

Burst	Pulse Width (us)	Chirp Width (MHz)	Number of Pulses per Burst	PRI-1 (us)	PRI-2 (us)	PRI-3 (us)
1	55.0	16	1	1934.0	-	-
2	60.7	16	1	1706.0	-	-
3	74.4	16	2	1704.0	1638.0	-
4	87.3	16	3	1967.0	1193.0	1832.0
5	52.2	16	1	1924.0	-	-
6	59.4	16	1	1509.0	-	-
7	97.1	16	3	1490.0	1827.0	1881.0
8	79.6	16	2	1463.0	1860.0	-
9	69.3	16	2	1090.0	1204.0	-
10	93.5	16	3	1328.0	1426.0	1814.0
11	50.4	16	1	1474.0	-	-
12	69.0	16	2	1351.0	1530.0	-

13	92.7	16	3	1101.0	1180.0	1029.0
14	71.4	16	2	1184.0	1243.0	-
15	83.0	16	2	1407.0	1524.0	-
16	93.7	16	3	1989.0	1054.0	1746.0
17	88.9	16	3	1864.0	1312.0	1933.0

Long Pulse Radar Test Signal						
Test Signal Name: LP_Signal_21						
Number of Bursts in Trial: 18						
Chirp Center Frequency: 5502.65 MHz						
Burst	Pulse Width (us)	Chirp Width (MHz)	Number of Pulses per Burst	PRI-1 (us)	PRI-2 (us)	PRI-3 (us)
1	89.8	17	3	1452.0	1441.0	1619.0
2	64.6	17	1	1031.0	-	-
3	93.9	17	3	2000.0	1323.0	1503.0
4	74.7	17	2	1473.0	1065.0	-
5	74.1	17	2	1965.0	1786.0	-
6	57.3	17	1	1088.0	-	-
7	56.5	17	1	1729.0	-	-
8	67.2	17	2	1470.0	1211.0	-
9	74.5	17	2	1300.0	1041.0	-
10	50.8	17	1	1794.0	-	-
11	96.7	17	3	1445.0	1307.0	1035.0
12	63.5	17	1	1186.0	-	-
13	50.9	17	1	1626.0	-	-
14	58.4	17	1	1615.0	-	-
15	82.8	17	2	1668.0	1961.0	-
16	72.3	17	2	1249.0	1804.0	-
17	90.3	17	3	1815.0	1196.0	1580.0
18	73.9	17	2	1526.0	1200.0	-

Long Pulse Radar Test Signal						
Test Signal Name: LP_Signal_22						
Number of Bursts in Trial: 17						
Chirp Center Frequency: 5503.05 MHz						
Burst	Pulse Width (us)	Chirp Width (MHz)	Number of Pulses per Burst	PRI-1 (us)	PRI-2 (us)	PRI-3 (us)
1	57.9	16	1	1749.0	-	-

2	50.0	16	1	1338.0	-	-
3	84.2	16	3	1190.0	1422.0	1545.0
4	99.4	16	3	1234.0	1265.0	1735.0
5	93.0	16	3	1269.0	1003.0	1648.0
6	90.3	16	3	1043.0	1700.0	1573.0
7	84.8	16	3	1376.0	1342.0	1466.0
8	53.5	16	1	1905.0	-	-
9	58.2	16	1	1417.0	-	-
10	64.6	16	1	1348.0	-	-
11	53.3	16	1	1647.0	-	-
12	86.5	16	3	1077.0	1517.0	1105.0
13	70.6	16	2	1055.0	1488.0	-
14	91.0	16	3	1350.0	1039.0	1138.0
15	86.6	16	3	1237.0	1085.0	1802.0
16	54.5	16	1	1131.0	-	-
17	57.1	16	1	1805.0	-	-

Long Pulse Radar Test Signal						
Test Signal Name: LP_Signal_23						
Number of Bursts in Trial: 9						
Chrip Center Frequency: 5506.65 MHz						
Burst	Pulse Width (us)	Chirp Width (MHz)	Number of Pulses per Burst	PRI-1 (us)	PRI-2 (us)	PRI-3 (us)
1	60.7	7	1	1324.0	-	-
2	91.5	7	3	1882.0	1114.0	1653.0
3	57.3	7	1	1937.0	-	-
4	81.0	7	2	1737.0	1789.0	-
5	53.3	7	1	1664.0	-	-
6	67.9	7	2	1046.0	1126.0	-
7	70.0	7	2	1396.0	1375.0	-
8	77.7	7	2	1777.0	1688.0	-
9	58.5	7	1	1311.0	-	-

Long Pulse Radar Test Signal						
Test Signal Name: LP_Signal_24						
Number of Bursts in Trial: 8						
Chrip Center Frequency: 5507.45 MHz						
Burst	Pulse Width	Chirp Width	Number of Pulses per	PRI-1 (us)	PRI-2 (us)	PRI-3 (us)



	(us)	(MHz)	Burst			
1	50.4	5	1	1494.0	-	-
2	66.1	5	1	1799.0	-	-
3	68.3	5	2	1781.0	1421.0	-
4	85.0	5	3	1303.0	1378.0	1144.0
5	67.7	5	2	1541.0	1667.0	-
6	96.7	5	3	1068.0	1119.0	1852.0
7	52.3	5	1	1516.0	-	-
8	97.6	5	3	1993.0	1796.0	1165.0

Long Pulse Radar Test Signal						
Test Signal Name: LP_Signal_25						
Number of Bursts in Trial: 14						
Chirp Center Frequency: 5504.65 MHz						
Burst	Pulse Width (us)	Chirp Width (MHz)	Number of Pulses per Burst	PRI-1 (us)	PRI-2 (us)	PRI-3 (us)
1	75.0	12	2	1168.0	1774.0	-
2	93.6	12	3	1169.0	1178.0	1017.0
3	54.7	12	1	1717.0	-	-
4	90.4	12	3	1926.0	1278.0	1761.0
5	71.6	12	2	1976.0	1232.0	-
6	53.5	12	1	1290.0	-	-
7	89.9	12	3	1347.0	1897.0	1779.0
8	70.6	12	2	1542.0	1052.0	-
9	99.2	12	3	1825.0	1358.0	1809.0
10	91.9	12	3	1153.0	1520.0	1247.0
11	63.9	12	1	1092.0	-	-
12	88.1	12	3	1985.0	1359.0	1095.0
13	80.3	12	2	1828.0	1534.0	-
14	55.7	12	1	1434.0	-	-

Long Pulse Radar Test Signal						
Test Signal Name: LP_Signal_26						
Number of Bursts in Trial: 16						
Chirp Center Frequency: 5503.45 MHz						
Burst	Pulse Width (us)	Chirp Width (MHz)	Number of Pulses per Burst	PRI-1 (us)	PRI-2 (us)	PRI-3 (us)
1	76.9	15	2	1783.0	1560.0	-

2	96.4	15	3	1091.0	1304.0	1388.0
3	51.2	15	1	1056.0	-	-
4	72.1	15	2	1892.0	1705.0	-
5	80.9	15	2	1495.0	1679.0	-
6	83.0	15	2	1712.0	1607.0	-
7	93.0	15	3	1246.0	1341.0	1724.0
8	54.5	15	1	1384.0	-	-
9	82.2	15	2	1093.0	1142.0	-
10	64.1	15	1	1831.0	-	-
11	71.6	15	2	1412.0	1155.0	-
12	84.4	15	3	1515.0	1191.0	1743.0
13	89.9	15	3	1838.0	1514.0	1176.0
14	68.6	15	2	1800.0	1963.0	-
15	85.2	15	3	1646.0	1449.0	1295.0
16	73.2	15	2	1074.0	1222.0	-

Long Pulse Radar Test Signal						
Test Signal Name: LP_Signal_27						
Number of Bursts in Trial: 12						
Chrip Center Frequency: 5505.85 MHz						
Burst	Pulse Width (us)	Chrip Width (MHz)	Number of Pulses per Burst	PRI-1 (us)	PRI-2 (us)	PRI-3 (us)
1	97.0	9	3	1571.0	1652.0	1830.0
2	56.7	9	1	1225.0	-	-
3	84.2	9	3	1707.0	1044.0	1656.0
4	73.0	9	2	1826.0	1500.0	-
5	65.9	9	1	1863.0	-	-
6	93.0	9	3	1887.0	1057.0	1230.0
7	99.9	9	3	1118.0	1824.0	1861.0
8	66.8	9	2	1780.0	1283.0	-
9	89.1	9	3	1411.0	1401.0	1771.0
10	88.0	9	3	1734.0	1915.0	1907.0
11	67.4	9	2	1132.0	1030.0	-
12	60.4	9	1	1263.0	-	-

Long Pulse Radar Test Signal						
Test Signal Name: LP_Signal_28						
Number of Bursts in Trial: 16						
Chrip Center Frequency: 5503.05 MHz						

Burst	Pulse Width (us)	Chirp Width (MHz)	Number of Pulses per Burst	PRI-1 (us)	PRI-2 (us)	PRI-3 (us)
1	54.2	16	1	1971.0	-	-
2	76.0	16	2	1400.0	1513.0	-
3	56.1	16	1	1133.0	-	-
4	89.7	16	3	1670.0	1991.0	1020.0
5	78.3	16	2	1587.0	1546.0	-
6	94.8	16	3	1819.0	1326.0	1584.0
7	89.2	16	3	1208.0	1185.0	1436.0
8	71.9	16	2	1145.0	1713.0	-
9	83.8	16	3	1339.0	1221.0	1403.0
10	95.7	16	3	1377.0	1966.0	1209.0
11	65.7	16	1	1353.0	-	-
12	69.4	16	2	1728.0	1327.0	-
13	54.6	16	1	1539.0	-	-
14	70.4	16	2	1309.0	1643.0	-
15	61.4	16	1	1135.0	-	-
16	90.6	16	3	1570.0	1766.0	1485.0

Long Pulse Radar Test Signal						
Test Signal Name: LP_Signal_29						
Number of Bursts in Trial: 13						
Chirp Center Frequency: 5505.05 MHz						
Burst	Pulse Width (us)	Chirp Width (MHz)	Number of Pulses per Burst	PRI-1 (us)	PRI-2 (us)	PRI-3 (us)
1	68.8	11	2	1833.0	1598.0	-
2	87.2	11	3	1161.0	1280.0	1390.0
3	63.6	11	1	1773.0	-	-
4	71.2	11	2	1175.0	1497.0	-
5	85.4	11	3	1252.0	1151.0	1448.0
6	76.0	11	2	1343.0	1772.0	-
7	95.0	11	3	1139.0	1527.0	1477.0
8	57.1	11	1	1890.0	-	-
9	53.8	11	1	1941.0	-	-
10	57.2	11	1	1683.0	-	-
11	89.8	11	3	1507.0	1462.0	1419.0
12	83.9	11	3	1425.0	1459.0	1275.0
13	96.5	11	3	1567.0	1394.0	1254.0

Long Pulse Radar Test Signal

Test Signal Name: LP\_Signal\_30

Number of Bursts in Trial: 8

Chirp Center Frequency: 5507.45 MHz

Burst	Pulse Width (us)	Chirp Width (MHz)	Number of Pulses per Burst	PRI-1 (us)	PRI-2 (us)	PRI-3 (us)
1	84.5	5	3	1902.0	1977.0	1156.0
2	83.0	5	2	1240.0	1365.0	-
3	93.0	5	3	1844.0	1067.0	1231.0
4	65.5	5	1	1519.0	-	-
5	82.5	5	2	1964.0	1260.0	-
6	50.3	5	1	1082.0	-	-
7	56.1	5	1	1220.0	-	-
8	58.0	5	1	1816.0	-	-

Type 6 Radar Statistical Performances				
Trial #	Pulses per Burst	Pulse Width ( $\mu$ sec)	PRI ( $\mu$ sec)	Detection
1	9	1	333.3	Yes
2	9	1	333.3	Yes
3	9	1	333.3	Yes
4	9	1	333.3	Yes
5	9	1	333.3	Yes
6	9	1	333.3	Yes
7	9	1	333.3	Yes
8	9	1	333.3	Yes
9	9	1	333.3	Yes
10	9	1	333.3	Yes
11	9	1	333.3	Yes
12	9	1	333.3	Yes
13	9	1	333.3	Yes
14	9	1	333.3	Yes
15	9	1	333.3	Yes
16	9	1	333.3	Yes
17	9	1	333.3	Yes
18	9	1	333.3	Yes
19	9	1	333.3	Yes
20	9	1	333.3	Yes
21	9	1	333.3	Yes
22	9	1	333.3	Yes
23	9	1	333.3	Yes
24	9	1	333.3	Yes
25	9	1	333.3	Yes
26	9	1	333.3	Yes
27	9	1	333.3	Yes
28	9	1	333.3	Yes
29	9	1	333.3	Yes
30	9	1	333.3	Yes
				Detection Rate:100 %

Type 6 Radar Statistical Performances		
Trial #	Hopping Frequency Sequence Name	Detection
1	HOP_FREQ_SEQ_01	Yes
2	HOP_FREQ_SEQ_02	Yes
3	HOP_FREQ_SEQ_03	Yes
4	HOP_FREQ_SEQ_04	Yes
5	HOP_FREQ_SEQ_05	Yes
6	HOP_FREQ_SEQ_06	Yes
7	HOP_FREQ_SEQ_07	Yes
8	HOP_FREQ_SEQ_08	Yes
9	HOP_FREQ_SEQ_09	Yes
10	HOP_FREQ_SEQ_10	Yes
11	HOP_FREQ_SEQ_11	Yes
12	HOP_FREQ_SEQ_12	Yes
13	HOP_FREQ_SEQ_13	Yes
14	HOP_FREQ_SEQ_14	Yes
15	HOP_FREQ_SEQ_15	Yes
16	HOP_FREQ_SEQ_16	Yes
17	HOP_FREQ_SEQ_17	Yes
18	HOP_FREQ_SEQ_18	Yes
19	HOP_FREQ_SEQ_19	Yes
20	HOP_FREQ_SEQ_20	Yes
21	HOP_FREQ_SEQ_21	Yes
22	HOP_FREQ_SEQ_22	Yes
23	HOP_FREQ_SEQ_23	Yes
24	HOP_FREQ_SEQ_24	Yes
25	HOP_FREQ_SEQ_25	Yes
26	HOP_FREQ_SEQ_26	Yes
27	HOP_FREQ_SEQ_27	Yes
28	HOP_FREQ_SEQ_28	Yes
29	HOP_FREQ_SEQ_29	Yes
30	HOP_FREQ_SEQ_30	Yes
		Detection Rate: 100 %

Hopping Frequency Sequence Name: HOP_FREQ_SEQ_01							
SEQ#	Frequency (Hz)	SEQ#	Frequency (Hz)	SEQ#	Frequency (Hz)	SEQ#	Frequency (Hz)
1	5.505G	2	5.674G	3	5.257G	4	5.690G
5	5.520G	6	5.262G	7	5.356G	8	5.439G
9	5.685G	10	5.332G	11	5.720G	12	5.579G
13	5.313G	14	5.383G	15	5.697G	16	5.318G
17	5.695G	18	5.461G	19	5.719G	20	5.606G
21	5.533G	22	5.287G	23	5.675G	24	5.540G
25	5.604G	26	5.591G	27	5.564G	28	5.612G
29	5.399G	30	5.593G	31	5.600G	32	5.478G
33	5.667G	34	5.434G	35	5.299G	36	5.387G
37	5.319G	38	5.376G	39	5.710G	40	5.581G
41	5.624G	42	5.302G	43	5.406G	44	5.272G
45	5.531G	46	5.298G	47	5.303G	48	5.265G
49	5.688G	50	5.372G	51	5.699G	52	5.550G
53	5.336G	54	5.308G	55	5.565G	56	5.269G
57	5.635G	58	5.650G	59	5.357G	60	5.462G
61	5.389G	62	5.626G	63	5.411G	64	5.386G
65	5.665G	66	5.481G	67	5.354G	68	5.267G
69	5.279G	70	5.558G	71	5.578G	72	5.647G
73	5.717G	74	5.382G	75	5.297G	76	5.601G
77	5.630G	78	5.603G	79	5.676G	80	5.657G
81	5.608G	82	5.329G	83	5.388G	84	5.602G
85	5.549G	86	5.451G	87	5.709G	88	5.716G
89	5.643G	90	5.285G	91	5.377G	92	5.443G
93	5.535G	94	5.584G	95	5.506G	96	5.723G
97	5.507G	98	5.712G	99	5.680G	100	5.724G

Hopping Frequency Sequence Name: HOP_FREQ_SEQ_02							
SEQ#	Frequency (Hz)	SEQ#	Frequency (Hz)	SEQ#	Frequency (Hz)	SEQ#	Frequency (Hz)
1	5.350G	2	5.673G	3	5.251G	4	5.286G
5	5.699G	6	5.714G	7	5.500G	8	5.265G
9	5.299G	10	5.455G	11	5.359G	12	5.611G
13	5.487G	14	5.448G	15	5.663G	16	5.373G
17	5.269G	18	5.614G	19	5.439G	20	5.385G
21	5.680G	22	5.603G	23	5.363G	24	5.341G
25	5.303G	26	5.504G	27	5.576G	28	5.584G
29	5.632G	30	5.535G	31	5.402G	32	5.597G
33	5.308G	34	5.566G	35	5.689G	36	5.301G
37	5.494G	38	5.400G	39	5.513G	40	5.691G
41	5.553G	42	5.343G	43	5.532G	44	5.520G
45	5.664G	46	5.718G	47	5.612G	48	5.444G
49	5.452G	50	5.588G	51	5.307G	52	5.422G
53	5.662G	54	5.275G	55	5.583G	56	5.578G
57	5.595G	58	5.479G	59	5.410G	60	5.693G
61	5.465G	62	5.312G	63	5.268G	64	5.629G
65	5.671G	66	5.284G	67	5.406G	68	5.624G
69	5.300G	70	5.568G	71	5.318G	72	5.711G
73	5.330G	74	5.399G	75	5.694G	76	5.631G
77	5.416G	78	5.723G	79	5.637G	80	5.339G
81	5.252G	82	5.703G	83	5.654G	84	5.538G
85	5.478G	86	5.482G	87	5.474G	88	5.407G
89	5.279G	90	5.316G	91	5.592G	92	5.627G
93	5.594G	94	5.633G	95	5.380G	96	5.598G
97	5.533G	98	5.446G	99	5.526G	100	5.555G



Hopping Frequency Sequence Name: HOP_FREQ_SEQ_03							
SEQ#	Frequency (Hz)	SEQ#	Frequency (Hz)	SEQ#	Frequency (Hz)	SEQ#	Frequency (Hz)
1	5.501G	2	5.592G	3	5.263G	4	5.484G
5	5.549G	6	5.346G	7	5.361G	8	5.576G
9	5.264G	10	5.700G	11	5.623G	12	5.324G
13	5.640G	14	5.669G	15	5.344G	16	5.579G
17	5.703G	18	5.585G	19	5.382G	20	5.601G
21	5.364G	22	5.296G	23	5.524G	24	5.532G
25	5.546G	26	5.555G	27	5.710G	28	5.644G
29	5.465G	30	5.456G	31	5.526G	32	5.627G
33	5.621G	34	5.717G	35	5.667G	36	5.652G
37	5.659G	38	5.498G	39	5.478G	40	5.386G
41	5.654G	42	5.508G	43	5.716G	44	5.599G
45	5.408G	46	5.427G	47	5.306G	48	5.402G
49	5.337G	50	5.464G	51	5.712G	52	5.358G
53	5.278G	54	5.680G	55	5.365G	56	5.442G
57	5.432G	58	5.538G	59	5.315G	60	5.587G
61	5.342G	62	5.615G	63	5.674G	64	5.563G
65	5.668G	66	5.460G	67	5.590G	68	5.542G
69	5.685G	70	5.469G	71	5.453G	72	5.429G
73	5.504G	74	5.660G	75	5.353G	76	5.616G
77	5.417G	78	5.672G	79	5.331G	80	5.393G
81	5.449G	82	5.347G	83	5.610G	84	5.706G
85	5.314G	86	5.321G	87	5.415G	88	5.724G
89	5.392G	90	5.437G	91	5.691G	92	5.407G
93	5.625G	94	5.463G	95	5.582G	96	5.646G
97	5.622G	98	5.688G	99	5.266G	100	5.428G

Hopping Frequency Sequence Name: HOP_FREQ_SEQ_04							
SEQ#	Frequency (Hz)	SEQ#	Frequency (Hz)	SEQ#	Frequency (Hz)	SEQ#	Frequency (Hz)
1	5.487G	2	5.498G	3	5.707G	4	5.277G
5	5.312G	6	5.447G	7	5.259G	8	5.548G
9	5.492G	10	5.699G	11	5.308G	12	5.677G
13	5.328G	14	5.520G	15	5.318G	16	5.433G
17	5.440G	18	5.294G	19	5.486G	20	5.258G
21	5.370G	22	5.405G	23	5.266G	24	5.380G
25	5.292G	26	5.590G	27	5.459G	28	5.495G
29	5.541G	30	5.564G	31	5.472G	32	5.680G
33	5.558G	34	5.319G	35	5.645G	36	5.475G
37	5.591G	38	5.375G	39	5.678G	40	5.649G
41	5.437G	42	5.674G	43	5.706G	44	5.460G
45	5.316G	46	5.636G	47	5.301G	48	5.660G
49	5.416G	50	5.284G	51	5.321G	52	5.545G
53	5.260G	54	5.353G	55	5.489G	56	5.334G
57	5.256G	58	5.600G	59	5.307G	60	5.683G
61	5.288G	62	5.637G	63	5.631G	64	5.253G
65	5.604G	66	5.709G	67	5.568G	68	5.697G
69	5.404G	70	5.508G	71	5.681G	72	5.345G
73	5.300G	74	5.497G	75	5.633G	76	5.655G
77	5.415G	78	5.333G	79	5.251G	80	5.374G
81	5.451G	82	5.443G	83	5.625G	84	5.473G
85	5.584G	86	5.338G	87	5.647G	88	5.304G
89	5.525G	90	5.542G	91	5.361G	92	5.650G
93	5.482G	94	5.666G	95	5.608G	96	5.589G
97	5.427G	98	5.384G	99	5.457G	100	5.355G

Hopping Frequency Sequence Name: HOP_FREQ_SEQ_05							
SEQ#	Frequency (Hz)	SEQ#	Frequency (Hz)	SEQ#	Frequency (Hz)	SEQ#	Frequency (Hz)
1	5.583G	2	5.381G	3	5.662G	4	5.649G
5	5.275G	6	5.678G	7	5.287G	8	5.452G
9	5.461G	10	5.670G	11	5.279G	12	5.702G
13	5.399G	14	5.420G	15	5.479G	16	5.278G
17	5.487G	18	5.484G	19	5.320G	20	5.433G
21	5.550G	22	5.333G	23	5.573G	24	5.456G
25	5.299G	26	5.261G	27	5.263G	28	5.614G
29	5.321G	30	5.300G	31	5.391G	32	5.551G
33	5.600G	34	5.509G	35	5.718G	36	5.522G
37	5.396G	38	5.713G	39	5.457G	40	5.717G
41	5.659G	42	5.607G	43	5.536G	44	5.370G
45	5.329G	46	5.708G	47	5.534G	48	5.429G
49	5.492G	50	5.379G	51	5.653G	52	5.545G
53	5.620G	54	5.681G	55	5.546G	56	5.715G
57	5.616G	58	5.591G	59	5.508G	60	5.375G
61	5.271G	62	5.596G	63	5.500G	64	5.455G
65	5.318G	66	5.585G	67	5.336G	68	5.657G
69	5.598G	70	5.251G	71	5.512G	72	5.668G
73	5.665G	74	5.667G	75	5.682G	76	5.407G
77	5.489G	78	5.309G	79	5.490G	80	5.418G
81	5.257G	82	5.697G	83	5.719G	84	5.341G
85	5.689G	86	5.647G	87	5.568G	88	5.699G
89	5.674G	90	5.572G	91	5.619G	92	5.408G
93	5.664G	94	5.706G	95	5.360G	96	5.439G
97	5.284G	98	5.312G	99	5.367G	100	5.478G

Hopping Frequency Sequence Name: HOP_FREQ_SEQ_06							
SEQ#	Frequency (Hz)	SEQ#	Frequency (Hz)	SEQ#	Frequency (Hz)	SEQ#	Frequency (Hz)
1	5.493G	2	5.665G	3	5.291G	4	5.553G
5	5.367G	6	5.518G	7	5.444G	8	5.350G
9	5.338G	10	5.467G	11	5.262G	12	5.629G
13	5.439G	14	5.406G	15	5.267G	16	5.293G
17	5.384G	18	5.447G	19	5.647G	20	5.716G
21	5.583G	22	5.697G	23	5.260G	24	5.609G
25	5.465G	26	5.632G	27	5.268G	28	5.593G
29	5.611G	30	5.546G	31	5.466G	32	5.478G
33	5.653G	34	5.660G	35	5.357G	36	5.454G
37	5.605G	38	5.502G	39	5.604G	40	5.703G
41	5.637G	42	5.519G	43	5.258G	44	5.601G
45	5.516G	46	5.346G	47	5.645G	48	5.638G
49	5.418G	50	5.354G	51	5.644G	52	5.456G
53	5.682G	54	5.702G	55	5.607G	56	5.503G
57	5.396G	58	5.441G	59	5.273G	60	5.548G
61	5.314G	62	5.371G	63	5.306G	64	5.360G
65	5.691G	66	5.413G	67	5.551G	68	5.485G
69	5.495G	70	5.419G	71	5.531G	72	5.492G
73	5.499G	74	5.392G	75	5.347G	76	5.497G
77	5.692G	78	5.342G	79	5.723G	80	5.356G
81	5.484G	82	5.491G	83	5.705G	84	5.563G
85	5.394G	86	5.397G	87	5.534G	88	5.269G
89	5.471G	90	5.514G	91	5.339G	92	5.640G
93	5.332G	94	5.680G	95	5.482G	96	5.488G
97	5.429G	98	5.430G	99	5.464G	100	5.295G

Hopping Frequency Sequence Name: HOP_FREQ_SEQ_07							
SEQ#	Frequency (Hz)	SEQ#	Frequency (Hz)	SEQ#	Frequency (Hz)	SEQ#	Frequency (Hz)
1	5.320G	2	5.390G	3	5.286G	4	5.418G
5	5.603G	6	5.488G	7	5.457G	8	5.410G
9	5.299G	10	5.545G	11	5.358G	12	5.355G
13	5.454G	14	5.277G	15	5.687G	16	5.582G
17	5.434G	18	5.475G	19	5.619G	20	5.627G
21	5.307G	22	5.317G	23	5.319G	24	5.421G
25	5.556G	26	5.541G	27	5.623G	28	5.546G
29	5.336G	30	5.578G	31	5.304G	32	5.325G
33	5.574G	34	5.382G	35	5.570G	36	5.544G
37	5.700G	38	5.571G	39	5.491G	40	5.465G
41	5.272G	42	5.536G	43	5.279G	44	5.402G
45	5.628G	46	5.595G	47	5.479G	48	5.401G
49	5.451G	50	5.356G	51	5.309G	52	5.561G
53	5.539G	54	5.685G	55	5.648G	56	5.693G
57	5.414G	58	5.679G	59	5.362G	60	5.695G
61	5.256G	62	5.283G	63	5.376G	64	5.706G
65	5.504G	66	5.441G	67	5.284G	68	5.449G
69	5.476G	70	5.462G	71	5.381G	72	5.343G
73	5.638G	74	5.689G	75	5.357G	76	5.389G
77	5.255G	78	5.303G	79	5.592G	80	5.675G
81	5.450G	82	5.611G	83	5.566G	84	5.265G
85	5.510G	86	5.724G	87	5.680G	88	5.392G
89	5.296G	90	5.605G	91	5.490G	92	5.631G
93	5.560G	94	5.612G	95	5.555G	96	5.487G
97	5.530G	98	5.327G	99	5.573G	100	5.704G

Hopping Frequency Sequence Name: HOP_FREQ_SEQ_08							
SEQ#	Frequency (Hz)	SEQ#	Frequency (Hz)	SEQ#	Frequency (Hz)	SEQ#	Frequency (Hz)
1	5.537G	2	5.669G	3	5.683G	4	5.517G
5	5.583G	6	5.304G	7	5.607G	8	5.656G
9	5.424G	10	5.441G	11	5.256G	12	5.552G
13	5.599G	14	5.277G	15	5.349G	16	5.707G
17	5.521G	18	5.478G	19	5.612G	20	5.302G
21	5.677G	22	5.581G	23	5.300G	24	5.412G
25	5.381G	26	5.259G	27	5.637G	28	5.251G
29	5.296G	30	5.565G	31	5.306G	32	5.285G
33	5.648G	34	5.563G	35	5.452G	36	5.555G
37	5.650G	38	5.495G	39	5.503G	40	5.594G
41	5.469G	42	5.582G	43	5.307G	44	5.255G
45	5.253G	46	5.323G	47	5.676G	48	5.709G
49	5.720G	50	5.712G	51	5.679G	52	5.482G
53	5.438G	54	5.415G	55	5.268G	56	5.636G
57	5.593G	58	5.427G	59	5.383G	60	5.661G
61	5.560G	62	5.697G	63	5.675G	64	5.468G
65	5.649G	66	5.298G	67	5.651G	68	5.400G
69	5.647G	70	5.467G	71	5.329G	72	5.652G
73	5.589G	74	5.347G	75	5.628G	76	5.500G
77	5.689G	78	5.368G	79	5.611G	80	5.387G
81	5.608G	82	5.473G	83	5.575G	84	5.278G
85	5.704G	86	5.662G	87	5.342G	88	5.592G
89	5.686G	90	5.702G	91	5.624G	92	5.434G
93	5.416G	94	5.553G	95	5.576G	96	5.477G
97	5.464G	98	5.396G	99	5.386G	100	5.432G

Hopping Frequency Sequence Name: HOP_FREQ_SEQ_09							
SEQ#	Frequency (Hz)	SEQ#	Frequency (Hz)	SEQ#	Frequency (Hz)	SEQ#	Frequency (Hz)
1	5.349G	2	5.590G	3	5.466G	4	5.546G
5	5.530G	6	5.355G	7	5.575G	8	5.709G
9	5.350G	10	5.724G	11	5.456G	12	5.682G
13	5.625G	14	5.554G	15	5.713G	16	5.477G
17	5.432G	18	5.412G	19	5.454G	20	5.402G
21	5.357G	22	5.389G	23	5.626G	24	5.717G
25	5.282G	26	5.524G	27	5.697G	28	5.264G
29	5.467G	30	5.720G	31	5.459G	32	5.313G
33	5.640G	34	5.329G	35	5.605G	36	5.427G
37	5.295G	38	5.567G	39	5.302G	40	5.635G
41	5.278G	42	5.578G	43	5.461G	44	5.700G
45	5.455G	46	5.327G	47	5.592G	48	5.275G
49	5.632G	50	5.453G	51	5.422G	52	5.300G
53	5.721G	54	5.650G	55	5.704G	56	5.380G
57	5.403G	58	5.373G	59	5.367G	60	5.372G
61	5.492G	62	5.690G	63	5.618G	64	5.540G
65	5.508G	66	5.485G	67	5.496G	68	5.548G
69	5.512G	70	5.687G	71	5.296G	72	5.676G
73	5.499G	74	5.440G	75	5.579G	76	5.604G
77	5.608G	78	5.723G	79	5.576G	80	5.703G
81	5.433G	82	5.612G	83	5.482G	84	5.583G
85	5.633G	86	5.582G	87	5.437G	88	5.521G
89	5.601G	90	5.391G	91	5.647G	92	5.393G
93	5.419G	94	5.598G	95	5.434G	96	5.597G
97	5.446G	98	5.478G	99	5.551G	100	5.621G

Hopping Frequency Sequence Name: HOP_FREQ_SEQ_10							
SEQ#	Frequency (Hz)	SEQ#	Frequency (Hz)	SEQ#	Frequency (Hz)	SEQ#	Frequency (Hz)
1	5.550G	2	5.265G	3	5.435G	4	5.470G
5	5.657G	6	5.490G	7	5.566G	8	5.303G
9	5.400G	10	5.263G	11	5.271G	12	5.372G
13	5.448G	14	5.659G	15	5.549G	16	5.571G
17	5.381G	18	5.398G	19	5.278G	20	5.511G
21	5.583G	22	5.333G	23	5.482G	24	5.494G
25	5.353G	26	5.668G	27	5.460G	28	5.563G
29	5.706G	30	5.421G	31	5.283G	32	5.703G
33	5.554G	34	5.503G	35	5.513G	36	5.461G
37	5.355G	38	5.341G	39	5.532G	40	5.528G
41	5.380G	42	5.698G	43	5.392G	44	5.582G
45	5.285G	46	5.425G	47	5.454G	48	5.617G
49	5.323G	50	5.281G	51	5.544G	52	5.466G
53	5.447G	54	5.420G	55	5.600G	56	5.676G
57	5.422G	58	5.638G	59	5.324G	60	5.295G
61	5.359G	62	5.483G	63	5.628G	64	5.350G
65	5.690G	66	5.389G	67	5.495G	68	5.252G
69	5.603G	70	5.688G	71	5.266G	72	5.696G
73	5.713G	74	5.649G	75	5.465G	76	5.413G
77	5.551G	78	5.615G	79	5.620G	80	5.358G
81	5.567G	82	5.442G	83	5.524G	84	5.506G
85	5.296G	86	5.597G	87	5.360G	88	5.484G
89	5.430G	90	5.407G	91	5.612G	92	5.619G
93	5.488G	94	5.631G	95	5.375G	96	5.432G
97	5.641G	98	5.342G	99	5.443G	100	5.590G



Hopping Frequency Sequence Name: HOP_FREQ_SEQ_11							
SEQ#	Frequency (Hz)	SEQ#	Frequency (Hz)	SEQ#	Frequency (Hz)	SEQ#	Frequency (Hz)
1	5.408G	2	5.306G	3	5.263G	4	5.393G
5	5.321G	6	5.559G	7	5.525G	8	5.427G
9	5.723G	10	5.451G	11	5.696G	12	5.626G
13	5.709G	14	5.553G	15	5.257G	16	5.474G
17	5.261G	18	5.669G	19	5.462G	20	5.348G
21	5.487G	22	5.589G	23	5.625G	24	5.294G
25	5.262G	26	5.711G	27	5.362G	28	5.623G
29	5.568G	30	5.564G	31	5.666G	32	5.413G
33	5.538G	34	5.484G	35	5.641G	36	5.520G
37	5.721G	38	5.483G	39	5.659G	40	5.339G
41	5.300G	42	5.478G	43	5.563G	44	5.269G
45	5.684G	46	5.663G	47	5.252G	48	5.254G
49	5.480G	50	5.655G	51	5.521G	52	5.377G
53	5.603G	54	5.627G	55	5.314G	56	5.364G
57	5.629G	58	5.365G	59	5.351G	60	5.528G
61	5.657G	62	5.447G	63	5.270G	64	5.477G
65	5.515G	66	5.295G	67	5.268G	68	5.383G
69	5.251G	70	5.458G	71	5.320G	72	5.374G
73	5.492G	74	5.358G	75	5.357G	76	5.410G
77	5.676G	78	5.588G	79	5.414G	80	5.399G
81	5.498G	82	5.491G	83	5.604G	84	5.658G
85	5.330G	86	5.613G	87	5.317G	88	5.539G
89	5.652G	90	5.403G	91	5.675G	92	5.642G
93	5.551G	94	5.343G	95	5.460G	96	5.543G
97	5.369G	98	5.276G	99	5.532G	100	5.708G

Hopping Frequency Sequence Name: HOP_FREQ_SEQ_12							
SEQ#	Frequency (Hz)	SEQ#	Frequency (Hz)	SEQ#	Frequency (Hz)	SEQ#	Frequency (Hz)
1	5.603G	2	5.666G	3	5.522G	4	5.502G
5	5.678G	6	5.480G	7	5.479G	8	5.281G
9	5.364G	10	5.297G	11	5.713G	12	5.316G
13	5.476G	14	5.662G	15	5.437G	16	5.710G
17	5.561G	18	5.306G	19	5.416G	20	5.463G
21	5.268G	22	5.498G	23	5.674G	24	5.313G
25	5.549G	26	5.294G	27	5.558G	28	5.637G
29	5.583G	30	5.462G	31	5.291G	32	5.492G
33	5.452G	34	5.260G	35	5.497G	36	5.535G
37	5.586G	38	5.577G	39	5.658G	40	5.470G
41	5.424G	42	5.264G	43	5.680G	44	5.347G
45	5.619G	46	5.500G	47	5.266G	48	5.411G
49	5.272G	50	5.353G	51	5.661G	52	5.317G
53	5.696G	54	5.576G	55	5.391G	56	5.376G
57	5.442G	58	5.432G	59	5.305G	60	5.461G
61	5.398G	62	5.394G	63	5.368G	64	5.283G
65	5.624G	66	5.414G	67	5.483G	68	5.458G
69	5.329G	70	5.634G	71	5.578G	72	5.718G
73	5.387G	74	5.596G	75	5.650G	76	5.517G
77	5.690G	78	5.453G	79	5.613G	80	5.653G
81	5.628G	82	5.451G	83	5.478G	84	5.356G
85	5.441G	86	5.381G	87	5.552G	88	5.395G
89	5.341G	90	5.496G	91	5.455G	92	5.469G
93	5.573G	94	5.365G	95	5.642G	96	5.505G
97	5.309G	98	5.397G	99	5.568G	100	5.639G

Hopping Frequency Sequence Name: HOP_FREQ_SEQ_13							
SEQ#	Frequency (Hz)	SEQ#	Frequency (Hz)	SEQ#	Frequency (Hz)	SEQ#	Frequency (Hz)
1	5.375G	2	5.264G	3	5.273G	4	5.293G
5	5.612G	6	5.436G	7	5.695G	8	5.549G
9	5.422G	10	5.631G	11	5.262G	12	5.490G
13	5.589G	14	5.506G	15	5.326G	16	5.282G
17	5.657G	18	5.497G	19	5.509G	20	5.660G
21	5.474G	22	5.629G	23	5.272G	24	5.314G
25	5.433G	26	5.560G	27	5.399G	28	5.357G
29	5.668G	30	5.484G	31	5.408G	32	5.325G
33	5.434G	34	5.356G	35	5.563G	36	5.285G
37	5.401G	38	5.426G	39	5.393G	40	5.621G
41	5.277G	42	5.567G	43	5.593G	44	5.559G
45	5.496G	46	5.675G	47	5.419G	48	5.319G
49	5.690G	50	5.694G	51	5.373G	52	5.661G
53	5.367G	54	5.522G	55	5.674G	56	5.265G
57	5.300G	58	5.468G	59	5.596G	60	5.324G
61	5.528G	62	5.526G	63	5.537G	64	5.669G
65	5.599G	66	5.358G	67	5.303G	68	5.648G
69	5.378G	70	5.478G	71	5.469G	72	5.407G
73	5.513G	74	5.263G	75	5.586G	76	5.360G
77	5.571G	78	5.604G	79	5.446G	80	5.479G
81	5.482G	82	5.366G	83	5.394G	84	5.693G
85	5.288G	86	5.512G	87	5.551G	88	5.585G
89	5.723G	90	5.705G	91	5.412G	92	5.711G
93	5.345G	94	5.486G	95	5.678G	96	5.361G
97	5.390G	98	5.352G	99	5.649G	100	5.647G

Hopping Frequency Sequence Name: HOP_FREQ_SEQ_14							
SEQ#	Frequency (Hz)	SEQ#	Frequency (Hz)	SEQ#	Frequency (Hz)	SEQ#	Frequency (Hz)
1	5.507G	2	5.709G	3	5.352G	4	5.516G
5	5.503G	6	5.594G	7	5.415G	8	5.255G
9	5.475G	10	5.275G	11	5.657G	12	5.344G
13	5.534G	14	5.406G	15	5.612G	16	5.671G
17	5.389G	18	5.314G	19	5.323G	20	5.544G
21	5.277G	22	5.302G	23	5.545G	24	5.577G
25	5.388G	26	5.258G	27	5.386G	28	5.434G
29	5.312G	30	5.595G	31	5.689G	32	5.420G
33	5.287G	34	5.408G	35	5.464G	36	5.511G
37	5.443G	38	5.427G	39	5.416G	40	5.365G
41	5.500G	42	5.587G	43	5.457G	44	5.395G
45	5.621G	46	5.588G	47	5.442G	48	5.411G
49	5.390G	50	5.539G	51	5.425G	52	5.521G
53	5.722G	54	5.696G	55	5.413G	56	5.529G
57	5.355G	58	5.656G	59	5.704G	60	5.316G
61	5.480G	62	5.581G	63	5.632G	64	5.676G
65	5.482G	66	5.432G	67	5.259G	68	5.438G
69	5.694G	70	5.580G	71	5.536G	72	5.663G
73	5.495G	74	5.674G	75	5.347G	76	5.400G
77	5.465G	78	5.330G	79	5.589G	80	5.519G
81	5.699G	82	5.645G	83	5.380G	84	5.672G
85	5.635G	86	5.548G	87	5.563G	88	5.710G
89	5.348G	90	5.629G	91	5.641G	92	5.509G
93	5.317G	94	5.384G	95	5.562G	96	5.666G
97	5.332G	98	5.456G	99	5.262G	100	5.701G

Hopping Frequency Sequence Name: HOP_FREQ_SEQ_15							
SEQ#	Frequency (Hz)	SEQ#	Frequency (Hz)	SEQ#	Frequency (Hz)	SEQ#	Frequency (Hz)
1	5.332G	2	5.253G	3	5.256G	4	5.368G
5	5.366G	6	5.427G	7	5.495G	8	5.322G
9	5.496G	10	5.474G	11	5.448G	12	5.678G
13	5.410G	14	5.687G	15	5.686G	16	5.533G
17	5.269G	18	5.385G	19	5.429G	20	5.261G
21	5.585G	22	5.509G	23	5.255G	24	5.478G
25	5.360G	26	5.339G	27	5.335G	28	5.512G
29	5.604G	30	5.462G	31	5.479G	32	5.562G
33	5.693G	34	5.337G	35	5.671G	36	5.260G
37	5.382G	38	5.556G	39	5.523G	40	5.292G
41	5.273G	42	5.313G	43	5.586G	44	5.668G
45	5.317G	46	5.324G	47	5.505G	48	5.486G
49	5.358G	50	5.493G	51	5.456G	52	5.610G
53	5.528G	54	5.590G	55	5.506G	56	5.517G
57	5.530G	58	5.640G	59	5.318G	60	5.274G
61	5.381G	62	5.579G	63	5.667G	64	5.661G
65	5.415G	66	5.442G	67	5.621G	68	5.552G
69	5.455G	70	5.300G	71	5.441G	72	5.491G
73	5.722G	74	5.305G	75	5.331G	76	5.365G
77	5.390G	78	5.637G	79	5.266G	80	5.591G
81	5.563G	82	5.607G	83	5.461G	84	5.262G
85	5.605G	86	5.617G	87	5.403G	88	5.600G
89	5.492G	90	5.294G	91	5.706G	92	5.507G
93	5.284G	94	5.298G	95	5.564G	96	5.650G
97	5.537G	98	5.611G	99	5.645G	100	5.413G

Hopping Frequency Sequence Name: HOP_FREQ_SEQ_16							
SEQ#	Frequency (Hz)	SEQ#	Frequency (Hz)	SEQ#	Frequency (Hz)	SEQ#	Frequency (Hz)
1	5.469G	2	5.426G	3	5.347G	4	5.449G
5	5.330G	6	5.537G	7	5.391G	8	5.687G
9	5.666G	10	5.332G	11	5.651G	12	5.341G
13	5.352G	14	5.457G	15	5.686G	16	5.531G
17	5.693G	18	5.631G	19	5.269G	20	5.525G
21	5.702G	22	5.403G	23	5.536G	24	5.363G
25	5.516G	26	5.538G	27	5.490G	28	5.511G
29	5.724G	30	5.704G	31	5.442G	32	5.441G
33	5.411G	34	5.717G	35	5.571G	36	5.647G
37	5.649G	38	5.606G	39	5.319G	40	5.448G
41	5.504G	42	5.472G	43	5.609G	44	5.438G
45	5.545G	46	5.480G	47	5.256G	48	5.679G
49	5.382G	50	5.284G	51	5.543G	52	5.424G
53	5.317G	54	5.520G	55	5.604G	56	5.397G
57	5.505G	58	5.463G	59	5.685G	60	5.602G
61	5.270G	62	5.618G	63	5.662G	64	5.273G
65	5.707G	66	5.664G	67	5.552G	68	5.294G
69	5.320G	70	5.464G	71	5.641G	72	5.476G
73	5.661G	74	5.566G	75	5.299G	76	5.584G
77	5.619G	78	5.420G	79	5.488G	80	5.593G
81	5.654G	82	5.714G	83	5.287G	84	5.657G
85	5.337G	86	5.644G	87	5.648G	88	5.659G
89	5.251G	90	5.265G	91	5.279G	92	5.359G
93	5.460G	94	5.413G	95	5.308G	96	5.544G
97	5.640G	98	5.394G	99	5.348G	100	5.613G

Hopping Frequency Sequence Name: HOP_FREQ_SEQ_17							
SEQ#	Frequency (Hz)	SEQ#	Frequency (Hz)	SEQ#	Frequency (Hz)	SEQ#	Frequency (Hz)
1	5.421G	2	5.498G	3	5.713G	4	5.660G
5	5.583G	6	5.662G	7	5.657G	8	5.641G
9	5.268G	10	5.654G	11	5.517G	12	5.259G
13	5.485G	14	5.419G	15	5.276G	16	5.649G
17	5.467G	18	5.646G	19	5.359G	20	5.642G
21	5.659G	22	5.620G	23	5.345G	24	5.257G
25	5.288G	26	5.478G	27	5.637G	28	5.252G
29	5.489G	30	5.274G	31	5.703G	32	5.534G
33	5.376G	34	5.719G	35	5.682G	36	5.413G
37	5.614G	38	5.448G	39	5.256G	40	5.365G
41	5.587G	42	5.350G	43	5.605G	44	5.447G
45	5.328G	46	5.710G	47	5.330G	48	5.679G
49	5.557G	50	5.674G	51	5.437G	52	5.668G
53	5.714G	54	5.353G	55	5.488G	56	5.427G
57	5.577G	58	5.482G	59	5.700G	60	5.626G
61	5.307G	62	5.464G	63	5.423G	64	5.336G
65	5.617G	66	5.608G	67	5.562G	68	5.443G
69	5.446G	70	5.561G	71	5.493G	72	5.560G
73	5.304G	74	5.354G	75	5.495G	76	5.680G
77	5.397G	78	5.344G	79	5.426G	80	5.425G
81	5.599G	82	5.567G	83	5.510G	84	5.555G
85	5.625G	86	5.324G	87	5.707G	88	5.262G
89	5.501G	90	5.651G	91	5.292G	92	5.424G
93	5.573G	94	5.411G	95	5.597G	96	5.691G
97	5.435G	98	5.459G	99	5.282G	100	5.600G

Hopping Frequency Sequence Name: HOP_FREQ_SEQ_18							
SEQ#	Frequency (Hz)	SEQ#	Frequency (Hz)	SEQ#	Frequency (Hz)	SEQ#	Frequency (Hz)
1	5.471G	2	5.678G	3	5.410G	4	5.537G
5	5.446G	6	5.666G	7	5.563G	8	5.355G
9	5.484G	10	5.489G	11	5.556G	12	5.596G
13	5.454G	14	5.682G	15	5.554G	16	5.595G
17	5.270G	18	5.610G	19	5.586G	20	5.549G
21	5.264G	22	5.415G	23	5.266G	24	5.339G
25	5.662G	26	5.697G	27	5.379G	28	5.392G
29	5.301G	30	5.334G	31	5.573G	32	5.643G
33	5.253G	34	5.439G	35	5.300G	36	5.519G
37	5.267G	38	5.689G	39	5.539G	40	5.455G
41	5.468G	42	5.613G	43	5.496G	44	5.665G
45	5.381G	46	5.250G	47	5.298G	48	5.272G
49	5.592G	50	5.360G	51	5.532G	52	5.324G
53	5.710G	54	5.409G	55	5.517G	56	5.467G
57	5.647G	58	5.668G	59	5.309G	60	5.548G
61	5.317G	62	5.428G	63	5.597G	64	5.314G
65	5.481G	66	5.308G	67	5.584G	68	5.622G
69	5.358G	70	5.466G	71	5.616G	72	5.295G
73	5.364G	74	5.261G	75	5.655G	76	5.660G
77	5.457G	78	5.672G	79	5.565G	80	5.652G
81	5.260G	82	5.683G	83	5.343G	84	5.401G
85	5.325G	86	5.686G	87	5.353G	88	5.315G
89	5.373G	90	5.402G	91	5.352G	92	5.599G
93	5.626G	94	5.702G	95	5.258G	96	5.460G
97	5.724G	98	5.670G	99	5.444G	100	5.388G



Hopping Frequency Sequence Name: HOP_FREQ_SEQ_19							
SEQ#	Frequency (Hz)	SEQ#	Frequency (Hz)	SEQ#	Frequency (Hz)	SEQ#	Frequency (Hz)
1	5.550G	2	5.672G	3	5.305G	4	5.508G
5	5.713G	6	5.500G	7	5.312G	8	5.704G
9	5.291G	10	5.288G	11	5.664G	12	5.468G
13	5.405G	14	5.558G	15	5.313G	16	5.308G
17	5.390G	18	5.685G	19	5.526G	20	5.394G
21	5.616G	22	5.333G	23	5.419G	24	5.461G
25	5.417G	26	5.393G	27	5.427G	28	5.650G
29	5.376G	30	5.351G	31	5.656G	32	5.494G
33	5.700G	34	5.365G	35	5.624G	36	5.551G
37	5.259G	38	5.657G	39	5.470G	40	5.666G
41	5.250G	42	5.501G	43	5.681G	44	5.496G
45	5.370G	46	5.689G	47	5.535G	48	5.271G
49	5.444G	50	5.696G	51	5.337G	52	5.621G
53	5.265G	54	5.399G	55	5.609G	56	5.722G
57	5.401G	58	5.667G	59	5.473G	60	5.511G
61	5.350G	62	5.614G	63	5.516G	64	5.409G
65	5.260G	66	5.709G	67	5.677G	68	5.590G
69	5.671G	70	5.418G	71	5.297G	72	5.623G
73	5.539G	74	5.371G	75	5.280G	76	5.422G
77	5.607G	78	5.407G	79	5.533G	80	5.316G
81	5.301G	82	5.640G	83	5.610G	84	5.454G
85	5.413G	86	5.512G	87	5.577G	88	5.557G
89	5.471G	90	5.622G	91	5.439G	92	5.361G
93	5.582G	94	5.360G	95	5.440G	96	5.537G
97	5.406G	98	5.585G	99	5.342G	100	5.462G

Hopping Frequency Sequence Name: HOP_FREQ_SEQ_20							
SEQ#	Frequency (Hz)	SEQ#	Frequency (Hz)	SEQ#	Frequency (Hz)	SEQ#	Frequency (Hz)
1	5.664G	2	5.377G	3	5.595G	4	5.701G
5	5.596G	6	5.490G	7	5.573G	8	5.706G
9	5.594G	10	5.393G	11	5.581G	12	5.592G
13	5.403G	14	5.547G	15	5.428G	16	5.314G
17	5.643G	18	5.585G	19	5.444G	20	5.405G
21	5.279G	22	5.294G	23	5.477G	24	5.277G
25	5.543G	26	5.338G	27	5.720G	28	5.613G
29	5.323G	30	5.541G	31	5.496G	32	5.270G
33	5.499G	34	5.410G	35	5.530G	36	5.339G
37	5.452G	38	5.287G	39	5.423G	40	5.375G
41	5.328G	42	5.644G	43	5.620G	44	5.333G
45	5.635G	46	5.566G	47	5.645G	48	5.497G
49	5.325G	50	5.417G	51	5.523G	52	5.562G
53	5.605G	54	5.495G	55	5.271G	56	5.693G
57	5.442G	58	5.524G	59	5.637G	60	5.407G
61	5.421G	62	5.342G	63	5.435G	64	5.590G
65	5.636G	66	5.711G	67	5.468G	68	5.288G
69	5.488G	70	5.719G	71	5.699G	72	5.400G
73	5.343G	74	5.589G	75	5.379G	76	5.408G
77	5.406G	78	5.712G	79	5.370G	80	5.268G
81	5.299G	82	5.576G	83	5.619G	84	5.332G
85	5.361G	86	5.465G	87	5.517G	88	5.485G
89	5.724G	90	5.557G	91	5.297G	92	5.586G
93	5.321G	94	5.368G	95	5.683G	96	5.526G
97	5.649G	98	5.587G	99	5.582G	100	5.681G

Hopping Frequency Sequence Name: HOP_FREQ_SEQ_21							
SEQ#	Frequency (Hz)	SEQ#	Frequency (Hz)	SEQ#	Frequency (Hz)	SEQ#	Frequency (Hz)
1	5.265G	2	5.645G	3	5.335G	4	5.680G
5	5.551G	6	5.661G	7	5.669G	8	5.387G
9	5.352G	10	5.635G	11	5.451G	12	5.534G
13	5.511G	14	5.708G	15	5.721G	16	5.644G
17	5.524G	18	5.634G	19	5.453G	20	5.698G
21	5.631G	22	5.445G	23	5.279G	24	5.582G
25	5.488G	26	5.687G	27	5.292G	28	5.673G
29	5.361G	30	5.256G	31	5.471G	32	5.523G
33	5.464G	34	5.330G	35	5.555G	36	5.499G
37	5.700G	38	5.613G	39	5.695G	40	5.672G
41	5.591G	42	5.399G	43	5.432G	44	5.664G
45	5.578G	46	5.571G	47	5.478G	48	5.463G
49	5.431G	50	5.516G	51	5.371G	52	5.652G
53	5.709G	54	5.692G	55	5.421G	56	5.480G
57	5.425G	58	5.293G	59	5.285G	60	5.693G
61	5.666G	62	5.609G	63	5.377G	64	5.338G
65	5.597G	66	5.430G	67	5.568G	68	5.489G
69	5.495G	70	5.479G	71	5.304G	72	5.527G
73	5.473G	74	5.397G	75	5.643G	76	5.626G
77	5.411G	78	5.702G	79	5.409G	80	5.512G
81	5.599G	82	5.497G	83	5.393G	84	5.351G
85	5.706G	86	5.327G	87	5.660G	88	5.437G
89	5.322G	90	5.566G	91	5.553G	92	5.501G
93	5.315G	94	5.590G	95	5.385G	96	5.650G
97	5.614G	98	5.705G	99	5.276G	100	5.469G

Hopping Frequency Sequence Name: HOP_FREQ_SEQ_22							
SEQ#	Frequency (Hz)	SEQ#	Frequency (Hz)	SEQ#	Frequency (Hz)	SEQ#	Frequency (Hz)
1	5.609G	2	5.255G	3	5.447G	4	5.276G
5	5.345G	6	5.385G	7	5.526G	8	5.623G
9	5.601G	10	5.535G	11	5.657G	12	5.300G
13	5.306G	14	5.708G	15	5.495G	16	5.422G
17	5.658G	18	5.379G	19	5.692G	20	5.502G
21	5.253G	22	5.498G	23	5.380G	24	5.670G
25	5.460G	26	5.514G	27	5.545G	28	5.319G
29	5.252G	30	5.457G	31	5.478G	32	5.707G
33	5.722G	34	5.681G	35	5.329G	36	5.390G
37	5.367G	38	5.622G	39	5.286G	40	5.472G
41	5.435G	42	5.427G	43	5.458G	44	5.715G
45	5.537G	46	5.312G	47	5.671G	48	5.521G
49	5.322G	50	5.655G	51	5.308G	52	5.484G
53	5.361G	54	5.304G	55	5.259G	56	5.418G
57	5.360G	58	5.724G	59	5.594G	60	5.420G
61	5.549G	62	5.454G	63	5.314G	64	5.569G
65	5.467G	66	5.450G	67	5.519G	68	5.444G
69	5.268G	70	5.663G	71	5.709G	72	5.610G
73	5.621G	74	5.647G	75	5.648G	76	5.557G
77	5.529G	78	5.483G	79	5.589G	80	5.377G
81	5.338G	82	5.698G	83	5.433G	84	5.446G
85	5.618G	86	5.597G	87	5.393G	88	5.554G
89	5.477G	90	5.403G	91	5.280G	92	5.719G
93	5.263G	94	5.465G	95	5.305G	96	5.646G
97	5.550G	98	5.396G	99	5.637G	100	5.716G

Hopping Frequency Sequence Name: HOP_FREQ_SEQ_23							
SEQ#	Frequency (Hz)	SEQ#	Frequency (Hz)	SEQ#	Frequency (Hz)	SEQ#	Frequency (Hz)
1	5.401G	2	5.459G	3	5.412G	4	5.639G
5	5.383G	6	5.630G	7	5.689G	8	5.673G
9	5.441G	10	5.384G	11	5.432G	12	5.451G
13	5.608G	14	5.440G	15	5.593G	16	5.398G
17	5.590G	18	5.280G	19	5.339G	20	5.257G
21	5.702G	22	5.422G	23	5.648G	24	5.683G
25	5.642G	26	5.479G	27	5.354G	28	5.718G
29	5.633G	30	5.620G	31	5.562G	32	5.334G
33	5.515G	34	5.546G	35	5.585G	36	5.486G
37	5.366G	38	5.409G	39	5.375G	40	5.392G
41	5.482G	42	5.313G	43	5.660G	44	5.279G
45	5.563G	46	5.617G	47	5.694G	48	5.307G
49	5.314G	50	5.376G	51	5.447G	52	5.697G
53	5.393G	54	5.698G	55	5.335G	56	5.358G
57	5.503G	58	5.605G	59	5.712G	60	5.413G
61	5.285G	62	5.662G	63	5.576G	64	5.429G
65	5.365G	66	5.653G	67	5.284G	68	5.687G
69	5.415G	70	5.315G	71	5.347G	72	5.722G
73	5.613G	74	5.372G	75	5.425G	76	5.504G
77	5.723G	78	5.330G	79	5.672G	80	5.473G
81	5.423G	82	5.618G	83	5.526G	84	5.452G
85	5.301G	86	5.460G	87	5.652G	88	5.592G
89	5.547G	90	5.286G	91	5.614G	92	5.603G
93	5.696G	94	5.484G	95	5.721G	96	5.343G
97	5.519G	98	5.667G	99	5.407G	100	5.489G

Hopping Frequency Sequence Name: HOP_FREQ_SEQ_24							
SEQ#	Frequency (Hz)	SEQ#	Frequency (Hz)	SEQ#	Frequency (Hz)	SEQ#	Frequency (Hz)
1	5.338G	2	5.690G	3	5.513G	4	5.614G
5	5.452G	6	5.451G	7	5.357G	8	5.646G
9	5.375G	10	5.403G	11	5.400G	12	5.341G
13	5.469G	14	5.723G	15	5.707G	16	5.314G
17	5.708G	18	5.474G	19	5.336G	20	5.416G
21	5.427G	22	5.521G	23	5.593G	24	5.611G
25	5.598G	26	5.558G	27	5.652G	28	5.581G
29	5.383G	30	5.642G	31	5.313G	32	5.649G
33	5.722G	34	5.664G	35	5.561G	36	5.594G
37	5.266G	38	5.334G	39	5.685G	40	5.701G
41	5.437G	42	5.544G	43	5.332G	44	5.603G
45	5.465G	46	5.379G	47	5.579G	48	5.262G
49	5.250G	50	5.724G	51	5.283G	52	5.291G
53	5.587G	54	5.391G	55	5.329G	56	5.382G
57	5.372G	58	5.645G	59	5.455G	60	5.596G
61	5.422G	62	5.251G	63	5.609G	64	5.559G
65	5.497G	66	5.253G	67	5.545G	68	5.438G
69	5.488G	70	5.697G	71	5.503G	72	5.348G
73	5.583G	74	5.390G	75	5.647G	76	5.377G
77	5.535G	78	5.298G	79	5.556G	80	5.571G
81	5.644G	82	5.625G	83	5.490G	84	5.610G
85	5.592G	86	5.426G	87	5.280G	88	5.591G
89	5.305G	90	5.564G	91	5.721G	92	5.285G
93	5.526G	94	5.315G	95	5.698G	96	5.624G
97	5.258G	98	5.505G	99	5.606G	100	5.516G

Hopping Frequency Sequence Name: HOP_FREQ_SEQ_25							
SEQ#	Frequency (Hz)	SEQ#	Frequency (Hz)	SEQ#	Frequency (Hz)	SEQ#	Frequency (Hz)
1	5.337G	2	5.639G	3	5.406G	4	5.583G
5	5.403G	6	5.551G	7	5.705G	8	5.571G
9	5.488G	10	5.253G	11	5.519G	12	5.369G
13	5.575G	14	5.445G	15	5.511G	16	5.419G
17	5.619G	18	5.261G	19	5.473G	20	5.710G
21	5.580G	22	5.657G	23	5.446G	24	5.508G
25	5.355G	26	5.634G	27	5.334G	28	5.460G
29	5.648G	30	5.546G	31	5.608G	32	5.674G
33	5.534G	34	5.723G	35	5.256G	36	5.629G
37	5.459G	38	5.352G	39	5.293G	40	5.517G
41	5.322G	42	5.467G	43	5.557G	44	5.672G
45	5.703G	46	5.415G	47	5.296G	48	5.547G
49	5.435G	50	5.465G	51	5.260G	52	5.282G
53	5.374G	54	5.430G	55	5.494G	56	5.640G
57	5.268G	58	5.432G	59	5.392G	60	5.307G
61	5.393G	62	5.344G	63	5.416G	64	5.285G
65	5.638G	66	5.597G	67	5.516G	68	5.690G
69	5.449G	70	5.504G	71	5.572G	72	5.669G
73	5.594G	74	5.532G	75	5.628G	76	5.673G
77	5.448G	78	5.537G	79	5.326G	80	5.266G
81	5.697G	82	5.522G	83	5.678G	84	5.655G
85	5.422G	86	5.317G	87	5.602G	88	5.264G
89	5.589G	90	5.627G	91	5.491G	92	5.701G
93	5.436G	94	5.680G	95	5.478G	96	5.558G
97	5.320G	98	5.662G	99	5.525G	100	5.434G

Hopping Frequency Sequence Name: HOP_FREQ_SEQ_26							
SEQ#	Frequency (Hz)	SEQ#	Frequency (Hz)	SEQ#	Frequency (Hz)	SEQ#	Frequency (Hz)
1	5.518G	2	5.489G	3	5.280G	4	5.598G
5	5.417G	6	5.447G	7	5.418G	8	5.400G
9	5.674G	10	5.631G	11	5.668G	12	5.577G
13	5.654G	14	5.251G	15	5.570G	16	5.649G
17	5.318G	18	5.373G	19	5.558G	20	5.544G
21	5.331G	22	5.695G	23	5.395G	24	5.628G
25	5.551G	26	5.338G	27	5.678G	28	5.375G
29	5.448G	30	5.254G	31	5.693G	32	5.273G
33	5.501G	34	5.596G	35	5.406G	36	5.295G
37	5.253G	38	5.430G	39	5.315G	40	5.650G
41	5.565G	42	5.504G	43	5.533G	44	5.664G
45	5.547G	46	5.307G	47	5.385G	48	5.561G
49	5.521G	50	5.303G	51	5.383G	52	5.525G
53	5.300G	54	5.641G	55	5.613G	56	5.291G
57	5.614G	58	5.588G	59	5.365G	60	5.294G
61	5.600G	62	5.445G	63	5.387G	64	5.468G
65	5.405G	66	5.429G	67	5.450G	68	5.288G
69	5.462G	70	5.464G	71	5.443G	72	5.659G
73	5.344G	74	5.636G	75	5.611G	76	5.432G
77	5.341G	78	5.532G	79	5.420G	80	5.449G
81	5.284G	82	5.414G	83	5.724G	84	5.440G
85	5.556G	86	5.455G	87	5.499G	88	5.474G
89	5.481G	90	5.363G	91	5.478G	92	5.456G
93	5.264G	94	5.633G	95	5.589G	96	5.686G
97	5.538G	98	5.569G	99	5.524G	100	5.578G



Hopping Frequency Sequence Name: HOP_FREQ_SEQ_27							
SEQ#	Frequency (Hz)	SEQ#	Frequency (Hz)	SEQ#	Frequency (Hz)	SEQ#	Frequency (Hz)
1	5.368G	2	5.583G	3	5.564G	4	5.520G
5	5.428G	6	5.366G	7	5.611G	8	5.390G
9	5.616G	10	5.556G	11	5.539G	12	5.485G
13	5.360G	14	5.302G	15	5.581G	16	5.614G
17	5.353G	18	5.358G	19	5.582G	20	5.325G
21	5.348G	22	5.292G	23	5.287G	24	5.567G
25	5.615G	26	5.346G	27	5.531G	28	5.263G
29	5.272G	30	5.282G	31	5.657G	32	5.554G
33	5.618G	34	5.580G	35	5.525G	36	5.291G
37	5.715G	38	5.343G	39	5.534G	40	5.312G
41	5.275G	42	5.270G	43	5.718G	44	5.696G
45	5.671G	46	5.307G	47	5.332G	48	5.721G
49	5.462G	50	5.714G	51	5.451G	52	5.679G
53	5.422G	54	5.317G	55	5.640G	56	5.695G
57	5.722G	58	5.598G	59	5.607G	60	5.648G
61	5.547G	62	5.396G	63	5.523G	64	5.659G
65	5.624G	66	5.584G	67	5.660G	68	5.452G
69	5.550G	70	5.440G	71	5.683G	72	5.382G
73	5.562G	74	5.578G	75	5.513G	76	5.393G
77	5.379G	78	5.409G	79	5.362G	80	5.297G
81	5.597G	82	5.337G	83	5.711G	84	5.460G
85	5.576G	86	5.605G	87	5.645G	88	5.591G
89	5.667G	90	5.398G	91	5.456G	92	5.380G
93	5.710G	94	5.636G	95	5.315G	96	5.277G
97	5.441G	98	5.676G	99	5.593G	100	5.394G

Hopping Frequency Sequence Name: HOP_FREQ_SEQ_28							
SEQ#	Frequency (Hz)	SEQ#	Frequency (Hz)	SEQ#	Frequency (Hz)	SEQ#	Frequency (Hz)
1	5.336G	2	5.506G	3	5.514G	4	5.286G
5	5.715G	6	5.452G	7	5.408G	8	5.722G
9	5.332G	10	5.606G	11	5.608G	12	5.630G
13	5.676G	14	5.547G	15	5.568G	16	5.436G
17	5.503G	18	5.344G	19	5.723G	20	5.331G
21	5.637G	22	5.454G	23	5.589G	24	5.517G
25	5.586G	26	5.474G	27	5.267G	28	5.686G
29	5.333G	30	5.540G	31	5.585G	32	5.678G
33	5.482G	34	5.549G	35	5.473G	36	5.695G
37	5.412G	38	5.600G	39	5.620G	40	5.272G
41	5.499G	42	5.424G	43	5.366G	44	5.594G
45	5.526G	46	5.625G	47	5.632G	48	5.572G
49	5.260G	50	5.463G	51	5.679G	52	5.444G
53	5.716G	54	5.388G	55	5.587G	56	5.592G
57	5.399G	58	5.327G	59	5.607G	60	5.529G
61	5.455G	62	5.554G	63	5.688G	64	5.534G
65	5.250G	66	5.295G	67	5.541G	68	5.402G
69	5.551G	70	5.595G	71	5.459G	72	5.516G
73	5.467G	74	5.544G	75	5.358G	76	5.393G
77	5.490G	78	5.656G	79	5.493G	80	5.639G
81	5.410G	82	5.494G	83	5.346G	84	5.304G
85	5.357G	86	5.616G	87	5.339G	88	5.316G
89	5.318G	90	5.510G	91	5.405G	92	5.697G
93	5.483G	94	5.535G	95	5.672G	96	5.645G
97	5.558G	98	5.284G	99	5.460G	100	5.519G

Hopping Frequency Sequence Name: HOP_FREQ_SEQ_29							
SEQ#	Frequency (Hz)	SEQ#	Frequency (Hz)	SEQ#	Frequency (Hz)	SEQ#	Frequency (Hz)
1	5.666G	2	5.685G	3	5.395G	4	5.370G
5	5.611G	6	5.291G	7	5.687G	8	5.327G
9	5.307G	10	5.486G	11	5.389G	12	5.604G
13	5.319G	14	5.463G	15	5.445G	16	5.357G
17	5.415G	18	5.721G	19	5.587G	20	5.585G
21	5.558G	22	5.574G	23	5.675G	24	5.566G
25	5.679G	26	5.570G	27	5.488G	28	5.640G
29	5.406G	30	5.617G	31	5.386G	32	5.592G
33	5.382G	34	5.448G	35	5.479G	36	5.461G
37	5.273G	38	5.671G	39	5.458G	40	5.432G
41	5.544G	42	5.271G	43	5.628G	44	5.343G
45	5.689G	46	5.709G	47	5.691G	48	5.529G
49	5.540G	50	5.633G	51	5.623G	52	5.667G
53	5.536G	54	5.277G	55	5.577G	56	5.625G
57	5.454G	58	5.595G	59	5.660G	60	5.564G
61	5.673G	62	5.362G	63	5.692G	64	5.252G
65	5.680G	66	5.304G	67	5.459G	68	5.436G
69	5.314G	70	5.723G	71	5.423G	72	5.651G
73	5.435G	74	5.553G	75	5.562G	76	5.602G
77	5.368G	78	5.646G	79	5.441G	80	5.412G
81	5.718G	82	5.552G	83	5.430G	84	5.607G
85	5.404G	86	5.393G	87	5.420G	88	5.672G
89	5.669G	90	5.596G	91	5.384G	92	5.428G
93	5.495G	94	5.268G	95	5.606G	96	5.551G
97	5.377G	98	5.588G	99	5.352G	100	5.477G

Hopping Frequency Sequence Name: HOP_FREQ_SEQ_30							
SEQ#	Frequency (Hz)	SEQ#	Frequency (Hz)	SEQ#	Frequency (Hz)	SEQ#	Frequency (Hz)
1	5.458G	2	5.613G	3	5.717G	4	5.475G
5	5.607G	6	5.589G	7	5.417G	8	5.406G
9	5.298G	10	5.318G	11	5.710G	12	5.667G
13	5.351G	14	5.347G	15	5.300G	16	5.619G
17	5.309G	18	5.502G	19	5.578G	20	5.639G
21	5.573G	22	5.448G	23	5.462G	24	5.721G
25	5.389G	26	5.509G	27	5.414G	28	5.443G
29	5.262G	30	5.571G	31	5.558G	32	5.285G
33	5.529G	34	5.606G	35	5.419G	36	5.352G
37	5.566G	38	5.459G	39	5.304G	40	5.398G
41	5.339G	42	5.408G	43	5.281G	44	5.663G
45	5.690G	46	5.405G	47	5.335G	48	5.577G
49	5.491G	50	5.424G	51	5.411G	52	5.581G
53	5.715G	54	5.686G	55	5.267G	56	5.594G
57	5.277G	58	5.596G	59	5.457G	60	5.554G
61	5.388G	62	5.669G	63	5.474G	64	5.720G
65	5.453G	66	5.658G	67	5.500G	68	5.677G
69	5.358G	70	5.287G	71	5.338G	72	5.394G
73	5.609G	74	5.676G	75	5.353G	76	5.379G
77	5.616G	78	5.625G	79	5.257G	80	5.595G
81	5.588G	82	5.426G	83	5.556G	84	5.680G
85	5.373G	86	5.674G	87	5.350G	88	5.628G
89	5.423G	90	5.418G	91	5.260G	92	5.590G
93	5.392G	94	5.532G	95	5.478G	96	5.582G
97	5.562G	98	5.326G	99	5.548G	100	5.286G

**IEEE 802.11ac VHT40**

Type 1 Radar Statistical Performances						
Trial #	Pulse Repetition Frequency Number(1 to 23)	PRF(Pulse per seconds)	Pulses per Burst	PRI ( $\mu$ sec)	Radar Frequency (MHz)	Detection
1	23	326.2	18	3066	5513	Yes
2	9	1474.9	78	678	5520	Yes
3	16	1222.5	65	818	5493	Yes
4	5	1672.2	89	598	5498	Yes
5	7	1567.4	83	638	5507	Yes
6	15	1253.1	67	798	5515	Yes
7	12	1355	72	738	5514	Yes
8	20	1113.6	59	898	5496	Yes
9	11	1392.8	74	718	5522	Yes
10	3	1792.1	95	558	5526	Yes
11	19	1139	61	878	5501	Yes
12	17	1193.3	63	838	5502	Yes
13	2	1858.7	99	538	5523	Yes
14	8	1519.8	81	658	5504	Yes
15	22	1066.1	57	938	5511	Yes
16		1065.0	57	939	5494	Yes
17		499.0	27	2004	5491	Yes
18		627.7	34	1593	5508	Yes
19		636.5	34	1571	5528	Yes
20		1179.2	63	848	5512	Yes
21		370.8	20	2697	5529	Yes
22		590.7	32	1693	5510	Yes
23		557.7	30	1793	5524	Yes
24		989.1	53	1011	5509	Yes
25		349.4	19	2862	5495	Yes
26		997.0	53	1003	5517	Yes
27		363.5	20	2751	5521	Yes
28		492.9	27	2029	5518	Yes
29		1326.3	70	754	5519	Yes
30		803.2	43	1245	5497	Yes
Detection Rate: 100 %						

Type 2 Radar Statistical Performances					
Trial #	Pulses per Burst	Pulse Width ( $\mu$ sec)	PRI ( $\mu$ sec)	Radar Frequency (MHz)	Detection
1	29	4.9	210	5495	Yes
2	24	1.7	178	5492	Yes
3	25	2.1	173	5520	Yes
4	28	4	222	5508	Yes
5	27	3.6	219	5529	Yes
6	29	5	212	5494	No
7	29	4.9	176	5514	Yes
8	23	1.1	199	5503	Yes
9	23	1.2	162	5496	Yes
10	29	4.5	220	5511	Yes
11	29	5	229	5517	Yes
12	29	5	214	5502	Yes
13	25	2.4	153	5512	Yes
14	28	4.1	197	5504	Yes
15	24	2	211	5506	Yes
16	29	4.6	190	5491	Yes
17	23	1	213	5507	Yes
18	25	2.4	218	5499	Yes
19	26	3.2	215	5493	Yes
20	26	3.1	157	5498	Yes
21	25	2.7	168	5497	Yes
22	25	2.6	227	5524	Yes
23	24	2	171	5523	Yes
24	23	1.1	158	5500	Yes
25	23	1	167	5519	Yes
26	29	4.9	150	5528	Yes
27	29	4.8	191	5501	Yes
28	25	2.3	159	5505	Yes
29	28	4.3	226	5526	Yes
30	26	3.3	208	5516	Yes
					Detection Rate: 96.67 %

Type 3 Radar Statistical Performances					
Trial #	Pulses per Burst	Pulse Width ( $\mu$ sec)	PRI ( $\mu$ sec)	Radar Frequency (MHz)	Detection
1	18	9.9	235	5523	Yes
2	16	6.7	357	5492	Yes
3	16	7.1	333	5512	Yes
4	18	9	242	5494	Yes
5	17	8.6	397	5515	Yes
6	18	10	302	5493	No
7	18	9.9	203	5520	Yes
8	16	6.1	428	5501	Yes
9	16	6.2	335	5521	Yes
10	18	9.5	240	5510	Yes
11	18	10	224	5505	No
12	18	10	410	5506	Yes
13	17	7.4	359	5526	Yes
14	18	9.1	269	5504	Yes
15	16	7	250	5518	Yes
16	18	9.6	247	5522	Yes
17	16	6	222	5495	No
18	17	7.4	424	5497	Yes
19	17	8.2	393	5491	Yes
20	17	8.1	382	5500	Yes
21	17	7.7	486	5511	Yes
22	17	7.6	480	5507	Yes
23	16	7	360	5513	Yes
24	16	6.1	297	5503	Yes
25	16	6	265	5525	Yes
26	18	9.9	263	5516	Yes
27	18	9.8	324	5519	Yes
28	17	7.3	386	5514	Yes
29	18	9.3	311	5498	No
30	17	8.3	378	5496	No
					Detection Rate: 83.33 %

Type 4 Radar Statistical Performances					
Trial #	Pulses per Burst	Pulse Width ( $\mu$ sec)	PRI ( $\mu$ sec)	Radar Frequency (MHz)	Detection
1	16	19.7	235	5491	Yes
2	12	12.7	357	5516	Yes
3	13	13.6	333	5518	No
4	15	17.7	242	5521	Yes
5	15	16.8	397	5509	Yes
6	16	20	302	5496	Yes
7	16	19.7	203	5497	Yes
8	12	11.3	428	5507	No
9	12	11.5	335	5500	No
10	16	18.8	240	5519	No
11	16	20	224	5501	No
12	16	20	410	5508	Yes
13	13	14.2	359	5520	Yes
14	15	18	269	5524	No
15	13	13.3	250	5505	Yes
16	16	19	247	5492	Yes
17	12	11.1	222	5527	Yes
18	13	14.2	424	5502	No
19	14	15.9	393	5493	Yes
20	14	15.8	382	5514	Yes
21	14	14.8	486	5495	Yes
22	13	14.6	480	5513	No
23	13	13.2	360	5506	Yes
24	12	11.3	297	5522	Yes
25	12	11	265	5529	Yes
26	16	19.6	263	5517	Yes
27	16	19.6	324	5503	Yes
28	13	14	386	5526	No
29	16	18.3	311	5499	No
30	14	16.1	378	5523	Yes
					Detection Rate: 66.67 %



Type 5 Radar Statistical Performances		
Trial #	Test Signal Name	Detection
1	LP_Signal_01	Yes
2	LP_Signal_02	Yes
3	LP_Signal_03	Yes
4	LP_Signal_04	Yes
5	LP_Signal_05	Yes
6	LP_Signal_06	Yes
7	LP_Signal_07	Yes
8	LP_Signal_08	Yes
9	LP_Signal_09	Yes
10	LP_Signal_10	Yes
11	LP_Signal_11	Yes
12	LP_Signal_12	Yes
13	LP_Signal_13	Yes
14	LP_Signal_14	Yes
15	LP_Signal_15	Yes
16	LP_Signal_16	Yes
17	LP_Signal_17	Yes
18	LP_Signal_18	Yes
19	LP_Signal_19	Yes
20	LP_Signal_20	Yes
21	LP_Signal_21	Yes
22	LP_Signal_22	Yes
23	LP_Signal_23	Yes
24	LP_Signal_24	Yes
25	LP_Signal_25	Yes
26	LP_Signal_26	Yes
27	LP_Signal_27	Yes
28	LP_Signal_28	Yes
29	LP_Signal_29	Yes
30	LP_Signal_30	Yes
Detection Rate: 100 %		

Long Pulse Radar Test Signal						
Test Signal Name: LP_Signal_01						
Number of Bursts in Trial: 13						
Chirp Center Frequency: 5510MHz						
Burst	Pulse	Chirp	Number of	PRI-1 (us)	PRI-2 (us)	PRI-3 (us)

	Width (us)	Width (MHz)	Pulses per Burst			
1	72.2	12	2	1002.0	1973.0	-
2	74.1	12	2	1892.0	1635.0	-
3	85.9	12	3	1097.0	1171.0	1514.0
4	68.7	12	2	1150.0	1740.0	-
5	62.1	12	1	1907.0	-	-
6	84.8	12	3	1313.0	1536.0	1177.0
7	85.2	12	3	1597.0	1539.0	1629.0
8	76.2	12	2	1371.0	1764.0	-
9	94.6	12	3	1563.0	1880.0	1548.0
10	52.5	12	1	1528.0	-	-
11	94.6	12	3	1537.0	1935.0	1241.0
12	71.5	12	2	1337.0	1472.0	-
13	66.1	12	1	1824.0	-	-

Long Pulse Radar Test Signal

Test Signal Name: LP\_Signal\_02

Number of Bursts in Trial: 14

Chirp Center Frequency: 5510MHz

Burst	Pulse Width (us)	Chirp Width (MHz)	Number of Pulses per Burst	PRI-1 (us)	PRI-2 (us)	PRI-3 (us)
1	75.3	12	2	1516.0	1581.0	-
2	57.3	12	1	1187.0	-	-
3	97.0	12	3	1767.0	1677.0	1381.0
4	71.3	12	2	1683.0	1622.0	-
5	65.7	12	1	1458.0	-	-
6	56.8	12	1	1388.0	-	-
7	95.0	12	3	1793.0	1254.0	1779.0
8	52.2	12	1	1575.0	-	-
9	54.2	12	1	1682.0	-	-
10	94.1	12	3	1957.0	1485.0	1876.0
11	91.2	12	3	1803.0	1693.0	1628.0
12	91.8	12	3	1897.0	1636.0	1353.0
13	75.0	12	2	1877.0	1456.0	-
14	80.2	12	2	1698.0	1608.0	-

Long Pulse Radar Test Signal

Test Signal Name: LP\_Signal\_03

Number of Bursts in Trial: 17						
Chirp Center Frequency: 5510MHz						
Burst	Pulse Width (us)	Chirp Width (MHz)	Number of Pulses per Burst	PRI-1 (us)	PRI-2 (us)	PRI-3 (us)
1	76.2	16	2	1955.0	1109.0	-
2	97.3	16	3	1836.0	1042.0	1224.0
3	75.3	16	2	1579.0	1126.0	-
4	74.5	16	2	1771.0	1755.0	-
5	51.2	16	1	1133.0	-	-
6	66.1	16	1	1167.0	-	-
7	98.8	16	3	1919.0	1424.0	1985.0
8	61.3	16	1	1454.0	-	-
9	66.4	16	1	1772.0	-	-
10	93.5	16	3	1879.0	1022.0	1857.0
11	85.7	16	3	1980.0	1009.0	1716.0
12	50.5	16	1	1924.0	-	-
13	88.1	16	3	1131.0	1890.0	1939.0
14	68.9	16	2	1806.0	1414.0	-
15	55.3	16	1	1802.0	-	-
16	64.6	16	1	1178.0	-	-
17	57.2	16	1	1238.0	-	-

Long Pulse Radar Test Signal						
Test Signal Name: LP_Signal_04						
Number of Bursts in Trial: 13						
Chirp Center Frequency: 5510MHz						
Burst	Pulse Width (us)	Chirp Width (MHz)	Number of Pulses per Burst	PRI-1 (us)	PRI-2 (us)	PRI-3 (us)
1	78.5	10	2	1267.0	1505.0	-
2	63.3	10	1	1532.0	-	-
3	92.6	10	3	1729.0	1751.0	1928.0
4	91.0	10	3	1808.0	1249.0	1809.0
5	94.9	10	3	1186.0	1732.0	1743.0
6	79.1	10	2	1776.0	1457.0	-
7	50.3	10	1	1914.0	-	-
8	89.3	10	3	1182.0	1251.0	1687.0
9	94.6	10	3	1998.0	1753.0	1228.0
10	64.7	10	1	1100.0	-	-

11	84.0	10	3	1373.0	1450.0	1589.0
12	68.0	10	2	1895.0	1322.0	-

Long Pulse Radar Test Signal						
Test Signal Name: LP_Signal_05						
Number of Bursts in Trial: 11						
Chirp Center Frequency: 5510MHz						
Burst	Pulse Width (us)	Chirp Width (MHz)	Number of Pulses per Burst	PRI-1 (us)	PRI-2 (us)	PRI-3 (us)
1	80.0	8	2	1357.0	1208.0	-
2	94.7	8	3	1931.0	1905.0	1921.0
3	76.9	8	2	1453.0	1021.0	-
4	87.1	8	3	1953.0	1469.0	1706.0
5	54.6	8	1	1301.0	-	-
6	59.0	8	1	1794.0	-	-
7	78.9	8	2	1279.0	1975.0	-
8	69.3	8	2	1288.0	1610.0	-
9	78.0	8	2	1433.0	1025.0	-
10	93.4	8	3	1833.0	1804.0	1493.0
11	55.4	8	1	1495.0	-	-

Long Pulse Radar Test Signal						
Test Signal Name: LP_Signal_06						
Number of Bursts in Trial: 17						
Chirp Center Frequency: 5510MHz						
Burst	Pulse Width (us)	Chirp Width (MHz)	Number of Pulses per Burst	PRI-1 (us)	PRI-2 (us)	PRI-3 (us)
1	67.3	16	2	1530.0	1432.0	-
2	63.9	16	1	1356.0	-	-
3	91.0	16	3	1631.0	1478.0	1219.0
4	53.4	16	1	1609.0	-	-
5	85.7	16	3	1831.0	1535.0	1960.0
6	65.2	16	1	1873.0	-	-
7	68.7	16	2	1791.0	1461.0	-
8	76.1	16	2	1815.0	1300.0	-
9	97.0	16	3	1471.0	1292.0	1452.0
10	89.6	16	3	1436.0	1074.0	1400.0
11	86.9	16	3	1085.0	1093.0	1156.0

12	62.6	16	1	1870.0	-	-
13	78.5	16	2	1447.0	1404.0	-
14	82.5	16	2	1717.0	1689.0	-
15	89.2	16	3	1642.0	1391.0	1274.0
16	81.4	16	2	1624.0	1645.0	-
17	68.2	16	2	1475.0	1250.0	-

Long Pulse Radar Test Signal						
Test Signal Name: LP_Signal_07						
Number of Bursts in Trial: 17						
Chirp Center Frequency: 5510MHz						
Burst	Pulse Width (us)	Chirp Width (MHz)	Number of Pulses per Burst	PRI-1 (us)	PRI-2 (us)	PRI-3 (us)
1	74.9	16	2	1350.0	1816.0	-
2	85.3	16	3	1965.0	1440.0	1583.0
3	56.6	16	1	1739.0	-	-
4	51.4	16	1	1819.0	-	-
5	64.8	16	1	1673.0	-	-
6	93.4	16	3	1271.0	1504.0	1275.0
7	86.4	16	3	1203.0	1064.0	1347.0
8	98.9	16	3	1611.0	1958.0	1546.0
9	58.7	16	1	1638.0	-	-
10	63.4	16	1	1316.0	-	-
11	83.5	16	3	1741.0	1293.0	1305.0
12	59.8	16	1	1820.0	-	-
13	76.4	16	2	1484.0	1835.0	-
14	95.4	16	3	1423.0	1827.0	1474.0
15	79.3	16	2	1944.0	1891.0	-
16	85.2	16	3	1473.0	1321.0	1213.0
17	57.9	16	1	1757.0	-	-

Long Pulse Radar Test Signal						
Test Signal Name: LP_Signal_08						
Number of Bursts in Trial: 14						
Chirp Center Frequency: 5510MHz						
Burst	Pulse Width (us)	Chirp Width (MHz)	Number of Pulses per Burst	PRI-1 (us)	PRI-2 (us)	PRI-3 (us)
1	75.2	13	2	1261.0	1304.0	-

2	77.1	13	2	1027.0	1508.0	-
3	53.8	13	1	1902.0	-	-
4	75.7	13	2	1695.0	1486.0	-
5	64.7	13	1	1578.0	-	-
6	74.0	13	2	1297.0	1665.0	-
7	75.9	13	2	1668.0	1099.0	-
8	88.6	13	3	1090.0	1936.0	1660.0
9	87.0	13	3	1380.0	1565.0	1497.0
10	78.4	13	2	1379.0	1840.0	-
11	93.2	13	3	1850.0	1932.0	1054.0
12	82.0	13	2	1428.0	1543.0	-
13	98.5	13	3	1029.0	1055.0	1690.0
14	54.6	13	1	1266.0	-	-

Long Pulse Radar Test Signal

Test Signal Name: LP\_Signal\_09

Number of Bursts in Trial: 19

Chirp Center Frequency: 5510MHz

Burst	Pulse Width (us)	Chirp Width (MHz)	Number of Pulses per Burst	PRI-1 (us)	PRI-2 (us)	PRI-3 (us)
1	65.5	19	1	1799.0	-	-
2	77.7	19	2	1728.0	1378.0	-
3	60.7	19	1	1787.0	-	-
4	94.4	19	3	1908.0	1028.0	1324.0
5	92.7	19	3	1737.0	1540.0	1586.0
6	86.8	19	3	1368.0	1194.0	1593.0
7	54.0	19	1	1445.0	-	-
8	52.4	19	1	1101.0	-	-
9	70.5	19	2	1766.0	1927.0	-
10	54.5	19	1	1442.0	-	-
11	54.5	19	1	1913.0	-	-
12	76.9	19	2	1223.0	1894.0	-
13	51.7	19	1	1225.0	-	-
14	85.3	19	3	1403.0	1375.0	1925.0
15	66.3	19	1	1061.0	-	-
16	70.5	19	2	1881.0	1923.0	-
17	94.3	19	3	1510.0	1114.0	1654.0
18	57.6	19	1	1780.0	-	-
19	77.5	19	2	1602.0	1394.0	-

Long Pulse Radar Test Signal						
Test Signal Name: LP_Signal_10						
Number of Bursts in Trial: 8						
Chirp Center Frequency: 5510MHz						
Burst	Pulses per Burst	Chirp (Hz)	Pulse Width (s)	Pulse 1 to 2 Spacing (s)	Pulse 2 to 3 Spacing (s)	Start Location (s)
1	Pulse Width (us)	Chirp Width (MHz)	Number of Pulses per Burst	PRI-1 (us)	PRI-2 (us)	PRI-3 (us)
2	70.6	5	2	1604.0	1926.0	-
3	57.2	5	1	1195.0	-	-
4	62.0	5	1	1181.0	-	-
5	77.5	5	2	1349.0	1658.0	-
6	92.5	5	3	1599.0	1544.0	1016.0
7	60.1	5	1	1077.0	-	-
8	61.3	5	1	1139.0	-	-

Long Pulse Radar Test Signal						
Test Signal Name: LP_Signal_11						
Number of Bursts in Trial: 19						
Chirp Center Frequency: 5499MHz						
Burst	Pulse Width (us)	Chirp Width (MHz)	Number of Pulses per Burst	PRI-1 (us)	PRI-2 (us)	PRI-3 (us)
1	62.8	19	1	1655.0	-	-
2	77.9	19	2	1014.0	1929.0	-
3	65.0	19	1	1860.0	-	-
4	93.3	19	3	1954.0	1542.0	1096.0
5	66.9	19	2	1667.0	1754.0	-
6	60.2	19	1	1625.0	-	-
7	58.8	19	1	1323.0	-	-
8	67.9	19	2	1518.0	1134.0	-
9	82.1	19	2	1281.0	1343.0	-
10	65.7	19	1	1615.0	-	-
11	50.9	19	1	1026.0	-	-
12	86.6	19	3	1966.0	1590.0	1158.0
13	98.5	19	3	1686.0	1977.0	1402.0
14	53.8	19	1	1011.0	-	-

15	72.8	19	2	1846.0	1714.0	-
16	56.6	19	1	1202.0	-	-
17	99.4	19	3	1429.0	1521.0	1455.0
18	71.2	19	2	1362.0	1060.0	-
19	87.9	19	3	1934.0	1172.0	1561.0

Long Pulse Radar Test Signal						
Test Signal Name: LP_Signal_12						
Number of Bursts in Trial: 13						
Chrip Center Frequency: 5495.8MHz						
Burst	Pulse Width (us)	Chirp Width (MHz)	Number of Pulses per Burst	PRI-1 (us)	PRI-2 (us)	PRI-3 (us)
1	72.2	11	2	1258.0	1361.0	-
2	90.7	11	3	1265.0	1573.0	1230.0
3	72.3	11	2	1050.0	1796.0	-
4	66.5	11	1	1507.0	-	-
5	84.1	11	3	1427.0	1393.0	1338.0
6	85.5	11	3	1449.0	1910.0	1374.0
7	54.5	11	1	1342.0	-	-
8	77.9	11	2	1118.0	1013.0	-
9	97.4	11	3	1781.0	1253.0	1707.0
10	53.4	11	1	1032.0	-	-
11	50.2	11	1	1671.0	-	-
12	68.3	11	2	1465.0	1125.0	-
13	84.3	11	3	1972.0	1652.0	1206.0

Long Pulse Radar Test Signal						
Test Signal Name: LP_Signal_13						
Number of Bursts in Trial: 12						
Chrip Center Frequency: 5495.4MHz						
Burst	Pulse Width (us)	Chirp Width (MHz)	Number of Pulses per Burst	PRI-1 (us)	PRI-2 (us)	PRI-3 (us)
1	81.4	10	2	1431.0	1141.0	-
2	56.0	10	1	1727.0	-	-
3	91.2	10	3	1533.0	1264.0	1132.0
4	74.6	10	2	1669.0	1477.0	-
5	55.5	10	1	1738.0	-	-
6	61.2	10	1	1774.0	-	-



7	87.7	10	3	1574.0	1140.0	1464.0
8	66.6	10	1	1587.0	-	-
9	93.0	10	3	1320.0	1663.0	1525.0
10	67.3	10	2	1018.0	1302.0	-
11	84.2	10	3	1513.0	1215.0	1688.0
12	54.8	10	1	1243.0	-	-

<b>Long Pulse Radar Test Signal</b>						
Test Signal Name: LP_Signal_14						
Number of Bursts in Trial: 14						
Chirp Center Frequency: 5496.6MHz						
Burst	Pulse Width (us)	Chirp Width (MHz)	Number of Pulses per Burst	PRI-1 (us)	PRI-2 (us)	PRI-3 (us)
1	93.4	13	3	1023.0	1052.0	1143.0
2	71.0	13	2	1152.0	1770.0	-
3	79.0	13	2	1862.0	1552.0	-
4	66.7	13	2	1483.0	1296.0	-
5	84.5	13	3	1185.0	1144.0	1832.0
6	55.3	13	1	1969.0	-	-
7	78.1	13	2	1318.0	1722.0	-
8	71.3	13	2	1653.0	1201.0	-
9	72.3	13	2	1222.0	1232.0	-
10	89.1	13	3	1874.0	1748.0	1491.0
11	90.1	13	3	1522.0	1582.0	1990.0
12	90.5	13	3	1176.0	1344.0	1971.0
13	61.3	13	1	1199.0	-	-
14	80.9	13	2	1111.0	1295.0	-

<b>Long Pulse Radar Test Signal</b>						
Test Signal Name: LP_Signal_15						
Number of Bursts in Trial: 9						
Chirp Center Frequency: 5494.2MHz						
Burst	Pulse Width (us)	Chirp Width (MHz)	Number of Pulses per Burst	PRI-1 (us)	PRI-2 (us)	PRI-3 (us)
1	57.8	7	1	1724.0	-	-
2	62.3	7	1	1498.0	-	-
3	82.4	7	2	1151.0	1396.0	-
4	61.5	7	1	1501.0	-	-

5	64.5	7	1	1623.0	-	-
6	81.9	7	2	1079.0	1951.0	-
7	97.4	7	3	1216.0	1204.0	1618.0
8	66.6	7	1	1630.0	-	-
9	55.2	7	1	1502.0	-	-

Long Pulse Radar Test Signal						
Test Signal Name: LP_Signal_16						
Number of Bursts in Trial: 20						
Chrip Center Frequency: 5499.4MHz						
Burst	Pulse Width (us)	Chirp Width (MHz)	Number of Pulses per Burst	PRI-1 (us)	PRI-2 (us)	PRI-3 (us)
1	92.5	20	3	1098.0	1694.0	1425.0
2	62.7	20	1	1844.0	-	-
3	98.2	20	3	1976.0	1482.0	1887.0
4	51.1	20	1	1479.0	-	-
5	88.1	20	3	1838.0	1191.0	1421.0
6	83.5	20	3	1366.0	1037.0	1981.0
7	71.3	20	2	1676.0	1699.0	-
8	79.3	20	2	1856.0	1174.0	-
9	73.3	20	2	1326.0	1529.0	-
10	88.1	20	3	1070.0	1841.0	1710.0
11	61.6	20	1	1327.0	-	-
12	90.8	20	3	1086.0	1584.0	1236.0
13	64.4	20	1	1045.0	-	-
14	75.5	20	2	1311.0	1273.0	-
15	61.2	20	1	1180.0	-	-
16	62.8	20	1	1136.0	-	-
17	98.1	20	3	1242.0	1058.0	1248.0
18	72.1	20	2	1941.0	1041.0	-
19	97.1	20	3	1031.0	1221.0	1309.0
20	62.0	20	1	1797.0	-	-

Long Pulse Radar Test Signal						
Test Signal Name: LP_Signal_17						
Number of Bursts in Trial: 13						
Chrip Center Frequency: 5495.8MHz						
Burst	Pulse Width	Chirp Width	Number of Pulses per	PRI-1 (us)	PRI-2 (us)	PRI-3 (us)

	(us)	(MHz)	Burst			
1	92.3	11	3	1768.0	1605.0	1619.0
2	66.0	11	1	1468.0	-	-
3	50.6	11	1	1549.0	-	-
4	63.2	11	1	1035.0	-	-
5	74.6	11	2	1312.0	1745.0	-
6	53.4	11	1	1598.0	-	-
7	75.3	11	2	1837.0	1443.0	-
8	84.2	11	3	1110.0	1034.0	1948.0
9	81.5	11	2	1898.0	1298.0	-
10	52.8	11	1	1553.0	-	-
11	52.3	11	1	1675.0	-	-
12	57.4	11	1	1702.0	-	-
13	76.7	11	2	1961.0	1670.0	-

Long Pulse Radar Test Signal						
Test Signal Name: LP_Signal_18						
Number of Bursts in Trial: 12						
Chrip Center Frequency: 5495.4MHz						
Burst	Pulse Width (us)	Chrip Width (MHz)	Number of Pulses per Burst	PRI-1 (us)	PRI-2 (us)	PRI-3 (us)
1	65.8	10	1	2000.0	-	-
2	86.6	10	3	1666.0	1190.0	1043.0
3	54.0	10	1	1922.0	-	-
4	86.4	10	3	1703.0	1962.0	1639.0
5	54.2	10	1	1119.0	-	-
6	90.0	10	3	1257.0	1911.0	1571.0
7	87.8	10	3	1120.0	1509.0	1708.0
8	50.9	10	1	1572.0	-	-
9	59.7	10	1	1155.0	-	-
10	66.7	10	2	1818.0	1725.0	-
11	52.4	10	1	1082.0	-	-
12	99.8	10	3	1775.0	1778.0	1068.0

Long Pulse Radar Test Signal						
Test Signal Name: LP_Signal_19						
Number of Bursts in Trial: 9						
Chrip Center Frequency: 5494.2MHz						
Burst	Pulse	Chrip	Number of	PRI-1 (us)	PRI-2 (us)	PRI-3 (us)

	Width (us)	Width (MHz)	Pulses per Burst			
1	90.2	7	3	1723.0	1106.0	1103.0
2	93.4	7	3	1715.0	1810.0	1370.0
3	86.8	7	3	1390.0	1340.0	1634.0
4	71.2	7	2	1108.0	1351.0	-
5	98.7	7	3	1949.0	1720.0	1363.0
6	66.4	7	1	1621.0	-	-
7	59.7	7	1	1993.0	-	-
8	50.3	7	1	1412.0	-	-
9	54.6	7	1	1441.0	-	-

Long Pulse Radar Test Signal						
Test Signal Name: LP_Signal_20						
Number of Bursts in Trial: 19						
Chrip Center Frequency: 5499MHz						
Burst	Pulse Width (us)	Chrip Width (MHz)	Number of Pulses per Burst	PRI-1 (us)	PRI-2 (us)	PRI-3 (us)
1	62.9	19	1	1466.0	-	-
2	76.5	19	2	1008.0	1600.0	-
3	62.0	19	1	1355.0	-	-
4	84.9	19	3	1893.0	1851.0	1166.0
5	76.5	19	2	1909.0	1987.0	-
6	84.7	19	3	1179.0	1256.0	1107.0
7	58.1	19	1	1123.0	-	-
8	87.1	19	3	1315.0	1763.0	1365.0
9	97.9	19	3	1051.0	1395.0	1519.0
10	70.5	19	2	1984.0	1692.0	-
11	85.7	19	3	1438.0	1040.0	1672.0
12	54.2	19	1	1247.0	-	-
13	64.0	19	1	1674.0	-	-
14	98.7	19	3	1566.0	1289.0	1752.0
15	89.0	19	3	1290.0	1405.0	1959.0
16	57.2	19	1	1164.0	-	-
17	76.5	19	2	1165.0	1135.0	-
18	93.9	19	3	1888.0	1731.0	1828.0
19	82.2	19	2	1175.0	1091.0	-

Long Pulse Radar Test Signal
------------------------------

Test Signal Name: LP_Signal_21						
Number of Bursts in Trial: 8						
Chirp Center Frequency: 5526.6MHz						
Burst	Pulse Width (us)	Chirp Width (MHz)	Number of Pulses per Burst	PRI-1 (us)	PRI-2 (us)	PRI-3 (us)
1	59.2	5	1	1307.0	-	-
2	61.0	5	1	1389.0	-	-
3	82.6	5	2	1047.0	1637.0	-
4	99.3	5	3	1408.0	1760.0	1901.0
5	98.3	5	3	1996.0	1039.0	1104.0
6	63.5	5	1	1596.0	-	-
7	84.5	5	3	1115.0	1930.0	1864.0
8	60.1	5	1	1328.0	-	-

Long Pulse Radar Test Signal						
Test Signal Name: LP_Signal_22						
Number of Bursts in Trial: 9						
Chirp Center Frequency: 5526.2MHz						
Burst	Pulse Width (us)	Chirp Width (MHz)	Number of Pulses per Burst	PRI-1 (us)	PRI-2 (us)	PRI-3 (us)
1	88.5	6	3	1648.0	1627.0	1496.0
2	63.0	6	1	1001.0	-	-
3	82.8	6	2	1868.0	1006.0	-
4	86.4	6	3	1657.0	1044.0	1709.0
5	92.7	6	3	1644.0	1916.0	1527.0
6	57.1	6	1	1420.0	-	-
7	72.0	6	2	1092.0	1192.0	-
8	52.8	6	1	1335.0	-	-
9	60.1	6	1	1137.0	-	-

Long Pulse Radar Test Signal						
Test Signal Name: LP_Signal_23						
Number of Bursts in Trial: 19						
Chirp Center Frequency: 5521MHz						
Burst	Pulse Width (us)	Chirp Width (MHz)	Number of Pulses per Burst	PRI-1 (us)	PRI-2 (us)	PRI-3 (us)
1	92.0	19	3	1858.0	1601.0	1189.0

2	51.4	19	1	1331.0	-	-
3	77.7	19	2	1517.0	1834.0	-
4	55.3	19	1	1397.0	-	-
5	79.6	19	2	1992.0	1205.0	-
6	63.9	19	1	1588.0	-	-
7	61.9	19	1	1439.0	-	-
8	96.2	19	3	1889.0	1193.0	1938.0
9	66.7	19	2	1853.0	1418.0	-
10	95.6	19	3	1761.0	1592.0	1263.0
11	76.1	19	2	1585.0	1950.0	-
12	94.8	19	3	1387.0	1336.0	1550.0
13	97.9	19	3	1807.0	1138.0	1661.0
14	64.0	19	1	1038.0	-	-
15	72.2	19	2	1790.0	1882.0	-
16	72.6	19	2	1736.0	1383.0	-
17	77.6	19	2	1244.0	1641.0	-
18	91.1	19	3	1299.0	1406.0	1056.0
19	93.7	19	3	1964.0	1718.0	1053.0

**Long Pulse Radar Test Signal**

Test Signal Name: LP\_Signal\_24

Number of Bursts in Trial: 18

Chirp Center Frequency: 5521.4MHz

Burst	Pulse Width (us)	Chirp Width (MHz)	Number of Pulses per Burst	PRI-1 (us)	PRI-2 (us)	PRI-3 (us)
1	80.4	18	2	1735.0	1046.0	-
2	77.2	18	2	1662.0	1359.0	-
3	63.7	18	1	1341.0	-	-
4	71.3	18	2	1346.0	1883.0	-
5	92.1	18	3	1069.0	1033.0	1417.0
6	74.5	18	2	1986.0	1730.0	-
7	69.7	18	2	1988.0	1547.0	-
8	74.0	18	2	1612.0	1285.0	-
9	65.0	18	1	1415.0	-	-
10	84.2	18	3	1556.0	1030.0	1664.0
11	93.1	18	3	1148.0	1160.0	1259.0
12	97.1	18	3	1062.0	1372.0	1392.0
13	92.0	18	3	1933.0	1970.0	1685.0
14	95.8	18	3	1967.0	1875.0	1112.0

15	78.9	18	2	1983.0	1903.0	-
16	65.2	18	1	1814.0	-	-
17	75.0	18	2	1146.0	1142.0	-
18	66.2	18	1	1577.0	-	-

Long Pulse Radar Test Signal						
Test Signal Name: LP_Signal_25						
Number of Bursts in Trial: 18						
Chirp Center Frequency: 5521.4MHz						
Burst	Pulse Width (us)	Chirp Width (MHz)	Number of Pulses per Burst	PRI-1 (us)	PRI-2 (us)	PRI-3 (us)
1	76.8	18	2	1284.0	1792.0	-
2	79.7	18	2	1364.0	1276.0	-
3	97.1	18	3	1861.0	1759.0	1260.0
4	70.7	18	2	1937.0	1744.0	-
5	53.1	18	1	1017.0	-	-
6	81.5	18	2	1184.0	1072.0	-
7	68.0	18	2	1360.0	1332.0	-
8	58.4	18	1	1306.0	-	-
9	65.4	18	1	1234.0	-	-
10	90.7	18	3	1207.0	1147.0	1603.0
11	99.1	18	3	1900.0	1746.0	1252.0
12	60.6	18	1	1684.0	-	-
13	63.8	18	1	1616.0	-	-
14	65.1	18	1	1382.0	-	-
15	66.0	18	1	1829.0	-	-
16	78.4	18	2	1512.0	1940.0	-
17	72.5	18	2	1430.0	1701.0	-
18	82.9	18	2	1010.0	1066.0	-

Long Pulse Radar Test Signal						
Test Signal Name: LP_Signal_26						
Number of Bursts in Trial: 14						
Chirp Center Frequency: 5523.4MHz						
Burst	Pulse Width (us)	Chirp Width (MHz)	Number of Pulses per Burst	PRI-1 (us)	PRI-2 (us)	PRI-3 (us)
1	78.2	13	2	1227.0	1352.0	-
2	80.1	13	2	1872.0	1680.0	-

3	85.6	13	3	1545.0	1105.0	1399.0
4	80.9	13	2	1633.0	1129.0	-
5	59.9	13	1	1145.0	-	-
6	90.0	13	3	1059.0	1978.0	1859.0
7	96.9	13	3	1407.0	1480.0	1747.0
8	62.0	13	1	1885.0	-	-
9	73.7	13	2	1852.0	1696.0	-
10	98.5	13	3	1063.0	1088.0	1168.0
11	84.1	13	3	1157.0	1198.0	1212.0
12	99.0	13	3	1245.0	1784.0	1422.0
13	69.0	13	2	1515.0	1991.0	-
14	98.8	13	3	1237.0	1554.0	1705.0

Long Pulse Radar Test Signal						
Test Signal Name: LP_Signal_27						
Number of Bursts in Trial: 15						
Chirp Center Frequency: 5523MHz						
Burst	Pulse Width (us)	Chirp Width (MHz)	Number of Pulses per Burst	PRI-1 (us)	PRI-2 (us)	PRI-3 (us)
1	97.3	14	3	1384.0	1434.0	1843.0
2	56.4	14	1	1170.0	-	-
3	50.7	14	1	1049.0	-	-
4	61.4	14	1	1777.0	-	-
5	96.6	14	3	1626.0	1821.0	1643.0
6	59.7	14	1	1280.0	-	-
7	74.1	14	2	1918.0	1845.0	-
8	82.3	14	2	1435.0	1640.0	-
9	53.3	14	1	1127.0	-	-
10	83.6	14	3	1235.0	1489.0	1721.0
11	59.1	14	1	1884.0	-	-
12	79.0	14	2	1451.0	1613.0	-
13	75.0	14	2	1239.0	1989.0	-
14	54.3	14	1	1481.0	-	-
15	70.3	14	2	1783.0	1334.0	-

Long Pulse Radar Test Signal						
Test Signal Name: LP_Signal_28						
Number of Bursts in Trial: 14						
Chirp Center Frequency: 5523.4MHz						



Burst	Pulse Width (us)	Chirp Width (MHz)	Number of Pulses per Burst	PRI-1 (us)	PRI-2 (us)	PRI-3 (us)
1	78.0	13	2	1786.0	1231.0	-
2	81.1	13	2	1377.0	1019.0	-
3	63.6	13	1	1083.0	-	-
4	73.2	13	2	1048.0	1878.0	-
5	96.0	13	3	1555.0	1704.0	1130.0
6	87.0	13	3	1492.0	1523.0	1526.0
7	94.9	13	3	1487.0	1218.0	1865.0
8	80.6	13	2	1278.0	1570.0	-
9	96.0	13	3	1183.0	1531.0	1956.0
10	69.8	13	2	1467.0	1081.0	-
11	57.1	13	1	1354.0	-	-
12	73.8	13	2	1646.0	1196.0	-
13	91.2	13	3	1711.0	1410.0	1078.0
14	57.8	13	1	1742.0	-	-

Long Pulse Radar Test Signal						
Test Signal Name: LP_Signal_29						
Number of Bursts in Trial: 20						
Chirp Center Frequency: 5520.6MHz						
Burst	Pulse Width (us)	Chirp Width (MHz)	Number of Pulses per Burst	PRI-1 (us)	PRI-2 (us)	PRI-3 (us)
1	69.6	20	2	1161.0	1162.0	-
2	74.4	20	2	1607.0	1272.0	-
3	66.4	20	1	1866.0	-	-
4	71.7	20	2	1089.0	1470.0	-
5	50.2	20	1	1503.0	-	-
6	63.4	20	1	1762.0	-	-
7	57.4	20	1	1595.0	-	-
8	64.3	20	1	1003.0	-	-
9	54.6	20	1	1476.0	-	-
10	81.9	20	2	1154.0	1488.0	-
11	62.8	20	1	1942.0	-	-
12	58.8	20	1	1825.0	-	-
13	96.0	20	3	1173.0	1116.0	1095.0
14	76.8	20	2	1024.0	1210.0	-
15	51.9	20	1	1463.0	-	-

16	71.7	20	2	1286.0	1121.0	-
17	80.9	20	2	1756.0	1398.0	-
18	64.9	20	1	1805.0	-	-
19	92.5	20	3	1801.0	1367.0	1594.0
20	91.7	20	3	1559.0	1620.0	1122.0

Long Pulse Radar Test Signal						
Test Signal Name: LP_Signal_30						
Number of Bursts in Trial: 14						
Chrip Center Frequency: 5523.4MHz						
Burst	Pulse Width (us)	Chirp Width (MHz)	Number of Pulses per Burst	PRI-1 (us)	PRI-2 (us)	PRI-3 (us)
1	95.8	13	3	1915.0	1214.0	1551.0
2	67.3	13	2	1979.0	1128.0	-
3	70.5	13	2	1920.0	1339.0	-
4	75.7	13	2	1000.0	1734.0	-
5	73.0	13	2	1149.0	1591.0	-
6	61.8	13	1	1681.0	-	-
7	52.4	13	1	1567.0	-	-
8	75.8	13	2	2000.0	1886.0	-
9	54.8	13	1	1117.0	-	-
10	91.6	13	3	1233.0	1004.0	1413.0
11	89.5	13	3	1416.0	1329.0	1007.0
12	86.0	13	3	1614.0	1557.0	1822.0
13	83.0	13	2	1863.0	1282.0	-
14	74.4	13	2	1269.0	1617.0	-

Type 6 Radar Statistical Performances				
Trial #	Pulses per Burst	Pulse Width ( $\mu$ sec)	PRI ( $\mu$ sec)	Detection
1	9	1	333.3	Yes
2	9	1	333.3	Yes
3	9	1	333.3	Yes
4	9	1	333.3	Yes
5	9	1	333.3	Yes
6	9	1	333.3	Yes
7	9	1	333.3	Yes
8	9	1	333.3	Yes
9	9	1	333.3	Yes
10	9	1	333.3	Yes
11	9	1	333.3	Yes
12	9	1	333.3	Yes
13	9	1	333.3	Yes
14	9	1	333.3	Yes
15	9	1	333.3	Yes
16	9	1	333.3	Yes
17	9	1	333.3	Yes
18	9	1	333.3	Yes
19	9	1	333.3	Yes
20	9	1	333.3	Yes
21	9	1	333.3	Yes
22	9	1	333.3	Yes
23	9	1	333.3	Yes
24	9	1	333.3	Yes
25	9	1	333.3	Yes
26	9	1	333.3	Yes
27	9	1	333.3	Yes
28	9	1	333.3	Yes
29	9	1	333.3	Yes
30	9	1	333.3	Yes
				Detection Rate: 100.0 %

Type 6 Radar Statistical Performances		
Trial #	Hopping Frequency Sequence Name	Detection
1	HOP_FREQ_SEQ_01	Yes
2	HOP_FREQ_SEQ_02	Yes
3	HOP_FREQ_SEQ_03	Yes
4	HOP_FREQ_SEQ_04	Yes
5	HOP_FREQ_SEQ_05	Yes
6	HOP_FREQ_SEQ_06	Yes
7	HOP_FREQ_SEQ_07	Yes
8	HOP_FREQ_SEQ_08	Yes
9	HOP_FREQ_SEQ_09	Yes
10	HOP_FREQ_SEQ_10	Yes
11	HOP_FREQ_SEQ_11	Yes
12	HOP_FREQ_SEQ_12	Yes
13	HOP_FREQ_SEQ_13	Yes
14	HOP_FREQ_SEQ_14	Yes
15	HOP_FREQ_SEQ_15	Yes
16	HOP_FREQ_SEQ_16	Yes
17	HOP_FREQ_SEQ_17	Yes
18	HOP_FREQ_SEQ_18	Yes
19	HOP_FREQ_SEQ_19	Yes
20	HOP_FREQ_SEQ_20	Yes
21	HOP_FREQ_SEQ_21	Yes
22	HOP_FREQ_SEQ_22	Yes
23	HOP_FREQ_SEQ_23	Yes
24	HOP_FREQ_SEQ_24	Yes
25	HOP_FREQ_SEQ_25	Yes
26	HOP_FREQ_SEQ_26	Yes
27	HOP_FREQ_SEQ_27	Yes
28	HOP_FREQ_SEQ_28	Yes
29	HOP_FREQ_SEQ_29	Yes
30	HOP_FREQ_SEQ_30	Yes
		Detection Rate: 100.0 %

Hopping Frequency Sequence Name: HOP_FREQ_SEQ_01							
SEQ#	Frequency (Hz)	SEQ#	Frequency (Hz)	SEQ#	Frequency (Hz)	SEQ#	Frequency (Hz)
1	5.603G	2	5.405G	3	5.498G	4	5.670G
5	5.630G	6	5.712G	7	5.653G	8	5.285G
9	5.399G	10	5.541G	11	5.704G	12	5.323G
13	5.532G	14	5.366G	15	5.410G	16	5.581G
17	5.612G	18	5.467G	19	5.312G	20	5.554G
21	5.520G	22	5.551G	23	5.575G	24	5.448G
25	5.414G	26	5.598G	27	5.354G	28	5.708G
29	5.332G	30	5.288G	31	5.310G	32	5.456G
33	5.397G	34	5.361G	35	5.390G	36	5.380G
37	5.620G	38	5.652G	39	5.666G	40	5.457G
41	5.296G	42	5.631G	43	5.411G	44	5.470G
45	5.526G	46	5.472G	47	5.628G	48	5.375G
49	5.649G	50	5.656G	51	5.408G	52	5.393G
53	5.514G	54	5.348G	55	5.523G	56	5.709G
57	5.311G	58	5.284G	59	5.552G	60	5.427G
61	5.255G	62	5.395G	63	5.536G	64	5.626G
65	5.389G	66	5.297G	67	5.679G	68	5.545G
69	5.496G	70	5.617G	71	5.283G	72	5.508G
73	5.299G	74	5.319G	75	5.624G	76	5.440G
77	5.677G	78	5.643G	79	5.558G	80	5.252G
81	5.671G	82	5.378G	83	5.680G	84	5.547G
85	5.683G	86	5.453G	87	5.466G	88	5.471G
89	5.548G	90	5.356G	91	5.486G	92	5.684G
93	5.669G	94	5.349G	95	5.504G	96	5.641G
97	5.495G	98	5.578G	99	5.702G	100	5.706G

Hopping Frequency Sequence Name: HOP_FREQ_SEQ_02							
SEQ#	Frequency (Hz)	SEQ#	Frequency (Hz)	SEQ#	Frequency (Hz)	SEQ#	Frequency (Hz)
1	5.328G	2	5.655G	3	5.570G	4	5.291G
5	5.485G	6	5.342G	7	5.365G	8	5.720G
9	5.647G	10	5.264G	11	5.362G	12	5.403G
13	5.392G	14	5.284G	15	5.363G	16	5.461G
17	5.346G	18	5.381G	19	5.598G	20	5.528G
21	5.640G	22	5.315G	23	5.500G	24	5.539G
25	5.531G	26	5.459G	27	5.603G	28	5.372G
29	5.499G	30	5.263G	31	5.329G	32	5.366G
33	5.431G	34	5.586G	35	5.536G	36	5.266G
37	5.376G	38	5.654G	39	5.701G	40	5.285G
41	5.699G	42	5.327G	43	5.450G	44	5.567G
45	5.680G	46	5.581G	47	5.270G	48	5.633G
49	5.676G	50	5.353G	51	5.456G	52	5.454G
53	5.446G	54	5.532G	55	5.665G	56	5.443G
57	5.432G	58	5.371G	59	5.269G	60	5.559G
61	5.386G	62	5.535G	63	5.308G	64	5.451G
65	5.276G	66	5.718G	67	5.719G	68	5.287G
69	5.636G	70	5.292G	71	5.490G	72	5.700G
73	5.303G	74	5.569G	75	5.489G	76	5.364G
77	5.564G	78	5.335G	79	5.340G	80	5.326G
81	5.677G	82	5.375G	83	5.664G	84	5.427G
85	5.538G	86	5.509G	87	5.420G	88	5.344G
89	5.462G	90	5.682G	91	5.565G	92	5.691G
93	5.355G	94	5.687G	95	5.652G	96	5.352G
97	5.416G	98	5.286G	99	5.684G	100	5.425G

Hopping Frequency Sequence Name: HOP_FREQ_SEQ_03							
SEQ#	Frequency (Hz)	SEQ#	Frequency (Hz)	SEQ#	Frequency (Hz)	SEQ#	Frequency (Hz)
1	5.715G	2	5.431G	3	5.262G	4	5.608G
5	5.436G	6	5.354G	7	5.555G	8	5.545G
9	5.322G	10	5.379G	11	5.513G	12	5.254G
13	5.468G	14	5.449G	15	5.470G	16	5.616G
17	5.287G	18	5.393G	19	5.560G	20	5.256G
21	5.689G	22	5.647G	23	5.707G	24	5.413G
25	5.364G	26	5.445G	27	5.485G	28	5.615G
29	5.566G	30	5.610G	31	5.359G	32	5.723G
33	5.629G	34	5.312G	35	5.296G	36	5.341G
37	5.400G	38	5.611G	39	5.475G	40	5.463G
41	5.625G	42	5.412G	43	5.573G	44	5.434G
45	5.457G	46	5.540G	47	5.264G	48	5.496G
49	5.706G	50	5.724G	51	5.597G	52	5.299G
53	5.324G	54	5.539G	55	5.455G	56	5.547G
57	5.542G	58	5.631G	59	5.367G	60	5.363G
61	5.601G	62	5.714G	63	5.590G	64	5.365G
65	5.578G	66	5.453G	67	5.416G	68	5.471G
69	5.698G	70	5.323G	71	5.605G	72	5.635G
73	5.537G	74	5.352G	75	5.339G	76	5.378G
77	5.317G	78	5.257G	79	5.717G	80	5.637G
81	5.654G	82	5.361G	83	5.511G	84	5.510G
85	5.380G	86	5.594G	87	5.699G	88	5.600G
89	5.648G	90	5.683G	91	5.671G	92	5.283G
93	5.684G	94	5.508G	95	5.337G	96	5.342G
97	5.617G	98	5.278G	99	5.398G	100	5.497G

Hopping Frequency Sequence Name: HOP_FREQ_SEQ_04							
SEQ#	Frequency (Hz)	SEQ#	Frequency (Hz)	SEQ#	Frequency (Hz)	SEQ#	Frequency (Hz)
1	5.267G	2	5.612G	3	5.554G	4	5.569G
5	5.698G	6	5.718G	7	5.288G	8	5.716G
9	5.621G	10	5.723G	11	5.322G	12	5.511G
13	5.570G	14	5.683G	15	5.721G	16	5.530G
17	5.508G	18	5.451G	19	5.416G	20	5.521G
21	5.501G	22	5.460G	23	5.527G	24	5.699G
25	5.363G	26	5.470G	27	5.304G	28	5.623G
29	5.453G	30	5.426G	31	5.441G	32	5.579G
33	5.398G	34	5.669G	35	5.333G	36	5.468G
37	5.557G	38	5.517G	39	5.665G	40	5.610G
41	5.448G	42	5.629G	43	5.380G	44	5.262G
45	5.597G	46	5.285G	47	5.318G	48	5.266G
49	5.270G	50	5.381G	51	5.315G	52	5.401G
53	5.463G	54	5.298G	55	5.607G	56	5.700G
57	5.711G	58	5.417G	59	5.717G	60	5.360G
61	5.429G	62	5.654G	63	5.524G	64	5.496G
65	5.445G	66	5.499G	67	5.280G	68	5.386G
69	5.351G	70	5.687G	71	5.584G	72	5.356G
73	5.661G	74	5.589G	75	5.663G	76	5.657G
77	5.478G	78	5.659G	79	5.389G	80	5.513G
81	5.555G	82	5.458G	83	5.502G	84	5.420G
85	5.549G	86	5.690G	87	5.641G	88	5.648G
89	5.452G	90	5.473G	91	5.542G	92	5.588G
93	5.632G	94	5.439G	95	5.250G	96	5.348G
97	5.466G	98	5.541G	99	5.481G	100	5.562G



Hopping Frequency Sequence Name: HOP_FREQ_SEQ_05							
SEQ#	Frequency (Hz)	SEQ#	Frequency (Hz)	SEQ#	Frequency (Hz)	SEQ#	Frequency (Hz)
1	5.538G	2	5.423G	3	5.481G	4	5.307G
5	5.357G	6	5.593G	7	5.615G	8	5.404G
9	5.711G	10	5.490G	11	5.550G	12	5.416G
13	5.519G	14	5.541G	15	5.339G	16	5.612G
17	5.699G	18	5.653G	19	5.350G	20	5.369G
21	5.373G	22	5.656G	23	5.672G	24	5.688G
25	5.403G	26	5.522G	27	5.665G	28	5.675G
29	5.297G	30	5.402G	31	5.588G	32	5.673G
33	5.421G	34	5.512G	35	5.537G	36	5.715G
37	5.299G	38	5.686G	39	5.263G	40	5.679G
41	5.391G	42	5.313G	43	5.480G	44	5.561G
45	5.523G	46	5.389G	47	5.692G	48	5.569G
49	5.556G	50	5.578G	51	5.425G	52	5.517G
53	5.475G	54	5.532G	55	5.255G	56	5.375G
57	5.349G	58	5.436G	59	5.424G	60	5.271G
61	5.390G	62	5.585G	63	5.652G	64	5.486G
65	5.722G	66	5.280G	67	5.554G	68	5.514G
69	5.587G	70	5.683G	71	5.321G	72	5.547G
73	5.590G	74	5.432G	75	5.548G	76	5.657G
77	5.279G	78	5.693G	79	5.671G	80	5.539G
81	5.438G	82	5.301G	83	5.544G	84	5.670G
85	5.346G	86	5.463G	87	5.394G	88	5.567G
89	5.526G	90	5.434G	91	5.467G	92	5.611G
93	5.295G	94	5.647G	95	5.602G	96	5.318G
97	5.714G	98	5.649G	99	5.695G	100	5.630G

Hopping Frequency Sequence Name: HOP_FREQ_SEQ_06							
SEQ#	Frequency (Hz)	SEQ#	Frequency (Hz)	SEQ#	Frequency (Hz)	SEQ#	Frequency (Hz)
1	5.527G	2	5.604G	3	5.380G	4	5.393G
5	5.280G	6	5.665G	7	5.273G	8	5.473G
9	5.566G	10	5.647G	11	5.694G	12	5.645G
13	5.528G	14	5.359G	15	5.369G	16	5.564G
17	5.497G	18	5.669G	19	5.508G	20	5.459G
21	5.342G	22	5.563G	23	5.531G	24	5.605G
25	5.322G	26	5.436G	27	5.394G	28	5.611G
29	5.295G	30	5.441G	31	5.622G	32	5.469G
33	5.652G	34	5.638G	35	5.308G	36	5.375G
37	5.374G	38	5.309G	39	5.439G	40	5.626G
41	5.688G	42	5.345G	43	5.514G	44	5.646G
45	5.602G	46	5.666G	47	5.254G	48	5.271G
49	5.347G	50	5.470G	51	5.408G	52	5.700G
53	5.467G	54	5.480G	55	5.337G	56	5.673G
57	5.506G	58	5.417G	59	5.512G	60	5.348G
61	5.317G	62	5.621G	63	5.368G	64	5.557G
65	5.722G	66	5.266G	67	5.363G	68	5.678G
69	5.305G	70	5.485G	71	5.352G	72	5.668G
73	5.720G	74	5.509G	75	5.403G	76	5.460G
77	5.351G	78	5.556G	79	5.259G	80	5.629G
81	5.454G	82	5.723G	83	5.291G	84	5.356G
85	5.496G	86	5.681G	87	5.376G	88	5.689G
89	5.461G	90	5.711G	91	5.381G	92	5.279G
93	5.267G	94	5.533G	95	5.367G	96	5.361G
97	5.468G	98	5.389G	99	5.261G	100	5.357G

Hopping Frequency Sequence Name: HOP_FREQ_SEQ_07							
SEQ#	Frequency (Hz)	SEQ#	Frequency (Hz)	SEQ#	Frequency (Hz)	SEQ#	Frequency (Hz)
1	5.273G	2	5.275G	3	5.630G	4	5.277G
5	5.532G	6	5.396G	7	5.342G	8	5.379G
9	5.283G	10	5.475G	11	5.423G	12	5.571G
13	5.516G	14	5.382G	15	5.467G	16	5.429G
17	5.537G	18	5.386G	19	5.678G	20	5.544G
21	5.657G	22	5.527G	23	5.340G	24	5.470G
25	5.440G	26	5.332G	27	5.406G	28	5.373G
29	5.299G	30	5.385G	31	5.314G	32	5.255G
33	5.503G	34	5.507G	35	5.335G	36	5.476G
37	5.310G	38	5.383G	39	5.337G	40	5.518G
41	5.464G	42	5.674G	43	5.560G	44	5.322G
45	5.631G	46	5.446G	47	5.270G	48	5.708G
49	5.590G	50	5.365G	51	5.591G	52	5.706G
53	5.318G	54	5.402G	55	5.703G	56	5.662G
57	5.457G	58	5.414G	59	5.278G	60	5.308G
61	5.569G	62	5.407G	63	5.426G	64	5.376G
65	5.321G	66	5.384G	67	5.381G	68	5.542G
69	5.558G	70	5.472G	71	5.684G	72	5.553G
73	5.306G	74	5.401G	75	5.715G	76	5.458G
77	5.575G	78	5.654G	79	5.352G	80	5.671G
81	5.710G	82	5.479G	83	5.690G	84	5.297G
85	5.528G	86	5.276G	87	5.368G	88	5.585G
89	5.596G	90	5.353G	91	5.681G	92	5.442G
93	5.266G	94	5.268G	95	5.291G	96	5.615G
97	5.416G	98	5.699G	99	5.663G	100	5.293G

Hopping Frequency Sequence Name: HOP_FREQ_SEQ_08							
SEQ#	Frequency (Hz)	SEQ#	Frequency (Hz)	SEQ#	Frequency (Hz)	SEQ#	Frequency (Hz)
1	5.706G	2	5.662G	3	5.360G	4	5.585G
5	5.609G	6	5.471G	7	5.569G	8	5.485G
9	5.292G	10	5.673G	11	5.486G	12	5.626G
13	5.430G	14	5.563G	15	5.659G	16	5.287G
17	5.687G	18	5.719G	19	5.616G	20	5.668G
21	5.621G	22	5.591G	23	5.329G	24	5.558G
25	5.540G	26	5.623G	27	5.393G	28	5.712G
29	5.689G	30	5.370G	31	5.451G	32	5.545G
33	5.448G	34	5.394G	35	5.588G	36	5.633G
37	5.561G	38	5.418G	39	5.522G	40	5.707G
41	5.480G	42	5.414G	43	5.491G	44	5.312G
45	5.704G	46	5.317G	47	5.291G	48	5.319G
49	5.321G	50	5.681G	51	5.273G	52	5.473G
53	5.547G	54	5.457G	55	5.404G	56	5.456G
57	5.296G	58	5.299G	59	5.358G	60	5.684G
61	5.705G	62	5.581G	63	5.355G	64	5.592G
65	5.575G	66	5.436G	67	5.284G	68	5.381G
69	5.542G	70	5.388G	71	5.267G	72	5.254G
73	5.643G	74	5.257G	75	5.618G	76	5.332G
77	5.560G	78	5.647G	79	5.362G	80	5.677G
81	5.670G	82	5.651G	83	5.656G	84	5.425G
85	5.584G	86	5.612G	87	5.379G	88	5.368G
89	5.600G	90	5.489G	91	5.657G	92	5.357G
93	5.263G	94	5.277G	95	5.583G	96	5.555G
97	5.307G	98	5.658G	99	5.286G	100	5.487G

Hopping Frequency Sequence Name: HOP_FREQ_SEQ_09							
SEQ#	Frequency (Hz)	SEQ#	Frequency (Hz)	SEQ#	Frequency (Hz)	SEQ#	Frequency (Hz)
1	5.358G	2	5.423G	3	5.255G	4	5.380G
5	5.477G	6	5.387G	7	5.724G	8	5.629G
9	5.466G	10	5.254G	11	5.611G	12	5.379G
13	5.395G	14	5.702G	15	5.508G	16	5.543G
17	5.261G	18	5.360G	19	5.696G	20	5.411G
21	5.394G	22	5.460G	23	5.592G	24	5.528G
25	5.692G	26	5.449G	27	5.281G	28	5.285G
29	5.279G	30	5.558G	31	5.348G	32	5.496G
33	5.418G	34	5.647G	35	5.661G	36	5.517G
37	5.607G	38	5.359G	39	5.636G	40	5.650G
41	5.559G	42	5.642G	43	5.713G	44	5.274G
45	5.322G	46	5.604G	47	5.667G	48	5.674G
49	5.564G	50	5.414G	51	5.627G	52	5.489G
53	5.431G	54	5.298G	55	5.439G	56	5.353G
57	5.339G	58	5.398G	59	5.457G	60	5.497G
61	5.511G	62	5.390G	63	5.710G	64	5.407G
65	5.334G	66	5.609G	67	5.665G	68	5.263G
69	5.706G	70	5.259G	71	5.484G	72	5.479G
73	5.381G	74	5.693G	75	5.341G	76	5.351G
77	5.614G	78	5.566G	79	5.422G	80	5.475G
81	5.467G	82	5.386G	83	5.492G	84	5.705G
85	5.504G	86	5.399G	87	5.286G	88	5.610G
89	5.267G	90	5.670G	91	5.646G	92	5.265G
93	5.486G	94	5.635G	95	5.615G	96	5.608G
97	5.633G	98	5.514G	99	5.723G	100	5.372G

Hopping Frequency Sequence Name: HOP_FREQ_SEQ_10							
SEQ#	Frequency (Hz)	SEQ#	Frequency (Hz)	SEQ#	Frequency (Hz)	SEQ#	Frequency (Hz)
1	5.597G	2	5.266G	3	5.337G	4	5.578G
5	5.512G	6	5.712G	7	5.553G	8	5.671G
9	5.628G	10	5.713G	11	5.392G	12	5.346G
13	5.681G	14	5.520G	15	5.356G	16	5.488G
17	5.257G	18	5.393G	19	5.458G	20	5.605G
21	5.297G	22	5.287G	23	5.637G	24	5.710G
25	5.505G	26	5.549G	27	5.455G	28	5.385G
29	5.344G	30	5.402G	31	5.534G	32	5.452G
33	5.404G	34	5.461G	35	5.363G	36	5.322G
37	5.309G	38	5.638G	39	5.299G	40	5.445G
41	5.368G	42	5.288G	43	5.624G	44	5.516G
45	5.298G	46	5.548G	47	5.694G	48	5.685G
49	5.716G	50	5.500G	51	5.618G	52	5.431G
53	5.286G	54	5.547G	55	5.328G	56	5.351G
57	5.595G	58	5.253G	59	5.723G	60	5.350G
61	5.613G	62	5.542G	63	5.325G	64	5.255G
65	5.433G	66	5.469G	67	5.539G	68	5.420G
69	5.487G	70	5.345G	71	5.634G	72	5.483G
73	5.606G	74	5.722G	75	5.399G	76	5.386G
77	5.342G	78	5.459G	79	5.689G	80	5.658G
81	5.599G	82	5.557G	83	5.478G	84	5.477G
85	5.603G	86	5.473G	87	5.410G	88	5.540G
89	5.446G	90	5.443G	91	5.623G	92	5.550G
93	5.616G	94	5.670G	95	5.376G	96	5.341G
97	5.412G	98	5.596G	99	5.693G	100	5.347G

Hopping Frequency Sequence Name: HOP_FREQ_SEQ_11							
SEQ#	Frequency (Hz)	SEQ#	Frequency (Hz)	SEQ#	Frequency (Hz)	SEQ#	Frequency (Hz)
1	5.481G	2	5.267G	3	5.677G	4	5.358G
5	5.424G	6	5.457G	7	5.486G	8	5.285G
9	5.455G	10	5.632G	11	5.637G	12	5.679G
13	5.534G	14	5.651G	15	5.341G	16	5.376G
17	5.580G	18	5.705G	19	5.505G	20	5.438G
21	5.610G	22	5.606G	23	5.682G	24	5.578G
25	5.627G	26	5.674G	27	5.410G	28	5.370G
29	5.631G	30	5.475G	31	5.514G	32	5.694G
33	5.405G	34	5.555G	35	5.659G	36	5.420G
37	5.533G	38	5.575G	39	5.508G	40	5.266G
41	5.471G	42	5.657G	43	5.392G	44	5.339G
45	5.562G	46	5.348G	47	5.497G	48	5.278G
49	5.628G	50	5.643G	51	5.292G	52	5.528G
53	5.595G	54	5.450G	55	5.461G	56	5.387G
57	5.665G	58	5.257G	59	5.454G	60	5.301G
61	5.540G	62	5.571G	63	5.391G	64	5.568G
65	5.343G	66	5.347G	67	5.565G	68	5.718G
69	5.646G	70	5.488G	71	5.608G	72	5.710G
73	5.569G	74	5.377G	75	5.408G	76	5.572G
77	5.626G	78	5.666G	79	5.412G	80	5.284G
81	5.473G	82	5.459G	83	5.402G	84	5.416G
85	5.480G	86	5.525G	87	5.413G	88	5.519G
89	5.375G	90	5.602G	91	5.640G	92	5.478G
93	5.418G	94	5.653G	95	5.681G	96	5.421G
97	5.638G	98	5.714G	99	5.536G	100	5.673G

Hopping Frequency Sequence Name: HOP_FREQ_SEQ_12							
SEQ#	Frequency (Hz)	SEQ#	Frequency (Hz)	SEQ#	Frequency (Hz)	SEQ#	Frequency (Hz)
1	5.585G	2	5.257G	3	5.621G	4	5.720G
5	5.611G	6	5.538G	7	5.556G	8	5.427G
9	5.657G	10	5.628G	11	5.508G	12	5.367G
13	5.291G	14	5.341G	15	5.300G	16	5.485G
17	5.630G	18	5.648G	19	5.697G	20	5.378G
21	5.386G	22	5.711G	23	5.584G	24	5.350G
25	5.365G	26	5.337G	27	5.501G	28	5.272G
29	5.463G	30	5.420G	31	5.668G	32	5.283G
33	5.323G	34	5.640G	35	5.629G	36	5.502G
37	5.612G	38	5.329G	39	5.469G	40	5.701G
41	5.588G	42	5.295G	43	5.418G	44	5.683G
45	5.315G	46	5.573G	47	5.517G	48	5.592G
49	5.387G	50	5.311G	51	5.595G	52	5.580G
53	5.445G	54	5.381G	55	5.318G	56	5.523G
57	5.271G	58	5.705G	59	5.712G	60	5.669G
61	5.715G	62	5.507G	63	5.623G	64	5.491G
65	5.515G	66	5.604G	67	5.267G	68	5.368G
69	5.625G	70	5.714G	71	5.581G	72	5.407G
73	5.665G	74	5.475G	75	5.616G	76	5.276G
77	5.474G	78	5.716G	79	5.423G	80	5.302G
81	5.410G	82	5.496G	83	5.471G	84	5.413G
85	5.339G	86	5.565G	87	5.266G	88	5.352G
89	5.521G	90	5.275G	91	5.652G	92	5.653G
93	5.601G	94	5.593G	95	5.681G	96	5.656G
97	5.476G	98	5.498G	99	5.348G	100	5.446G



Hopping Frequency Sequence Name: HOP_FREQ_SEQ_13							
SEQ#	Frequency (Hz)	SEQ#	Frequency (Hz)	SEQ#	Frequency (Hz)	SEQ#	Frequency (Hz)
1	5.303G	2	5.525G	3	5.524G	4	5.392G
5	5.396G	6	5.518G	7	5.534G	8	5.685G
9	5.573G	10	5.406G	11	5.468G	12	5.389G
13	5.492G	14	5.341G	15	5.585G	16	5.540G
17	5.323G	18	5.653G	19	5.652G	20	5.269G
21	5.460G	22	5.387G	23	5.443G	24	5.424G
25	5.643G	26	5.678G	27	5.312G	28	5.526G
29	5.675G	30	5.626G	31	5.515G	32	5.668G
33	5.495G	34	5.611G	35	5.633G	36	5.408G
37	5.344G	38	5.305G	39	5.493G	40	5.623G
41	5.717G	42	5.411G	43	5.569G	44	5.516G
45	5.478G	46	5.538G	47	5.673G	48	5.255G
49	5.566G	50	5.340G	51	5.512G	52	5.463G
53	5.561G	54	5.661G	55	5.624G	56	5.713G
57	5.256G	58	5.533G	59	5.322G	60	5.503G
61	5.487G	62	5.394G	63	5.638G	64	5.436G
65	5.311G	66	5.635G	67	5.298G	68	5.284G
69	5.375G	70	5.336G	71	5.694G	72	5.456G
73	5.295G	74	5.577G	75	5.605G	76	5.625G
77	5.417G	78	5.592G	79	5.437G	80	5.627G
81	5.629G	82	5.388G	83	5.414G	84	5.264G
85	5.572G	86	5.701G	87	5.360G	88	5.508G
89	5.689G	90	5.266G	91	5.707G	92	5.543G
93	5.671G	94	5.632G	95	5.596G	96	5.407G
97	5.510G	98	5.612G	99	5.337G	100	5.576G

Hopping Frequency Sequence Name: HOP_FREQ_SEQ_14							
SEQ#	Frequency (Hz)	SEQ#	Frequency (Hz)	SEQ#	Frequency (Hz)	SEQ#	Frequency (Hz)
1	5.320G	2	5.569G	3	5.430G	4	5.515G
5	5.378G	6	5.686G	7	5.418G	8	5.682G
9	5.367G	10	5.715G	11	5.444G	12	5.405G
13	5.695G	14	5.421G	15	5.574G	16	5.293G
17	5.266G	18	5.450G	19	5.462G	20	5.524G
21	5.499G	22	5.520G	23	5.455G	24	5.270G
25	5.345G	26	5.560G	27	5.466G	28	5.491G
29	5.498G	30	5.602G	31	5.274G	32	5.550G
33	5.393G	34	5.454G	35	5.268G	36	5.590G
37	5.608G	38	5.424G	39	5.600G	40	5.276G
41	5.305G	42	5.374G	43	5.588G	44	5.662G
45	5.541G	46	5.516G	47	5.463G	48	5.677G
49	5.555G	50	5.540G	51	5.649G	52	5.484G
53	5.639G	54	5.641G	55	5.655G	56	5.316G
57	5.678G	58	5.357G	59	5.547G	60	5.269G
61	5.397G	62	5.318G	63	5.302G	64	5.596G
65	5.411G	66	5.538G	67	5.568G	68	5.626G
69	5.694G	70	5.671G	71	5.323G	72	5.267G
73	5.693G	74	5.643G	75	5.443G	76	5.598G
77	5.502G	78	5.528G	79	5.341G	80	5.445G
81	5.691G	82	5.353G	83	5.368G	84	5.575G
85	5.344G	86	5.440G	87	5.489G	88	5.501G
89	5.292G	90	5.355G	91	5.534G	92	5.642G
93	5.423G	94	5.545G	95	5.470G	96	5.409G
97	5.425G	98	5.612G	99	5.651G	100	5.688G

Hopping Frequency Sequence Name: HOP_FREQ_SEQ_15							
SEQ#	Frequency (Hz)	SEQ#	Frequency (Hz)	SEQ#	Frequency (Hz)	SEQ#	Frequency (Hz)
1	5.679G	2	5.438G	3	5.375G	4	5.447G
5	5.698G	6	5.642G	7	5.366G	8	5.662G
9	5.653G	10	5.250G	11	5.299G	12	5.427G
13	5.303G	14	5.277G	15	5.283G	16	5.574G
17	5.720G	18	5.279G	19	5.455G	20	5.470G
21	5.638G	22	5.639G	23	5.323G	24	5.643G
25	5.619G	26	5.575G	27	5.633G	28	5.710G
29	5.411G	30	5.645G	31	5.712G	32	5.510G
33	5.604G	34	5.680G	35	5.284G	36	5.357G
37	5.397G	38	5.322G	39	5.294G	40	5.681G
41	5.555G	42	5.523G	43	5.591G	44	5.593G
45	5.392G	46	5.342G	47	5.401G	48	5.255G
49	5.363G	50	5.345G	51	5.348G	52	5.281G
53	5.449G	54	5.319G	55	5.671G	56	5.498G
57	5.558G	58	5.350G	59	5.464G	60	5.405G
61	5.717G	62	5.317G	63	5.669G	64	5.526G
65	5.530G	66	5.597G	67	5.329G	68	5.508G
69	5.270G	70	5.552G	71	5.634G	72	5.355G
73	5.646G	74	5.461G	75	5.516G	76	5.380G
77	5.263G	78	5.387G	79	5.306G	80	5.341G
81	5.605G	82	5.606G	83	5.687G	84	5.637G
85	5.362G	86	5.325G	87	5.305G	88	5.326G
89	5.688G	90	5.390G	91	5.477G	92	5.567G
93	5.320G	94	5.651G	95	5.499G	96	5.721G
97	5.296G	98	5.410G	99	5.673G	100	5.586G

Hopping Frequency Sequence Name: HOP_FREQ_SEQ_16							
SEQ#	Frequency (Hz)	SEQ#	Frequency (Hz)	SEQ#	Frequency (Hz)	SEQ#	Frequency (Hz)
1	5.426G	2	5.604G	3	5.396G	4	5.259G
5	5.410G	6	5.543G	7	5.666G	8	5.395G
9	5.569G	10	5.340G	11	5.348G	12	5.690G
13	5.679G	14	5.628G	15	5.515G	16	5.588G
17	5.436G	18	5.547G	19	5.555G	20	5.385G
21	5.456G	22	5.563G	23	5.499G	24	5.573G
25	5.526G	26	5.264G	27	5.521G	28	5.528G
29	5.334G	30	5.363G	31	5.470G	32	5.386G
33	5.275G	34	5.693G	35	5.493G	36	5.427G
37	5.665G	38	5.446G	39	5.681G	40	5.382G
41	5.336G	42	5.416G	43	5.447G	44	5.390G
45	5.278G	46	5.685G	47	5.263G	48	5.342G
49	5.345G	50	5.343G	51	5.497G	52	5.653G
53	5.417G	54	5.309G	55	5.509G	56	5.579G
57	5.441G	58	5.684G	59	5.397G	60	5.341G
61	5.372G	62	5.315G	63	5.554G	64	5.540G
65	5.546G	66	5.268G	67	5.299G	68	5.561G
69	5.317G	70	5.656G	71	5.318G	72	5.703G
73	5.516G	74	5.544G	75	5.454G	76	5.414G
77	5.273G	78	5.574G	79	5.535G	80	5.380G
81	5.457G	82	5.595G	83	5.548G	84	5.466G
85	5.672G	86	5.271G	87	5.486G	88	5.650G
89	5.490G	90	5.699G	91	5.381G	92	5.581G
93	5.276G	94	5.550G	95	5.487G	96	5.402G
97	5.257G	98	5.406G	99	5.323G	100	5.371G

Hopping Frequency Sequence Name: HOP_FREQ_SEQ_17							
SEQ#	Frequency (Hz)	SEQ#	Frequency (Hz)	SEQ#	Frequency (Hz)	SEQ#	Frequency (Hz)
1	5.421G	2	5.452G	3	5.547G	4	5.598G
5	5.335G	6	5.378G	7	5.572G	8	5.279G
9	5.419G	10	5.605G	11	5.553G	12	5.461G
13	5.406G	14	5.397G	15	5.293G	16	5.401G
17	5.435G	18	5.596G	19	5.683G	20	5.352G
21	5.480G	22	5.416G	23	5.575G	24	5.543G
25	5.708G	26	5.449G	27	5.652G	28	5.372G
29	5.661G	30	5.483G	31	5.588G	32	5.315G
33	5.251G	34	5.611G	35	5.667G	36	5.264G
37	5.283G	38	5.339G	39	5.592G	40	5.363G
41	5.629G	42	5.594G	43	5.518G	44	5.674G
45	5.573G	46	5.531G	47	5.323G	48	5.405G
49	5.353G	50	5.617G	51	5.468G	52	5.671G
53	5.695G	54	5.269G	55	5.515G	56	5.580G
57	5.649G	58	5.673G	59	5.299G	60	5.644G
61	5.509G	62	5.650G	63	5.500G	64	5.467G
65	5.344G	66	5.614G	67	5.538G	68	5.622G
69	5.645G	70	5.721G	71	5.368G	72	5.627G
73	5.260G	74	5.620G	75	5.601G	76	5.356G
77	5.413G	78	5.340G	79	5.451G	80	5.697G
81	5.643G	82	5.519G	83	5.444G	84	5.578G
85	5.624G	86	5.556G	87	5.551G	88	5.355G
89	5.677G	90	5.439G	91	5.548G	92	5.338G
93	5.277G	94	5.387G	95	5.252G	96	5.311G
97	5.651G	98	5.599G	99	5.574G	100	5.600G

Hopping Frequency Sequence Name: HOP_FREQ_SEQ_18							
SEQ#	Frequency (Hz)	SEQ#	Frequency (Hz)	SEQ#	Frequency (Hz)	SEQ#	Frequency (Hz)
1	5.487G	2	5.444G	3	5.562G	4	5.715G
5	5.662G	6	5.308G	7	5.379G	8	5.453G
9	5.368G	10	5.629G	11	5.514G	12	5.329G
13	5.538G	14	5.356G	15	5.588G	16	5.391G
17	5.413G	18	5.700G	19	5.381G	20	5.618G
21	5.455G	22	5.558G	23	5.352G	24	5.582G
25	5.283G	26	5.709G	27	5.542G	28	5.394G
29	5.663G	30	5.689G	31	5.288G	32	5.262G
33	5.370G	34	5.371G	35	5.577G	36	5.702G
37	5.299G	38	5.465G	39	5.325G	40	5.503G
41	5.312G	42	5.549G	43	5.451G	44	5.314G
45	5.319G	46	5.274G	47	5.682G	48	5.388G
49	5.546G	50	5.513G	51	5.474G	52	5.713G
53	5.260G	54	5.251G	55	5.722G	56	5.408G
57	5.625G	58	5.392G	59	5.418G	60	5.389G
61	5.492G	62	5.668G	63	5.697G	64	5.482G
65	5.300G	66	5.647G	67	5.599G	68	5.494G
69	5.571G	70	5.348G	71	5.460G	72	5.716G
73	5.551G	74	5.327G	75	5.366G	76	5.509G
77	5.600G	78	5.406G	79	5.622G	80	5.495G
81	5.712G	82	5.404G	83	5.421G	84	5.464G
85	5.393G	86	5.470G	87	5.676G	88	5.617G
89	5.594G	90	5.637G	91	5.425G	92	5.691G
93	5.278G	94	5.410G	95	5.486G	96	5.632G
97	5.653G	98	5.400G	99	5.572G	100	5.426G

Hopping Frequency Sequence Name: HOP_FREQ_SEQ_19							
SEQ#	Frequency (Hz)	SEQ#	Frequency (Hz)	SEQ#	Frequency (Hz)	SEQ#	Frequency (Hz)
1	5.329G	2	5.351G	3	5.639G	4	5.713G
5	5.256G	6	5.715G	7	5.672G	8	5.430G
9	5.291G	10	5.665G	11	5.459G	12	5.427G
13	5.693G	14	5.462G	15	5.571G	16	5.573G
17	5.474G	18	5.262G	19	5.596G	20	5.287G
21	5.327G	22	5.341G	23	5.326G	24	5.701G
25	5.457G	26	5.576G	27	5.681G	28	5.620G
29	5.325G	30	5.671G	31	5.543G	32	5.720G
33	5.521G	34	5.360G	35	5.485G	36	5.509G
37	5.408G	38	5.334G	39	5.555G	40	5.315G
41	5.417G	42	5.694G	43	5.623G	44	5.654G
45	5.253G	46	5.499G	47	5.544G	48	5.293G
49	5.708G	50	5.372G	51	5.366G	52	5.520G
53	5.302G	54	5.711G	55	5.590G	56	5.477G
57	5.349G	58	5.712G	59	5.305G	60	5.281G
61	5.383G	62	5.467G	63	5.397G	64	5.388G
65	5.527G	66	5.540G	67	5.651G	68	5.511G
69	5.386G	70	5.370G	71	5.580G	72	5.517G
73	5.684G	74	5.519G	75	5.435G	76	5.444G
77	5.535G	78	5.298G	79	5.699G	80	5.554G
81	5.514G	82	5.319G	83	5.473G	84	5.348G
85	5.705G	86	5.594G	87	5.323G	88	5.484G
89	5.506G	90	5.714G	91	5.411G	92	5.359G
93	5.421G	94	5.487G	95	5.258G	96	5.312G
97	5.491G	98	5.269G	99	5.320G	100	5.641G

Hopping Frequency Sequence Name: HOP_FREQ_SEQ_20							
SEQ#	Frequency (Hz)	SEQ#	Frequency (Hz)	SEQ#	Frequency (Hz)	SEQ#	Frequency (Hz)
1	5.288G	2	5.291G	3	5.457G	4	5.252G
5	5.596G	6	5.598G	7	5.306G	8	5.434G
9	5.633G	10	5.625G	11	5.374G	12	5.477G
13	5.684G	14	5.272G	15	5.664G	16	5.441G
17	5.399G	18	5.586G	19	5.261G	20	5.656G
21	5.621G	22	5.373G	23	5.280G	24	5.376G
25	5.349G	26	5.530G	27	5.632G	28	5.348G
29	5.333G	30	5.618G	31	5.391G	32	5.283G
33	5.265G	34	5.273G	35	5.594G	36	5.440G
37	5.548G	38	5.651G	39	5.724G	40	5.584G
41	5.676G	42	5.682G	43	5.506G	44	5.294G
45	5.679G	46	5.323G	47	5.649G	48	5.497G
49	5.361G	50	5.337G	51	5.286G	52	5.268G
53	5.524G	54	5.513G	55	5.257G	56	5.300G
57	5.697G	58	5.504G	59	5.492G	60	5.607G
61	5.525G	62	5.377G	63	5.432G	64	5.310G
65	5.320G	66	5.661G	67	5.250G	68	5.493G
69	5.593G	70	5.346G	71	5.456G	72	5.307G
73	5.368G	74	5.281G	75	5.636G	76	5.382G
77	5.540G	78	5.538G	79	5.502G	80	5.573G
81	5.692G	82	5.445G	83	5.590G	84	5.370G
85	5.570G	86	5.439G	87	5.654G	88	5.443G
89	5.352G	90	5.581G	91	5.295G	92	5.681G
93	5.322G	94	5.680G	95	5.327G	96	5.561G
97	5.345G	98	5.550G	99	5.356G	100	5.609G



Hopping Frequency Sequence Name: HOP_FREQ_SEQ_21							
SEQ#	Frequency (Hz)	SEQ#	Frequency (Hz)	SEQ#	Frequency (Hz)	SEQ#	Frequency (Hz)
1	5.269G	2	5.285G	3	5.400G	4	5.637G
5	5.564G	6	5.523G	7	5.255G	8	5.461G
9	5.563G	10	5.552G	11	5.625G	12	5.421G
13	5.531G	14	5.695G	15	5.271G	16	5.590G
17	5.484G	18	5.456G	19	5.352G	20	5.409G
21	5.672G	22	5.459G	23	5.292G	24	5.359G
25	5.486G	26	5.422G	27	5.650G	28	5.407G
29	5.633G	30	5.532G	31	5.720G	32	5.493G
33	5.357G	34	5.439G	35	5.472G	36	5.628G
37	5.442G	38	5.668G	39	5.343G	40	5.638G
41	5.466G	42	5.470G	43	5.585G	44	5.611G
45	5.471G	46	5.524G	47	5.307G	48	5.441G
49	5.398G	50	5.529G	51	5.545G	52	5.325G
53	5.641G	54	5.688G	55	5.657G	56	5.429G
57	5.302G	58	5.719G	59	5.687G	60	5.494G
61	5.328G	62	5.397G	63	5.475G	64	5.626G
65	5.693G	66	5.265G	67	5.608G	68	5.337G
69	5.485G	70	5.703G	71	5.554G	72	5.294G
73	5.505G	74	5.314G	75	5.324G	76	5.405G
77	5.355G	78	5.389G	79	5.649G	80	5.620G
81	5.259G	82	5.566G	83	5.645G	84	5.701G
85	5.510G	86	5.370G	87	5.539G	88	5.423G
89	5.342G	90	5.609G	91	5.384G	92	5.629G
93	5.369G	94	5.613G	95	5.718G	96	5.381G
97	5.424G	98	5.578G	99	5.568G	100	5.427G

Hopping Frequency Sequence Name: HOP_FREQ_SEQ_22							
SEQ#	Frequency (Hz)	SEQ#	Frequency (Hz)	SEQ#	Frequency (Hz)	SEQ#	Frequency (Hz)
1	5.576G	2	5.614G	3	5.255G	4	5.381G
5	5.450G	6	5.715G	7	5.545G	8	5.517G
9	5.647G	10	5.317G	11	5.546G	12	5.375G
13	5.530G	14	5.439G	15	5.344G	16	5.541G
17	5.323G	18	5.513G	19	5.480G	20	5.586G
21	5.300G	22	5.565G	23	5.341G	24	5.472G
25	5.283G	26	5.524G	27	5.307G	28	5.284G
29	5.388G	30	5.583G	31	5.663G	32	5.332G
33	5.484G	34	5.362G	35	5.658G	36	5.295G
37	5.446G	38	5.491G	39	5.441G	40	5.570G
41	5.351G	42	5.533G	43	5.349G	44	5.655G
45	5.563G	46	5.638G	47	5.613G	48	5.646G
49	5.285G	50	5.696G	51	5.417G	52	5.358G
53	5.703G	54	5.669G	55	5.662G	56	5.713G
57	5.335G	58	5.321G	59	5.438G	60	5.355G
61	5.628G	62	5.412G	63	5.700G	64	5.674G
65	5.536G	66	5.334G	67	5.626G	68	5.465G
69	5.310G	70	5.518G	71	5.282G	72	5.551G
73	5.585G	74	5.548G	75	5.680G	76	5.376G
77	5.338G	78	5.440G	79	5.266G	80	5.648G
81	5.516G	82	5.468G	83	5.644G	84	5.414G
85	5.579G	86	5.393G	87	5.643G	88	5.537G
89	5.487G	90	5.592G	91	5.590G	92	5.423G
93	5.430G	94	5.288G	95	5.387G	96	5.636G
97	5.456G	98	5.508G	99	5.359G	100	5.425G

Hopping Frequency Sequence Name: HOP_FREQ_SEQ_23							
SEQ#	Frequency (Hz)	SEQ#	Frequency (Hz)	SEQ#	Frequency (Hz)	SEQ#	Frequency (Hz)
1	5.650G	2	5.457G	3	5.366G	4	5.672G
5	5.654G	6	5.255G	7	5.381G	8	5.432G
9	5.701G	10	5.639G	11	5.310G	12	5.598G
13	5.405G	14	5.576G	15	5.464G	16	5.529G
17	5.659G	18	5.278G	19	5.251G	20	5.525G
21	5.530G	22	5.528G	23	5.567G	24	5.486G
25	5.394G	26	5.690G	27	5.713G	28	5.315G
29	5.533G	30	5.614G	31	5.623G	32	5.395G
33	5.620G	34	5.308G	35	5.379G	36	5.281G
37	5.677G	38	5.304G	39	5.537G	40	5.364G
41	5.352G	42	5.339G	43	5.284G	44	5.456G
45	5.626G	46	5.632G	47	5.287G	48	5.592G
49	5.452G	50	5.470G	51	5.329G	52	5.388G
53	5.356G	54	5.585G	55	5.593G	56	5.283G
57	5.603G	58	5.361G	59	5.408G	60	5.717G
61	5.404G	62	5.298G	63	5.347G	64	5.332G
65	5.412G	66	5.697G	67	5.674G	68	5.263G
69	5.499G	70	5.372G	71	5.676G	72	5.609G
73	5.619G	74	5.468G	75	5.692G	76	5.577G
77	5.578G	78	5.268G	79	5.428G	80	5.552G
81	5.413G	82	5.482G	83	5.579G	84	5.662G
85	5.621G	86	5.572G	87	5.682G	88	5.625G
89	5.644G	90	5.279G	91	5.253G	92	5.652G
93	5.678G	94	5.360G	95	5.627G	96	5.270G
97	5.721G	98	5.261G	99	5.497G	100	5.441G

Hopping Frequency Sequence Name: HOP_FREQ_SEQ_24							
SEQ#	Frequency (Hz)	SEQ#	Frequency (Hz)	SEQ#	Frequency (Hz)	SEQ#	Frequency (Hz)
1	5.564G	2	5.702G	3	5.585G	4	5.465G
5	5.407G	6	5.670G	7	5.522G	8	5.466G
9	5.628G	10	5.659G	11	5.485G	12	5.704G
13	5.640G	14	5.367G	15	5.510G	16	5.722G
17	5.412G	18	5.355G	19	5.430G	20	5.549G
21	5.361G	22	5.329G	23	5.389G	24	5.587G
25	5.621G	26	5.720G	27	5.451G	28	5.320G
29	5.321G	30	5.424G	31	5.508G	32	5.618G
33	5.278G	34	5.556G	35	5.387G	36	5.374G
37	5.562G	38	5.553G	39	5.470G	40	5.276G
41	5.457G	42	5.439G	43	5.711G	44	5.518G
45	5.458G	46	5.513G	47	5.500G	48	5.376G
49	5.402G	50	5.447G	51	5.669G	52	5.524G
53	5.400G	54	5.515G	55	5.625G	56	5.652G
57	5.449G	58	5.301G	59	5.484G	60	5.529G
61	5.541G	62	5.333G	63	5.255G	64	5.354G
65	5.695G	66	5.365G	67	5.701G	68	5.494G
69	5.646G	70	5.454G	71	5.613G	72	5.721G
73	5.595G	74	5.688G	75	5.690G	76	5.487G
77	5.415G	78	5.428G	79	5.548G	80	5.591G
81	5.277G	82	5.496G	83	5.323G	84	5.302G
85	5.719G	86	5.298G	87	5.299G	88	5.614G
89	5.405G	90	5.497G	91	5.563G	92	5.291G
93	5.724G	94	5.483G	95	5.271G	96	5.297G
97	5.559G	98	5.311G	99	5.426G	100	5.360G

Hopping Frequency Sequence Name: HOP_FREQ_SEQ_25							
SEQ#	Frequency (Hz)	SEQ#	Frequency (Hz)	SEQ#	Frequency (Hz)	SEQ#	Frequency (Hz)
1	5.336G	2	5.277G	3	5.619G	4	5.303G
5	5.685G	6	5.545G	7	5.356G	8	5.341G
9	5.471G	10	5.533G	11	5.724G	12	5.716G
13	5.267G	14	5.495G	15	5.253G	16	5.460G
17	5.600G	18	5.279G	19	5.333G	20	5.335G
21	5.566G	22	5.384G	23	5.718G	24	5.616G
25	5.598G	26	5.588G	27	5.722G	28	5.591G
29	5.621G	30	5.475G	31	5.366G	32	5.692G
33	5.681G	34	5.306G	35	5.595G	36	5.594G
37	5.673G	38	5.291G	39	5.400G	40	5.269G
41	5.426G	42	5.491G	43	5.281G	44	5.395G
45	5.515G	46	5.288G	47	5.519G	48	5.334G
49	5.711G	50	5.550G	51	5.464G	52	5.525G
53	5.377G	54	5.265G	55	5.452G	56	5.596G
57	5.297G	58	5.305G	59	5.565G	60	5.579G
61	5.345G	62	5.703G	63	5.719G	64	5.298G
65	5.541G	66	5.456G	67	5.282G	68	5.645G
69	5.421G	70	5.357G	71	5.351G	72	5.431G
73	5.674G	74	5.449G	75	5.576G	76	5.539G
77	5.264G	78	5.257G	79	5.439G	80	5.562G
81	5.493G	82	5.642G	83	5.668G	84	5.477G
85	5.450G	86	5.311G	87	5.544G	88	5.707G
89	5.402G	90	5.567G	91	5.442G	92	5.343G
93	5.720G	94	5.397G	95	5.665G	96	5.582G
97	5.405G	98	5.467G	99	5.444G	100	5.693G

Hopping Frequency Sequence Name: HOP_FREQ_SEQ_26							
SEQ#	Frequency (Hz)	SEQ#	Frequency (Hz)	SEQ#	Frequency (Hz)	SEQ#	Frequency (Hz)
1	5.474G	2	5.271G	3	5.495G	4	5.592G
5	5.560G	6	5.447G	7	5.713G	8	5.561G
9	5.389G	10	5.526G	11	5.400G	12	5.715G
13	5.672G	14	5.388G	15	5.450G	16	5.325G
17	5.706G	18	5.556G	19	5.621G	20	5.522G
21	5.532G	22	5.357G	23	5.587G	24	5.258G
25	5.435G	26	5.329G	27	5.716G	28	5.571G
29	5.344G	30	5.250G	31	5.649G	32	5.639G
33	5.611G	34	5.466G	35	5.612G	36	5.274G
37	5.263G	38	5.539G	39	5.434G	40	5.645G
41	5.615G	42	5.572G	43	5.574G	44	5.549G
45	5.420G	46	5.646G	47	5.501G	48	5.402G
49	5.453G	50	5.320G	51	5.674G	52	5.491G
53	5.683G	54	5.700G	55	5.607G	56	5.441G
57	5.625G	58	5.464G	59	5.699G	60	5.490G
61	5.265G	62	5.719G	63	5.470G	64	5.494G
65	5.302G	66	5.391G	67	5.541G	68	5.641G
69	5.338G	70	5.722G	71	5.475G	72	5.295G
73	5.352G	74	5.692G	75	5.583G	76	5.529G
77	5.665G	78	5.603G	79	5.423G	80	5.465G
81	5.487G	82	5.415G	83	5.381G	84	5.354G
85	5.624G	86	5.502G	87	5.533G	88	5.688G
89	5.375G	90	5.272G	91	5.622G	92	5.437G
93	5.499G	94	5.714G	95	5.578G	96	5.576G
97	5.278G	98	5.513G	99	5.419G	100	5.383G

Hopping Frequency Sequence Name: HOP_FREQ_SEQ_27							
SEQ#	Frequency (Hz)	SEQ#	Frequency (Hz)	SEQ#	Frequency (Hz)	SEQ#	Frequency (Hz)
1	5.668G	2	5.412G	3	5.577G	4	5.421G
5	5.372G	6	5.376G	7	5.363G	8	5.645G
9	5.696G	10	5.596G	11	5.650G	12	5.587G
13	5.306G	14	5.691G	15	5.341G	16	5.256G
17	5.399G	18	5.429G	19	5.392G	20	5.632G
21	5.263G	22	5.466G	23	5.567G	24	5.265G
25	5.522G	26	5.661G	27	5.700G	28	5.511G
29	5.536G	30	5.326G	31	5.709G	32	5.695G
33	5.669G	34	5.523G	35	5.582G	36	5.580G
37	5.550G	38	5.277G	39	5.285G	40	5.557G
41	5.574G	42	5.461G	43	5.425G	44	5.551G
45	5.608G	46	5.261G	47	5.317G	48	5.260G
49	5.439G	50	5.562G	51	5.324G	52	5.414G
53	5.527G	54	5.497G	55	5.686G	56	5.259G
57	5.664G	58	5.590G	59	5.478G	60	5.404G
61	5.589G	62	5.607G	63	5.481G	64	5.689G
65	5.389G	66	5.640G	67	5.720G	68	5.697G
69	5.402G	70	5.452G	71	5.313G	72	5.717G
73	5.257G	74	5.287G	75	5.534G	76	5.553G
77	5.304G	78	5.684G	79	5.374G	80	5.390G
81	5.441G	82	5.506G	83	5.444G	84	5.329G
85	5.250G	86	5.503G	87	5.588G	88	5.442G
89	5.611G	90	5.561G	91	5.406G	92	5.663G
93	5.297G	94	5.619G	95	5.405G	96	5.677G
97	5.501G	98	5.508G	99	5.262G	100	5.474G

Hopping Frequency Sequence Name: HOP_FREQ_SEQ_28							
SEQ#	Frequency (Hz)	SEQ#	Frequency (Hz)	SEQ#	Frequency (Hz)	SEQ#	Frequency (Hz)
1	5.307G	2	5.649G	3	5.482G	4	5.315G
5	5.443G	6	5.285G	7	5.390G	8	5.326G
9	5.654G	10	5.581G	11	5.263G	12	5.687G
13	5.679G	14	5.486G	15	5.279G	16	5.680G
17	5.387G	18	5.608G	19	5.487G	20	5.724G
21	5.683G	22	5.430G	23	5.436G	24	5.320G
25	5.281G	26	5.257G	27	5.539G	28	5.255G
29	5.622G	30	5.359G	31	5.251G	32	5.418G
33	5.456G	34	5.569G	35	5.628G	36	5.643G
37	5.301G	38	5.488G	39	5.338G	40	5.584G
41	5.685G	42	5.503G	43	5.411G	44	5.697G
45	5.574G	46	5.558G	47	5.468G	48	5.355G
49	5.478G	50	5.549G	51	5.283G	52	5.648G
53	5.695G	54	5.371G	55	5.304G	56	5.705G
57	5.722G	58	5.349G	59	5.453G	60	5.591G
61	5.678G	62	5.401G	63	5.284G	64	5.481G
65	5.381G	66	5.644G	67	5.422G	68	5.590G
69	5.547G	70	5.458G	71	5.274G	72	5.446G
73	5.523G	74	5.391G	75	5.719G	76	5.296G
77	5.521G	78	5.286G	79	5.435G	80	5.336G
81	5.619G	82	5.668G	83	5.565G	84	5.343G
85	5.434G	86	5.356G	87	5.374G	88	5.278G
89	5.449G	90	5.660G	91	5.544G	92	5.363G
93	5.604G	94	5.314G	95	5.499G	96	5.531G
97	5.322G	98	5.347G	99	5.675G	100	5.273G



Hopping Frequency Sequence Name: HOP_FREQ_SEQ_29							
SEQ#	Frequency (Hz)	SEQ#	Frequency (Hz)	SEQ#	Frequency (Hz)	SEQ#	Frequency (Hz)
1	5.587G	2	5.271G	3	5.622G	4	5.676G
5	5.627G	6	5.604G	7	5.309G	8	5.666G
9	5.449G	10	5.613G	11	5.340G	12	5.579G
13	5.372G	14	5.263G	15	5.252G	16	5.665G
17	5.568G	18	5.386G	19	5.639G	20	5.480G
21	5.251G	22	5.270G	23	5.614G	24	5.698G
25	5.549G	26	5.451G	27	5.335G	28	5.685G
29	5.464G	30	5.424G	31	5.291G	32	5.400G
33	5.555G	34	5.530G	35	5.510G	36	5.278G
37	5.257G	38	5.595G	39	5.724G	40	5.645G
41	5.675G	42	5.317G	43	5.695G	44	5.722G
45	5.277G	46	5.522G	47	5.686G	48	5.597G
49	5.588G	50	5.517G	51	5.518G	52	5.707G
53	5.431G	54	5.364G	55	5.542G	56	5.513G
57	5.322G	58	5.405G	59	5.402G	60	5.560G
61	5.677G	62	5.492G	63	5.446G	64	5.268G
65	5.717G	66	5.459G	67	5.357G	68	5.655G
69	5.650G	70	5.314G	71	5.688G	72	5.528G
73	5.535G	74	5.715G	75	5.380G	76	5.648G
77	5.556G	78	5.531G	79	5.616G	80	5.586G
81	5.612G	82	5.435G	83	5.656G	84	5.659G
85	5.546G	86	5.407G	87	5.346G	88	5.516G
89	5.623G	90	5.634G	91	5.325G	92	5.420G
93	5.720G	94	5.558G	95	5.478G	96	5.644G
97	5.311G	98	5.607G	99	5.273G	100	5.444G

Hopping Frequency Sequence Name: HOP_FREQ_SEQ_30							
SEQ#	Frequency (Hz)	SEQ#	Frequency (Hz)	SEQ#	Frequency (Hz)	SEQ#	Frequency (Hz)
1	5.490G	2	5.296G	3	5.458G	4	5.553G
5	5.430G	6	5.516G	7	5.414G	8	5.618G
9	5.521G	10	5.544G	11	5.721G	12	5.438G
13	5.311G	14	5.677G	15	5.386G	16	5.382G
17	5.600G	18	5.446G	19	5.549G	20	5.422G
21	5.291G	22	5.581G	23	5.316G	24	5.359G
25	5.637G	26	5.588G	27	5.612G	28	5.288G
29	5.455G	30	5.541G	31	5.385G	32	5.557G
33	5.413G	34	5.701G	35	5.515G	36	5.254G
37	5.459G	38	5.714G	39	5.502G	40	5.528G
41	5.536G	42	5.260G	43	5.614G	44	5.451G
45	5.663G	46	5.532G	47	5.273G	48	5.482G
49	5.689G	50	5.326G	51	5.578G	52	5.537G
53	5.266G	54	5.387G	55	5.299G	56	5.513G
57	5.355G	58	5.297G	59	5.569G	60	5.262G
61	5.699G	62	5.551G	63	5.648G	64	5.679G
65	5.389G	66	5.607G	67	5.450G	68	5.421G
69	5.571G	70	5.629G	71	5.345G	72	5.623G
73	5.380G	74	5.643G	75	5.656G	76	5.500G
77	5.664G	78	5.550G	79	5.554G	80	5.269G
81	5.435G	82	5.442G	83	5.715G	84	5.284G
85	5.277G	86	5.582G	87	5.460G	88	5.412G
89	5.638G	90	5.354G	91	5.265G	92	5.323G
93	5.585G	94	5.539G	95	5.711G	96	5.390G
97	5.697G	98	5.619G	99	5.552G	100	5.650G

**IEEE 802.11ac VHT80**

Type 1 Radar Statistical Performances						
Trial #	Pulse Repetition Frequency Number(1 to 23)	PRF(Pulse per seconds)	Pulses per Burst	PRI ( $\mu$ sec)	Radar Frequency (MHz)	Detection
1	18	1165.6	62	858	5497	Yes
2	20	1113.6	59	898	5561	Yes
3	8	1519.8	81	658	5530	Yes
4	19	1139	61	878	5562	Yes
5	6	1618.1	86	618	5545	Yes
6	12	1355	72	738	5529	Yes
7	5	1672.2	89	598	5533	Yes
8	7	1567.4	83	638	5499	Yes
9	22	1066.1	57	938	5553	Yes
10	2	1858.7	99	538	5564	Yes
11	9	1474.9	78	678	5547	Yes
12	14	1285.3	68	778	5532	Yes
13	21	1089.3	58	918	5504	Yes
14	10	1432.7	76	698	5537	Yes
15	3	1792.1	95	558	5555	Yes
16		327.8	18	3051	5507	Yes
17		425.4	23	2351	5557	Yes
18		1085.8	58	921	5509	Yes
19		643.1	34	1555	5501	Yes
20		386.1	21	2590	5514	Yes
21		635.7	34	1573	5519	Yes
22		1733.1	92	577	5500	Yes
23		479.2	26	2087	5536	Yes
24		1003.0	53	997	5508	Yes
25		424.1	23	2358	5492	Yes
26		638.6	34	1566	5560	Yes
27		412.5	22	2424	5520	Yes
28		501.5	27	1994	5510	Yes
29		520.0	28	1923	5512	Yes
30		1412.4	75	708	5513	Yes

Detection Rate: 100.0 %

Type 2 Radar Statistical Performances					
Trial #	Pulses per Burst	Pulse Width ( $\mu$ sec)	PRI ( $\mu$ sec)	Radar Frequency (MHz)	Detection
1	23	1.3	228	5533	Yes
2	26	3.2	172	5561	Yes
3	27	3.9	212	5525	Yes
4	24	1.9	213	5504	No
5	27	3.6	150	5550	Yes
6	26	3.3	158	5519	Yes
7	29	4.9	210	5539	Yes
8	23	1.3	223	5499	Yes
9	29	4.9	152	5555	Yes
10	27	3.3	190	5538	Yes
11	25	2.7	203	5562	Yes
12	29	5	227	5503	Yes
13	26	3.3	196	5536	No
14	28	4.4	198	5556	Yes
15	24	1.9	161	5506	Yes
16	27	3.6	226	5507	Yes
17	26	2.8	181	5535	Yes
18	25	2.5	167	5515	Yes
19	23	1.3	178	5528	Yes
20	25	2.4	187	5531	Yes
21	29	4.8	153	5522	Yes
22	27	3.5	201	5548	Yes
23	23	1.3	166	5511	Yes
24	29	4.8	155	5545	Yes
25	28	4.3	221	5505	Yes
26	26	3.2	191	5557	Yes
27	24	1.7	192	5518	Yes
28	23	1.2	164	5549	Yes
29	25	2.4	154	5498	Yes
30	29	5	207	5543	Yes
					Detection Rate: 93.33%

Type 3 Radar Statistical Performances					
Trial #	Pulses per Burst	Pulse Width ( $\mu$ sec)	PRI ( $\mu$ sec)	Radar Frequency (MHz)	Detection
1	16	6.3	403	5492	Yes
2	17	8.2	313	5497	Yes
3	18	8.9	214	5496	Yes
4	16	6.9	262	5513	No
5	17	8.6	273	5494	Yes
6	17	8.3	470	5567	Yes
7	18	9.9	453	5561	Yes
8	16	6.3	378	5503	Yes
9	18	9.9	483	5517	Yes
10	17	8.3	317	5552	Yes
11	17	7.7	385	5549	Yes
12	18	10	275	5499	Yes
13	17	8.3	497	5564	Yes
14	18	9.4	420	5508	Yes
15	16	6.9	366	5522	Yes
16	17	8.6	414	5531	Yes
17	17	7.8	444	5553	Yes
18	17	7.5	427	5557	Yes
19	16	6.3	338	5563	Yes
20	17	7.4	436	5534	Yes
21	18	9.8	265	5512	Yes
22	17	8.5	451	5560	Yes
23	16	6.3	274	5556	No
24	18	9.8	417	5504	Yes
25	18	9.3	330	5516	Yes
26	17	8.2	472	5520	Yes
27	16	6.7	333	5547	Yes
28	16	6.2	377	5530	Yes
29	17	7.4	394	5507	Yes
30	18	10	296	5533	Yes
					Detection Rate: 93.33 %

Type 4 Radar Statistical Performances					
Trial #	Pulses per Burst	Pulse Width ( $\mu$ sec)	PRI ( $\mu$ sec)	Radar Frequency (MHz)	Detection
1	12	11.7	403	5568	Yes
2	14	15.9	313	5563	Yes
3	15	17.4	214	5526	Yes
4	13	13.2	262	5495	Yes
5	15	16.8	273	5544	Yes
6	14	16.1	470	5497	No
7	16	19.8	453	5527	Yes
8	12	11.7	378	5507	Yes
9	16	19.8	483	5500	Yes
10	14	16.2	317	5510	No
11	14	14.8	385	5513	Yes
12	16	19.9	275	5550	Yes
13	14	16.1	497	5504	No
14	16	18.6	420	5567	Yes
15	13	13.2	366	5506	Yes
16	15	16.9	414	5545	Yes
17	14	15	444	5520	No
18	13	14.4	427	5509	Yes
19	12	11.7	338	5522	No
20	13	14.2	436	5547	No
21	16	19.6	265	5546	Yes
22	15	16.5	451	5529	Yes
23	12	11.7	274	5564	Yes
24	16	19.4	417	5542	Yes
25	16	18.3	330	5554	Yes
26	14	15.9	472	5539	Yes
27	12	12.5	333	5514	Yes
28	12	11.5	377	5516	Yes
29	13	14.2	394	5493	Yes
30	16	19.8	296	5499	Yes
					Detection Rate: 80 %

Type 5 Radar Statistical Performances		
Trial #	Test Signal Name	Detection
1	LP_Signal_01	Yes
2	LP_Signal_02	Yes
3	LP_Signal_03	Yes
4	LP_Signal_04	Yes
5	LP_Signal_05	Yes
6	LP_Signal_06	Yes
7	LP_Signal_07	Yes
8	LP_Signal_08	Yes
9	LP_Signal_09	Yes
10	LP_Signal_10	Yes
11	LP_Signal_11	Yes
12	LP_Signal_12	Yes
13	LP_Signal_13	Yes
14	LP_Signal_14	Yes
15	LP_Signal_15	Yes
16	LP_Signal_16	Yes
17	LP_Signal_17	Yes
18	LP_Signal_18	Yes
19	LP_Signal_19	Yes
20	LP_Signal_20	Yes
21	LP_Signal_21	Yes
22	LP_Signal_22	Yes
23	LP_Signal_23	Yes
24	LP_Signal_24	Yes
25	LP_Signal_25	Yes
26	LP_Signal_26	Yes
27	LP_Signal_27	Yes
28	LP_Signal_28	Yes
29	LP_Signal_29	Yes
30	LP_Signal_30	Yes
Detection Rate: 100 %		

Long Pulse Radar Test Signal						
Test Signal Name: LP_Signal_01						
Number of Bursts in Trial: 13						
Chirp Center Frequency: 5530MHz						
Burst	Pulse	Chirp	Number of	PRI-1 (us)	PRI-2 (us)	PRI-3 (us)

	Width (us)	Width (MHz)	Pulses per Burst			
1	72.2	12	2	1002.0	1973.0	-
2	74.1	12	2	1892.0	1635.0	-
3	85.9	12	3	1097.0	1171.0	1514.0
4	68.7	12	2	1150.0	1740.0	-
5	62.1	12	1	1907.0	-	-
6	84.8	12	3	1313.0	1536.0	1177.0
7	85.2	12	3	1597.0	1539.0	1629.0
8	76.2	12	2	1371.0	1764.0	-
9	94.6	12	3	1563.0	1880.0	1548.0
10	52.5	12	1	1528.0	-	-
11	94.6	12	3	1537.0	1935.0	1241.0
12	71.5	12	2	1337.0	1472.0	-
13	66.1	12	1	1824.0	-	-

Long Pulse Radar Test Signal

Test Signal Name: LP\_Signal\_02

Number of Bursts in Trial: 14

Chirp Center Frequency: 5530MHz

Burst	Pulse Width (us)	Chirp Width (MHz)	Number of Pulses per Burst	PRI-1 (us)	PRI-2 (us)	PRI-3 (us)
1	75.3	12	2	1516.0	1581.0	-
2	57.3	12	1	1187.0	-	-
3	97.0	12	3	1767.0	1677.0	1381.0
4	71.3	12	2	1683.0	1622.0	-
5	65.7	12	1	1458.0	-	-
6	56.8	12	1	1388.0	-	-
7	95.0	12	3	1793.0	1254.0	1779.0
8	52.2	12	1	1575.0	-	-
9	54.2	12	1	1682.0	-	-
10	94.1	12	3	1957.0	1485.0	1876.0
11	91.2	12	3	1803.0	1693.0	1628.0
12	91.8	12	3	1897.0	1636.0	1353.0
13	75.0	12	2	1877.0	1456.0	-
14	80.2	12	2	1698.0	1608.0	-

Long Pulse Radar Test Signal

Test Signal Name: LP\_Signal\_03



Number of Bursts in Trial: 17						
Chirp Center Frequency: 5530MHz						
Burst	Pulse Width (us)	Chirp Width (MHz)	Number of Pulses per Burst	PRI-1 (us)	PRI-2 (us)	PRI-3 (us)
1	76.2	16	2	1955.0	1109.0	-
2	97.3	16	3	1836.0	1042.0	1224.0
3	75.3	16	2	1579.0	1126.0	-
4	74.5	16	2	1771.0	1755.0	-
5	51.2	16	1	1133.0	-	-
6	66.1	16	1	1167.0	-	-
7	98.8	16	3	1919.0	1424.0	1985.0
8	61.3	16	1	1454.0	-	-
9	66.4	16	1	1772.0	-	-
10	93.5	16	3	1879.0	1022.0	1857.0
11	85.7	16	3	1980.0	1009.0	1716.0
12	50.5	16	1	1924.0	-	-
13	88.1	16	3	1131.0	1890.0	1939.0
14	68.9	16	2	1806.0	1414.0	-
15	55.3	16	1	1802.0	-	-
16	64.6	16	1	1178.0	-	-
17	57.2	16	1	1238.0	-	-

Long Pulse Radar Test Signal						
Test Signal Name: LP_Signal_04						
Number of Bursts in Trial: 12						
Chirp Center Frequency: 5530MHz						
Burst	Pulse Width (us)	Chirp Width (MHz)	Number of Pulses per Burst	PRI-1 (us)	PRI-2 (us)	PRI-3 (us)
1	78.5	10	2	1267.0	1505.0	-
2	63.3	10	1	1532.0	-	-
3	92.6	10	3	1729.0	1751.0	1928.0
4	91.0	10	3	1808.0	1249.0	1809.0
5	94.9	10	3	1186.0	1732.0	1743.0
6	79.1	10	2	1776.0	1457.0	-
7	50.3	10	1	1914.0	-	-
8	89.3	10	3	1182.0	1251.0	1687.0
9	94.6	10	3	1998.0	1753.0	1228.0
10	64.7	10	1	1100.0	-	-

11	84.0	10	3	1373.0	1450.0	1589.0
12	68.0	10	2	1895.0	1322.0	-

Long Pulse Radar Test Signal						
Test Signal Name: LP_Signal_05						
Number of Bursts in Trial: 11						
Chrip Center Frequency: 5530MHz						
Burst	Pulse Width (us)	Chrip Width (MHz)	Number of Pulses per Burst	PRI-1 (us)	PRI-2 (us)	PRI-3 (us)
1	80.0	8	2	1357.0	1208.0	-
2	94.7	8	3	1931.0	1905.0	1921.0
3	76.9	8	2	1453.0	1021.0	-
4	87.1	8	3	1953.0	1469.0	1706.0
5	54.6	8	1	1301.0	-	-
6	59.0	8	1	1794.0	-	-
7	78.9	8	2	1279.0	1975.0	-
8	69.3	8	2	1288.0	1610.0	-
9	78.0	8	2	1433.0	1025.0	-
10	93.4	8	3	1833.0	1804.0	1493.0
11	55.4	8	1	1495.0	-	-

Long Pulse Radar Test Signal						
Test Signal Name: LP_Signal_06						
Number of Bursts in Trial: 17						
Chrip Center Frequency: 5530MHz						
Burst	Pulse Width (us)	Chrip Width (MHz)	Number of Pulses per Burst	PRI-1 (us)	PRI-2 (us)	PRI-3 (us)
1	67.3	16	2	1530.0	1432.0	-
2	63.9	16	1	1356.0	-	-
3	91.0	16	3	1631.0	1478.0	1219.0
4	53.4	16	1	1609.0	-	-
5	85.7	16	3	1831.0	1535.0	1960.0
6	65.2	16	1	1873.0	-	-
7	68.7	16	2	1791.0	1461.0	-
8	76.1	16	2	1815.0	1300.0	-
9	97.0	16	3	1471.0	1292.0	1452.0
10	89.6	16	3	1436.0	1074.0	1400.0
11	86.9	16	3	1085.0	1093.0	1156.0

12	62.6	16	1	1870.0	-	-
13	78.5	16	2	1447.0	1404.0	-
14	82.5	16	2	1717.0	1689.0	-
15	89.2	16	3	1642.0	1391.0	1274.0
16	81.4	16	2	1624.0	1645.0	-
17	68.2	16	2	1475.0	1250.0	-

Long Pulse Radar Test Signal						
Test Signal Name: LP_Signal_07						
Number of Bursts in Trial: 17						
Chirp Center Frequency: 5530MHz						
Burst	Pulse Width (us)	Chirp Width (MHz)	Number of Pulses per Burst	PRI-1 (us)	PRI-2 (us)	PRI-3 (us)
1	74.9	16	2	1350.0	1816.0	-
2	85.3	16	3	1965.0	1440.0	1583.0
3	56.6	16	1	1739.0	-	-
4	51.4	16	1	1819.0	-	-
5	64.8	16	1	1673.0	-	-
6	93.4	16	3	1271.0	1504.0	1275.0
7	86.4	16	3	1203.0	1064.0	1347.0
8	98.9	16	3	1611.0	1958.0	1546.0
9	58.7	16	1	1638.0	-	-
10	63.4	16	1	1316.0	-	-
11	83.5	16	3	1741.0	1293.0	1305.0
12	59.8	16	1	1820.0	-	-
13	76.4	16	2	1484.0	1835.0	-
14	95.4	16	3	1423.0	1827.0	1474.0
15	79.3	16	2	1944.0	1891.0	-
16	85.2	16	3	1473.0	1321.0	1213.0
17	57.9	16	1	1757.0	-	-

Long Pulse Radar Test Signal						
Test Signal Name: LP_Signal_08						
Number of Bursts in Trial: 14						
Chirp Center Frequency: 5530MHz						
Burst	Pulse Width (us)	Chirp Width (MHz)	Number of Pulses per Burst	PRI-1 (us)	PRI-2 (us)	PRI-3 (us)
1	75.2	13	2	1261.0	1304.0	-

2	77.1	13	2	1027.0	1508.0	-
3	53.8	13	1	1902.0	-	-
4	75.7	13	2	1695.0	1486.0	-
5	64.7	13	1	1578.0	-	-
6	74.0	13	2	1297.0	1665.0	-
7	75.9	13	2	1668.0	1099.0	-
8	88.6	13	3	1090.0	1936.0	1660.0
9	87.0	13	3	1380.0	1565.0	1497.0
10	78.4	13	2	1379.0	1840.0	-
11	93.2	13	3	1850.0	1932.0	1054.0
12	82.0	13	2	1428.0	1543.0	-
13	98.5	13	3	1029.0	1055.0	1690.0
14	54.6	13	1	1266.0	-	-

Long Pulse Radar Test Signal

Test Signal Name: LP\_Signal\_09

Number of Bursts in Trial: 19

Chirp Center Frequency: 5530MHz

Burst	Pulse Width (us)	Chirp Width (MHz)	Number of Pulses per Burst	PRI-1 (us)	PRI-2 (us)	PRI-3 (us)
1	65.5	19	1	1799.0	-	-
2	77.7	19	2	1728.0	1378.0	-
3	60.7	19	1	1787.0	-	-
4	94.4	19	3	1908.0	1028.0	1324.0
5	92.7	19	3	1737.0	1540.0	1586.0
6	86.8	19	3	1368.0	1194.0	1593.0
7	54.0	19	1	1445.0	-	-
8	52.4	19	1	1101.0	-	-
9	70.5	19	2	1766.0	1927.0	-
10	54.5	19	1	1442.0	-	-
11	54.5	19	1	1913.0	-	-
12	76.9	19	2	1223.0	1894.0	-
13	51.7	19	1	1225.0	-	-
14	85.3	19	3	1403.0	1375.0	1925.0
15	66.3	19	1	1061.0	-	-
16	70.5	19	2	1881.0	1923.0	-
17	94.3	19	3	1510.0	1114.0	1654.0
18	57.6	19	1	1780.0	-	-
19	77.5	19	2	1602.0	1394.0	-

Long Pulse Radar Test Signal						
Test Signal Name: LP_Signal_10						
Number of Bursts in Trial: 8						
Chirp Center Frequency: 5530MHz						
Burst	Pulse Width (us)	Chirp Width (MHz)	Number of Pulses per Burst	PRI-1 (us)	PRI-2 (us)	PRI-3 (us)
1	70.6	5	2	1604.0	1926.0	-
2	57.2	5	1	1195.0	-	-
3	62.0	5	1	1181.0	-	-
4	77.5	5	2	1349.0	1658.0	-
5	92.5	5	3	1599.0	1544.0	1016.0
6	60.1	5	1	1077.0	-	-
7	61.3	5	1	1139.0	-	-
8	80.7	5	2	1562.0	1758.0	-

Long Pulse Radar Test Signal						
Test Signal Name: LP_Signal_11						
Number of Bursts in Trial: 19						
Chirp Center Frequency: 5499.6MHz						
Burst	Pulse Width (us)	Chirp Width (MHz)	Number of Pulses per Burst	PRI-1 (us)	PRI-2 (us)	PRI-3 (us)
1	62.8	19	1	1655.0	-	-
2	77.9	19	2	1014.0	1929.0	-
3	65.0	19	1	1860.0	-	-
4	93.3	19	3	1954.0	1542.0	1096.0
5	66.9	19	2	1667.0	1754.0	-
6	60.2	19	1	1625.0	-	-
7	58.8	19	1	1323.0	-	-
8	67.9	19	2	1518.0	1134.0	-
9	82.1	19	2	1281.0	1343.0	-
10	65.7	19	1	1615.0	-	-
11	50.9	19	1	1026.0	-	-
12	86.6	19	3	1966.0	1590.0	1158.0
13	98.5	19	3	1686.0	1977.0	1402.0
14	53.8	19	1	1011.0	-	-
15	72.8	19	2	1846.0	1714.0	-
16	56.6	19	1	1202.0	-	-
17	99.4	19	3	1429.0	1521.0	1455.0

18	71.2	19	2	1362.0	1060.0	-
19	87.9	19	3	1934.0	1172.0	1561.0

Long Pulse Radar Test Signal						
Test Signal Name: LP_Signal_12						
Number of Bursts in Trial: 13						
Chrip Center Frequency: 5496.4MHz						
Burst	Pulse Width (us)	Chrip Width (MHz)	Number of Pulses per Burst	PRI-1 (us)	PRI-2 (us)	PRI-3 (us)
1	72.2	11	2	1258.0	1361.0	-
2	90.7	11	3	1265.0	1573.0	1230.0
3	72.3	11	2	1050.0	1796.0	-
4	66.5	11	1	1507.0	-	-
5	84.1	11	3	1427.0	1393.0	1338.0
6	85.5	11	3	1449.0	1910.0	1374.0
7	54.5	11	1	1342.0	-	-
8	77.9	11	2	1118.0	1013.0	-
9	97.4	11	3	1781.0	1253.0	1707.0
10	53.4	11	1	1032.0	-	-
11	50.2	11	1	1671.0	-	-
12	68.3	11	2	1465.0	1125.0	-
13	84.3	11	3	1972.0	1652.0	1206.0

Long Pulse Radar Test Signal						
Test Signal Name: LP_Signal_13						
Number of Bursts in Trial: 12						
Chrip Center Frequency: 5496MHz						
Burst	Pulse Width (us)	Chrip Width (MHz)	Number of Pulses per Burst	PRI-1 (us)	PRI-2 (us)	PRI-3 (us)
1	81.4	10	2	1431.0	1141.0	-
2	56.0	10	1	1727.0	-	-
3	91.2	10	3	1533.0	1264.0	1132.0
4	74.6	10	2	1669.0	1477.0	-
5	55.5	10	1	1738.0	-	-
6	61.2	10	1	1774.0	-	-
7	87.7	10	3	1574.0	1140.0	1464.0
8	66.6	10	1	1587.0	-	-
9	93.0	10	3	1320.0	1663.0	1525.0

10	67.3	10	2	1018.0	1302.0	-
11	84.2	10	3	1513.0	1215.0	1688.0
12	54.8	10	1	1243.0	-	-

Long Pulse Radar Test Signal						
Test Signal Name: LP_Signal_14						
Number of Bursts in Trial: 14						
Chirp Center Frequency: 5497.2MHz						
Burst	Pulse Width (us)	Chirp Width (MHz)	Number of Pulses per Burst	PRI-1 (us)	PRI-2 (us)	PRI-3 (us)
1	93.4	13	3	1023.0	1052.0	1143.0
2	71.0	13	2	1152.0	1770.0	-
3	79.0	13	2	1862.0	1552.0	-
4	66.7	13	2	1483.0	1296.0	-
5	84.5	13	3	1185.0	1144.0	1832.0
6	55.3	13	1	1969.0	-	-
7	78.1	13	2	1318.0	1722.0	-
8	71.3	13	2	1653.0	1201.0	-
9	72.3	13	2	1222.0	1232.0	-
10	89.1	13	3	1874.0	1748.0	1491.0
11	90.1	13	3	1522.0	1582.0	1990.0
12	90.5	13	3	1176.0	1344.0	1971.0
13	61.3	13	1	1199.0	-	-
14	80.9	13	2	1111.0	1295.0	-

Long Pulse Radar Test Signal						
Test Signal Name: LP_Signal_15						
Number of Bursts in Trial: 9						
Chirp Center Frequency: 5494.8MHz						
Burst	Pulse Width (us)	Chirp Width (MHz)	Number of Pulses per Burst	PRI-1 (us)	PRI-2 (us)	PRI-3 (us)
1	57.8	7	1	1724.0	-	-
2	62.3	7	1	1498.0	-	-
3	82.4	7	2	1151.0	1396.0	-
4	61.5	7	1	1501.0	-	-
5	64.5	7	1	1623.0	-	-
6	81.9	7	2	1079.0	1951.0	-
7	97.4	7	3	1216.0	1204.0	1618.0

8	66.6	7	1	1630.0	-	-
9	55.2	7	1	1502.0	-	-

Long Pulse Radar Test Signal						
Test Signal Name: LP_Signal_16						
Number of Bursts in Trial: 20						
Chrip Center Frequency: 5500MHz						
Burst	Pulse Width (us)	Chrip Width (MHz)	Number of Pulses per Burst	PRI-1 (us)	PRI-2 (us)	PRI-3 (us)
1	92.5	20	3	1098.0	1694.0	1425.0
2	62.7	20	1	1844.0	-	-
3	98.2	20	3	1976.0	1482.0	1887.0
4	51.1	20	1	1479.0	-	-
5	88.1	20	3	1838.0	1191.0	1421.0
6	83.5	20	3	1366.0	1037.0	1981.0
7	71.3	20	2	1676.0	1699.0	-
8	79.3	20	2	1856.0	1174.0	-
9	73.3	20	2	1326.0	1529.0	-
10	88.1	20	3	1070.0	1841.0	1710.0
11	61.6	20	1	1327.0	-	-
12	90.8	20	3	1086.0	1584.0	1236.0
13	64.4	20	1	1045.0	-	-
14	75.5	20	2	1311.0	1273.0	-
15	61.2	20	1	1180.0	-	-
16	62.8	20	1	1136.0	-	-
17	98.1	20	3	1242.0	1058.0	1248.0
18	72.1	20	2	1941.0	1041.0	-
19	97.1	20	3	1031.0	1221.0	1309.0
20	62.0	20	1	1797.0	-	-

Long Pulse Radar Test Signal						
Test Signal Name: LP_Signal_17						
Number of Bursts in Trial: 13						
Chrip Center Frequency: 5496.4MHz						
Burst	Pulse Width (us)	Chrip Width (MHz)	Number of Pulses per Burst	PRI-1 (us)	PRI-2 (us)	PRI-3 (us)
1	92.3	11	3	1768.0	1605.0	1619.0
2	66.0	11	1	1468.0	-	-



3	50.6	11	1	1549.0	-	-
4	63.2	11	1	1035.0	-	-
5	74.6	11	2	1312.0	1745.0	-
6	53.4	11	1	1598.0	-	-
7	75.3	11	2	1837.0	1443.0	-
8	84.2	11	3	1110.0	1034.0	1948.0
9	81.5	11	2	1898.0	1298.0	-
10	52.8	11	1	1553.0	-	-
11	52.3	11	1	1675.0	-	-
12	57.4	11	1	1702.0	-	-
13	76.7	11	2	1961.0	1670.0	-

Long Pulse Radar Test Signal						
Test Signal Name: LP_Signal_18						
Number of Bursts in Trial: 12						
Chirp Center Frequency: 5496MHz						
Burst	Pulse Width (us)	Chirp Width (MHz)	Number of Pulses per Burst	PRI-1 (us)	PRI-2 (us)	PRI-3 (us)
1	65.8	10	1	2000.0	-	-
2	86.6	10	3	1666.0	1190.0	1043.0
3	54.0	10	1	1922.0	-	-
4	86.4	10	3	1703.0	1962.0	1639.0
5	54.2	10	1	1119.0	-	-
6	90.0	10	3	1257.0	1911.0	1571.0
7	87.8	10	3	1120.0	1509.0	1708.0
8	50.9	10	1	1572.0	-	-
9	59.7	10	1	1155.0	-	-
10	66.7	10	2	1818.0	1725.0	-
11	52.4	10	1	1082.0	-	-
12	99.8	10	3	1775.0	1778.0	1068.0

Long Pulse Radar Test Signal						
Test Signal Name: LP_Signal_19						
Number of Bursts in Trial: 9						
Chirp Center Frequency: 5494.8MHz						
Burst	Pulse Width (us)	Chirp Width (MHz)	Number of Pulses per Burst	PRI-1 (us)	PRI-2 (us)	PRI-3 (us)
1	90.2	7	3	1723.0	1106.0	1103.0

2	93.4	7	3	1715.0	1810.0	1370.0
3	86.8	7	3	1390.0	1340.0	1634.0
4	71.2	7	2	1108.0	1351.0	-
5	98.7	7	3	1949.0	1720.0	1363.0
6	66.4	7	1	1621.0	-	-
7	59.7	7	1	1993.0	-	-
8	50.3	7	1	1412.0	-	-
9	54.6	7	1	1441.0	-	-

Long Pulse Radar Test Signal						
Test Signal Name: LP_Signal_20						
Number of Bursts in Trial: 19						
Chrip Center Frequency: 5499.6MHz						
Burst	Pulse Width (us)	Chrip Width (MHz)	Number of Pulses per Burst	PRI-1 (us)	PRI-2 (us)	PRI-3 (us)
1	62.9	19	1	1466.0	-	-
2	76.5	19	2	1008.0	1600.0	-
3	62.0	19	1	1355.0	-	-
4	84.9	19	3	1893.0	1851.0	1166.0
5	76.5	19	2	1909.0	1987.0	-
6	84.7	19	3	1179.0	1256.0	1107.0
7	58.1	19	1	1123.0	-	-
8	87.1	19	3	1315.0	1763.0	1365.0
9	97.9	19	3	1051.0	1395.0	1519.0
10	70.5	19	2	1984.0	1692.0	-
11	85.7	19	3	1438.0	1040.0	1672.0
12	54.2	19	1	1247.0	-	-
13	64.0	19	1	1674.0	-	-
14	98.7	19	3	1566.0	1289.0	1752.0
15	89.0	19	3	1290.0	1405.0	1959.0
16	57.2	19	1	1164.0	-	-
17	76.5	19	2	1165.0	1135.0	-
18	93.9	19	3	1888.0	1731.0	1828.0
19	82.2	19	2	1175.0	1091.0	-

Long Pulse Radar Test Signal						
Test Signal Name: LP_Signal_21						
Number of Bursts in Trial: 8						
Chrip Center Frequency: 5566MHz						

Burst	Pulse Width (us)	Chirp Width (MHz)	Number of Pulses per Burst	PRI-1 (us)	PRI-2 (us)	PRI-3 (us)
1	59.2	5	1	1307.0	-	-
2	61.0	5	1	1389.0	-	-
3	82.6	5	2	1047.0	1637.0	-
4	99.3	5	3	1408.0	1760.0	1901.0
5	98.3	5	3	1996.0	1039.0	1104.0
6	63.5	5	1	1596.0	-	-
7	84.5	5	3	1115.0	1930.0	1864.0
8	60.1	5	1	1328.0	-	-

Long Pulse Radar Test Signal  
Test Signal Name: LP\_Signal\_22  
Number of Bursts in Trial: 9  
Chirp Center Frequency: 5565.6MHz

Burst	Pulse Width (us)	Chirp Width (MHz)	Number of Pulses per Burst	PRI-1 (us)	PRI-2 (us)	PRI-3 (us)
1	88.5	6	3	1648.0	1627.0	1496.0
2	63.0	6	1	1001.0	-	-
3	82.8	6	2	1868.0	1006.0	-
4	86.4	6	3	1657.0	1044.0	1709.0
5	92.7	6	3	1644.0	1916.0	1527.0
6	57.1	6	1	1420.0	-	-
7	72.0	6	2	1092.0	1192.0	-
8	52.8	6	1	1335.0	-	-
9	60.1	6	1	1137.0	-	-

Long Pulse Radar Test Signal  
Test Signal Name: LP\_Signal\_23  
Number of Bursts in Trial: 19  
Chirp Center Frequency: 5560.4MHz

Burst	Pulse Width (us)	Chirp Width (MHz)	Number of Pulses per Burst	PRI-1 (us)	PRI-2 (us)	PRI-3 (us)
1	92.0	19	3	1858.0	1601.0	1189.0
2	51.4	19	1	1331.0	-	-
3	77.7	19	2	1517.0	1834.0	-
4	55.3	19	1	1397.0	-	-

5	79.6	19	2	1992.0	1205.0	-
6	63.9	19	1	1588.0	-	-
7	61.9	19	1	1439.0	-	-
8	96.2	19	3	1889.0	1193.0	1938.0
9	66.7	19	2	1853.0	1418.0	-
10	95.6	19	3	1761.0	1592.0	1263.0
11	76.1	19	2	1585.0	1950.0	-
12	94.8	19	3	1387.0	1336.0	1550.0
13	97.9	19	3	1807.0	1138.0	1661.0
14	64.0	19	1	1038.0	-	-
15	72.2	19	2	1790.0	1882.0	-
16	72.6	19	2	1736.0	1383.0	-
17	77.6	19	2	1244.0	1641.0	-
18	91.1	19	3	1299.0	1406.0	1056.0
19	93.7	19	3	1964.0	1718.0	1053.0

Long Pulse Radar Test Signal						
Test Signal Name: LP_Signal_24						
Number of Bursts in Trial: 18						
Chirp Center Frequency: 5560.8MHz						
Burst	Pulse Width (us)	Chirp Width (MHz)	Number of Pulses per Burst	PRI-1 (us)	PRI-2 (us)	PRI-3 (us)
1	80.4	18	2	1735.0	1046.0	-
2	77.2	18	2	1662.0	1359.0	-
3	63.7	18	1	1341.0	-	-
4	71.3	18	2	1346.0	1883.0	-
5	92.1	18	3	1069.0	1033.0	1417.0
6	74.5	18	2	1986.0	1730.0	-
7	69.7	18	2	1988.0	1547.0	-
8	74.0	18	2	1612.0	1285.0	-
9	65.0	18	1	1415.0	-	-
10	84.2	18	3	1556.0	1030.0	1664.0
11	93.1	18	3	1148.0	1160.0	1259.0
12	97.1	18	3	1062.0	1372.0	1392.0
13	92.0	18	3	1933.0	1970.0	1685.0
14	95.8	18	3	1967.0	1875.0	1112.0
15	78.9	18	2	1983.0	1903.0	-
16	65.2	18	1	1814.0	-	-
17	75.0	18	2	1146.0	1142.0	-

18	66.2	18	1	1577.0	-	-
----	------	----	---	--------	---	---

Long Pulse Radar Test Signal						
Test Signal Name: LP_Signal_25						
Number of Bursts in Trial: 18						
Chirp Center Frequency: 5560.8MHz						
Burst	Pulse Width (us)	Chirp Width (MHz)	Number of Pulses per Burst	PRI-1 (us)	PRI-2 (us)	PRI-3 (us)
1	76.8	18	2	1284.0	1792.0	-
2	79.7	18	2	1364.0	1276.0	-
3	97.1	18	3	1861.0	1759.0	1260.0
4	70.7	18	2	1937.0	1744.0	-
5	53.1	18	1	1017.0	-	-
6	81.5	18	2	1184.0	1072.0	-
7	68.0	18	2	1360.0	1332.0	-
8	58.4	18	1	1306.0	-	-
9	65.4	18	1	1234.0	-	-
10	90.7	18	3	1207.0	1147.0	1603.0
11	99.1	18	3	1900.0	1746.0	1252.0
12	60.6	18	1	1684.0	-	-
13	63.8	18	1	1616.0	-	-
14	65.1	18	1	1382.0	-	-
15	66.0	18	1	1829.0	-	-
16	78.4	18	2	1512.0	1940.0	-
17	72.5	18	2	1430.0	1701.0	-
18	82.9	18	2	1010.0	1066.0	-

Long Pulse Radar Test Signal						
Test Signal Name: LP_Signal_26						
Number of Bursts in Trial: 14						
Chirp Center Frequency: 5562.8MHz						
Burst	Pulse Width (us)	Chirp Width (MHz)	Number of Pulses per Burst	PRI-1 (us)	PRI-2 (us)	PRI-3 (us)
1	78.2	13	2	1227.0	1352.0	-
2	80.1	13	2	1872.0	1680.0	-
3	85.6	13	3	1545.0	1105.0	1399.0
4	80.9	13	2	1633.0	1129.0	-
5	59.9	13	1	1145.0	-	-

6	90.0	13	3	1059.0	1978.0	1859.0
7	96.9	13	3	1407.0	1480.0	1747.0
8	62.0	13	1	1885.0	-	-
9	73.7	13	2	1852.0	1696.0	-
10	98.5	13	3	1063.0	1088.0	1168.0
11	84.1	13	3	1157.0	1198.0	1212.0
12	99.0	13	3	1245.0	1784.0	1422.0
13	69.0	13	2	1515.0	1991.0	-
14	98.8	13	3	1237.0	1554.0	1705.0

**Long Pulse Radar Test Signal**

Test Signal Name: LP\_Signal\_27

Number of Bursts in Trial: 15

Chirp Center Frequency: 5562.4MHz

Burst	Pulse Width (us)	Chirp Width (MHz)	Number of Pulses per Burst	PRI-1 (us)	PRI-2 (us)	PRI-3 (us)
1	97.3	14	3	1384.0	1434.0	1843.0
2	56.4	14	1	1170.0	-	-
3	50.7	14	1	1049.0	-	-
4	61.4	14	1	1777.0	-	-
5	96.6	14	3	1626.0	1821.0	1643.0
6	59.7	14	1	1280.0	-	-
7	74.1	14	2	1918.0	1845.0	-
8	82.3	14	2	1435.0	1640.0	-
9	53.3	14	1	1127.0	-	-
10	83.6	14	3	1235.0	1489.0	1721.0
11	59.1	14	1	1884.0	-	-
12	79.0	14	2	1451.0	1613.0	-
13	75.0	14	2	1239.0	1989.0	-
14	54.3	14	1	1481.0	-	-
15	70.3	14	2	1783.0	1334.0	-

**Long Pulse Radar Test Signal**

Test Signal Name: LP\_Signal\_28

Number of Bursts in Trial: 14

Chirp Center Frequency: 5562.8MHz

Burst	Pulse Width (us)	Chirp Width (MHz)	Number of Pulses per Burst	PRI-1 (us)	PRI-2 (us)	PRI-3 (us)
-------	------------------	-------------------	----------------------------	------------	------------	------------

1	78.0	13	2	1786.0	1231.0	-
2	81.1	13	2	1377.0	1019.0	-
3	63.6	13	1	1083.0	-	-
4	73.2	13	2	1048.0	1878.0	-
5	96.0	13	3	1555.0	1704.0	1130.0
6	87.0	13	3	1492.0	1523.0	1526.0
7	94.9	13	3	1487.0	1218.0	1865.0
8	80.6	13	2	1278.0	1570.0	-
9	96.0	13	3	1183.0	1531.0	1956.0
10	69.8	13	2	1467.0	1081.0	-
11	57.1	13	1	1354.0	-	-
12	73.8	13	2	1646.0	1196.0	-
13	91.2	13	3	1711.0	1410.0	1078.0
14	57.8	13	1	1742.0	-	-

Long Pulse Radar Test Signal						
Test Signal Name: LP_Signal_29						
Number of Bursts in Trial: 20						
Chirp Center Frequency: 5560MHz						
Burst	Pulse Width (us)	Chirp Width (MHz)	Number of Pulses per Burst	PRI-1 (us)	PRI-2 (us)	PRI-3 (us)
1	69.6	20	2	1161.0	1162.0	-
2	74.4	20	2	1607.0	1272.0	-
3	66.4	20	1	1866.0	-	-
4	71.7	20	2	1089.0	1470.0	-
5	50.2	20	1	1503.0	-	-
6	63.4	20	1	1762.0	-	-
7	57.4	20	1	1595.0	-	-
8	64.3	20	1	1003.0	-	-
9	54.6	20	1	1476.0	-	-
10	81.9	20	2	1154.0	1488.0	-
11	62.8	20	1	1942.0	-	-
12	58.8	20	1	1825.0	-	-
13	96.0	20	3	1173.0	1116.0	1095.0
14	76.8	20	2	1024.0	1210.0	-
15	51.9	20	1	1463.0	-	-
16	71.7	20	2	1286.0	1121.0	-
17	80.9	20	2	1756.0	1398.0	-
18	64.9	20	1	1805.0	-	-

19	92.5	20	3	1801.0	1367.0	1594.0
20	91.7	20	3	1559.0	1620.0	1122.0

Long Pulse Radar Test Signal

Test Signal Name: LP\_Signal\_30

Number of Bursts in Trial: 14

Chirp Center Frequency: 5562.8MHz

Burst	Pulse Width (us)	Chirp Width (MHz)	Number of Pulses per Burst	PRI-1 (us)	PRI-2 (us)	PRI-3 (us)
1	95.8	13	3	1915.0	1214.0	1551.0
2	67.3	13	2	1979.0	1128.0	-
3	70.5	13	2	1920.0	1339.0	-
4	75.7	13	2	1000.0	1734.0	-
5	73.0	13	2	1149.0	1591.0	-
6	61.8	13	1	1681.0	-	-
7	52.4	13	1	1567.0	-	-
8	75.8	13	2	2000.0	1886.0	-
9	54.8	13	1	1117.0	-	-
10	91.6	13	3	1233.0	1004.0	1413.0
11	89.5	13	3	1416.0	1329.0	1007.0
12	86.0	13	3	1614.0	1557.0	1822.0
13	83.0	13	2	1863.0	1282.0	-
14	74.4	13	2	1269.0	1617.0	-



Type 6 Radar Statistical Performances				
Trial #	Pulses per Burst	Pulse Width ( $\mu$ sec)	PRI ( $\mu$ sec)	Detection
1	9	1	333.3	Yes
2	9	1	333.3	Yes
3	9	1	333.3	Yes
4	9	1	333.3	Yes
5	9	1	333.3	Yes
6	9	1	333.3	Yes
7	9	1	333.3	Yes
8	9	1	333.3	Yes
9	9	1	333.3	Yes
10	9	1	333.3	Yes
11	9	1	333.3	Yes
12	9	1	333.3	Yes
13	9	1	333.3	Yes
14	9	1	333.3	Yes
15	9	1	333.3	Yes
16	9	1	333.3	Yes
17	9	1	333.3	Yes
18	9	1	333.3	Yes
19	9	1	333.3	Yes
20	9	1	333.3	Yes
21	9	1	333.3	Yes
22	9	1	333.3	Yes
23	9	1	333.3	Yes
24	9	1	333.3	Yes
25	9	1	333.3	Yes
26	9	1	333.3	Yes
27	9	1	333.3	Yes
28	9	1	333.3	Yes
29	9	1	333.3	Yes
30	9	1	333.3	Yes
				Detection Rate: 100.0 %

Type 6 Radar Statistical Performances		
Trial #	Hopping Frequency Sequence Name	Detection
1	HOP_FREQ_SEQ_01	Yes
2	HOP_FREQ_SEQ_02	Yes
3	HOP_FREQ_SEQ_03	Yes
4	HOP_FREQ_SEQ_04	Yes
5	HOP_FREQ_SEQ_05	Yes
6	HOP_FREQ_SEQ_06	Yes
7	HOP_FREQ_SEQ_07	Yes
8	HOP_FREQ_SEQ_08	Yes
9	HOP_FREQ_SEQ_09	Yes
10	HOP_FREQ_SEQ_10	Yes
11	HOP_FREQ_SEQ_11	Yes
12	HOP_FREQ_SEQ_12	Yes
13	HOP_FREQ_SEQ_13	Yes
14	HOP_FREQ_SEQ_14	Yes
15	HOP_FREQ_SEQ_15	Yes
16	HOP_FREQ_SEQ_16	Yes
17	HOP_FREQ_SEQ_17	Yes
18	HOP_FREQ_SEQ_18	Yes
19	HOP_FREQ_SEQ_19	Yes
20	HOP_FREQ_SEQ_20	Yes
21	HOP_FREQ_SEQ_21	Yes
22	HOP_FREQ_SEQ_22	Yes
23	HOP_FREQ_SEQ_23	Yes
24	HOP_FREQ_SEQ_24	Yes
25	HOP_FREQ_SEQ_25	Yes
26	HOP_FREQ_SEQ_26	Yes
27	HOP_FREQ_SEQ_27	Yes
28	HOP_FREQ_SEQ_28	Yes
29	HOP_FREQ_SEQ_29	Yes
30	HOP_FREQ_SEQ_30	Yes
		Detection Rate: 100.0 %

Hopping Frequency Sequence Name: HOP_FREQ_SEQ_01							
SEQ#	Frequency (Hz)	SEQ#	Frequency (Hz)	SEQ#	Frequency (Hz)	SEQ#	Frequency (Hz)
1	5.540G	2	5.513G	3	5.526G	4	5.574G
5	5.501G	6	5.717G	7	5.590G	8	5.373G
9	5.338G	10	5.534G	11	5.388G	12	5.493G
13	5.447G	14	5.554G	15	5.593G	16	5.566G
17	5.688G	18	5.715G	19	5.350G	20	5.713G
21	5.404G	22	5.374G	23	5.571G	24	5.420G
25	5.588G	26	5.277G	27	5.407G	28	5.610G
29	5.278G	30	5.710G	31	5.366G	32	5.301G
33	5.666G	34	5.551G	35	5.531G	36	5.339G
37	5.410G	38	5.303G	39	5.267G	40	5.538G
41	5.327G	42	5.701G	43	5.358G	44	5.581G
45	5.408G	46	5.584G	47	5.477G	48	5.357G
49	5.703G	50	5.376G	51	5.683G	52	5.413G
53	5.662G	54	5.423G	55	5.632G	56	5.668G
57	5.619G	58	5.281G	59	5.429G	60	5.289G
61	5.306G	62	5.337G	63	5.596G	64	5.286G
65	5.592G	66	5.379G	67	5.362G	68	5.351G
69	5.433G	70	5.271G	71	5.384G	72	5.614G
73	5.504G	74	5.296G	75	5.712G	76	5.452G
77	5.687G	78	5.533G	79	5.599G	80	5.561G
81	5.293G	82	5.300G	83	5.302G	84	5.718G
85	5.291G	86	5.456G	87	5.505G	88	5.636G
89	5.367G	90	5.348G	91	5.527G	92	5.558G
93	5.640G	94	5.559G	95	5.436G	96	5.613G
97	5.472G	98	5.707G	99	5.607G	100	5.680G

Hopping Frequency Sequence Name: HOP_FREQ_SEQ_02							
SEQ#	Frequency (Hz)	SEQ#	Frequency (Hz)	SEQ#	Frequency (Hz)	SEQ#	Frequency (Hz)
1	5.641G	2	5.581G	3	5.679G	4	5.580G
5	5.429G	6	5.315G	7	5.582G	8	5.604G
9	5.353G	10	5.255G	11	5.260G	12	5.425G
13	5.366G	14	5.343G	15	5.478G	16	5.310G
17	5.367G	18	5.288G	19	5.595G	20	5.719G
21	5.514G	22	5.630G	23	5.327G	24	5.606G
25	5.424G	26	5.662G	27	5.482G	28	5.683G
29	5.528G	30	5.289G	31	5.700G	32	5.541G
33	5.356G	34	5.585G	35	5.506G	36	5.297G
37	5.391G	38	5.505G	39	5.511G	40	5.333G
41	5.292G	42	5.572G	43	5.329G	44	5.553G
45	5.408G	46	5.612G	47	5.532G	48	5.423G
49	5.594G	50	5.495G	51	5.499G	52	5.607G
53	5.706G	54	5.525G	55	5.692G	56	5.390G
57	5.576G	58	5.270G	59	5.549G	60	5.468G
61	5.407G	62	5.455G	63	5.448G	64	5.565G
65	5.687G	66	5.656G	67	5.335G	68	5.649G
69	5.360G	70	5.349G	71	5.504G	72	5.661G
73	5.422G	74	5.328G	75	5.311G	76	5.307G
77	5.669G	78	5.561G	79	5.521G	80	5.342G
81	5.337G	82	5.518G	83	5.441G	84	5.436G
85	5.682G	86	5.562G	87	5.466G	88	5.539G
89	5.372G	90	5.534G	91	5.284G	92	5.537G
93	5.701G	94	5.384G	95	5.251G	96	5.445G
97	5.473G	98	5.388G	99	5.280G	100	5.285G

Hopping Frequency Sequence Name: HOP_FREQ_SEQ_03							
SEQ#	Frequency (Hz)	SEQ#	Frequency (Hz)	SEQ#	Frequency (Hz)	SEQ#	Frequency (Hz)
1	5.284G	2	5.304G	3	5.456G	4	5.489G
5	5.670G	6	5.409G	7	5.574G	8	5.448G
9	5.581G	10	5.467G	11	5.637G	12	5.651G
13	5.641G	14	5.407G	15	5.281G	16	5.321G
17	5.428G	18	5.355G	19	5.260G	20	5.276G
21	5.435G	22	5.640G	23	5.683G	24	5.333G
25	5.382G	26	5.712G	27	5.391G	28	5.401G
29	5.554G	30	5.383G	31	5.261G	32	5.315G
33	5.563G	34	5.326G	35	5.652G	36	5.393G
37	5.280G	38	5.352G	39	5.588G	40	5.595G
41	5.498G	42	5.618G	43	5.596G	44	5.307G
45	5.720G	46	5.495G	47	5.542G	48	5.469G
49	5.617G	50	5.623G	51	5.723G	52	5.440G
53	5.350G	54	5.338G	55	5.332G	56	5.602G
57	5.277G	58	5.367G	59	5.572G	60	5.611G
61	5.294G	62	5.584G	63	5.529G	64	5.678G
65	5.501G	66	5.267G	67	5.536G	68	5.301G
69	5.516G	70	5.650G	71	5.664G	72	5.662G
73	5.263G	74	5.458G	75	5.528G	76	5.707G
77	5.717G	78	5.418G	79	5.560G	80	5.604G
81	5.644G	82	5.396G	83	5.416G	84	5.514G
85	5.526G	86	5.699G	87	5.443G	88	5.674G
89	5.411G	90	5.671G	91	5.510G	92	5.257G
93	5.436G	94	5.424G	95	5.459G	96	5.273G
97	5.685G	98	5.463G	99	5.288G	100	5.275G

Hopping Frequency Sequence Name: HOP_FREQ_SEQ_04							
SEQ#	Frequency (Hz)	SEQ#	Frequency (Hz)	SEQ#	Frequency (Hz)	SEQ#	Frequency (Hz)
1	5.278G	2	5.505G	3	5.563G	4	5.422G
5	5.685G	6	5.270G	7	5.545G	8	5.321G
9	5.641G	10	5.680G	11	5.568G	12	5.284G
13	5.675G	14	5.542G	15	5.406G	16	5.426G
17	5.346G	18	5.327G	19	5.558G	20	5.423G
21	5.285G	22	5.434G	23	5.720G	24	5.538G
25	5.357G	26	5.286G	27	5.362G	28	5.522G
29	5.520G	30	5.438G	31	5.418G	32	5.448G
33	5.605G	34	5.451G	35	5.516G	36	5.319G
37	5.694G	38	5.671G	39	5.518G	40	5.553G
41	5.252G	42	5.395G	43	5.482G	44	5.419G
45	5.397G	46	5.716G	47	5.349G	48	5.661G
49	5.296G	50	5.693G	51	5.414G	52	5.670G
53	5.356G	54	5.527G	55	5.704G	56	5.566G
57	5.429G	58	5.592G	59	5.353G	60	5.361G
61	5.475G	62	5.636G	63	5.508G	64	5.718G
65	5.484G	66	5.405G	67	5.348G	68	5.650G
69	5.412G	70	5.607G	71	5.294G	72	5.721G
73	5.565G	74	5.379G	75	5.279G	76	5.433G
77	5.578G	78	5.610G	79	5.477G	80	5.571G
81	5.276G	82	5.495G	83	5.308G	84	5.698G
85	5.572G	86	5.398G	87	5.387G	88	5.597G
89	5.688G	90	5.590G	91	5.485G	92	5.497G
93	5.253G	94	5.617G	95	5.632G	96	5.363G
97	5.628G	98	5.376G	99	5.282G	100	5.490G

Hopping Frequency Sequence Name: HOP_FREQ_SEQ_05							
SEQ#	Frequency (Hz)	SEQ#	Frequency (Hz)	SEQ#	Frequency (Hz)	SEQ#	Frequency (Hz)
1	5.535G	2	5.444G	3	5.468G	4	5.719G
5	5.264G	6	5.349G	7	5.554G	8	5.387G
9	5.462G	10	5.632G	11	5.490G	12	5.478G
13	5.340G	14	5.494G	15	5.323G	16	5.320G
17	5.560G	18	5.435G	19	5.367G	20	5.544G
21	5.519G	22	5.401G	23	5.616G	24	5.485G
25	5.477G	26	5.482G	27	5.669G	28	5.553G
29	5.682G	30	5.308G	31	5.293G	32	5.496G
33	5.480G	34	5.593G	35	5.268G	36	5.324G
37	5.657G	38	5.587G	39	5.712G	40	5.635G
41	5.473G	42	5.441G	43	5.442G	44	5.649G
45	5.597G	46	5.517G	47	5.279G	48	5.454G
49	5.689G	50	5.456G	51	5.529G	52	5.391G
53	5.515G	54	5.350G	55	5.434G	56	5.505G
57	5.539G	58	5.582G	59	5.604G	60	5.370G
61	5.413G	62	5.414G	63	5.285G	64	5.605G
65	5.648G	66	5.345G	67	5.489G	68	5.671G
69	5.540G	70	5.289G	71	5.598G	72	5.542G
73	5.636G	74	5.381G	75	5.347G	76	5.522G
77	5.711G	78	5.693G	79	5.319G	80	5.431G
81	5.501G	82	5.486G	83	5.280G	84	5.647G
85	5.398G	86	5.259G	87	5.570G	88	5.504G
89	5.558G	90	5.426G	91	5.706G	92	5.291G
93	5.253G	94	5.662G	95	5.362G	96	5.667G
97	5.590G	98	5.569G	99	5.531G	100	5.405G

Hopping Frequency Sequence Name: HOP_FREQ_SEQ_06							
SEQ#	Frequency (Hz)	SEQ#	Frequency (Hz)	SEQ#	Frequency (Hz)	SEQ#	Frequency (Hz)
1	5.642G	2	5.685G	3	5.613G	4	5.701G
5	5.526G	6	5.604G	7	5.329G	8	5.551G
9	5.624G	10	5.389G	11	5.696G	12	5.599G
13	5.323G	14	5.274G	15	5.293G	16	5.416G
17	5.720G	18	5.453G	19	5.655G	20	5.608G
21	5.344G	22	5.349G	23	5.399G	24	5.605G
25	5.326G	26	5.693G	27	5.674G	28	5.255G
29	5.370G	30	5.285G	31	5.666G	32	5.578G
33	5.260G	34	5.275G	35	5.409G	36	5.715G
37	5.660G	38	5.460G	39	5.324G	40	5.509G
41	5.712G	42	5.312G	43	5.480G	44	5.375G
45	5.681G	46	5.631G	47	5.714G	48	5.512G
49	5.445G	50	5.514G	51	5.354G	52	5.483G
53	5.490G	54	5.654G	55	5.386G	56	5.291G
57	5.476G	58	5.716G	59	5.362G	60	5.265G
61	5.680G	62	5.439G	63	5.541G	64	5.573G
65	5.682G	66	5.644G	67	5.414G	68	5.422G
69	5.668G	70	5.677G	71	5.609G	72	5.705G
73	5.473G	74	5.517G	75	5.482G	76	5.549G
77	5.360G	78	5.485G	79	5.684G	80	5.317G
81	5.264G	82	5.711G	83	5.355G	84	5.596G
85	5.300G	86	5.592G	87	5.303G	88	5.594G
89	5.579G	90	5.649G	91	5.340G	92	5.667G
93	5.643G	94	5.575G	95	5.396G	96	5.436G
97	5.437G	98	5.408G	99	5.561G	100	5.421G



Hopping Frequency Sequence Name: HOP_FREQ_SEQ_07							
SEQ#	Frequency (Hz)	SEQ#	Frequency (Hz)	SEQ#	Frequency (Hz)	SEQ#	Frequency (Hz)
1	5.597G	2	5.360G	3	5.666G	4	5.431G
5	5.587G	6	5.521G	7	5.471G	8	5.553G
9	5.676G	10	5.338G	11	5.722G	12	5.347G
13	5.458G	14	5.498G	15	5.620G	16	5.641G
17	5.596G	18	5.295G	19	5.317G	20	5.605G
21	5.532G	22	5.650G	23	5.558G	24	5.700G
25	5.495G	26	5.481G	27	5.485G	28	5.390G
29	5.656G	30	5.648G	31	5.365G	32	5.708G
33	5.371G	34	5.441G	35	5.702G	36	5.504G
37	5.261G	38	5.398G	39	5.392G	40	5.572G
41	5.683G	42	5.567G	43	5.585G	44	5.623G
45	5.569G	46	5.256G	47	5.505G	48	5.649G
49	5.426G	50	5.264G	51	5.640G	52	5.690G
53	5.520G	54	5.466G	55	5.593G	56	5.568G
57	5.325G	58	5.383G	59	5.300G	60	5.389G
61	5.469G	62	5.253G	63	5.285G	64	5.724G
65	5.538G	66	5.467G	67	5.519G	68	5.686G
69	5.539G	70	5.313G	71	5.713G	72	5.312G
73	5.654G	74	5.299G	75	5.446G	76	5.366G
77	5.320G	78	5.479G	79	5.492G	80	5.340G
81	5.548G	82	5.671G	83	5.698G	84	5.674G
85	5.343G	86	5.710G	87	5.443G	88	5.503G
89	5.599G	90	5.474G	91	5.502G	92	5.437G
93	5.263G	94	5.604G	95	5.393G	96	5.372G
97	5.369G	98	5.262G	99	5.711G	100	5.527G

Hopping Frequency Sequence Name: HOP_FREQ_SEQ_08							
SEQ#	Frequency (Hz)	SEQ#	Frequency (Hz)	SEQ#	Frequency (Hz)	SEQ#	Frequency (Hz)
1	5.667G	2	5.626G	3	5.314G	4	5.440G
5	5.527G	6	5.365G	7	5.653G	8	5.652G
9	5.469G	10	5.694G	11	5.496G	12	5.634G
13	5.517G	14	5.354G	15	5.481G	16	5.505G
17	5.292G	18	5.254G	19	5.569G	20	5.649G
21	5.433G	22	5.604G	23	5.404G	24	5.349G
25	5.416G	26	5.551G	27	5.603G	28	5.561G
29	5.386G	30	5.648G	31	5.369G	32	5.252G
33	5.635G	34	5.605G	35	5.399G	36	5.485G
37	5.391G	38	5.641G	39	5.518G	40	5.607G
41	5.529G	42	5.590G	43	5.520G	44	5.514G
45	5.409G	46	5.336G	47	5.567G	48	5.679G
49	5.698G	50	5.594G	51	5.564G	52	5.419G
53	5.657G	54	5.668G	55	5.689G	56	5.306G
57	5.385G	58	5.278G	59	5.688G	60	5.423G
61	5.674G	62	5.536G	63	5.544G	64	5.435G
65	5.251G	66	5.601G	67	5.438G	68	5.280G
69	5.260G	70	5.288G	71	5.711G	72	5.389G
73	5.640G	74	5.556G	75	5.664G	76	5.718G
77	5.677G	78	5.651G	79	5.277G	80	5.420G
81	5.300G	82	5.683G	83	5.573G	84	5.702G
85	5.256G	86	5.684G	87	5.533G	88	5.362G
89	5.443G	90	5.712G	91	5.612G	92	5.606G
93	5.491G	94	5.364G	95	5.338G	96	5.417G
97	5.428G	98	5.553G	99	5.595G	100	5.583G

Hopping Frequency Sequence Name: HOP_FREQ_SEQ_09							
SEQ#	Frequency (Hz)	SEQ#	Frequency (Hz)	SEQ#	Frequency (Hz)	SEQ#	Frequency (Hz)
1	5.652G	2	5.260G	3	5.508G	4	5.643G
5	5.653G	6	5.659G	7	5.381G	8	5.683G
9	5.724G	10	5.711G	11	5.577G	12	5.333G
13	5.682G	14	5.307G	15	5.258G	16	5.603G
17	5.605G	18	5.534G	19	5.520G	20	5.491G
21	5.367G	22	5.672G	23	5.355G	24	5.372G
25	5.651G	26	5.541G	27	5.274G	28	5.666G
29	5.498G	30	5.336G	31	5.420G	32	5.701G
33	5.496G	34	5.707G	35	5.361G	36	5.608G
37	5.582G	38	5.631G	39	5.289G	40	5.386G
41	5.568G	42	5.671G	43	5.455G	44	5.279G
45	5.558G	46	5.595G	47	5.363G	48	5.352G
49	5.549G	50	5.434G	51	5.602G	52	5.362G
53	5.379G	54	5.419G	55	5.554G	56	5.686G
57	5.366G	58	5.516G	59	5.285G	60	5.405G
61	5.319G	62	5.596G	63	5.394G	64	5.385G
65	5.356G	66	5.300G	67	5.641G	68	5.280G
69	5.332G	70	5.626G	71	5.674G	72	5.295G
73	5.664G	74	5.600G	75	5.523G	76	5.440G
77	5.286G	78	5.490G	79	5.259G	80	5.593G
81	5.531G	82	5.634G	83	5.489G	84	5.559G
85	5.527G	86	5.578G	87	5.322G	88	5.589G
89	5.709G	90	5.525G	91	5.535G	92	5.537G
93	5.636G	94	5.521G	95	5.323G	96	5.716G
97	5.611G	98	5.632G	99	5.282G	100	5.598G

Hopping Frequency Sequence Name: HOP_FREQ_SEQ_10							
SEQ#	Frequency (Hz)	SEQ#	Frequency (Hz)	SEQ#	Frequency (Hz)	SEQ#	Frequency (Hz)
1	5.448G	2	5.353G	3	5.542G	4	5.384G
5	5.676G	6	5.609G	7	5.518G	8	5.454G
9	5.662G	10	5.516G	11	5.357G	12	5.406G
13	5.491G	14	5.438G	15	5.408G	16	5.263G
17	5.625G	18	5.559G	19	5.652G	20	5.280G
21	5.577G	22	5.254G	23	5.556G	24	5.472G
25	5.672G	26	5.282G	27	5.639G	28	5.527G
29	5.612G	30	5.569G	31	5.555G	32	5.630G
33	5.347G	34	5.607G	35	5.647G	36	5.425G
37	5.422G	38	5.329G	39	5.501G	40	5.704G
41	5.364G	42	5.374G	43	5.702G	44	5.554G
45	5.644G	46	5.277G	47	5.626G	48	5.418G
49	5.587G	50	5.604G	51	5.677G	52	5.558G
53	5.568G	54	5.534G	55	5.497G	56	5.401G
57	5.252G	58	5.466G	59	5.571G	60	5.584G
61	5.714G	62	5.682G	63	5.552G	64	5.610G
65	5.597G	66	5.392G	67	5.370G	68	5.456G
69	5.316G	70	5.274G	71	5.506G	72	5.523G
73	5.537G	74	5.533G	75	5.546G	76	5.645G
77	5.276G	78	5.505G	79	5.484G	80	5.684G
81	5.679G	82	5.259G	83	5.285G	84	5.668G
85	5.723G	86	5.656G	87	5.673G	88	5.255G
89	5.594G	90	5.339G	91	5.268G	92	5.502G
93	5.496G	94	5.503G	95	5.323G	96	5.273G
97	5.342G	98	5.711G	99	5.410G	100	5.661G

Hopping Frequency Sequence Name: HOP_FREQ_SEQ_11							
SEQ#	Frequency (Hz)	SEQ#	Frequency (Hz)	SEQ#	Frequency (Hz)	SEQ#	Frequency (Hz)
1	5.407G	2	5.441G	3	5.498G	4	5.515G
5	5.358G	6	5.316G	7	5.659G	8	5.695G
9	5.542G	10	5.393G	11	5.592G	12	5.682G
13	5.332G	14	5.675G	15	5.608G	16	5.588G
17	5.578G	18	5.291G	19	5.614G	20	5.282G
21	5.648G	22	5.476G	23	5.273G	24	5.312G
25	5.697G	26	5.658G	27	5.349G	28	5.600G
29	5.279G	30	5.431G	31	5.484G	32	5.372G
33	5.283G	34	5.378G	35	5.401G	36	5.505G
37	5.471G	38	5.295G	39	5.470G	40	5.341G
41	5.669G	42	5.366G	43	5.290G	44	5.475G
45	5.549G	46	5.633G	47	5.430G	48	5.539G
49	5.425G	50	5.387G	51	5.511G	52	5.373G
53	5.514G	54	5.634G	55	5.297G	56	5.461G
57	5.392G	58	5.516G	59	5.270G	60	5.280G
61	5.427G	62	5.570G	63	5.289G	64	5.310G
65	5.411G	66	5.412G	67	5.711G	68	5.568G
69	5.386G	70	5.655G	71	5.409G	72	5.374G
73	5.437G	74	5.302G	75	5.617G	76	5.572G
77	5.370G	78	5.667G	79	5.601G	80	5.447G
81	5.551G	82	5.525G	83	5.292G	84	5.481G
85	5.571G	86	5.605G	87	5.395G	88	5.496G
89	5.402G	90	5.644G	91	5.631G	92	5.432G
93	5.694G	94	5.662G	95	5.540G	96	5.489G
97	5.463G	98	5.521G	99	5.486G	100	5.616G

Hopping Frequency Sequence Name: HOP_FREQ_SEQ_12							
SEQ#	Frequency (Hz)	SEQ#	Frequency (Hz)	SEQ#	Frequency (Hz)	SEQ#	Frequency (Hz)
1	5.544G	2	5.339G	3	5.529G	4	5.472G
5	5.508G	6	5.431G	7	5.596G	8	5.270G
9	5.327G	10	5.379G	11	5.662G	12	5.462G
13	5.273G	14	5.617G	15	5.651G	16	5.377G
17	5.686G	18	5.415G	19	5.488G	20	5.380G
21	5.351G	22	5.688G	23	5.260G	24	5.530G
25	5.589G	26	5.703G	27	5.632G	28	5.609G
29	5.333G	30	5.286G	31	5.507G	32	5.693G
33	5.664G	34	5.582G	35	5.461G	36	5.358G
37	5.667G	38	5.555G	39	5.367G	40	5.570G
41	5.711G	42	5.372G	43	5.537G	44	5.267G
45	5.301G	46	5.585G	47	5.288G	48	5.583G
49	5.398G	50	5.421G	51	5.291G	52	5.445G
53	5.541G	54	5.504G	55	5.384G	56	5.299G
57	5.543G	58	5.556G	59	5.496G	60	5.477G
61	5.423G	62	5.678G	63	5.624G	64	5.353G
65	5.413G	66	5.296G	67	5.706G	68	5.685G
69	5.473G	70	5.722G	71	5.424G	72	5.525G
73	5.674G	74	5.359G	75	5.325G	76	5.489G
77	5.614G	78	5.622G	79	5.294G	80	5.573G
81	5.494G	82	5.326G	83	5.394G	84	5.482G
85	5.650G	86	5.435G	87	5.659G	88	5.400G
89	5.637G	90	5.355G	91	5.258G	92	5.449G
93	5.718G	94	5.676G	95	5.447G	96	5.549G
97	5.640G	98	5.645G	99	5.276G	100	5.533G

Hopping Frequency Sequence Name: HOP_FREQ_SEQ_13							
SEQ#	Frequency (Hz)	SEQ#	Frequency (Hz)	SEQ#	Frequency (Hz)	SEQ#	Frequency (Hz)
1	5.358G	2	5.430G	3	5.615G	4	5.653G
5	5.439G	6	5.310G	7	5.399G	8	5.722G
9	5.721G	10	5.494G	11	5.352G	12	5.449G
13	5.538G	14	5.337G	15	5.438G	16	5.262G
17	5.307G	18	5.409G	19	5.503G	20	5.419G
21	5.487G	22	5.282G	23	5.417G	24	5.295G
25	5.644G	26	5.622G	27	5.383G	28	5.334G
29	5.692G	30	5.658G	31	5.598G	32	5.372G
33	5.573G	34	5.576G	35	5.491G	36	5.621G
37	5.380G	38	5.586G	39	5.527G	40	5.698G
41	5.342G	42	5.275G	43	5.492G	44	5.630G
45	5.529G	46	5.724G	47	5.269G	48	5.411G
49	5.474G	50	5.608G	51	5.553G	52	5.602G
53	5.429G	54	5.478G	55	5.312G	56	5.318G
57	5.673G	58	5.297G	59	5.369G	60	5.377G
61	5.375G	62	5.285G	63	5.558G	64	5.260G
65	5.390G	66	5.268G	67	5.656G	68	5.370G
69	5.596G	70	5.605G	71	5.591G	72	5.629G
73	5.506G	74	5.351G	75	5.281G	76	5.336G
77	5.524G	78	5.521G	79	5.461G	80	5.367G
81	5.296G	82	5.347G	83	5.435G	84	5.329G
85	5.340G	86	5.299G	87	5.680G	88	5.448G
89	5.261G	90	5.510G	91	5.265G	92	5.555G
93	5.595G	94	5.457G	95	5.280G	96	5.359G
97	5.410G	98	5.509G	99	5.379G	100	5.447G

Hopping Frequency Sequence Name: HOP_FREQ_SEQ_14							
SEQ#	Frequency (Hz)	SEQ#	Frequency (Hz)	SEQ#	Frequency (Hz)	SEQ#	Frequency (Hz)
1	5.393G	2	5.673G	3	5.362G	4	5.390G
5	5.528G	6	5.625G	7	5.315G	8	5.383G
9	5.653G	10	5.342G	11	5.572G	12	5.613G
13	5.252G	14	5.520G	15	5.685G	16	5.292G
17	5.268G	18	5.450G	19	5.259G	20	5.674G
21	5.321G	22	5.371G	23	5.531G	24	5.381G
25	5.284G	26	5.403G	27	5.599G	28	5.549G
29	5.400G	30	5.482G	31	5.281G	32	5.454G
33	5.689G	34	5.290G	35	5.481G	36	5.540G
37	5.571G	38	5.368G	39	5.440G	40	5.555G
41	5.607G	42	5.399G	43	5.713G	44	5.301G
45	5.423G	46	5.369G	47	5.445G	48	5.566G
49	5.574G	50	5.724G	51	5.639G	52	5.406G
53	5.407G	54	5.543G	55	5.476G	56	5.660G
57	5.633G	58	5.700G	59	5.417G	60	5.439G
61	5.589G	62	5.585G	63	5.435G	64	5.500G
65	5.715G	66	5.280G	67	5.697G	68	5.366G
69	5.442G	70	5.558G	71	5.286G	72	5.448G
73	5.716G	74	5.508G	75	5.634G	76	5.488G
77	5.657G	78	5.554G	79	5.461G	80	5.721G
81	5.517G	82	5.269G	83	5.584G	84	5.693G
85	5.587G	86	5.502G	87	5.431G	88	5.405G
89	5.272G	90	5.707G	91	5.667G	92	5.418G
93	5.662G	94	5.387G	95	5.610G	96	5.536G
97	5.485G	98	5.605G	99	5.526G	100	5.279G



Hopping Frequency Sequence Name: HOP_FREQ_SEQ_15							
SEQ#	Frequency (Hz)	SEQ#	Frequency (Hz)	SEQ#	Frequency (Hz)	SEQ#	Frequency (Hz)
1	5.293G	2	5.401G	3	5.260G	4	5.640G
5	5.308G	6	5.684G	7	5.527G	8	5.417G
9	5.419G	10	5.660G	11	5.495G	12	5.628G
13	5.363G	14	5.470G	15	5.517G	16	5.412G
17	5.446G	18	5.302G	19	5.567G	20	5.712G
21	5.272G	22	5.335G	23	5.582G	24	5.500G
25	5.311G	26	5.550G	27	5.378G	28	5.601G
29	5.671G	30	5.667G	31	5.452G	32	5.271G
33	5.283G	34	5.719G	35	5.536G	36	5.652G
37	5.526G	38	5.481G	39	5.657G	40	5.254G
41	5.343G	42	5.505G	43	5.542G	44	5.483G
45	5.342G	46	5.259G	47	5.710G	48	5.545G
49	5.410G	50	5.516G	51	5.489G	52	5.696G
53	5.512G	54	5.554G	55	5.571G	56	5.433G
57	5.445G	58	5.634G	59	5.345G	60	5.434G
61	5.716G	62	5.613G	63	5.541G	64	5.268G
65	5.282G	66	5.252G	67	5.442G	68	5.488G
69	5.703G	70	5.586G	71	5.349G	72	5.544G
73	5.325G	74	5.514G	75	5.456G	76	5.508G
77	5.403G	78	5.387G	79	5.406G	80	5.653G
81	5.497G	82	5.454G	83	5.307G	84	5.430G
85	5.377G	86	5.431G	87	5.382G	88	5.539G
89	5.251G	90	5.420G	91	5.638G	92	5.676G
93	5.592G	94	5.579G	95	5.463G	96	5.678G
97	5.262G	98	5.364G	99	5.388G	100	5.261G

Hopping Frequency Sequence Name: HOP_FREQ_SEQ_16							
SEQ#	Frequency (Hz)	SEQ#	Frequency (Hz)	SEQ#	Frequency (Hz)	SEQ#	Frequency (Hz)
1	5.700G	2	5.350G	3	5.410G	4	5.401G
5	5.669G	6	5.409G	7	5.462G	8	5.338G
9	5.266G	10	5.526G	11	5.681G	12	5.337G
13	5.420G	14	5.267G	15	5.516G	16	5.629G
17	5.389G	18	5.299G	19	5.490G	20	5.398G
21	5.380G	22	5.418G	23	5.523G	24	5.655G
25	5.360G	26	5.328G	27	5.397G	28	5.639G
29	5.417G	30	5.423G	31	5.540G	32	5.342G
33	5.656G	34	5.296G	35	5.491G	36	5.635G
37	5.395G	38	5.255G	39	5.556G	40	5.254G
41	5.278G	42	5.648G	43	5.295G	44	5.576G
45	5.686G	46	5.569G	47	5.439G	48	5.476G
49	5.614G	50	5.422G	51	5.336G	52	5.367G
53	5.259G	54	5.461G	55	5.566G	56	5.702G
57	5.345G	58	5.307G	59	5.319G	60	5.289G
61	5.517G	62	5.281G	63	5.581G	64	5.673G
65	5.489G	66	5.339G	67	5.436G	68	5.352G
69	5.440G	70	5.634G	71	5.504G	72	5.411G
73	5.407G	74	5.625G	75	5.601G	76	5.678G
77	5.671G	78	5.282G	79	5.710G	80	5.324G
81	5.264G	82	5.536G	83	5.633G	84	5.499G
85	5.271G	86	5.568G	87	5.559G	88	5.644G
89	5.514G	90	5.664G	91	5.326G	92	5.294G
93	5.646G	94	5.315G	95	5.340G	96	5.408G
97	5.638G	98	5.599G	99	5.670G	100	5.561G

Hopping Frequency Sequence Name: HOP_FREQ_SEQ_17							
SEQ#	Frequency (Hz)	SEQ#	Frequency (Hz)	SEQ#	Frequency (Hz)	SEQ#	Frequency (Hz)
1	5.563G	2	5.478G	3	5.723G	4	5.319G
5	5.374G	6	5.492G	7	5.469G	8	5.292G
9	5.525G	10	5.252G	11	5.350G	12	5.608G
13	5.323G	14	5.681G	15	5.388G	16	5.545G
17	5.291G	18	5.517G	19	5.253G	20	5.383G
21	5.489G	22	5.654G	23	5.704G	24	5.616G
25	5.621G	26	5.593G	27	5.435G	28	5.332G
29	5.420G	30	5.375G	31	5.587G	32	5.610G
33	5.498G	34	5.376G	35	5.661G	36	5.596G
37	5.413G	38	5.269G	39	5.701G	40	5.510G
41	5.266G	42	5.626G	43	5.516G	44	5.483G
45	5.467G	46	5.518G	47	5.586G	48	5.255G
49	5.512G	50	5.315G	51	5.639G	52	5.316G
53	5.667G	54	5.625G	55	5.495G	56	5.560G
57	5.455G	58	5.286G	59	5.324G	60	5.678G
61	5.555G	62	5.594G	63	5.662G	64	5.505G
65	5.320G	66	5.685G	67	5.282G	68	5.335G
69	5.677G	70	5.585G	71	5.526G	72	5.670G
73	5.400G	74	5.541G	75	5.488G	76	5.477G
77	5.480G	78	5.507G	79	5.449G	80	5.385G
81	5.473G	82	5.412G	83	5.714G	84	5.549G
85	5.690G	86	5.295G	87	5.619G	88	5.683G
89	5.411G	90	5.343G	91	5.664G	92	5.637G
93	5.351G	94	5.285G	95	5.691G	96	5.554G
97	5.415G	98	5.530G	99	5.692G	100	5.452G

Hopping Frequency Sequence Name: HOP_FREQ_SEQ_18							
SEQ#	Frequency (Hz)	SEQ#	Frequency (Hz)	SEQ#	Frequency (Hz)	SEQ#	Frequency (Hz)
1	5.497G	2	5.599G	3	5.670G	4	5.665G
5	5.351G	6	5.278G	7	5.388G	8	5.600G
9	5.263G	10	5.572G	11	5.364G	12	5.532G
13	5.643G	14	5.487G	15	5.486G	16	5.631G
17	5.515G	18	5.492G	19	5.373G	20	5.442G
21	5.358G	22	5.293G	23	5.562G	24	5.355G
25	5.496G	26	5.467G	27	5.679G	28	5.707G
29	5.607G	30	5.513G	31	5.489G	32	5.485G
33	5.320G	34	5.418G	35	5.621G	36	5.416G
37	5.522G	38	5.407G	39	5.303G	40	5.357G
41	5.378G	42	5.542G	43	5.678G	44	5.452G
45	5.574G	46	5.449G	47	5.546G	48	5.610G
49	5.434G	50	5.613G	51	5.650G	52	5.469G
53	5.281G	54	5.608G	55	5.524G	56	5.529G
57	5.428G	58	5.661G	59	5.544G	60	5.512G
61	5.393G	62	5.411G	63	5.471G	64	5.462G
65	5.504G	66	5.399G	67	5.638G	68	5.298G
69	5.395G	70	5.553G	71	5.273G	72	5.578G
73	5.463G	74	5.423G	75	5.307G	76	5.516G
77	5.507G	78	5.480G	79	5.360G	80	5.721G
81	5.598G	82	5.376G	83	5.494G	84	5.398G
85	5.595G	86	5.521G	87	5.305G	88	5.446G
89	5.275G	90	5.443G	91	5.316G	92	5.437G
93	5.549G	94	5.693G	95	5.269G	96	5.295G
97	5.668G	98	5.586G	99	5.719G	100	5.615G

Hopping Frequency Sequence Name: HOP_FREQ_SEQ_19							
SEQ#	Frequency (Hz)	SEQ#	Frequency (Hz)	SEQ#	Frequency (Hz)	SEQ#	Frequency (Hz)
1	5.691G	2	5.551G	3	5.579G	4	5.350G
5	5.688G	6	5.622G	7	5.294G	8	5.547G
9	5.460G	10	5.446G	11	5.270G	12	5.541G
13	5.620G	14	5.571G	15	5.384G	16	5.633G
17	5.477G	18	5.503G	19	5.553G	20	5.629G
21	5.472G	22	5.542G	23	5.528G	24	5.544G
25	5.613G	26	5.700G	27	5.434G	28	5.358G
29	5.525G	30	5.305G	31	5.644G	32	5.516G
33	5.648G	34	5.684G	35	5.488G	36	5.478G
37	5.498G	38	5.335G	39	5.441G	40	5.361G
41	5.411G	42	5.420G	43	5.396G	44	5.515G
45	5.353G	46	5.266G	47	5.451G	48	5.386G
49	5.617G	50	5.588G	51	5.374G	52	5.532G
53	5.666G	54	5.669G	55	5.314G	56	5.431G
57	5.520G	58	5.306G	59	5.272G	60	5.279G
61	5.634G	62	5.654G	63	5.619G	64	5.504G
65	5.334G	66	5.685G	67	5.690G	68	5.646G
69	5.575G	70	5.641G	71	5.297G	72	5.282G
73	5.713G	74	5.479G	75	5.663G	76	5.695G
77	5.492G	78	5.493G	79	5.668G	80	5.327G
81	5.288G	82	5.296G	83	5.413G	84	5.511G
85	5.486G	86	5.597G	87	5.286G	88	5.661G
89	5.421G	90	5.405G	91	5.536G	92	5.719G
93	5.518G	94	5.590G	95	5.608G	96	5.408G
97	5.582G	98	5.303G	99	5.449G	100	5.414G

Hopping Frequency Sequence Name: HOP_FREQ_SEQ_20							
SEQ#	Frequency (Hz)	SEQ#	Frequency (Hz)	SEQ#	Frequency (Hz)	SEQ#	Frequency (Hz)
1	5.680G	2	5.483G	3	5.416G	4	5.549G
5	5.475G	6	5.321G	7	5.633G	8	5.278G
9	5.311G	10	5.524G	11	5.678G	12	5.521G
13	5.605G	14	5.367G	15	5.691G	16	5.672G
17	5.370G	18	5.504G	19	5.488G	20	5.433G
21	5.465G	22	5.282G	23	5.266G	24	5.701G
25	5.709G	26	5.267G	27	5.445G	28	5.385G
29	5.623G	30	5.299G	31	5.419G	32	5.707G
33	5.617G	34	5.322G	35	5.498G	36	5.632G
37	5.649G	38	5.546G	39	5.446G	40	5.541G
41	5.599G	42	5.630G	43	5.256G	44	5.568G
45	5.566G	46	5.537G	47	5.534G	48	5.277G
49	5.618G	50	5.374G	51	5.455G	52	5.283G
53	5.564G	54	5.312G	55	5.693G	56	5.436G
57	5.338G	58	5.372G	59	5.272G	60	5.369G
61	5.696G	62	5.507G	63	5.695G	64	5.529G
65	5.317G	66	5.384G	67	5.297G	68	5.494G
69	5.366G	70	5.705G	71	5.300G	72	5.715G
73	5.481G	74	5.287G	75	5.698G	76	5.301G
77	5.655G	78	5.670G	79	5.264G	80	5.420G
81	5.262G	82	5.676G	83	5.683G	84	5.394G
85	5.540G	86	5.337G	87	5.326G	88	5.431G
89	5.381G	90	5.505G	91	5.515G	92	5.275G
93	5.408G	94	5.690G	95	5.306G	96	5.359G
97	5.427G	98	5.342G	99	5.356G	100	5.462G

Hopping Frequency Sequence Name: HOP_FREQ_SEQ_21							
SEQ#	Frequency (Hz)	SEQ#	Frequency (Hz)	SEQ#	Frequency (Hz)	SEQ#	Frequency (Hz)
1	5.600G	2	5.680G	3	5.444G	4	5.459G
5	5.718G	6	5.298G	7	5.441G	8	5.605G
9	5.622G	10	5.505G	11	5.286G	12	5.634G
13	5.683G	14	5.583G	15	5.428G	16	5.667G
17	5.570G	18	5.549G	19	5.553G	20	5.353G
21	5.602G	22	5.544G	23	5.377G	24	5.341G
25	5.677G	26	5.713G	27	5.629G	28	5.321G
29	5.483G	30	5.363G	31	5.636G	32	5.504G
33	5.595G	34	5.384G	35	5.474G	36	5.625G
37	5.269G	38	5.624G	39	5.665G	40	5.375G
41	5.712G	42	5.345G	43	5.418G	44	5.457G
45	5.311G	46	5.656G	47	5.507G	48	5.429G
49	5.440G	50	5.320G	51	5.540G	52	5.477G
53	5.411G	54	5.561G	55	5.352G	56	5.317G
57	5.497G	58	5.423G	59	5.576G	60	5.367G
61	5.509G	62	5.472G	63	5.641G	64	5.597G
65	5.559G	66	5.585G	67	5.626G	68	5.336G
69	5.271G	70	5.313G	71	5.420G	72	5.448G
73	5.443G	74	5.381G	75	5.647G	76	5.431G
77	5.370G	78	5.580G	79	5.323G	80	5.548G
81	5.430G	82	5.596G	83	5.523G	84	5.530G
85	5.560G	86	5.592G	87	5.314G	88	5.422G
89	5.607G	90	5.385G	91	5.628G	92	5.421G
93	5.463G	94	5.437G	95	5.646G	96	5.648G
97	5.536G	98	5.296G	99	5.312G	100	5.409G

Hopping Frequency Sequence Name: HOP_FREQ_SEQ_22							
SEQ#	Frequency (Hz)	SEQ#	Frequency (Hz)	SEQ#	Frequency (Hz)	SEQ#	Frequency (Hz)
1	5.290G	2	5.317G	3	5.630G	4	5.724G
5	5.411G	6	5.700G	7	5.507G	8	5.263G
9	5.308G	10	5.568G	11	5.400G	12	5.252G
13	5.499G	14	5.570G	15	5.528G	16	5.461G
17	5.638G	18	5.399G	19	5.398G	20	5.254G
21	5.684G	22	5.616G	23	5.659G	24	5.285G
25	5.640G	26	5.647G	27	5.357G	28	5.279G
29	5.324G	30	5.323G	31	5.327G	32	5.626G
33	5.722G	34	5.345G	35	5.302G	36	5.483G
37	5.702G	38	5.384G	39	5.305G	40	5.651G
41	5.498G	42	5.693G	43	5.255G	44	5.564G
45	5.299G	46	5.482G	47	5.446G	48	5.704G
49	5.459G	50	5.582G	51	5.288G	52	5.720G
53	5.335G	54	5.286G	55	5.541G	56	5.457G
57	5.272G	58	5.365G	59	5.529G	60	5.618G
61	5.441G	62	5.581G	63	5.386G	64	5.650G
65	5.580G	66	5.612G	67	5.601G	68	5.557G
69	5.486G	70	5.608G	71	5.511G	72	5.664G
73	5.675G	74	5.525G	75	5.567G	76	5.678G
77	5.586G	78	5.336G	79	5.291G	80	5.387G
81	5.625G	82	5.356G	83	5.412G	84	5.706G
85	5.591G	86	5.688G	87	5.374G	88	5.401G
89	5.510G	90	5.624G	91	5.321G	92	5.339G
93	5.466G	94	5.475G	95	5.655G	96	5.328G
97	5.513G	98	5.686G	99	5.352G	100	5.261G



Hopping Frequency Sequence Name: HOP_FREQ_SEQ_23							
SEQ#	Frequency (Hz)	SEQ#	Frequency (Hz)	SEQ#	Frequency (Hz)	SEQ#	Frequency (Hz)
1	5.367G	2	5.276G	3	5.659G	4	5.686G
5	5.388G	6	5.552G	7	5.452G	8	5.285G
9	5.475G	10	5.441G	11	5.514G	12	5.266G
13	5.432G	14	5.462G	15	5.545G	16	5.348G
17	5.442G	18	5.489G	19	5.271G	20	5.277G
21	5.542G	22	5.594G	23	5.411G	24	5.517G
25	5.613G	26	5.275G	27	5.426G	28	5.661G
29	5.286G	30	5.595G	31	5.645G	32	5.688G
33	5.357G	34	5.690G	35	5.543G	36	5.364G
37	5.497G	38	5.393G	39	5.435G	40	5.345G
41	5.482G	42	5.344G	43	5.570G	44	5.593G
45	5.715G	46	5.602G	47	5.548G	48	5.451G
49	5.633G	50	5.471G	51	5.605G	52	5.324G
53	5.550G	54	5.526G	55	5.445G	56	5.651G
57	5.289G	58	5.582G	59	5.535G	60	5.251G
61	5.549G	62	5.362G	63	5.527G	64	5.294G
65	5.539G	66	5.423G	67	5.268G	68	5.400G
69	5.368G	70	5.684G	71	5.553G	72	5.703G
73	5.460G	74	5.436G	75	5.448G	76	5.309G
77	5.290G	78	5.260G	79	5.444G	80	5.588G
81	5.530G	82	5.682G	83	5.418G	84	5.560G
85	5.320G	86	5.486G	87	5.404G	88	5.428G
89	5.663G	90	5.401G	91	5.580G	92	5.484G
93	5.495G	94	5.319G	95	5.267G	96	5.618G
97	5.431G	98	5.327G	99	5.252G	100	5.547G

Hopping Frequency Sequence Name: HOP_FREQ_SEQ_24							
SEQ#	Frequency (Hz)	SEQ#	Frequency (Hz)	SEQ#	Frequency (Hz)	SEQ#	Frequency (Hz)
1	5.280G	2	5.283G	3	5.409G	4	5.651G
5	5.340G	6	5.620G	7	5.366G	8	5.353G
9	5.501G	10	5.456G	11	5.573G	12	5.583G
13	5.375G	14	5.630G	15	5.291G	16	5.333G
17	5.477G	18	5.453G	19	5.513G	20	5.510G
21	5.445G	22	5.407G	23	5.401G	24	5.671G
25	5.523G	26	5.428G	27	5.655G	28	5.603G
29	5.650G	30	5.270G	31	5.348G	32	5.367G
33	5.564G	34	5.673G	35	5.362G	36	5.378G
37	5.528G	38	5.334G	39	5.365G	40	5.568G
41	5.341G	42	5.636G	43	5.411G	44	5.549G
45	5.394G	46	5.271G	47	5.420G	48	5.724G
49	5.467G	50	5.423G	51	5.427G	52	5.580G
53	5.611G	54	5.313G	55	5.584G	56	5.553G
57	5.396G	58	5.688G	59	5.516G	60	5.433G
61	5.487G	62	5.308G	63	5.296G	64	5.338G
65	5.666G	66	5.464G	67	5.389G	68	5.421G
69	5.721G	70	5.605G	71	5.555G	72	5.447G
73	5.455G	74	5.567G	75	5.585G	76	5.656G
77	5.469G	78	5.640G	79	5.629G	80	5.424G
81	5.481G	82	5.329G	83	5.342G	84	5.610G
85	5.710G	86	5.489G	87	5.343G	88	5.442G
89	5.692G	90	5.292G	91	5.702G	92	5.601G
93	5.491G	94	5.626G	95	5.644G	96	5.641G
97	5.406G	98	5.450G	99	5.569G	100	5.690G

Hopping Frequency Sequence Name: HOP_FREQ_SEQ_25							
SEQ#	Frequency (Hz)	SEQ#	Frequency (Hz)	SEQ#	Frequency (Hz)	SEQ#	Frequency (Hz)
1	5.615G	2	5.657G	3	5.676G	4	5.592G
5	5.327G	6	5.300G	7	5.337G	8	5.680G
9	5.448G	10	5.690G	11	5.417G	12	5.567G
13	5.604G	14	5.694G	15	5.516G	16	5.503G
17	5.312G	18	5.598G	19	5.696G	20	5.383G
21	5.718G	22	5.475G	23	5.603G	24	5.464G
25	5.425G	26	5.677G	27	5.320G	28	5.367G
29	5.313G	30	5.436G	31	5.463G	32	5.699G
33	5.565G	34	5.371G	35	5.411G	36	5.659G
37	5.661G	38	5.649G	39	5.391G	40	5.589G
41	5.452G	42	5.410G	43	5.484G	44	5.302G
45	5.692G	46	5.270G	47	5.386G	48	5.279G
49	5.601G	50	5.513G	51	5.602G	52	5.673G
53	5.501G	54	5.557G	55	5.494G	56	5.254G
57	5.571G	58	5.264G	59	5.573G	60	5.440G
61	5.281G	62	5.423G	63	5.358G	64	5.500G
65	5.701G	66	5.525G	67	5.446G	68	5.369G
69	5.499G	70	5.582G	71	5.717G	72	5.664G
73	5.515G	74	5.514G	75	5.461G	76	5.631G
77	5.719G	78	5.606G	79	5.483G	80	5.449G
81	5.458G	82	5.447G	83	5.616G	84	5.482G
85	5.453G	86	5.263G	87	5.542G	88	5.399G
89	5.469G	90	5.275G	91	5.295G	92	5.291G
93	5.416G	94	5.444G	95	5.599G	96	5.522G
97	5.640G	98	5.632G	99	5.472G	100	5.583G

Hopping Frequency Sequence Name: HOP_FREQ_SEQ_26							
SEQ#	Frequency (Hz)	SEQ#	Frequency (Hz)	SEQ#	Frequency (Hz)	SEQ#	Frequency (Hz)
1	5.339G	2	5.672G	3	5.594G	4	5.694G
5	5.660G	6	5.647G	7	5.656G	8	5.705G
9	5.551G	10	5.542G	11	5.295G	12	5.316G
13	5.454G	14	5.592G	15	5.582G	16	5.303G
17	5.465G	18	5.417G	19	5.512G	20	5.710G
21	5.289G	22	5.286G	23	5.277G	24	5.440G
25	5.584G	26	5.518G	27	5.505G	28	5.597G
29	5.326G	30	5.371G	31	5.374G	32	5.639G
33	5.355G	34	5.609G	35	5.618G	36	5.463G
37	5.425G	38	5.404G	39	5.711G	40	5.506G
41	5.394G	42	5.431G	43	5.703G	44	5.489G
45	5.596G	46	5.575G	47	5.515G	48	5.655G
49	5.652G	50	5.494G	51	5.358G	52	5.648G
53	5.376G	54	5.457G	55	5.279G	56	5.707G
57	5.412G	58	5.396G	59	5.319G	60	5.430G
61	5.363G	62	5.379G	63	5.544G	64	5.364G
65	5.499G	66	5.622G	67	5.476G	68	5.536G
69	5.487G	70	5.587G	71	5.452G	72	5.418G
73	5.333G	74	5.321G	75	5.528G	76	5.574G
77	5.619G	78	5.386G	79	5.633G	80	5.467G
81	5.600G	82	5.500G	83	5.504G	84	5.265G
85	5.625G	86	5.359G	87	5.485G	88	5.372G
89	5.569G	90	5.456G	91	5.573G	92	5.581G
93	5.281G	94	5.314G	95	5.721G	96	5.650G
97	5.713G	98	5.275G	99	5.686G	100	5.708G

Hopping Frequency Sequence Name: HOP_FREQ_SEQ_27							
SEQ#	Frequency (Hz)	SEQ#	Frequency (Hz)	SEQ#	Frequency (Hz)	SEQ#	Frequency (Hz)
1	5.452G	2	5.650G	3	5.373G	4	5.568G
5	5.602G	6	5.448G	7	5.593G	8	5.367G
9	5.529G	10	5.515G	11	5.598G	12	5.338G
13	5.380G	14	5.524G	15	5.371G	16	5.401G
17	5.522G	18	5.411G	19	5.715G	20	5.590G
21	5.300G	22	5.691G	23	5.433G	24	5.430G
25	5.670G	26	5.318G	27	5.319G	28	5.333G
29	5.260G	30	5.425G	31	5.530G	32	5.708G
33	5.722G	34	5.712G	35	5.501G	36	5.654G
37	5.485G	38	5.424G	39	5.638G	40	5.445G
41	5.564G	42	5.439G	43	5.376G	44	5.442G
45	5.619G	46	5.552G	47	5.347G	48	5.408G
49	5.316G	50	5.643G	51	5.269G	52	5.484G
53	5.687G	54	5.419G	55	5.573G	56	5.473G
57	5.327G	58	5.293G	59	5.611G	60	5.475G
61	5.537G	62	5.583G	63	5.444G	64	5.661G
65	5.551G	66	5.255G	67	5.364G	68	5.349G
69	5.574G	70	5.588G	71	5.680G	72	5.497G
73	5.585G	74	5.534G	75	5.365G	76	5.721G
77	5.469G	78	5.488G	79	5.406G	80	5.348G
81	5.504G	82	5.671G	83	5.651G	84	5.375G
85	5.286G	86	5.507G	87	5.414G	88	5.519G
89	5.684G	90	5.438G	91	5.520G	92	5.265G
93	5.404G	94	5.711G	95	5.586G	96	5.657G
97	5.302G	98	5.575G	99	5.490G	100	5.464G

Hopping Frequency Sequence Name: HOP_FREQ_SEQ_28							
SEQ#	Frequency (Hz)	SEQ#	Frequency (Hz)	SEQ#	Frequency (Hz)	SEQ#	Frequency (Hz)
1	5.434G	2	5.680G	3	5.335G	4	5.560G
5	5.369G	6	5.305G	7	5.710G	8	5.275G
9	5.315G	10	5.475G	11	5.269G	12	5.460G
13	5.533G	14	5.627G	15	5.702G	16	5.661G
17	5.707G	18	5.356G	19	5.687G	20	5.328G
21	5.656G	22	5.563G	23	5.581G	24	5.361G
25	5.694G	26	5.468G	27	5.456G	28	5.304G
29	5.499G	30	5.255G	31	5.391G	32	5.647G
33	5.320G	34	5.653G	35	5.298G	36	5.536G
37	5.665G	38	5.268G	39	5.623G	40	5.721G
41	5.620G	42	5.611G	43	5.313G	44	5.570G
45	5.545G	46	5.716G	47	5.524G	48	5.628G
49	5.698G	50	5.558G	51	5.278G	52	5.723G
53	5.420G	54	5.359G	55	5.722G	56	5.492G
57	5.446G	58	5.354G	59	5.474G	60	5.638G
61	5.720G	62	5.618G	63	5.582G	64	5.326G
65	5.398G	66	5.410G	67	5.634G	68	5.344G
69	5.697G	70	5.253G	71	5.519G	72	5.424G
73	5.594G	74	5.286G	75	5.599G	76	5.264G
77	5.718G	78	5.576G	79	5.682G	80	5.432G
81	5.584G	82	5.462G	83	5.525G	84	5.336G
85	5.577G	86	5.459G	87	5.714G	88	5.449G
89	5.483G	90	5.490G	91	5.347G	92	5.277G
93	5.478G	94	5.292G	95	5.274G	96	5.377G
97	5.617G	98	5.367G	99	5.472G	100	5.337G

Hopping Frequency Sequence Name: HOP_FREQ_SEQ_29							
SEQ#	Frequency (Hz)	SEQ#	Frequency (Hz)	SEQ#	Frequency (Hz)	SEQ#	Frequency (Hz)
1	5.410G	2	5.585G	3	5.609G	4	5.523G
5	5.304G	6	5.466G	7	5.262G	8	5.617G
9	5.311G	10	5.677G	11	5.590G	12	5.283G
13	5.305G	14	5.601G	15	5.404G	16	5.690G
17	5.302G	18	5.655G	19	5.668G	20	5.389G
21	5.412G	22	5.709G	23	5.286G	24	5.631G
25	5.626G	26	5.487G	27	5.257G	28	5.491G
29	5.328G	30	5.345G	31	5.651G	32	5.275G
33	5.605G	34	5.430G	35	5.588G	36	5.705G
37	5.289G	38	5.694G	39	5.365G	40	5.307G
41	5.673G	42	5.288G	43	5.458G	44	5.363G
45	5.573G	46	5.424G	47	5.654G	48	5.354G
49	5.548G	50	5.696G	51	5.440G	52	5.701G
53	5.629G	54	5.390G	55	5.334G	56	5.507G
57	5.434G	58	5.724G	59	5.485G	60	5.444G
61	5.527G	62	5.428G	63	5.360G	64	5.377G
65	5.542G	66	5.641G	67	5.423G	68	5.446G
69	5.483G	70	5.478G	71	5.537G	72	5.293G
73	5.612G	74	5.476G	75	5.445G	76	5.702G
77	5.596G	78	5.388G	79	5.544G	80	5.499G
81	5.621G	82	5.353G	83	5.402G	84	5.603G
85	5.650G	86	5.469G	87	5.327G	88	5.313G
89	5.721G	90	5.432G	91	5.646G	92	5.680G
93	5.640G	94	5.295G	95	5.606G	96	5.604G
97	5.539G	98	5.325G	99	5.468G	100	5.484G

Hopping Frequency Sequence Name: HOP_FREQ_SEQ_30							
SEQ#	Frequency (Hz)	SEQ#	Frequency (Hz)	SEQ#	Frequency (Hz)	SEQ#	Frequency (Hz)
1	5.631G	2	5.628G	3	5.645G	4	5.347G
5	5.591G	6	5.427G	7	5.333G	8	5.692G
9	5.441G	10	5.504G	11	5.600G	12	5.551G
13	5.271G	14	5.647G	15	5.646G	16	5.406G
17	5.613G	18	5.291G	19	5.362G	20	5.394G
21	5.470G	22	5.458G	23	5.546G	24	5.563G
25	5.318G	26	5.397G	27	5.260G	28	5.636G
29	5.576G	30	5.430G	31	5.391G	32	5.460G
33	5.361G	34	5.708G	35	5.698G	36	5.544G
37	5.258G	38	5.474G	39	5.703G	40	5.416G
41	5.657G	42	5.328G	43	5.277G	44	5.617G
45	5.449G	46	5.489G	47	5.575G	48	5.268G
49	5.294G	50	5.723G	51	5.644G	52	5.590G
53	5.256G	54	5.721G	55	5.261G	56	5.259G
57	5.514G	58	5.476G	59	5.345G	60	5.459G
61	5.462G	62	5.266G	63	5.407G	64	5.488G
65	5.286G	66	5.371G	67	5.571G	68	5.556G
69	5.588G	70	5.654G	71	5.678G	72	5.354G
73	5.472G	74	5.526G	75	5.487G	76	5.468G
77	5.508G	78	5.388G	79	5.446G	80	5.520G
81	5.418G	82	5.390G	83	5.550G	84	5.482G
85	5.337G	86	5.404G	87	5.664G	88	5.465G
89	5.598G	90	5.257G	91	5.392G	92	5.516G
93	5.448G	94	5.327G	95	5.614G	96	5.594G
97	5.633G	98	5.637G	99	5.715G	100	5.329G