



FCC TEST REPORT (15.247)

REPORT NO.: RF110617E04

MODEL NO.: DWA-566

FCC ID: KA2WA566A1

RECEIVED: June 17, 2011

TESTED: June 22 to July 07, 2011

ISSUED: Aug. 26, 2011

APPLICANT: D-Link Corporation

ADDRESS: No.289, Sinhu 3rd Rd., Neihu District, Taipei
City 114, Taiwan, R.O.C.

ISSUED BY: Bureau Veritas Consumer Products Services
(H.K.) Ltd., Taoyuan Branch Hsin Chu Laboratory

LAB ADDRESS : No. 81-1, Lu Liao Keng, 9th Ling,Wu Lung Tsuen,
Chiung Lin Hsiang, Hsin Chu Hsien 307, Taiwan

TEST LOCATION (1): No. 81-1, Lu Liao Keng, 9th Ling,Wu Lung Tsuen,
Chiung Lin Hsiang, Hsin Chu Hsien 307, Taiwan

TEST LOCATION (2): No. 49, Ln. 206, Wende Rd., Shangshan Tsuen,
Chiung Lin Hsiang, Hsin Chu Hsien 307, Taiwan

This test report consists of 131 pages in total. It may be duplicated completely for legal use with the approval of the applicant. It should not be reproduced except in full, without the written approval of our laboratory. The client should not use it to claim product certification, approval, or endorsement by TAF or any government agencies. The test results in the report only apply to the tested sample.





A D T

Table of Contents

RELEASE CONTROL RECORD	5
1. CERTIFICATION	6
2. SUMMARY OF TEST RESULTS	7
2.1 MEASUREMENT UNCERTAINTY	9
3. GENERAL INFORMATION	10
3.1 GENERAL DESCRIPTION OF EUT	10
3.2 DESCRIPTION OF TEST MODES	13
3.2.1 TEST MODE APPLICABILITY AND TESTED CHANNEL DETAIL	14
3.3 GENERAL DESCRIPTION OF APPLIED STANDARDS	18
3.4 DESCRIPTION OF SUPPORT UNITS.....	19
3.5 CONFIGURATION OF SYSTEM UNDER TEST	20
4. TEST TYPES AND RESULTS (802.11b & g, 2400 ~ 2483.5MHz Band)	21
4.1 CONDUCTED EMISSION MEASUREMENT	21
4.1.1 LIMITS OF CONDUCTED EMISSION MEASUREMENT	21
4.1.2 TEST INSTRUMENTS.....	21
4.1.3 TEST PROCEDURES	22
4.1.4 DEVIATION FROM TEST STANDARD	22
4.1.5 TEST SETUP	23
4.1.6 EUT OPERATING CONDITIONS	23
4.1.7 TEST RESULTS	24
4.2 RADIATED EMISSION MEASUREMENT	26
4.2.1 LIMITS OF RADIATED EMISSION MEASUREMENT	26
4.2.2 TEST INSTRUMENTS.....	27
4.2.3 TEST PROCEDURES	28
4.2.4 DEVIATION FROM TEST STANDARD	28
4.2.5 TEST SETUP	29
4.2.6 EUT OPERATING CONDITIONS	29
4.2.7 TEST RESULTS	30
4.3 6dB BANDWIDTH MEASUREMENT	59
4.3.1 LIMITS OF 6dB BANDWIDTH MEASUREMENT	59
4.3.2 TEST INSTRUMENTS.....	59
4.3.3 TEST PROCEDURE.....	59
4.3.4 DEVIATION FROM TEST STANDARD	59
4.3.5 TEST SETUP	59
4.3.6 EUT OPERATING CONDITIONS	59
4.3.7 TEST RESULTS	60
4.4 MAXIMUM PEAK OUTPUT POWER.....	64
4.4.1 LIMITS OF MAXIMUM PEAK OUTPUT POWER MEASUREMENT	64
4.4.2 INSTRUMENTS.....	64
4.4.3 TEST PROCEDURES	64



4.4.4	DEVIATION FROM TEST STANDARD	64
4.4.5	TEST SETUP	64
4.4.6	EUT OPERATING CONDITIONS	64
4.4.7	TEST RESULTS	65
4.5	POWER SPECTRAL DENSITY MEASUREMENT	67
4.5.1	LIMITS OF POWER SPECTRAL DENSITY MEASUREMENT	67
4.5.2	TEST INSTRUMENTS.....	67
4.5.3	TEST PROCEDURE.....	67
4.5.4	DEVIATION FROM TEST STANDARD	67
4.5.5	TEST SETUP	67
4.5.6	EUT OPERATING CONDITION.....	67
4.5.7	TEST RESULTS	68
4.6	CONDUCTED OUT-BAND EMISSION MEASUREMENT	72
4.6.1	LIMITS OF CONDUCTED OUT-BAND EMISSION MEASUREMENT.....	72
4.6.2	TEST INSTRUMENTS.....	72
4.6.3	TEST PROCEDURE.....	72
4.6.4	DEVIATION FROM TEST STANDARD	72
4.6.5	EUT OPERATING CONDITION	72
4.6.6	TEST RESULTS	72
5.	TEST TYPES AND RESULTS (802.11a, 5725~5850MHz Band).....	89
5.1	CONDUCTED EMISSION MEASUREMENT	89
5.1.1	LIMITS OF CONDUCTED EMISSION MEASUREMENT	89
5.1.2	TEST INSTRUMENTS.....	89
5.1.3	TEST PROCEDURES	90
5.1.4	DEVIATION FROM TEST STANDARD	90
5.1.5	TEST SETUP	91
5.1.6	EUT OPERATING CONDITIONS	91
5.1.7	TEST RESULTS	92
5.2	RADIATED EMISSION MEASUREMENT	94
5.2.1	LIMITS OF RADIATED EMISSION MEASUREMENT	94
5.2.2	TEST INSTRUMENTS.....	95
5.2.3	TEST PROCEDURES	96
5.2.4	DEVIATION FROM TEST STANDARD	96
5.2.5	TEST SETUP	97
5.2.6	EUT OPERATING CONDITIONS	97
5.2.7	TEST RESULTS	98
5.3	6dB BANDWIDTH MEASUREMENT	107
5.3.1	LIMITS OF 6dB BANDWIDTH MEASUREMENT	107
5.3.2	TEST INSTRUMENTS.....	107
5.3.3	TEST PROCEDURE.....	107
5.3.4	DEVIATION FROM TEST STANDARD	107
5.3.5	TEST SETUP	107



A D T

5.3.6	EUT OPERATING CONDITIONS	107
5.3.7	TEST RESULTS	108
5.4	MAXIMUM PEAK OUTPUT POWER.....	111
5.4.1	LIMITS OF MAXIMUM PEAK OUTPUT POWER MEASUREMENT	111
5.4.2	INSTRUMENTS.....	111
5.4.3	TEST PROCEDURES	111
5.4.4	DEVIATION FROM TEST STANDARD.....	111
5.4.5	TEST SETUP	111
5.4.6	EUT OPERATING CONDITIONS	111
5.4.7	TEST RESULTS	112
5.5	POWER SPECTRAL DENSITY MEASUREMENT.....	113
5.5.1	LIMITS OF POWER SPECTRAL DENSITY MEASUREMENT	113
5.5.2	TEST INSTRUMENTS.....	113
5.5.3	TEST PROCEDURE.....	113
5.5.4	DEVIATION FROM TEST STANDARD.....	113
5.5.5	TEST SETUP	113
5.5.6	EUT OPERATING CONDITION.....	113
5.5.7	TEST RESULTS	114
5.6	CONDUCTED OUT-BAND EMISSION MEASUREMENT.....	117
5.6.1	LIMITS OF CONDUCTED OUT-BAND EMISSION MEASUREMENT.....	117
5.6.2	TEST INSTRUMENTS.....	117
5.6.3	TEST PROCEDURE.....	117
5.6.4	DEVIATION FROM TEST STANDARD.....	117
5.6.5	EUT OPERATING CONDITION.....	117
5.6.6	TEST RESULTS	117
6.	INFORMATION ON THE TESTING LABORATORIES	130
7.	APPENDIX A - MODIFICATIONS RECORDERS FOR ENGINEERING CHANGES TO THE EUT BY THE LAB.....	131



A D T

RELEASE CONTROL RECORD

ISSUE NO.	REASON FOR CHANGE	DATE ISSUED
RF110617E04	Original release	Aug. 26, 2011



A D T

1. CERTIFICATION

PRODUCT: WIRELESS N 300 PCIe
BRAND NAME: D-Link
MODEL NO.: DWA-566
TEST SAMPLE: MASS-PRODUCTION
APPLICANT: D-Link Corporation
TESTED: June 22 to July 07, 2011
STANDARDS: FCC Part 15, Subpart C (Section 15.247)
ANSI C63.4-2003
ANSI C63.10-2009

The above equipment (Model: DWA-566) has been tested by **Bureau Veritas Consumer Products Services (H.K.) Ltd., Taoyuan Branch**, and found compliance with the requirement of the above standards. The test record, data evaluation & Equipment Under Test (EUT) configurations represented herein are true and accurate accounts of the measurements of the sample's EMC characteristics under the conditions specified in this report.

PREPARED BY : Midoli Peng, **DATE:** Aug. 26, 2011
(Midoli Peng, Specialist)

APPROVED BY : May Chen, **DATE:** Aug. 26, 2011
(May Chen, Deputy Manager)

2. SUMMARY OF TEST RESULTS

The EUT has been tested according to the following specifications:

For 2.4GHz, 2412~2462MHz Band

APPLIED STANDARD: FCC Part 15, Subpart C			
Standard Section	Test Type and Limit	Result	Remark
15.207	AC Power Conducted Emission	PASS	Meet the requirement of limit. Minimum passing margin is -11.63dB at 0.205MHz
15.247(a)(2)	Spectrum Bandwidth of a Direct Sequence Spread Spectrum System Limit: min. 500kHz	PASS	Meet the requirement of limit.
15.247(b)	Maximum Peak Output Power Limit: max. 30dBm	PASS	Meet the requirement of limit.
15.247(d)	Radiated Emissions Limit: Table 15.209	PASS	Meet the requirement of limit. Minimum passing margin is -0.7dB at 2483.5MHz
15.247(e)	Power Spectral Density Limit: max. 8dBm	PASS	Meet the requirement of limit.
15.247(d)	Conducted Out-Band Emission Measurement Limit: 20dB less than the peak value of fundamental frequency	PASS	Meet the requirement of limit.
15.203	Antenna Requirement	PASS	Antenna connector is SMA Plug Straight / Reverse not a standard connector.



A D T

For 5GHz, 5725~5850MHz Band

APPLIED STANDARD: FCC Part 15, Subpart C			
Standard Section	Test Type and Limit	Result	Remark
15.207	AC Power Conducted Emission	PASS	Meet the requirement of limit. Minimum passing margin is -14.60dB at 0.209MHz
15.247(a)(2)	Spectrum Bandwidth of a Direct Sequence Spread Spectrum System Limit: min. 500kHz	PASS	Meet the requirement of limit.
15.247(b)	Maximum Peak Output Power Limit: max. 30dBm	PASS	Meet the requirement of limit.
15.247(d)	Radiated Emissions Limit: Table 15.209	PASS	Meet the requirement of limit. Minimum passing margin is -4.4dB at 799.75MHz
15.247(e)	Power Spectral Density Limit: max. 8dBm	PASS	Meet the requirement of limit.
15.247(d)	Conducted Out-Band Emission Measurement Limit: 20dB less than the peak value of fundamental frequency	PASS	Meet the requirement of limit.
15.203	Antenna Requirement	PASS	Antenna connector is SMA Plug Straight / Reverse not a standard connector.

NOTE:

1. The EUT was operating in 2400 ~ 2483.5MHz, 5.15~5.35GHz, 5.47~5.725GHz and 5.725~5.850GHz frequencies band. This report was recorded the RF parameters including 2400 ~ 2483.5MHz and 5.725~5.850GHz. For the 5.15~5.35GHz and 5.47~5.725GHz RF parameters was recorded in another test report.



A D T

2.1 MEASUREMENT UNCERTAINTY

Where relevant, the following measurement uncertainty levels have been estimated for tests performed on the EUT as specified in CISPR 16-4-2:

This uncertainty represents an expanded uncertainty expressed at approximately the 95% confidence level using a coverage factor of $k=2$.

Measurement	Value
Conducted emissions	2.45 dB
Radiated emissions (30MHz-1GHz)	3.81 dB
Radiated emissions (1GHz -18GHz)	2.19 dB
Radiated emissions (18GHz -40GHz)	2.56 dB



A D T

3. GENERAL INFORMATION

3.1 GENERAL DESCRIPTION OF EUT

PRODUCT	WIRELESS N 300 PCIe
MODEL NO.	DWA-566
FCC ID	KA2WA566A1
POWER SUPPLY	DC 3.3V \pm 10% from host equipment
MODULATION TYPE	CCK, DQPSK, DBPSK for DSSS 64QAM, 16QAM, QPSK, BPSK for OFDM
MODULATION TECHNOLOGY	DSSS, OFDM
TRANSFER RATE	802.11b: 11 / 5.5 / 2 / 1Mbps 802.11g: 54 / 48 / 36 / 24 / 18 / 12 / 9 / 6Mbps HT20 MCS0~7 (800ns GI): 6.5Mbps, 13Mbps, 19.5Mbps, 26Mbps, 39Mbps, 52Mbps, 58.5Mbps, 65Mbps, HT20 MCS8~15 (800ns GI): 13Mbps, 26Mbps, 39Mbps, 52Mbps, 78Mbps, 104Mbps, 117Mbps, 130Mbps. HT40 MCS0~7 (800ns GI): 13.5Mbps, 27Mbps, 40.5Mbps, 54Mbps, 81Mbps, 108Mbps, 121.5Mbps, 135Mbps. HT40 MCS8~15 (800ns GI): 27Mbps, 54Mbps, 81Mbps, 108Mbps, 162Mbps, 216Mbps, 243Mbps, 270Mbps. HT20 MCS0~7 (400ns GI): 7.2Mbps, 14.4Mbps, 21.7Mbps, 28.9Mbps, 43.3Mbps, 57.8Mbps, 65.0Mbps, 72.2Mbps, HT20 MCS8~15 (400ns GI): 14.444Mbps, 28.889Mbps, 43.333Mbps, 57.778Mbps, 86.667Mbps, 115.556Mbps, 130.000Mbps, 144.444Mbps. HT40 MCS0~7 (400ns GI): 15.0Mbps, 30.0Mbps, 45.0Mbps, 60.0Mbps, 90.0Mbps, 120.0Mbps, 135.0Mbps, 150.0Mbps, HT40 MCS8~15 (400ns GI): 30.0Mbps, 60.0Mbps, 90.0Mbps, 120.0Mbps, 180.0Mbps, 240.0Mbps, 270.0Mbps, 300.0Mbps.
OPERATING FREQUENCY	For 15.407 802.11a: 5.18 ~ 5.24GHz, 5.26 ~ 5.32GHz, 5.50 ~ 5.70GHz For 15.247 802.11b & 802.11g: 2.412 ~ 2.462GHz 802.11a: 5.745 ~ 5.825GHz

NUMBER OF CHANNEL	For 15.407 19 for 802.11a, 802.11n (20MHz) 9 for 802.11n (40MHz)
	For 15.247(2.4GHz) 11 for 802.11b, 802.11g, 802.11n (20MHz) 7 for 802.11n (40MHz)
	For 15.247(5GHz) 5 for 802.11a, 802.11n (20MHz) 2 for 802.11n (40MHz)
MAXIMUM OUTPUT POWER	For 15.407 802.11a: 109.3mW 802.11n (20MHz): 102.4mW 802.11n (40MHz): 74.4mW
	For 15.247(2.4GHz) 802.11b: 221.0mW 802.11g: 442.6mW 802.11n (20MHz): 502.5mW 802.11n (40MHz): 347.7mW
	For 15.247(5GHz) 802.11a: 302.7mW 802.11n (20MHz): 306.7mW 802.11n (40MHz): 355.8mW
ANTENNA TYPE	Please see note
DATA CABLE	NA
I/O PORTS	NA
ASSOCIATED DEVICES	NA

NOTE:

- There are two antennas provided to this EUT, please refer to the following table:

Transmitter Circuit	Brand	Model	Gain (dBi) include cable loss	Antenna Type	Connector
Chain (0)	WHA YU GROUP	C037-511105-A (SSR-02561)	2	Dipole	SMA Plug Straight / Reverse
Chain (1)	WHA YU GROUP	C037-511105-A (SSR-02561)	2	Dipole	SMA Plug Straight / Reverse

- 2.4GHz and 5GHz technology cannot transmit at same time.



A D T

3. The EUT incorporates CDD function with 802.11a, 802.11b, 802.11g.
4. The EUT is 2 * 2 spatial MIMO (2Tx & 2Rx) without beam forming function.
5. When the EUT operating in 802.11n, the software operation, which is defined by manufacturer, MCS (Modulation and Coding Schemes) from 0 to 15.
6. The above EUT information was declared by the manufacturer and for more detailed features description, please refer to the manufacturer's specifications or User's Manual.



3.2 DESCRIPTION OF TEST MODES

Operated in 2400 ~ 2483.5MHz band:

Eleven channels are provided for 802.11b, 802.11g, 802.11n (20MHz):

CHANNEL	FREQUENCY	CHANNEL	FREQUENCY
1	2412MHz	7	2442MHz
2	2417MHz	8	2447MHz
3	2422MHz	9	2452MHz
4	2427MHz	10	2457MHz
5	2432MHz	11	2462MHz
6	2437MHz		

Seven channels are provided for 802.11n (40MHz):

CHANNEL	FREQUENCY	CHANNEL	FREQUENCY
3	2422MHz	7	2442MHz
4	2427MHz	8	2447MHz
5	2432MHz	9	2452MHz
6	2437MHz		

Operated in 5725 ~ 5850MHz band:

Five channels are provided for 802.11a, 802.11n (20MHz):

CHANNEL	FREQUENCY	CHANNEL	FREQUENCY
149	5745 MHz	161	5805 MHz
153	5765 MHz	165	5825 MHz
157	5785 MHz		

Two channels are provided for 802.11n (40MHz):

CHANNEL	FREQUENCY
151	5755 MHz
159	5795 MHz

3.2.1 TEST MODE APPLICABILITY AND TESTED CHANNEL DETAIL

EUT CONFIGURE MODE	APPLICABLE TO					DESCRIPTION
	PLC	RE < 1G	RE ≥ 1G	APCM	OB	
-	√	√	√	√	√	-

Where **PLC**: Power Line Conducted Emission **RE < 1G**: Radiated Emission below 1GHz
RE ≥ 1G: Radiated Emission above 1GHz **APCM**: Antenna Port Conducted Measurement
OB: Conducted Out-Band Emission Measurement

ANTENNA COMBINATION MODE:

COMBINATION MODE	OPERATION MODE	TX CHAIN(0)	TX CHAIN(1)
A	802.11 b	√	√
B	802.11 g	√	√
C	802.11 a	√	√
D	802.11n(20MHz) for MCS0~15	√	√
E	802.11n(40MHz) for MCS0~15	√	√

Note: 1. The above information was declared by manufacturer and for more detailed features description, please refer to the manufacturer's specifications or user's manual.

POWER LINE CONDUCTED EMISSION TEST:

- Pre-Scan has been conducted to determine the worst-case mode from all possible combinations between available modulations, data rates and antenna ports (if EUT with antenna diversity architecture).
- Following channel(s) was (were) selected for the final test as listed below.

MODE	AVAILABLE CHANNEL	TESTED CHANNEL	MODULATION TECHNOLOGY	MODULATION TYPE	DATA RATE (Mbps)	COMBINATION
For 2.4 GHz 802.11n (20MHz)	1 to 11	6	OFDM	BPSK	6.5	D
For 5 GHz 802.11n (40MHz)	151 to 159	151	OFDM	BPSK	13.5	E



A D T

RADIATED EMISSION TEST (BELOW 1 GHz):

- Pre-Scan has been conducted to determine the worst-case mode from all possible combinations between available modulations, data rates and antenna ports (if EUT with antenna diversity architecture).
- Following channel(s) was (were) selected for the final test as listed below.

MODE	AVAILABLE CHANNEL	TESTED CHANNEL	MODULATION TECHNOLOGY	MODULATION TYPE	DATA RATE (Mbps)	COMBINATION
For 2.4 GHz 802.11n (20MHz)	1 to 11	6	OFDM	BPSK	6.5	D
For 5 GHz 802.11n (40MHz)	151 to 159	151	OFDM	BPSK	13.5	E

RADIATED EMISSION TEST (ABOVE 1 GHz):

- Pre-Scan has been conducted to determine the worst-case mode from all possible combinations between available modulations, data rates and antenna ports (if EUT with antenna diversity architecture).
- Following channel(s) was (were) selected for the final test as listed below.

MODE	AVAILABLE CHANNEL	TESTED CHANNEL	MODULATION TECHNOLOGY	MODULATION TYPE	DATA RATE (Mbps)	COMBINATION
802.11b	1 to 11	1, 6, 11	DSSS	DBPSK	1	A
802.11g	1 to 11	1, 6, 11	OFDM	BPSK	6	B
For 2.4 GHz 802.11n (20MHz)	1 to 11	1, 6, 11	OFDM	BPSK	6.5	D
For 2.4 GHz 802.11n (40MHz)	3 to 9	3, 6, 9	OFDM	BPSK	13.5	E
802.11a	149 to 165	149, 157, 165	OFDM	BPSK	6	C
For 5 GHz 802.11n (20MHz)	149 to 165	149, 157, 165	OFDM	BPSK	6.5	D
For 5 GHz 802.11n (40MHz)	151 to 159	151, 159	OFDM	BPSK	13.5	E

ANTENNA PORT CONDUCTED MEASUREMENT:

- This item includes all test value of each mode, but only includes spectrum plot of worst value of each mode.
- Pre-Scan has been conducted to determine the worst-case mode from all possible combinations between available modulations, data rates and antenna ports (if EUT with antenna diversity architecture).
- Following channel(s) was (were) selected for the final test as listed below.

MODE	AVAILABLE CHANNEL	TESTED CHANNEL	MODULATION TECHNOLOGY	MODULATION TYPE	DATA RATE (Mbps)	COMBINATION
802.11b	1 to 11	1, 6, 11	DSSS	DBPSK	1	A
802.11g	1 to 11	1, 6, 11	OFDM	BPSK	6	B
For 2.4 GHz 802.11n (20MHz)	1 to 11	1, 6, 11	OFDM	BPSK	6.5	D
For 2.4 GHz 802.11n (40MHz)	3 to 9	3, 6, 9	OFDM	BPSK	13.5	E
802.11a	149 to 165	149, 157, 165	OFDM	BPSK	6	C
For 5 GHz 802.11n (20MHz)	149 to 165	149, 157, 165	OFDM	BPSK	6.	D
For 5 GHz 802.11n (40MHz)	151 to 159	151, 159	OFDM	BPSK	13.5	E

CONDUCTED OUT-BAND EMISSION MEASUREMENT:

- Pre-Scan has been conducted to determine the worst-case mode from all possible combinations between available modulations, data rates and antenna ports (if EUT with antenna diversity architecture).
- Following channel(s) was (were) selected for the final test as listed below.

MODE	AVAILABLE CHANNEL	TESTED CHANNEL	MODULATION TECHNOLOGY	MODULATION TYPE	DATA RATE (Mbps)	COMBINATION MODE
802.11b	1 to 11	1, 11	DSSS	DBPSK	1	A
802.11g	1 to 11	1, 11	OFDM	BPSK	6	B
For 2.4 GHz 802.11n (20MHz)	1 to 11	1, 11	OFDM	BPSK	6.5	D
For 2.4 GHz 802.11n (40MHz)	3 to 9	3, 9	OFDM	BPSK	13.5	E
802.11a	149 to 165	149, 165	OFDM	BPSK	6	C
For 5 GHz 802.11n (20MHz)	149 to 165	149, 165	OFDM	BPSK	6.	D
For 5 GHz 802.11n (40MHz)	151 to 159	151, 159	OFDM	BPSK	13.5	E



A D T

TEST CONDITION:

APPLICABLE TO	ENVIRONMENTAL CONDITIONS	INPUT POWER (SYSTEM)	TESTED BY
PLC	25deg. C, 75%RH	120Vac, 60Hz	Eagle Chen
RE<1G	24deg. C, 70%RH	120Vac, 60Hz	Nelson Teng
RE ³ 1G	26deg. C, 68%RH	120Vac, 60Hz	Frank Liu, Kent Liu
APCM	25deg. C, 60%RH	120Vac, 60Hz	Kent Liu
OB	25deg. C, 60%RH	120Vac, 60Hz	Kent Liu

3.3 GENERAL DESCRIPTION OF APPLIED STANDARDS

The EUT is a RF product. According to the specifications of the manufacturer, it must comply with the requirements of the following standards:

FCC Part 15, Subpart C. (15.247)

ANSI C63.4-2003

ANSI C63.10-2009

All test items have been performed and recorded as per the above standards.

NOTE: The EUT is also considered as a kind of computer peripheral, because the connection to computer is necessary for typical use. It has been verified to comply with the requirements of FCC Part 15, Subpart B, Class B (DoC). The test report has been issued separately.



A D T

3.4 DESCRIPTION OF SUPPORT UNITS

The EUT has been tested as an independent unit together with other necessary accessories or support units. The following support units or accessories were used to form a representative test configuration during the tests.

For Conducted test					
NO.	PRODUCT	BRAND	MODEL NO.	SERIAL NO.	FCC ID
1	PERSONAL COMPUTER	DELL	DCSCMF	9KKB32S	FCC DoC
2	MONITOR	DELL	E2210Hc	CN-OG337R-64 180-97S-OQDS	FCC DoC
3	PRINTER	EPSON	LQ-300+II	G88Y074083	FCC DoC
4	MODEM	ACEEX	1414	0206026778	IFAXDM1414
5	KEYBOARD	DELL	SK-8115	MY-0DJ325-716 19-99B-0476	FCC DoC
6	MOUSE	DELL	MOC5UO	I1401LVG	FCC DoC
For other test items					
NO.	PRODUCT	BRAND	MODEL NO.	SERIAL NO.	FCC ID
1	PERSONAL COMPUTER	IBM	A65	L3B4724	FCC DoC
2	MONITOR	DELL	E2210Hc	CN-OG337R-64 180-97S-OQ8S	FCC DoC
3	PRINTER	EPSON	LQ-300+II	G88Y074015	FCC DoC
4	MODEM	ACEEX	1414	0206026778	IFAXDM1414
5	KEYBOARD	DELL	SK-8115	MY-0DJ325-716 19-99B-0479	FCC DoC
6	MOUSE	DELL	MOC5UO	I14066PS	FCC DoC

NO.	SIGNAL CABLE DESCRIPTION OF THE ABOVE SUPPORT UNITS
1	NA
2	1.8m VGA Cable, shielded, with two cores.
3	1.8m braid shielded wire, terminated with DB25 and Centronics connector via metallic frame, w/o core.
4	1.2m braid shielded wire, terminated with DB25 and DB9 connector via metallic frame, w/o core.
5	1.8m USB Cable, shielded.
6	1.5m USB Cable, shielded.

NOTE: All power cords of the above support units are non shielded (1.8m).

3.5 CONFIGURATION OF SYSTEM UNDER TEST

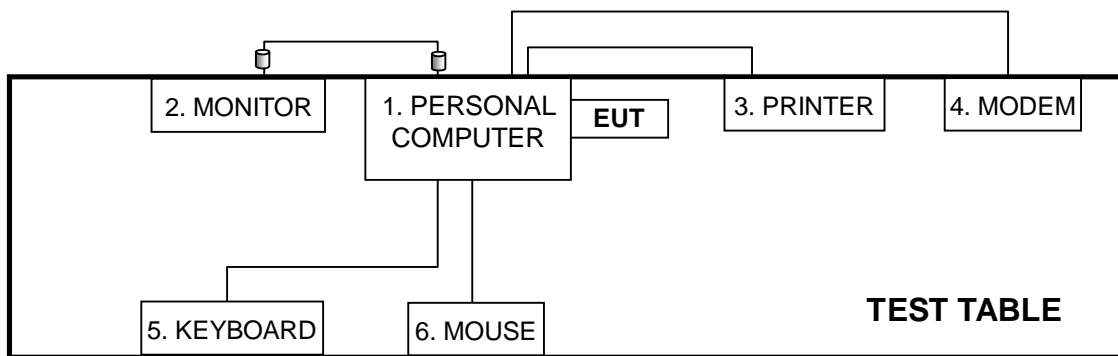

4. TEST TYPES AND RESULTS (802.11b & g, 2400 ~ 2483.5MHz Band)

4.1 CONDUCTED EMISSION MEASUREMENT

4.1.1 LIMITS OF CONDUCTED EMISSION MEASUREMENT

FREQUENCY OF EMISSION (MHz)	CONDUCTED LIMIT (dB μ V)	
	Quasi-peak	Average
0.15-0.5	66 to 56	56 to 46
0.5-5	56	46
5-30	60	50

- NOTE:**
1. The lower limit shall apply at the transition frequencies.
 2. The limit decreases in line with the logarithm of the frequency in the range of 0.15 to 0.50 MHz.
 3. All emanations from a class A/B digital device or system, including any network of conductors and apparatus connected thereto, shall not exceed the level of field strengths specified above.

4.1.2 TEST INSTRUMENTS

Test date: June 22, 2011

DESCRIPTION & MANUFACTURER	MODEL NO.	SERIAL NO.	CALIBRATED DATE	CALIBRATED UNTIL
Test Receiver	ESCS 30	100375	Mar. 09, 2011	Mar. 08, 2012
Line-Impedance Stabilization Network (for EUT)	NSLK 8127	8127-522	Sep. 08, 2010	Sep. 07, 2011
Line-Impedance Stabilization Network (for Peripheral)	ESH3-Z5	848773/004	Nov. 03, 2010	Nov. 02, 2011
RF Cable (JYBAO)	5DFB	COCCAB-002	Aug. 30, 2010	Aug. 29, 2011
50 ohms Terminator	50	3	Nov. 03, 2010	Nov. 02, 2011
Software	BV ADT_Cond_V7.3.7	NA	NA	NA

Note:

1. The calibration interval of the above test instruments is 12 months and the calibrations are traceable to NML/ROC and NIST/USA.
2. The test was performed in Shielded Room No. C.
3. The VCCI Con C Registration No. is C-3611.

4.1.3 TEST PROCEDURES

- a. The EUT was placed 0.4 meters from the conducting wall of the shielded room with EUT being connected to the power mains through a line impedance stabilization network (LISN). Other support units were connected to the power mains through another LISN. The two LISNs provide 50 ohm/ 50uH of coupling impedance for the measuring instrument.
- b. Both lines of the power mains connected to the EUT were checked for maximum conducted interference.
- c. The frequency range from 150kHz to 30MHz was searched. Emission levels under (Limit - 20dB) were not recorded.

4.1.4 DEVIATION FROM TEST STANDARD

No deviation

4.1.5 TEST SETUP

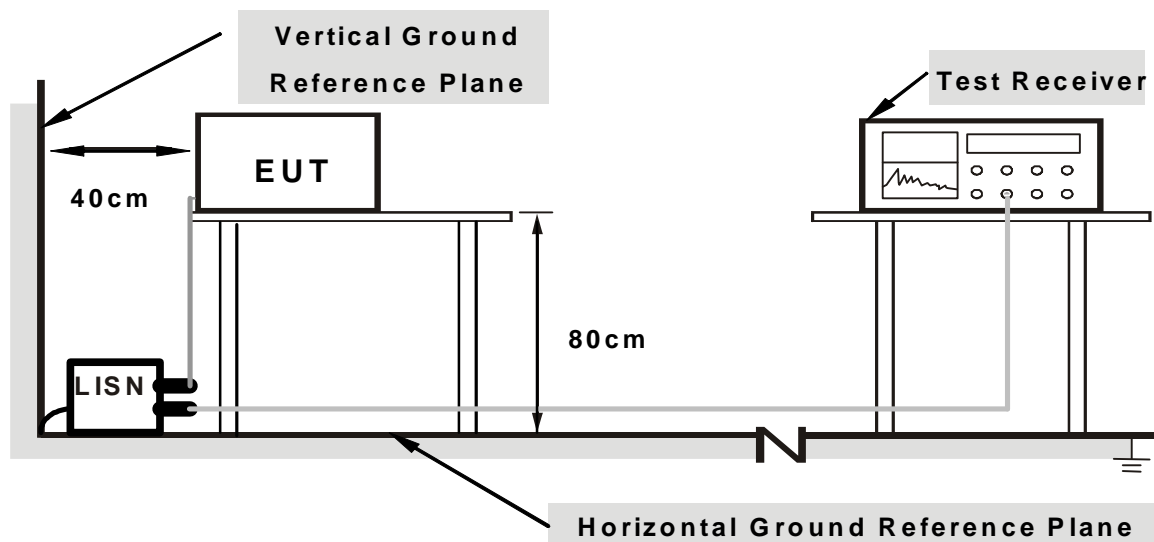

Note: 1. Support units were connected to second LISN.

2. Both of LISNs (AMN) are 80 cm from EUT and at least 80 from other units and other metal planes

For the actual test configuration, please refer to the related item – Photographs of the Test Configuration.

4.1.6 EUT OPERATING CONDITIONS

1. Turned on the power of all equipment.
2. Prepared computer system support unit 1 (Personal Computer) to act as communication partner and placed it outside of testing area.
3. The communication partner ran test program “art2_ver_2_14BIN” to enable EUT under transmission/receiving condition continuously.

4.1.7 TEST RESULTS

PHASE	Line (L)	6dB BANDWIDTH	9 kHz
--------------	----------	----------------------	-------

No	Freq. [MHz]	Corr. Factor (dB)	Reading Value		Emission Level		Limit		Margin	
			[dB (uV)]		[dB (uV)]		[dB (uV)]		(dB)	
			Q.P.	AV.	Q.P.	AV.	Q.P.	AV.	Q.P.	AV.
1	0.150	0.39	38.99	27.25	39.38	27.64	66.00	56.00	-26.62	-28.36
2	0.205	0.40	44.56	41.36	44.96	41.76	63.39	53.39	-18.43	-11.63
3	0.310	0.41	30.77	30.52	31.18	30.93	59.97	49.97	-28.79	-19.04
4	0.414	0.41	30.14	30.84	30.55	31.25	57.57	47.57	-27.02	-16.32
5	9.902	0.94	27.61	23.85	28.55	24.79	60.00	50.00	-31.45	-25.21
6	14.445	1.11	17.34	10.11	18.45	11.22	60.00	50.00	-41.55	-38.78
7	15.363	1.14	34.55	30.18	35.69	31.32	60.00	50.00	-24.31	-18.68
8	23.992	1.45	31.55	30.14	33.00	31.59	60.00	50.00	-27.00	-18.41

- REMARKS:**
1. Q.P. and AV. are abbreviations of quasi-peak and average individually.
 2. The emission levels of other frequencies were very low against the limit.
 3. Margin value = Emission level - Limit value
 4. Correction factor = Insertion loss + Cable loss
 5. Emission Level = Correction Factor + Reading Value.

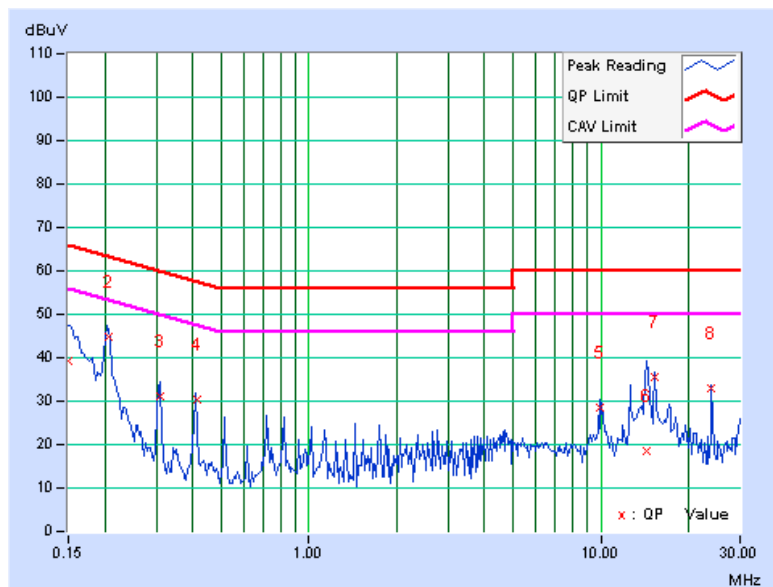

PHASE	Neutral (N)	6dB BANDWIDTH	9 kHz
--------------	-------------	----------------------	-------

No	Freq. [MHz]	Corr. Factor (dB)	Reading Value		Emission Level		Limit		Margin	
			[dB (uV)]		[dB (uV)]		[dB (uV)]		(dB)	
			Q.P.	AV.	Q.P.	AV.	Q.P.	AV.	Q.P.	AV.
1	0.154	0.12	33.37	20.25	33.49	20.37	65.78	55.78	-32.30	-35.42
2	0.313	0.16	29.77	28.64	29.93	28.80	59.89	49.89	-29.97	-21.10
3	0.521	0.16	25.31	22.54	25.47	22.70	56.00	46.00	-30.53	-23.30
4	0.935	0.18	29.41	24.85	29.59	25.03	56.00	46.00	-26.41	-20.97
5	12.634	0.92	29.25	25.73	30.17	26.65	60.00	50.00	-29.83	-23.35
6	15.362	1.11	36.44	33.28	37.55	34.39	60.00	50.00	-22.45	-15.61
7	23.992	1.71	28.57	27.31	30.28	29.02	60.00	50.00	-29.72	-20.98

- REMARKS:**
1. Q.P. and AV. are abbreviations of quasi-peak and average individually.
 2. The emission levels of other frequencies were very low against the limit.
 3. Margin value = Emission level - Limit value
 4. Correction factor = Insertion loss + Cable loss
 5. Emission Level = Correction Factor + Reading Value.

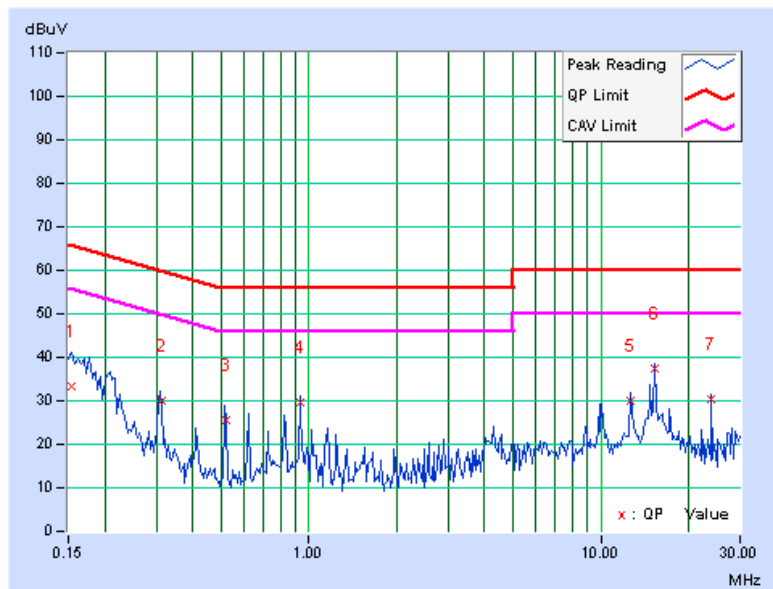

4.2 RADIATED EMISSION MEASUREMENT

4.2.1 LIMITS OF RADIATED EMISSION MEASUREMENT

Emissions radiated outside of the specified bands, shall be according to the general radiated limits in 15.209 as following:

Frequencies (MHz)	Field strength (microvolts/meter)	Measurement distance (meters)
0.009-0.490	2400/F(kHz)	300
0.490-1.705	24000/F(kHz)	30
1.705-30.0	30	30
30-88	100	3
88-216	150	3
216-960	200	3
Above 960	500	3

NOTE:

1. The lower limit shall apply at the transition frequencies.
2. Emission level (dBuV/m) = 20 log Emission level (uV/m).
3. As shown in 15.35(b), for frequencies above 1000MHz, the field strength limits are based on average detector, however, the peak field strength of any emission shall not exceed the maximum permitted average limits, specified above by more than 20dB under any condition of modulation.
4. Section 15.205 restricted bands of operation shall compliance with the limits in Section 15.209.



A D T

4.2.2 TEST INSTRUMENTS

Test date: July 05 to 07, 2011

DESCRIPTION & MANUFACTURER	MODEL NO.	SERIAL NO.	CALIBRATED DATE	CALIBRATED UNTIL
Agilent Spectrum Analyzer	E4446A	MY48250254	July 14, 2010	July 13, 2011
Agilent Pre-Selector	N9039A	MY46520311	July 14, 2010	July 13, 2011
Agilent Signal Generator	N5181A	MY49060517	July 14, 2010	July 13, 2011
Mini-Circuits Pre-Amplifier	ZFL-1000VH2B	AMP-ZFL-03	Nov. 16, 2010	Nov. 15, 2011
Agilent Pre-Amplifier	8449B	3008A02578	July 04, 2011	July 03, 2012
Miteq Pre-Amplifier	AFS33-1800265 0-30-8P-44	881786	NA	NA
SCHWARZBECK Trilog Broadband Antenna	VULB 9168	9168-360	Apr. 14, 2011	Apr. 13, 2012
AISI Horn_Antenna	AIH.8018	0000320091110	Nov. 12, 2010	Nov. 11, 2011
SCHWARZBECK Horn_Antenna	BBHA 9170	9170-424	Oct. 08, 2010	Oct. 07, 2011
RF CABLE	NA	RF104-201 RF104-203 RF104-204	Dec. 27, 2010	Dec. 26, 2011
RF Cable	NA	CHGCAB_001	NA	NA
Software	ADT_Radiated_ V8.7.05	NA	NA	NA
CT Antenna Tower & Turn Table	NA	NA	NA	NA

Note: 1. The calibration interval of the above test instruments is 12 months and the calibrations are traceable to NML/ROC and NIST/USA.

2. The horn antenna, preamplifier (model: 8449B) are used only for the measurement of emission frequency above 1GHz if tested.

3. The test was performed in 966 Chamber No. G.

4. The FCC Site Registration No. is 966073.

5. The VCCI Site Registration No. is G-137.

6. The CANADA Site Registration No. is IC 7450H-2.

4.2.3 TEST PROCEDURES

- a. The EUT was placed on the top of a rotating table 0.8 meters above the ground at 3 meter chamber room. The table was rotated 360 degrees to determine the position of the highest radiation.
- b. The EUT was set 3 meters away from the interference-receiving antenna, which was mounted on the top of a variable-height antenna tower.
- c. The height of antenna is varied from one meter to four meters above the ground to determine the maximum value of the field strength. Both horizontal and vertical polarizations of the antenna are set to make the measurement.
- d. For each suspected emission, the EUT was arranged to its worst case and then the antenna was tuned to heights from 1 meter to 4 meters and the rotatable table was turned from 0 degrees to 360 degrees to find the maximum reading.
- e. The test-receiver system was set to quasi-peak detect function and specified bandwidth with maximum hold mode when the test frequency is below 1 GHz.
- f. The test-receiver system was set to peak and average detect function and specified bandwidth with maximum hold mode when the test frequency is above 1 GHz. If the peak reading value also meets average limit, measurement with the average detector is unnecessary.

NOTE:

1. The resolution bandwidth and video bandwidth of test receiver/spectrum analyzer is 120kHz for Quasi-peak detection (QP) at frequency below 1GHz.
2. The resolution bandwidth of test receiver/spectrum analyzer is 1 MHz and the video bandwidth is 3 MHz for Peak detection (PK) at frequency above 1GHz.
3. The resolution bandwidth of test receiver/spectrum analyzer is 1 MHz and the video bandwidth is 10 Hz for Average detection (AV) at frequency above 1GHz.

4.2.4 DEVIATION FROM TEST STANDARD

No deviation

4.2.5 TEST SETUP

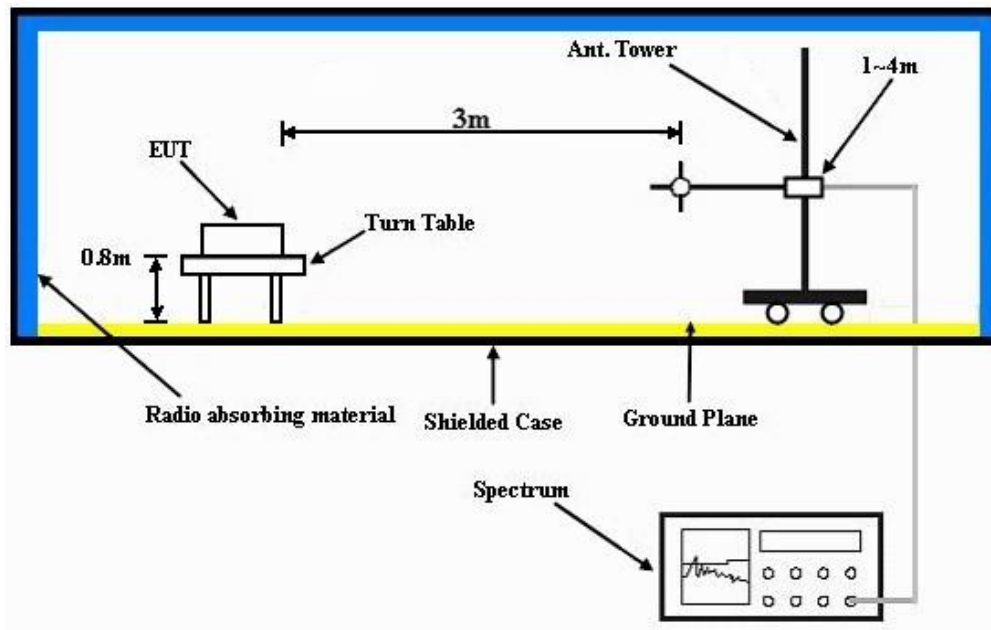

For the actual test configuration, please refer to the related item – Photographs of the Test Configuration.

4.2.6 EUT OPERATING CONDITIONS

Same as 4.1.6



A D T

4.2.7 TEST RESULTS

BELOW 1GHz WORST-CASE DATA : 802.11n (20MHz) OFDM MODULATION

EUT TEST CONDITION		MEASUREMENT DETAIL	
CHANNEL	Channel 6	FREQUENCY RANGE	Below 1000MHz
INPUT POWER (SYSTEM)	120Vac, 60 Hz	DETECTOR FUNCTION	Quasi-Peak
ENVIRONMENTAL CONDITIONS	24deg. C, 70%RH	TESTED BY	Nelson Teng

ANTENNA POLARITY & TEST DISTANCE: HORIZONTAL AT 3 M								
NO.	FREQ. (MHz)	EMISSION LEVEL (dBuV/m)	LIMIT (dBuV/m)	MARGIN (dB)	ANTENNA HEIGHT (m)	TABLE ANGLE (Degree)	RAW VALUE (dBuV)	CORRECTION FACTOR (dB/m)
1	99.99	27.1 QP	43.5	-16.4	1.75 H	92	17.59	9.48
2	232.38	38.8 QP	46.0	-7.2	1.50 H	322	26.20	12.59
3	298.70	34.8 QP	46.0	-11.3	1.00 H	253	19.62	15.13
4	527.97	37.6 QP	46.0	-8.4	1.50 H	39	17.06	20.54
5	699.56	33.2 QP	46.0	-12.8	1.00 H	155	10.66	22.58
6	832.67	32.1 QP	46.0	-13.9	1.50 H	360	6.51	25.63
ANTENNA POLARITY & TEST DISTANCE: VERTICAL AT 3 M								
NO.	FREQ. (MHz)	EMISSION LEVEL (dBuV/m)	LIMIT (dBuV/m)	MARGIN (dB)	ANTENNA HEIGHT (m)	TABLE ANGLE (Degree)	RAW VALUE (dBuV)	CORRECTION FACTOR (dB/m)
1	125.21	24.3 QP	43.5	-19.2	1.00 V	173	11.19	13.07
2	233.09	35.0 QP	46.0	-11.0	2.00 V	197	22.39	12.62
3	366.32	31.8 QP	46.0	-14.2	1.75 V	66	14.98	16.82
4	527.97	34.1 QP	46.0	-11.9	2.00 V	0	13.55	20.54
5	799.63	40.7 QP	46.0	-5.4	1.25 V	119	15.48	25.17
6	831.01	38.5 QP	46.0	-7.5	1.75 V	251	12.88	25.61

- REMARKS:**
1. Emission level (dBuV/m) = Raw Value (dBuV) + Correction Factor (dB/m).
 2. Correction Factor (dB/m) = Antenna Factor (dB/m) + Cable Factor (dB).
 3. The other emission levels were very low against the limit.
 4. Margin value = Emission level – Limit value.



A D T

ABOVE 1GHz WORST-CASE DATA

802.11b DSSS MODULATION

EUT TEST CONDITION		MEASUREMENT DETAIL	
CHANNEL	Channel 1	FREQUENCY RANGE	1 ~ 25GHz
INPUT POWER (SYSTEM)	120Vac, 60 Hz	DETECTOR FUNCTION	Peak (PK) Average (AV)
ENVIRONMENTAL CONDITIONS	26deg. C, 68%RH	TESTED BY	Frank Liu

ANTENNA POLARITY & TEST DISTANCE: HORIZONTAL AT 3 M

NO.	FREQ. (MHz)	EMISSION LEVEL (dBuV/m)	LIMIT (dBuV/m)	MARGIN (dB)	ANTENNA HEIGHT (m)	TABLE ANGLE (Degree)	RAW VALUE (dBuV)	CORRECTION FACTOR (dB/m)
1	2390.00	57.0 PK	74.0	-17.0	1.00 H	42	25.34	31.66
2	2390.00	44.9 AV	54.0	-9.1	1.00 H	42	13.24	31.66
3	*2412.00	101.9 PK			1.00 H	42	70.17	31.73
4	*2412.00	99.3 AV			1.00 H	42	67.57	31.73
5	4824.00	49.6 PK	74.0	-24.4	1.52 H	48	10.63	38.97
6	4824.00	39.1 AV	54.0	-14.9	1.52 H	48	0.13	38.97
7	12060.00	57.8 PK	74.0	-16.2	1.36 H	20	9.55	48.25
8	12060.00	46.7 AV	54.0	-7.3	1.36 H	20	-1.55	48.25

ANTENNA POLARITY & TEST DISTANCE: VERTICAL AT 3 M

NO.	FREQ. (MHz)	EMISSION LEVEL (dBuV/m)	LIMIT (dBuV/m)	MARGIN (dB)	ANTENNA HEIGHT (m)	TABLE ANGLE (Degree)	RAW VALUE (dBuV)	CORRECTION FACTOR (dB/m)
1	2390.00	67.8 PK	74.0	-6.2	1.00 V	13	36.14	31.66
2	2390.00	51.9 AV	54.0	-2.1	1.00 V	13	20.24	31.66
3	*2412.00	109.0 PK			1.00 V	13	77.27	31.73
4	*2412.00	106.1 AV			1.00 V	13	74.37	31.73
5	4824.00	50.4 PK	74.0	-23.6	1.14 V	43	11.43	38.97
6	4824.00	46.6 AV	54.0	-7.4	1.14 V	43	7.63	38.97
7	12060.00	58.0 PK	74.0	-16.0	1.00 V	58	9.75	48.25
8	12060.00	47.3 AV	54.0	-6.7	1.00 V	58	-0.95	48.25

- REMARKS:**
1. Emission level (dBuV/m) = Raw Value (dBuV) + Correction Factor (dB/m).
 2. Correction Factor (dB/m) = Antenna Factor (dB/m) + Cable Factor (dB).
 3. The other emission levels were very low against the limit.
 4. Margin value = Emission level – Limit value.
 5. “ * “: Fundamental frequency.



A D T

EUT TEST CONDITION		MEASUREMENT DETAIL	
CHANNEL	Channel 6	FREQUENCY RANGE	1 ~ 25GHz
INPUT POWER (SYSTEM)	120Vac, 60 Hz	DETECTOR FUNCTION	Peak (PK) Average (AV)
ENVIRONMENTAL CONDITIONS	26deg. C, 68%RH	TESTED BY	Frank Liu

ANTENNA POLARITY & TEST DISTANCE: HORIZONTAL AT 3 M								
NO.	FREQ. (MHz)	EMISSION LEVEL (dBuV/m)	LIMIT (dBuV/m)	MARGIN (dB)	ANTENNA HEIGHT (m)	TABLE ANGLE (Degree)	RAW VALUE (dBuV)	CORRECTION FACTOR (dB/m)
1	*2437.00	104.7 PK			1.00 H	41	72.89	31.81
2	*2437.00	102.1 AV			1.00 H	41	70.29	31.81
3	4874.00	47.5 PK	74.0	-26.5	1.05 H	34	8.36	39.14
4	4874.00	36.6 AV	54.0	-17.4	1.05 H	34	-2.54	39.14
5	7311.00	54.6 PK	74.0	-19.4	1.07 H	46	7.97	46.63
6	7311.00	42.0 AV	54.0	-12.0	1.07 H	46	-4.63	46.63
ANTENNA POLARITY & TEST DISTANCE: VERTICAL AT 3 M								
NO.	FREQ. (MHz)	EMISSION LEVEL (dBuV/m)	LIMIT (dBuV/m)	MARGIN (dB)	ANTENNA HEIGHT (m)	TABLE ANGLE (Degree)	RAW VALUE (dBuV)	CORRECTION FACTOR (dB/m)
1	*2437.00	108.6 PK			1.00 V	23	76.79	31.81
2	*2437.00	105.4 AV			1.00 V	23	73.59	31.81
3	4874.00	51.3 PK	74.0	-22.7	1.46 V	42	12.16	39.14
4	4874.00	47.3 AV	54.0	-6.7	1.46 V	42	8.16	39.14
5	7311.00	57.1 PK	74.0	-16.9	1.00 V	20	10.47	46.63
6	7311.00	50.3 AV	54.0	-3.7	1.00 V	20	3.67	46.63

- REMARKS:**
1. Emission level (dBuV/m) = Raw Value (dBuV) + Correction Factor (dB/m).
 2. Correction Factor (dB/m) = Antenna Factor (dB/m) + Cable Factor (dB).
 3. The other emission levels were very low against the limit.
 4. Margin value = Emission level – Limit value.
 5. “ * “: Fundamental frequency.



A D T

EUT TEST CONDITION		MEASUREMENT DETAIL	
CHANNEL	Channel 11	FREQUENCY RANGE	1 ~ 25GHz
INPUT POWER (SYSTEM)	120Vac, 60 Hz	DETECTOR FUNCTION	Peak (PK) Average (AV)
ENVIRONMENTAL CONDITIONS	26deg. C, 68%RH	TESTED BY	Frank Liu

ANTENNA POLARITY & TEST DISTANCE: HORIZONTAL AT 3 M								
NO.	FREQ. (MHz)	EMISSION LEVEL (dBuV/m)	LIMIT (dBuV/m)	MARGIN (dB)	ANTENNA HEIGHT (m)	TABLE ANGLE (Degree)	RAW VALUE (dBuV)	CORRECTION FACTOR (dB/m)
1	*2462.00	106.5 PK			1.00 H	38	74.61	31.89
2	*2462.00	104.2 AV			1.00 H	38	72.31	31.89
3	2483.50	57.8 PK	74.0	-16.2	1.00 H	38	25.83	31.97
4	2483.50	45.8 AV	54.0	-8.2	1.00 H	38	13.83	31.97
5	4924.00	47.3 PK	74.0	-26.7	1.08 H	48	7.99	39.31
6	4924.00	36.4 AV	54.0	-17.6	1.08 H	48	-2.91	39.31
7	7386.00	54.7 PK	74.0	-19.3	1.11 H	48	8.10	46.60
8	7386.00	42.3 AV	54.0	-11.7	1.11 H	48	-4.30	46.60
ANTENNA POLARITY & TEST DISTANCE: VERTICAL AT 3 M								
NO.	FREQ. (MHz)	EMISSION LEVEL (dBuV/m)	LIMIT (dBuV/m)	MARGIN (dB)	ANTENNA HEIGHT (m)	TABLE ANGLE (Degree)	RAW VALUE (dBuV)	CORRECTION FACTOR (dB/m)
1	*2462.00	109.9 PK			1.12 V	40	78.01	31.89
2	*2462.00	107.7 AV			1.12 V	40	75.81	31.89
3	2483.50	66.3 PK	74.0	-7.7	1.10 V	42	34.33	31.97
4	2483.50	49.0 AV	54.0	-5.0	1.10 V	42	17.03	31.97
5	4924.00	52.5 PK	74.0	-21.5	1.43 V	53	13.19	39.31
6	4924.00	48.1 AV	54.0	-5.9	1.43 V	53	8.79	39.31
7	7386.00	58.4 PK	74.0	-15.6	1.41 V	35	11.80	46.60
8	7386.00	51.0 AV	54.0	-3.0	1.41 V	35	4.40	46.60

- REMARKS:**
1. Emission level (dBuV/m) = Raw Value (dBuV) + Correction Factor (dB/m).
 2. Correction Factor (dB/m) = Antenna Factor (dB/m) + Cable Factor (dB).
 3. The other emission levels were very low against the limit.
 4. Margin value = Emission level – Limit value.
 5. “ * “: Fundamental frequency.

RESTRICTED BANDEDGE (802.11b MODE, CH1, HORIZONTAL)

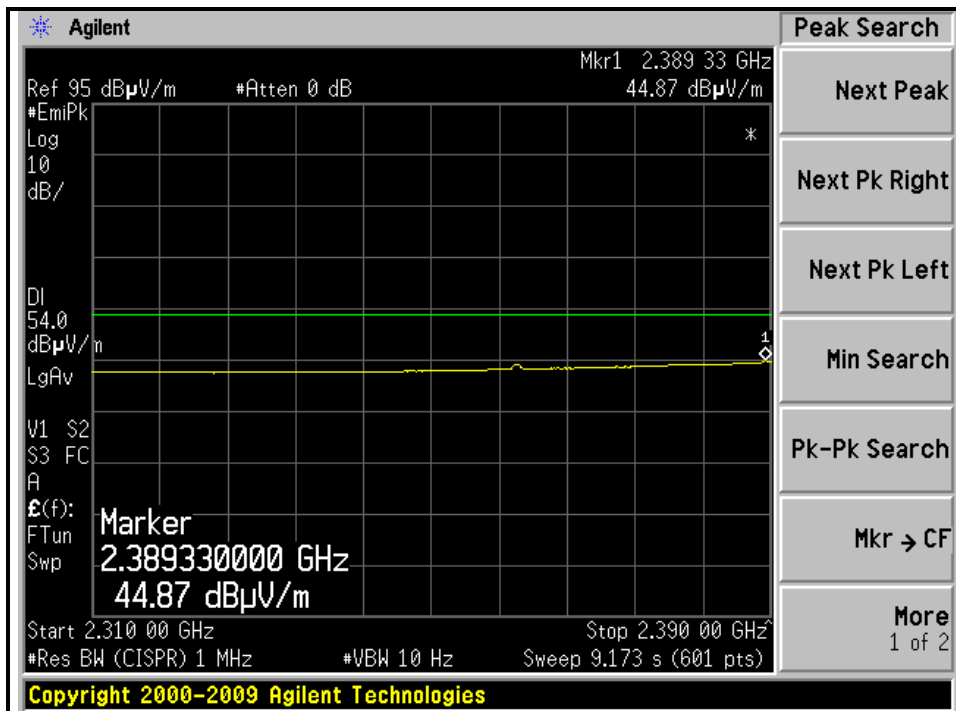
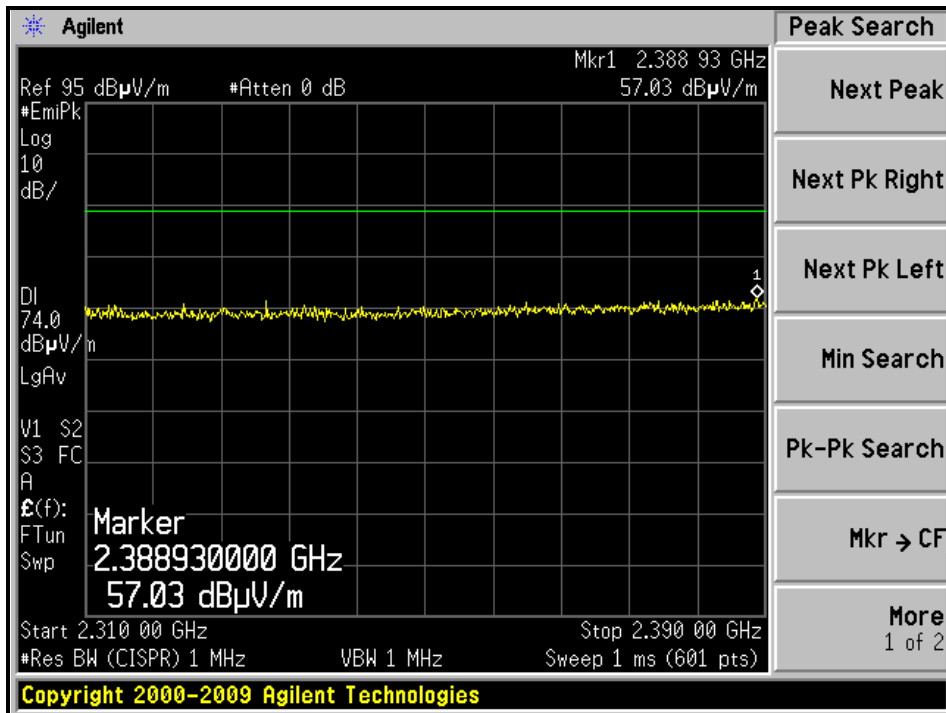



A D T

RESTRICTED BANDEDGE (802.11b MODE, CH1, VERTICAL)

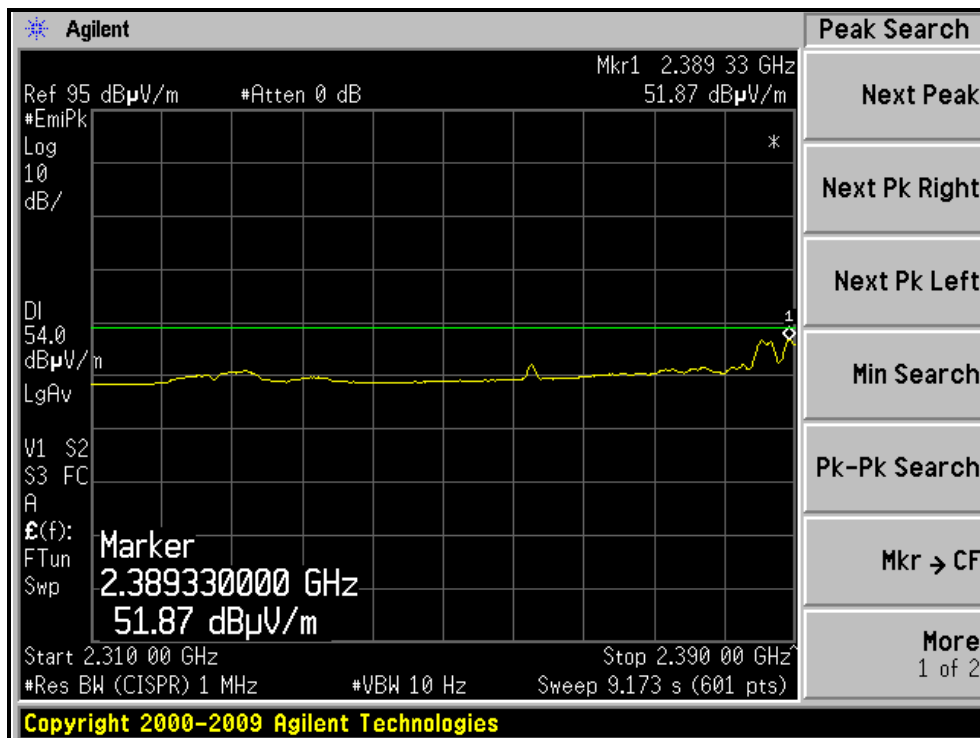
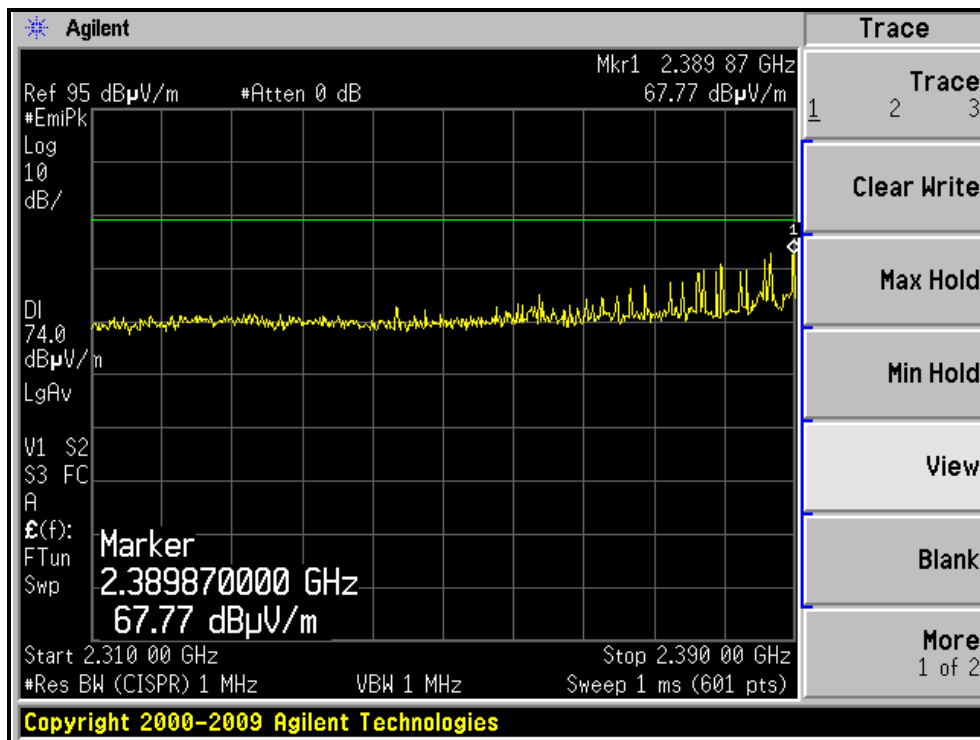



A D T

RESTRICTED BANDEDGE (802.11b MODE, CH11, HORIZONTAL)

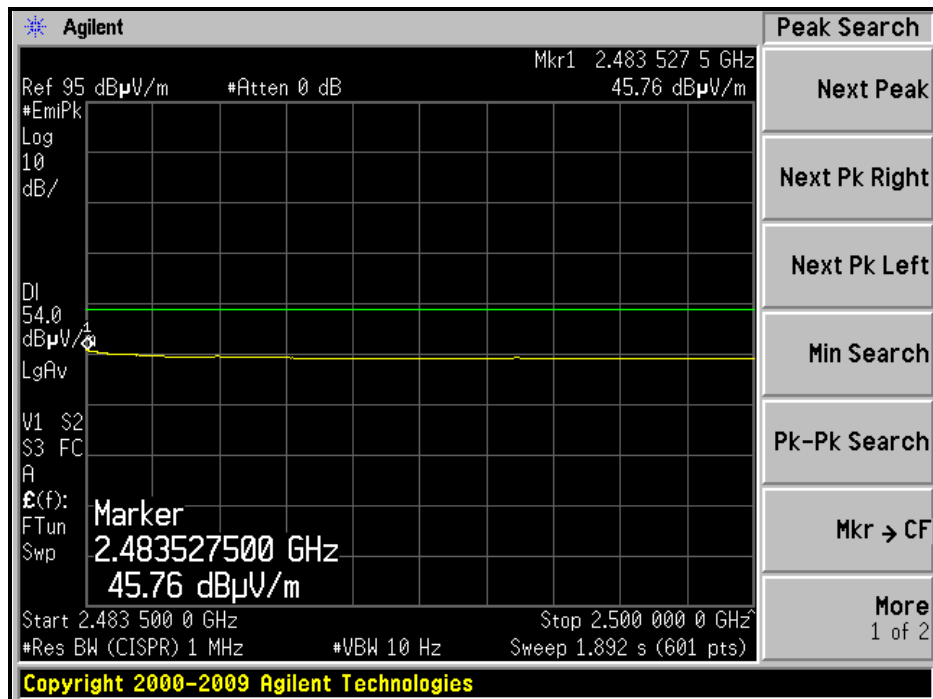
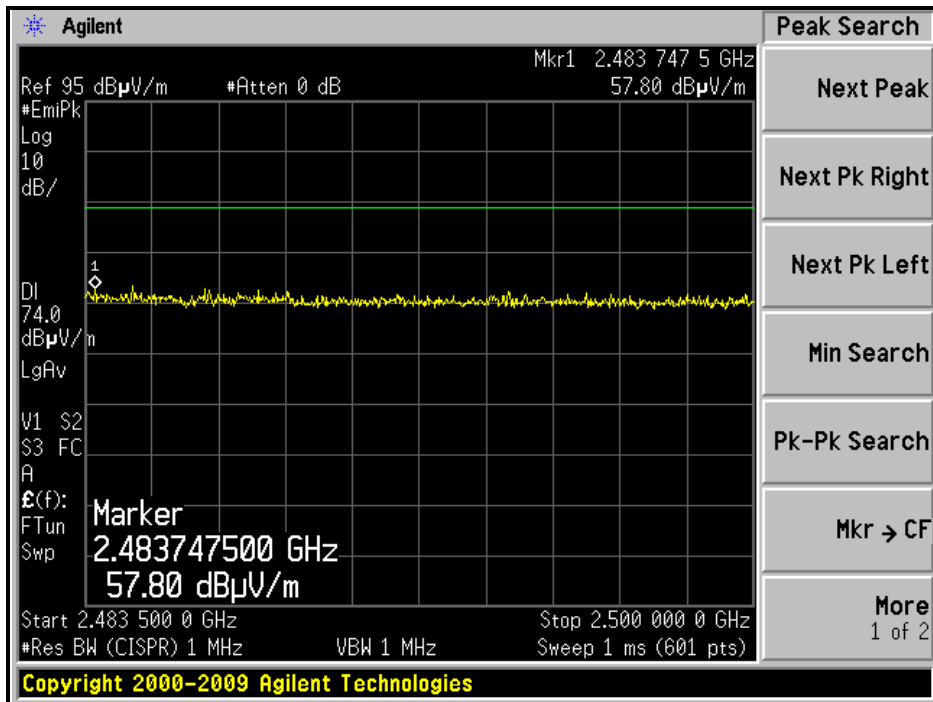



A D T

RESTRICTED BANDEDGE (802.11b MODE, CH11, VERTICAL)

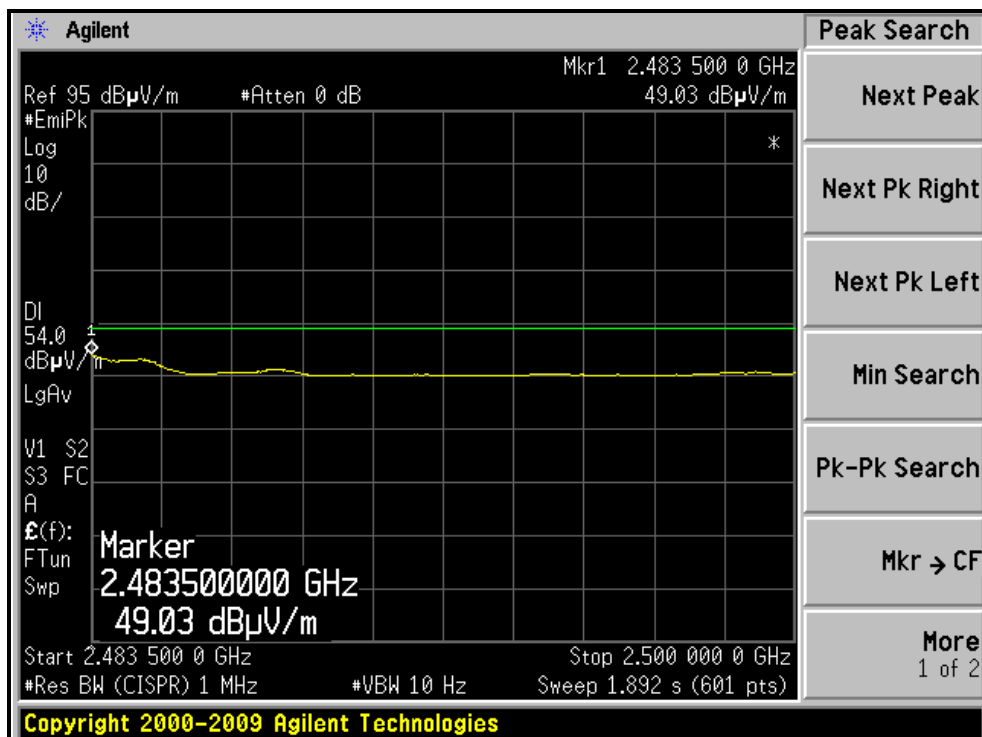
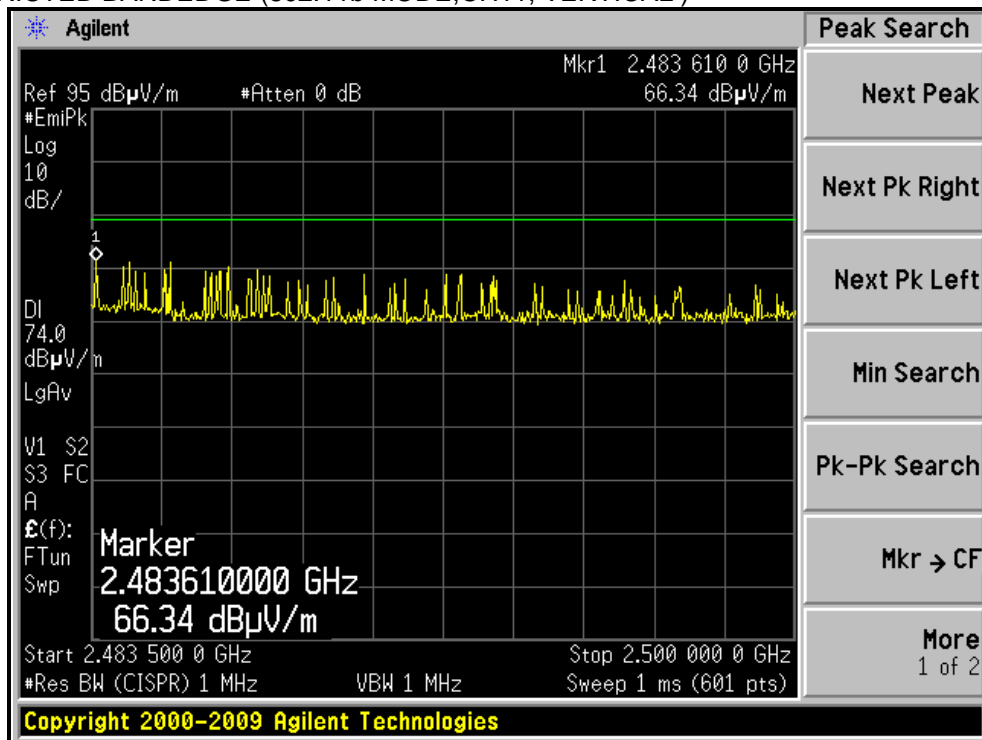



A D T

802.11g OFDM MODULATION

EUT TEST CONDITION		MEASUREMENT DETAIL	
CHANNEL	Channel 1	FREQUENCY RANGE	1 ~ 25GHz
INPUT POWER (SYSTEM)	120Vac, 60 Hz	DETECTOR FUNCTION	Peak (PK) Average (AV)
ENVIRONMENTAL CONDITIONS	26deg. C, 68%RH	TESTED BY	Frank Liu

ANTENNA POLARITY & TEST DISTANCE: HORIZONTAL AT 3 M								
NO.	FREQ. (MHz)	EMISSION LEVEL (dBuV/m)	LIMIT (dBuV/m)	MARGIN (dB)	ANTENNA HEIGHT (m)	TABLE ANGLE (Degree)	RAW VALUE (dBuV)	CORRECTION FACTOR (dB/m)
1	2390.00	68.8 PK	74.0	-5.2	1.00 H	41	37.14	31.66
2	2390.00	49.7 AV	54.0	-4.3	1.00 H	41	18.04	31.66
3	*2412.00	106.1 PK			1.00 H	41	74.37	31.73
4	*2412.00	95.5 AV			1.00 H	41	63.77	31.73
5	4824.00	46.2 PK	74.0	-27.8	1.01 H	39	7.23	38.97
6	4824.00	34.5 AV	54.0	-19.5	1.01 H	39	-4.47	38.97
ANTENNA POLARITY & TEST DISTANCE: VERTICAL AT 3 M								
NO.	FREQ. (MHz)	EMISSION LEVEL (dBuV/m)	LIMIT (dBuV/m)	MARGIN (dB)	ANTENNA HEIGHT (m)	TABLE ANGLE (Degree)	RAW VALUE (dBuV)	CORRECTION FACTOR (dB/m)
1	2390.00	70.7 PK	74.0	-3.3	1.17 V	357	39.04	31.66
2	2390.00	52.6 AV	54.0	-1.4	1.17 V	357	20.94	31.66
3	*2412.00	110.0 PK			1.17 V	357	78.27	31.73
4	*2412.00	100.7 AV			1.17 V	357	68.97	31.73
5	4824.00	46.7 PK	74.0	-27.3	1.42 V	59	7.73	38.97
6	4824.00	34.6 AV	54.0	-19.4	1.42 V	59	-4.37	38.97

- REMARKS:**
1. Emission level (dBuV/m) = Raw Value (dBuV) + Correction Factor (dB/m).
 2. Correction Factor (dB/m) = Antenna Factor (dB/m) + Cable Factor (dB).
 3. The other emission levels were very low against the limit.
 4. Margin value = Emission level – Limit value.
 5. “ * “: Fundamental frequency.



A D T

EUT TEST CONDITION		MEASUREMENT DETAIL	
CHANNEL	Channel 6	FREQUENCY RANGE	1 ~ 25GHz
INPUT POWER (SYSTEM)	120Vac, 60 Hz	DETECTOR FUNCTION	Peak (PK) Average (AV)
ENVIRONMENTAL CONDITIONS	26deg. C, 68%RH	TESTED BY	Frank Liu

ANTENNA POLARITY & TEST DISTANCE: HORIZONTAL AT 3 M

NO.	FREQ. (MHz)	EMISSION LEVEL (dBuV/m)	LIMIT (dBuV/m)	MARGIN (dB)	ANTENNA HEIGHT (m)	TABLE ANGLE (Degree)	RAW VALUE (dBuV)	CORRECTION FACTOR (dB/m)
1	*2437.00	108.9 PK			1.01 H	40	77.09	31.81
2	*2437.00	98.1 AV			1.01 H	40	66.29	31.81
3	4874.00	47.6 PK	74.0	-26.4	1.00 H	40	8.46	39.14
4	4874.00	36.8 AV	54.0	-17.2	1.00 H	40	-2.34	39.14
5	7311.00	54.5 PK	74.0	-19.5	1.05 H	44	7.87	46.63
6	7311.00	42.2 AV	54.0	-11.8	1.05 H	44	-4.43	46.63

ANTENNA POLARITY & TEST DISTANCE: VERTICAL AT 3 M

NO.	FREQ. (MHz)	EMISSION LEVEL (dBuV/m)	LIMIT (dBuV/m)	MARGIN (dB)	ANTENNA HEIGHT (m)	TABLE ANGLE (Degree)	RAW VALUE (dBuV)	CORRECTION FACTOR (dB/m)
1	*2437.00	114.2 PK			1.13 V	352	82.39	31.81
2	*2437.00	105.4 AV			1.13 V	352	73.59	31.81
3	2483.50	63.7 PK	74.0	-10.3	1.13 V	341	31.73	31.97
4	2483.50	49.1 AV	54.0	-4.9	1.13 V	341	17.13	31.97
5	4874.00	47.9 PK	74.0	-26.1	1.69 V	45	8.76	39.14
6	4874.00	36.4 AV	54.0	-17.6	1.69 V	45	-2.74	39.14
7	7311.00	54.8 PK	74.0	-19.2	1.06 V	53	8.17	46.63
8	7311.00	42.2 AV	54.0	-11.8	1.06 V	53	-4.43	46.63

- REMARKS:**
1. Emission level (dBuV/m) = Raw Value (dBuV) + Correction Factor (dB/m).
 2. Correction Factor (dB/m) = Antenna Factor (dB/m) + Cable Factor (dB).
 3. The other emission levels were very low against the limit.
 4. Margin value = Emission level – Limit value.
 5. “ * “: Fundamental frequency.



A D T

EUT TEST CONDITION		MEASUREMENT DETAIL	
CHANNEL	Channel 11	FREQUENCY RANGE	1 ~ 25GHz
INPUT POWER (SYSTEM)	120Vac, 60 Hz	DETECTOR FUNCTION	Peak (PK) Average (AV)
ENVIRONMENTAL CONDITIONS	26deg. C, 68%RH	TESTED BY	Frank Liu

ANTENNA POLARITY & TEST DISTANCE: HORIZONTAL AT 3 M

NO.	FREQ. (MHz)	EMISSION LEVEL (dBuV/m)	LIMIT (dBuV/m)	MARGIN (dB)	ANTENNA HEIGHT (m)	TABLE ANGLE (Degree)	RAW VALUE (dBuV)	CORRECTION FACTOR (dB/m)
1	*2462.00	104.5 PK			1.00 H	39	72.61	31.89
2	*2462.00	94.2 AV			1.00 H	39	62.31	31.89
3	2483.50	68.6 PK	74.0	-5.4	1.00 H	39	36.63	31.97
4	2483.50	47.2 AV	54.0	-6.8	1.00 H	39	15.23	31.97
5	4924.00	47.5 PK	74.0	-26.5	1.06 H	33	8.19	39.31
6	4924.00	36.7 AV	54.0	-17.3	1.06 H	33	-2.61	39.31
7	7386.00	54.4 PK	74.0	-19.6	1.05 H	46	7.80	46.60
8	7386.00	42.0 AV	54.0	-12.0	1.05 H	46	-4.60	46.60

ANTENNA POLARITY & TEST DISTANCE: VERTICAL AT 3 M

NO.	FREQ. (MHz)	EMISSION LEVEL (dBuV/m)	LIMIT (dBuV/m)	MARGIN (dB)	ANTENNA HEIGHT (m)	TABLE ANGLE (Degree)	RAW VALUE (dBuV)	CORRECTION FACTOR (dB/m)
1	*2462.00	110.0 PK			1.16 V	7	78.11	31.89
2	*2462.00	100.0 AV			1.16 V	7	68.11	31.89
3	2483.50	73.3 PK	74.0	-0.7	1.16 V	7	41.33	31.97
4	2483.50	52.9 AV	54.0	-1.1	1.16 V	7	20.93	31.97
5	4924.00	47.3 PK	74.0	-26.7	1.64 V	29	7.99	39.31
6	4924.00	36.7 AV	54.0	-17.3	1.64 V	29	-2.61	39.31
7	7386.00	54.8 PK	74.0	-19.2	1.03 V	54	8.20	46.60
8	7386.00	42.4 AV	54.0	-11.6	1.03 V	54	-4.20	46.60

- REMARKS:**
1. Emission level (dBuV/m) = Raw Value (dBuV) + Correction Factor (dB/m).
 2. Correction Factor (dB/m) = Antenna Factor (dB/m) + Cable Factor (dB).
 3. The other emission levels were very low against the limit.
 4. Margin value = Emission level – Limit value.
 5. “ * “: Fundamental frequency.

RESTRICTED BANDEDGE (802.11g MODE, CH1, HORIZONTAL)

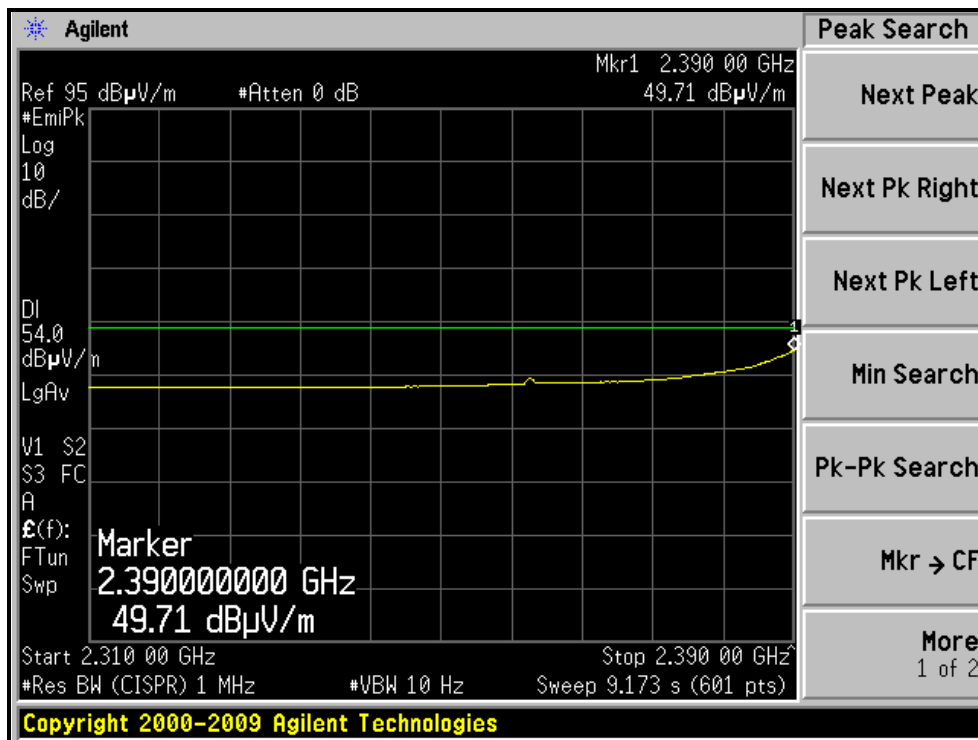
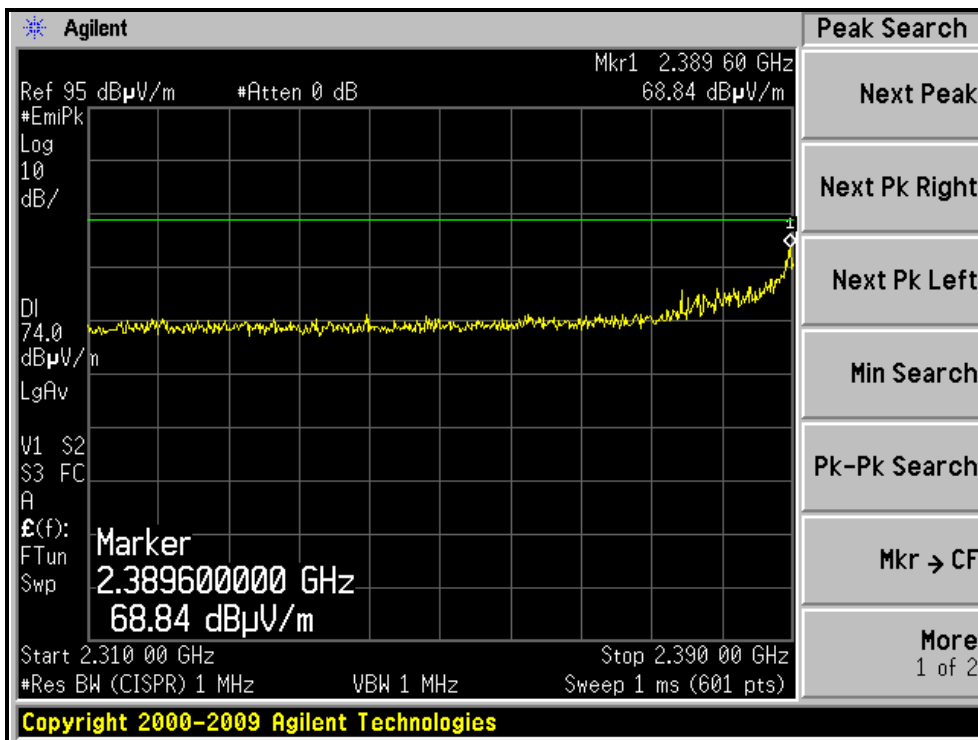



A D T

RESTRICTED BANDEDGE (802.11g MODE,CH1, VERTICAL)

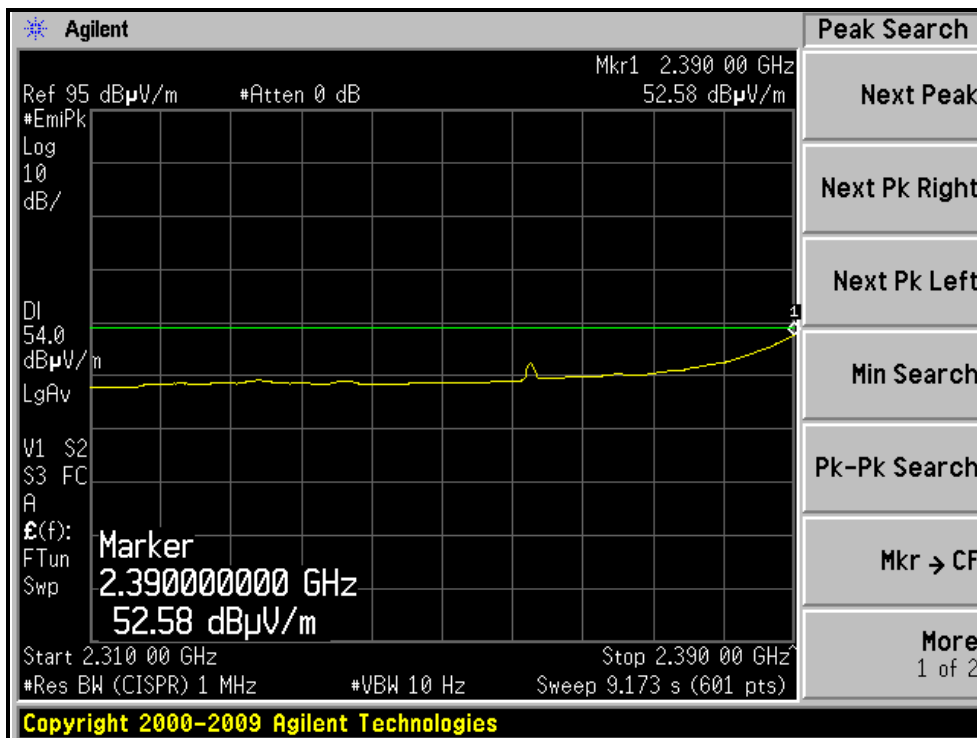
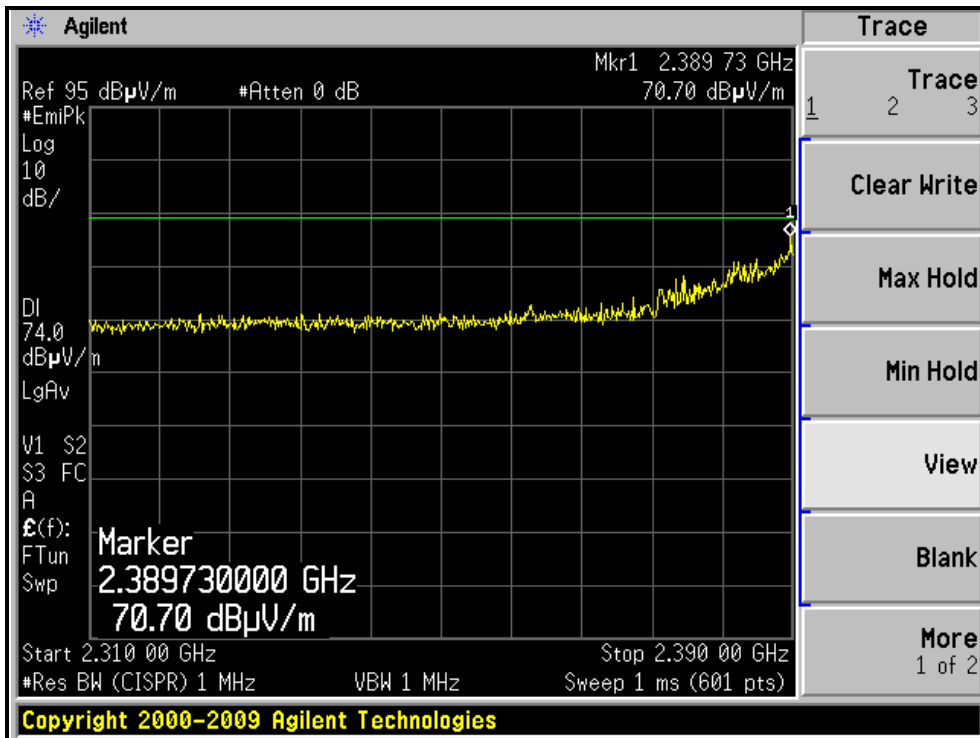



A D T

RESTRICTED BANDEDGE (802.11g MODE, CH11, HORIZONTAL)

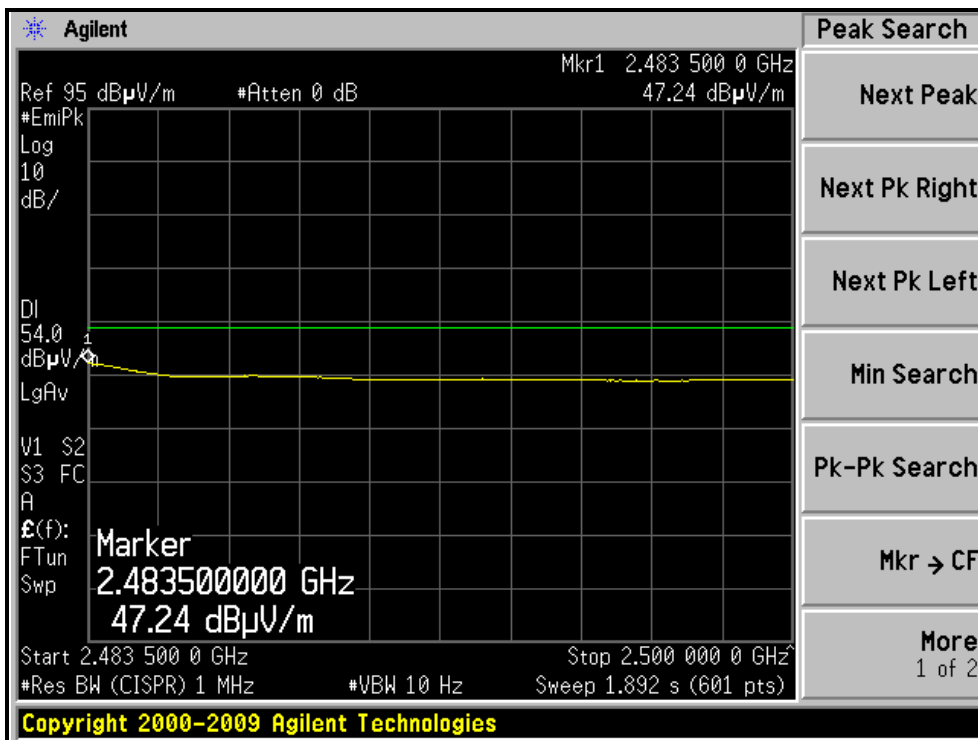
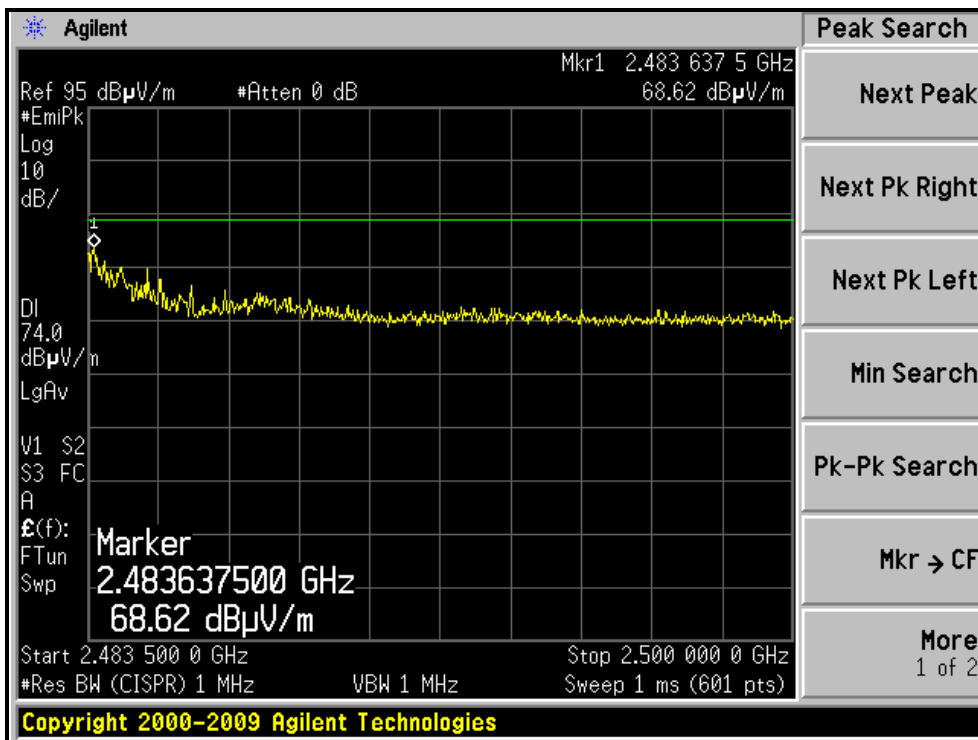

RESTRICTED BANDEDGE (802.11g MODE, CH11, VERTICAL)

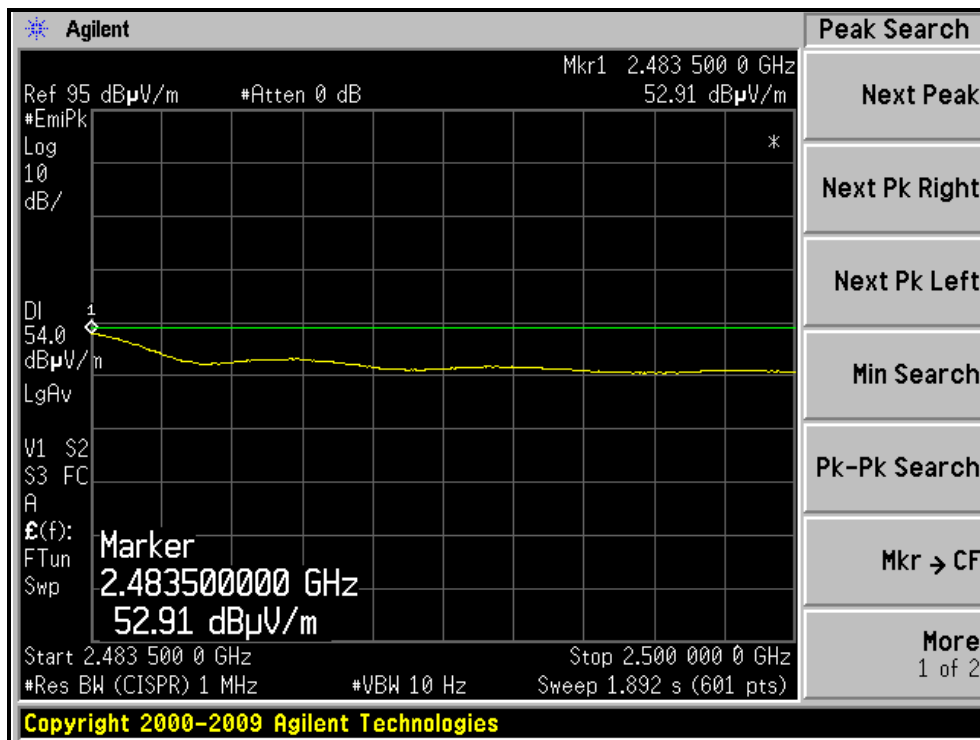
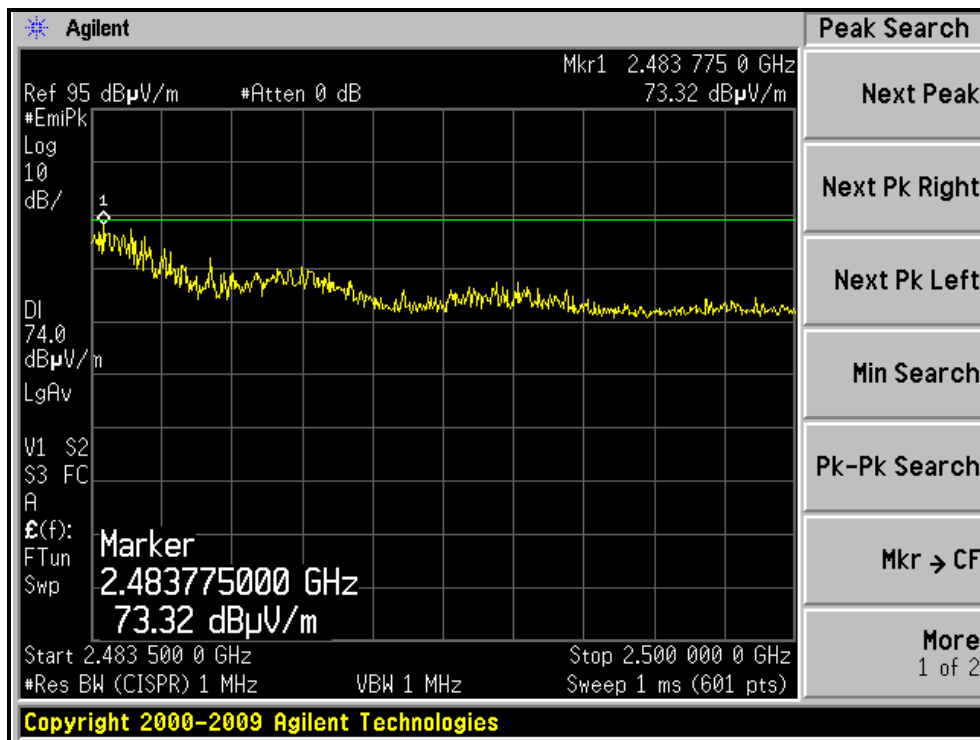



A D T

802.11n (20MHz) OFDM MODULATION

EUT TEST CONDITION		MEASUREMENT DETAIL	
CHANNEL	Channel 1	FREQUENCY RANGE	1 ~ 25GHz
INPUT POWER (SYSTEM)	120Vac, 60 Hz	DETECTOR FUNCTION	Peak (PK) Average (AV)
ENVIRONMENTAL CONDITIONS	26deg. C, 68%RH	TESTED BY	Frank Liu

ANTENNA POLARITY & TEST DISTANCE: HORIZONTAL AT 3 M								
NO.	FREQ. (MHz)	EMISSION LEVEL (dBuV/m)	LIMIT (dBuV/m)	MARGIN (dB)	ANTENNA HEIGHT (m)	TABLE ANGLE (Degree)	RAW VALUE (dBuV)	CORRECTION FACTOR (dB/m)
1	2390.00	64.4 PK	74.0	-9.6	1.00 H	43	32.74	31.66
2	2390.00	48.8 AV	54.0	-5.2	1.00 H	43	17.14	31.66
3	*2412.00	104.7 PK			1.01 H	43	72.97	31.73
4	*2412.00	92.0 AV			1.01 H	43	60.27	31.73
5	4824.00	46.3 PK	74.0	-27.7	1.05 H	37	7.33	38.97
6	4824.00	34.6 AV	54.0	-19.4	1.05 H	37	-4.37	38.97
ANTENNA POLARITY & TEST DISTANCE: VERTICAL AT 3 M								
NO.	FREQ. (MHz)	EMISSION LEVEL (dBuV/m)	LIMIT (dBuV/m)	MARGIN (dB)	ANTENNA HEIGHT (m)	TABLE ANGLE (Degree)	RAW VALUE (dBuV)	CORRECTION FACTOR (dB/m)
1	2390.00	70.1 PK	74.0	-3.9	1.18 V	26	38.44	31.66
2	2390.00	51.5 AV	54.0	-2.5	1.18 V	26	19.84	31.66
3	*2412.00	108.8 PK			1.16 V	25	77.07	31.73
4	*2412.00	97.7 AV			1.16 V	25	65.97	31.73
5	4824.00	46.5 PK	74.0	-27.5	1.44 V	52	7.53	38.97
6	4824.00	34.1 AV	54.0	-19.9	1.44 V	52	-4.87	38.97

- REMARKS:**
1. Emission level (dBuV/m) = Raw Value (dBuV) + Correction Factor (dB/m).
 2. Correction Factor (dB/m) = Antenna Factor (dB/m) + Cable Factor (dB).
 3. The other emission levels were very low against the limit.
 4. Margin value = Emission level – Limit value.
 5. “ * “: Fundamental frequency.



A D T

EUT TEST CONDITION		MEASUREMENT DETAIL	
CHANNEL	Channel 6	FREQUENCY RANGE	1 ~ 25GHz
INPUT POWER (SYSTEM)	120Vac, 60 Hz	DETECTOR FUNCTION	Peak (PK) Average (AV)
ENVIRONMENTAL CONDITIONS	26deg. C, 68%RH	TESTED BY	Frank Liu

ANTENNA POLARITY & TEST DISTANCE: HORIZONTAL AT 3 M								
NO.	FREQ. (MHz)	EMISSION LEVEL (dBuV/m)	LIMIT (dBuV/m)	MARGIN (dB)	ANTENNA HEIGHT (m)	TABLE ANGLE (Degree)	RAW VALUE (dBuV)	CORRECTION FACTOR (dB/m)
1	*2437.00	107.9 PK			1.01 H	38	76.09	31.81
2	*2437.00	94.6 AV			1.01 H	38	62.79	31.81
3	4874.00	47.4 PK	74.0	-26.6	1.00 H	29	8.26	39.14
4	4874.00	36.6 AV	54.0	-17.4	1.00 H	29	-2.54	39.14
5	7311.00	54.3 PK	74.0	-19.7	1.06 H	39	7.67	46.63
6	7311.00	42.1 AV	54.0	-11.9	1.06 H	39	-4.53	46.63
ANTENNA POLARITY & TEST DISTANCE: VERTICAL AT 3 M								
NO.	FREQ. (MHz)	EMISSION LEVEL (dBuV/m)	LIMIT (dBuV/m)	MARGIN (dB)	ANTENNA HEIGHT (m)	TABLE ANGLE (Degree)	RAW VALUE (dBuV)	CORRECTION FACTOR (dB/m)
1	*2437.00	113.4 PK			1.15 V	18	81.59	31.81
2	*2437.00	102.4 AV			1.15 V	18	70.59	31.81
3	4874.00	47.9 PK	74.0	-26.1	1.70 V	55	8.76	39.14
4	4874.00	36.2 AV	54.0	-17.8	1.70 V	55	-2.94	39.14
5	7311.00	54.7 PK	74.0	-19.3	1.07 V	49	8.07	46.63
6	7311.00	42.4 AV	54.0	-11.6	1.07 V	49	-4.23	46.63

- REMARKS:**
1. Emission level (dBuV/m) = Raw Value (dBuV) + Correction Factor (dB/m).
 2. Correction Factor (dB/m) = Antenna Factor (dB/m) + Cable Factor (dB).
 3. The other emission levels were very low against the limit.
 4. Margin value = Emission level – Limit value.
 5. “ * “: Fundamental frequency.



A D T

EUT TEST CONDITION		MEASUREMENT DETAIL	
CHANNEL	Channel 11	FREQUENCY RANGE	1 ~ 25GHz
INPUT POWER (SYSTEM)	120Vac, 60 Hz	DETECTOR FUNCTION	Peak (PK) Average (AV)
ENVIRONMENTAL CONDITIONS	26deg. C, 68%RH	TESTED BY	Frank Liu

ANTENNA POLARITY & TEST DISTANCE: HORIZONTAL AT 3 M

NO.	FREQ. (MHz)	EMISSION LEVEL (dBuV/m)	LIMIT (dBuV/m)	MARGIN (dB)	ANTENNA HEIGHT (m)	TABLE ANGLE (Degree)	RAW VALUE (dBuV)	CORRECTION FACTOR (dB/m)
1	*2462.00	103.9 PK			1.00 H	38	72.01	31.89
2	*2462.00	90.1 AV			1.00 H	38	58.21	31.89
3	2483.50	66.2 PK	74.0	-7.8	1.00 H	38	34.23	31.97
4	2483.50	45.6 AV	54.0	-8.4	1.00 H	38	13.63	31.97
5	4924.00	47.7 PK	74.0	-26.3	1.04 H	30	8.39	39.31
6	4924.00	36.7 AV	54.0	-17.3	1.04 H	30	-2.61	39.31
7	7386.00	54.6 PK	74.0	-19.4	1.07 H	57	8.00	46.60
8	7386.00	42.2 AV	54.0	-11.8	1.07 H	57	-4.40	46.60

ANTENNA POLARITY & TEST DISTANCE: VERTICAL AT 3 M

NO.	FREQ. (MHz)	EMISSION LEVEL (dBuV/m)	LIMIT (dBuV/m)	MARGIN (dB)	ANTENNA HEIGHT (m)	TABLE ANGLE (Degree)	RAW VALUE (dBuV)	CORRECTION FACTOR (dB/m)
1	*2462.00	108.7 PK			1.14 V	15	76.81	31.89
2	*2462.00	97.5 AV			1.14 V	15	65.61	31.89
3	2483.50	70.1 PK	74.0	-3.9	1.13 V	14	38.13	31.97
4	2483.50	48.1 AV	54.0	-5.9	1.13 V	14	16.13	31.97
5	4924.00	47.8 PK	74.0	-26.2	1.74 V	35	8.49	39.31
6	4924.00	36.5 AV	54.0	-17.5	1.74 V	35	-2.81	39.31
7	7386.00	54.8 PK	74.0	-19.2	1.10 V	63	8.20	46.60
8	7386.00	42.3 AV	54.0	-11.7	1.10 V	63	-4.30	46.60

- REMARKS:**
1. Emission level (dBuV/m) = Raw Value (dBuV) + Correction Factor (dB/m).
 2. Correction Factor (dB/m) = Antenna Factor (dB/m) + Cable Factor (dB).
 3. The other emission levels were very low against the limit.
 4. Margin value = Emission level – Limit value.
 5. “ * “: Fundamental frequency.



A D T

RESTRICTED BANDEDGE (802.11n (20MHz) MODE,CH1, HORIZONTAL)

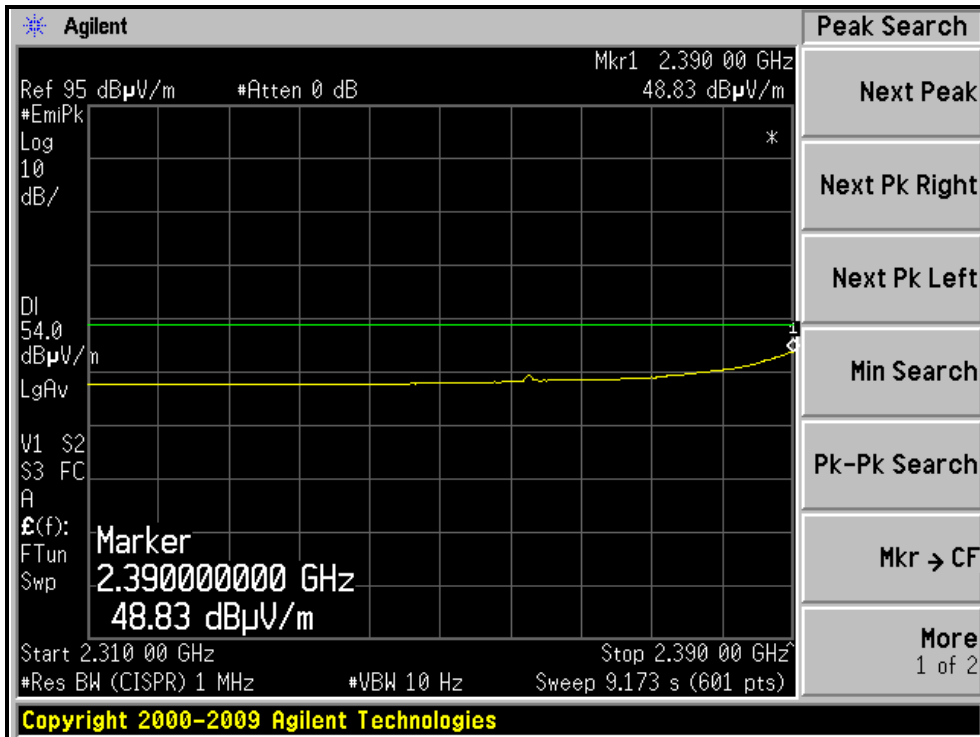
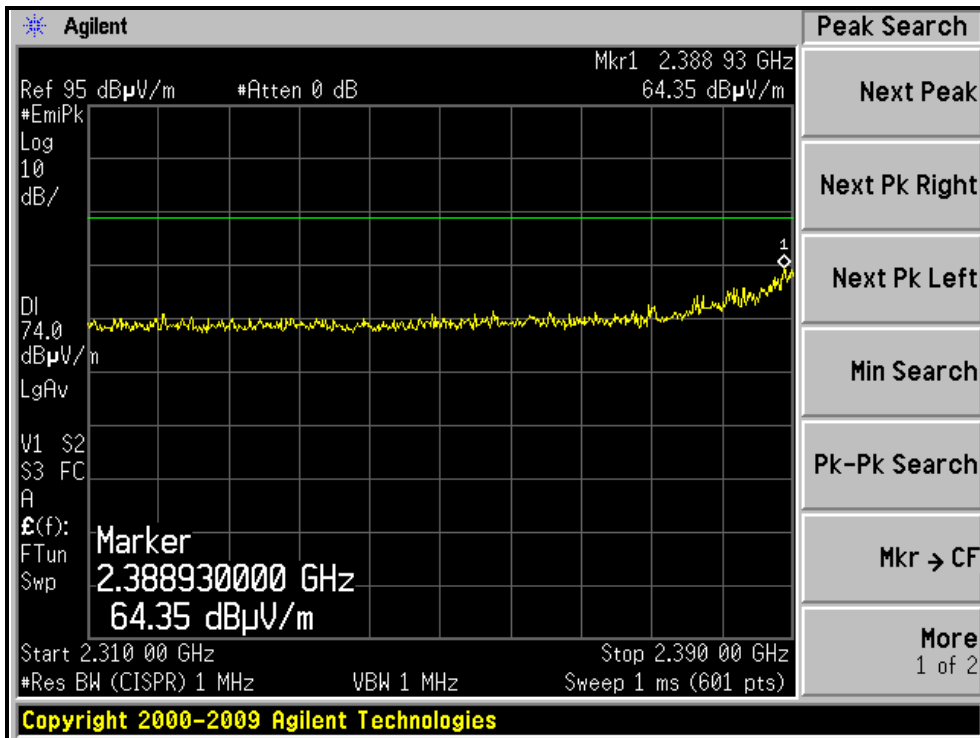



A D T

RESTRICTED BANDEDGE (802.11n (20MHz) MODE,CH1, VERTICAL)

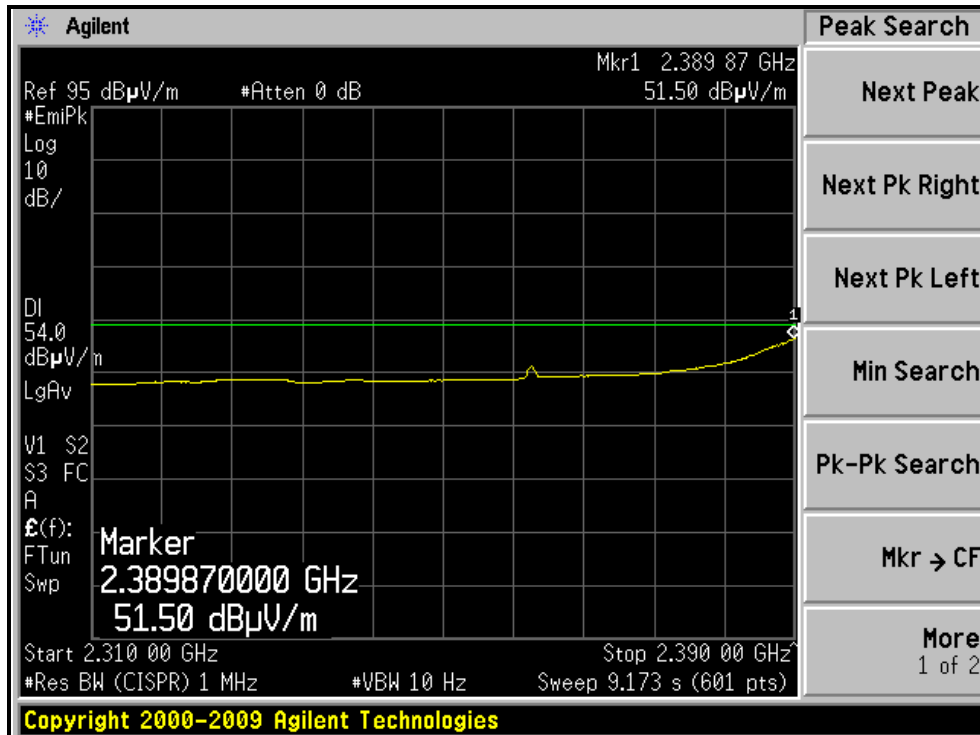
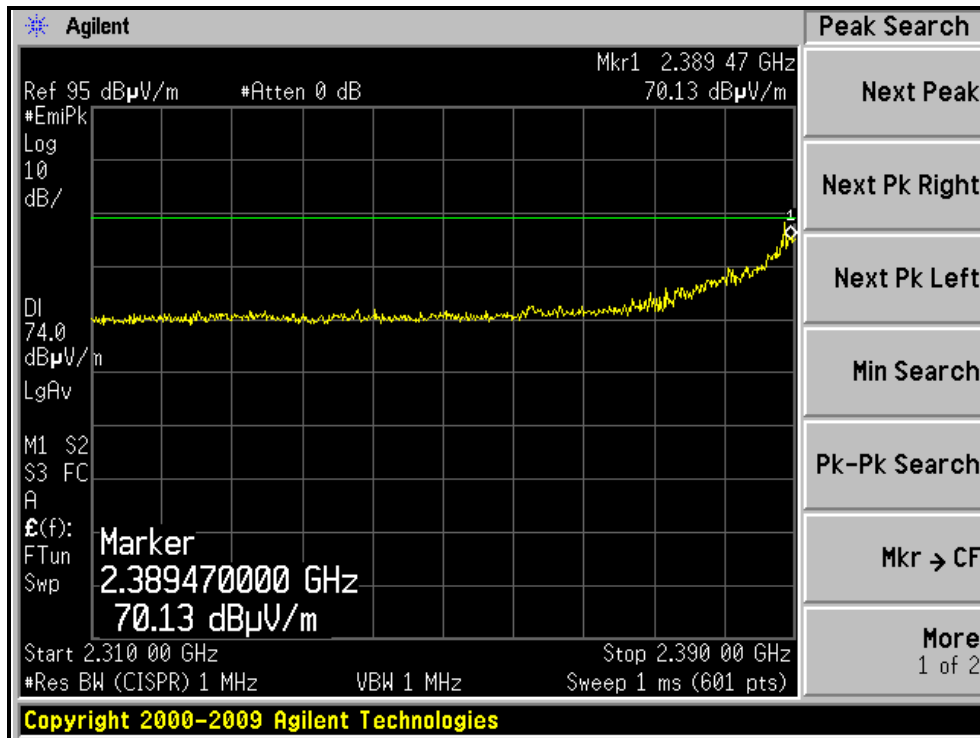



A D T

RESTRICTED BANDEDGE (802.11n (20MHz) MODE,CH11, HORIZONTAL)

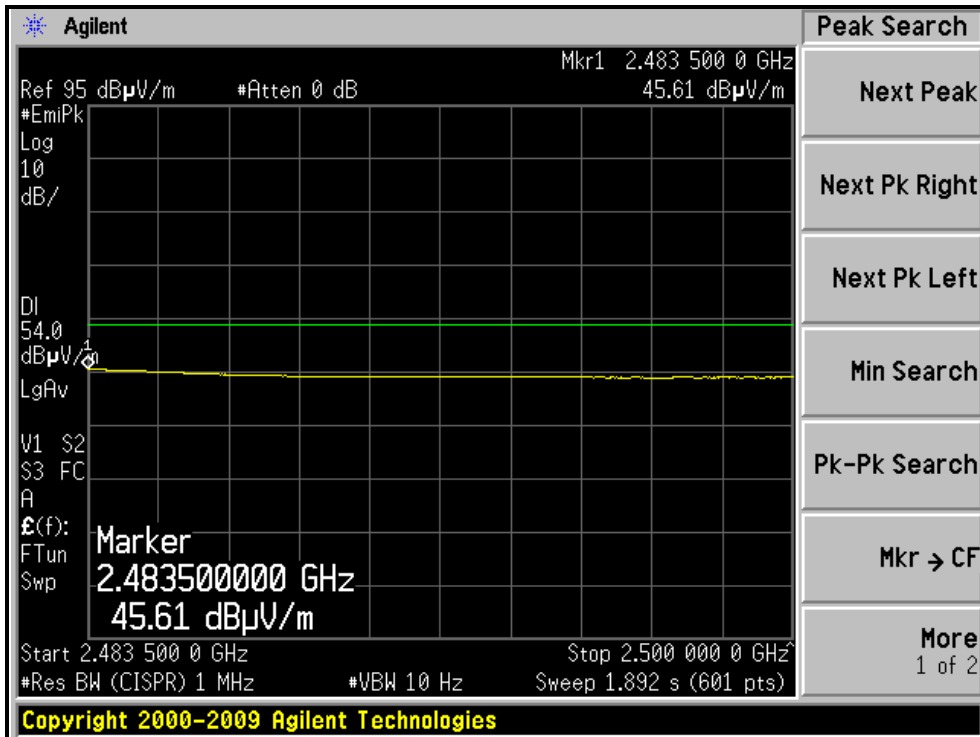
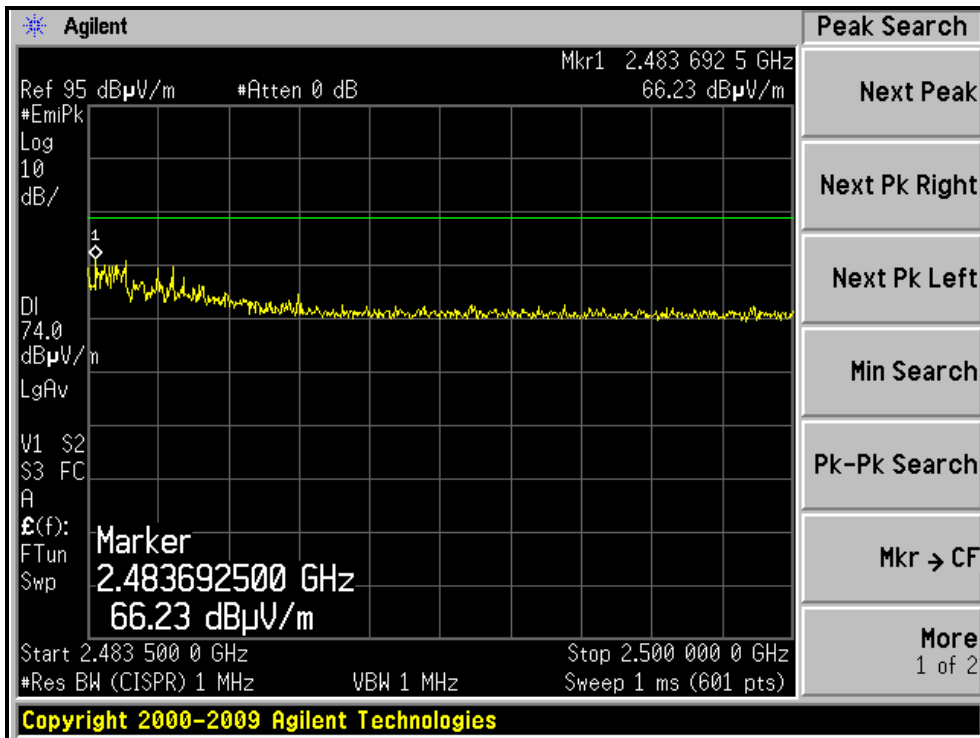

RESTRICTED BANDEDGE (802.11n (20MHz) MODE,CH11, VERTICAL)

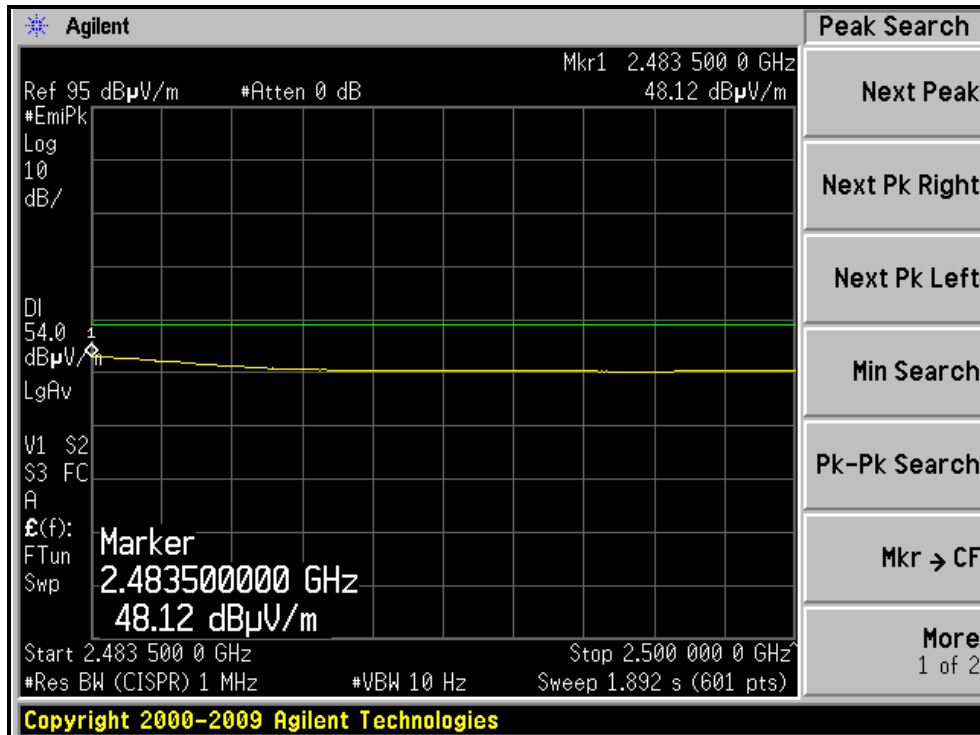
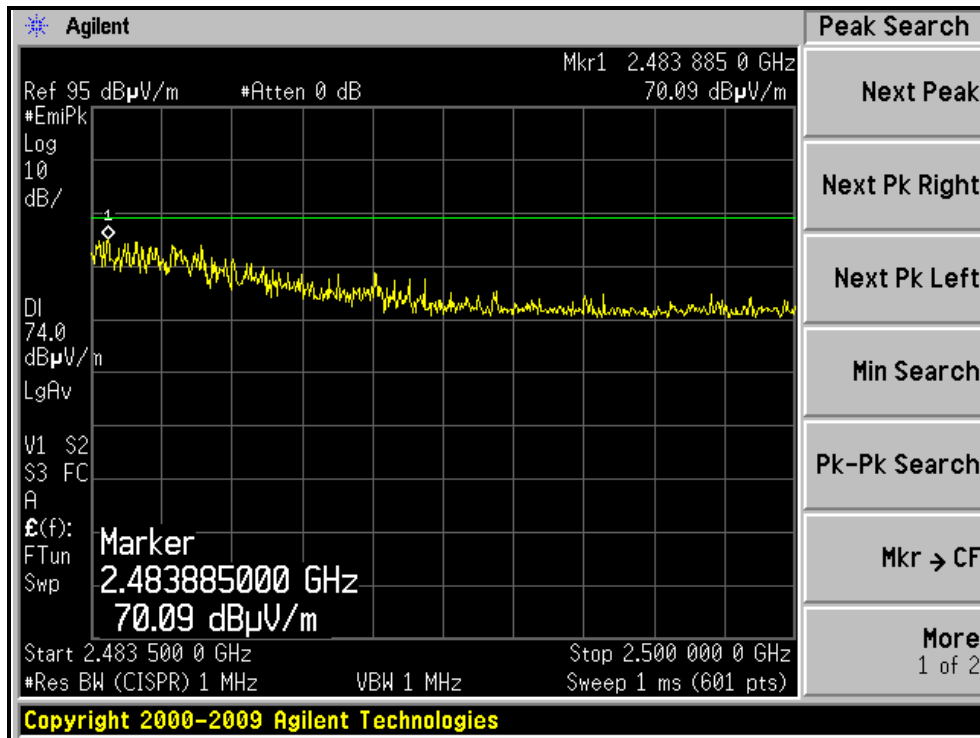



A D T

802.11n (40MHz) OFDM MODULATION

EUT TEST CONDITION		MEASUREMENT DETAIL	
CHANNEL	Channel 3	FREQUENCY RANGE	1 ~ 25GHz
INPUT POWER (SYSTEM)	120Vac, 60 Hz	DETECTOR FUNCTION	Peak (PK) Average (AV)
ENVIRONMENTAL CONDITIONS	26deg. C, 68%RH	TESTED BY	Frank Liu

ANTENNA POLARITY & TEST DISTANCE: HORIZONTAL AT 3 M

NO.	FREQ. (MHz)	EMISSION LEVEL (dBuV/m)	LIMIT (dBuV/m)	MARGIN (dB)	ANTENNA HEIGHT (m)	TABLE ANGLE (Degree)	RAW VALUE (dBuV)	CORRECTION FACTOR (dB/m)
1	2390.00	67.5 PK	74.0	-6.5	1.00 H	39	35.84	31.66
2	2390.00	49.2 AV	54.0	-4.8	1.00 H	39	17.54	31.66
3	*2422.00	101.5 PK			1.00 H	39	69.74	31.76
4	*2422.00	88.6 AV			1.00 H	39	56.84	31.76
5	4844.00	47.2 PK	74.0	-26.8	1.00 H	34	8.16	39.04
6	4844.00	36.4 AV	54.0	-17.6	1.00 H	34	-2.64	39.04
7	7266.00	54.3 PK	74.0	-19.7	1.06 H	27	7.63	46.67
8	7266.00	42.2 AV	54.0	-11.8	1.06 H	27	-4.47	46.67

ANTENNA POLARITY & TEST DISTANCE: VERTICAL AT 3 M

NO.	FREQ. (MHz)	EMISSION LEVEL (dBuV/m)	LIMIT (dBuV/m)	MARGIN (dB)	ANTENNA HEIGHT (m)	TABLE ANGLE (Degree)	RAW VALUE (dBuV)	CORRECTION FACTOR (dB/m)
1	2390.00	71.6 PK	74.0	-2.4	1.47 V	208	39.94	31.66
2	2390.00	53.1 AV	54.0	-0.9	1.47 V	208	21.44	31.66
3	*2422.00	106.4 PK			1.47 V	223	74.64	31.76
4	*2422.00	92.5 AV			1.47 V	223	60.74	31.76
5	4844.00	47.8 PK	74.0	-26.2	1.66 V	56	8.76	39.04
6	4844.00	36.0 AV	54.0	-18.0	1.66 V	56	-3.04	39.04
7	7266.00	54.3 PK	74.0	-19.7	1.07 V	62	7.63	46.67
8	7266.00	42.2 AV	54.0	-11.8	1.07 V	62	-4.47	46.67

- REMARKS:**
1. Emission level (dBuV/m) = Raw Value (dBuV) + Correction Factor (dB/m).
 2. Correction Factor (dB/m) = Antenna Factor (dB/m) + Cable Factor (dB).
 3. The other emission levels were very low against the limit.
 4. Margin value = Emission level – Limit value.
 5. “ * “: Fundamental frequency.



A D T

EUT TEST CONDITION		MEASUREMENT DETAIL	
CHANNEL	Channel 6	FREQUENCY RANGE	1 ~ 25GHz
INPUT POWER (SYSTEM)	120Vac, 60 Hz	DETECTOR FUNCTION	Peak (PK) Average (AV)
ENVIRONMENTAL CONDITIONS	26deg. C, 68%RH	TESTED BY	Frank Liu

ANTENNA POLARITY & TEST DISTANCE: HORIZONTAL AT 3 M								
NO.	FREQ. (MHz)	EMISSION LEVEL (dBuV/m)	LIMIT (dBuV/m)	MARGIN (dB)	ANTENNA HEIGHT (m)	TABLE ANGLE (Degree)	RAW VALUE (dBuV)	CORRECTION FACTOR (dB/m)
1	*2437.00	102.1 PK			1.02 H	36	70.29	31.81
2	*2437.00	87.1 AV			1.02 H	36	55.29	31.81
3	4874.00	47.3 PK	74.0	-26.7	1.00 H	36	8.16	39.14
4	4874.00	36.4 AV	54.0	-17.6	1.00 H	36	-2.74	39.14
5	7311.00	54.5 PK	74.0	-19.5	1.06 H	49	7.87	46.63
6	7311.00	42.1 AV	54.0	-11.9	1.06 H	49	-4.53	46.63
ANTENNA POLARITY & TEST DISTANCE: VERTICAL AT 3 M								
NO.	FREQ. (MHz)	EMISSION LEVEL (dBuV/m)	LIMIT (dBuV/m)	MARGIN (dB)	ANTENNA HEIGHT (m)	TABLE ANGLE (Degree)	RAW VALUE (dBuV)	CORRECTION FACTOR (dB/m)
1	2390.00	61.3 PK	74.0	-12.7	1.38 V	207	29.64	31.66
2	2390.00	47.1 AV	54.0	-6.9	1.38 V	207	15.44	31.66
3	*2437.00	105.5 PK			1.44 V	211	73.69	31.81
4	*2437.00	91.0 AV			1.44 V	211	59.19	31.81
5	2483.50	66.5 PK	74.0	-7.5	1.35 V	214	34.53	31.97
6	2483.50	51.0 AV	54.0	-3.0	1.35 V	214	19.03	31.97
7	4874.00	48.2 PK	74.0	-25.8	1.65 V	45	9.06	39.14
8	4874.00	36.3 AV	54.0	-17.7	1.65 V	45	-2.84	39.14
9	7311.00	54.8 PK	74.0	-19.2	1.03 V	43	8.17	46.63
10	7311.00	42.4 AV	54.0	-11.6	1.03 V	43	-4.23	46.63

- REMARKS:**
1. Emission level (dBuV/m) = Raw Value (dBuV) + Correction Factor (dB/m).
 2. Correction Factor (dB/m) = Antenna Factor (dB/m) + Cable Factor (dB).
 3. The other emission levels were very low against the limit.
 4. Margin value = Emission level – Limit value.
 5. “ * “: Fundamental frequency.



A D T

EUT TEST CONDITION		MEASUREMENT DETAIL	
CHANNEL	Channel 9	FREQUENCY RANGE	1 ~ 25GHz
INPUT POWER (SYSTEM)	120Vac, 60 Hz	DETECTOR FUNCTION	Peak (PK) Average (AV)
ENVIRONMENTAL CONDITIONS	26deg. C, 68%RH	TESTED BY	Frank Liu

ANTENNA POLARITY & TEST DISTANCE: HORIZONTAL AT 3 M								
NO.	FREQ. (MHz)	EMISSION LEVEL (dBuV/m)	LIMIT (dBuV/m)	MARGIN (dB)	ANTENNA HEIGHT (m)	TABLE ANGLE (Degree)	RAW VALUE (dBuV)	CORRECTION FACTOR (dB/m)
1	*2452.00	101.7 PK			1.01 H	38	69.84	31.86
2	*2452.00	86.6 AV			1.01 H	38	54.74	31.86
3	2483.50	68.5 PK	74.0	-5.5	1.01 H	38	36.53	31.97
4	2483.50	49.2 AV	54.0	-4.8	1.01 H	38	17.23	31.97
5	4904.00	47.2 PK	74.0	-26.8	1.00 H	29	7.96	39.24
6	4904.00	36.6 AV	54.0	-17.4	1.00 H	29	-2.64	39.24
7	7356.00	54.6 PK	74.0	-19.4	1.05 H	31	7.99	46.61
8	7356.00	42.2 AV	54.0	-11.8	1.05 H	31	-4.41	46.61
ANTENNA POLARITY & TEST DISTANCE: VERTICAL AT 3 M								
NO.	FREQ. (MHz)	EMISSION LEVEL (dBuV/m)	LIMIT (dBuV/m)	MARGIN (dB)	ANTENNA HEIGHT (m)	TABLE ANGLE (Degree)	RAW VALUE (dBuV)	CORRECTION FACTOR (dB/m)
1	*2452.00	103.5 PK			1.39 V	214	71.64	31.86
2	*2452.00	89.7 AV			1.39 V	214	57.84	31.86
3	2483.50	70.8 PK	74.0	-3.2	1.45 V	217	38.83	31.97
4	2483.50	51.1 AV	54.0	-2.9	1.45 V	217	19.13	31.97
5	4904.00	48.3 PK	74.0	-25.7	1.73 V	56	9.06	39.24
6	4904.00	36.4 AV	54.0	-17.6	1.73 V	56	-2.84	39.24
7	7356.00	55.0 PK	74.0	-19.0	1.10 V	38	8.39	46.61
8	7356.00	42.5 AV	54.0	-11.5	1.10 V	38	-4.11	46.61

- REMARKS:**
1. Emission level (dBuV/m) = Raw Value (dBuV) + Correction Factor (dB/m).
 2. Correction Factor (dB/m) = Antenna Factor (dB/m) + Cable Factor (dB).
 3. The other emission levels were very low against the limit.
 4. Margin value = Emission level – Limit value.
 5. “ * “: Fundamental frequency.



A D T

RESTRICTED BANDEDGE (802.11n (40MHz) MODE,CH3, HORIZONTAL)

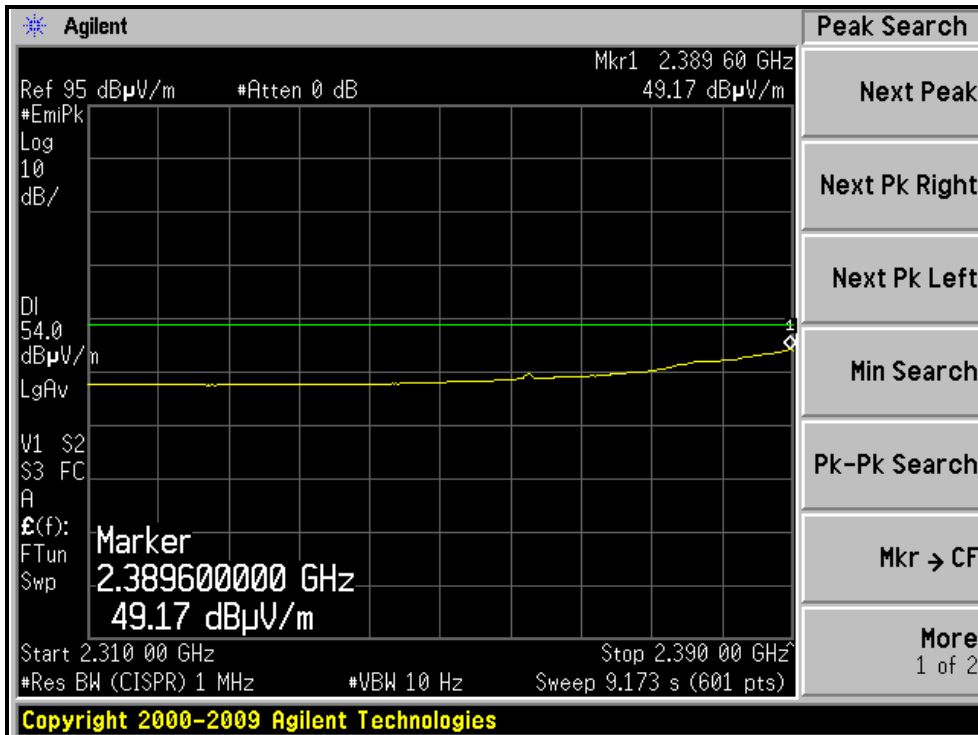
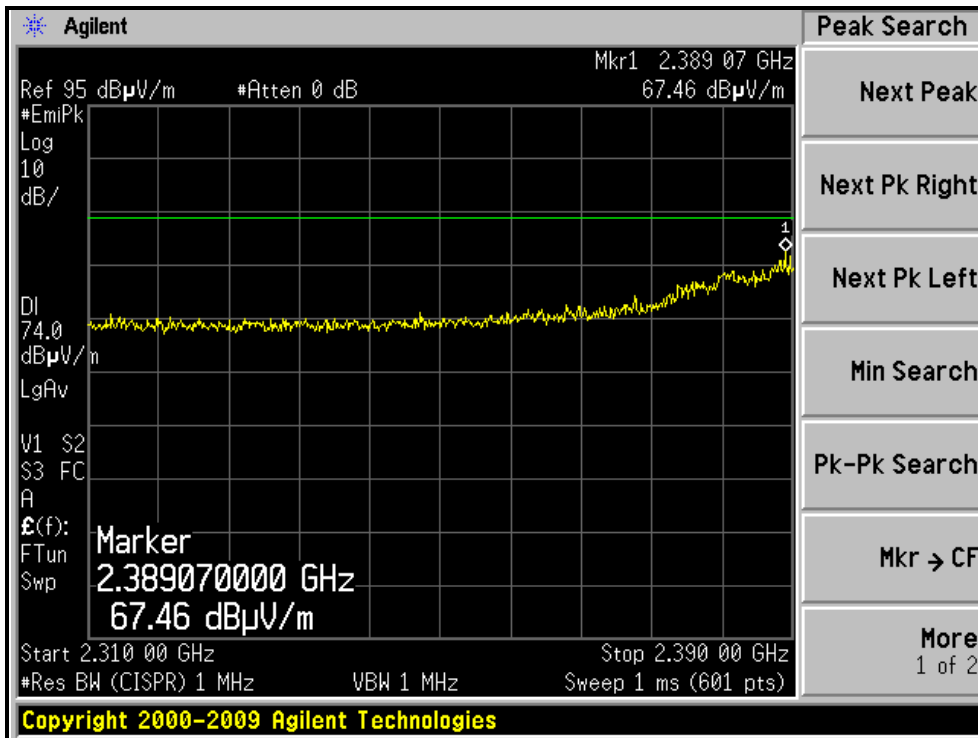

RESTRICTED BANDEDGE (802.11n (40MHz) MODE,CH3, VERTICAL)

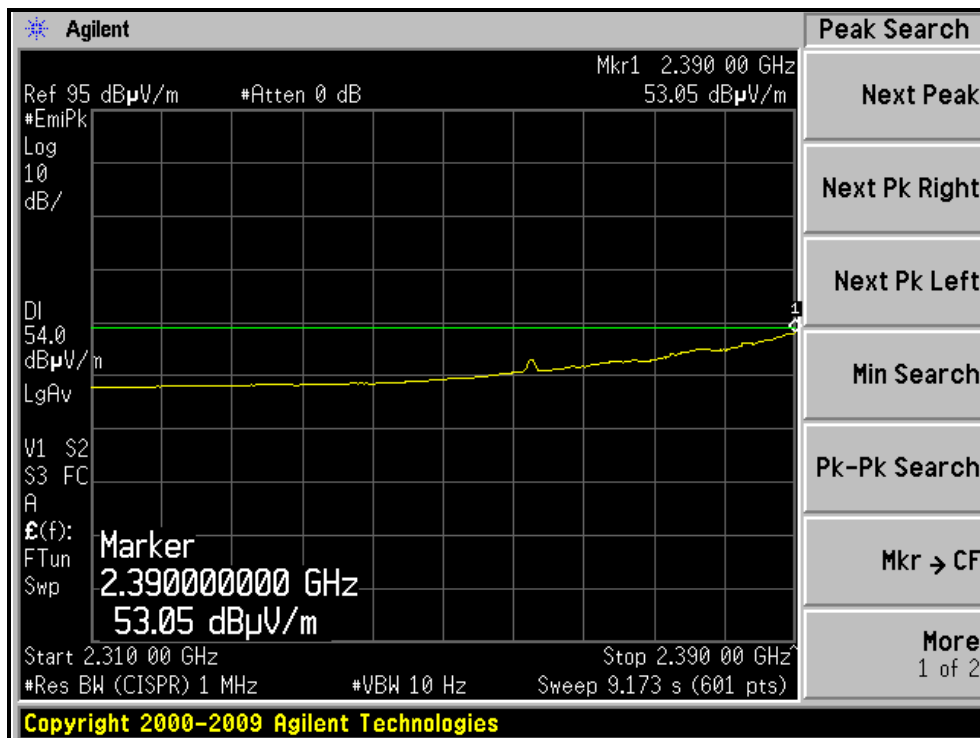
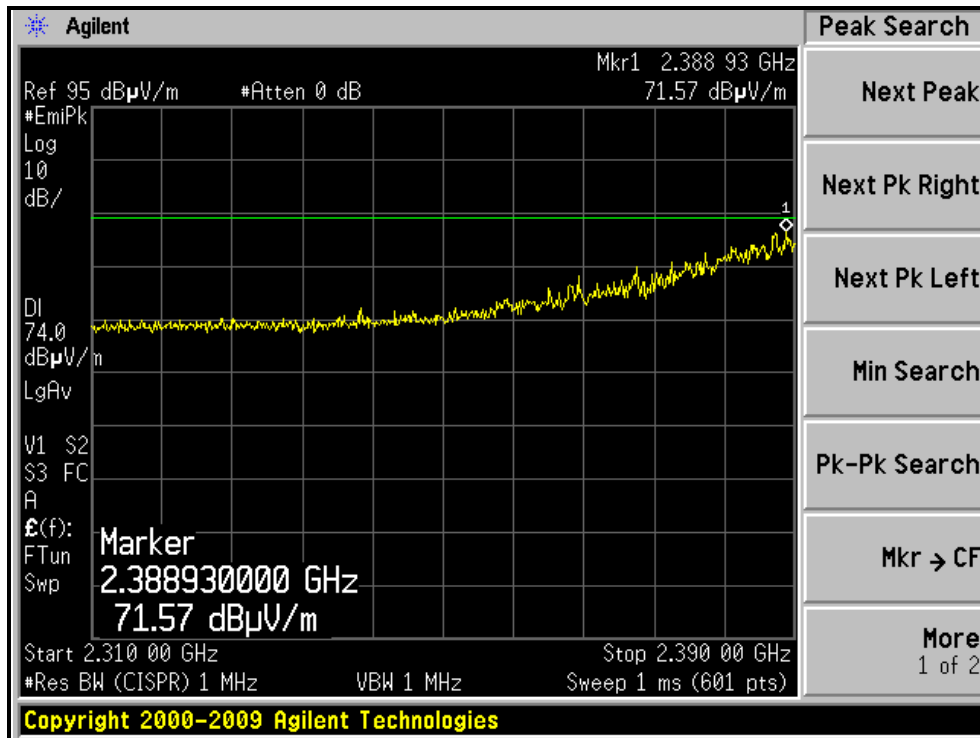



A D T

RESTRICTED BANDEDGE (802.11n (40MHz) MODE,CH9, HORIZONTAL)

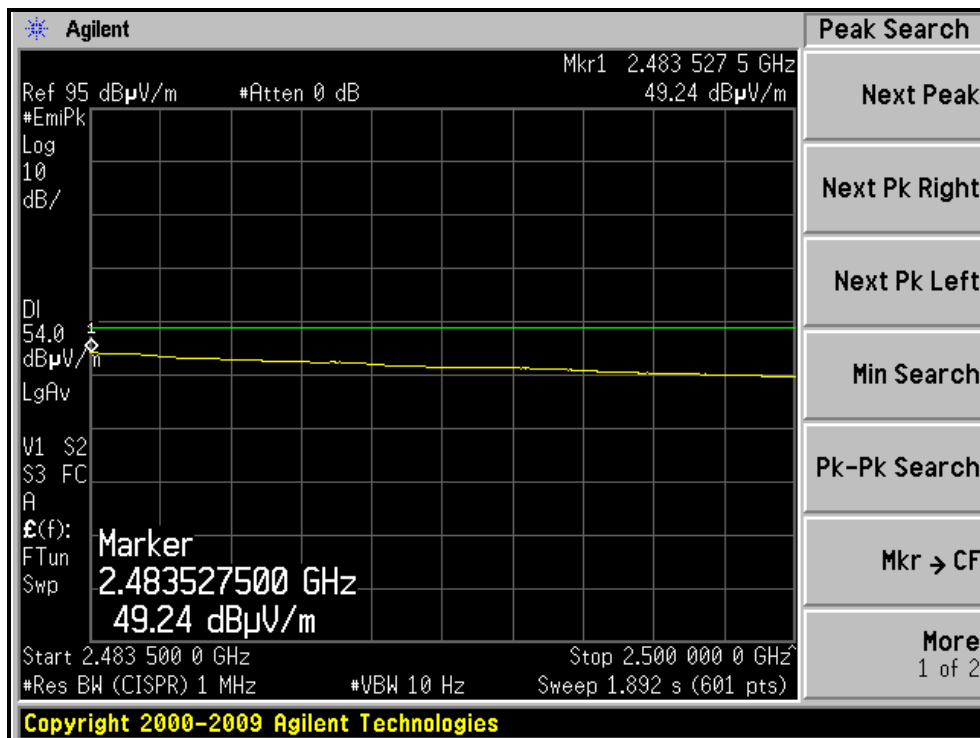
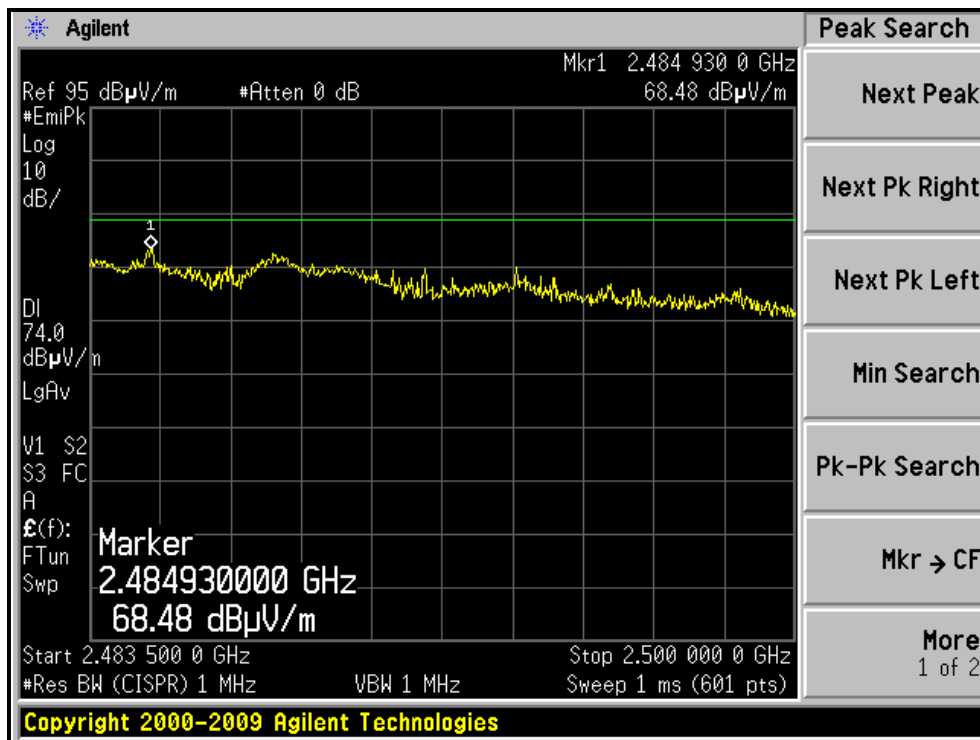

RESTRICTED BANDEDGE (802.11n (40MHz) MODE,CH9, VERTICAL)

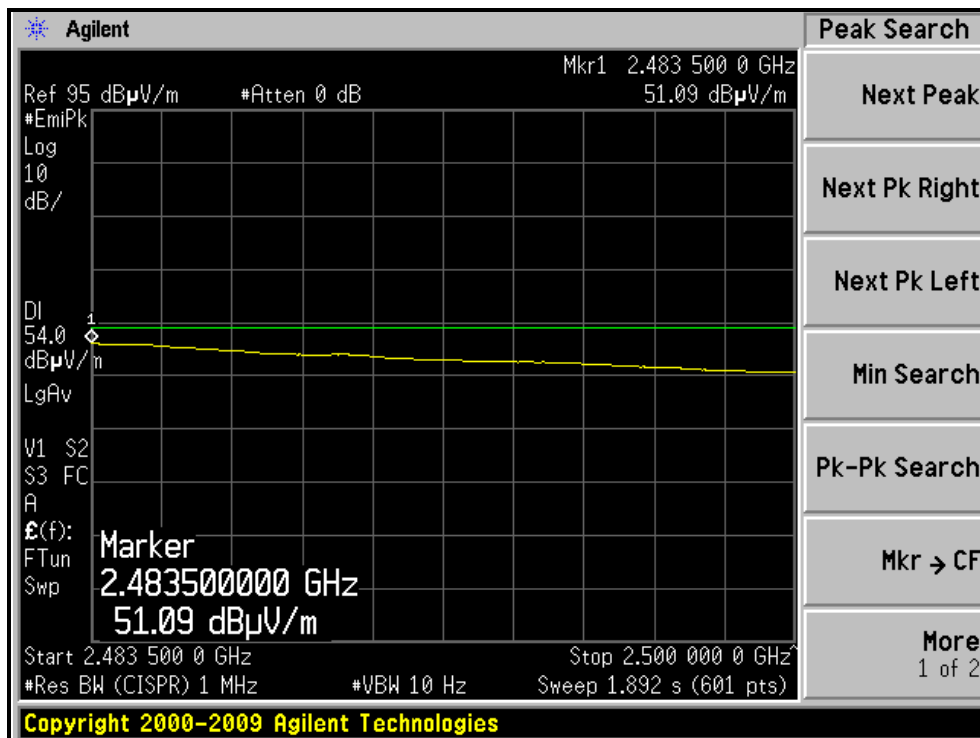
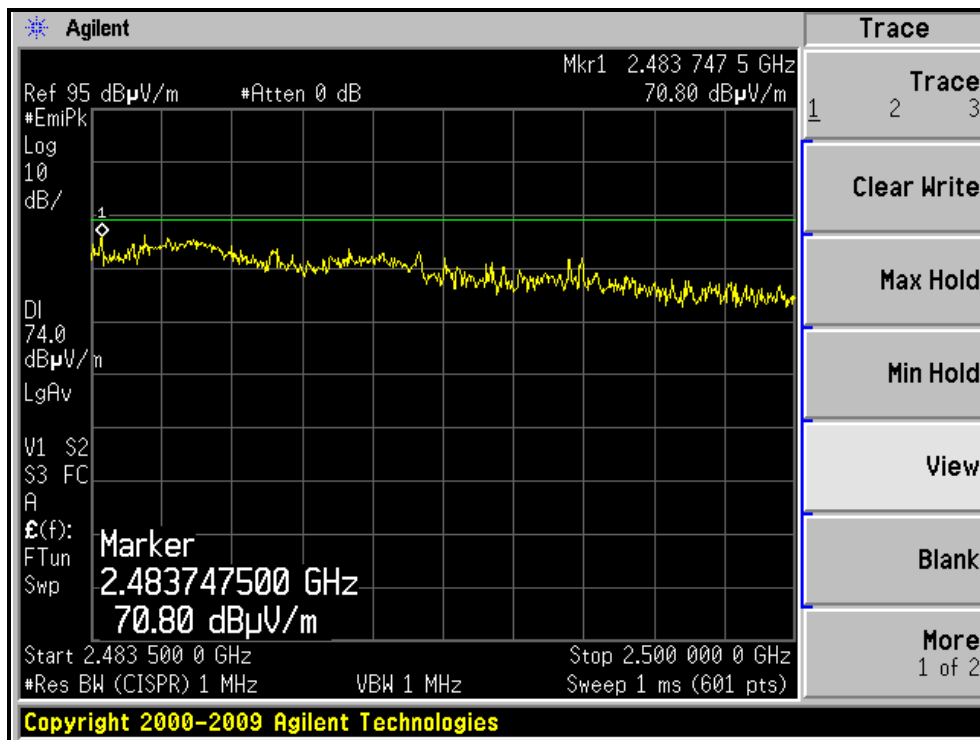

4.3 6dB BANDWIDTH MEASUREMENT

4.3.1 LIMITS OF 6dB BANDWIDTH MEASUREMENT

The minimum of 6dB Bandwidth Measurement is 0.5 MHz.

4.3.2 TEST INSTRUMENTS

Test date: July 07, 2011

DESCRIPTION & MANUFACTURER	MODEL NO.	SERIAL NO.	CALIBRATED DATE	CALIBRATED UNTIL
R&S Spectrum Analyzer	FSP40	100036	Dec. 08, 2010	Dec. 07, 2011

NOTE: The calibration interval of the above test instruments is 12 months and the calibrations are traceable to NML/ROC and NIST/USA.

4.3.3 TEST PROCEDURE

The transmitter output was connected to the spectrum analyzer through an attenuator. The bandwidth of the fundamental frequency was measured by spectrum analyzer with 100kHz RBW and 300kHz VBW. The 6dB bandwidth is defined as the total spectrum the power of which is higher than peak power minus 6dB.

4.3.4 DEVIATION FROM TEST STANDARD

No deviation

4.3.5 TEST SETUP



4.3.6 EUT OPERATING CONDITIONS

The software provided by client to enable the EUT under transmission condition continuously at lowest, middle and highest channel frequencies individually.



A D T

4.3.7 TEST RESULTS

802.11b DSSS MODULATION:

CHANNEL	CHANNEL FREQUENCY (MHz)	6dB BANDWIDTH (MHz)		MINIMUM LIMIT (MHz)	PASS / FAIL
		CHAIN(0)	CHAIN(1)		
1	2412	9.38	9.25	0.5	PASS
6	2437	8.98	8.87	0.5	PASS
11	2462	10.42	10.24	0.5	PASS

For Chain(0) : CH11

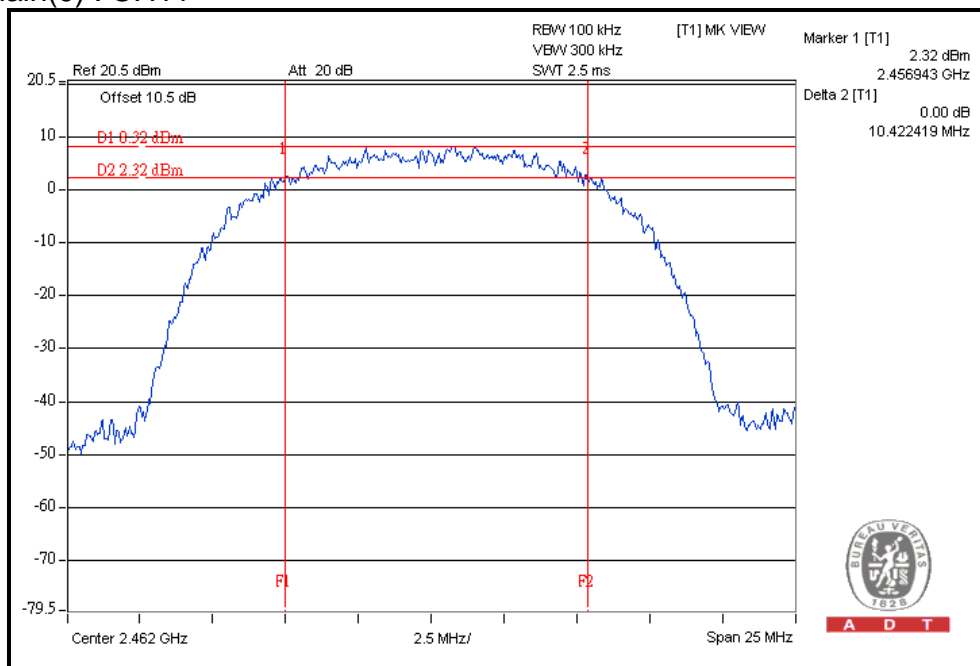



A D T

802.11g OFDM MODULATION:

CHANNEL	CHANNEL FREQUENCY (MHz)	6dB BANDWIDTH (MHz)		MINIMUM LIMIT (MHz)	PASS / FAIL
		CHAIN(0)	CHAIN(1)		
1	2412	16.47	16.23	0.5	PASS
6	2437	16.45	16.25	0.5	PASS
11	2462	16.49	16.31	0.5	PASS

For Chain(0) : CH11

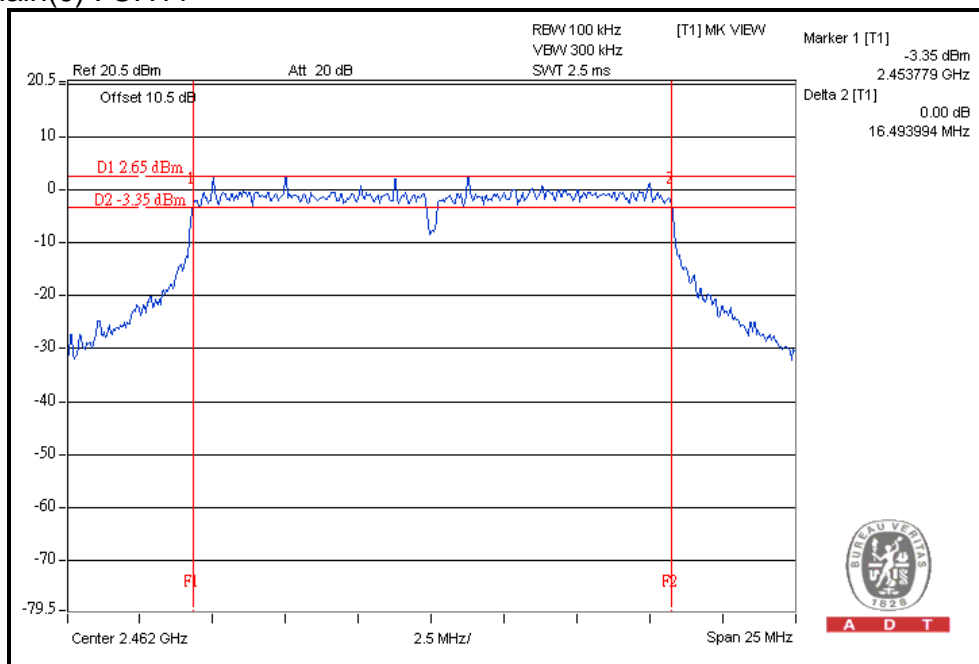

802.11n (20MHz) OFDM modulation:

CHANNEL	CHANNEL FREQUENCY (MHz)	6dB BANDWIDTH (MHz)		MINIMUM LIMIT (MHz)	PASS / FAIL
		CHAIN(0)	CHAIN(1)		
1	2412	17.69	17.51	0.5	PASS
6	2437	17.64	17.55	0.5	PASS
11	2462	17.68	17.49	0.5	PASS

For Chain(0) : CH1

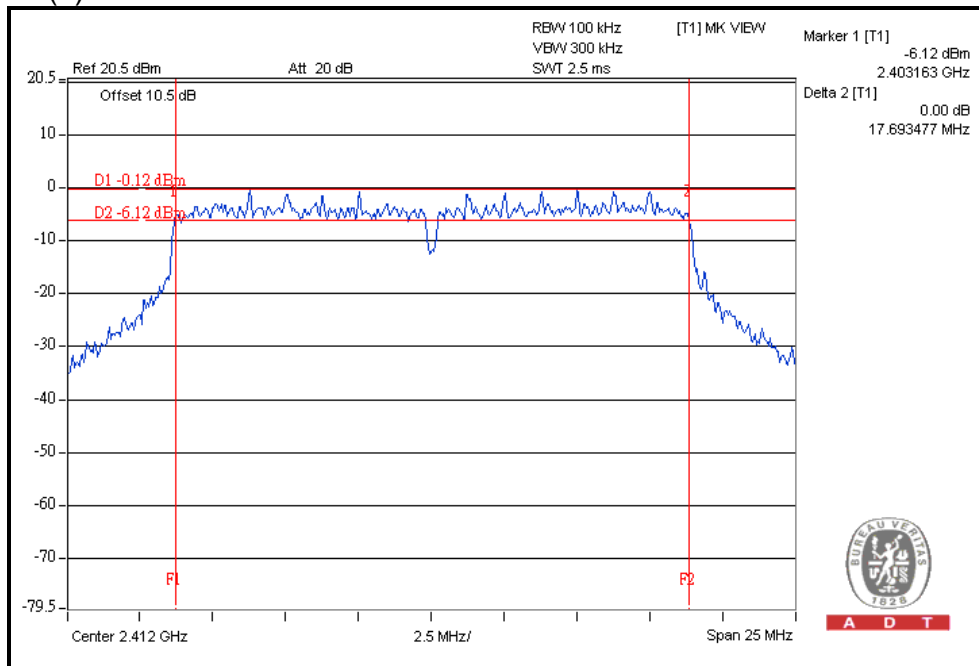

802.11n (40MHz) OFDM MODULATION:

CHANNEL	CHANNEL FREQUENCY (MHz)	6dB BANDWIDTH (MHz)		MINIMUM LIMIT (MHz)	PASS / FAIL
		CHAIN(0)	CHAIN(1)		
3	2422	36.47	36.32	0.5	PASS
6	2437	36.47	36.33	0.5	PASS
9	2452	36.50	36.37	0.5	PASS

For Chain(0) : CH9

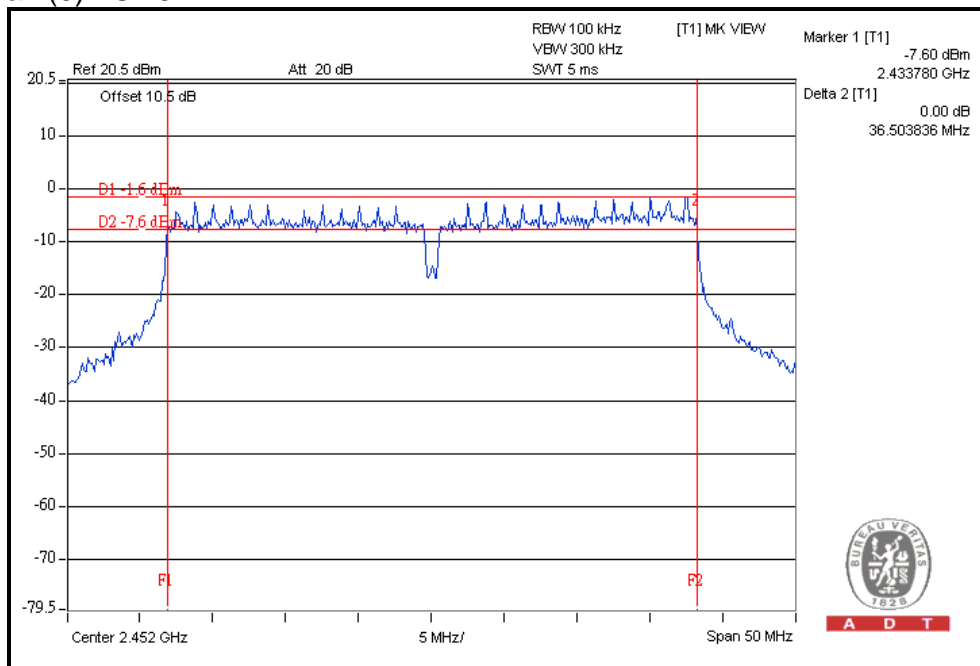

4.4 MAXIMUM PEAK OUTPUT POWER

4.4.1 LIMITS OF MAXIMUM PEAK OUTPUT POWER MEASUREMENT

The Maximum Peak Output Power Measurement is 30dBm.

4.4.2 INSTRUMENTS

Test date: July 07, 2011

DESCRIPTION & MANUFACTURER	MODEL NO.	SERIAL NO.	CALIBRATED DATE	CALIBRATED UNTIL
Peak Power Meter	ML2495A	0824006	May 04, 2011	May 03, 2012
Power Sensor	MA2411B	0738172	May 03, 2011	May 02, 2012

NOTE: The calibration interval of the above test instruments is 12 months and the calibrations are traceable to NML/ROC and NIST/USA.

4.4.3 TEST PROCEDURES

1. The transmitter output was connected to the power meter through an attenuator; the bandwidth of the fundamental frequency was measured with the power meter.
2. Record the power level.

4.4.4 DEVIATION FROM TEST STANDARD

No deviation

4.4.5 TEST SETUP

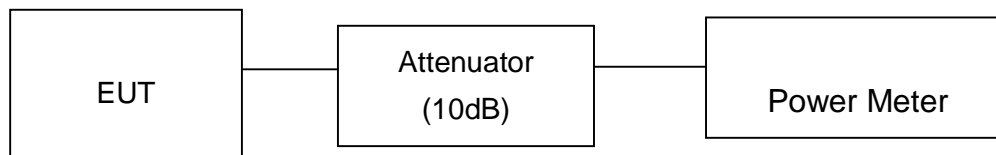

4.4.6 EUT OPERATING CONDITIONS

Same as Item 4.3.6



A D T

4.4.7 TEST RESULTS

802.11b DSSS MODULATION:

CHANNEL	CHANNEL FREQUENCY (MHz)	PEAK POWER OUTPUT (dBm)		TOTAL PEAK POWER (mW)	TOTAL PEAK POWER (dBm)	PEAK POWER LIMIT (dBm)	PASS / FAIL
		CHAIN(0)	CHAIN(1)				
1	2412	16.3	19.3	127.8	21.1	30	PASS
6	2437	19.5	21.2	221.0	23.4	30	PASS
11	2462	20.9	19.4	210.1	23.2	30	PASS

Directional gain = gain of antenna element + 10 log (# of TX antenna elements)

Effective Legacy Gain (dBi)=5

The effective legacy gain is 5dBi, therefore the limit doesn't reduce.

802.11g OFDM MODULATION:

CHANNEL	CHANNEL FREQUENCY (MHz)	PEAK POWER OUTPUT (dBm)		TOTAL PEAK POWER (mW)	TOTAL PEAK POWER (dBm)	PEAK POWER LIMIT (dBm)	PASS / FAIL
		CHAIN(0)	CHAIN(1)				
1	2412	22.3	23.4	388.6	25.9	30	PASS
6	2437	23.4	23.5	442.6	26.5	30	PASS
11	2462	22.7	22.4	360.0	25.6	30	PASS

Directional gain = gain of antenna element + 10 log (# of TX antenna elements)

Effective Legacy Gain (dBi)=5

The effective legacy gain is 5dBi, therefore the limit doesn't reduce.



A D T

802.11n (20MHz) OFDM MODULATION:

CHANNEL	CHANNEL FREQUENCY (MHz)	PEAK POWER OUTPUT (dBm)		TOTAL PEAK POWER (mW)	TOTAL PEAK POWER (dBm)	PEAK POWER LIMIT (dBm)	PASS / FAIL
		CHAIN(0)	CHAIN(1)				
1	2412	20.8	23.6	349.3	25.4	30	PASS
6	2437	24.1	23.9	502.5	27.0	30	PASS
11	2462	22.1	20.6	277.0	24.4	30	PASS

802.11n (40MHz) OFDM MODULATION:

CHANNEL	CHANNEL FREQUENCY (MHz)	PEAK POWER OUTPUT (dBm)		TOTAL PEAK POWER (mW)	TOTAL PEAK POWER (dBm)	PEAK POWER LIMIT (dBm)	PASS / FAIL
		CHAIN(0)	CHAIN(1)				
3	2422	20.1	22.9	297.3	24.7	30	PASS
6	2437	21.2	22.6	313.8	25.0	30	PASS
9	2452	22.3	22.5	347.7	25.4	30	PASS

4.5 POWER SPECTRAL DENSITY MEASUREMENT

4.5.1 LIMITS OF POWER SPECTRAL DENSITY MEASUREMENT

The Maximum of Power Spectral Density Measurement is 8dBm.

4.5.2 TEST INSTRUMENTS

Test date: July 07, 2011

DESCRIPTION & MANUFACTURER	MODEL NO.	SERIAL NO.	CALIBRATED DATE	CALIBRATED UNTIL
R&S Spectrum Analyzer	FSP40	100036	Dec. 08, 2010	Dec. 07, 2011

NOTE: The calibration interval of the above test instruments is 12 months and the calibrations are traceable to NML/ROC and NIST/USA.

4.5.3 TEST PROCEDURE

The transmitter output was connected to the spectrum analyzer through an attenuator, the bandwidth of the fundamental frequency was measured with the spectrum analyzer using 3kHz RBW and 30kHz VBW, set sweep time = span/3kHz. The power spectral density was measured and recorded. The sweep time is allowed to be longer than span/3kHz for a full response of the mixer in the spectrum analyzer.

4.5.4 DEVIATION FROM TEST STANDARD

No deviation

4.5.5 TEST SETUP

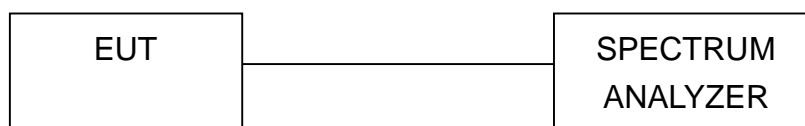

4.5.6 EUT OPERATING CONDITION

Same as Item 4.3.6



A D T

4.5.7 TEST RESULTS

802.11b DSSS MODULATION:

CHANNEL	CHANNEL FREQUENCY (MHz)	RF POWER LEVEL IN 3kHz BW (dBm)		TOTAL POWER DENSITY (dBm)	MAXIMUM LIMIT (dBm)	PASS / FAIL
		CHAIN(0)	CHAIN(1)			
1	2412	-9.7	-5.0	-3.7	8	PASS
6	2437	-7.2	-5.9	-3.5	8	PASS
11	2462	-6.6	-8.7	-4.5	8	PASS

For Chain(1): CH1

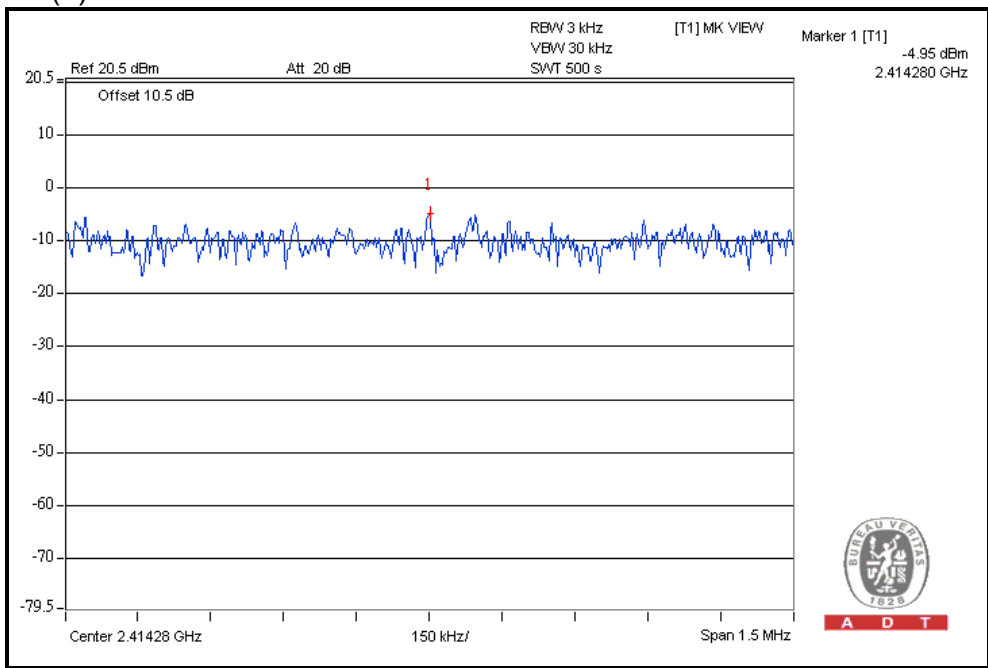

802.11g OFDM MODULATION:

CHANNEL	CHANNEL FREQUENCY (MHz)	RF POWER LEVEL IN 3kHz BW (dBm)		TOTAL POWER DENSITY (dBm)	MAXIMUM LIMIT (dBm)	PASS / FAIL
		CHAIN(0)	CHAIN(1)			
1	2412	-13.8	-7.9	-6.9	8	PASS
6	2437	-1.2	-7.0	-0.2	8	PASS
11	2462	-11.9	-13.4	-9.6	8	PASS

For Chain(0): CH6

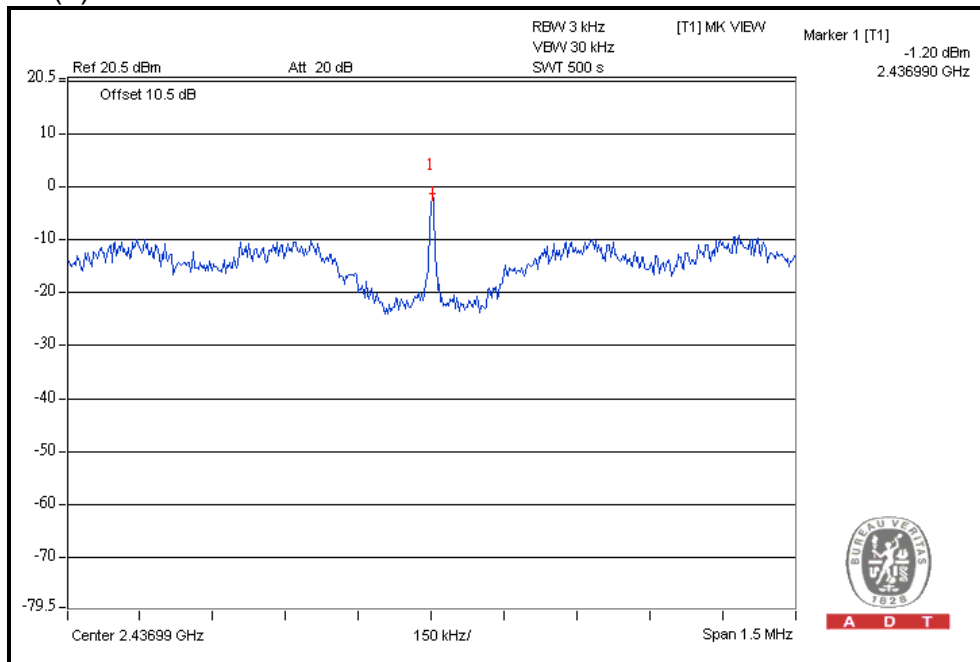

802.11n (20MHz) OFDM MODULATION:

CHANNEL	CHANNEL FREQUENCY (MHz)	RF POWER LEVEL IN 3kHz BW (dBm)		TOTAL POWER DENSITY (dBm)	MAXIMUM LIMIT (dBm)	PASS / FAIL
		CHAIN(0)	CHAIN(1)			
1	2412	-14.4	-9.8	-8.5	8	PASS
6	2437	-1.2	-2.7	1.1	8	PASS
11	2462	-13.2	-13.7	-10.4	8	PASS

For Chain(0): CH6

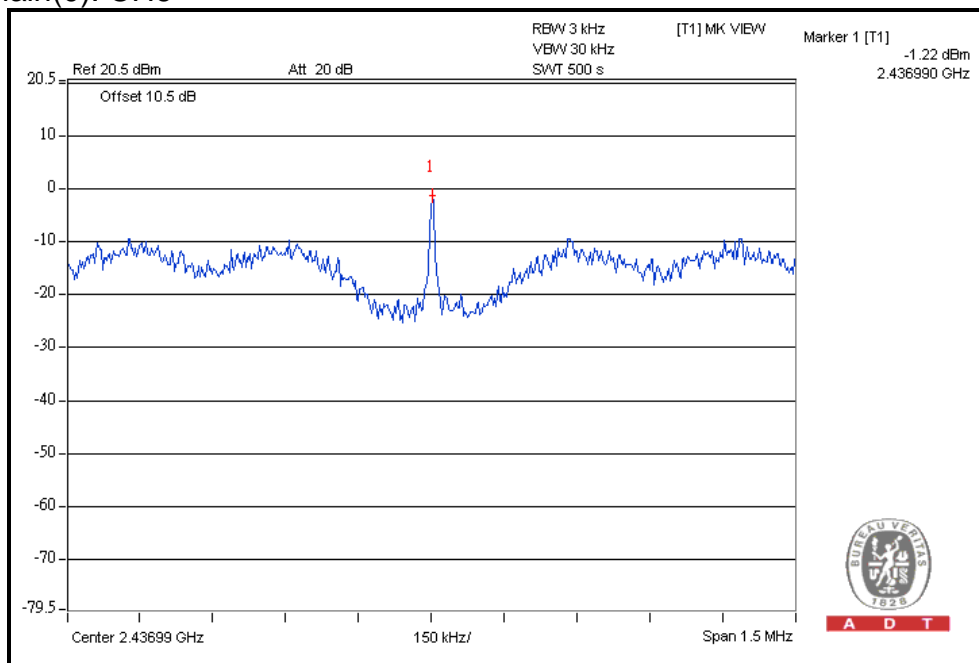



A D T

802.11n (40MHz) OFDM MODULATION:

CHANNEL	CHANNEL FREQUENCY (MHz)	RF POWER LEVEL IN 3kHz BW (dBm)		TOTAL POWER DENSITY (dBm)	MAXIMUM LIMIT (dBm)	PASS / FAIL
		CHAIN(0)	CHAIN(1)			
3	2422	-17.6	-10.0	-9.3	8	PASS
6	2437	-19.2	-15.6	-14.0	8	PASS
9	2452	-15.5	-11.0	-9.7	8	PASS

For Chain(1): CH3

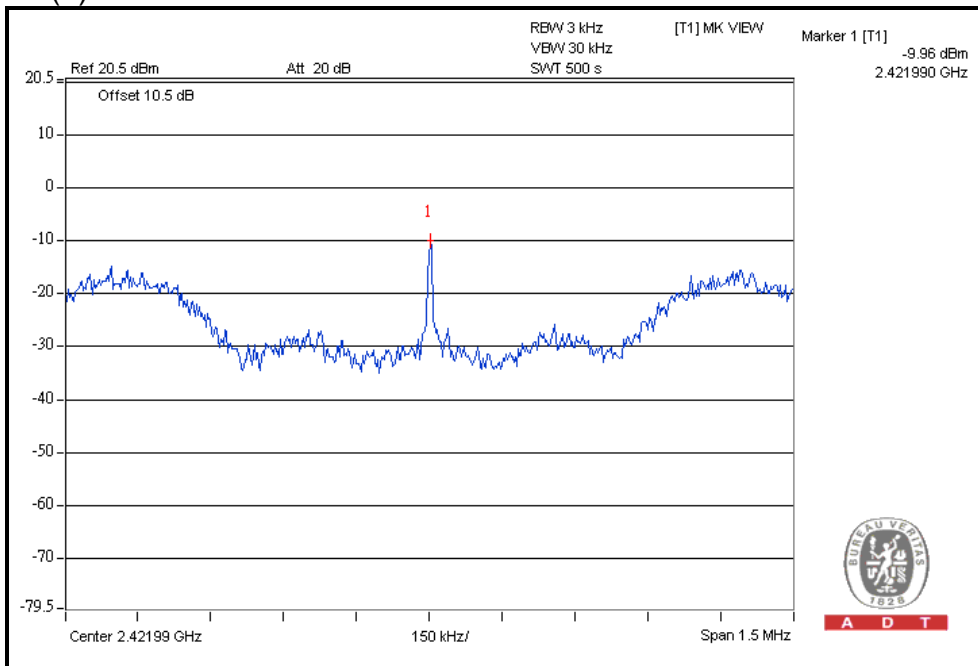

4.6 CONDUCTED OUT-BAND EMISSION MEASUREMENT

4.6.1 LIMITS OF CONDUCTED OUT-BAND EMISSION MEASUREMENT

Below -20dB of the highest emission level of operating band (in 100kHz Resolution Bandwidth).

4.6.2 TEST INSTRUMENTS

Test date: July 07, 2011

DESCRIPTION & MANUFACTURER	MODEL NO.	SERIAL NO.	CALIBRATED DATE	CALIBRATED UNTIL
R&S Spectrum Analyzer	FSP40	100036	Dec. 08, 2010	Dec. 07, 2011

NOTE: The calibration interval of the above test instruments is 12 months and the calibrations are traceable to NML/ROC and NIST/USA.

4.6.3 TEST PROCEDURE

The transmitter output was connected to the spectrum analyzer via a low loss cable. Set RBW of spectrum analyzer to 100kHz and VBW of spectrum analyzer to 300kHz with suitable frequency span including 100MHz or 200MHz bandwidth from band edge. The band edges was measured and recorded.

The spectrum plots (RBW = 100kHz, VBW = 300kHz) are attached on the following pages.

4.6.4 DEVIATION FROM TEST STANDARD

No deviation

4.6.5 EUT OPERATING CONDITION

Same as Item 4.3.6

4.6.6 TEST RESULTS

The spectrum plots are attached on the following images. D1 line indicates the highest level, and D2 line indicates the 20dB offset below D1. It shows compliance with the requirement in part 15.247(d).



A D T

802.11b DSSS MODULATION:

For Chain(0) : CH1

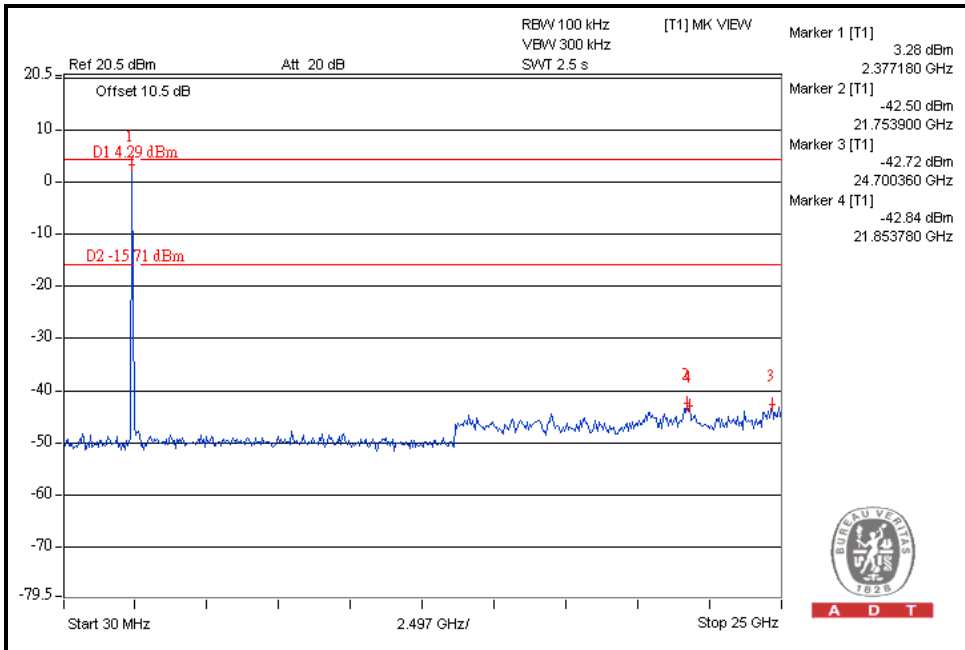
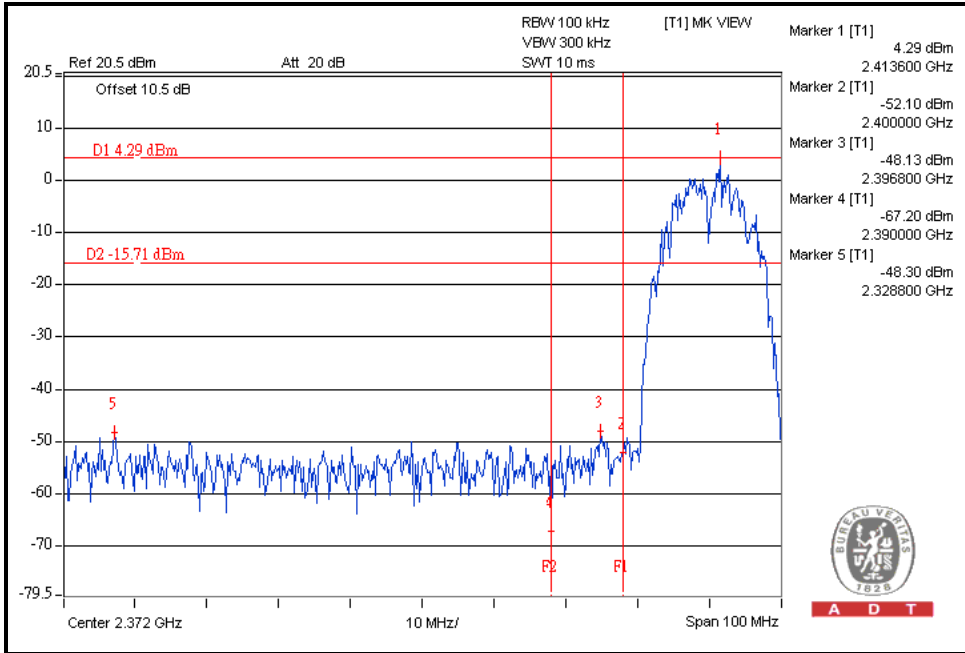



A D T

For Chain(0) : CH11

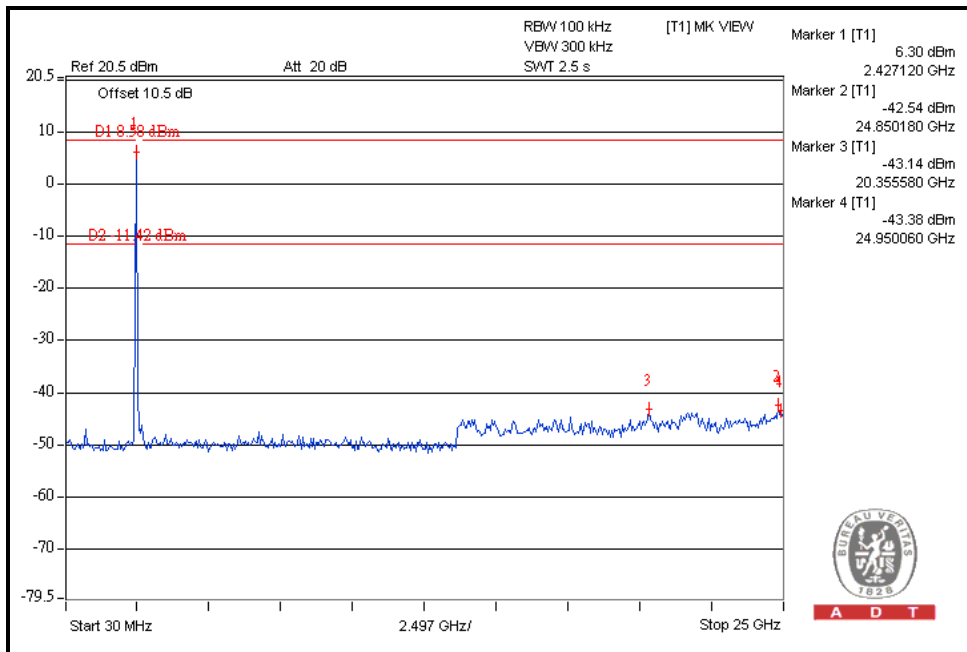
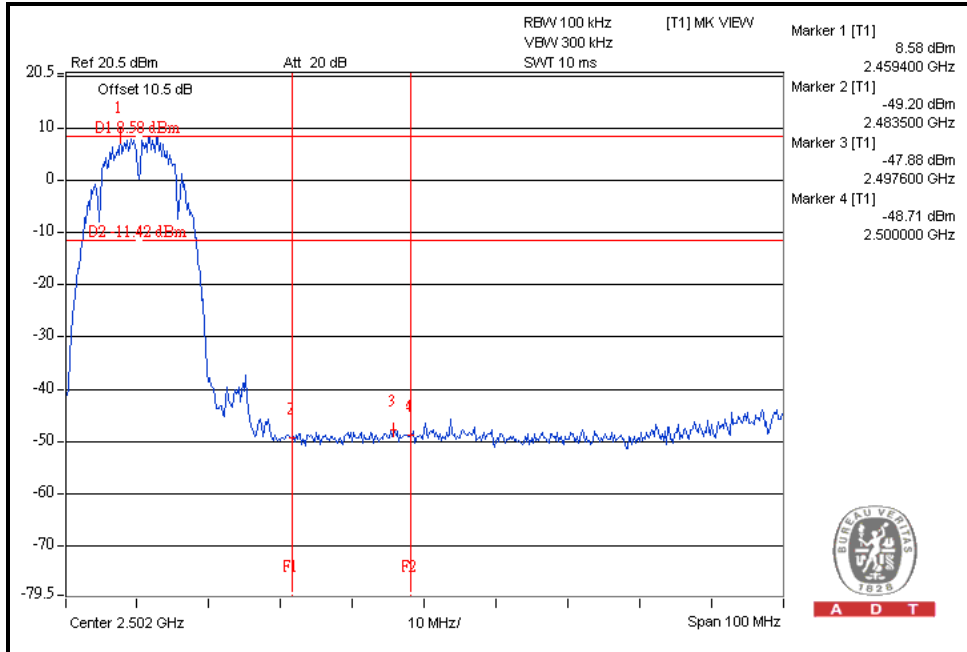



A D T

For Chain(1) : CH1

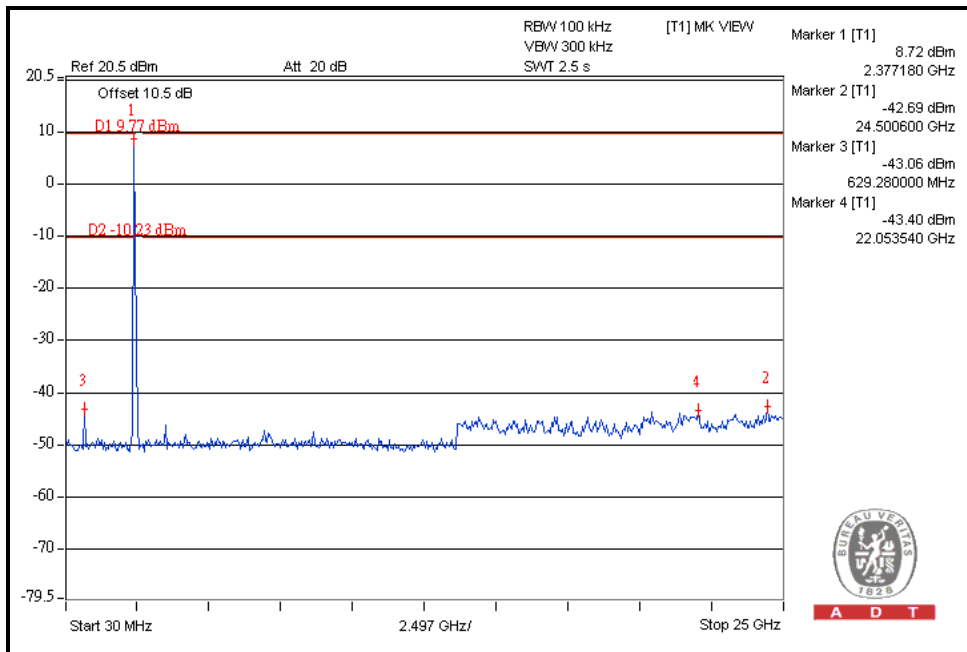
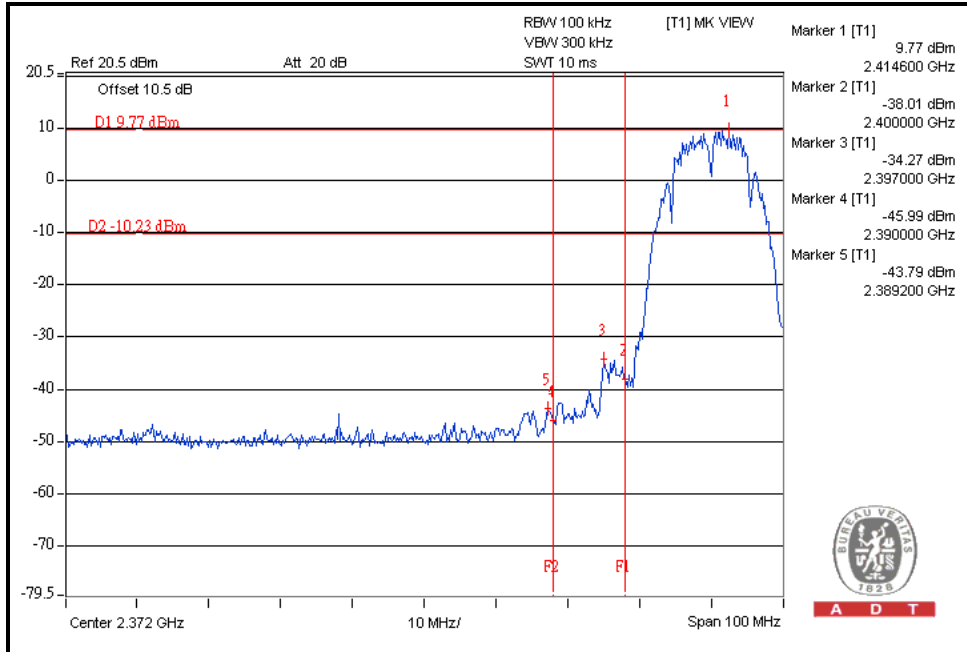



A D T

For Chain(1) : CH11

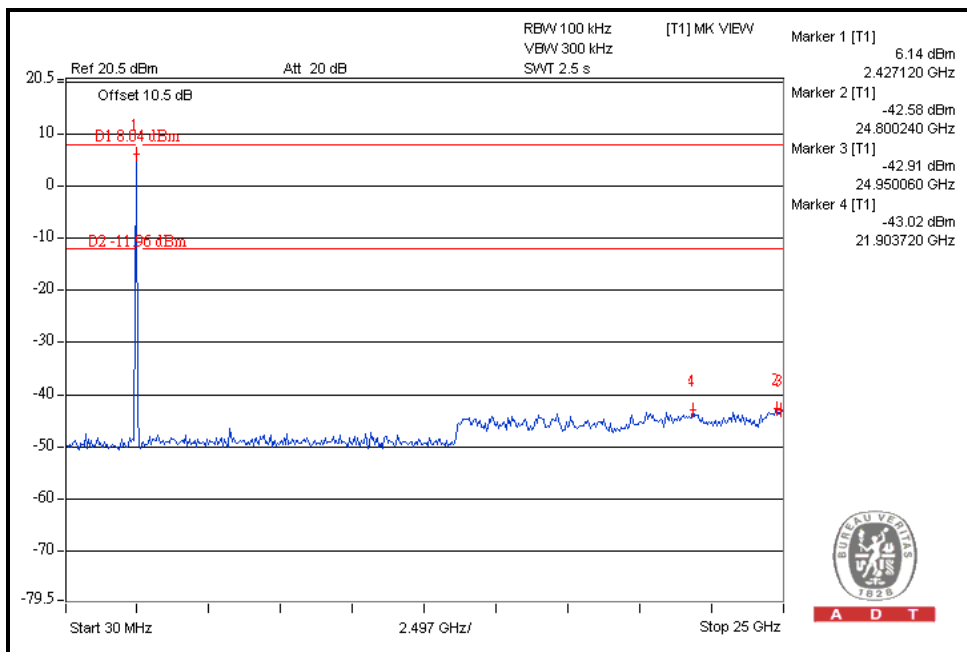
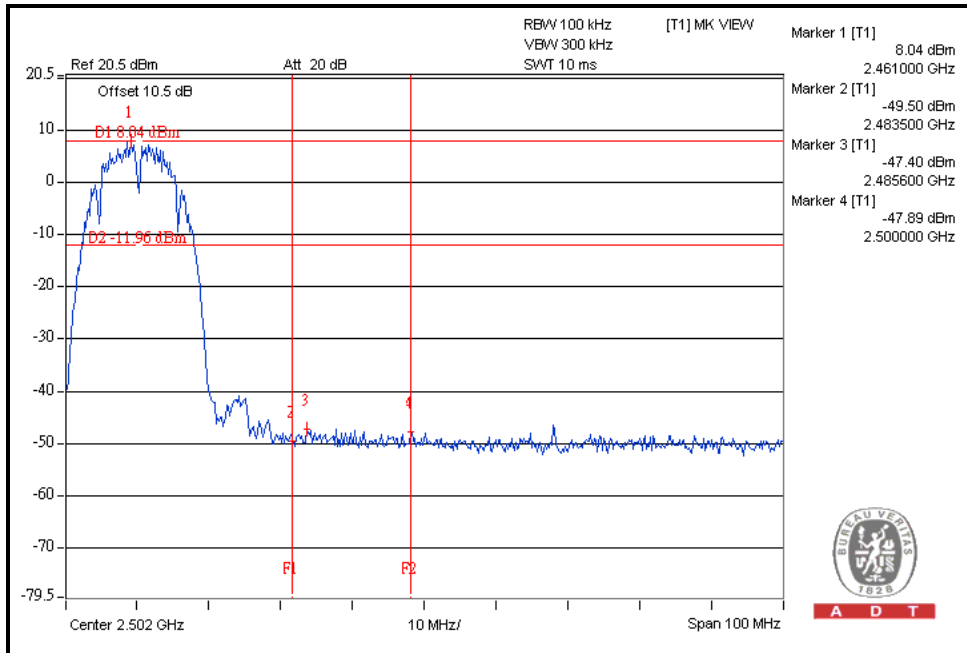

802.11g OFDM MODULATION:

For Chain(0) : CH1

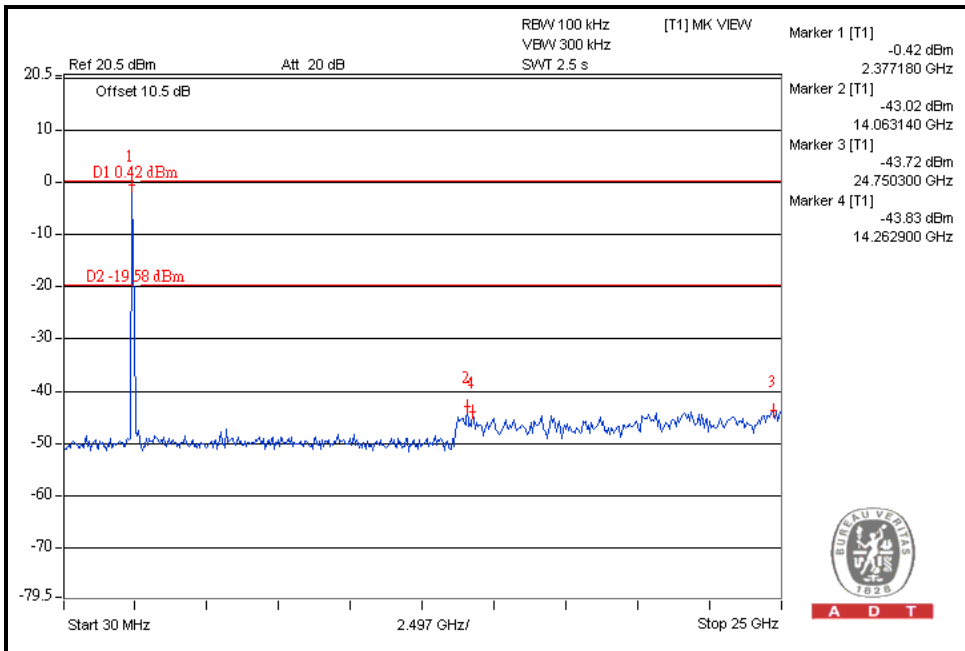
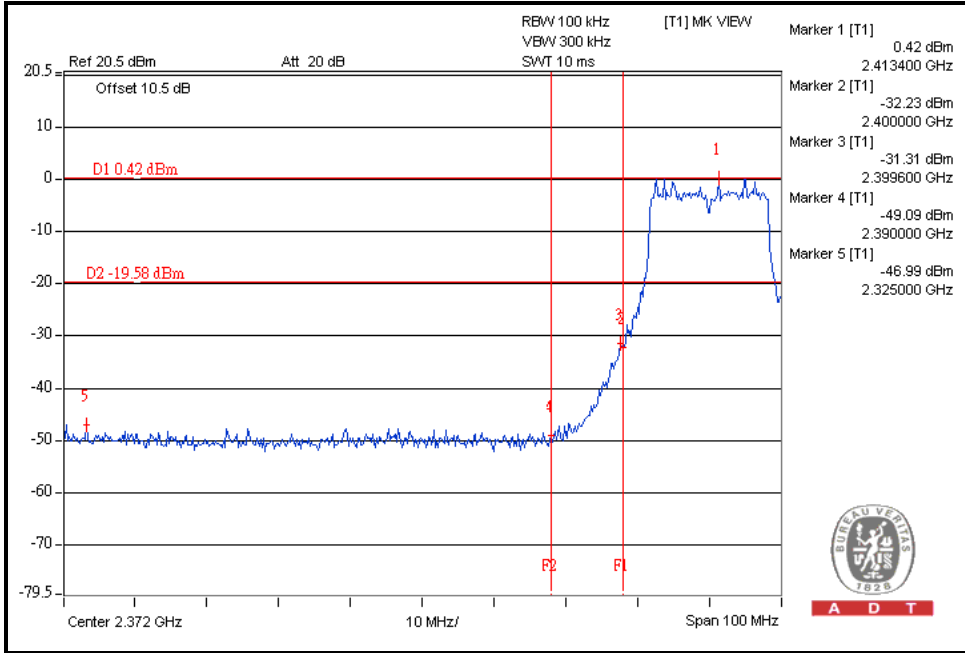



A D T

For Chain(0) : CH11

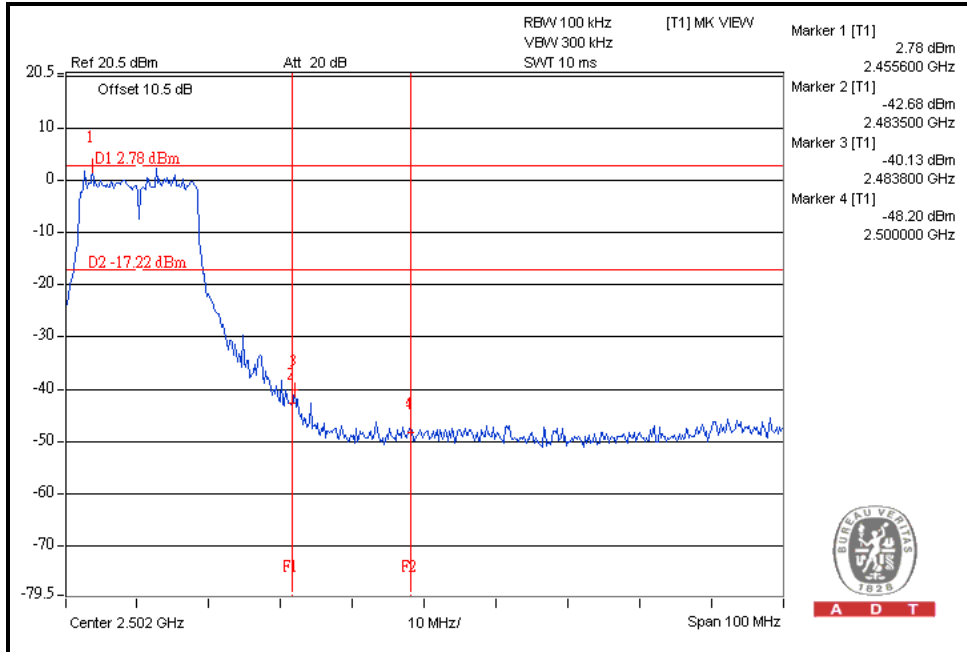

A D T

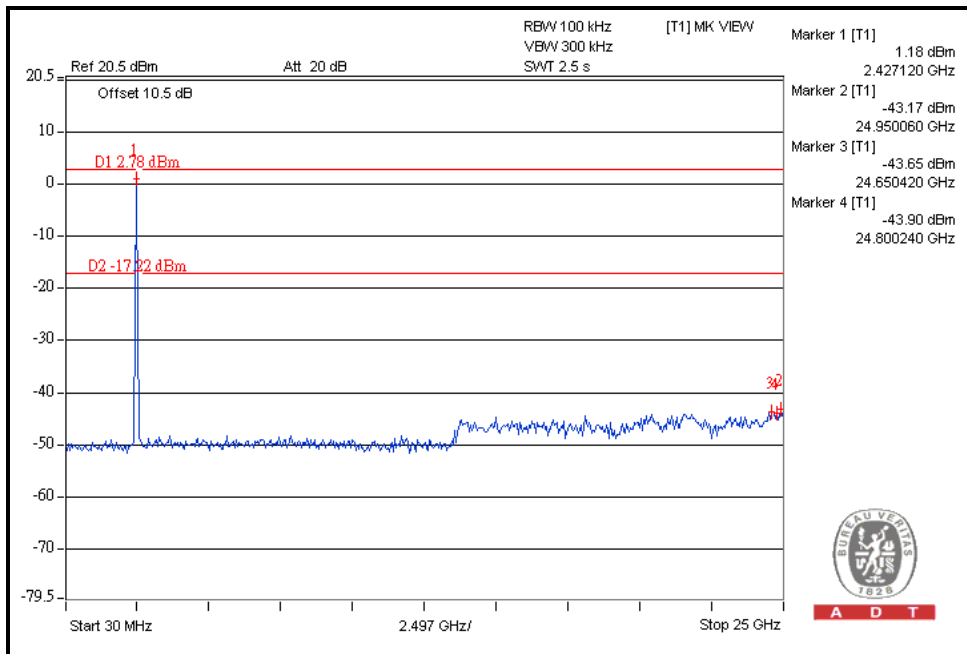

A D T



A D T

For Chain(1) : CH1

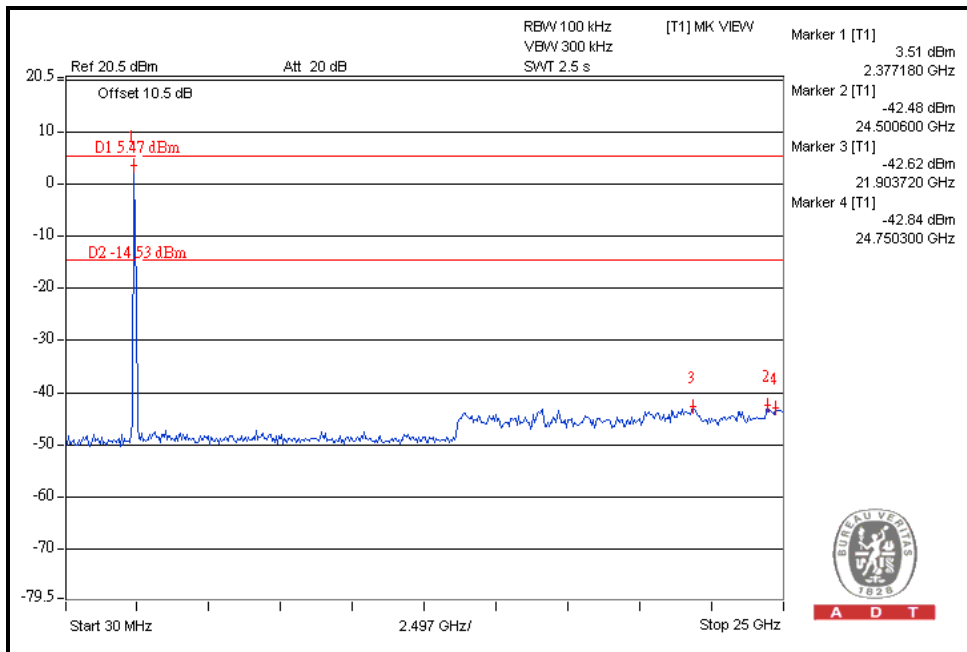
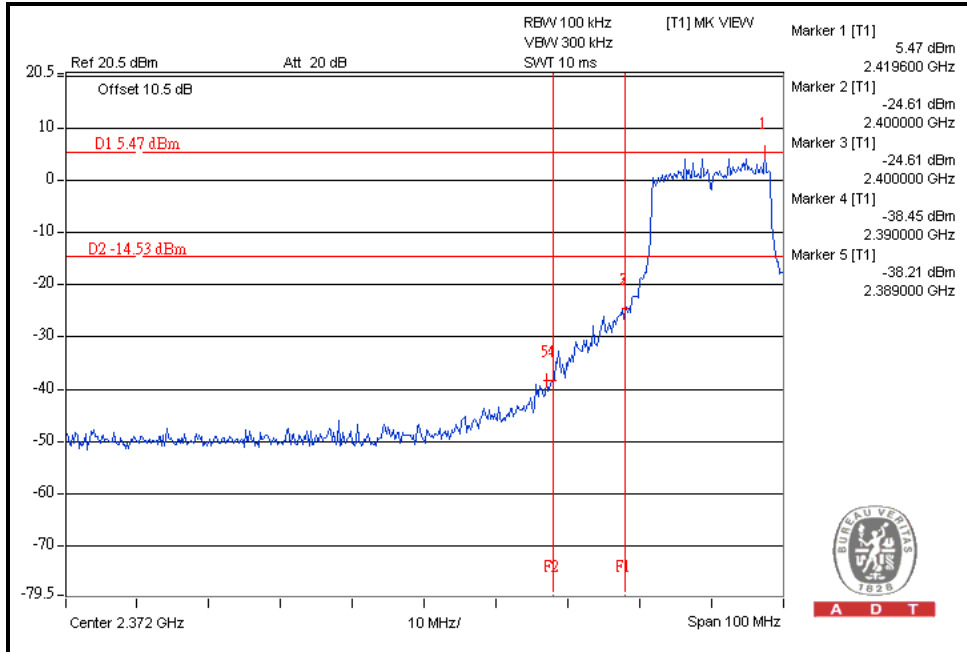



A D T

For Chain(1) : CH11

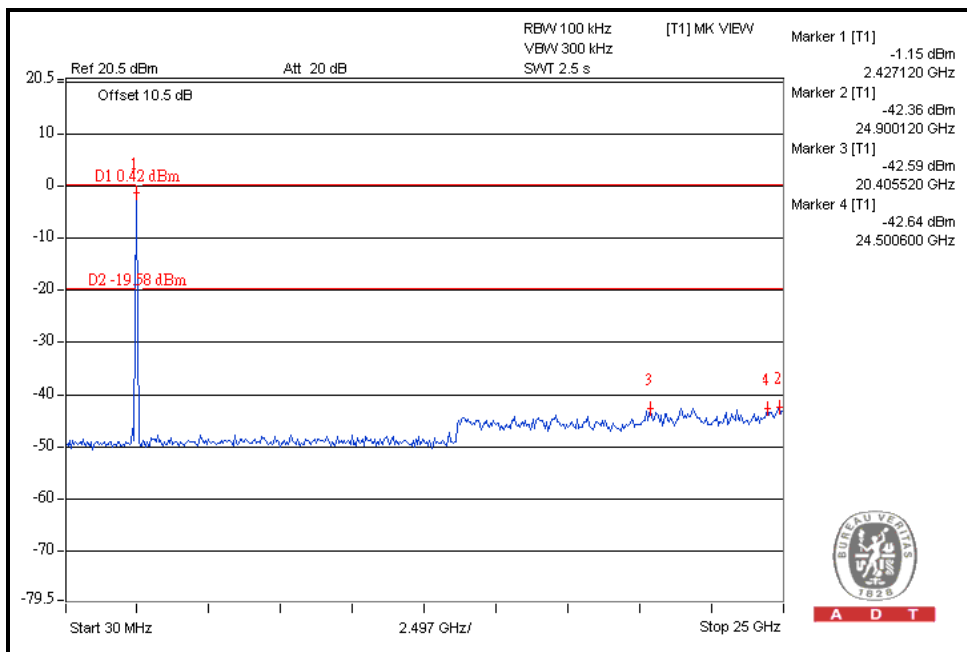
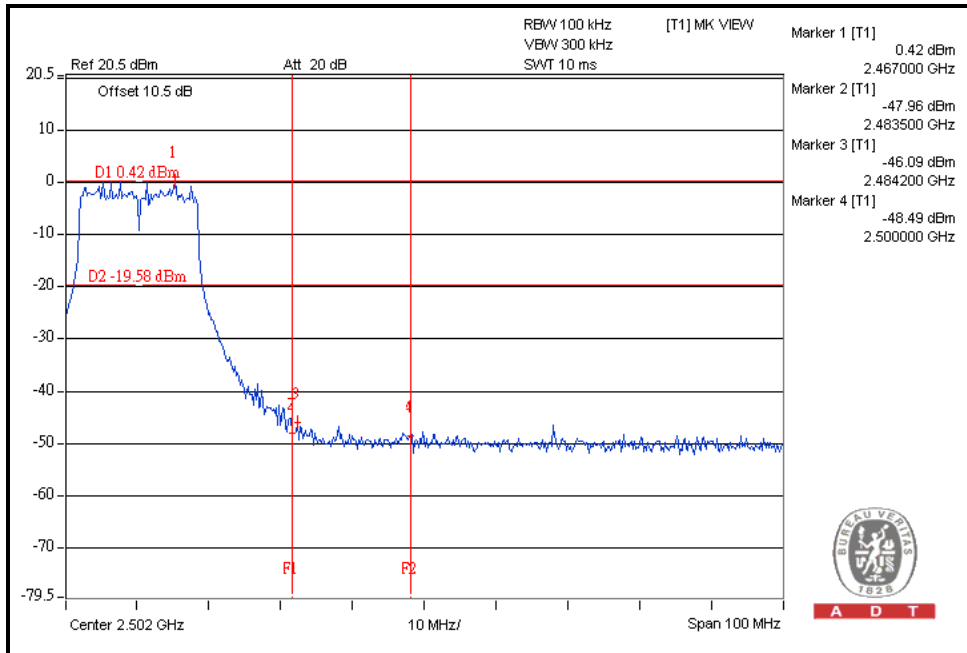

802.11n (20MHz) OFDM MODULATION:

For Chain(0) : CH1

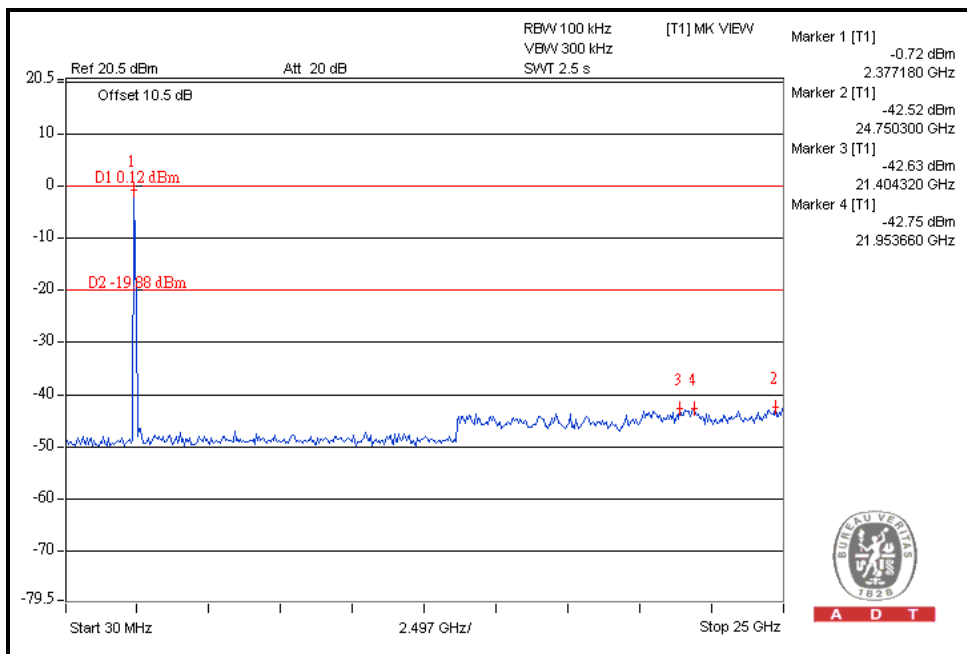
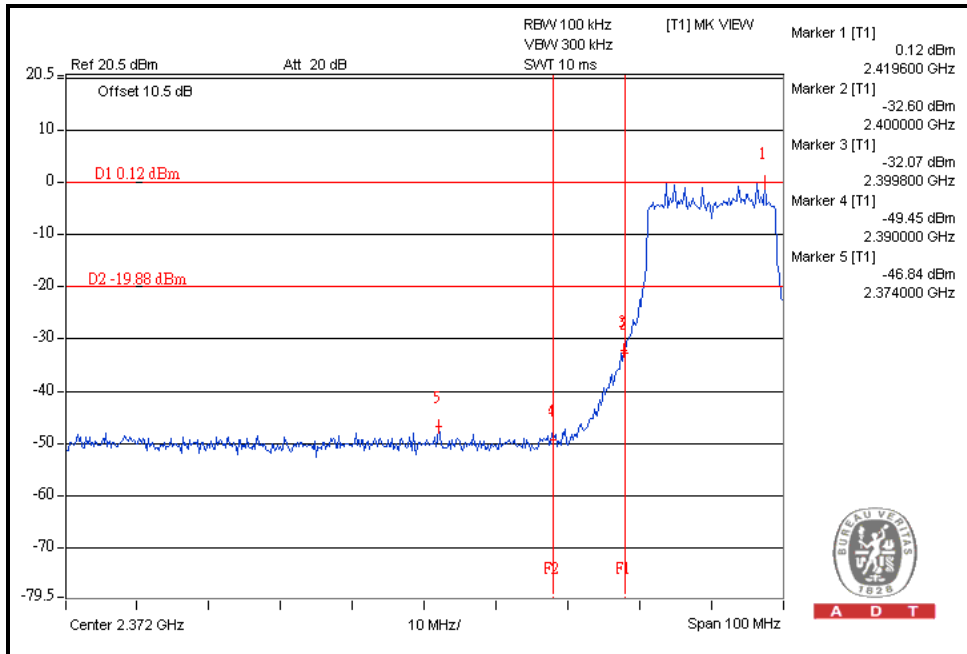

For Chain(0) : CH11

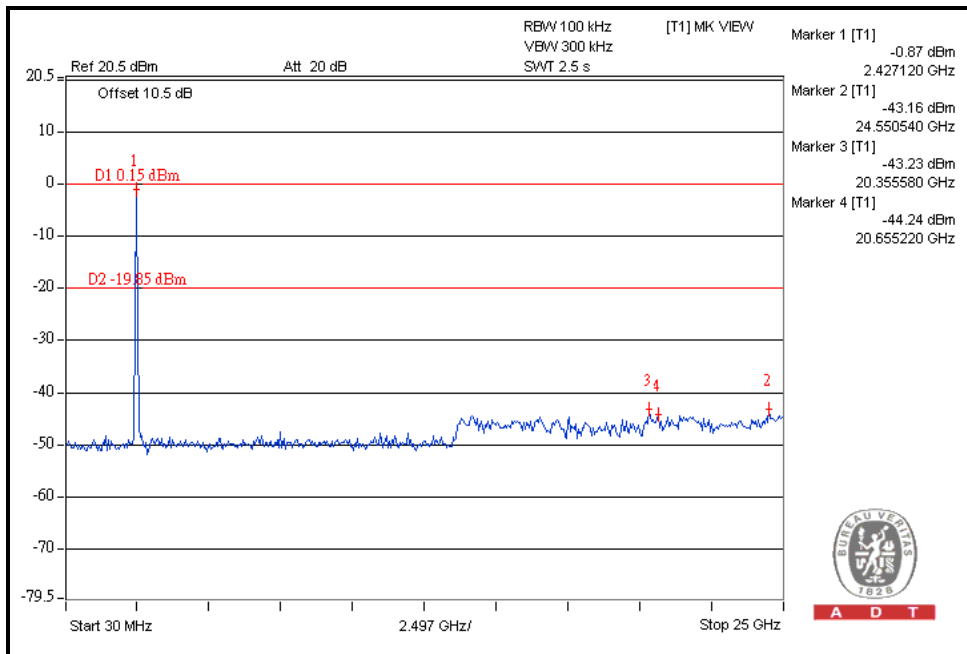
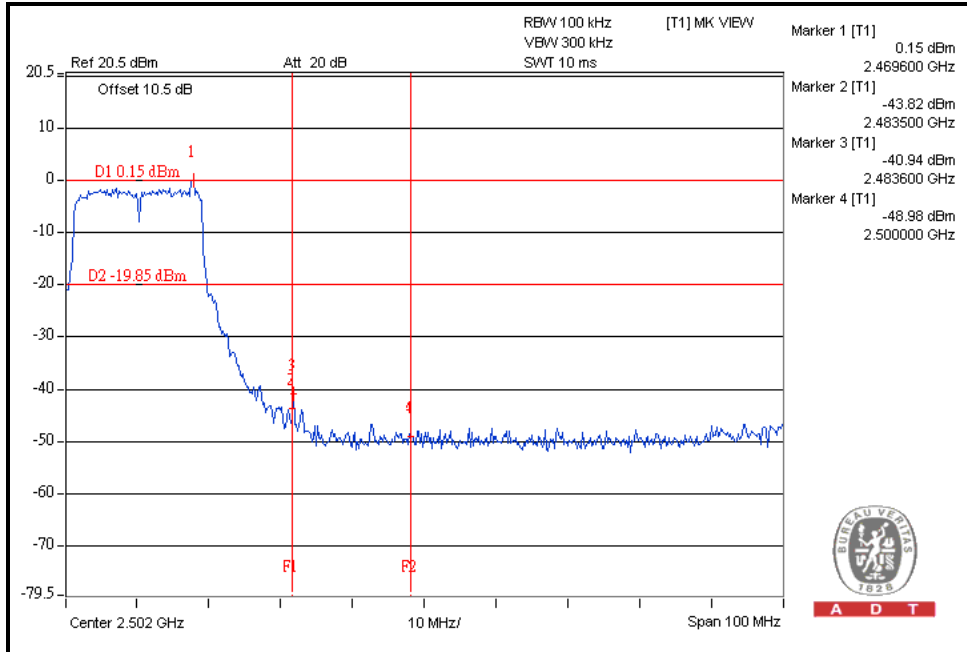



A D T

For Chain(1) : CH1

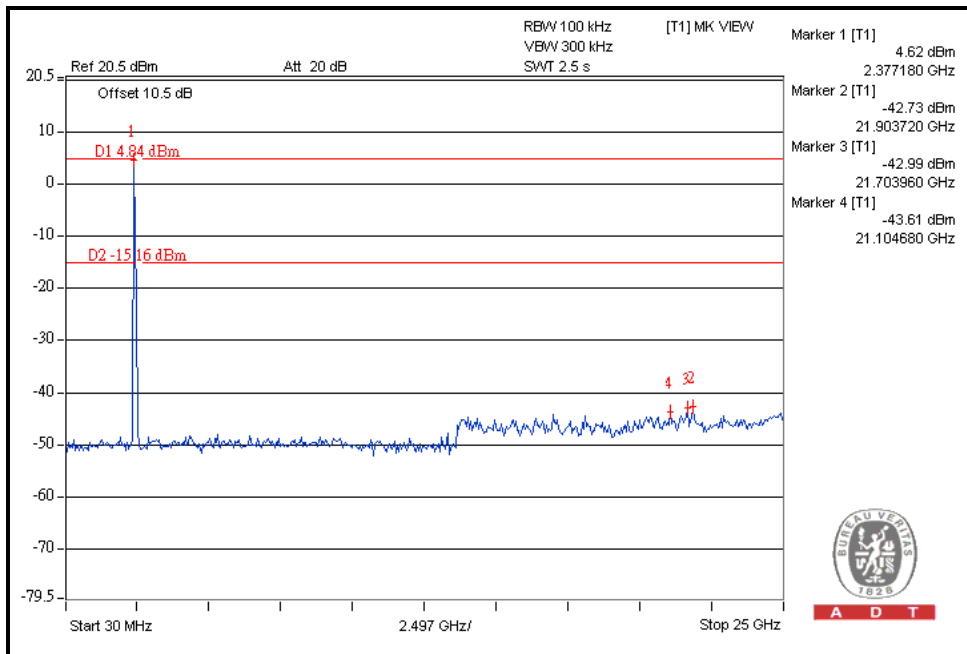
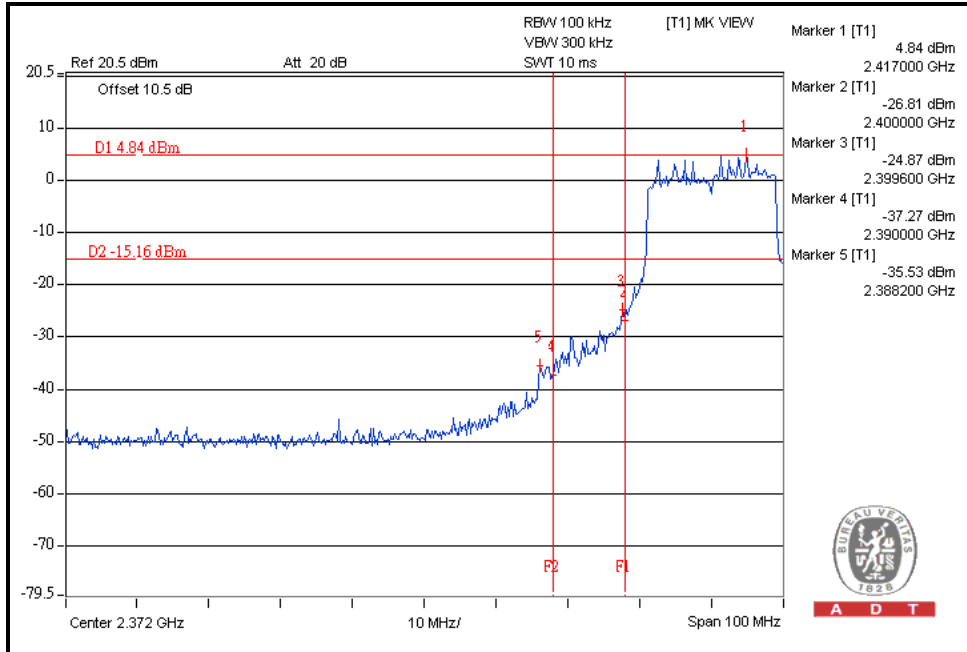



A D T

For Chain(1) : CH11

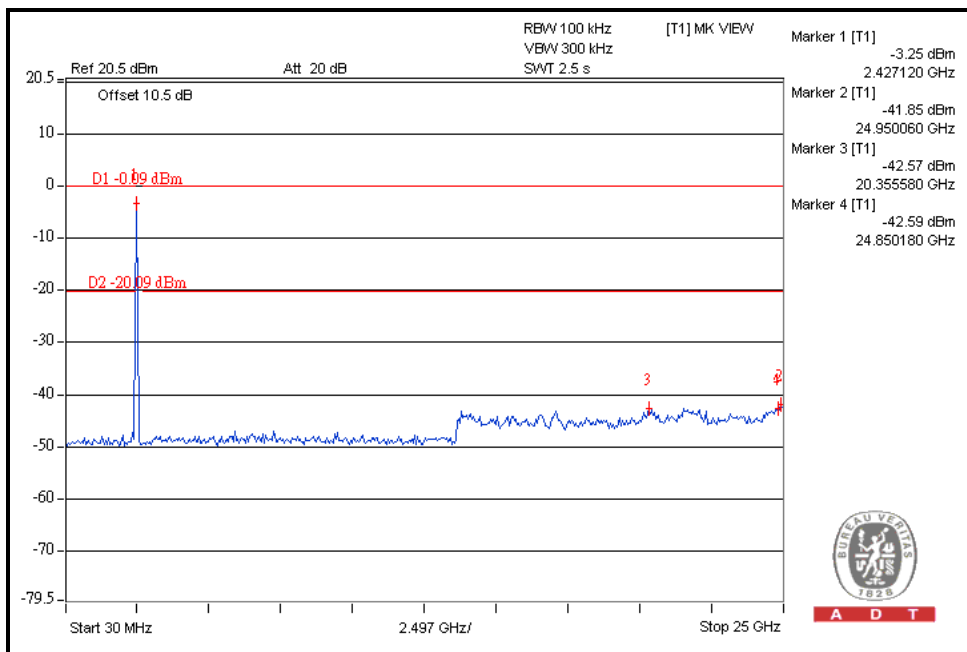
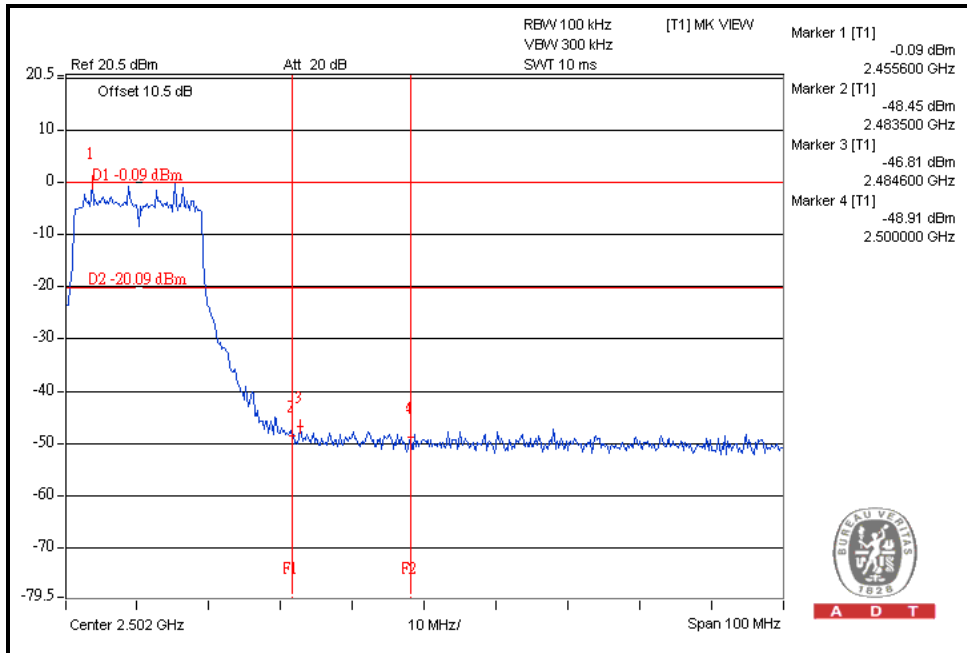



A D T

802.11n (40MHz) OFDM MODULATION:

For Chain(0) : CH3

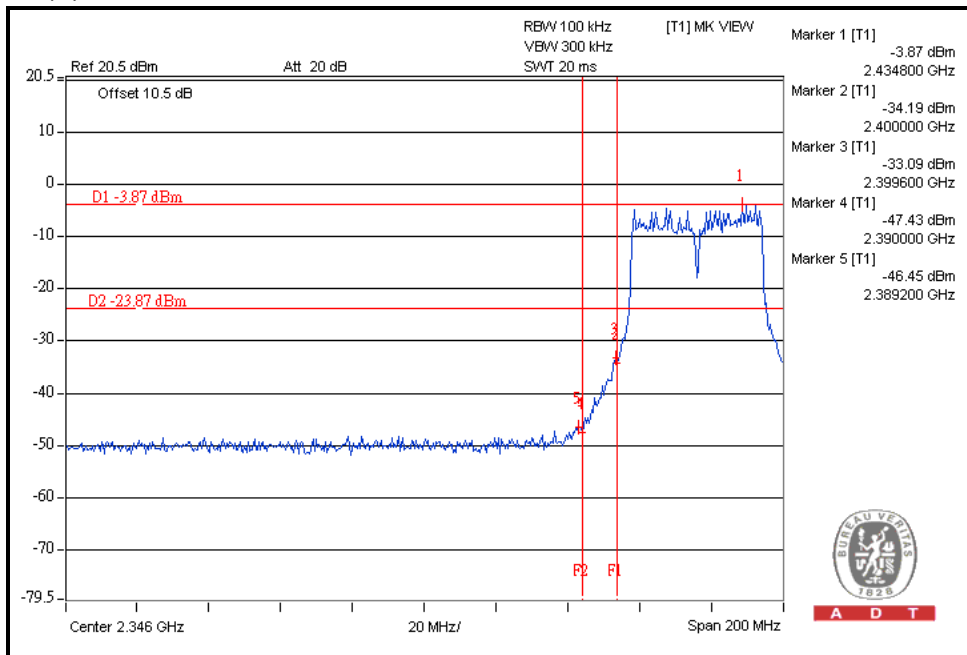

A D T

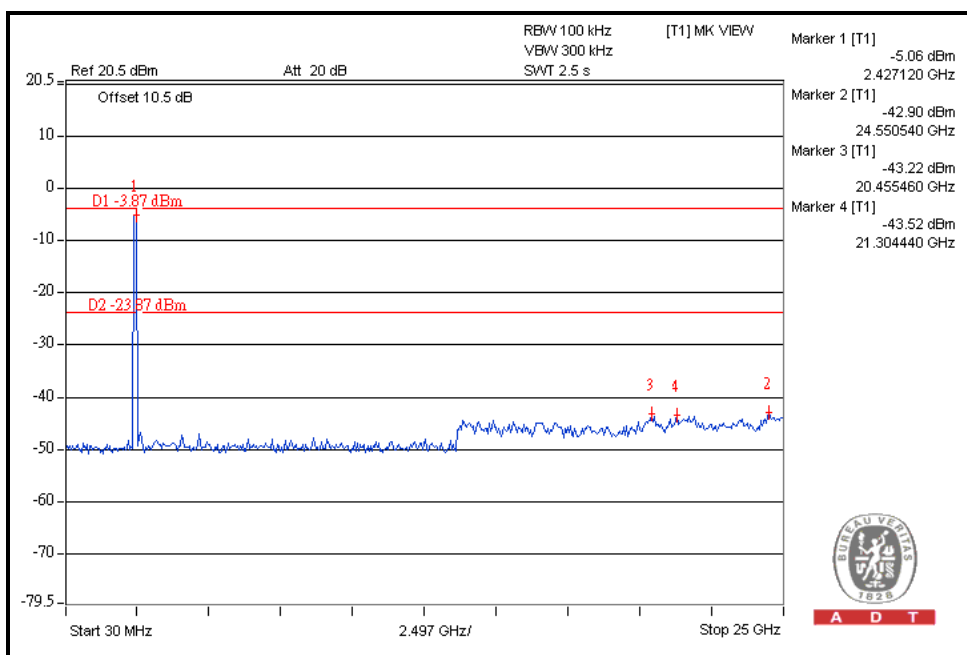

A D T



A D T

For Chain(0) : CH9

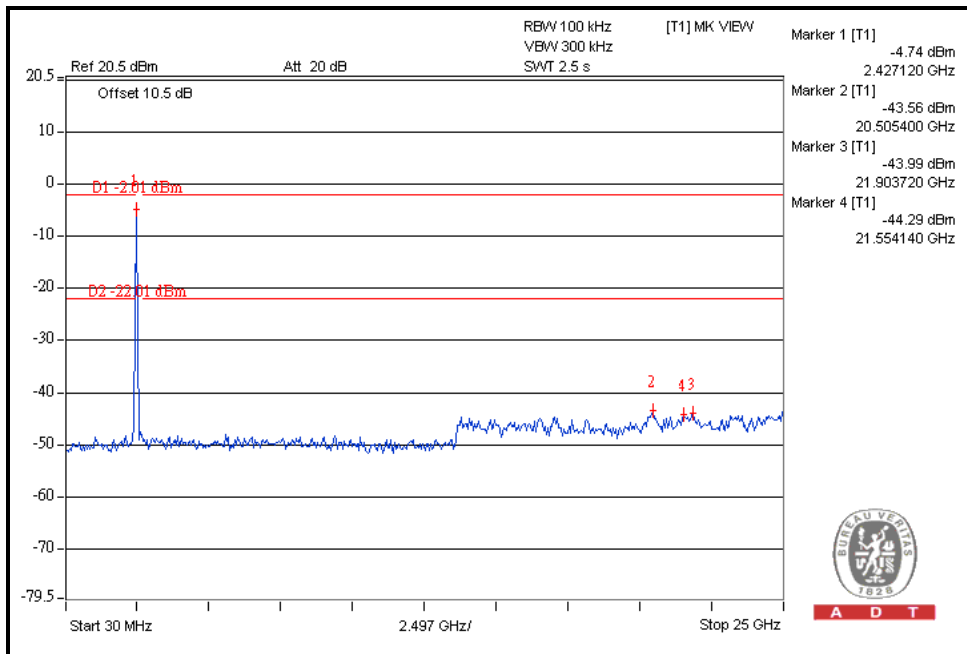
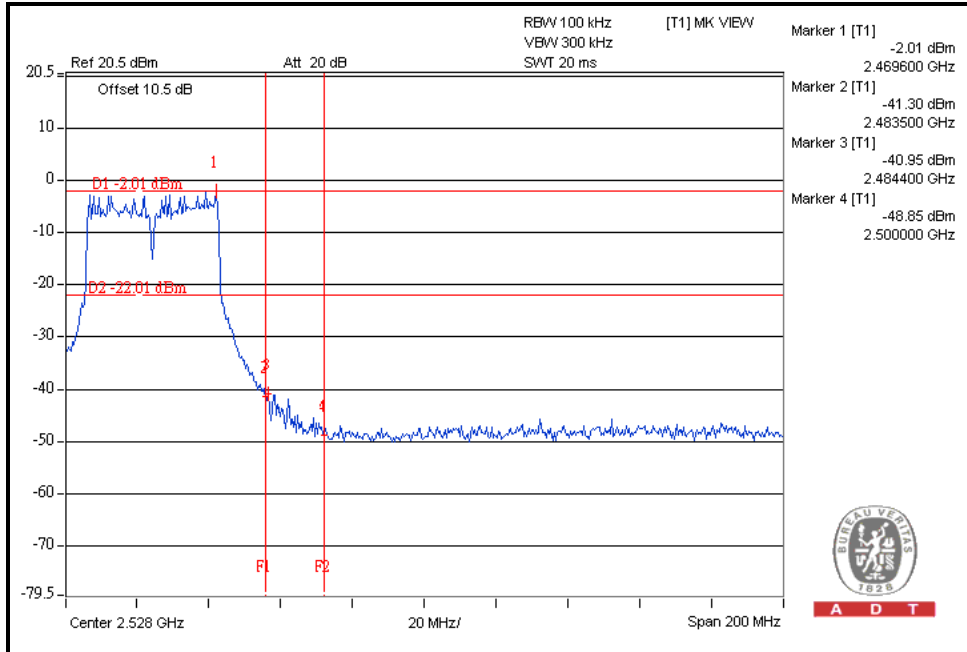



A D T

For Chain(1) : CH3

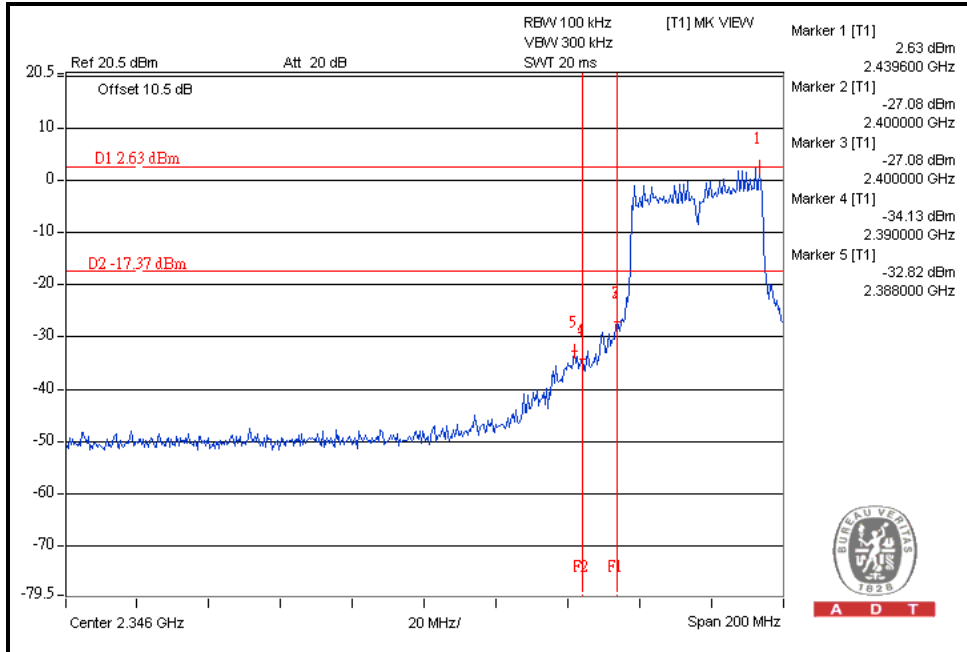

A D T

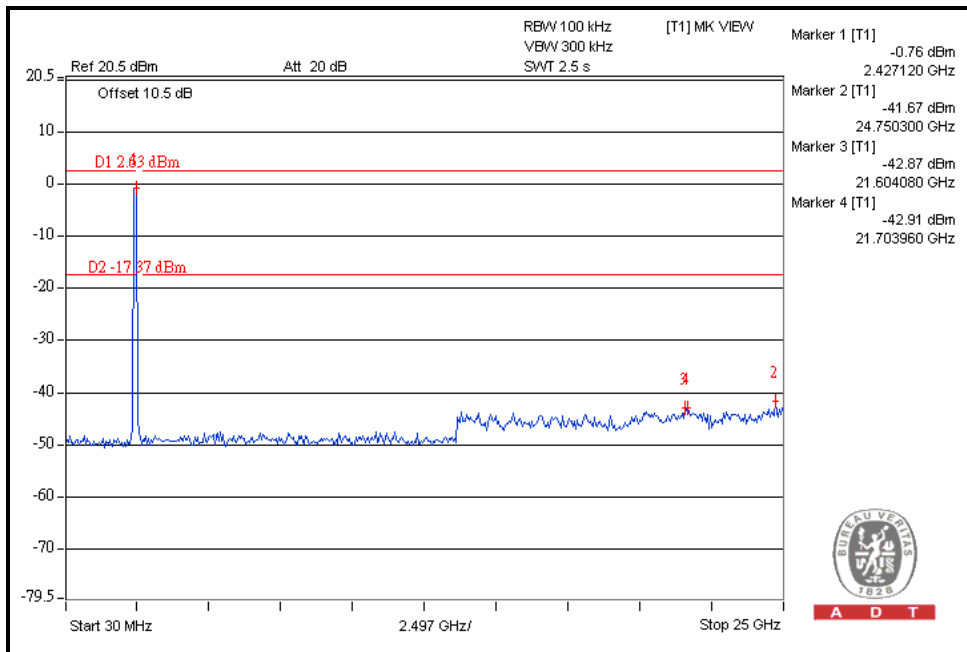

A D T



A D T

For Chain(1) : CH9

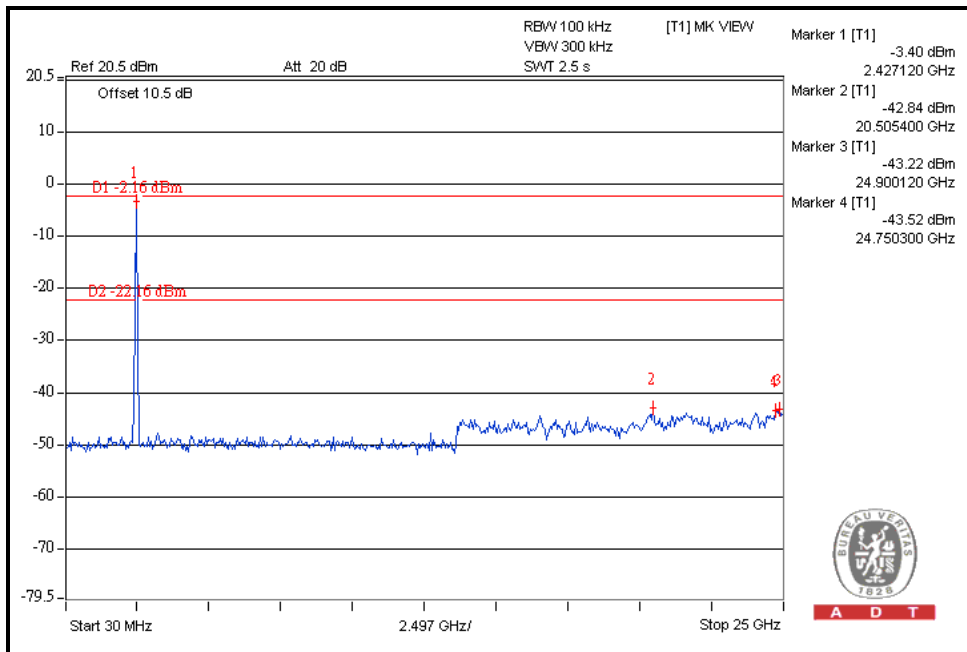
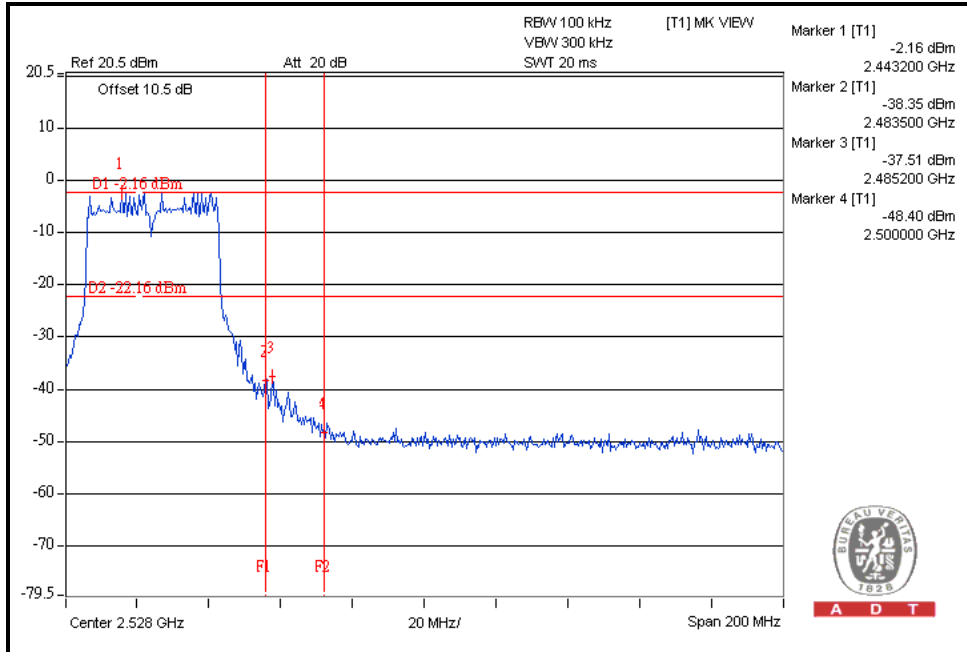



A D T

5. TEST TYPES AND RESULTS (802.11a, 5725~5850MHz Band)

5.1 CONDUCTED EMISSION MEASUREMENT

5.1.1 LIMITS OF CONDUCTED EMISSION MEASUREMENT

FREQUENCY OF EMISSION (MHz)	CONDUCTED LIMIT (dBµV)	
	Quasi-peak	Average
0.15-0.5	66 to 56	56 to 46
0.5-5	56	46
5-30	60	50

- NOTE:**
1. The lower limit shall apply at the transition frequencies.
 2. The limit decreases in line with the logarithm of the frequency in the range of 0.15 to 0.50 MHz.
 3. All emanations from a class A/B digital device or system, including any network of conductors and apparatus connected thereto, shall not exceed the level of field strengths specified above.

5.1.2 TEST INSTRUMENTS

Test date: June 22, 2011

DESCRIPTION & MANUFACTURER	MODEL NO.	SERIAL NO.	CALIBRATED DATE	CALIBRATED UNTIL
Test Receiver	ESCS 30	100375	Mar. 09, 2011	Mar. 08, 2012
Line-Impedance Stabilization Network (for EUT)	NSLK 8127	8127-522	Sep. 08, 2010	Sep. 07, 2011
Line-Impedance Stabilization Network (for Peripheral)	ESH3-Z5	848773/004	Nov. 03, 2010	Nov. 02, 2011
RF Cable (JYEBAO)	5DFB	COCCAB-002	Aug. 30, 2010	Aug. 29, 2011
50 ohms Terminator	50	3	Nov. 03, 2010	Nov. 02, 2011
Software	BV ADT_Cond_V7.3.7	NA	NA	NA

Note:

1. The calibration interval of the above test instruments is 12 months and the calibrations are traceable to NML/ROC and NIST/USA.
2. The test was performed in Shielded Room No. C.
3. The VCCI Con C Registration No. is C-3611.



A D T

5.1.3 TEST PROCEDURES

- a. The EUT was placed 0.4 meters from the conducting wall of the shielded room with EUT being connected to the power mains through a line impedance stabilization network (LISN). Other support units were connected to the power mains through another LISN. The two LISNs provide 50 ohm/ 50uH of coupling impedance for the measuring instrument.
- b. Both lines of the power mains connected to the EUT were checked for maximum conducted interference.
- c. The frequency range from 150kHz to 30MHz was searched. Emission levels under (Limit – 20dB) were not recorded.

5.1.4 DEVIATION FROM TEST STANDARD

No deviation

5.1.5 TEST SETUP

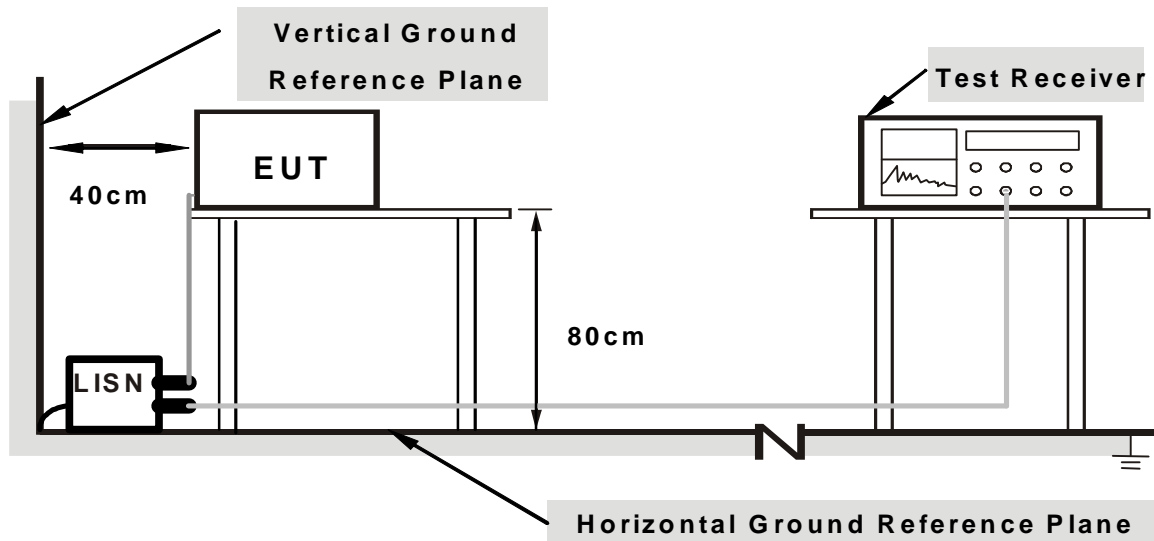

Note: 1. Support units were connected to second LISN.

2. Both of LISNs (AMN) are 80 cm from EUT and at least 80 from other units and other metal planes

For the actual test configuration, please refer to the related item – Photographs of the Test Configuration.

5.1.6 EUT OPERATING CONDITIONS

Same as the 4.1.6

5.1.7 TEST RESULTS

PHASE	Line (L)	6dB BANDWIDTH	9 kHz
--------------	----------	----------------------	-------

No	Freq.	Corr.	Reading Value		Emission Level		Limit		Margin	
	[MHz]	Factor	[dB (uV)]		[dB (uV)]		[dB (uV)]		(dB)	
		(dB)	Q.P.	AV.	Q.P.	AV.	Q.P.	AV.	Q.P.	AV.
1	0.209	0.40	40.03	38.26	40.43	38.66	63.26	53.26	-22.83	-14.60
2	0.937	0.42	30.15	26.34	30.57	26.76	56.00	46.00	-25.43	-19.24
3	1.039	0.42	29.24	21.33	29.66	21.75	56.00	46.00	-26.34	-24.25
4	9.902	0.94	26.53	22.68	27.47	23.62	60.00	50.00	-32.53	-26.38
5	12.629	1.04	29.25	25.26	30.29	26.30	60.00	50.00	-29.71	-23.70
6	15.363	1.14	36.11	32.56	37.25	33.70	60.00	50.00	-22.75	-16.30
7	23.996	1.45	28.58	27.11	30.03	28.56	60.00	50.00	-29.97	-21.44

- REMARKS:**
1. Q.P. and AV. are abbreviations of quasi-peak and average individually.
 2. The emission levels of other frequencies were very low against the limit.
 3. Margin value = Emission level - Limit value
 4. Correction factor = Insertion loss + Cable loss
 5. Emission Level = Correction Factor + Reading Value.

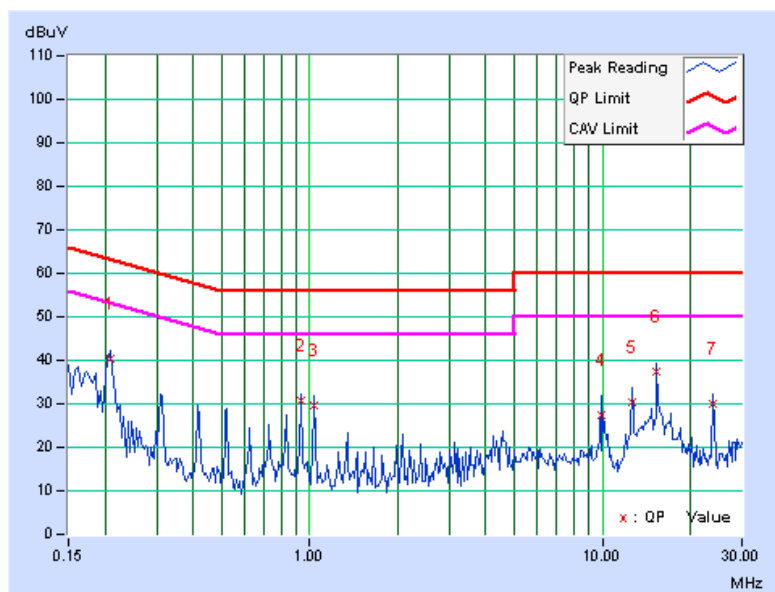

PHASE	Neutral (N)	6dB BANDWIDTH	9 kHz
--------------	-------------	----------------------	-------

No	Freq. [MHz]	Corr. Factor (dB)	Reading Value		Emission Level		Limit		Margin	
			[dB (uV)]		[dB (uV)]		[dB (uV)]		(dB)	
			Q.P.	AV.	Q.P.	AV.	Q.P.	AV.	Q.P.	AV.
1	0.154	0.12	33.52	20.24	33.64	20.36	65.78	55.78	-32.15	-35.43
2	0.313	0.16	29.77	28.64	29.93	28.80	59.89	49.89	-29.97	-21.10
3	0.521	0.16	25.34	22.52	25.50	22.68	56.00	46.00	-30.50	-23.32
4	0.935	0.18	29.36	24.45	29.54	24.63	56.00	46.00	-26.46	-21.37
5	12.634	0.92	29.35	25.84	30.27	26.76	60.00	50.00	-29.73	-23.24
6	15.362	1.11	36.37	33.26	37.48	34.37	60.00	50.00	-22.52	-15.63
7	23.992	1.71	28.63	27.14	30.34	28.85	60.00	50.00	-29.66	-21.15

- REMARKS:**
1. Q.P. and AV. are abbreviations of quasi-peak and average individually.
 2. The emission levels of other frequencies were very low against the limit.
 3. Margin value = Emission level - Limit value
 4. Correction factor = Insertion loss + Cable loss
 5. Emission Level = Correction Factor + Reading Value.

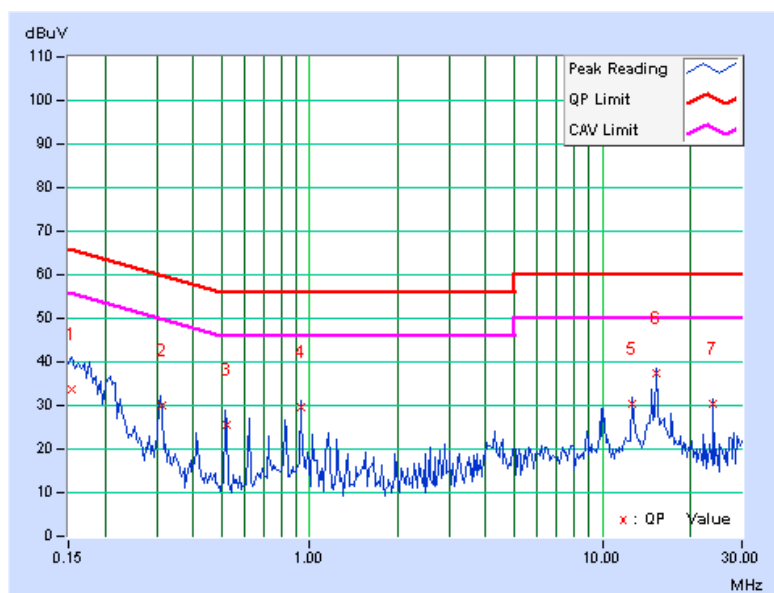

5.2 RADIATED EMISSION MEASUREMENT

5.2.1 LIMITS OF RADIATED EMISSION MEASUREMENT

Emissions radiated outside of the specified bands, shall be according to the general radiated limits in 15.209 as following:

Frequencies (MHz)	Field strength (microvolts/meter)	Measurement distance (meters)
0.009-0.490	2400/F(kHz)	300
0.490-1.705	24000/F(kHz)	30
1.705-30.0	30	30
30-88	100	3
88-216	150	3
216-960	200	3
Above 960	500	3

NOTE:

1. The lower limit shall apply at the transition frequencies.
2. Emission level (dBuV/m) = 20 log Emission level (uV/m).
3. As shown in 15.35(b), for frequencies above 1000MHz, the field strength limits are based on average detector, however, the peak field strength of any emission shall not exceed the maximum permitted average limits, specified above by more than 20dB under any condition of modulation.
4. Section 15.205 restricted bands of operation shall compliance with the limits in Section 15.209.



A D T

5.2.2 TEST INSTRUMENTS

Test date: July 05 to 07, 2011

DESCRIPTION & MANUFACTURER	MODEL NO.	SERIAL NO.	CALIBRATED DATE	CALIBRATED UNTIL
Agilent Spectrum Analyzer	E4446A	MY48250254	July 14, 2010	July 13, 2011
Agilent Pre-Selector	N9039A	MY46520311	July 14, 2010	July 13, 2011
Agilent Signal Generator	N5181A	MY49060517	July 14, 2010	July 13, 2011
Mini-Circuits Pre-Amplifier	ZFL-1000VH2B	AMP-ZFL-03	Nov. 16, 2010	Nov. 15, 2011
Agilent Pre-Amplifier	8449B	3008A02578	July 04, 2011	July 03, 2012
Miteq Pre-Amplifier	AFS33-1800265 0-30-8P-44	881786	NA	NA
SCHWARZBECK Trilog Broadband Antenna	VULB 9168	9168-360	Apr. 14, 2011	Apr. 13, 2012
AISI Horn_Antenna	AIH.8018	0000320091110	Nov. 12, 2010	Nov. 11, 2011
SCHWARZBECK Horn_Antenna	BBHA 9170	9170-424	Oct. 08, 2010	Oct. 07, 2011
RF CABLE	NA	RF104-201 RF104-203 RF104-204	Dec. 27, 2010	Dec. 26, 2011
RF Cable	NA	CHGCAB_001	NA	NA
Software	ADT_Radiated_V8.7.05	NA	NA	NA
CT Antenna Tower & Turn Table	NA	NA	NA	NA

Note: 1. The calibration interval of the above test instruments is 12 months and the calibrations are traceable to NML/ROC and NIST/USA.

2. The horn antenna, preamplifier (model: 8449B) are used only for the measurement of emission frequency above 1GHz if tested.

3. The test was performed in 966 Chamber No. G.

4. The FCC Site Registration No. is 966073.

5. The VCCI Site Registration No. is G-137.

6. The CANADA Site Registration No. is IC 7450H-2.

5.2.3 TEST PROCEDURES

- a. The EUT was placed on the top of a rotating table 0.8 meters above the ground at a 3 meter chamber room. The table was rotated 360 degrees to determine the position of the highest radiation.
- b. The EUT was set 3 meters away from the interference-receiving antenna, which was mounted on the top of a variable-height antenna tower.
- c. The height of antenna is varied from one meter to four meters above the ground to determine the maximum value of the field strength. Both horizontal and vertical polarizations of the antenna are set to make the measurement.
- d. For each suspected emission, the EUT was arranged to its worst case and then the antenna was tuned to heights from 1 meter to 4 meters and the rotatable table was turned from 0 degrees to 360 degrees to find the maximum reading.
- e. The test-receiver system was set to quasi-peak detect function and specified bandwidth with maximum hold mode when the test frequency is below 1 GHz.
- f. The test-receiver system was set to peak and average detect function and specified bandwidth with maximum hold mode when the test frequency is above 1 GHz. If the peak reading value also meets average limit, measurement with the average detector is unnecessary.

NOTE:

1. The resolution bandwidth and video bandwidth of test receiver/spectrum analyzer is 120kHz for Quasi-peak detection (QP) at frequency below 1GHz.
2. The resolution bandwidth of test receiver/spectrum analyzer is 1 MHz and the video bandwidth is 3 MHz for Peak detection (PK) at frequency above 1GHz.
3. The resolution bandwidth of test receiver/spectrum analyzer is 1 MHz and the video bandwidth is 10 Hz for Average detection (AV) at frequency above 1GHz.

5.2.4 DEVIATION FROM TEST STANDARD

No deviation

5.2.5 TEST SETUP

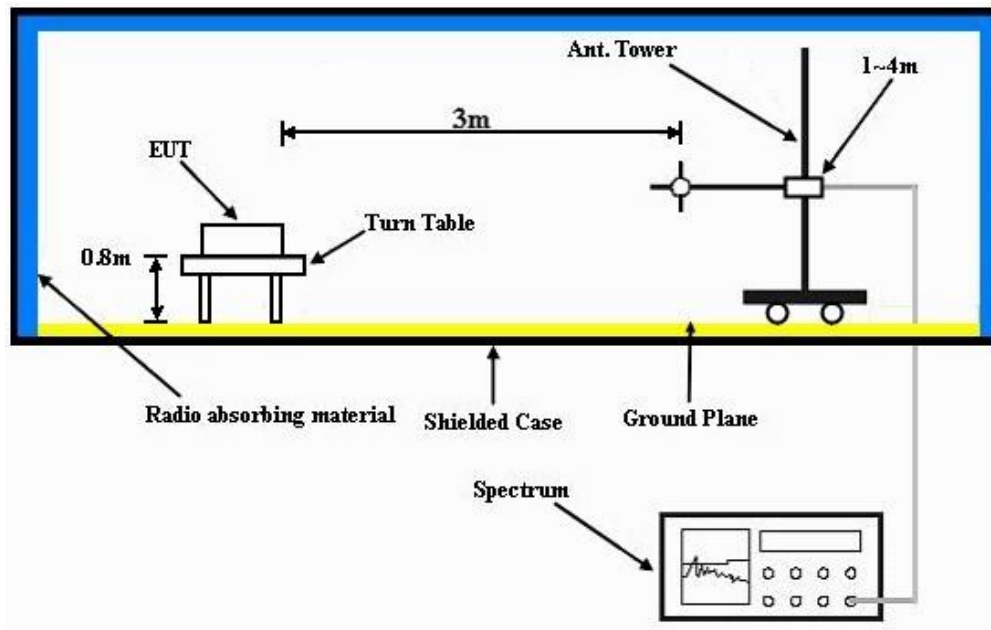

For the actual test configuration, please refer to the related item – Photographs of the Test Configuration.

5.2.6 EUT OPERATING CONDITIONS

Same as the 4.1.6



A D T

5.2.7 TEST RESULTS

BELOW 1GHz WORST-CASE DATA : 802.11n (40MHz) OFDM MODULATION

EUT TEST CONDITION		MEASUREMENT DETAIL	
CHANNEL	Channel 151	FREQUENCY RANGE	Below 1000MHz
INPUT POWER (SYSTEM)	120Vac, 60 Hz	DETECTOR FUNCTION	Quasi-Peak
ENVIRONMENTAL CONDITIONS	24deg. C, 70%RH	TESTED BY	Nelson Teng

ANTENNA POLARITY & TEST DISTANCE: HORIZONTAL AT 3 M								
NO.	FREQ. (MHz)	EMISSION LEVEL (dBuV/m)	LIMIT (dBuV/m)	MARGIN (dB)	ANTENNA HEIGHT (m)	TABLE ANGLE (Degree)	RAW VALUE (dBuV)	CORRECTION FACTOR (dB/m)
1	232.38	38.4 QP	46.0	-7.6	1.00 H	325	25.79	12.59
2	298.70	36.0 QP	46.0	-10.0	1.00 H	247	20.91	15.13
3	336.00	34.3 QP	46.0	-11.7	1.00 H	37	18.21	16.07
4	527.97	37.0 QP	46.0	-9.1	1.50 H	41	16.41	20.54
5	750.01	35.0 QP	46.0	-11.0	1.25 H	360	11.17	23.87
6	799.63	37.3 QP	46.0	-8.7	1.00 H	317	12.11	25.17

ANTENNA POLARITY & TEST DISTANCE: VERTICAL AT 3 M								
NO.	FREQ. (MHz)	EMISSION LEVEL (dBuV/m)	LIMIT (dBuV/m)	MARGIN (dB)	ANTENNA HEIGHT (m)	TABLE ANGLE (Degree)	RAW VALUE (dBuV)	CORRECTION FACTOR (dB/m)
1	232.38	34.1 QP	46.0	-12.0	1.00 V	318	21.46	12.59
2	336.00	33.6 QP	46.0	-12.5	1.25 V	0	17.48	16.07
3	366.44	33.8 QP	46.0	-12.2	1.50 V	94	16.94	16.83
4	527.97	35.7 QP	46.0	-10.3	1.75 V	0	15.18	20.54
5	632.89	35.8 QP	46.0	-10.2	1.25 V	185	13.46	22.31
6	799.75	41.6 QP	46.0	-4.4	1.25 V	111	16.45	25.17

- REMARKS:**
1. Emission level (dBuV/m) = Raw Value (dBuV) + Correction Factor (dB/m).
 2. Correction Factor (dB/m) = Antenna Factor (dB/m) + Cable Factor (dB).
 3. The other emission levels were very low against the limit.
 4. Margin value = Emission level – Limit value.



A D T

ABOVE 1GHz WORST-CASE DATA

802.11a OFDM MODULATION

EUT TEST CONDITION		MEASUREMENT DETAIL	
CHANNEL	Channel 149	FREQUENCY RANGE	1 ~ 40GHz
INPUT POWER (SYSTEM)	120Vac, 60 Hz	DETECTOR FUNCTION	Peak (PK) Average (AV)
ENVIRONMENTAL CONDITIONS	26deg. C, 68%RH	TESTED BY	Kent Liu

ANTENNA POLARITY & TEST DISTANCE: HORIZONTAL AT 3 M

NO.	FREQ. (MHz)	EMISSION LEVEL (dBuV/m)	LIMIT (dBuV/m)	MARGIN (dB)	ANTENNA HEIGHT (m)	TABLE ANGLE (Degree)	RAW VALUE (dBuV)	CORRECTION FACTOR (dB/m)
1	*5745.00	113.6 PK			1.26 H	67	72.05	41.55
2	*5745.00	103.4 AV			1.26 H	67	61.85	41.55
3	11490.00	55.2 PK	74.0	-18.8	1.12 H	57	7.49	47.71
4	11490.00	43.2 AV	54.0	-10.8	1.12 H	57	-4.51	47.71

ANTENNA POLARITY & TEST DISTANCE: VERTICAL AT 3 M

NO.	FREQ. (MHz)	EMISSION LEVEL (dBuV/m)	LIMIT (dBuV/m)	MARGIN (dB)	ANTENNA HEIGHT (m)	TABLE ANGLE (Degree)	RAW VALUE (dBuV)	CORRECTION FACTOR (dB/m)
1	*5745.00	119.7 PK			1.31 V	6	78.15	41.55
2	*5745.00	108.5 AV			1.31 V	6	66.95	41.55
3	11490.00	54.7 PK	74.0	-19.3	1.18 V	25	6.99	47.71
4	11490.00	43.5 AV	54.0	-10.5	1.18 V	25	-4.21	47.71

- REMARKS:**
1. Emission level (dBuV/m) = Raw Value (dBuV) + Correction Factor (dB/m).
 2. Correction Factor (dB/m) = Antenna Factor (dB/m) + Cable Factor (dB).
 3. The other emission levels were very low against the limit.
 4. Margin value = Emission level – Limit value.
 5. “ * “: Fundamental frequency.
 6. The limit value is defined as per 15.247.



A D T

EUT TEST CONDITION		MEASUREMENT DETAIL	
CHANNEL	Channel 157	FREQUENCY RANGE	1 ~ 40GHz
INPUT POWER (SYSTEM)	120Vac, 60 Hz	DETECTOR FUNCTION	Peak (PK) Average (AV)
ENVIRONMENTAL CONDITIONS	26deg. C, 68%RH	TESTED BY	Kent Liu

ANTENNA POLARITY & TEST DISTANCE: HORIZONTAL AT 3 M								
NO.	FREQ. (MHz)	EMISSION LEVEL (dBuV/m)	LIMIT (dBuV/m)	MARGIN (dB)	ANTENNA HEIGHT (m)	TABLE ANGLE (Degree)	RAW VALUE (dBuV)	CORRECTION FACTOR (dB/m)
1	*5785.00	113.8 PK			1.22 H	56	72.12	41.68
2	*5785.00	103.6 AV			1.22 H	56	61.92	41.68
3	11570.00	55.5 PK	74.0	-18.5	1.16 H	69	7.75	47.75
4	11570.00	43.7 AV	54.0	-10.3	1.16 H	69	-4.05	47.75

ANTENNA POLARITY & TEST DISTANCE: VERTICAL AT 3 M								
NO.	FREQ. (MHz)	EMISSION LEVEL (dBuV/m)	LIMIT (dBuV/m)	MARGIN (dB)	ANTENNA HEIGHT (m)	TABLE ANGLE (Degree)	RAW VALUE (dBuV)	CORRECTION FACTOR (dB/m)
1	*5785.00	118.1 PK			1.34 V	13	76.42	41.68
2	*5785.00	108.6 AV			1.34 V	13	66.92	41.68
3	11570.00	55.0 PK	74.0	-19.0	1.14 V	35	7.25	47.75
4	11570.00	43.7 AV	54.0	-10.3	1.14 V	35	-4.05	47.75

- REMARKS:**
1. Emission level (dBuV/m) = Raw Value (dBuV) + Correction Factor (dB/m).
 2. Correction Factor (dB/m) = Antenna Factor (dB/m) + Cable Factor (dB).
 3. The other emission levels were very low against the limit.
 4. Margin value = Emission level – Limit value.
 5. “ * ”: Fundamental frequency.
 6. The limit value is defined as per 15.247.



A D T

EUT TEST CONDITION		MEASUREMENT DETAIL	
CHANNEL	Channel 165	FREQUENCY RANGE	1 ~ 40GHz
INPUT POWER (SYSTEM)	120Vac, 60 Hz	DETECTOR FUNCTION	Peak (PK) Average (AV)
ENVIRONMENTAL CONDITIONS	26deg. C, 68%RH	TESTED BY	Kent Liu

ANTENNA POLARITY & TEST DISTANCE: HORIZONTAL AT 3 M								
NO.	FREQ. (MHz)	EMISSION LEVEL (dBuV/m)	LIMIT (dBuV/m)	MARGIN (dB)	ANTENNA HEIGHT (m)	TABLE ANGLE (Degree)	RAW VALUE (dBuV)	CORRECTION FACTOR (dB/m)
1	*5825.00	114.2 PK			1.25 H	54	72.42	41.78
2	*5825.00	103.8 AV			1.25 H	54	62.02	41.78
3	11650.00	55.9 PK	74.0	-18.1	1.12 H	49	8.07	47.83
4	11650.00	43.7 AV	54.0	-10.3	1.12 H	49	-4.13	47.83

ANTENNA POLARITY & TEST DISTANCE: VERTICAL AT 3 M								
NO.	FREQ. (MHz)	EMISSION LEVEL (dBuV/m)	LIMIT (dBuV/m)	MARGIN (dB)	ANTENNA HEIGHT (m)	TABLE ANGLE (Degree)	RAW VALUE (dBuV)	CORRECTION FACTOR (dB/m)
1	*5825.00	118.2 PK			1.34 V	15	76.42	41.78
2	*5825.00	108.4 AV			1.34 V	15	66.62	41.78
3	11650.00	55.4 PK	74.0	-18.6	1.17 V	14	7.57	47.83
4	11650.00	44.0 AV	54.0	-10.0	1.17 V	14	-3.83	47.83

- REMARKS:**
1. Emission level (dBuV/m) = Raw Value (dBuV) + Correction Factor (dB/m).
 2. Correction Factor (dB/m) = Antenna Factor (dB/m) + Cable Factor (dB).
 3. The other emission levels were very low against the limit.
 4. Margin value = Emission level – Limit value.
 5. “ * ”: Fundamental frequency.
 6. The limit value is defined as per 15.247.

802.11n (20MHz) OFDM MODULATION

EUT TEST CONDITION		MEASUREMENT DETAIL	
CHANNEL	Channel 149	FREQUENCY RANGE	1 ~ 40GHz
INPUT POWER (SYSTEM)	120Vac, 60 Hz	DETECTOR FUNCTION	Peak (PK) Average (AV)
ENVIRONMENTAL CONDITIONS	26deg. C, 68%RH	TESTED BY	Kent Liu

ANTENNA POLARITY & TEST DISTANCE: HORIZONTAL AT 3 M								
NO.	FREQ. (MHz)	EMISSION LEVEL (dBuV/m)	LIMIT (dBuV/m)	MARGIN (dB)	ANTENNA HEIGHT (m)	TABLE ANGLE (Degree)	RAW VALUE (dBuV)	CORRECTION FACTOR (dB/m)
1	*5745.00	113.5 PK			1.31 H	74	71.95	41.55
2	*5745.00	103.3 AV			1.31 H	74	61.75	41.55
3	11490.00	55.2 PK	74.0	-18.8	1.07 H	53	7.49	47.71
4	11490.00	43.5 AV	54.0	-10.5	1.07 H	53	-4.21	47.71
ANTENNA POLARITY & TEST DISTANCE: VERTICAL AT 3 M								
NO.	FREQ. (MHz)	EMISSION LEVEL (dBuV/m)	LIMIT (dBuV/m)	MARGIN (dB)	ANTENNA HEIGHT (m)	TABLE ANGLE (Degree)	RAW VALUE (dBuV)	CORRECTION FACTOR (dB/m)
1	*5745.00	118.6 PK			1.26 V	0	77.05	41.55
2	*5745.00	108.1 AV			1.26 V	0	66.55	41.55
3	11490.00	55.0 PK	74.0	-19.0	1.13 V	35	7.29	47.71
4	11490.00	43.8 AV	54.0	-10.2	1.13 V	35	-3.91	47.71

- REMARKS:**
1. Emission level (dBuV/m) = Raw Value (dBuV) + Correction Factor (dB/m).
 2. Correction Factor (dB/m) = Antenna Factor (dB/m) + Cable Factor (dB).
 3. The other emission levels were very low against the limit.
 4. Margin value = Emission level – Limit value.
 5. “ * “: Fundamental frequency.
 6. The limit value is defined as per 15.247.



A D T

EUT TEST CONDITION		MEASUREMENT DETAIL	
CHANNEL	Channel 157	FREQUENCY RANGE	1 ~ 40GHz
INPUT POWER (SYSTEM)	120Vac, 60 Hz	DETECTOR FUNCTION	Peak (PK) Average (AV)
ENVIRONMENTAL CONDITIONS	26deg. C, 68%RH	TESTED BY	Kent Liu

ANTENNA POLARITY & TEST DISTANCE: HORIZONTAL AT 3 M								
NO.	FREQ. (MHz)	EMISSION LEVEL (dBuV/m)	LIMIT (dBuV/m)	MARGIN (dB)	ANTENNA HEIGHT (m)	TABLE ANGLE (Degree)	RAW VALUE (dBuV)	CORRECTION FACTOR (dB/m)
1	*5785.00	113.6 PK			1.27 H	78	71.92	41.68
2	*5785.00	103.3 AV			1.27 H	78	61.62	41.68
3	11570.00	56.0 PK	74.0	-18.0	1.09 H	57	8.25	47.75
4	11570.00	43.7 AV	54.0	-10.3	1.09 H	57	-4.05	47.75

ANTENNA POLARITY & TEST DISTANCE: VERTICAL AT 3 M								
NO.	FREQ. (MHz)	EMISSION LEVEL (dBuV/m)	LIMIT (dBuV/m)	MARGIN (dB)	ANTENNA HEIGHT (m)	TABLE ANGLE (Degree)	RAW VALUE (dBuV)	CORRECTION FACTOR (dB/m)
1	*5785.00	117.2 PK			1.36 V	5	75.52	41.68
2	*5785.00	107.9 AV			1.36 V	5	66.22	41.68
3	11570.00	55.0 PK	74.0	-19.0	1.23 V	25	7.25	47.75
4	11570.00	43.6 AV	54.0	-10.4	1.23 V	25	-4.15	47.75

- REMARKS:**
1. Emission level (dBuV/m) = Raw Value (dBuV) + Correction Factor (dB/m).
 2. Correction Factor (dB/m) = Antenna Factor (dB/m) + Cable Factor (dB).
 3. The other emission levels were very low against the limit.
 4. Margin value = Emission level – Limit value.
 5. “ * ”: Fundamental frequency.
 6. The limit value is defined as per 15.247.



A D T

EUT TEST CONDITION		MEASUREMENT DETAIL	
CHANNEL	Channel 165	FREQUENCY RANGE	1 ~ 40GHz
INPUT POWER (SYSTEM)	120Vac, 60 Hz	DETECTOR FUNCTION	Peak (PK) Average (AV)
ENVIRONMENTAL CONDITIONS	26deg. C, 68%RH	TESTED BY	Kent Liu

ANTENNA POLARITY & TEST DISTANCE: HORIZONTAL AT 3 M								
NO.	FREQ. (MHz)	EMISSION LEVEL (dBuV/m)	LIMIT (dBuV/m)	MARGIN (dB)	ANTENNA HEIGHT (m)	TABLE ANGLE (Degree)	RAW VALUE (dBuV)	CORRECTION FACTOR (dB/m)
1	*5825.00	114.2 PK			1.36 H	80	72.42	41.78
2	*5825.00	103.9 AV			1.36 H	80	62.12	41.78
3	11650.00	55.9 PK	74.0	-18.1	1.04 H	67	8.07	47.83
4	11650.00	44.0 AV	54.0	-10.0	1.04 H	67	-3.83	47.83
ANTENNA POLARITY & TEST DISTANCE: VERTICAL AT 3 M								
NO.	FREQ. (MHz)	EMISSION LEVEL (dBuV/m)	LIMIT (dBuV/m)	MARGIN (dB)	ANTENNA HEIGHT (m)	TABLE ANGLE (Degree)	RAW VALUE (dBuV)	CORRECTION FACTOR (dB/m)
1	*5825.00	117.3 PK			1.34 V	11	75.52	41.78
2	*5825.00	107.3 AV			1.34 V	11	65.52	41.78
3	11650.00	55.0 PK	74.0	-19.0	1.13 V	11	7.17	47.83
4	11650.00	43.8 AV	54.0	-10.2	1.13 V	11	-4.03	47.83

- REMARKS:**
1. Emission level (dBuV/m) = Raw Value (dBuV) + Correction Factor (dB/m).
 2. Correction Factor (dB/m) = Antenna Factor (dB/m) + Cable Factor (dB).
 3. The other emission levels were very low against the limit.
 4. Margin value = Emission level – Limit value.
 5. “ * ”: Fundamental frequency.
 6. The limit value is defined as per 15.247.



A D T

802.11n (40MHz) OFDM MODULATION

EUT TEST CONDITION		MEASUREMENT DETAIL	
CHANNEL	Channel 151	FREQUENCY RANGE	1 ~ 40GHz
INPUT POWER (SYSTEM)	120Vac, 60 Hz	DETECTOR FUNCTION	Peak (PK) Average (AV)
ENVIRONMENTAL CONDITIONS	26deg. C, 68%RH	TESTED BY	Kent Liu

ANTENNA POLARITY & TEST DISTANCE: HORIZONTAL AT 3 M								
NO.	FREQ. (MHz)	EMISSION LEVEL (dBuV/m)	LIMIT (dBuV/m)	MARGIN (dB)	ANTENNA HEIGHT (m)	TABLE ANGLE (Degree)	RAW VALUE (dBuV)	CORRECTION FACTOR (dB/m)
1	*5755.00	112.6 PK			1.34 H	87	71.01	41.59
2	*5755.00	102.4 AV			1.34 H	87	60.81	41.59
3	11510.00	56.0 PK	74.0	-18.0	1.03 H	58	8.28	47.72
4	11510.00	44.1 AV	54.0	-9.9	1.03 H	58	-3.62	47.72
ANTENNA POLARITY & TEST DISTANCE: VERTICAL AT 3 M								
NO.	FREQ. (MHz)	EMISSION LEVEL (dBuV/m)	LIMIT (dBuV/m)	MARGIN (dB)	ANTENNA HEIGHT (m)	TABLE ANGLE (Degree)	RAW VALUE (dBuV)	CORRECTION FACTOR (dB/m)
1	*5755.00	116.2 PK			1.32 V	23	74.61	41.59
2	*5755.00	106.4 AV			1.32 V	23	64.81	41.59
3	11510.00	55.5 PK	74.0	-18.5	1.14 V	27	7.78	47.72
4	11510.00	44.1 AV	54.0	-9.9	1.14 V	27	-3.62	47.72

- REMARKS:**
1. Emission level (dBuV/m) = Raw Value (dBuV) + Correction Factor (dB/m).
 2. Correction Factor (dB/m) = Antenna Factor (dB/m) + Cable Factor (dB).
 3. The other emission levels were very low against the limit.
 4. Margin value = Emission level – Limit value.
 5. “ * “: Fundamental frequency.
 6. The limit value is defined as per 15.247.



A D T

EUT TEST CONDITION		MEASUREMENT DETAIL	
CHANNEL	Channel 159	FREQUENCY RANGE	1 ~ 40GHz
INPUT POWER (SYSTEM)	120Vac, 60 Hz	DETECTOR FUNCTION	Peak (PK) Average (AV)
ENVIRONMENTAL CONDITIONS	26deg. C, 68%RH	TESTED BY	Kent Liu

ANTENNA POLARITY & TEST DISTANCE: HORIZONTAL AT 3 M								
NO.	FREQ. (MHz)	EMISSION LEVEL (dBuV/m)	LIMIT (dBuV/m)	MARGIN (dB)	ANTENNA HEIGHT (m)	TABLE ANGLE (Degree)	RAW VALUE (dBuV)	CORRECTION FACTOR (dB/m)
1	*5795.00	112.3 PK			1.31 H	79	70.60	41.70
2	*5795.00	102.5 AV			1.31 H	79	60.80	41.70
3	11590.00	55.7 PK	74.0	-18.3	1.03 H	58	7.94	47.76
4	11590.00	44.0 AV	54.0	-10.0	1.03 H	58	-3.76	47.76

ANTENNA POLARITY & TEST DISTANCE: VERTICAL AT 3 M								
NO.	FREQ. (MHz)	EMISSION LEVEL (dBuV/m)	LIMIT (dBuV/m)	MARGIN (dB)	ANTENNA HEIGHT (m)	TABLE ANGLE (Degree)	RAW VALUE (dBuV)	CORRECTION FACTOR (dB/m)
1	*5795.00	116.2 PK			1.31 V	43	74.50	41.70
2	*5795.00	106.1 AV			1.31 V	43	64.40	41.70
3	11590.00	54.6 PK	74.0	-19.4	1.11 V	48	6.84	47.76
4	11590.00	43.6 AV	54.0	-10.4	1.11 V	48	-4.16	47.76

- REMARKS:**
1. Emission level (dBuV/m) = Raw Value (dBuV) + Correction Factor (dB/m).
 2. Correction Factor (dB/m) = Antenna Factor (dB/m) + Cable Factor (dB).
 3. The other emission levels were very low against the limit.
 4. Margin value = Emission level – Limit value.
 5. “ * ”: Fundamental frequency.
 6. The limit value is defined as per 15.247.

5.3 6dB BANDWIDTH MEASUREMENT

5.3.1 LIMITS OF 6dB BANDWIDTH MEASUREMENT

The minimum of 6dB Bandwidth Measurement is 0.5 MHz.

5.3.2 TEST INSTRUMENTS

Test date: July 07, 2011

DESCRIPTION & MANUFACTURER	MODEL NO.	SERIAL NO.	CALIBRATED DATE	CALIBRATED UNTIL
R&S Spectrum Analyzer	FSP40	100036	Dec. 08, 2010	Dec. 07, 2011

NOTE: The calibration interval of the above test instruments is 12 months and the calibrations are traceable to NML/ROC and NIST/USA.

5.3.3 TEST PROCEDURE

The transmitter output was connected to the spectrum analyzer through an attenuator. The bandwidth of the fundamental frequency was measured by spectrum analyzer with 100kHz RBW and 300kHz VBW. The 6dB bandwidth is defined as the total spectrum the power of which is higher than peak power minus 6dB.

5.3.4 DEVIATION FROM TEST STANDARD

No deviation

5.3.5 TEST SETUP

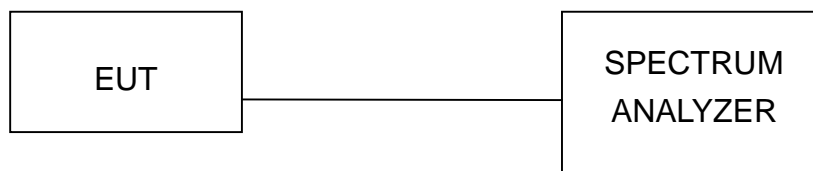

5.3.6 EUT OPERATING CONDITIONS

The software provided by client to enable the EUT under transmission condition continuously at lowest, middle and highest channel frequencies individually.



A D T

5.3.7 TEST RESULTS

802.11a OFDM MODULATION:

CHANNEL	CHANNEL FREQUENCY (MHz)	6dB BANDWIDTH (MHz)		MINIMUM LIMIT (MHz)	PASS / FAIL
		CHAIN(0)	CHAIN(1)		
149	5745	16.39	16.31	0.5	PASS
157	5785	16.39	16.31	0.5	PASS
165	5825	16.39	16.31	0.5	PASS

For Chain(0): CH149

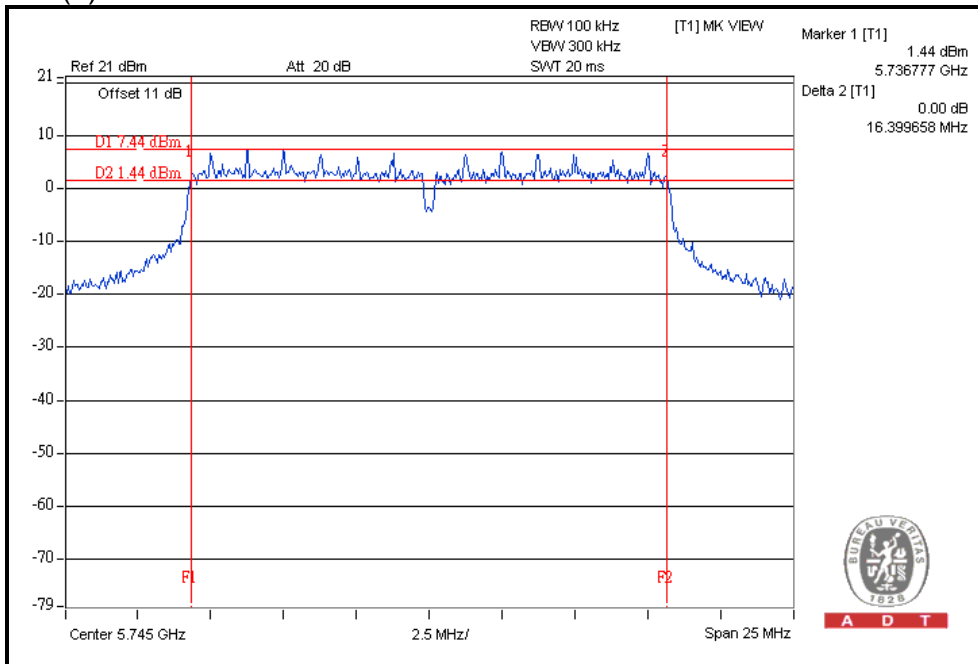



A D T

802.11n (20MHz) OFDM MODULATION:

CHANNEL	CHANNEL FREQUENCY (MHz)	6dB BANDWIDTH (MHz)		MINIMUM LIMIT (MHz)	PASS / FAIL
		CHAIN(0)	CHAIN(1)		
149	5745	17.6	17.46	0.5	PASS
157	5785	17.6	17.5	0.5	PASS
165	5825	17.58	17.41	0.5	PASS

For Chain(0): CH149

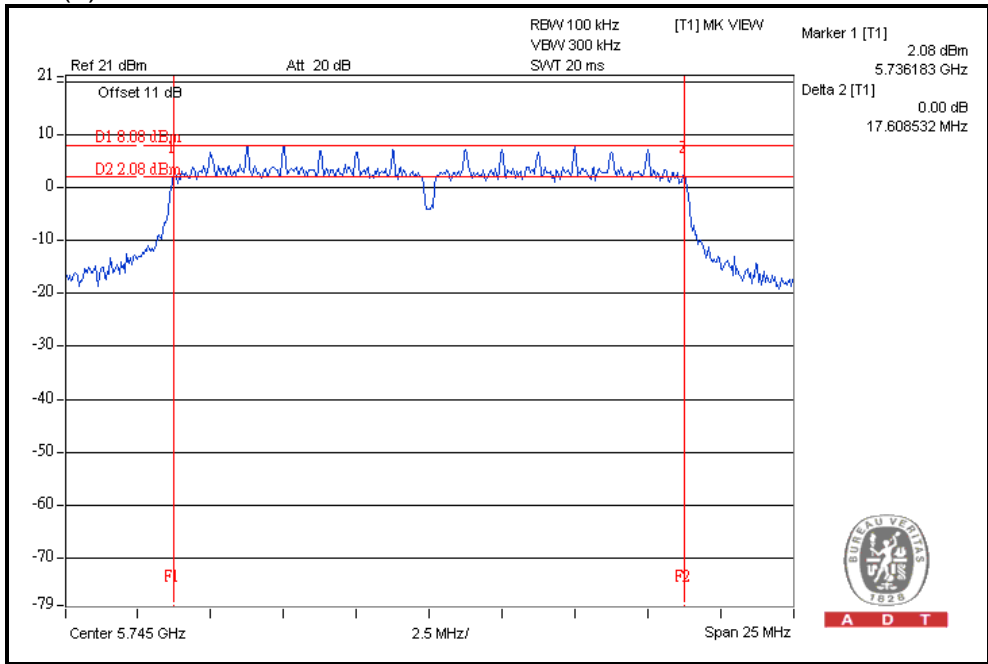



A D T

802.11n (40MHz) OFDM MODULATION:

CHANNEL	CHANNEL FREQUENCY (MHz)	6dB BANDWIDTH (MHz)		MINIMUM LIMIT (MHz)	PASS / FAIL
		CHAIN(0)	CHAIN(1)		
151	5755	36.19	36.02	0.5	PASS
159	5795	36.13	36.03	0.5	PASS

For Chain(0): CH151

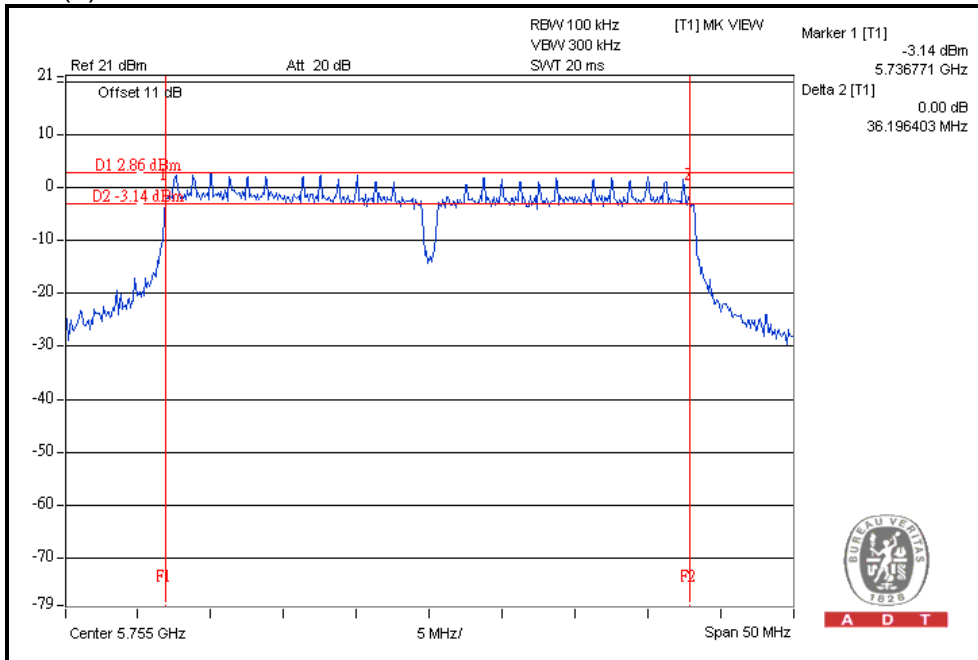

5.4 MAXIMUM PEAK OUTPUT POWER

5.4.1 LIMITS OF MAXIMUM PEAK OUTPUT POWER MEASUREMENT

The Maximum Peak Output Power Measurement is 30dBm.

5.4.2 INSTRUMENTS

Test date: July 07, 2011

DESCRIPTION & MANUFACTURER	MODEL NO.	SERIAL NO.	CALIBRATED DATE	CALIBRATED UNTIL
Peak Power Meter	ML2495A	0824006	May 04, 2011	May 03, 2012
Power Sensor	MA2411B	0738172	May 03, 2011	May 02, 2012

NOTE: The calibration interval of the above test instruments is 12 months and the calibrations are traceable to NML/ROC and NIST/USA.

5.4.3 TEST PROCEDURES

1. The transmitter output was connected to the power meter through an attenuator; the bandwidth of the fundamental frequency was measured with the power meter.
2. Record the power level.

5.4.4 DEVIATION FROM TEST STANDARD

No deviation

5.4.5 TEST SETUP

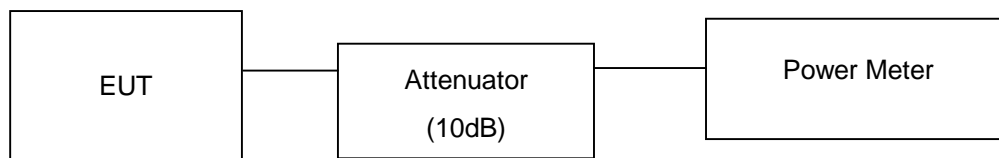

5.4.6 EUT OPERATING CONDITIONS

Same as Item 4.3.6



A D T

5.4.7 TEST RESULTS

802.11a OFDM MODULATION:

CHANNEL	CHANNEL FREQUENCY (MHz)	PEAK POWER OUTPUT (dBm)		TOTAL PEAK POWER (mW)	TOTAL PEAK POWER (dBm)	PEAK POWER LIMIT (dBm)	PASS / FAIL
		CHAIN(0)	CHAIN(1)				
149	5745	21.9	21.6	299.4	24.8	30	PASS
157	5785	21.9	21.4	292.9	24.7	30	PASS
165	5825	21.8	21.8	302.7	24.8	30	PASS

Directional gain = gain of antenna element + 10 log (# of TX antenna elements)

Effective Legacy Gain (dBi)=5

The effective legacy gain is 5dBi, therefore the limit doesn't reduce.

802.11n (20MHz) OFDM MODULATION:

CHANNEL	CHANNEL FREQUENCY (MHz)	PEAK POWER OUTPUT (dBm)		TOTAL PEAK POWER (mW)	TOTAL PEAK POWER (dBm)	PEAK POWER LIMIT (dBm)	PASS / FAIL
		CHAIN(0)	CHAIN(1)				
149	5745	21.9	21.5	296.1	24.7	30	PASS
157	5785	22.1	21.6	306.7	24.9	30	PASS
165	5825	21.6	21.1	273.4	24.4	30	PASS

802.11n (40MHz) OFDM MODULATION:

CHANNEL	CHANNEL FREQUENCY (MHz)	PEAK POWER OUTPUT (dBm)		TOTAL PEAK POWER (mW)	TOTAL PEAK POWER (dBm)	PEAK POWER LIMIT (dBm)	PASS / FAIL
		CHAIN(0)	CHAIN(1)				
151	5755	22.4	22.6	355.8	25.5	30	PASS
159	5795	22.2	22.7	352.2	25.5	30	PASS

5.5 POWER SPECTRAL DENSITY MEASUREMENT

5.5.1 LIMITS OF POWER SPECTRAL DENSITY MEASUREMENT

The Maximum of Power Spectral Density Measurement is 8dBm.

5.5.2 TEST INSTRUMENTS

Test date: July 07, 2011

DESCRIPTION & MANUFACTURER	MODEL NO.	SERIAL NO.	CALIBRATED DATE	CALIBRATED UNTIL
R&S Spectrum Analyzer	FSP40	100036	Dec. 08, 2010	Dec. 07, 2011

NOTE: The calibration interval of the above test instruments is 12 months and the calibrations are traceable to NML/ROC and NIST/USA.

5.5.3 TEST PROCEDURE

The transmitter output was connected to the spectrum analyzer through an attenuator, the bandwidth of the fundamental frequency was measured with the spectrum analyzer using 3 kHz RBW and 30 kHz VBW, set sweep time = span/3 kHz. The power spectral density was measured and recorded.

The sweep time is allowed to be longer than span/3 kHz for a full response of the mixer in the spectrum analyzer.

5.5.4 DEVIATION FROM TEST STANDARD

No deviation

5.5.5 TEST SETUP

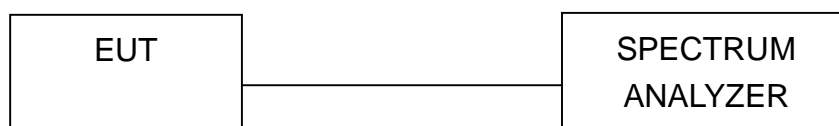

5.5.6 EUT OPERATING CONDITION

Same as Item 4.3.6



A D T

5.5.7 TEST RESULTS

802.11a OFDM MODULATION:

CHANNEL	CHANNEL FREQUENCY (MHz)	RF POWER LEVEL IN 3kHz BW (dBm)		TOTAL POWER DENSITY (dBm)	MAXIMUM LIMIT (dBm)	PASS / FAIL
		CHAIN(0)	CHAIN(1)			
149	5745	-7.8	-7.0	-4.4	8	PASS
157	5785	-7.1	-6.5	-3.8	8	PASS
165	5825	-7.9	-8.0	-4.9	8	PASS

For Chain(1): CH157

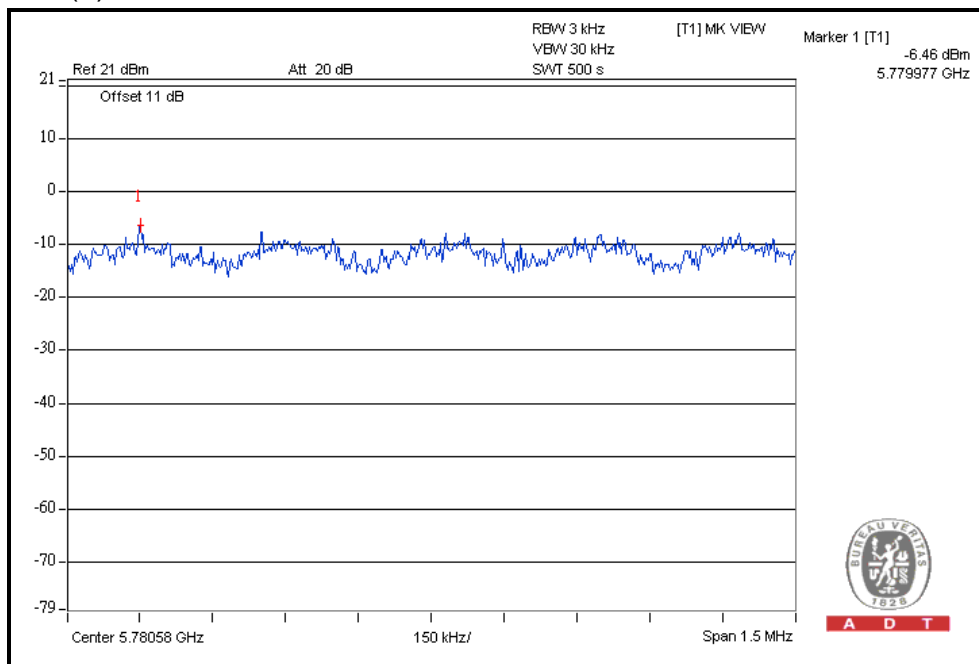



A D T

802.11n (20MHz) OFDM MODULATION:

CHANNEL	CHANNEL FREQUENCY (MHz)	RF POWER LEVEL IN 3kHz BW (dBm)		TOTAL POWER DENSITY (dBm)	MAXIMUM LIMIT (dBm)	PASS / FAIL
		CHAIN(0)	CHAIN(1)			
149	5745	-6.2	-7.4	-3.7	8	PASS
157	5785	-8.1	-7.9	-5.0	8	PASS
165	5825	-8.3	-8.3	-5.3	8	PASS

For Chain(0): CH149

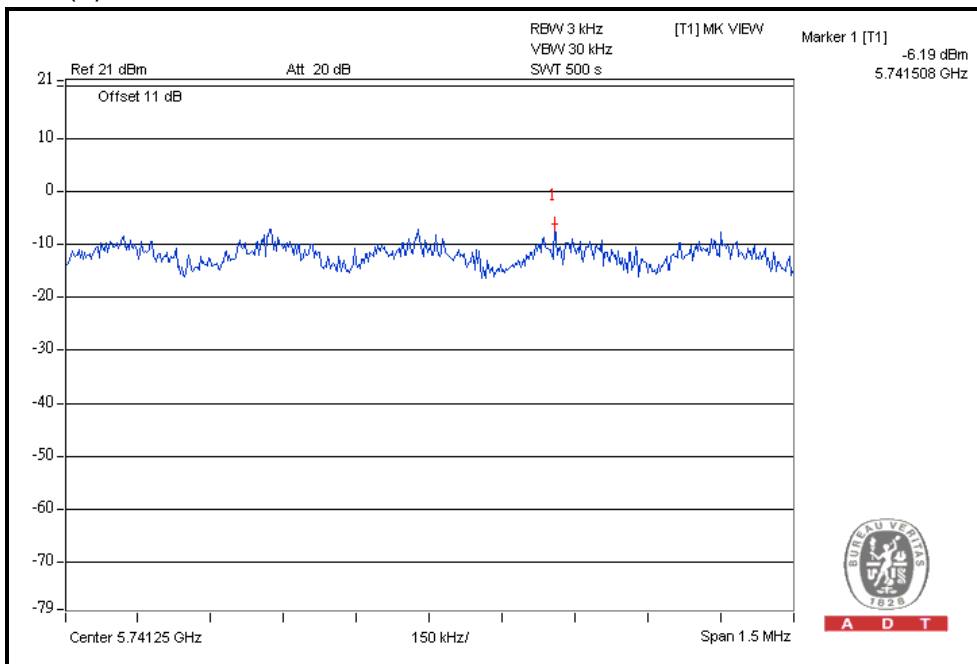



A D T

802.11n (40MHz) OFDM MODULATION:

CHANNEL	CHANNEL FREQUENCY (MHz)	RF POWER LEVEL IN 3kHz BW (dBm)		TOTAL POWER DENSITY (dBm)	MAXIMUM LIMIT (dBm)	PASS / FAIL
		CHAIN(0)	CHAIN(1)			
151	5755	-12.4	-11.9	-9.1	8	PASS
159	5795	-11.3	-10.6	-7.9	8	PASS

For Chain(1): CH159

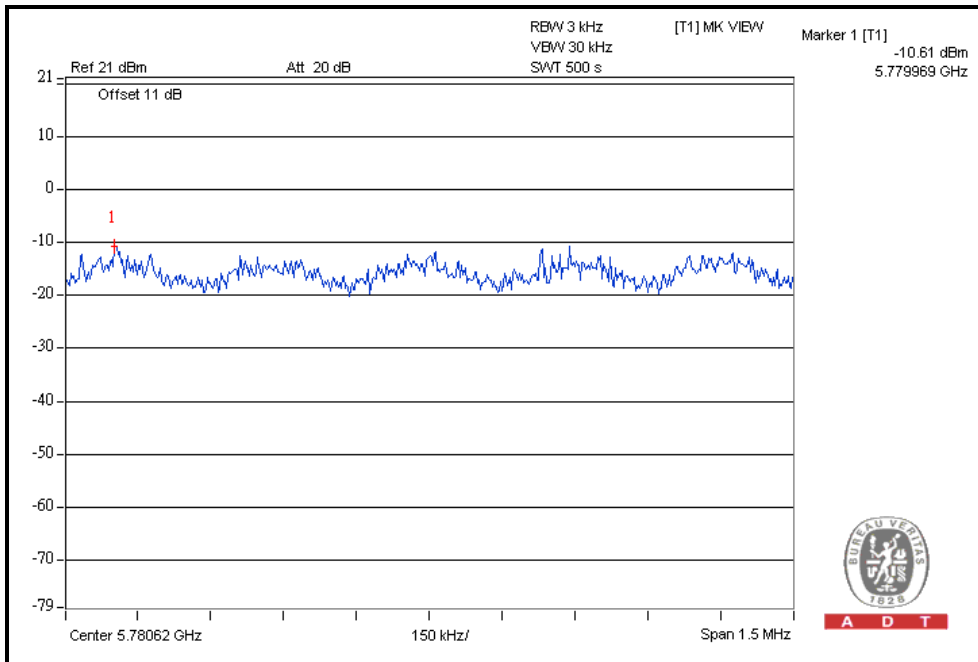

A D T

5.6 CONDUCTED OUT-BAND EMISSION MEASUREMENT

5.6.1 LIMITS OF CONDUCTED OUT-BAND EMISSION MEASUREMENT

Below -20dB of the highest emission level of operating band (in 100kHz Resolution Bandwidth).

5.6.2 TEST INSTRUMENTS

Test date: July 07, 2011

DESCRIPTION & MANUFACTURER	MODEL NO.	SERIAL NO.	CALIBRATED DATE	CALIBRATED UNTIL
R&S Spectrum Analyzer	FSP40	100036	Dec. 08, 2010	Dec. 07, 2011

NOTE: The calibration interval of the above test instruments is 12 months and the calibrations are traceable to NML/ROC and NIST/USA.

5.6.3 TEST PROCEDURE

The transmitter output was connected to the spectrum analyzer via a low loss cable. Set RBW of spectrum analyzer to 100 kHz with suitable frequency span including 100MHz or 200MHz bandwidth from band edge. The band edges was measured and recorded.

5.6.4 DEVIATION FROM TEST STANDARD

No deviation

5.6.5 EUT OPERATING CONDITION

Same as Item 4.3.6

5.6.6 TEST RESULTS

The spectrum plots are attached on the following pages. D2 line indicates the highest level, D1 line indicates the 20dB offset below D2. It shows compliance with the requirement in part 15.247(d).



A D T

802.11a OFDM modulation

For Chain(0) : CH149

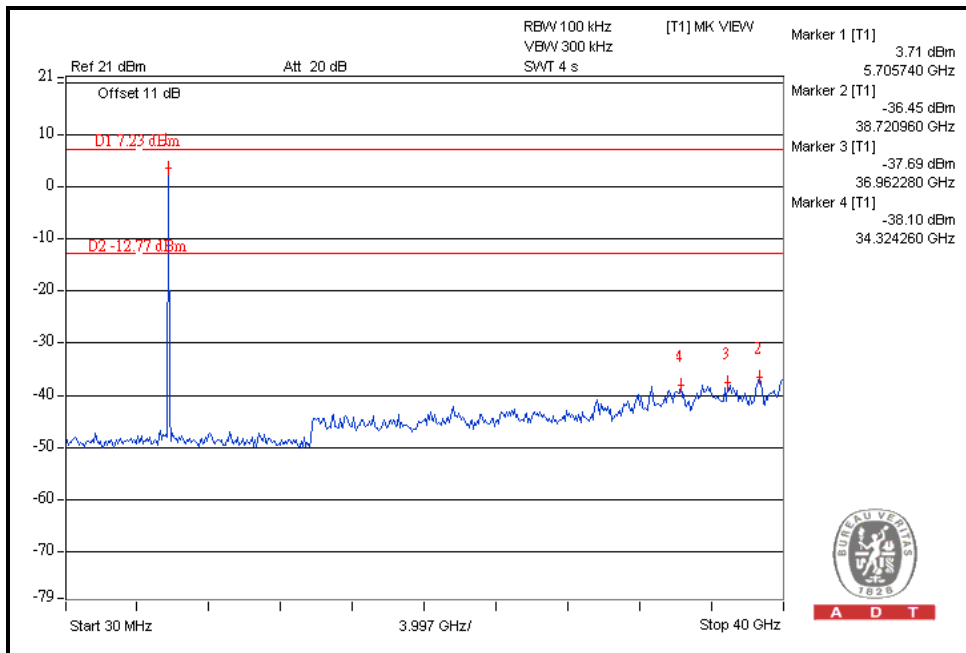
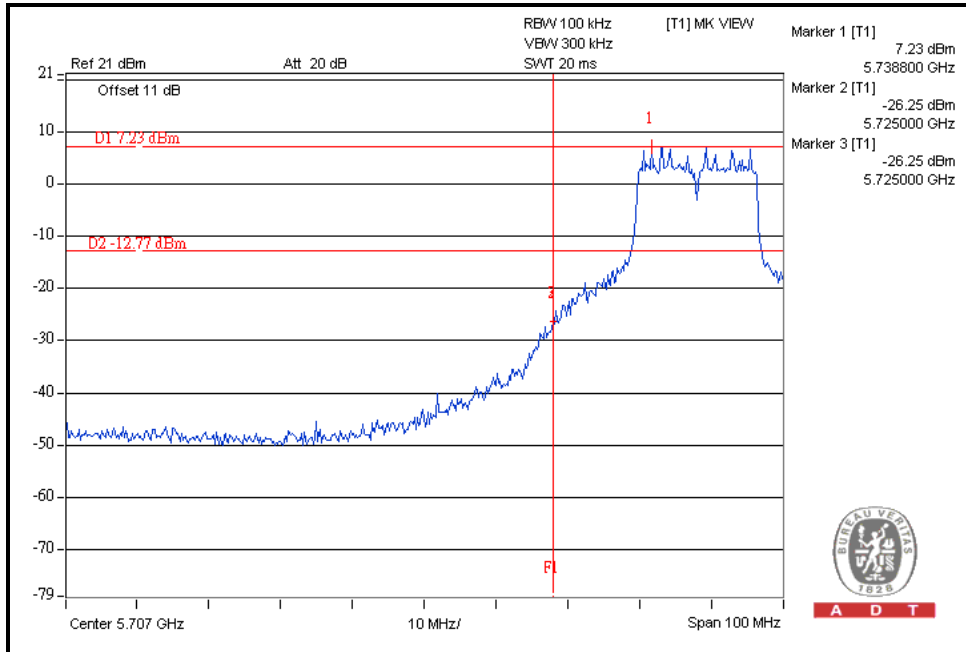



A D T

For Chain(0) : CH165

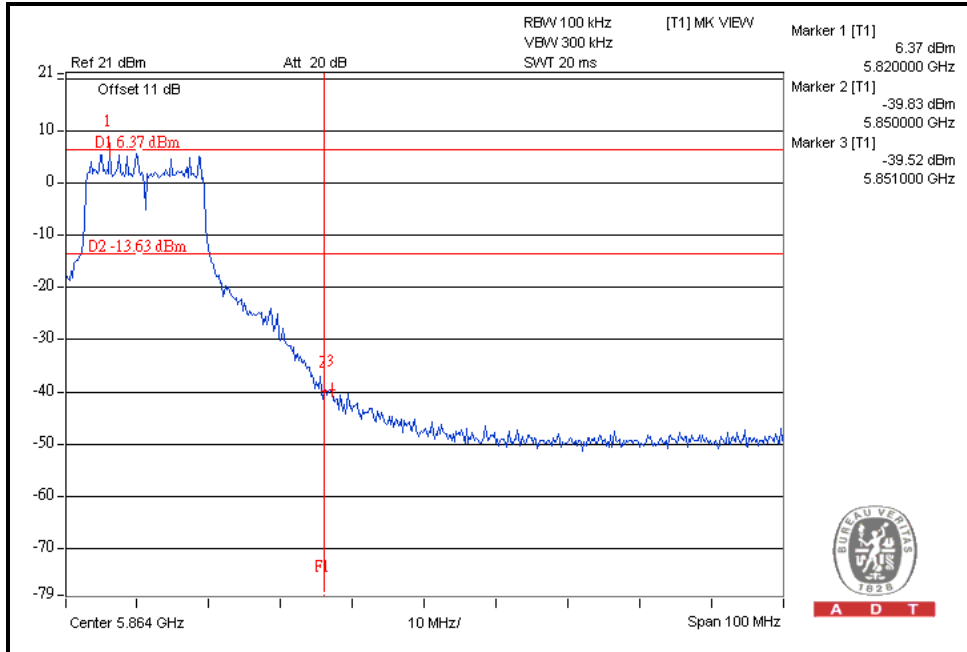

A D T

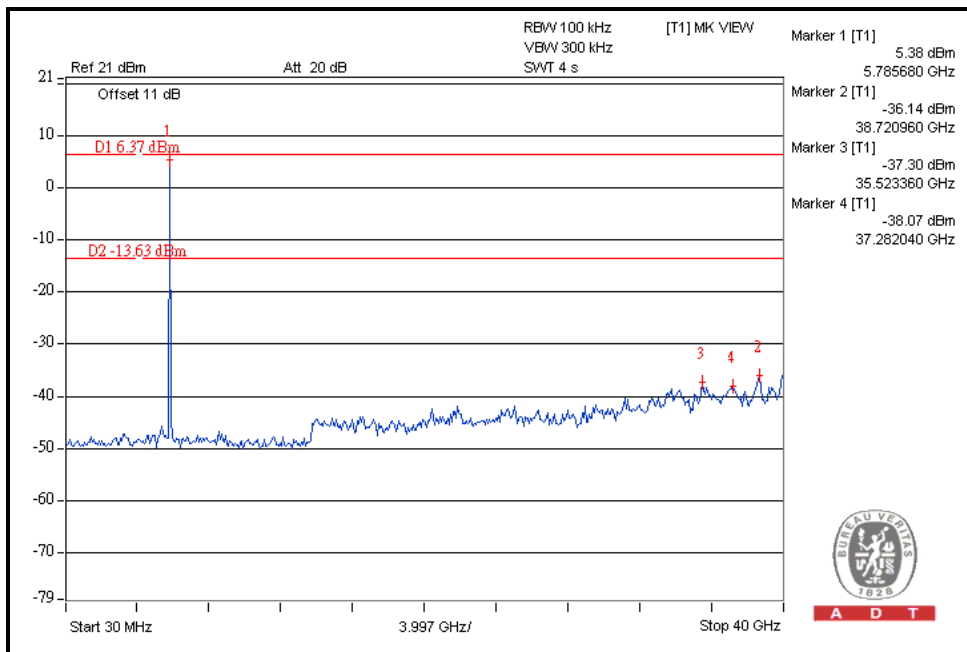

A D T



A D T

For Chain(1) : CH149

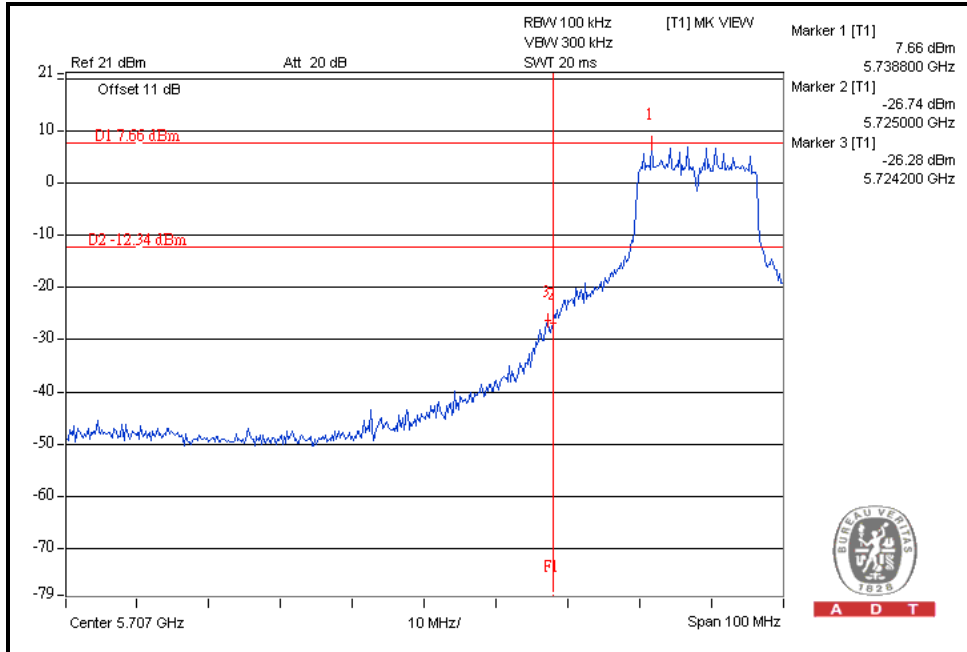

A D T

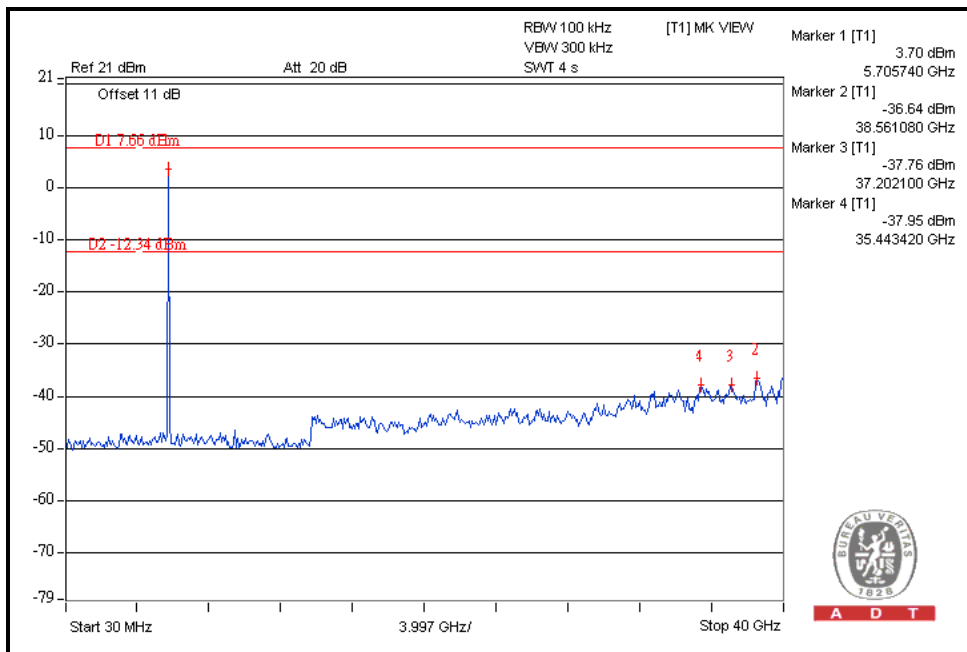

A D T



A D T

For Chain(1) : CH165

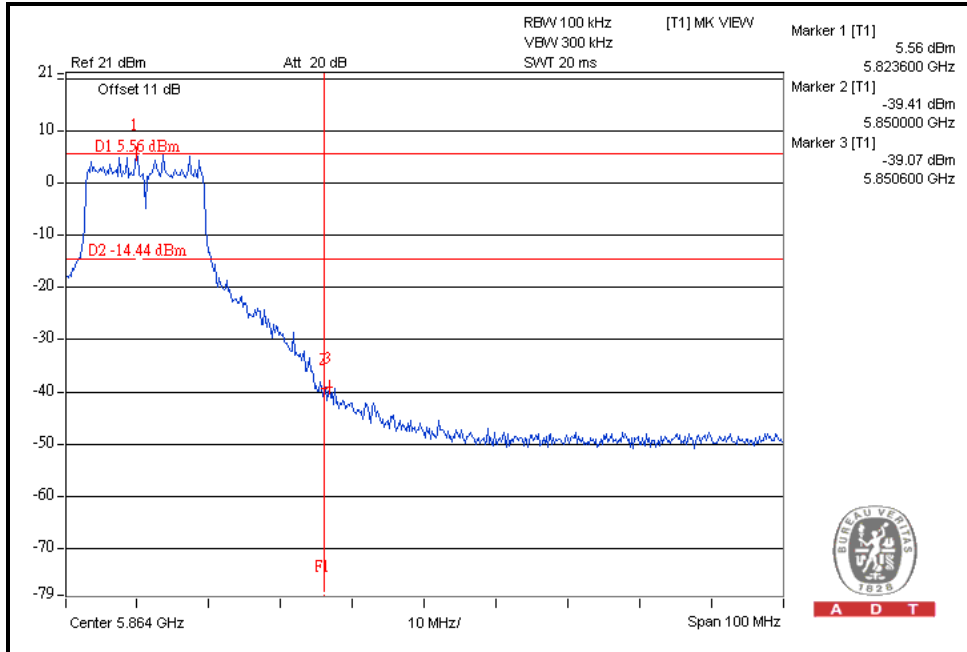

A D T

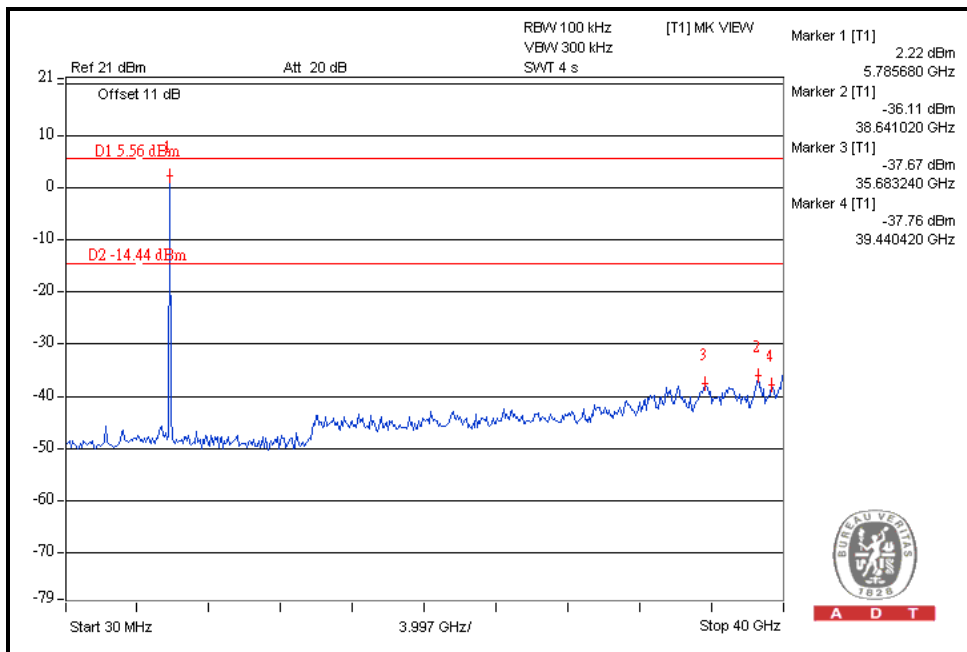

A D T



A D T

802.11n (20MHz) OFDM MODULATION:

For Chain(0) : CH149

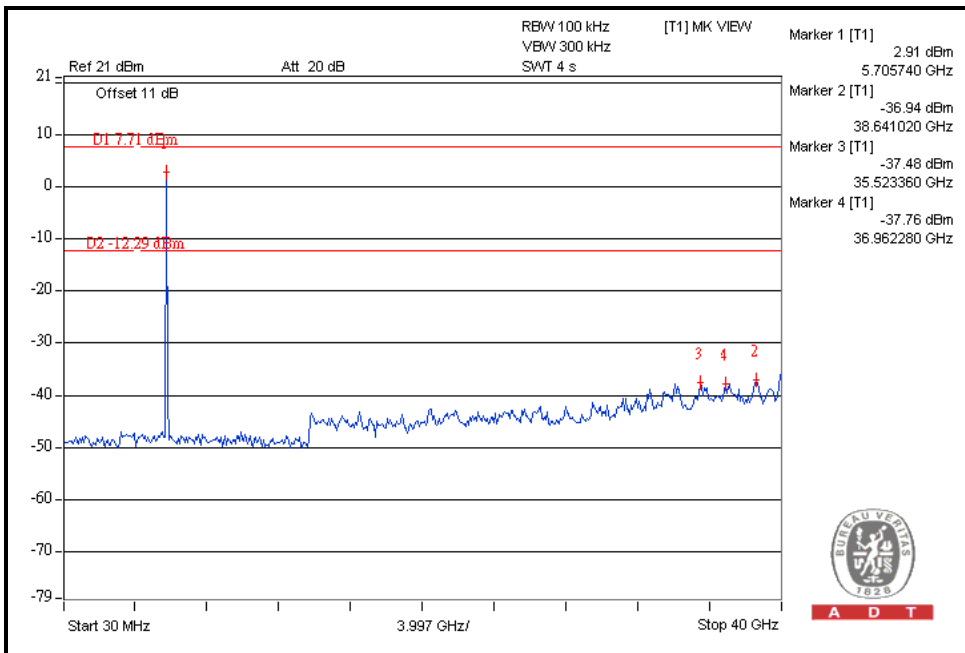
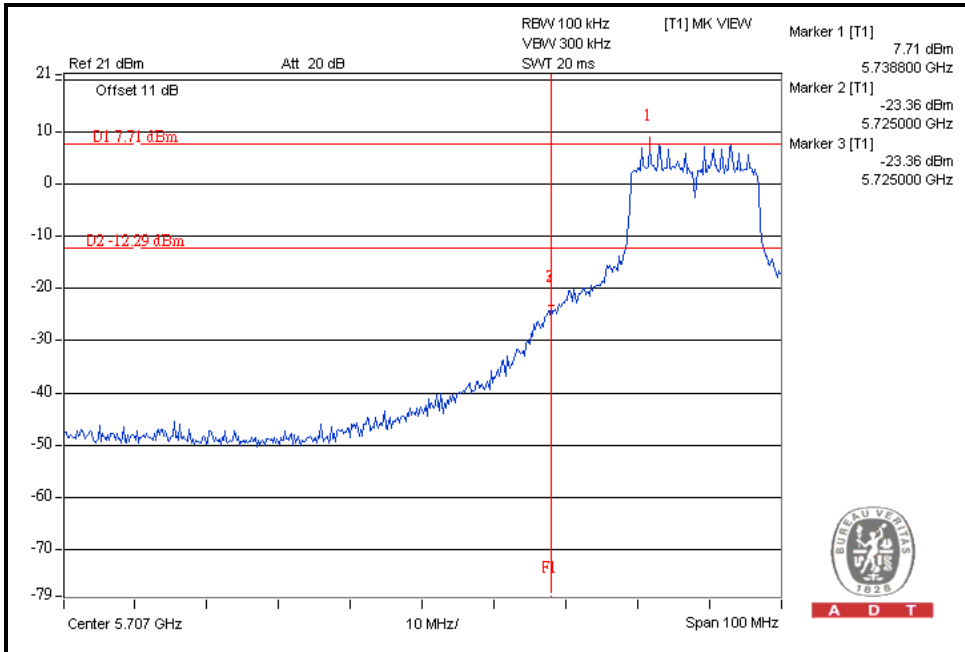



A D T

For Chain(0) : CH165

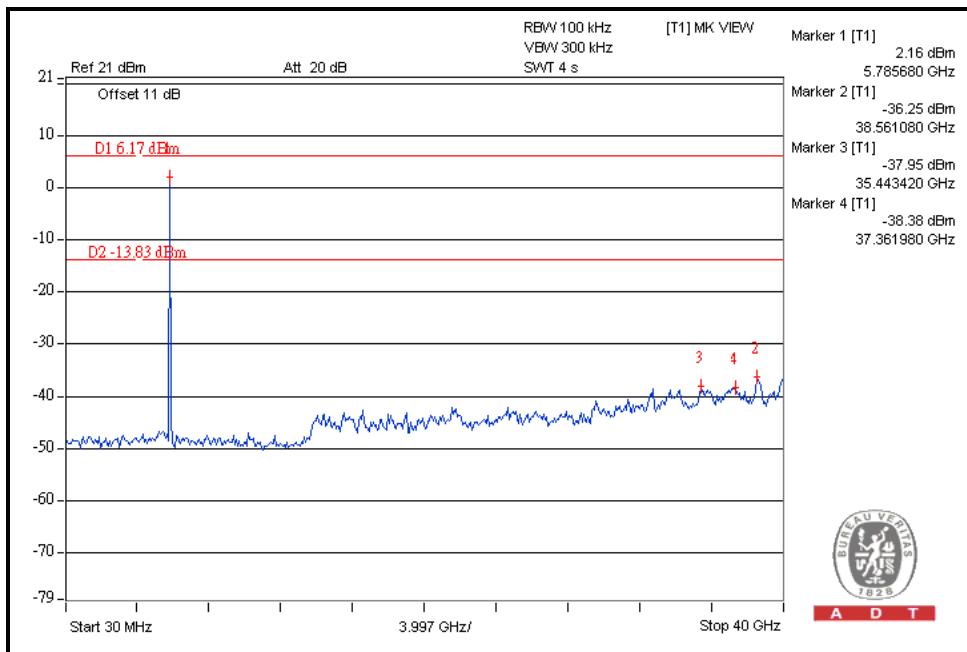
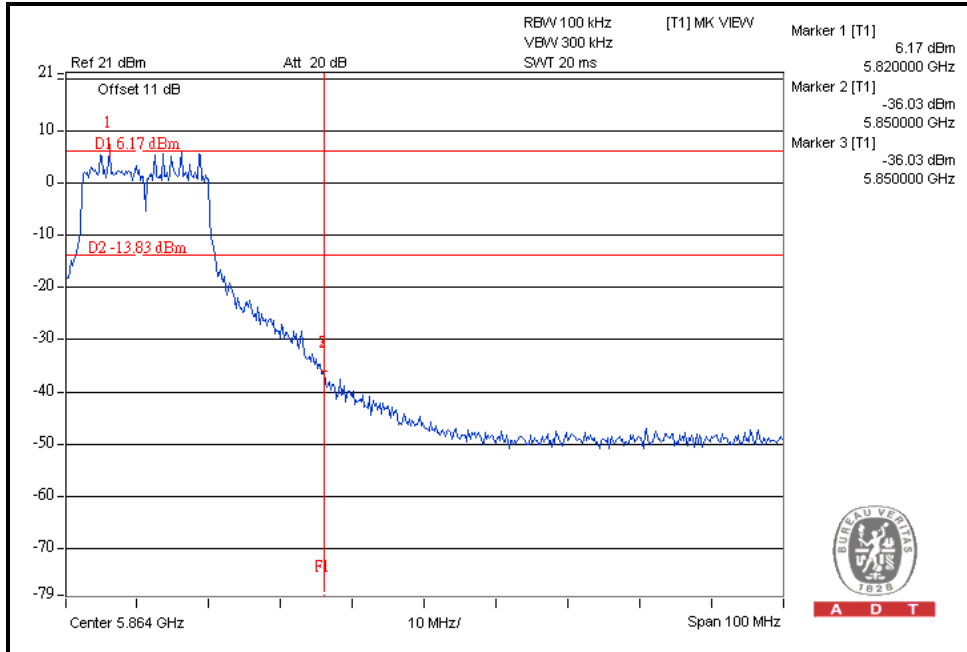



A D T

For Chain(1) : CH149

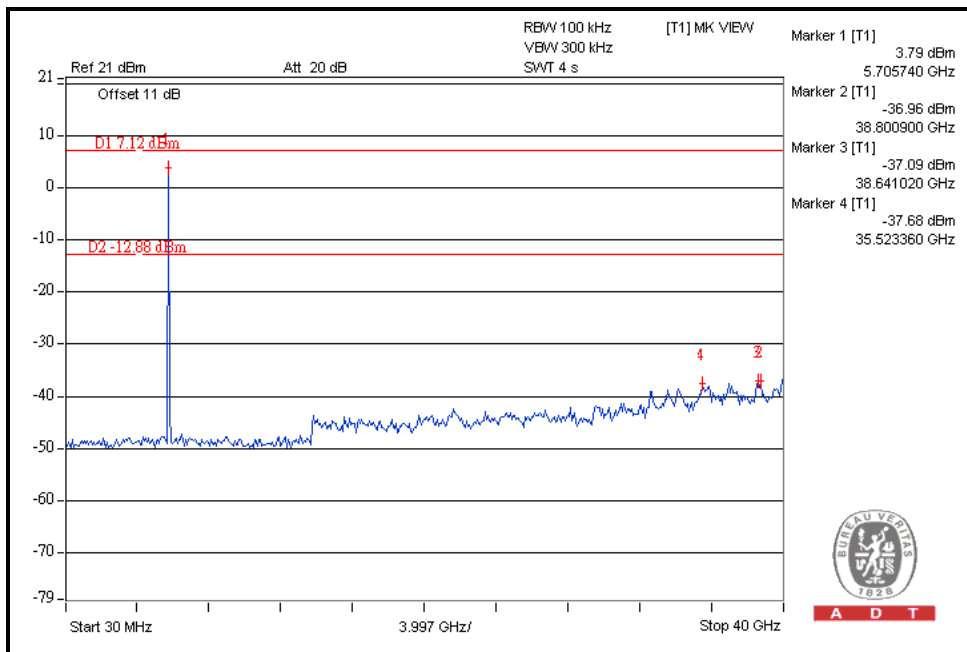
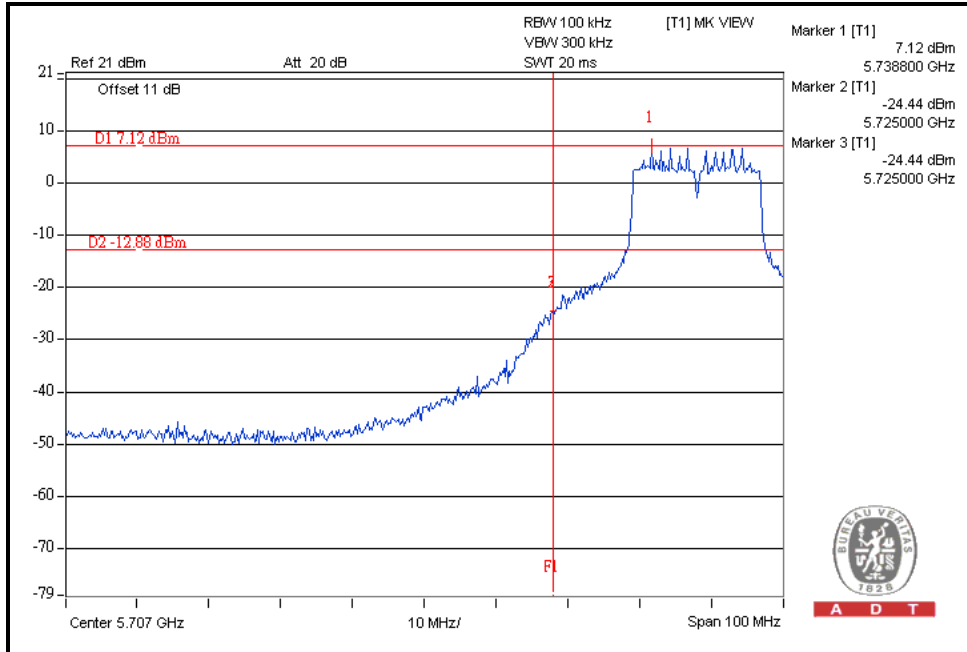



A D T

For Chain(1) : CH165

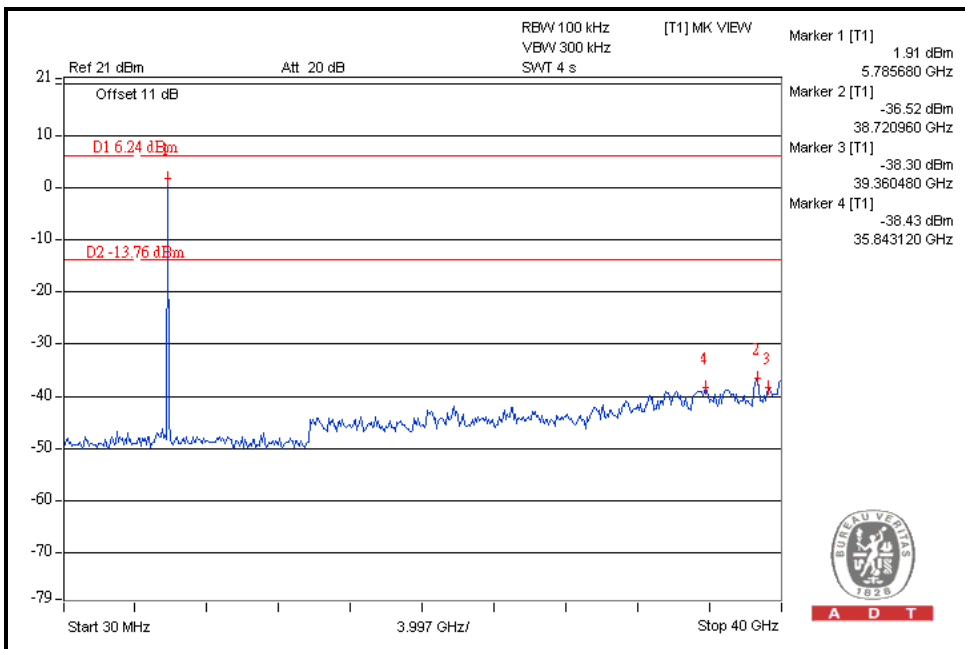
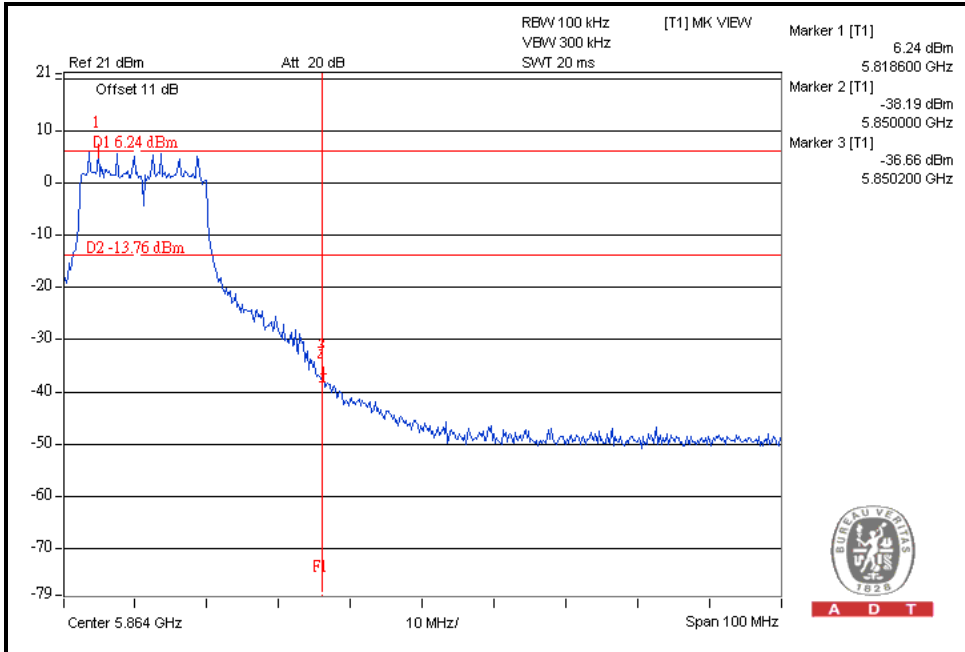

802.11n (40MHz) OFDM MODULATION:

For Chain(0) : CH151

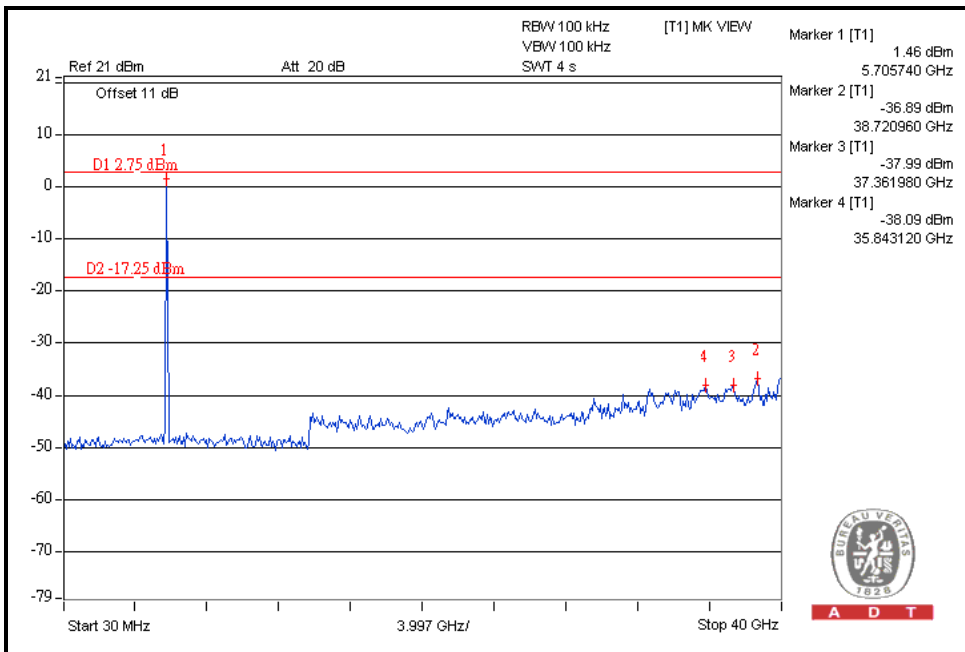
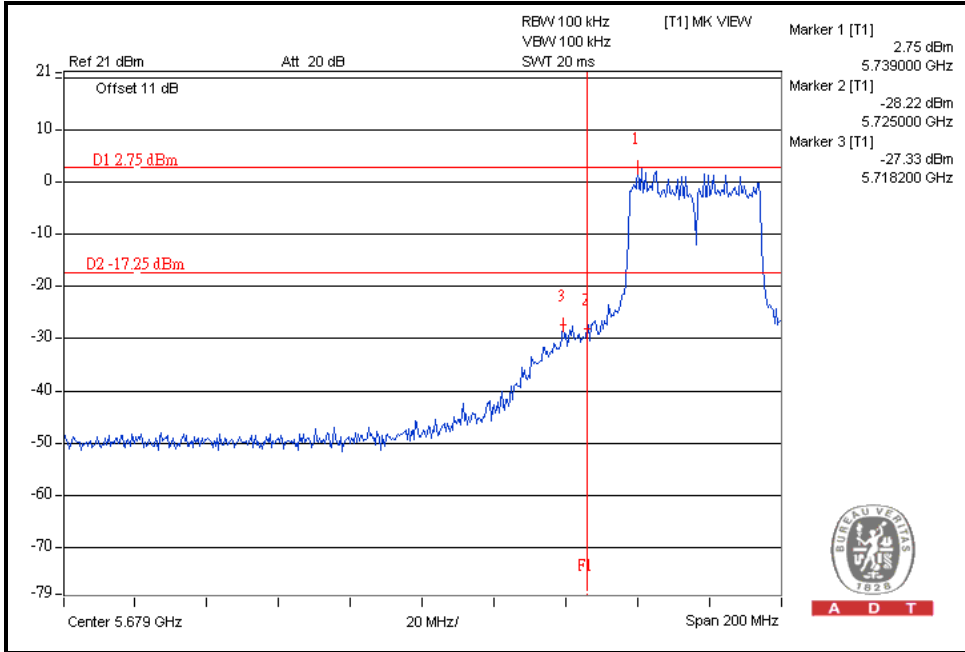



A D T

For Chain(0) : CH159

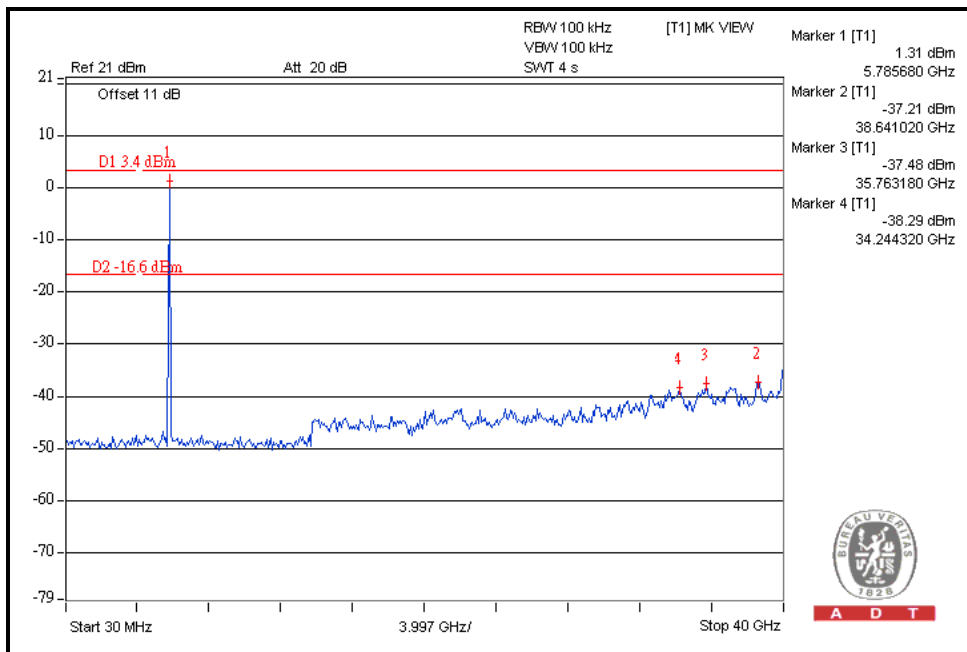
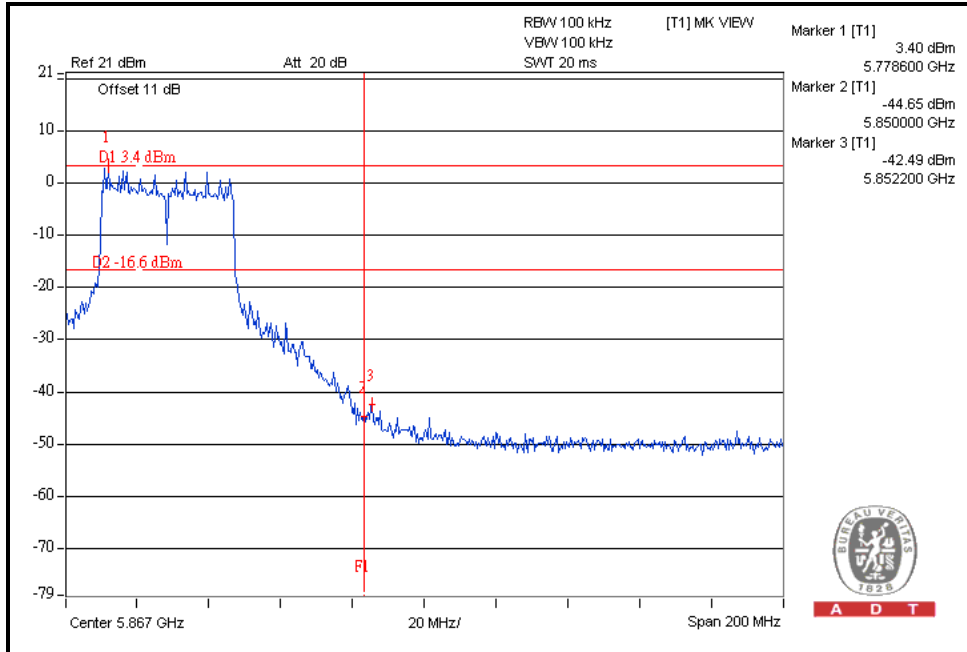



A D T

For Chain(1) : CH151

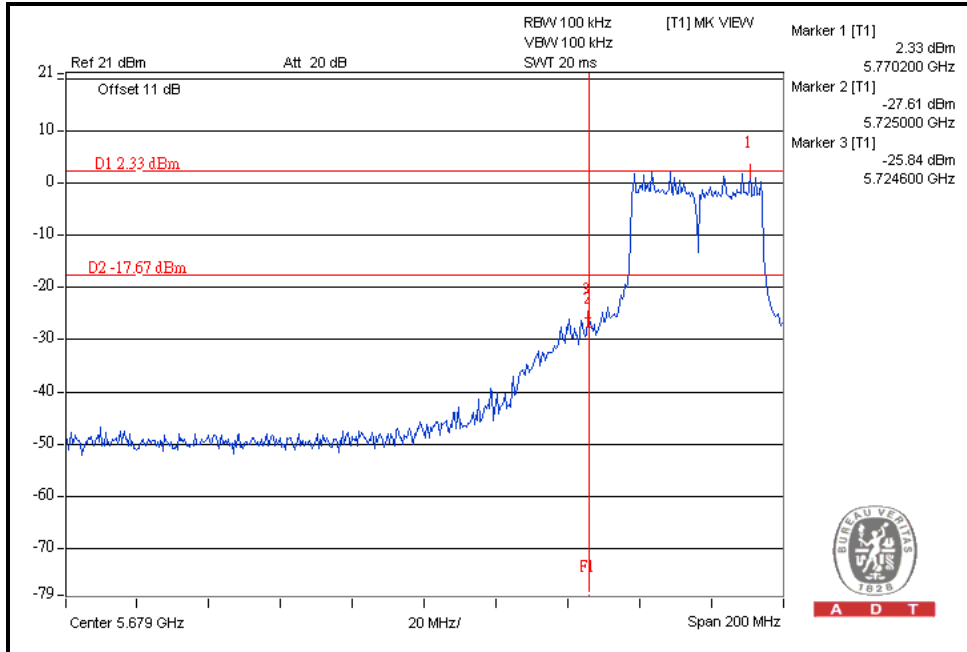

A D T

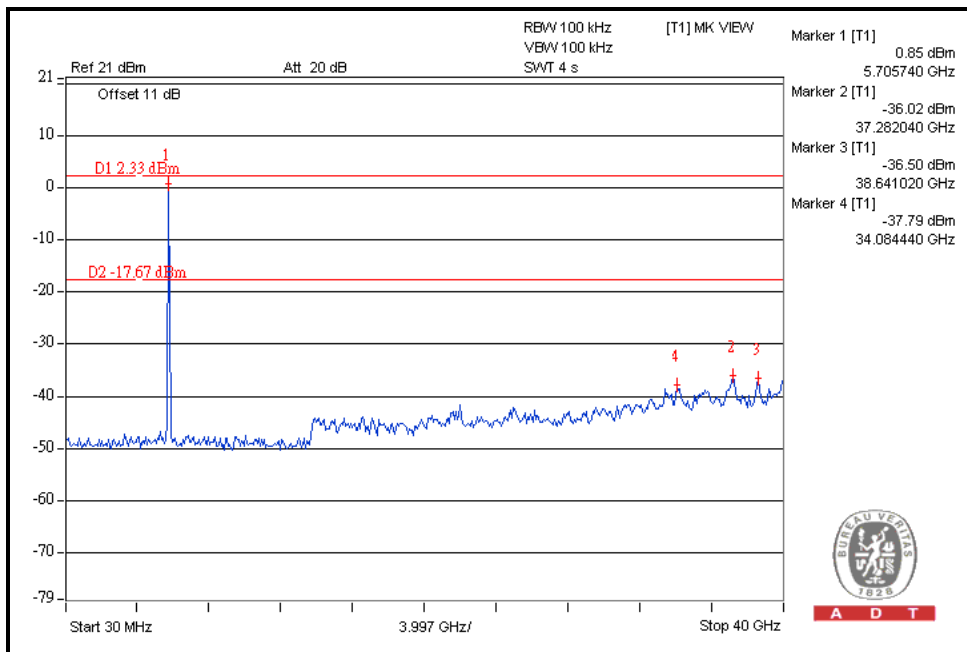

A D T



A D T

For Chain(1) : CH159

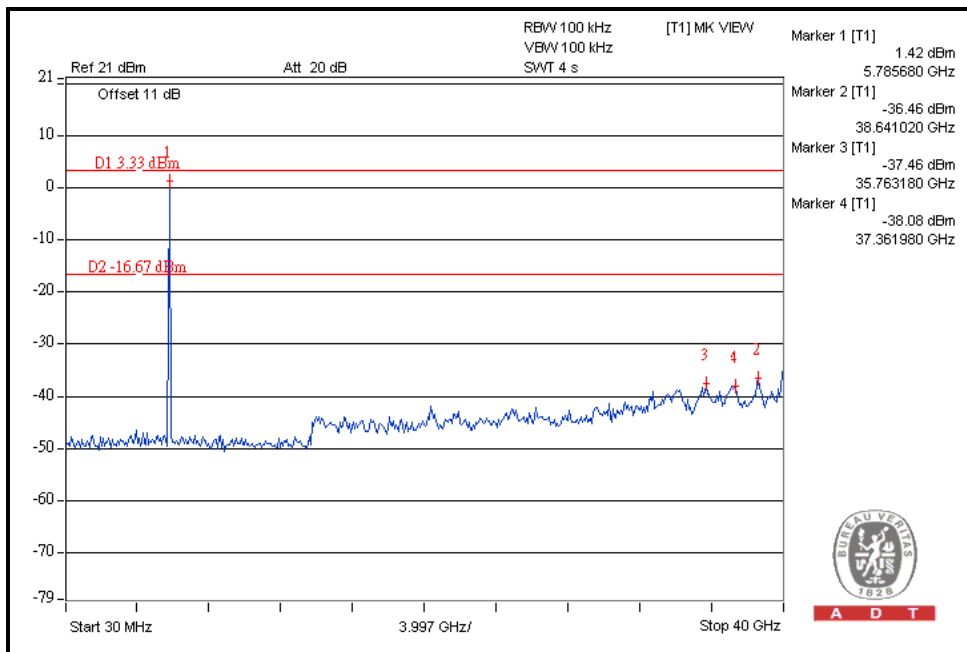
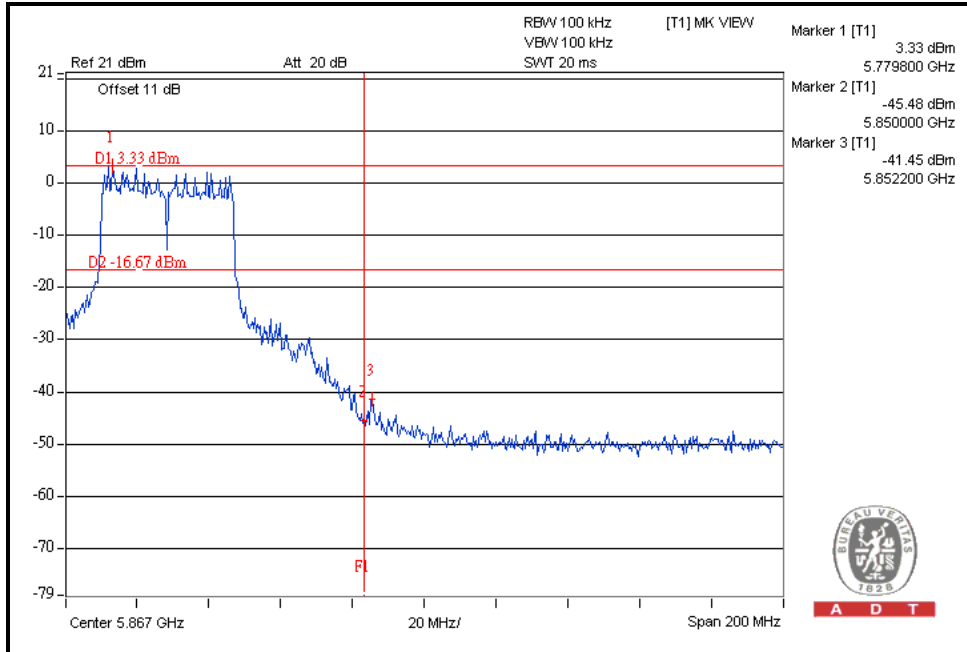



6. INFORMATION ON THE TESTING LABORATORIES

We, Bureau Veritas Consumer Products Services (H.K.) Ltd., Taoyuan Branch, were founded in 1988 to provide our best service in EMC, Radio, Telecom and Safety consultation. Our laboratories are accredited and approved according to ISO/IEC 17025.

Copies of accreditation certificates of our laboratories obtained from approval agencies can be downloaded from our web site: www.adt.com.tw/index.5.phtml. If you have any comments, please feel free to contact us at the following:

Linko EMC/RF Lab:

Tel: 886-2-26052180

Fax: 886-2-26052943

Hsin Chu EMC/RF Lab:

Tel: 886-3-5935343

Fax: 886-3-5935342

Hwa Ya EMC/RF/Safety/Telecom Lab:

Tel: 886-3-3183232

Fax: 886-3-3185050

Email: service.adt@tw.bureauveritas.com

Web Site: www.adt.com.tw

The address and road map of all our labs can be found in our web site also.



A D T

7.APPENDIX A - MODIFICATIONS RECORDERS FOR ENGINEERING CHANGES TO THE EUT BY THE LAB

No any modifications are made to the EUT by the lab during the test.

--- END ---