



FCC TEST REPORT

REPORT NO.: RF971016L12

MODEL NO.: DWA-552 (Refer to item 3.1 for more details)

RECEIVED: Oct. 16, 2008

TESTED: Oct. 20 ~ Nov. 25, 2008

ISSUED: Dec. 01, 2008

APPLICANT: D-Link Corporation

ADDRESS: 17595 Mt. Herrmann, Fountain Valley, CA
92708, U.S.A.

ISSUED BY: Bureau Veritas Consumer Products Services
(H.K.) Ltd., Taoyuan Branch

LAB ADDRESS: No. 47, 14th Ling, Chia Pau Tsuen, Lin Kou
Hsiang, Taipei Hsien 244, Taiwan, R.O.C.

TEST LOCATION: No. 19, Hwa Ya 2nd Rd, Wen Hwa Tsuen, Kwei
Shan Hsiang, Taoyuan Hsien 333, Taiwan,
R.O.C.

This test report consists of 97 pages in total. It may be duplicated completely for legal use with the approval of the applicant. It should not be reproduced except in full, without the written approval of our laboratory. The client should not use it to claim product endorsement by TAF or any government agencies. The test results in the report only apply to the tested sample.



TABLE OF CONTENTS

1.	CERTIFICATION.....	4
2.	SUMMARY OF TEST RESULTS	5
2.1	MEASUREMENT UNCERTAINTY.....	5
3.	GENERAL INFORMATION.....	6
3.1	GENERAL DESCRIPTION OF EUT	6
3.2	DESCRIPTION OF TEST MODES	7
3.2.1	CONFIGURATION OF SYSTEM UNDER TEST	7
3.2.2	TEST MODE APPLICABILITY AND TESTED CHANNEL DETAIL	8
3.3	GENERAL DESCRIPTION OF APPLIED STANDARDS	10
3.4	DESCRIPTION OF SUPPORT UNITS	10
4.	TEST TYPES AND RESULTS	11
4.1	RADIATED EMISSION MEASUREMENT	11
4.1.1	LIMITS OF RADIATED EMISSION MEASUREMENT	11
4.1.2	TEST INSTRUMENTS.....	12
4.1.3	TEST PROCEDURES	13
4.1.4	DEVIATION FROM TEST STANDARD.....	13
4.1.5	TEST SETUP.....	14
4.1.6	EUT OPERATING CONDITIONS	14
4.1.7	TEST RESULTS	15
4.2	CONDUCTED EMISSION MEASUREMENT	31
4.2.1	LIMITS OF CONDUCTED EMISSION MEASUREMENT	31
4.2.2	TEST INSTRUMENTS.....	31
4.2.3	TEST PROCEDURES	32
4.2.4	DEVIATION FROM TEST STANDARD.....	32
4.2.5	TEST SETUP.....	33
4.2.6	EUT OPERATING CONDITIONS	33
4.2.7	TEST RESULTS	34
4.3	6DB BANDWIDTH MEASUREMENT	36
4.3.1	LIMITS OF 6DB BANDWIDTH MEASUREMENT	36
4.3.2	TEST INSTRUMENTS.....	36
4.3.3	TEST PROCEDURE.....	36
4.3.4	DEVIATION FROM TEST STANDARD.....	36
4.3.5	TEST SETUP.....	37
4.3.6	EUT OPERATING CONDITIONS	37
4.3.7	TEST RESULTS	38
4.4	MAXIMUM PEAK OUTPUT POWER.....	54

4.4.1	LIMITS OF MAXIMUM PEAK OUTPUT POWER MEASUREMENT	54
4.4.2	TEST INSTRUMENTS.....	54
4.4.3	TEST PROCEDURES	54
4.4.3	DEVIATION FROM TEST STANDARD.....	55
4.4.4	TEST SETUP	55
4.4.5	EUT OPERATING CONDITIONS	55
4.4.6	TEST RESULTS	56
4.5	POWER SPECTRAL DENSITY MEASUREMENT	58
4.5.1	LIMITS OF POWER SPECTRAL DENSITY MEASUREMENT	58
4.5.2	TEST INSTRUMENTS.....	58
4.5.3	TEST PROCEDURE.....	58
4.5.4	DEVIATION FROM TEST STANDARD.....	59
4.5.5	TEST SETUP.....	59
4.5.6	EUT OPERATING CONDITION.....	59
4.5.7	TEST RESULTS	60
4.6	BAND EDGES MEASUREMENT	76
4.6.1	LIMITS OF BAND EDGES MEASUREMENT	76
4.6.2	TEST INSTRUMENTS.....	76
4.6.3	TEST PROCEDURE.....	77
4.6.4	DEVIATION FROM TEST STANDARD.....	77
4.6.5	EUT OPERATING CONDITION.....	77
4.6.6	TEST RESULTS	78
4.7	ANTENNA REQUIREMENT	94
4.7.1	STANDARD APPLICABLE	94
4.7.2	ANTENNA CONNECTED CONSTRUCTION	94
5.	PHOTOGRAPHS OF THE TEST CONFIGURATION	95
6.	INFORMATION ON THE TESTING LABORATORIES	96
7.	APPENDIX A - MODIFICATIONS RECORDERS FOR ENGINEERING CHANGES TO THE EUT BY THE LAB	97



1. CERTIFICATION

PRODUCT: D-Link DWA-552 Xtreme N™ Desktop Adapter

MODEL: DWA-552 (Refer to item 3.1 for more details)

BRAND: D-Link

APPLICANT: D-Link Corporation

TEST SAMPLE: ENGINEERING SAMPLE

TESTED: Oct. 20 ~ Nov. 25, 2008

STANDARDS: **FCC Part 15, Subpart C (Section 15.247)**

ANSI C63.4-2003

The above equipment (Model: DWA-552) has been tested by **Bureau Veritas Consumer Products Services (H.K.) Ltd., Taoyuan Branch**, and found compliance with the requirement of the above standards. The test record, data evaluation & Equipment Under Test (EUT) configurations represented herein are true and accurate accounts of the measurements of the sample's EMC characteristics under the conditions specified in this report.

PREPARED BY : Ivy Lin , **DATE:** Dec. 01, 2008
Ivy Lin / Specialist

TECHNICAL ACCEPTANCE : Long Chen , **DATE:** Dec. 01, 2008
Responsible for RF Long Chen / Senior Engineer

APPROVED BY : Gary Chang , **DATE:** Dec. 01, 2008
Gary Chang / Assistant Manager

2. SUMMARY OF TEST RESULTS

The EUT has been tested according to the following specifications:

APPLIED STANDARD: FCC PART 15, SUBPART C (SECTION 15.247)			
STANDARD SECTION	TEST TYPE AND LIMIT	RESULT	REMARK
15.207	AC Power Conducted Emission	PASS	Meet the requirement of limit. Minimum passing margin is -3.52dB at 19.814MHz.
15.247(a)(2)	Spectrum Bandwidth of a Direct Sequence Spread Spectrum System Limit: min. 500kHz	PASS	Meet the requirement of limit.
15.247(b)	Maximum Peak Output Power Limit: max. 30dBm	PASS	Meet the requirement of limit.
15.247(d)	Radiated Emissions Limit: Table 15.209	PASS	Meet the requirement of limit. Minimum passing margin is -1.25dB at 2483.50MHz.
15.247(e)	Power Spectral Density Limit: max. 8dBm	PASS	Meet the requirement of limit.
15.247(d)	Band Edge Measurement Limit: 20dB less than the peak value of fundamental frequency	PASS	Meet the requirement of limit.

2.1 MEASUREMENT UNCERTAINTY

Where relevant, the following measurement uncertainty levels have been estimated for tests performed on the EUT as specified in CISPR 16-4-2:

MEASUREMENT	FREQUENCY	UNCERTAINTY
Conducted emissions	9kHz ~ 30MHz	2.44dB
Radiated emissions	30MHz ~ 200MHz	3.34 dB
	200MHz ~1000MHz	3.35 dB
	1GHz ~ 18GHz	2.26 dB
	18GHz ~ 40GHz	1.94 dB

This uncertainty represents an expanded uncertainty expressed at approximately the 95% confidence level using a coverage factor of $k = 2$.

3. GENERAL INFORMATION

3.1 GENERAL DESCRIPTION OF EUT

EUT	D-Link DWA-552 Xtreme N™ Desktop Adapter
MODEL NO.	DWA-552 (Refer to note for more details)
FCC ID	KA2WA552A2
POWER SUPPLY	5Vdc from host equipment
MODULATION TYPE	CCK, DQPSK, DBPSK for DSSS 64QAM, 16QAM, QPSK, BPSK for OFDM
MODULATION TECHNOLOGY	DSSS, OFDM
TRANSFER RATE	802.11b:11.0/ 5.5/ 2.0/ 1.0Mbps 802.11g: 54.0/ 48.0/ 36.0/ 24.0/ 18.0/ 12.0/ 9.0/ 6.0Mbps Draft 802.11n: up to 300.0Mbps
FREQUENCY RANGE	2400.0 ~ 2483.5MHz
NUMBER OF CHANNEL	11 for 802.11b, 802.11g, draft 802.11n (20MHz) 7 for draft 802.11n (40MHz)
OUTPUT POWER	639.789mW
ANTENNA TYPE	Dipole antenna with 2.0dBi gain
DATA CABLE	NA
I/O PORTS	NA
ACCESSORY DEVICES	NA

NOTE:

1. The EUT incorporates a MIMO function. Physically, the EUT provides two completed transmitters and three receivers.

MODULATION MODE	TX FUNCTION
802.11b	2TX
802.11g	2TX
Draft 802.11n (20MHz)	2TX
Draft 802.11n (40MHz)	2TX

2. The models as below are identical to each other, except for their model designation due to marketing area differentiation.

Brand Name	Model No.	Difference
D-Link	DWA-552	marketing area differentiation
	DWA-547	

3. The above EUT information was declared by manufacturer and for more detailed features description, please refer to the manufacturer's specifications or user's manual.

3.2 DESCRIPTION OF TEST MODES

11 channels are provided for 802.11b, 802.11g and draft 802.11n (20MHz):

CHANNEL	FREQUENCY	CHANNEL	FREQUENCY
1	2412MHz	7	2442MHz
2	2417MHz	8	2447MHz
3	2422MHz	9	2452MHz
4	2427MHz	10	2457MHz
5	2432MHz	11	2462MHz
6	2437MHz		

7 channels are provided for draft 802.11n (40MHz):

CHANNEL	FREQUENCY	CHANNEL	FREQUENCY
1	2422MHz	5	2442MHz
2	2427MHz	6	2447MHz
3	2432MHz	7	2452MHz
4	2437MHz		

3.2.1 CONFIGURATION OF SYSTEM UNDER TEST

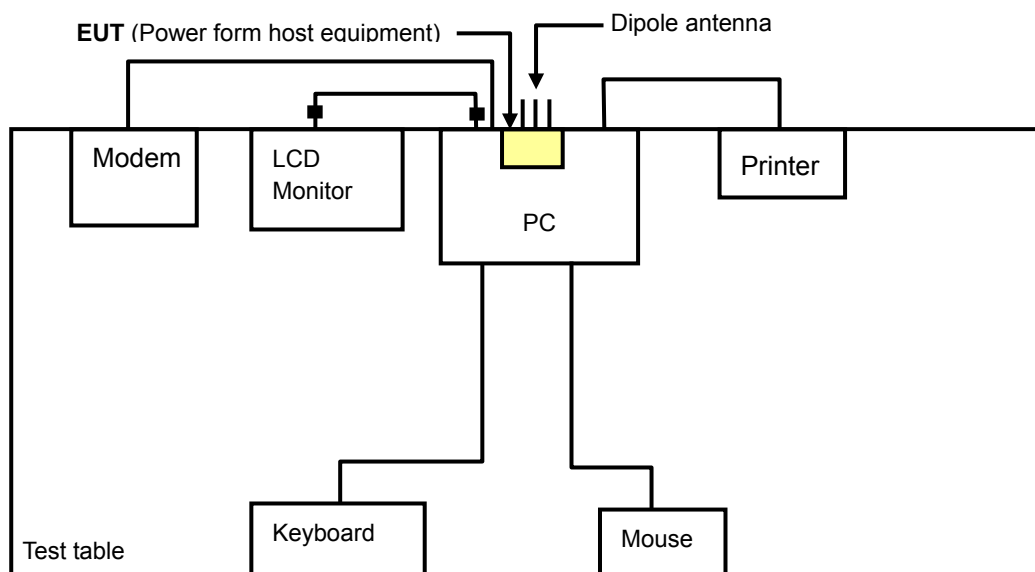

3.2.2 TEST MODE APPLICABILITY AND TESTED CHANNEL DETAIL

EUT CONFIGURE MODE	APPLICABLE TO				DESCRIPTION
	RE \geq 1G	RE<1G	PLC	APCM	
-	√	√	√	√	-

Where **RE \geq 1G**: Radiated Emission above 1GHz **RE<1G**: Radiated Emission below 1GHz
PLC: Power Line Conducted Emission **APCM**: Antenna Port Conducted Measurement

RADIATED EMISSION TEST (ABOVE 1GHz):

- Pre-Scan has been conducted to determine the worst-case mode from all possible combinations between available modulations, data rates and antenna ports (if EUT with antenna diversity architecture).
- Following channel(s) was (were) selected for the final test as listed below.

MODE	AVAILABLE CHANNEL	TESTED CHANNEL	MODULATION TECHNOLOGY	MODULATION TYPE	DATA RATE (Mbps)
802.11b	1 to 11	1, 6, 11	DSSS	DBPSK	1.0
802.11g	1 to 11	1, 6, 11	OFDM	BPSK	6.0
Draft 802.11n (20MHz)	1 to 11	1, 6, 11	OFDM	BPSK	7.2
Draft 802.11n (40MHz)	1 to 7	1, 4, 7	OFDM	BPSK	15.0

RADIATED EMISSION TEST (BELOW 1GHz):

- Pre-Scan has been conducted to determine the worst-case mode from all possible combinations between available modulations, data rates and antenna ports (if EUT with antenna diversity architecture).
- Following channel(s) was (were) selected for the final test as listed below.

MODE	AVAILABLE CHANNEL	TESTED CHANNEL	MODULATION TECHNOLOGY	MODULATION TYPE	DATA RATE (Mbps)
Draft 802.11n (40MHz)	1 to 7	4	OFDM	BPSK	15.0

POWER LINE CONDUCTED EMISSION TEST:

- Pre-Scan has been conducted to determine the worst-case mode from all possible combinations between available modulations, data rates and antenna ports (if EUT with antenna diversity architecture).
- Following channel(s) was (were) selected for the final test as listed below.

MODE	AVAILABLE CHANNEL	TESTED CHANNEL	MODULATION TECHNOLOGY	MODULATION TYPE	DATA RATE (Mbps)
Draft 802.11n (40MHz)	1 to 7	4	OFDM	BPSK	15.0

BANDEDGE MEASUREMENT:

- Pre-Scan has been conducted to determine the worst-case mode from all possible combinations between available modulations, data rates and antenna ports (if EUT with antenna diversity architecture).
- Following channel(s) was (were) selected for the final test as listed below.

MODE	AVAILABLE CHANNEL	TESTED CHANNEL	MODULATION TECHNOLOGY	MODULATION TYPE	DATA RATE (Mbps)
802.11b	1 to 11	1, 11	DSSS	DBPSK	1.0
802.11g	1 to 11	1, 11	OFDM	BPSK	6.0
Draft 802.11n (20MHz)	1 to 11	1, 11	OFDM	BPSK	7.2
Draft 802.11n (40MHz)	1 to 7	1, 7	OFDM	BPSK	15.0

ANTENNA PORT CONDUCTED MEASUREMENT:

- Pre-Scan has been conducted to determine the worst-case mode from all possible combinations between available modulations, data rates and antenna ports (if EUT with antenna diversity architecture).
- Following channel(s) was (were) selected for the final test as listed below.

MODE	AVAILABLE CHANNEL	TESTED CHANNEL	MODULATION TECHNOLOGY	MODULATION TYPE	DATA RATE (Mbps)
802.11b	1 to 11	1, 6, 11	DSSS	DBPSK	1.0
802.11g	1 to 11	1, 6, 11	OFDM	BPSK	6.0
Draft 802.11n (20MHz)	1 to 11	1, 6, 11	OFDM	BPSK	7.2
Draft 802.11n (40MHz)	1 to 7	1, 4, 7	OFDM	BPSK	15.0

3.3 GENERAL DESCRIPTION OF APPLIED STANDARDS

The EUT is a RF Product. According to the specifications of the manufacturer, it must comply with the requirements of the following standards:

FCC Part 15, Subpart C (15.247)
ANSI C63.4-2003

All test items have been performed and recorded as per the above standards.

NOTE: The EUT is also considered as a kind of computer peripheral, because the connection to computer is necessary for typical use. It has been verified to comply with the requirements of FCC Part 15, Subpart B, Class B (DoC). The test report has been issued separately.

3.4 DESCRIPTION OF SUPPORT UNITS

The EUT has been tested as an independent unit together with other necessary accessories or support units. The following support units or accessories were used to form a representative test configuration during the tests.

NO.	PRODUCT	BRAND	MODEL NO.	SERIAL NO.	FCC ID
1	PC	MSI	Hetis 865G	380125734	FCC DoC Approved
2	LCD MONITOR	Acer	AL1511 bm	ET.L1408.0433480 0146PK01	FCC DoC Approved
3	MODEM	ACEEX	1414V/3	0401008248	IFAXDM1414
4	PRINTER	EPSON	LQ-300+	DCGY047265	FCC DoC Approved
5	KEYBOARD	BTC	5200U	G09302046467	E5XKB5122U
6	MOUSE	DELL	M056U0	349004362	FCC DoC Approved

NO.	SIGNAL CABLE DESCRIPTION OF THE ABOVE SUPPORT UNITS
1	NA
2	1.8m D-Sub cable with two cores.
3	1.2m braid shielded wire , DB25 & DB9 connector , w/o core.
4	1.8m braid shielded wire , DB25 connector , w/o core.
5	1.5m foil shielded wire, USB Connector, w/o core.
6	1.8m foil shielded wire, USB Connector, w/o core.

NOTE: All power cords of the above support units are non shielded (1.8m).

4. TEST TYPES AND RESULTS

4.1 RADIATED EMISSION MEASUREMENT

4.1.1 LIMITS OF RADIATED EMISSION MEASUREMENT

Emissions radiated outside of the specified bands, shall be according to the general radiated limits in 15.209 as following:

FREQUENCIES (MHz)	FIELD STRENGTH (microvolts/meter)	MEASUREMENT DISTANCE (meters)
0.009 ~ 0.490	2400/F(kHz)	300
0.490 ~ 1.705	24000/F(kHz)	30
1.705 ~ 30.0	30	30
30 ~ 88	100	3
88 ~ 216	150	3
216 ~ 960	200	3
Above 960	500	3

NOTE:

1. The lower limit shall apply at the transition frequencies.
2. Emission level (dBuV/m) = 20 log Emission level (uV/m).
3. As shown in 15.35(b), for frequencies above 1000MHz, the field strength limits are based on average detector, however, the peak field strength of any emission shall not exceed the maximum permitted average limits, specified above by more than 20dB under any condition of modulation.



4.1.2 TEST INSTRUMENTS

DESCRIPTION & MANUFACTURER	MODEL NO.	SERIAL NO.	DATE OF CALIBRATION	DUE DATE OF CALIBRATION
Test Receiver ROHDE & SCHWARZ	ESI7	100033	Jun. 30, 2008	Jun. 29, 2009
Spectrum Analyzer ROHDE & SCHWARZ	FSP40	100041	Apr. 22, 2008	Apr. 21, 2009
BILOG Antenna SCHWARZBECK	VULB9168	9168-160	May 02, 2008	May 01, 2009
HORN Antenna SCHWARZBECK	9120D	9120D-209	Jun. 24, 2008	Jun. 23, 2009
HORN Antenna SCHWARZBECK	BBHA 9170	BBHA9170243	Dec. 25, 2007	Dec. 24, 2008
Preamplifier Agilent	8447D	2944A10633	Nov. 03, 2008	Nov. 02, 2009
Preamplifier Agilent	8449B	3008A01964	Oct. 23, 2008	Oct. 22, 2009
RF signal cable HUBER+SUHNNER	SUCOFLEX 104	238141/4	May 20, 2008	May 19, 2009
RF signal cable HUBER+SUHNNER	SUCOFLEX 104	12738/6	May 20, 2008	May 19, 2009
Software ADT.	ADT_Radiated_V7.6	NA	NA	NA
Antenna Tower inn-co GmbH	MA 4000	013303	NA	NA
Antenna Tower Controller inn-co GmbH	CO2000	017303	NA	NA
Turn Table ADT.	TT100.	TT93021703	NA	NA
Turn Table Controller ADT.	SC100.	SC93021703	NA	NA

- NOTE:**
1. The calibration interval of the above test instruments is 12 months and the calibrations are traceable to NML/ROC and NIST/USA.
 2. The test was performed in HwaYa Chamber 3.
 3. The horn antenna and HP preamplifier (model: 8449B) are used only for the measurement of emission frequency above 1GHz if tested.
 4. The FCC Site Registration No. is 988962.
 5. The IC Site Registration No. is IC 7450F-3.

4.1.3 TEST PROCEDURES

- a. The EUT was placed on the top of a rotating table 0.8 meters above the ground at a 3 meters semi-anechoic chamber. The table was rotated 360 degrees to determine the position of the highest radiation.
- b. The EUT was set 3 meters away from the interference-receiving antenna, which was mounted on the top of a variable-height antenna tower.
- c. The antenna is a broadband antenna, and its height is varied from one meter to four meters above the ground to determine the maximum value of the field strength. Both horizontal and vertical polarizations of the antenna are set to make the measurement.
- d. For each suspected emission, the EUT was arranged to its worst case and then the antenna was tuned to heights from 1 meter to 4 meters and the rotatable table was turned from 0 degrees to 360 degrees to find the maximum reading.
- e. The test-receiver system was set to Peak Detect Function and Specified Bandwidth with Maximum Hold Mode.
- f. If the emission level of the EUT in peak mode was lower than the limit specified, then testing could be stopped and the peak values of the EUT would be reported. Otherwise the emissions would be re-tested one by one using peak, quasi-peak or average method as specified and then reported in a data sheet.

NOTE:

1. The resolution bandwidth and video bandwidth of test receiver/spectrum analyzer is 120kHz for Quasi-peak detection at frequency below 1GHz.
2. The resolution bandwidth of test receiver/spectrum analyzer is 1MHz and video bandwidth is 3MHz for Peak detection at frequency above 1GHz.
3. The resolution bandwidth of test receiver/spectrum analyzer is 1MHz and the video bandwidth is 10Hz for Average detection (AV) at frequency above 1GHz.
4. All modes of operation were investigated and the worst-case emissions are reported.

4.1.4 DEVIATION FROM TEST STANDARD

No deviation.

4.1.5 TEST SETUP

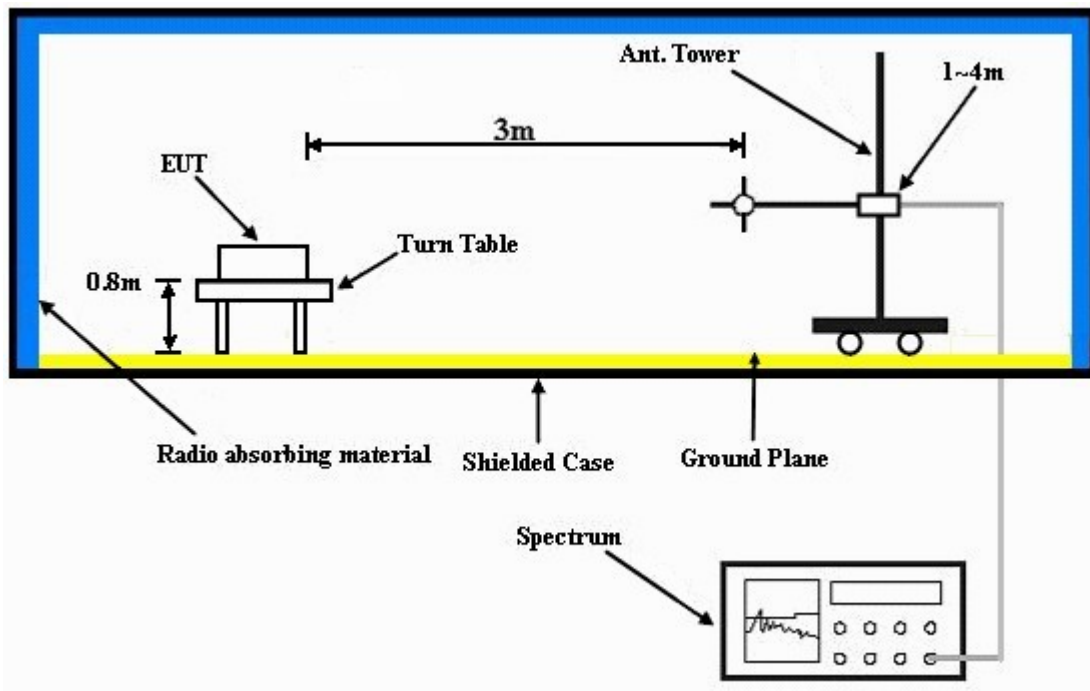

For the actual test configuration, please refer to the attached file (Test Setup Photo).

4.1.6 EUT OPERATING CONDITIONS

- a. The EUT installed to the PC and placed on the testing table.
- b. The PC ran a test program (provided by manufacturer) to enable EUT under transmission condition continuously at specific channel frequency.
- c. The necessary accessories enable the EUT in full functions.

4.1.7 TEST RESULTS

802.11b DSSS MODULATION

EUT TEST CONDITION		MEASUREMENT DETAIL	
CHANNEL	Channel 1	FREQUENCY RANGE	1 ~ 25GHz
INPUT POWER (SYSTEM)	120Vac, 60 Hz	DETECTOR FUNCTION	Peak (PK) Average (AV)
ENVIRONMENTAL CONDITIONS	26deg. C, 67%RH 1021hPa	TESTED BY	Antony Lee

ANTENNA POLARITY & TEST DISTANCE: HORIZONTAL AT 3 M								
NO.	FREQ. (MHz)	EMISSION LEVEL (dBuV/m)	LIMIT (dBuV/m)	MARGIN (dB)	ANTENNA HEIGHT (m)	TABLE ANGLE (Degree)	RAW VALUE (dBuV)	CORRECTION FACTOR (dB/m)
1	2390.00	61.46 PK	74.00	-12.54	1.00 H	253	28.13	33.33
2	2390.00	48.54 AV	54.00	-5.46	1.00 H	253	15.21	33.33
3	*2412.00	102.89 PK			1.51 H	150	69.48	33.41
4	*2412.00	98.59 AV			1.51 H	150	65.18	33.41
5	#3216.00	46.89 PK	82.89	-36.00	1.00 H	170	11.08	35.80
6	#3216.00	36.30 AV	78.59	-42.29	1.00 H	170	0.49	35.80
7	4824.00	50.54 PK	74.00	-23.46	1.00 H	142	10.78	39.76
8	4824.00	46.39 AV	54.00	-7.61	1.00 H	142	6.63	39.76
9	#7236.00	58.51 PK	82.89	-24.38	1.13 H	218	12.07	46.45
10	#7236.00	50.08 AV	78.59	-28.51	1.13 H	218	3.64	46.45

- REMARKS:**
1. Emission level (dBuV/m) = Raw Value (dBuV) + Correction Factor (dB/m).
 2. Correction Factor (dB/m) = Antenna Factor (dB/m) + Cable Factor (dB).
 3. The other emission levels were very low against the limit.
 4. Margin value = Emission level – Limit value.
 5. “ * “: Fundamental frequency.
 6. “#”: The radiated frequency is out the restricted band.



A D T

EUT TEST CONDITION		MEASUREMENT DETAIL	
CHANNEL	Channel 1	FREQUENCY RANGE	1 ~ 25GHz
INPUT POWER (SYSTEM)	120Vac, 60 Hz	DETECTOR FUNCTION	Peak (PK) Average (AV)
ENVIRONMENTAL CONDITIONS	26deg. C, 67%RH 1021hPa	TESTED BY	Antony Lee

ANTENNA POLARITY & TEST DISTANCE: VERTICAL AT 3 M								
NO.	FREQ. (MHz)	EMISSION LEVEL (dBuV/m)	LIMIT (dBuV/m)	MARGIN (dB)	ANTENNA HEIGHT (m)	TABLE ANGLE (Degree)	RAW VALUE (dBuV)	CORRECTION FACTOR (dB/m)
1	2390.00	62.36 PK	74.00	-11.64	1.03 V	226	29.03	33.33
2	2390.00	50.83 AV	54.00	-3.17	1.03 V	226	17.50	33.33
3	*2412.00	110.13 PK			1.04 V	84	76.72	33.41
4	*2412.00	105.30 AV			1.04 V	84	71.89	33.41
5	#3216.00	51.13 PK	90.13	-39.00	1.11 V	239	15.33	35.80
6	#3216.00	46.57 AV	85.30	-38.73	1.11 V	239	10.76	35.80
7	4824.00	52.20 PK	74.00	-21.80	1.08 V	209	12.44	39.76
8	4824.00	48.77 AV	54.00	-5.23	1.08 V	209	9.01	39.76
9	#7236.00	59.49 PK	90.13	-30.64	1.08 V	329	13.05	46.45
10	#7236.00	51.97 AV	85.30	-33.33	1.08 V	329	5.53	46.45

- REMARKS:**
1. Emission level (dBuV/m) = Raw Value (dBuV) + Correction Factor (dB/m).
 2. Correction Factor (dB/m) = Antenna Factor (dB/m) + Cable Factor (dB).
 3. The other emission levels were very low against the limit.
 4. Margin value = Emission level – Limit value.
 5. “ * “: Fundamental frequency.
 6. “#”:The radiated frequency is out the restricted band.

EUT TEST CONDITION		MEASUREMENT DETAIL	
CHANNEL	Channel 6	FREQUENCY RANGE	1 ~ 25GHz
INPUT POWER (SYSTEM)	120Vac, 60 Hz	DETECTOR FUNCTION	Peak (PK) Average (AV)
ENVIRONMENTAL CONDITIONS	26deg. C, 67%RH 1021hPa	TESTED BY	Antony Lee

ANTENNA POLARITY & TEST DISTANCE: HORIZONTAL AT 3 M								
NO.	FREQ. (MHz)	EMISSION LEVEL (dBuV/m)	LIMIT (dBuV/m)	MARGIN (dB)	ANTENNA HEIGHT (m)	TABLE ANGLE (Degree)	RAW VALUE (dBuV)	CORRECTION FACTOR (dB/m)
1	*2437.00	102.83 PK			1.20 H	149	69.34	33.49
2	*2437.00	98.53 AV			1.20 H	149	65.04	33.49
3	#3249.00	48.81 PK	82.83	-34.02	1.00 H	172	12.94	35.87
4	#3249.00	40.61 AV	78.53	-37.92	1.00 H	172	4.74	35.87
5	4874.00	51.28 PK	74.00	-22.72	1.00 H	168	11.40	39.88
6	4874.00	46.42 AV	54.00	-7.58	1.00 H	168	6.54	39.88
7	7311.00	57.50 PK	74.00	-16.50	1.03 H	177	10.80	46.70
8	7311.00	50.49 AV	54.00	-3.51	1.03 H	177	3.79	46.70
ANTENNA POLARITY & TEST DISTANCE: VERTICAL AT 3 M								
NO.	FREQ. (MHz)	EMISSION LEVEL (dBuV/m)	LIMIT (dBuV/m)	MARGIN (dB)	ANTENNA HEIGHT (m)	TABLE ANGLE (Degree)	RAW VALUE (dBuV)	CORRECTION FACTOR (dB/m)
1	*2437.00	110.38 PK			1.05 V	137	76.89	33.49
2	*2437.00	105.26 AV			1.05 V	137	71.77	33.49
3	#3249.00	50.95 PK	90.38	-39.43	1.11 V	237	15.08	35.87
4	#3249.00	46.37 AV	85.26	-38.89	1.11 V	237	10.50	35.87
5	4874.00	54.28 PK	74.00	-19.72	1.00 V	8	14.40	39.88
6	4874.00	49.95 AV	54.00	-4.05	1.00 V	8	10.07	39.88
7	7311.00	60.38 PK	74.00	-13.62	1.17 V	153	13.68	46.70
8	7311.00	52.57 AV	54.00	-1.43	1.17 V	153	5.87	46.70

- REMARKS:**
1. Emission level (dBuV/m) = Raw Value (dBuV) + Correction Factor (dB/m).
 2. Correction Factor (dB/m) = Antenna Factor (dB/m) + Cable Factor (dB).
 3. The other emission levels were very low against the limit.
 4. Margin value = Emission level – Limit value.
 5. “ * “: Fundamental frequency.
 6. “#”:The radiated frequency is out the restricted band.



A D T

EUT TEST CONDITION		MEASUREMENT DETAIL	
CHANNEL	Channel 11	FREQUENCY RANGE	1 ~ 25GHz
INPUT POWER (SYSTEM)	120Vac, 60 Hz	DETECTOR FUNCTION	Peak (PK) Average (AV)
ENVIRONMENTAL CONDITIONS	26deg. C, 67%RH 1021hPa	TESTED BY	Antony Lee

ANTENNA POLARITY & TEST DISTANCE: HORIZONTAL AT 3 M								
NO.	FREQ. (MHz)	EMISSION LEVEL (dBuV/m)	LIMIT (dBuV/m)	MARGIN (dB)	ANTENNA HEIGHT (m)	TABLE ANGLE (Degree)	RAW VALUE (dBuV)	CORRECTION FACTOR (dB/m)
1	*2462.00	102.74 PK			1.20 H	146	69.17	33.57
2	*2462.00	99.01 AV			1.20 H	146	65.44	33.57
3	2483.50	59.83 PK	74.00	-14.17	1.00 H	203	26.19	33.64
4	2483.50	48.56 AV	54.00	-5.44	1.00 H	203	14.92	33.64
5	#3282.00	46.32 PK	82.74	-36.42	1.00 H	167	10.39	35.93
6	#3282.00	36.73 AV	79.01	-42.28	1.00 H	167	0.80	35.93
7	4924.00	52.07 PK	74.00	-21.93	1.00 H	153	12.03	40.03
8	4924.00	46.81 AV	54.00	-7.19	1.00 H	153	6.77	40.03
9	7386.00	56.75 PK	74.00	-17.25	1.00 H	263	9.82	46.93
10	7386.00	46.40 AV	54.00	-7.60	1.00 H	263	-0.53	46.93

- REMARKS:**
1. Emission level (dBuV/m) = Raw Value (dBuV) + Correction Factor (dB/m).
 2. Correction Factor (dB/m) = Antenna Factor (dB/m) + Cable Factor (dB).
 3. The other emission levels were very low against the limit.
 4. Margin value = Emission level – Limit value.
 5. “ * “: Fundamental frequency.
 6. “#”:The radiated frequency is out the restricted band.



A D T

EUT TEST CONDITION		MEASUREMENT DETAIL	
CHANNEL	Channel 11	FREQUENCY RANGE	1 ~ 25GHz
INPUT POWER (SYSTEM)	120Vac, 60 Hz	DETECTOR FUNCTION	Peak (PK) Average (AV)
ENVIRONMENTAL CONDITIONS	26deg. C, 67%RH 1021hPa	TESTED BY	Antony Lee

ANTENNA POLARITY & TEST DISTANCE: VERTICAL AT 3 M								
NO.	FREQ. (MHz)	EMISSION LEVEL (dBuV/m)	LIMIT (dBuV/m)	MARGIN (dB)	ANTENNA HEIGHT (m)	TABLE ANGLE (Degree)	RAW VALUE (dBuV)	CORRECTION FACTOR (dB/m)
1	*2462.00	110.34 PK			1.00 V	87	76.77	33.57
2	*2462.00	105.10 AV			1.00 V	87	71.53	33.57
3	2483.50	62.54 PK	74.00	-11.46	1.00 V	85	28.90	33.64
4	2483.50	50.44 AV	54.00	-3.56	1.00 V	85	16.80	33.64
5	#3282.00	49.23 PK	90.34	-41.11	1.07 V	221	13.30	35.93
6	#3282.00	43.96 AV	85.10	-41.14	1.07 V	221	8.03	35.93
7	4924.00	55.81 PK	74.00	-18.19	1.00 V	167	15.78	40.03
8	4924.00	51.69 AV	54.00	-2.31	1.00 V	167	11.66	40.03
9	7386.00	59.76 PK	74.00	-14.24	1.00 V	357	12.84	46.93
10	7386.00	51.30 AV	54.00	-2.70	1.00 V	357	4.38	46.93

- REMARKS:**
1. Emission level (dBuV/m) = Raw Value (dBuV) + Correction Factor (dB/m).
 2. Correction Factor (dB/m) = Antenna Factor (dB/m) + Cable Factor (dB).
 3. The other emission levels were very low against the limit.
 4. Margin value = Emission level – Limit value.
 5. “ * “: Fundamental frequency.
 6. “#”:The radiated frequency is out the restricted band.

802.11g OFDM MODULATION

EUT TEST CONDITION		MEASUREMENT DETAIL	
CHANNEL	Channel 1	FREQUENCY RANGE	1 ~ 25GHz
INPUT POWER (SYSTEM)	120Vac, 60 Hz	DETECTOR FUNCTION	Peak (PK) Average (AV)
ENVIRONMENTAL CONDITIONS	26deg. C, 67%RH 1021hPa	TESTED BY	Antony Lee

ANTENNA POLARITY & TEST DISTANCE: HORIZONTAL AT 3 M								
NO.	FREQ. (MHz)	EMISSION LEVEL (dBuV/m)	LIMIT (dBuV/m)	MARGIN (dB)	ANTENNA HEIGHT (m)	TABLE ANGLE (Degree)	RAW VALUE (dBuV)	CORRECTION FACTOR (dB/m)
1	2390.00	58.40 PK	74.00	-15.60	1.00 H	340	25.07	33.33
2	2390.00	49.32 AV	54.00	-4.68	1.00 H	340	15.99	33.33
3	*2412.00	103.42 PK			1.48 H	150	70.01	33.41
4	*2412.00	94.32 AV			1.48 H	150	60.91	33.41
5	#3216.00	48.16 PK	83.42	-35.26	1.05 H	237	12.35	35.80
6	#3216.00	40.25 AV	74.32	-34.07	1.05 H	237	4.44	35.80
7	4824.00	48.02 PK	74.00	-25.98	1.00 H	23	8.26	39.76
8	4824.00	34.76 AV	54.00	-19.24	1.00 H	23	-5.00	39.76
ANTENNA POLARITY & TEST DISTANCE: VERTICAL AT 3 M								
NO.	FREQ. (MHz)	EMISSION LEVEL (dBuV/m)	LIMIT (dBuV/m)	MARGIN (dB)	ANTENNA HEIGHT (m)	TABLE ANGLE (Degree)	RAW VALUE (dBuV)	CORRECTION FACTOR (dB/m)
1	2390.00	69.88 PK	74.00	-4.12	1.00 V	264	36.55	33.33
2	2390.00	51.78 AV	54.00	-2.22	1.00 V	264	18.45	33.33
3	*2412.00	112.24 PK			1.00 V	136	78.83	33.41
4	*2412.00	102.67 AV			1.00 V	136	69.26	33.41
5	#3216.00	51.92 PK	92.24	-40.32	1.12 V	237	16.11	35.80
6	#3216.00	47.05 AV	82.67	-35.62	1.12 V	237	11.24	35.80
7	4824.00	48.00 PK	74.00	-26.00	1.00 V	62	8.24	39.76
8	4824.00	35.71 AV	54.00	-18.29	1.00 V	62	-4.05	39.76

- REMARKS:**
1. Emission level (dBuV/m) = Raw Value (dBuV) + Correction Factor (dB/m).
 2. Correction Factor (dB/m) = Antenna Factor (dB/m) + Cable Factor (dB).
 3. The other emission levels were very low against the limit.
 4. Margin value = Emission level – Limit value.
 5. “ * “: Fundamental frequency.
 6. “#”: The radiated frequency is out the restricted band.

EUT TEST CONDITION		MEASUREMENT DETAIL	
CHANNEL	Channel 6	FREQUENCY RANGE	1 ~ 25GHz
INPUT POWER (SYSTEM)	120Vac, 60 Hz	DETECTOR FUNCTION	Peak (PK) Average (AV)
ENVIRONMENTAL CONDITIONS	26deg. C, 67%RH 1021hPa	TESTED BY	Antony Lee

ANTENNA POLARITY & TEST DISTANCE: HORIZONTAL AT 3 M								
NO.	FREQ. (MHz)	EMISSION LEVEL (dBuV/m)	LIMIT (dBuV/m)	MARGIN (dB)	ANTENNA HEIGHT (m)	TABLE ANGLE (Degree)	RAW VALUE (dBuV)	CORRECTION FACTOR (dB/m)
1	*2437.00	104.71 PK			1.20 H	148	71.22	33.49
2	*2437.00	94.88 AV			1.20 H	148	61.39	33.49
3	#3249.00	57.87 PK	84.71	-26.84	1.03 H	240	22.00	35.87
4	#3249.00	45.06 AV	74.88	-29.82	1.03 H	240	9.19	35.87
5	4874.00	35.66 PK	74.00	-38.34	1.00 H	56	-4.22	39.88
6	4874.00	34.62 AV	54.00	-19.38	1.00 H	56	-5.26	39.88
7	7311.00	59.82 PK	74.00	-14.18	1.00 H	231	13.12	46.70
8	7311.00	45.81 AV	54.00	-8.19	1.00 H	231	-0.89	46.70
ANTENNA POLARITY & TEST DISTANCE: VERTICAL AT 3 M								
NO.	FREQ. (MHz)	EMISSION LEVEL (dBuV/m)	LIMIT (dBuV/m)	MARGIN (dB)	ANTENNA HEIGHT (m)	TABLE ANGLE (Degree)	RAW VALUE (dBuV)	CORRECTION FACTOR (dB/m)
1	*2437.00	112.23 PK			1.00 V	165	78.74	33.49
2	*2437.00	102.63 AV			1.00 V	165	69.14	33.49
3	#3249.00	55.49 PK	92.23	-36.74	1.10 V	242	19.62	35.87
4	#3249.00	52.79 AV	82.63	-29.84	1.10 V	242	16.92	35.87
5	4874.00	51.74 PK	74.00	-22.26	1.00 V	230	11.86	39.88
6	4874.00	37.81 AV	54.00	-16.19	1.00 V	230	-2.07	39.88
7	7311.00	64.93 PK	74.00	-9.07	1.06 V	199	18.23	46.70
8	7311.00	50.26 AV	54.00	-3.74	1.06 V	199	3.56	46.70

- REMARKS:**
1. Emission level (dBuV/m) = Raw Value (dBuV) + Correction Factor (dB/m).
 2. Correction Factor (dB/m) = Antenna Factor (dB/m) + Cable Factor (dB).
 3. The other emission levels were very low against the limit.
 4. Margin value = Emission level – Limit value.
 5. " * ": Fundamental frequency.
 6. "#": The radiated frequency is out the restricted band.

EUT TEST CONDITION		MEASUREMENT DETAIL	
CHANNEL	Channel 11	FREQUENCY RANGE	1 ~ 25GHz
INPUT POWER (SYSTEM)	120Vac, 60 Hz	DETECTOR FUNCTION	Peak (PK) Average (AV)
ENVIRONMENTAL CONDITIONS	26deg. C, 67%RH 1021hPa	TESTED BY	Antony Lee

ANTENNA POLARITY & TEST DISTANCE: HORIZONTAL AT 3 M								
NO.	FREQ. (MHz)	EMISSION LEVEL (dBuV/m)	LIMIT (dBuV/m)	MARGIN (dB)	ANTENNA HEIGHT (m)	TABLE ANGLE (Degree)	RAW VALUE (dBuV)	CORRECTION FACTOR (dB/m)
1	*2462.00	103.15 PK			1.43 H	147	69.58	33.57
2	*2462.00	93.48 AV			1.43 H	147	59.91	33.57
3	2483.50	60.45 PK	74.00	-13.55	1.00 H	136	26.81	33.64
4	2483.50	47.69 AV	54.00	-6.31	1.00 H	136	14.05	33.64
5	#3282.00	50.45 PK	83.15	-32.70	1.00 H	246	14.52	35.93
6	#3282.00	36.83 AV	73.48	-36.65	1.00 H	246	0.90	35.93
7	4924.00	48.22 PK	74.00	-25.78	1.00 H	203	8.18	40.03
8	4924.00	34.75 AV	54.00	-19.25	1.00 H	203	-5.29	40.03
ANTENNA POLARITY & TEST DISTANCE: VERTICAL AT 3 M								
NO.	FREQ. (MHz)	EMISSION LEVEL (dBuV/m)	LIMIT (dBuV/m)	MARGIN (dB)	ANTENNA HEIGHT (m)	TABLE ANGLE (Degree)	RAW VALUE (dBuV)	CORRECTION FACTOR (dB/m)
1	*2462.00	111.53 PK			1.00 V	135	77.96	33.57
2	*2462.00	101.96 AV			1.00 V	135	68.39	33.57
3	2483.50	69.65 PK	74.00	-4.35	1.00 V	135	36.01	33.64
4	2483.50	52.55 AV	54.00	-1.45	1.00 V	135	18.91	33.64
5	#3282.00	50.17 PK	91.53	-41.36	1.08 V	240	14.24	35.93
6	#3282.00	44.93 AV	81.96	-37.03	1.08 V	240	9.00	35.93
7	4924.00	48.05 PK	74.00	-25.95	1.00 V	19	8.01	40.03
8	4924.00	35.47 AV	54.00	-18.53	1.00 V	19	-4.57	40.03

- REMARKS:**
1. Emission level (dBuV/m) = Raw Value (dBuV) + Correction Factor (dB/m).
 2. Correction Factor (dB/m) = Antenna Factor (dB/m) + Cable Factor (dB).
 3. The other emission levels were very low against the limit.
 4. Margin value = Emission level – Limit value.
 5. “ * “: Fundamental frequency.
 6. “#”:The radiated frequency is out the restricted band.

DRAFT 802.11n (20MHz) OFDM MODULATION

EUT TEST CONDITION		MEASUREMENT DETAIL	
CHANNEL	Channel 1	FREQUENCY RANGE	1 ~ 25GHz
INPUT POWER (SYSTEM)	120Vac, 60 Hz	DETECTOR FUNCTION	Peak (PK) Average (AV)
ENVIRONMENTAL CONDITIONS	26deg. C, 67%RH 1021hPa	TESTED BY	Antony Lee

ANTENNA POLARITY & TEST DISTANCE: HORIZONTAL AT 3 M								
NO.	FREQ. (MHz)	EMISSION LEVEL (dBuV/m)	LIMIT (dBuV/m)	MARGIN (dB)	ANTENNA HEIGHT (m)	TABLE ANGLE (Degree)	RAW VALUE (dBuV)	CORRECTION FACTOR (dB/m)
1	2390.00	65.58 PK	74.00	-8.42	1.00 H	29	32.25	33.33
2	2390.00	48.30 AV	54.00	-5.70	1.00 H	29	14.97	33.33
3	*2412.00	104.11 PK			1.47 H	149	70.70	33.41
4	*2412.00	93.80 AV			1.47 H	149	60.39	33.41
5	#3216.00	49.98 PK	84.11	-34.13	1.00 H	233	14.18	35.80
6	#3216.00	39.82 AV	73.80	-33.98	1.00 H	233	4.02	35.80
7	4824.00	48.50 PK	74.00	-25.50	1.00 H	201	8.74	39.76
8	4824.00	35.07 AV	54.00	-18.93	1.00 H	201	-4.69	39.76
ANTENNA POLARITY & TEST DISTANCE: VERTICAL AT 3 M								
NO.	FREQ. (MHz)	EMISSION LEVEL (dBuV/m)	LIMIT (dBuV/m)	MARGIN (dB)	ANTENNA HEIGHT (m)	TABLE ANGLE (Degree)	RAW VALUE (dBuV)	CORRECTION FACTOR (dB/m)
1	2390.00	71.89 PK	74.00	-2.11	1.00 V	229	38.56	33.33
2	2390.00	51.05 AV	54.00	-2.95	1.00 V	229	17.72	33.33
3	*2412.00	112.32 PK			1.00 V	82	78.91	33.41
4	*2412.00	101.65 AV			1.00 V	82	68.24	33.41
5	#3216.00	51.00 PK	92.32	-41.32	1.10 V	228	15.19	35.80
6	#3216.00	46.61 AV	81.65	-35.04	1.10 V	228	10.80	35.80
7	4824.00	48.46 PK	74.00	-25.54	1.06 V	57	8.70	39.76
8	4824.00	34.57 AV	54.00	-19.43	1.06 V	57	-5.19	39.76

- REMARKS:**
1. Emission level (dBuV/m) = Raw Value (dBuV) + Correction Factor (dB/m).
 2. Correction Factor (dB/m) = Antenna Factor (dB/m) + Cable Factor (dB).
 3. The other emission levels were very low against the limit.
 4. Margin value = Emission level – Limit value.
 5. “ * “: Fundamental frequency.
 6. “#”:The radiated frequency is out the restricted band.

EUT TEST CONDITION		MEASUREMENT DETAIL	
CHANNEL	Channel 6	FREQUENCY RANGE	1 ~ 25GHz
INPUT POWER (SYSTEM)	120Vac, 60 Hz	DETECTOR FUNCTION	Peak (PK) Average (AV)
ENVIRONMENTAL CONDITIONS	26deg. C, 67%RH 1021hPa	TESTED BY	Antony Lee

ANTENNA POLARITY & TEST DISTANCE: HORIZONTAL AT 3 M								
NO.	FREQ. (MHz)	EMISSION LEVEL (dBuV/m)	LIMIT (dBuV/m)	MARGIN (dB)	ANTENNA HEIGHT (m)	TABLE ANGLE (Degree)	RAW VALUE (dBuV)	CORRECTION FACTOR (dB/m)
1	*2437.00	104.28 PK			1.23 H	148	70.79	33.49
2	*2437.00	94.12 AV			1.23 H	148	60.63	33.49
3	#3249.00	49.49 PK	84.28	-34.79	1.00 H	234	13.62	35.87
4	#3249.00	43.37 AV	74.12	-30.75	1.00 H	234	7.50	35.87
5	4874.00	48.77 PK	74.00	-25.23	1.00 H	69	8.89	39.88
6	4874.00	35.17 AV	54.00	-18.83	1.00 H	69	-4.71	39.88
7	7311.00	58.02 PK	74.00	-15.98	1.00 H	234	11.32	46.70
8	7311.00	44.89 AV	54.00	-9.11	1.00 H	234	-1.81	46.70
ANTENNA POLARITY & TEST DISTANCE: VERTICAL AT 3 M								
NO.	FREQ. (MHz)	EMISSION LEVEL (dBuV/m)	LIMIT (dBuV/m)	MARGIN (dB)	ANTENNA HEIGHT (m)	TABLE ANGLE (Degree)	RAW VALUE (dBuV)	CORRECTION FACTOR (dB/m)
1	*2437.00	112.62 PK			1.00 V	164	79.13	33.49
2	*2437.00	102.73 AV			1.00 V	164	69.24	33.49
3	#3249.00	54.59 PK	92.62	-38.03	1.10 V	243	18.72	35.87
4	#3249.00	51.85 AV	82.73	-30.88	1.10 V	243	15.98	35.87
5	4874.00	50.41 PK	74.00	-23.59	1.00 V	234	10.53	39.88
6	4874.00	35.37 AV	54.00	-18.63	1.00 V	234	-4.51	39.88
7	7311.00	63.76 PK	74.00	-10.24	1.08 V	202	17.06	46.70
8	7311.00	49.04 AV	54.00	-4.96	1.08 V	202	2.34	46.70

- REMARKS:**
1. Emission level (dBuV/m) = Raw Value (dBuV) + Correction Factor (dB/m).
 2. Correction Factor (dB/m) = Antenna Factor (dB/m) + Cable Factor (dB).
 3. The other emission levels were very low against the limit.
 4. Margin value = Emission level – Limit value.
 5. " * ": Fundamental frequency.
 6. "#": The radiated frequency is out the restricted band.

EUT TEST CONDITION		MEASUREMENT DETAIL	
CHANNEL	Channel 11	FREQUENCY RANGE	1 ~ 25GHz
INPUT POWER (SYSTEM)	120Vac, 60 Hz	DETECTOR FUNCTION	Peak (PK) Average (AV)
ENVIRONMENTAL CONDITIONS	26deg. C, 67%RH 1021hPa	TESTED BY	Antony Lee

ANTENNA POLARITY & TEST DISTANCE: HORIZONTAL AT 3 M								
NO.	FREQ. (MHz)	EMISSION LEVEL (dBuV/m)	LIMIT (dBuV/m)	MARGIN (dB)	ANTENNA HEIGHT (m)	TABLE ANGLE (Degree)	RAW VALUE (dBuV)	CORRECTION FACTOR (dB/m)
1	*2462.00	103.07 PK			1.43 H	147	69.50	33.57
2	*2462.00	92.89 AV			1.43 H	147	59.32	33.57
3	2483.50	65.56 PK	74.00	-8.44	1.00 H	139	31.92	33.64
4	2483.50	49.59 AV	54.00	-4.41	1.00 H	139	15.95	33.64
5	#3282.00	50.76 PK	83.07	-32.31	1.00 H	230	14.83	35.93
6	#3282.00	36.18 AV	72.89	-36.71	1.00 H	230	0.25	35.93
7	4924.00	48.23 PK	74.00	-25.77	1.00 H	26	8.19	40.03
8	4924.00	35.17 AV	54.00	-18.83	1.00 H	26	-4.87	40.03
ANTENNA POLARITY & TEST DISTANCE: VERTICAL AT 3 M								
NO.	FREQ. (MHz)	EMISSION LEVEL (dBuV/m)	LIMIT (dBuV/m)	MARGIN (dB)	ANTENNA HEIGHT (m)	TABLE ANGLE (Degree)	RAW VALUE (dBuV)	CORRECTION FACTOR (dB/m)
1	*2462.00	111.30 PK			1.00 V	84	77.73	33.57
2	*2462.00	101.42 AV			1.00 V	84	67.85	33.57
3	2483.50	71.60 PK	74.00	-2.40	1.00 V	205	37.96	33.64
4	2483.50	52.40 AV	54.00	-1.60	1.00 V	205	18.76	33.64
5	#3282.00	49.73 PK	91.30	-41.57	1.06 V	236	13.80	35.93
6	#3282.00	44.86 AV	81.42	-36.56	1.06 V	236	8.93	35.93
7	4924.00	48.24 PK	74.00	-25.76	1.02 V	20	8.20	40.03
8	4924.00	35.44 AV	54.00	-18.56	1.02 V	20	-4.60	40.03

- REMARKS:**
1. Emission level (dBuV/m) = Raw Value (dBuV) + Correction Factor (dB/m).
 2. Correction Factor (dB/m) = Antenna Factor (dB/m) + Cable Factor (dB).
 3. The other emission levels were very low against the limit.
 4. Margin value = Emission level – Limit value.
 5. “ * “: Fundamental frequency.
 6. “#“: The radiated frequency is out the restricted band.

DRAFT 802.11n (40MHz) OFDM MODULATION

EUT TEST CONDITION		MEASUREMENT DETAIL	
CHANNEL	Channel 1	FREQUENCY RANGE	1 ~ 25GHz
INPUT POWER (SYSTEM)	120Vac, 60 Hz	DETECTOR FUNCTION	Peak (PK) Average (AV)
ENVIRONMENTAL CONDITIONS	26deg. C, 67%RH 1021hPa	TESTED BY	Antony Lee

ANTENNA POLARITY & TEST DISTANCE: HORIZONTAL AT 3 M								
NO.	FREQ. (MHz)	EMISSION LEVEL (dBuV/m)	LIMIT (dBuV/m)	MARGIN (dB)	ANTENNA HEIGHT (m)	TABLE ANGLE (Degree)	RAW VALUE (dBuV)	CORRECTION FACTOR (dB/m)
1	2390.00	64.74 PK	74.00	-9.26	1.00 H	36	31.41	33.33
2	2390.00	48.13 AV	54.00	-5.87	1.00 H	36	14.80	33.33
3	*2422.00	99.76 PK			1.46 H	145	66.32	33.44
4	*2422.00	89.95 AV			1.46 H	145	56.51	33.44
5	#3229.00	47.00 PK	79.76	-32.76	1.00 H	236	11.17	35.83
6	#3229.00	36.90 AV	69.95	-33.05	1.00 H	236	1.07	35.83
7	4844.00	47.35 PK	74.00	-26.65	1.00 H	200	7.54	39.81
8	4844.00	35.52 AV	54.00	-18.48	1.00 H	200	-4.29	39.81
ANTENNA POLARITY & TEST DISTANCE: VERTICAL AT 3 M								
NO.	FREQ. (MHz)	EMISSION LEVEL (dBuV/m)	LIMIT (dBuV/m)	MARGIN (dB)	ANTENNA HEIGHT (m)	TABLE ANGLE (Degree)	RAW VALUE (dBuV)	CORRECTION FACTOR (dB/m)
1	2390.00	72.07 PK	74.00	-1.93	1.00 V	231	38.74	33.33
2	2390.00	52.20 AV	54.00	-1.80	1.00 V	231	18.87	33.33
3	*2422.00	109.79 PK			1.00 V	84	76.35	33.44
4	*2422.00	99.67 AV			1.00 V	84	66.23	33.44
5	#3229.00	50.73 PK	89.79	-39.06	1.10 V	240	14.91	35.83
6	#3229.00	46.48 AV	79.67	-33.19	1.10 V	240	10.66	35.83
7	4844.00	47.58 PK	74.00	-26.42	1.02 V	59	7.78	39.81
8	4844.00	34.79 AV	54.00	-19.21	1.02 V	59	-5.01	39.81

- REMARKS:**
1. Emission level (dBuV/m) = Raw Value (dBuV) + Correction Factor (dB/m).
 2. Correction Factor (dB/m) = Antenna Factor (dB/m) + Cable Factor (dB).
 3. The other emission levels were very low against the limit.
 4. Margin value = Emission level – Limit value.
 5. “ * “: Fundamental frequency.
 6. “#”: The radiated frequency is out the restricted band.

EUT TEST CONDITION		MEASUREMENT DETAIL	
CHANNEL	Channel 4	FREQUENCY RANGE	1 ~ 25GHz
INPUT POWER (SYSTEM)	120Vac, 60 Hz	DETECTOR FUNCTION	Peak (PK) Average (AV)
ENVIRONMENTAL CONDITIONS	26deg. C, 67%RH 1021hPa	TESTED BY	Antony Lee

ANTENNA POLARITY & TEST DISTANCE: HORIZONTAL AT 3 M								
NO.	FREQ. (MHz)	EMISSION LEVEL (dBuV/m)	LIMIT (dBuV/m)	MARGIN (dB)	ANTENNA HEIGHT (m)	TABLE ANGLE (Degree)	RAW VALUE (dBuV)	CORRECTION FACTOR (dB/m)
1	*2437.00	101.78 PK			1.00 H	146	68.29	33.49
2	*2437.00	91.02 AV			1.00 H	146	57.53	33.49
3	#3249.00	48.88 PK	81.78	-32.90	1.00 H	234	13.01	35.87
4	#3249.00	41.68 AV	71.02	-29.34	1.00 H	234	5.81	35.87
5	4874.00	49.15 PK	74.00	-24.85	1.00 H	265	9.27	39.88
6	4874.00	35.02 AV	54.00	-18.98	1.00 H	265	-4.86	39.88
7	7311.00	54.74 PK	74.00	-19.26	1.00 H	215	8.04	46.70
8	7311.00	41.41 AV	54.00	-12.59	1.00 H	215	-5.29	46.70
ANTENNA POLARITY & TEST DISTANCE: VERTICAL AT 3 M								
NO.	FREQ. (MHz)	EMISSION LEVEL (dBuV/m)	LIMIT (dBuV/m)	MARGIN (dB)	ANTENNA HEIGHT (m)	TABLE ANGLE (Degree)	RAW VALUE (dBuV)	CORRECTION FACTOR (dB/m)
1	*2437.00	110.37 PK			1.00 V	163	76.88	33.49
2	*2437.00	100.34 AV			1.00 V	163	66.85	33.49
3	#3249.00	53.30 PK	90.37	-37.07	1.09 V	245	17.43	35.87
4	#3249.00	50.11 AV	80.34	-30.23	1.09 V	245	14.24	35.87
5	4874.00	48.56 PK	74.00	-25.44	1.00 V	263	8.68	39.88
6	4874.00	35.26 AV	54.00	-18.74	1.00 V	263	-4.62	39.88
7	7311.00	59.28 PK	74.00	-14.72	1.08 V	199	12.58	46.70
8	7311.00	46.10 AV	54.00	-7.90	1.08 V	199	-0.60	46.70

- REMARKS:**
1. Emission level (dBuV/m) = Raw Value (dBuV) + Correction Factor (dB/m).
 2. Correction Factor (dB/m) = Antenna Factor (dB/m) + Cable Factor (dB).
 3. The other emission levels were very low against the limit.
 4. Margin value = Emission level – Limit value.
 5. “ * “: Fundamental frequency.
 6. “#“: The radiated frequency is out the restricted band.

EUT TEST CONDITION		MEASUREMENT DETAIL	
CHANNEL	Channel 7	FREQUENCY RANGE	1 ~ 25GHz
INPUT POWER (SYSTEM)	120Vac, 60 Hz	DETECTOR FUNCTION	Peak (PK) Average (AV)
ENVIRONMENTAL CONDITIONS	26deg. C, 67%RH 1021hPa	TESTED BY	Antony Lee

ANTENNA POLARITY & TEST DISTANCE: HORIZONTAL AT 3 M								
NO.	FREQ. (MHz)	EMISSION LEVEL (dBuV/m)	LIMIT (dBuV/m)	MARGIN (dB)	ANTENNA HEIGHT (m)	TABLE ANGLE (Degree)	RAW VALUE (dBuV)	CORRECTION FACTOR (dB/m)
1	*2452.00	98.94 PK			1.46 H	144	65.40	33.54
2	*2452.00	88.44 AV			1.46 H	144	54.90	33.54
3	2483.50	62.44 PK	74.00	-11.56	1.00 H	143	28.80	33.64
4	2483.50	49.61 AV	54.00	-4.39	1.00 H	143	15.97	33.64
5	#3269.00	49.12 PK	78.94	-29.82	1.00 H	245	13.21	35.91
6	#3269.00	37.26 AV	68.44	-31.18	1.00 H	245	1.35	35.91
7	4904.00	47.06 PK	74.00	-26.94	1.00 H	36	7.10	39.96
8	4904.00	35.82 AV	54.00	-18.18	1.00 H	36	-4.14	39.96
ANTENNA POLARITY & TEST DISTANCE: VERTICAL AT 3 M								
NO.	FREQ. (MHz)	EMISSION LEVEL (dBuV/m)	LIMIT (dBuV/m)	MARGIN (dB)	ANTENNA HEIGHT (m)	TABLE ANGLE (Degree)	RAW VALUE (dBuV)	CORRECTION FACTOR (dB/m)
1	*2452.00	108.01 PK			1.00 V	85	74.47	33.54
2	*2452.00	98.47 AV			1.00 V	85	64.93	33.54
3	2483.50	72.75 PK	74.00	-1.25	1.00 V	157	39.11	33.64
4	2483.50	52.12 AV	54.00	-1.88	1.00 V	157	18.48	33.64
5	#3269.00	50.55 PK	88.01	-37.46	1.07 V	237	14.64	35.91
6	#3269.00	45.19 AV	78.47	-33.28	1.07 V	237	9.28	35.91
7	4904.00	48.61 PK	74.00	-25.39	1.00 V	102	8.65	39.96
8	4904.00	34.95 AV	54.00	-19.05	1.00 V	102	-5.01	39.96

- REMARKS:**
1. Emission level (dBuV/m) = Raw Value (dBuV) + Correction Factor (dB/m).
 2. Correction Factor (dB/m) = Antenna Factor (dB/m) + Cable Factor (dB).
 3. The other emission levels were very low against the limit.
 4. Margin value = Emission level – Limit value.
 5. “ * “: Fundamental frequency.
 6. “#“: The radiated frequency is out the restricted band.

BELOW 1GHz WORST-CASE DATA : DRAFT 802.11n (40MHz) OFDM MODULATION

EUT TEST CONDITION		MEASUREMENT DETAIL	
CHANNEL	Channel 4	FREQUENCY RANGE	Below 1000MHz
INPUT POWER (SYSTEM)	120Vac, 60 Hz	DETECTOR FUNCTION	Quasi-Peak
ENVIRONMENTAL CONDITIONS	24deg. C, 64%RH 1021hPa	TESTED BY	Match Tsui

ANTENNA POLARITY & TEST DISTANCE: HORIZONTAL AT 3 M								
NO.	FREQ. (MHz)	EMISSION LEVEL (dBuV/m)	LIMIT (dBuV/m)	MARGIN (dB)	ANTENNA HEIGHT (m)	TABLE ANGLE (Degree)	RAW VALUE (dBuV)	CORRECTION FACTOR (dB/m)
1	167.94	37.63 QP	43.50	-5.87	1.50 H	223	23.27	14.36
2	391.54	37.89 QP	46.00	-8.11	1.00 H	187	19.32	18.56
3	399.31	39.81 QP	46.00	-6.19	1.00 H	193	20.90	18.91
4	453.75	36.47 QP	46.00	-9.53	2.00 H	223	16.23	20.23
5	488.75	40.18 QP	46.00	-5.82	1.25 H	145	19.01	21.17
6	496.53	39.15 QP	46.00	-6.85	2.00 H	217	17.77	21.37
7	533.47	35.35 QP	46.00	-10.65	1.50 H	79	13.14	22.21
8	675.40	35.51 QP	46.00	-10.49	1.25 H	304	9.72	25.80
9	720.12	40.12 QP	46.00	-5.88	1.00 H	232	13.40	26.72
10	727.90	39.07 QP	46.00	-6.93	1.00 H	223	12.27	26.80
11	805.67	35.49 QP	46.00	-10.51	1.50 H	241	7.81	27.68

- REMARKS:**
1. Emission level (dBuV/m) = Raw Value (dBuV) + Correction Factor (dB/m).
 2. Correction Factor (dB/m) = Antenna Factor (dB/m) + Cable Factor (dB).
 3. The other emission levels were very low against the limit.
 4. Margin value = Emission level – Limit value.



A D T

EUT TEST CONDITION		MEASUREMENT DETAIL	
CHANNEL	Channel 4	FREQUENCY RANGE	Below 1000MHz
INPUT POWER (SYSTEM)	120Vac, 60 Hz	DETECTOR FUNCTION	Quasi-Peak
ENVIRONMENTAL CONDITIONS	24deg. C, 64%RH 1021hPa	TESTED BY	Match Tsui

ANTENNA POLARITY & TEST DISTANCE: VERTICAL AT 3 M								
NO.	FREQ. (MHz)	EMISSION LEVEL (dBuV/m)	LIMIT (dBuV/m)	MARGIN (dB)	ANTENNA HEIGHT (m)	TABLE ANGLE (Degree)	RAW VALUE (dBuV)	CORRECTION FACTOR (dB/m)
1	167.94	32.67 QP	43.50	-10.83	2.00 V	262	18.31	14.36
2	391.54	36.78 QP	46.00	-9.22	1.00 V	142	18.21	18.56
3	399.31	39.39 QP	46.00	-6.61	1.00 V	157	20.48	18.91
4	488.75	37.55 QP	46.00	-8.45	1.00 V	70	16.39	21.17
5	496.53	37.56 QP	46.00	-8.44	1.00 V	61	16.19	21.37
6	574.30	36.77 QP	46.00	-9.23	1.50 V	202	13.67	23.10
7	675.40	36.80 QP	46.00	-9.20	1.25 V	175	11.00	25.80
8	716.23	39.13 QP	46.00	-6.87	1.25 V	205	12.45	26.67
9	722.07	37.64 QP	46.00	-8.36	1.25 V	208	10.90	26.74
10	805.67	36.38 QP	46.00	-9.62	1.25 V	130	8.70	27.68
11	817.34	35.34 QP	46.00	-10.66	1.00 V	127	7.39	27.96
12	879.55	35.60 QP	46.00	-10.40	1.00 V	166	6.17	29.42
13	959.27	36.92 QP	46.00	-9.08	1.50 V	346	6.39	30.53

- REMARKS:**
1. Emission level (dBuV/m) = Raw Value (dBuV) + Correction Factor (dB/m).
 2. Correction Factor (dB/m) = Antenna Factor (dB/m) + Cable Factor (dB).
 3. The other emission levels were very low against the limit.
 4. Margin value = Emission level – Limit value.

4.2 CONDUCTED EMISSION MEASUREMENT

4.2.1 LIMITS OF CONDUCTED EMISSION MEASUREMENT

FREQUENCY OF EMISSION (MHz)	CONDUCTED LIMIT (dB μ V)	
	Quasi-peak	Average
0.15 ~ 0.5	66 to 56	56 to 46
0.5 ~ 5	56	46
5 ~ 30	60	50

- NOTE:** 1. The lower limit shall apply at the transition frequencies.
 2. The limit decreases in line with the logarithm of the frequency in the range of 0.15 to 0.50MHz.
 3. All emanations from a class A/B digital device or system, including any network of conductors and apparatus connected thereto, shall not exceed the level of field strengths specified above.

4.2.2 TEST INSTRUMENTS

DESCRIPTION & MANUFACTURER	MODEL NO.	SERIAL NO.	DATE OF CALIBRATION	DUE DATE OF CALIBRATION
Test Receiver ROHDE & SCHWARZ	ESCS30	100291	Nov. 19, 2008	Nov. 18, 2009
RF signal cable Woken	5D-FB	Cable-HYC01-01	Jan. 04, 2008	Jan. 03, 2009
LISN ROHDE & SCHWARZ	ESH3-Z5	100312	Jun. 13, 2008	Jun. 12, 2009
V-LISN SCHWARZBECK	NNBL 8226-2	8226-142	Jun. 10, 2008	Jun. 09, 2009
Software ADT	ADT_Cond_V3	NA	NA	NA

- NOTE:** 1. The calibration interval of the above test instruments is 12 months and the calibrations are traceable to NML/ROC and NIST/USA.
 2. The test was performed in HwaYa Shielded Room 1.
 3. The VCCI Site Registration No. is C-2040.

4.2.3 TEST PROCEDURES

- a. The EUT was placed 0.4 meters from the conducting wall of the shielded room with EUT being connected to the power mains through a line impedance stabilization network (LISN). Other support units were connected to the power mains through another LISN. The two LISNs provide 50 ohm/ 50uH of coupling impedance for the measuring instrument.
- b. Both lines of the power mains connected to the EUT were checked for maximum conducted interference.
- c. The frequency range from 150kHz to 30MHz was searched. Emission levels under (Limit - 20dB) was not recorded.

NOTE: All modes of operation were investigated and the worst-case emissions are reported.

4.2.4 DEVIATION FROM TEST STANDARD

No deviation.

4.2.5 TEST SETUP

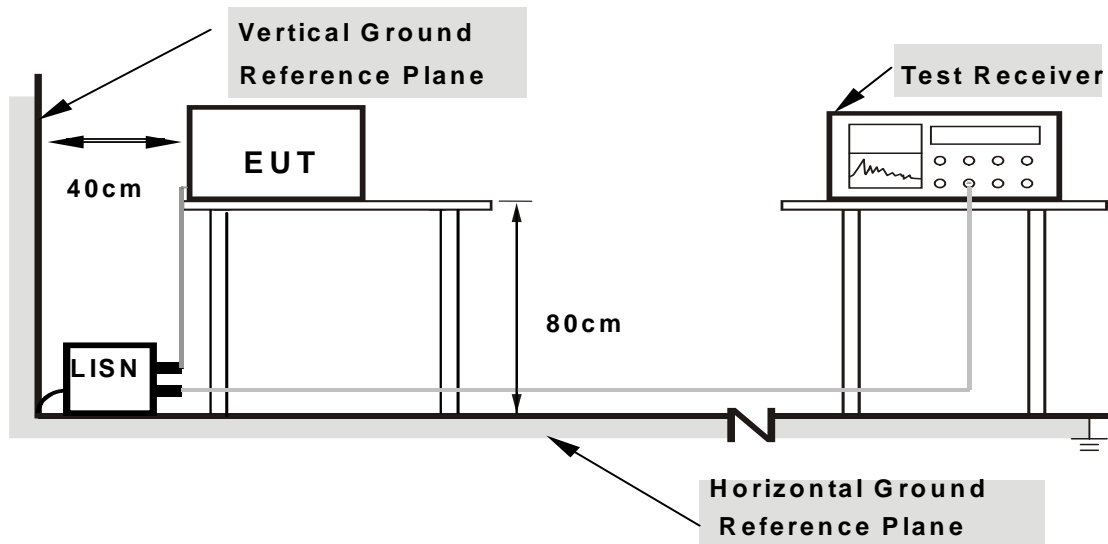

- Note:**
1. Support units were connected to second LISN.
 2. Both of LISNs (AMN) are 80 cm from EUT and at least 80 from other units and other metal planes

For the actual test configuration, please refer to the attached file (Test Setup Photo).

4.2.6 EUT OPERATING CONDITIONS

Same as 4.1.6.

4.2.7 TEST RESULTS

CONDUCTED WORST-CASE DATA : DRAFT 802.11n (40MHz) OFDM MODULATION

EUT TEST CONDITION		MEASUREMENT DETAIL	
CHANNEL	Channel 4	PHASE	Line 1
MODULATION TYPE	BPSK	INPUT POWER (SYSTEM)	120Vac, 60Hz
TRANSFER RATE	15.0Mbps	6dB BANDWIDTH	9kHz
ENVIRONMENTAL CONDITIONS	20deg. C, 60%RH, 1027hPa	TESTED BY	Match Tsui

No	Freq. [MHz]	Corr. Factor (dB)	Reading Value [dB (uV)]		Emission Level [dB (uV)]		Limit [dB (uV)]		Margin (dB)	
			Q.P.	AV.	Q.P.	AV.	Q.P.	AV.	Q.P.	AV.
1	0.189	0.20	48.96	-	49.16	-	64.08	54.08	-14.92	-
2	0.314	0.20	40.56	-	40.76	-	59.86	49.86	-19.10	-
3	0.627	0.20	35.51	-	35.71	-	56.00	46.00	-20.29	-
4	3.333	0.33	39.06	-	39.39	-	56.00	46.00	-16.61	-
5	7.488	0.48	40.19	-	40.67	-	60.00	50.00	-19.33	-
6	19.814	1.00	55.48	41.89	56.48	42.89	60.00	50.00	-3.52	-7.11

- REMARKS:**
1. Q.P. and AV. are abbreviations of quasi-peak and average individually.
 2. "-": The Quasi-peak reading value also meets average limit and measurement with the average detector is unnecessary.
 3. The emission levels of other frequencies were very low against the limit.
 4. Margin value = Emission level - Limit value
 5. Correction factor = Insertion loss + Cable loss
 6. Emission Level = Correction Factor + Reading Value.

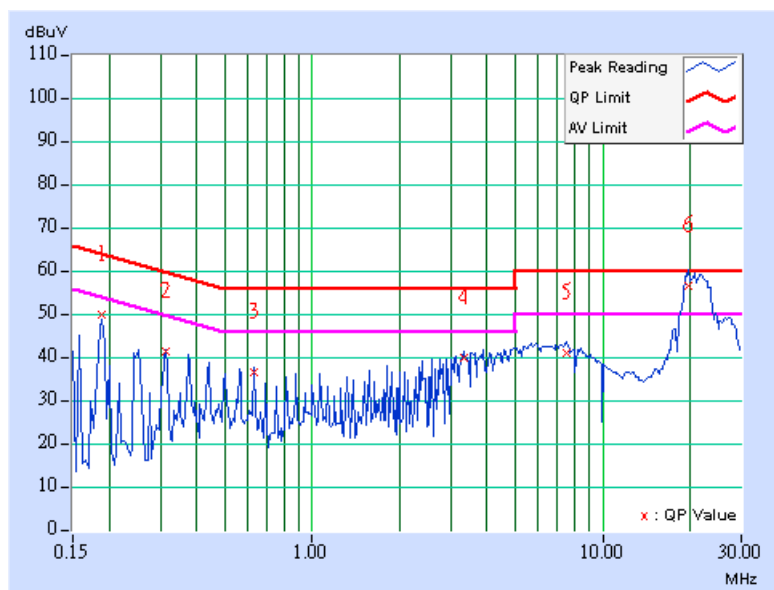



A D T

EUT TEST CONDITION		MEASUREMENT DETAIL	
CHANNEL	Channel 4	PHASE	Line 2
MODULATION TYPE	BPSK	INPUT POWER (SYSTEM)	120Vac, 60Hz
TRANSFER RATE	15.0Mbps	6dB BANDWIDTH	9kHz
ENVIRONMENTAL CONDITIONS	20deg. C, 60%RH, 1027hPa	TESTED BY	Match Tsui

No	Freq.	Corr. Factor	Reading Value		Emission Level		Limit		Margin	
			[dB (uV)]	[dB (uV)]	[dB (uV)]	[dB (uV)]	[dB (uV)]	[dB (uV)]	(dB)	(dB)
	[MHz]	(dB)	Q.P.	AV.	Q.P.	AV.	Q.P.	AV.	Q.P.	AV.
1	0.189	0.20	49.45	-	49.65	-	64.08	54.08	-14.43	-
2	0.377	0.20	46.00	-	46.20	-	58.35	48.35	-12.15	-
3	0.627	0.20	40.47	-	40.67	-	56.00	46.00	-15.33	-
4	0.886	0.20	44.35	-	44.55	-	56.00	46.00	-11.45	-
5	1.393	0.20	44.99	-	45.19	-	56.00	46.00	-10.81	-
6	20.110	0.51	51.37	35.18	51.88	35.69	60.00	50.00	-8.12	-14.31

- REMARKS:**
1. Q.P. and AV. are abbreviations of quasi-peak and average individually.
 2. "-": The Quasi-peak reading value also meets average limit and measurement with the average detector is unnecessary.
 3. The emission levels of other frequencies were very low against the limit.
 4. Margin value = Emission level - Limit value
 5. Correction factor = Insertion loss + Cable loss
 6. Emission Level = Correction Factor + Reading Value.

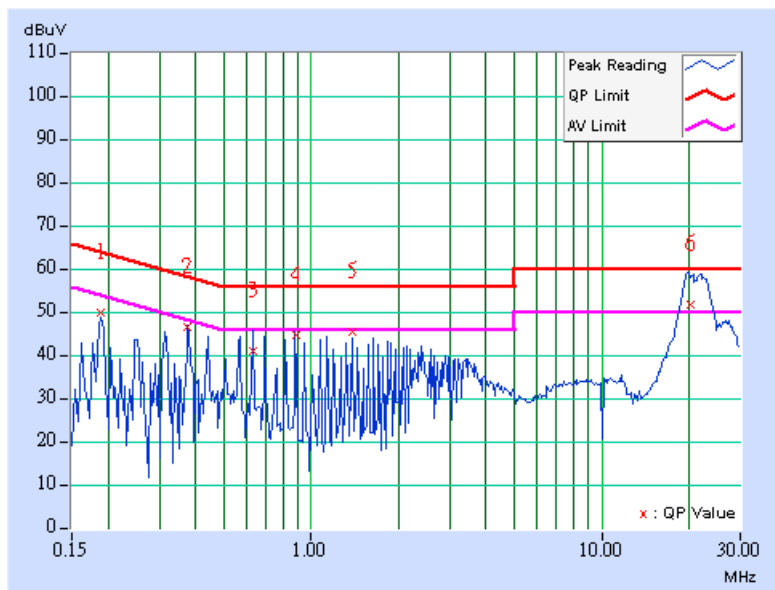



4.3 6dB BANDWIDTH MEASUREMENT

4.3.1 LIMITS OF 6dB BANDWIDTH MEASUREMENT

The minimum of 6dB Bandwidth Measurement is 0.5 MHz.

4.3.2 TEST INSTRUMENTS

DESCRIPTION & MANUFACTURER	MODEL NO.	SERIAL NO.	DATE OF CALIBRATION	DUE DATE OF CALIBRATION
R&S SPECTRUM ANALYZER	FSP40	100041	Apr. 22, 2008	Apr. 21, 2009

NOTE: The calibration interval of the above test instruments is 12 months and the calibrations are traceable to NML/ROC and NIST/USA.

4.3.3 TEST PROCEDURE

The transmitter output was connected to the spectrum analyzer through an attenuator. The bandwidth of the fundamental frequency was measured by spectrum analyzer with 100kHz RBW and 300kHz VBW. The 6dB bandwidth is defined as the total spectrum the power of which is higher than peak power minus 6dB.

4.3.4 DEVIATION FROM TEST STANDARD

No deviation.

4.3.5 TEST SETUP

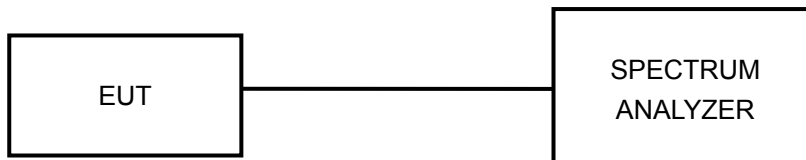

4.3.6 EUT OPERATING CONDITIONS

The software provided by client to enable the EUT under transmission condition continuously at lowest, middle and highest channel frequencies individually.

4.3.7 TEST RESULTS

802.11b DSSS MODULATION

MODULATION TYPE	DBPSK	TRANSFER RATE	1.0Mbps
INPUT POWER (SYSTEM)	120Vac, 60Hz	ENVIRONMENTAL CONDITIONS	25 deg.C, 65 %RH, 1009hPa
TESTED BY	Match Tsui		

CHANNEL	CHANNEL FREQUENCY (MHz)	6dB BANDWIDTH (MHz)		MINIMUM LIMIT (MHz)	PASS / FAIL
		CHAIN 0	CHAIN 1		
1	2412	12.11	12.11	0.5	PASS
6	2437	12.12	12.15	0.5	PASS
11	2462	12.16	12.08	0.5	PASS

FOR CHAIN 0: CH 1

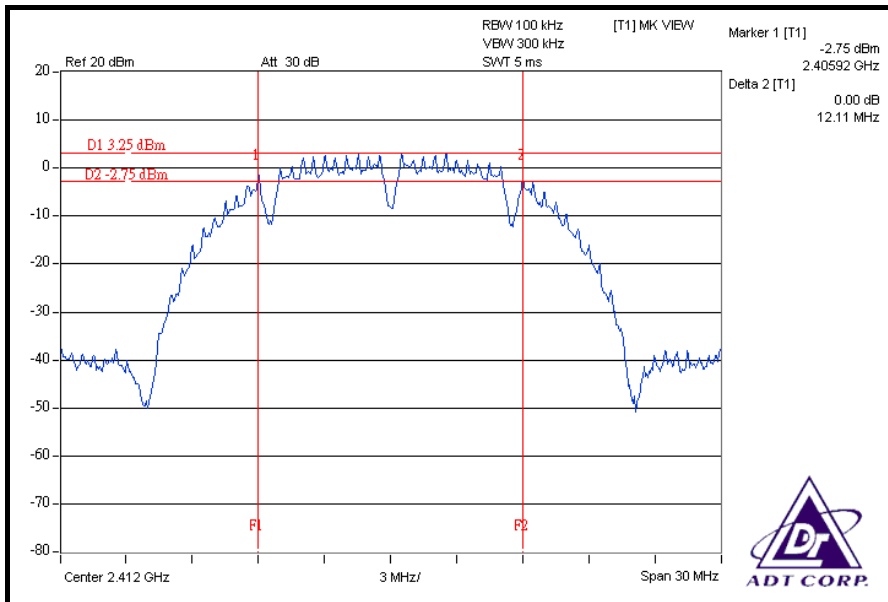

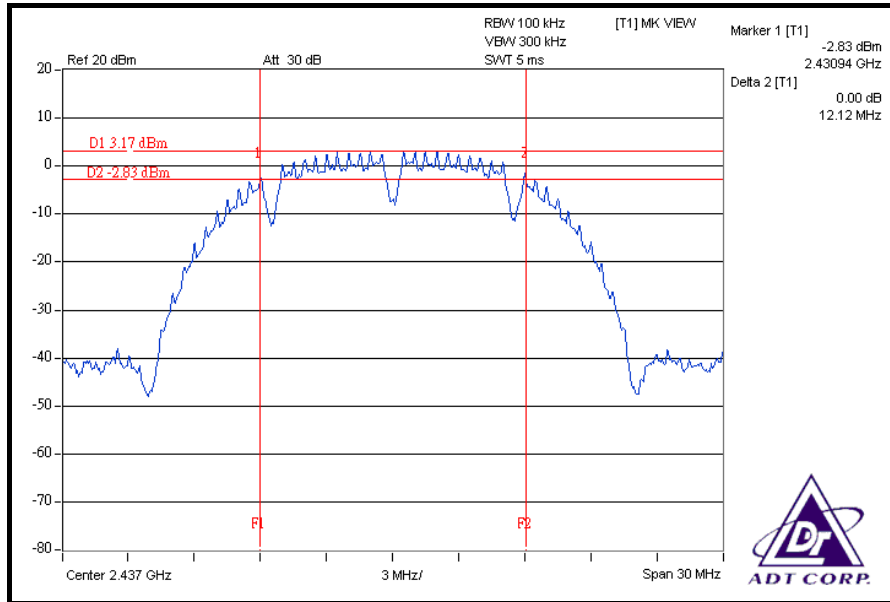
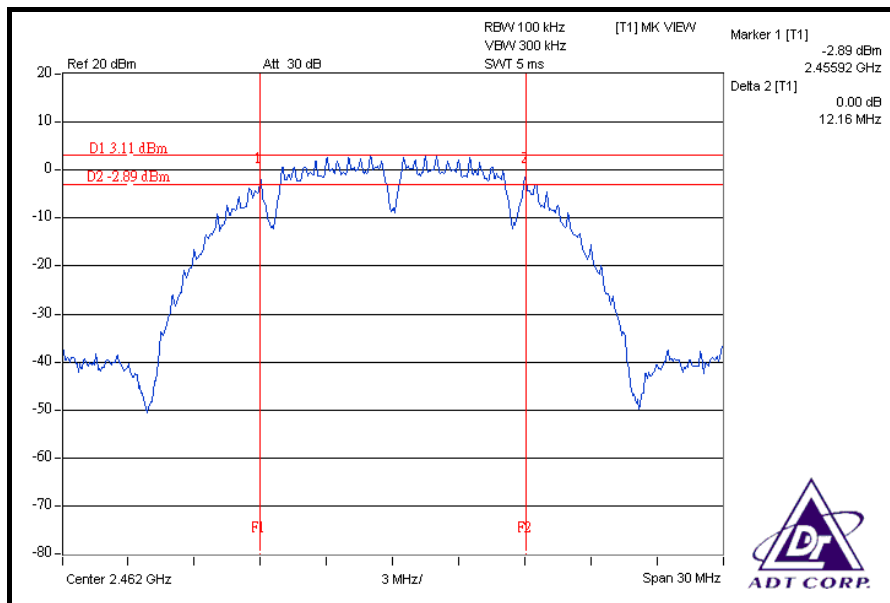
CH 6**CH 11**



A D T

FOR CHAIN 1: CH 1

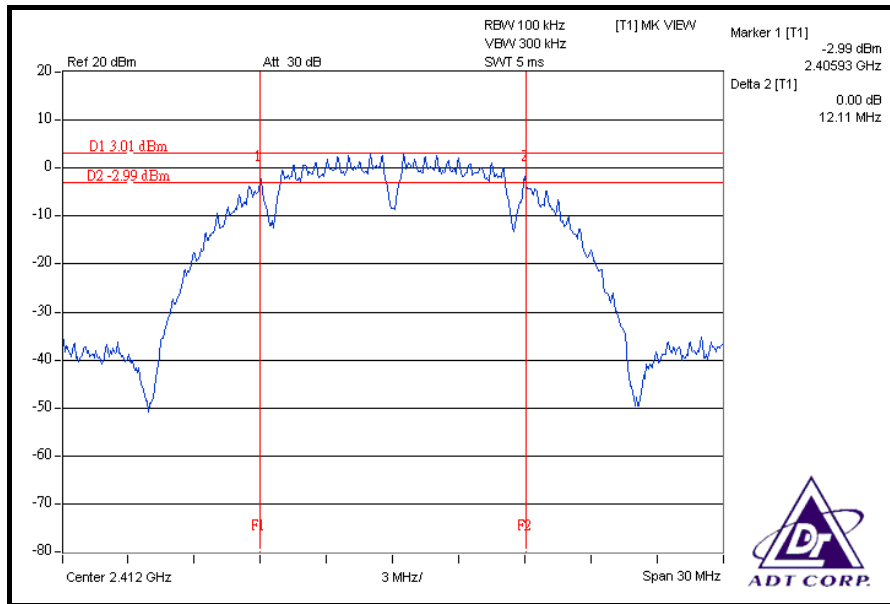

CH 6

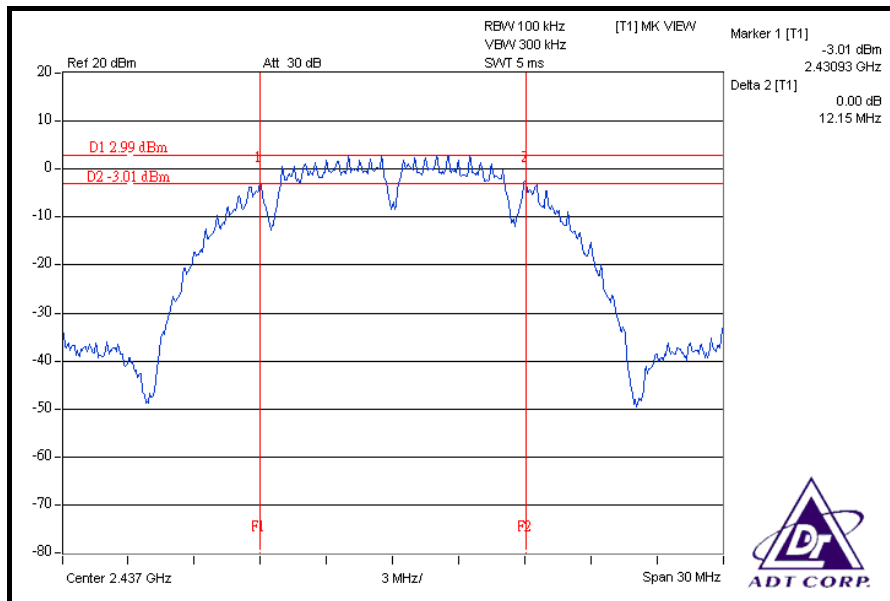



A D T

802.11g OFDM MODULATION

MODULATION TYPE	BPSK	TRANSFER RATE	6.0Mbps
INPUT POWER (SYSTEM)	120Vac, 60Hz	ENVIRONMENTAL CONDITIONS	25 deg.C, 65 %RH, 1009hPa
TESTED BY	Match Tsui		

CHANNEL	CHANNEL FREQUENCY (MHz)	6dB BANDWIDTH (MHz)		MINIMUM LIMIT (MHz)	PASS / FAIL
		CHAIN 0	CHAIN 1		
1	2412	16.47	16.43	0.5	PASS
6	2437	16.45	16.45	0.5	PASS
11	2462	16.43	16.42	0.5	PASS

FOR CHAIN 0: CH 1

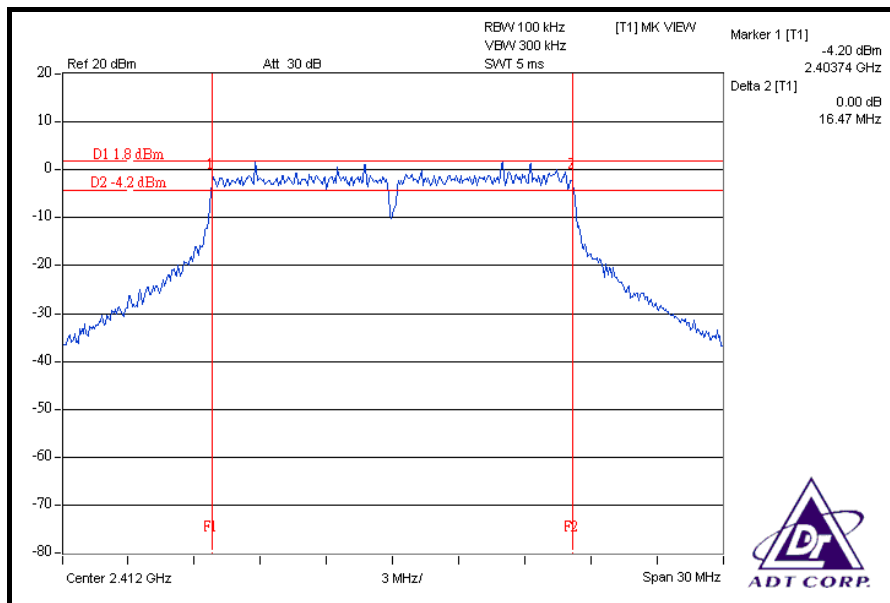

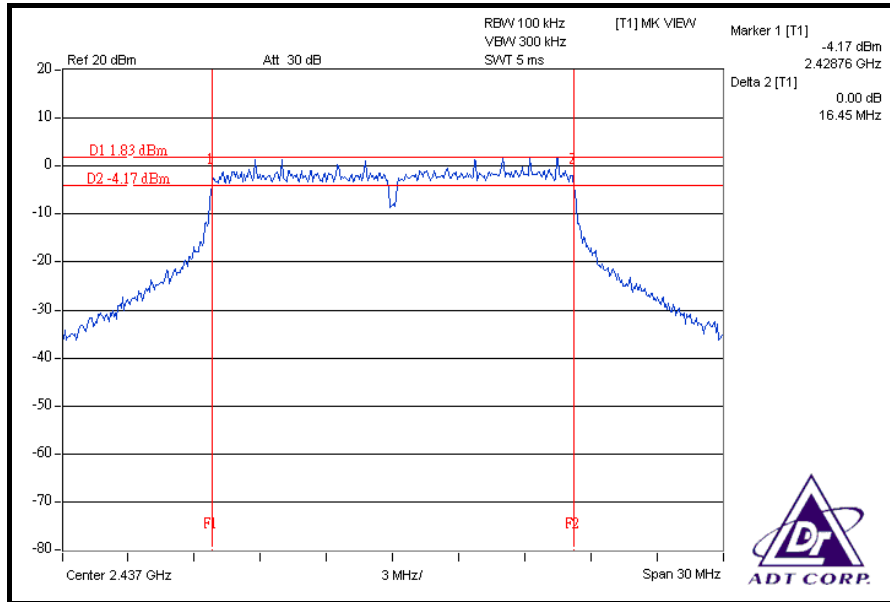
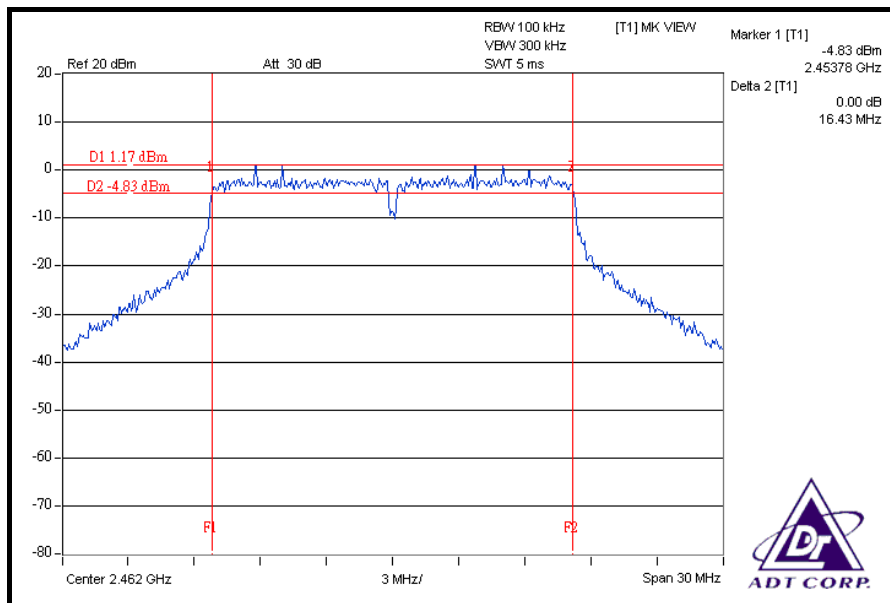
CH 6**CH 11**



A D T

FOR CHAIN 1: CH 1

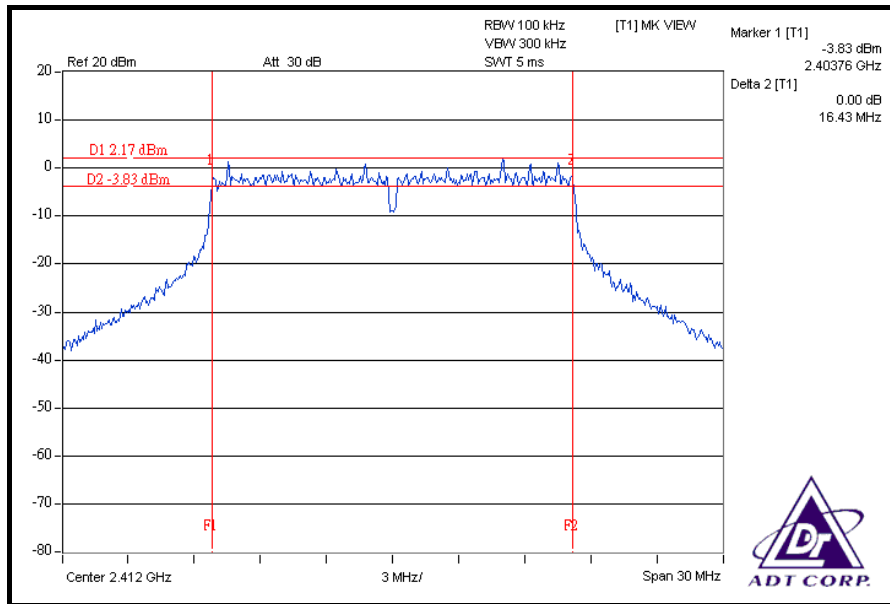

CH 6

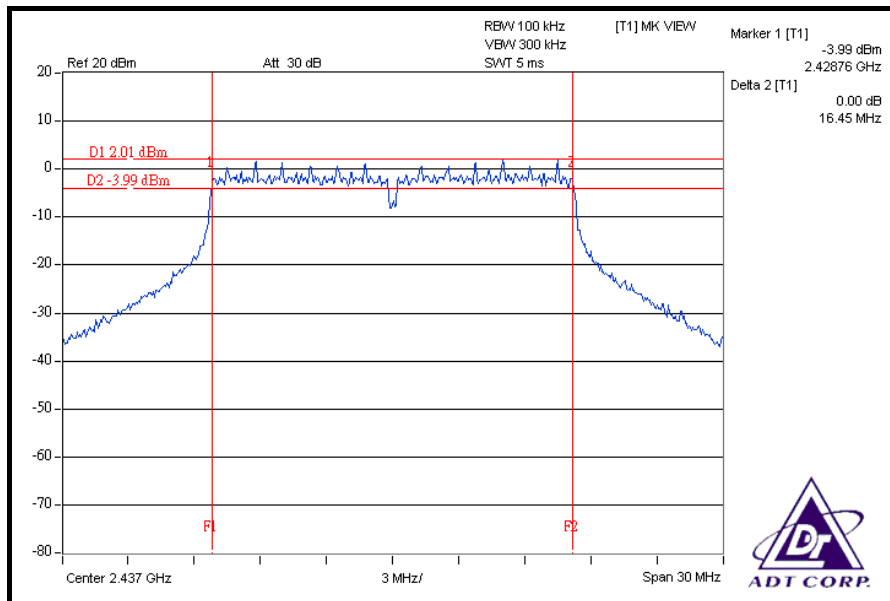



A D T

DRAFT 802.11n (20MHz) OFDM MODULATION

MODULATION TYPE	BPSK	TRANSFER RATE	7.2Mbps
INPUT POWER (SYSTEM)	120Vac, 60Hz	ENVIRONMENTAL CONDITIONS	25 deg.C, 65 %RH, 1009hPa
TESTED BY	Match Tsui		

CHANNEL	CHANNEL FREQUENCY (MHz)	6dB BANDWIDTH (MHz)		MINIMUM LIMIT (MHz)	PASS / FAIL
		CHAIN 0	CHAIN 1		
1	2412	17.66	17.70	0.5	PASS
6	2437	17.70	17.68	0.5	PASS
11	2462	17.71	17.71	0.5	PASS

FOR CHAIN 0: CH 1

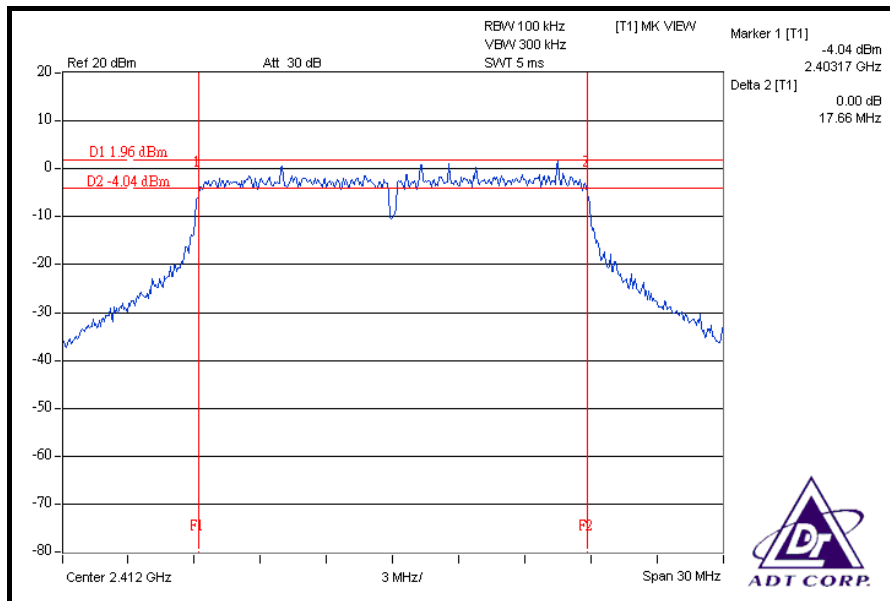

CH 6

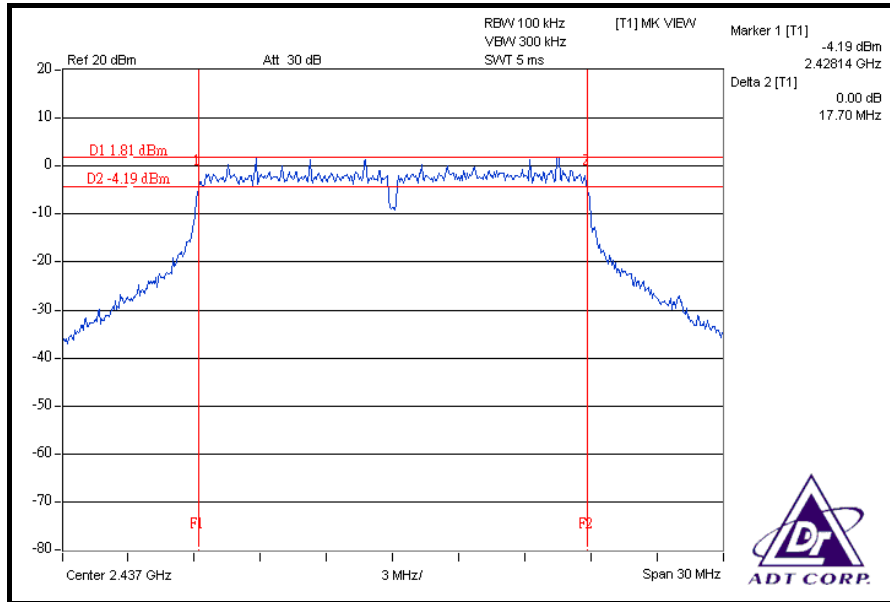

CH 11

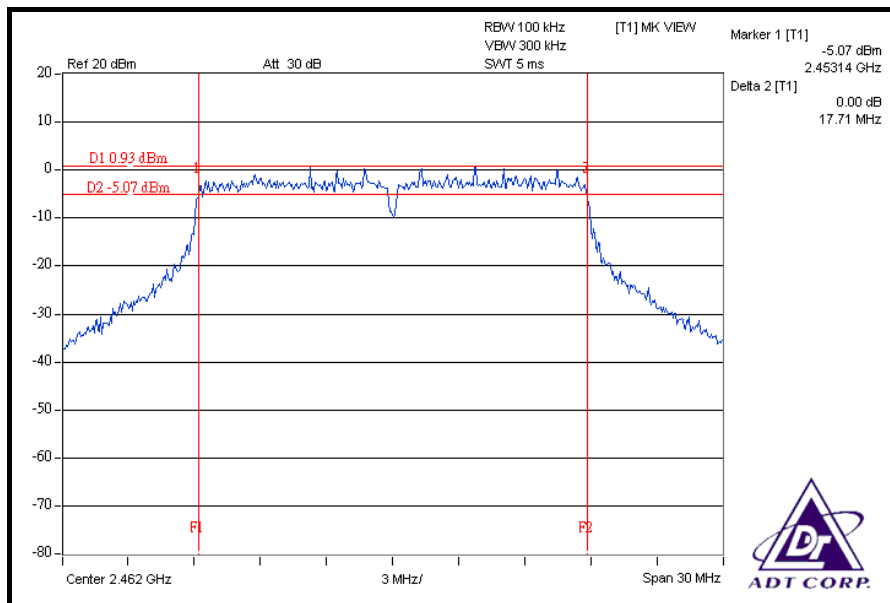

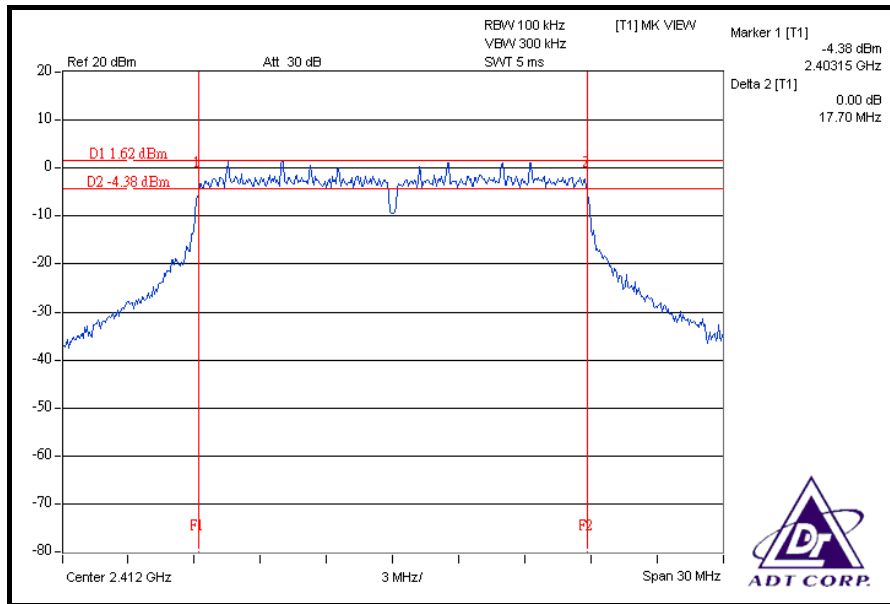
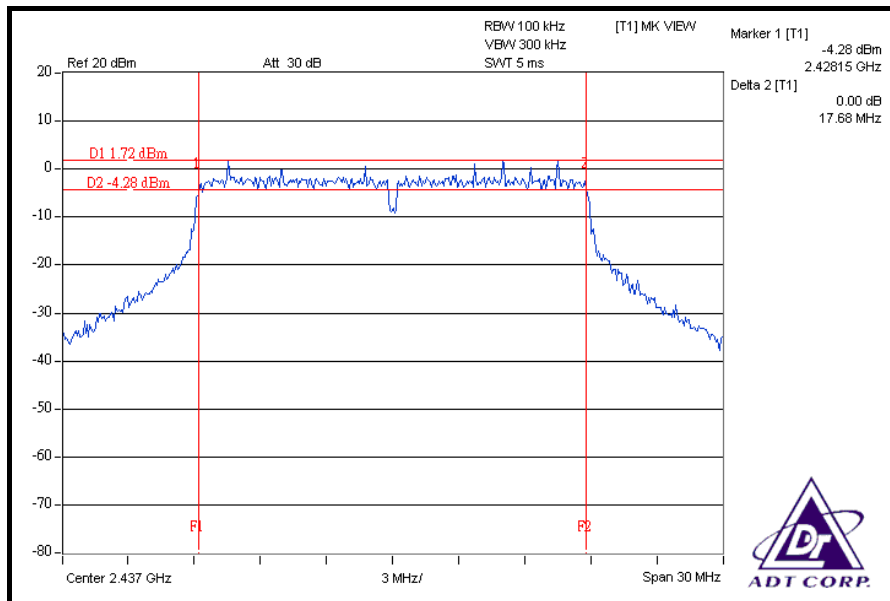
FOR CHAIN 1: CH 1**CH 6**



A D T

CH 11

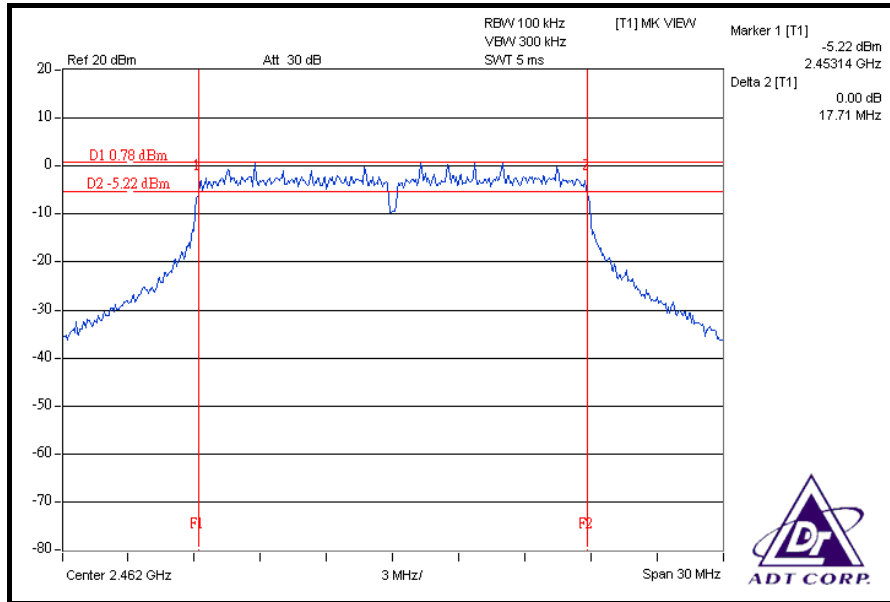



A D T

DRAFT 802.11n (40MHz) OFDM MODULATION

MODULATION TYPE	BPSK	TRANSFER RATE	15.0Mbps
INPUT POWER (SYSTEM)	120Vac, 60Hz	ENVIRONMENTAL CONDITIONS	25 deg.C, 65 %RH, 1009hPa
TESTED BY	Match Tsui		

CHANNEL	CHANNEL FREQUENCY (MHz)	6dB BANDWIDTH (MHz)		MINIMUM LIMIT (MHz)	PASS / FAIL
		CHAIN 0	CHAIN 1		
1	2422	36.45	36.46	0.5	PASS
4	2437	36.08	36.49	0.5	PASS
7	2452	36.47	36.60	0.5	PASS

FOR CHAIN 0: CH 1

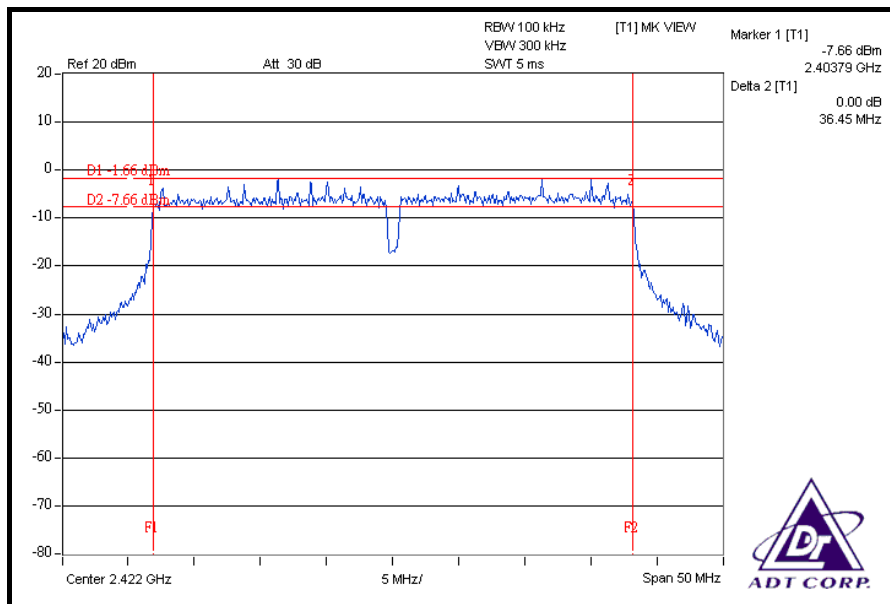



A D T

CH 4

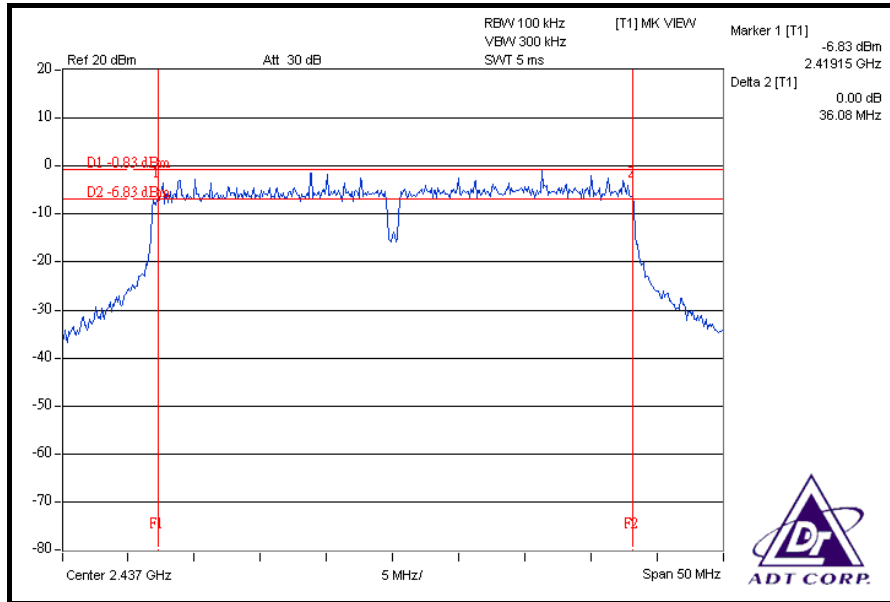

CH 7

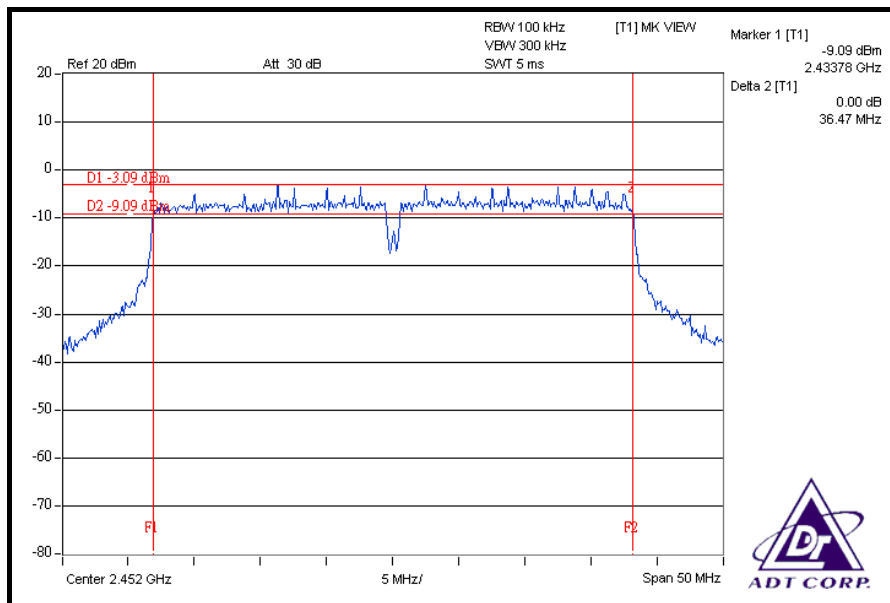

FOR CHAIN 1: CH 1

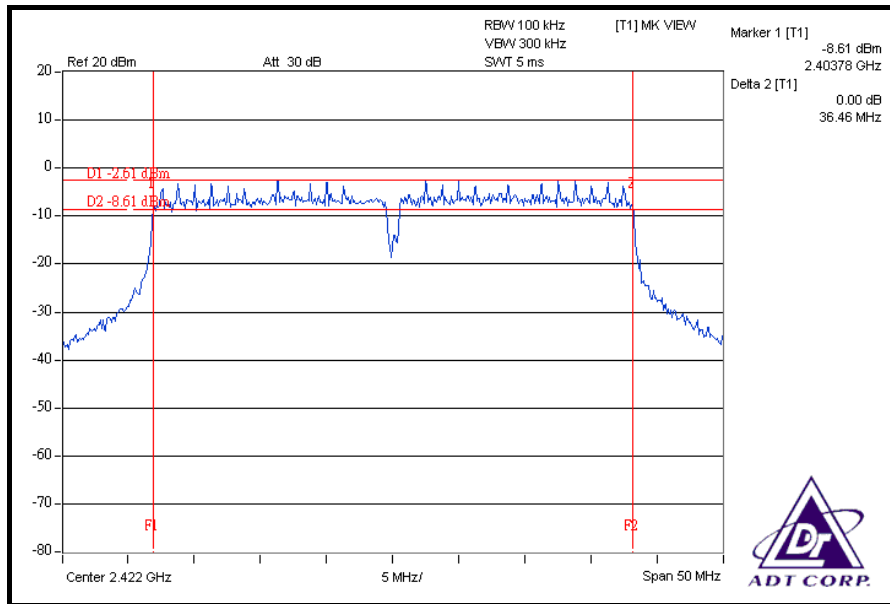

CH 4

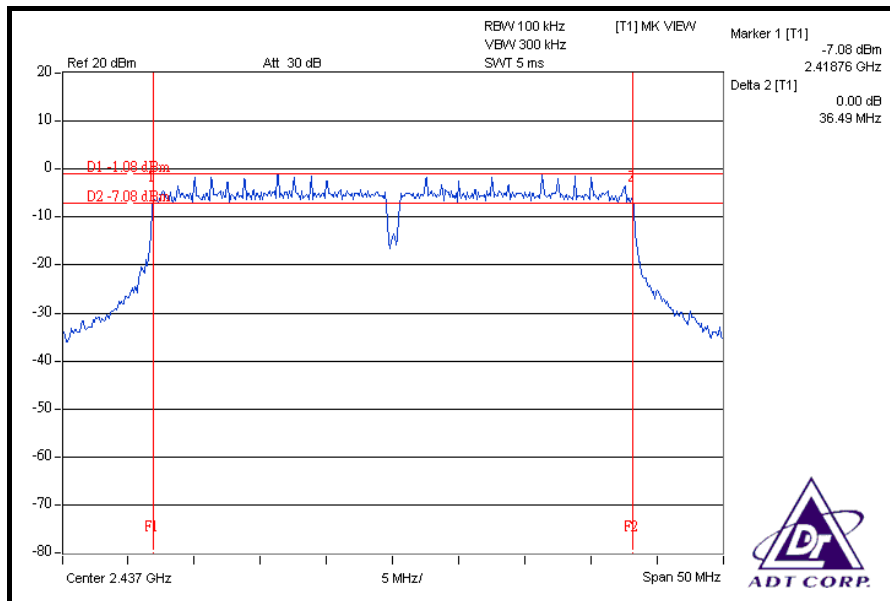



A D T

CH 7

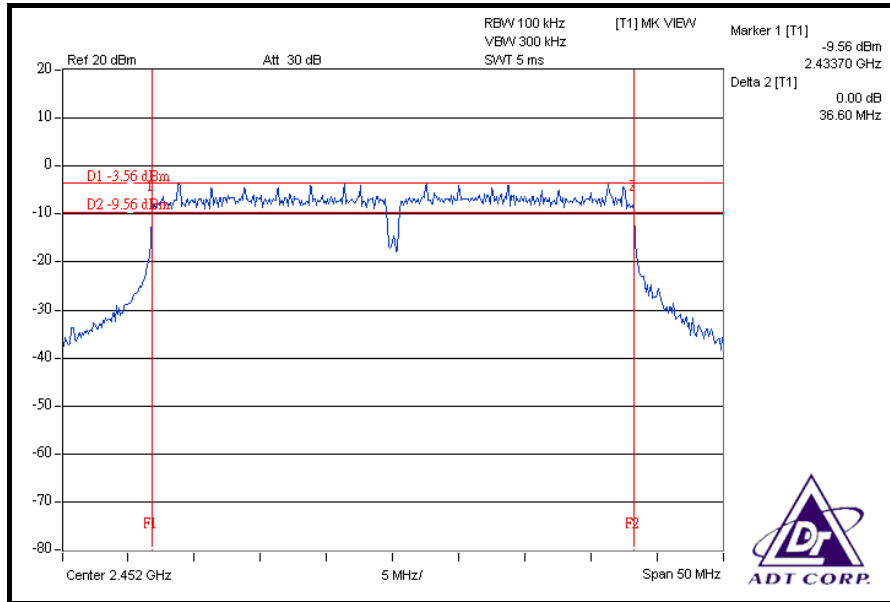

4.4 MAXIMUM PEAK OUTPUT POWER

4.4.1 LIMITS OF MAXIMUM PEAK OUTPUT POWER MEASUREMENT

The Maximum Peak Output Power Measurement is 30dBm.

4.4.2 TEST INSTRUMENTS

DESCRIPTION & MANUFACTURER	MODEL NO.	SERIAL NO.	DATE OF CALIBRATION	CALIBRATED UNTIL
High Speed Peak Power Meter	ML2495A	0824012	Aug. 04, 2008	Aug. 03, 2009
Power Sensor	MA2444B	0738138	Aug. 04, 2008	Aug. 03, 2009

NOTE:

1. The calibration interval of the above test instruments is 12 months and the calibrations are traceable to NML/ROC and NIST/USA.
2. Measurement Bandwidth of ML2495A is 65MHz greater than 6dB bandwidth of emission.

4.4.3 TEST PROCEDURES

A power sensor was used on the output port of the EUT. A power meter was used to read the response of the power sensor. Record the power level.

4.4.3 DEVIATION FROM TEST STANDARD

No deviation.

4.4.4 TEST SETUP

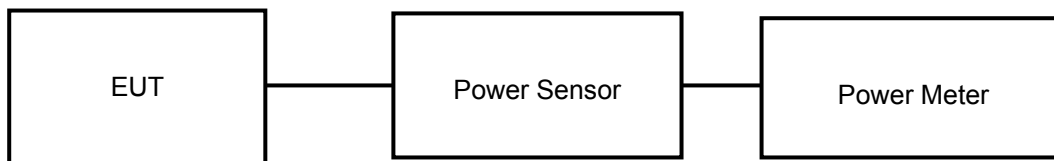

4.4.5 EUT OPERATING CONDITIONS

Same as Item 4.3.6.

4.4.6 TEST RESULTS

802.11b DSSS MODULATION

MODULATION TYPE	DBPSK	TRANSFER RATE	1.0Mbps
INPUT POWER (SYSTEM)	120Vac, 60Hz	ENVIRONMENTAL CONDITIONS	25 deg.C, 65 %RH, 1009hPa
TESTED BY	Match Tsui		

CHAN.	CHAN. FREQ. (MHz)	PEAK POWER OUTPUT (dBm)		TOTAL PEAK POWER (mW)	TOTAL PEAK POWER (dBm)	PEAK POWER LIMIT (dBm)	PASS / FAIL
		CHAIN 0	CHAIN 1				
1	2412	16.53	16.56	90.268	19.56	30	PASS
6	2437	16.59	16.57	90.998	19.59	30	PASS
11	2462	16.55	16.52	90.060	19.55	30	PASS

802.11g OFDM MODULATION

MODULATION TYPE	BPSK	TRANSFER RATE	6.0Mbps
INPUT POWER (SYSTEM)	120Vac, 60Hz	ENVIRONMENTAL CONDITIONS	25 deg.C, 65 %RH, 1009hPa
TESTED BY	Match Tsui		

CHAN.	CHAN. FREQ. (MHz)	PEAK POWER OUTPUT (dBm)		TOTAL PEAK POWER (mW)	TOTAL PEAK POWER (dBm)	PEAK POWER LIMIT (dBm)	PASS / FAIL
		CHAIN 0	CHAIN 1				
1	2412	23.08	23.05	405.072	26.08	30	PASS
6	2437	23.12	23.07	407.884	26.11	30	PASS
11	2462	22.59	22.14	345.233	25.38	30	PASS



A D T

DRAFT 802.11n (20MHz) OFDM MODULATION

MODULATION TYPE	BPSK	TRANSFER RATE	7.2Mbps
INPUT POWER (SYSTEM)	120Vac, 60Hz	ENVIRONMENTAL CONDITIONS	25 deg.C, 65 %RH, 1009hPa
TESTED BY	Match Tsui		

CHAN.	CHAN. FREQ. (MHz)	PEAK POWER OUTPUT (dBm)		TOTAL PEAK POWER (mW)	TOTAL PEAK POWER (dBm)	PEAK POWER LIMIT (dBm)	PASS / FAIL
		CHAIN 0	CHAIN 1				
1	2412	23.04	23.08	404.608	26.07	30	PASS
6	2437	23.07	23.11	407.413	26.10	30	PASS
11	2462	22.09	22.07	322.873	25.09	30	PASS

DRAFT 802.11n (40MHz) OFDM MODULATION

MODULATION TYPE	BPSK	TRANSFER RATE	15.0Mbps
INPUT POWER (SYSTEM)	120Vac, 60Hz	ENVIRONMENTAL CONDITIONS	25 deg.C, 65 %RH, 1009hPa
TESTED BY	Match Tsui		

CHAN.	CHAN. FREQ. (MHz)	PEAK POWER OUTPUT (dBm)		TOTAL PEAK POWER (mW)	TOTAL PEAK POWER (dBm)	PEAK POWER LIMIT (dBm)	PASS / FAIL
		CHAIN 0	CHAIN 1				
1	2422	24.08	23.59	484.418	26.85	30	PASS
4	2437	25.03	25.07	639.786	28.06	30	PASS
7	2452	22.55	22.54	359.360	25.56	30	PASS



4.5 POWER SPECTRAL DENSITY MEASUREMENT

4.5.1 LIMITS OF POWER SPECTRAL DENSITY MEASUREMENT

The Maximum of Power Spectral Density Measurement is 8dBm.

4.5.2 TEST INSTRUMENTS

DESCRIPTION & MANUFACTURER	MODEL NO.	SERIAL NO.	DATE OF CALIBRATION	DUE DATE OF CALIBRATION
R&S SPECTRUM ANALYZER	FSP40	100041	Apr. 22, 2008	Apr. 21, 2009

NOTE: The calibration interval of the above test instruments is 12 months and the calibrations are traceable to NML/ROC and NIST/USA.

4.5.3 TEST PROCEDURE

The transmitter output was connected to the spectrum analyzer through an attenuator, the bandwidth of the fundamental frequency was measured with the spectrum analyzer using 3kHz RBW and 30kHz VBW, set sweep time = span/3kHz. The power spectral density was measured and recorded.

The sweep time is allowed to be longer than span/3kHz for a full response of the mixer in the spectrum analyzer.

4.5.4 DEVIATION FROM TEST STANDARD

No deviation.

4.5.5 TEST SETUP

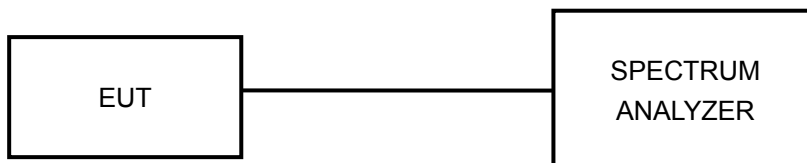

4.5.6 EUT OPERATING CONDITION

Same as Item 4.3.6.

4.5.7 TEST RESULTS

802.11b DSSS MODULATION

MODULATION TYPE	DBPSK	TRANSFER RATE	1.0Mbps
INPUT POWER (SYSTEM)	120Vac, 60Hz	ENVIRONMENTAL CONDITIONS	25 deg.C, 65 %RH, 1009hPa
TESTED BY	Match Tsui		

CHAN.	CHAN. FREQ. (MHz)	RF POWER LEVEL IN 3kHz BW (dBm)		TOTAL POWER DENSITY (mW)	TOTAL POWER DENSITY (dBm)	MAX. LIMIT (dBm)	PASS / FAIL
		CHAIN 0	CHAIN 1				
1	2412	-11.88	-11.38	0.138	-8.61	8	PASS
6	2437	-11.98	-11.20	0.139	-8.56	8	PASS
11	2462	-11.76	-11.23	0.142	-8.48	8	PASS

FOR CHAIN 0: CH 1

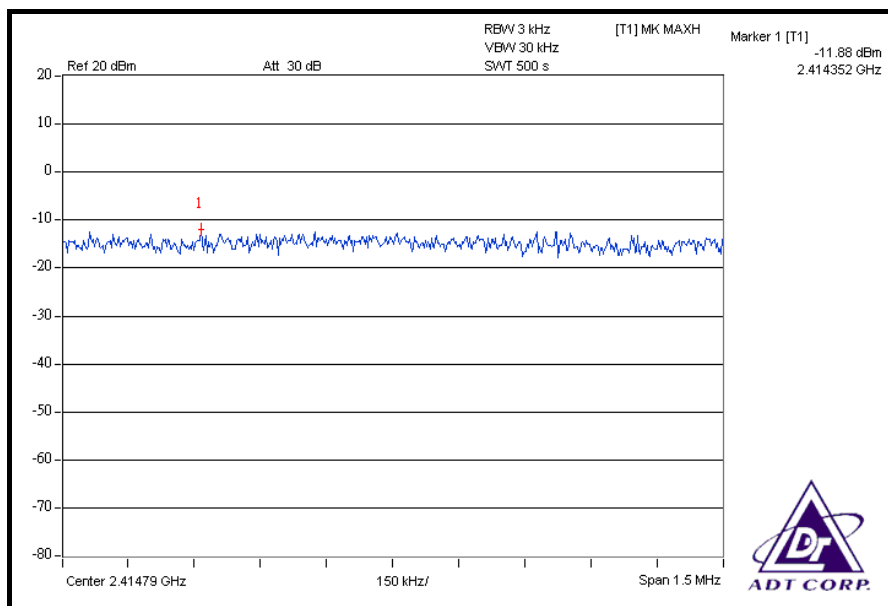



A D T

CH 11

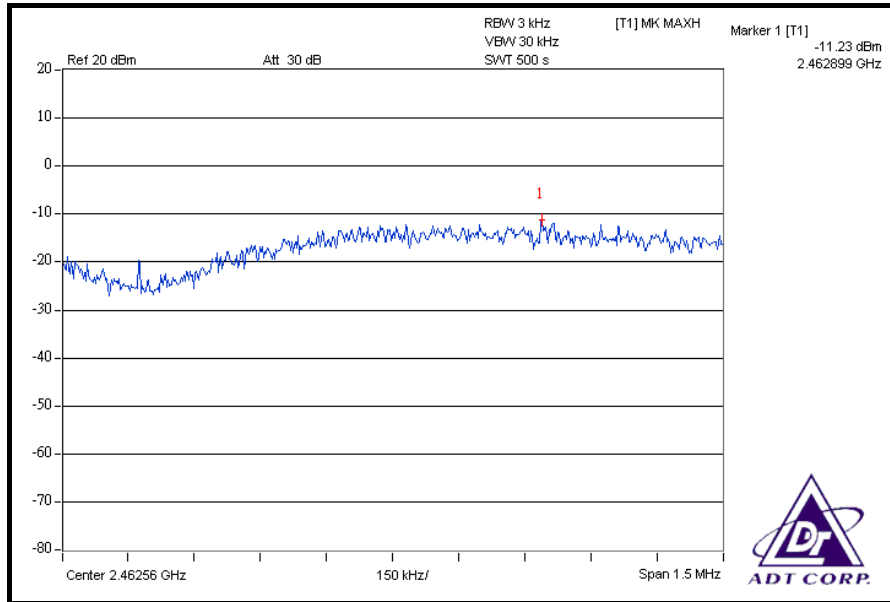



A D T

802.11g OFDM MODULATION

MODULATION TYPE	BPSK	TRANSFER RATE	6.0Mbps
INPUT POWER (SYSTEM)	120Vac, 60Hz	ENVIRONMENTAL CONDITIONS	25 deg.C, 63 %RH, 1008hPa
TESTED BY	Match Tsui		

CHAN.	CHAN. FREQ. (MHz)	RF POWER LEVEL IN 3kHz BW (dBm)		TOTAL POWER DENSITY (mW)	TOTAL POWER DENSITY (dBm)	MAX. LIMIT (dBm)	PASS / FAIL
		CHAIN 0	CHAIN 1				
1	2412	-12.24	-11.74	0.127	-8.97	8	PASS
6	2437	-12.21	-11.76	0.127	-8.97	8	PASS
11	2462	-12.91	-12.58	0.106	-9.73	8	PASS

FOR CHAIN 0: CH 1

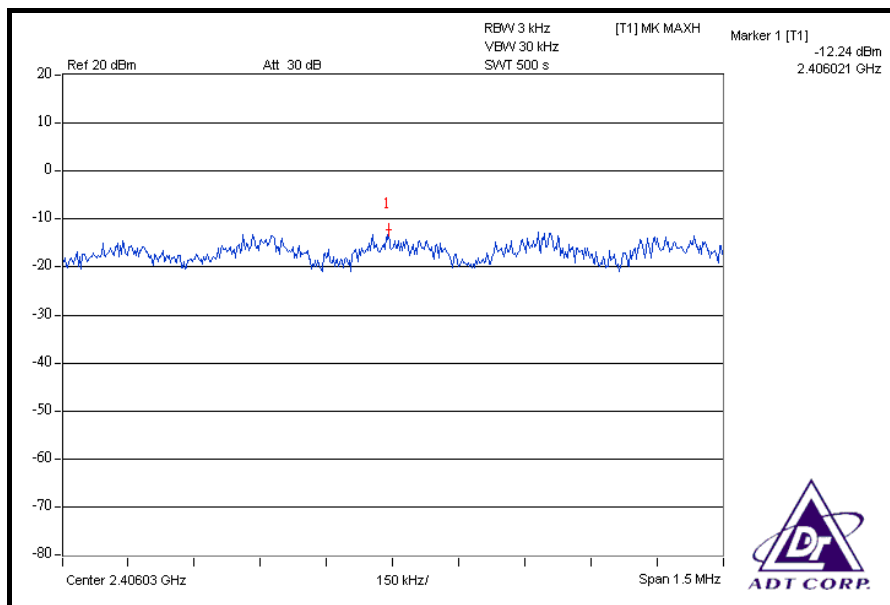



A D T

CH 6

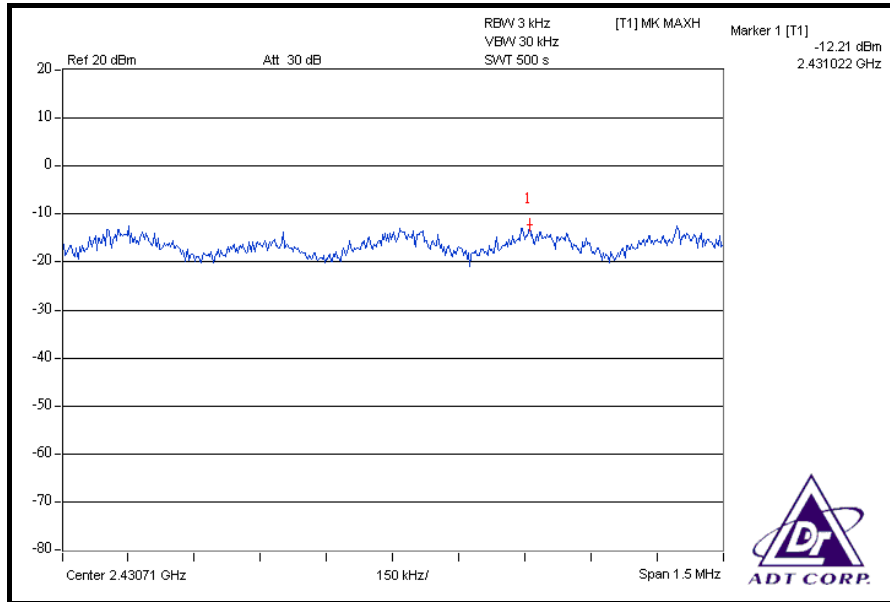

CH 11

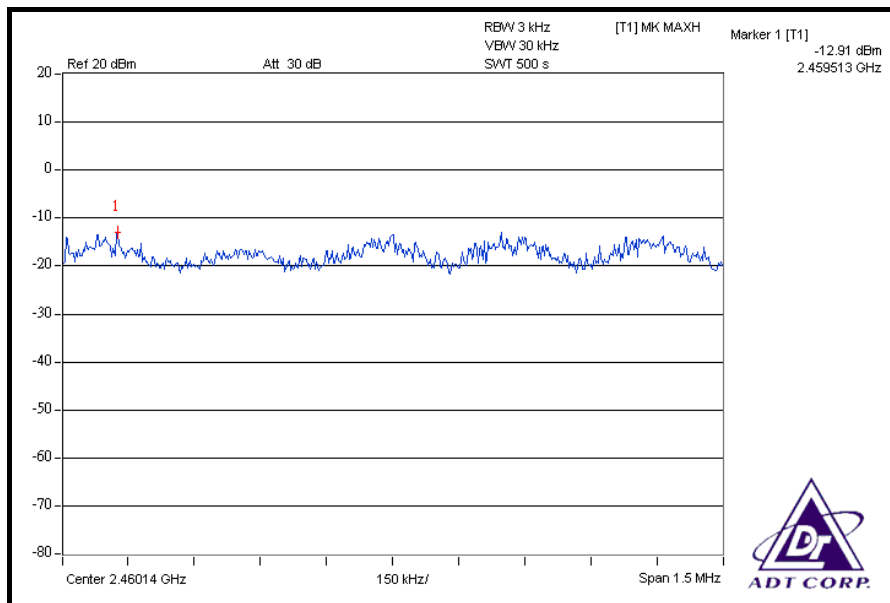



A D T

CH 11

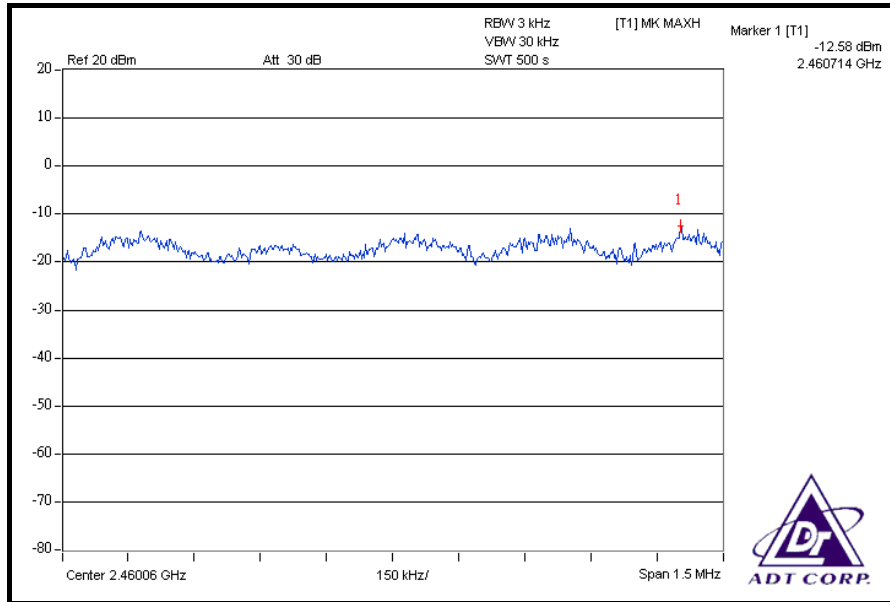



A D T

DRAFT 802.11n (20MHz) OFDM MODULATION

MODULATION TYPE	BPSK	TRANSFER RATE	7.2Mbps
INPUT POWER (SYSTEM)	120Vac, 60Hz	ENVIRONMENTAL CONDITIONS	25 deg.C, 63 %RH, 1008hPa
TESTED BY	Match Tsui		

CHAN.	CHAN. FREQ. (MHz)	RF POWER LEVEL IN 3kHz BW (dBm)		TOTAL POWER DENSITY (mW)	TOTAL POWER DENSITY (dBm)	MAX. LIMIT (dBm)	PASS / FAIL
		CHAIN 0	CHAIN 1				
1	2412	-12.08	-11.97	0.125	-9.01	8	PASS
6	2437	-12.04	-11.81	0.128	-8.91	8	PASS
11	2462	-13.05	-12.81	0.102	-9.92	8	PASS

FOR CHAIN 0: CH 1

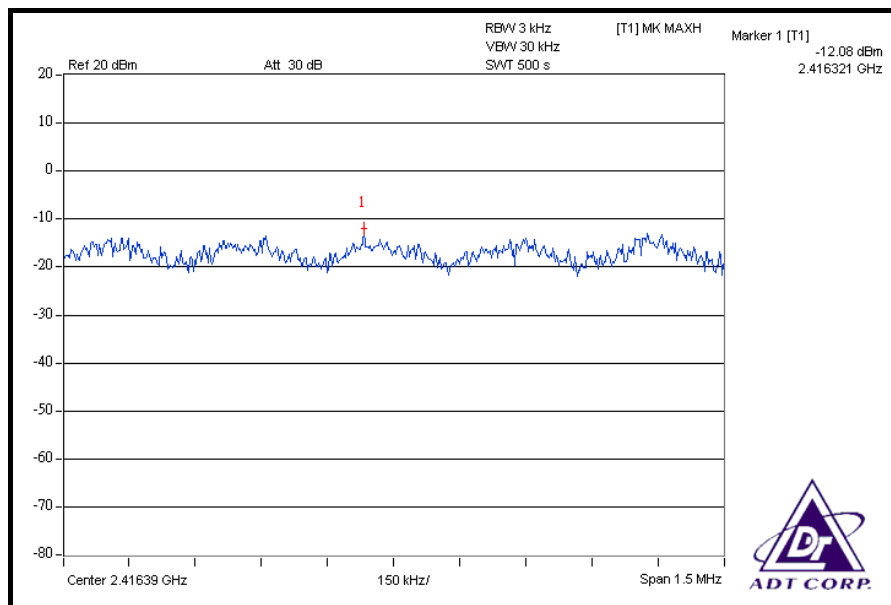



A D T

CH 6

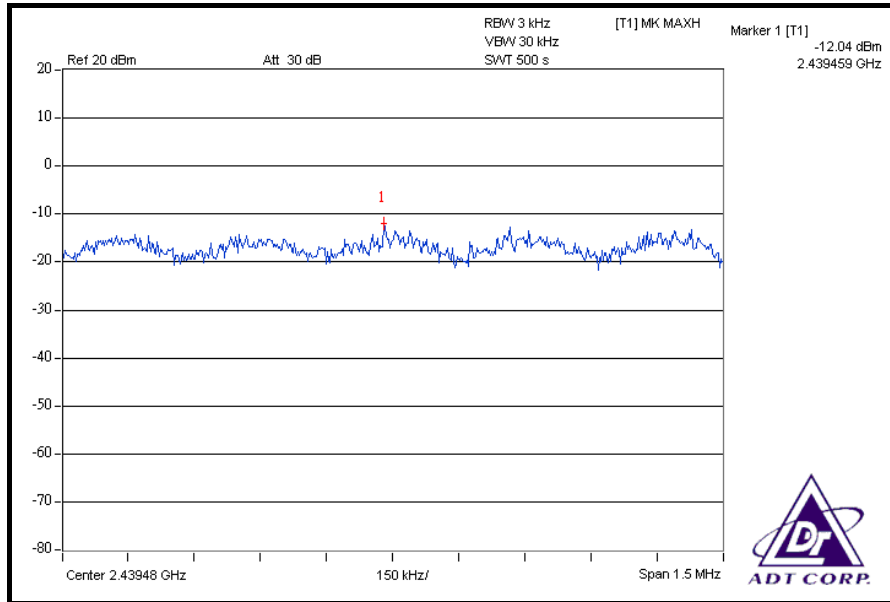

CH 11

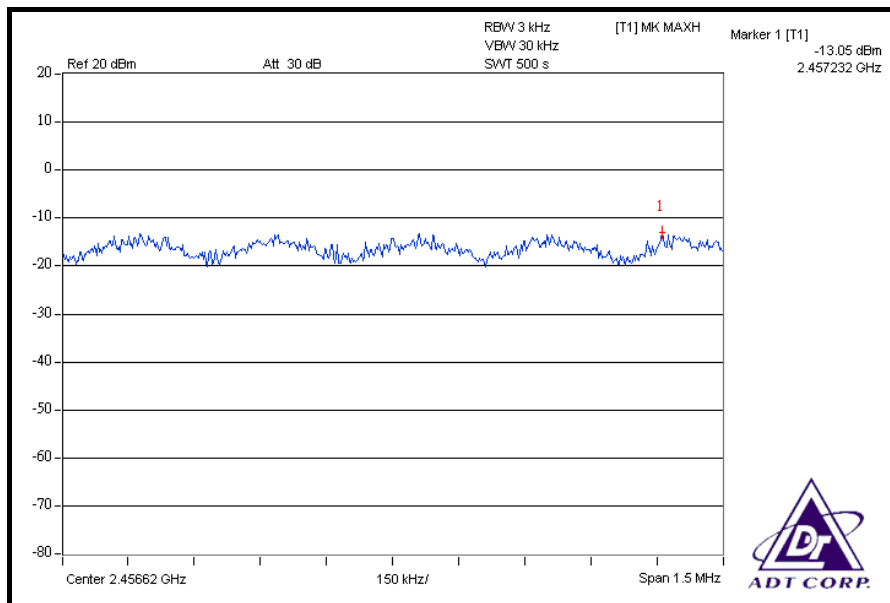



A D T

FOR CHAIN 1: CH 1

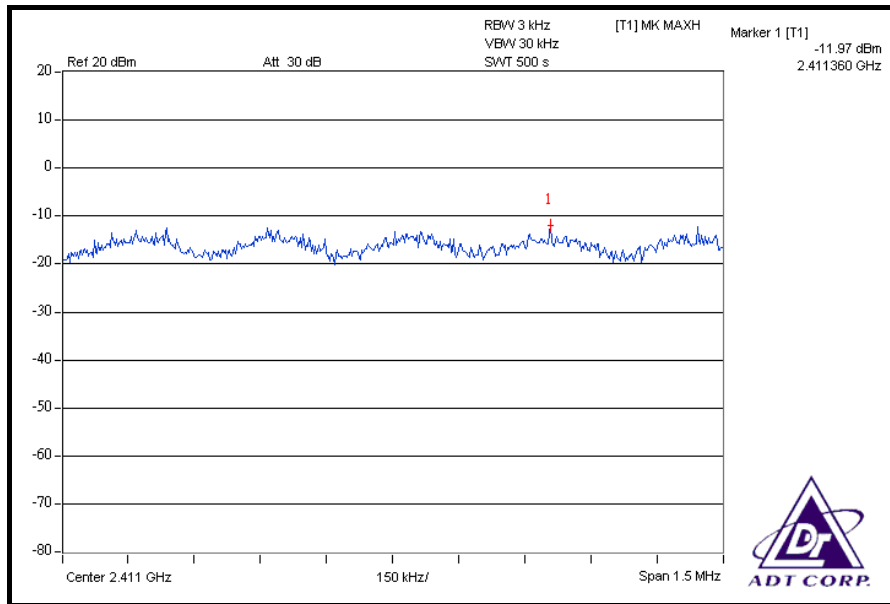

CH 6

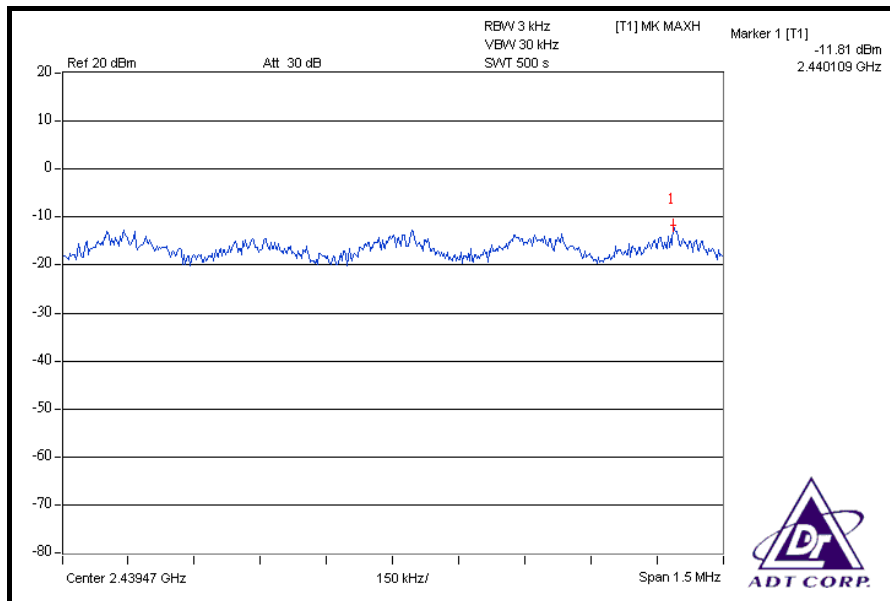



A D T

CH 11

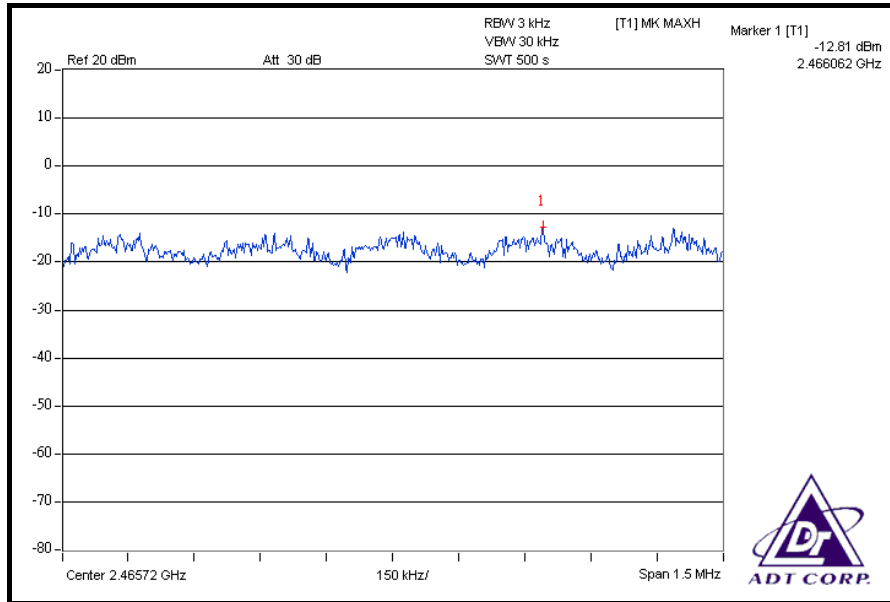



A D T

DRAFT 802.11n (40MHz) OFDM MODULATION

MODULATION TYPE	BPSK	TRANSFER RATE	15.0Mbps
INPUT POWER (SYSTEM)	120Vac, 60Hz	ENVIRONMENTAL CONDITIONS	25 deg.C, 65 %RH, 1009hPa
TESTED BY	Match Tsui		

CHAN.	CHAN. FREQ. (MHz)	RF POWER LEVEL IN 3kHz BW (dBm)		TOTAL POWER DENSITY (mW)	TOTAL POWER DENSITY (dBm)	MAX. LIMIT (dBm)	PASS / FAIL
		CHAIN 0	CHAIN 1				
1	2422	-15.75	-16.62	0.048	-13.15	8	PASS
4	2437	-14.60	-15.24	0.065	-11.90	8	PASS
7	2452	-17.10	-17.42	0.038	-14.25	8	PASS

FOR CHAIN 0: CH 1

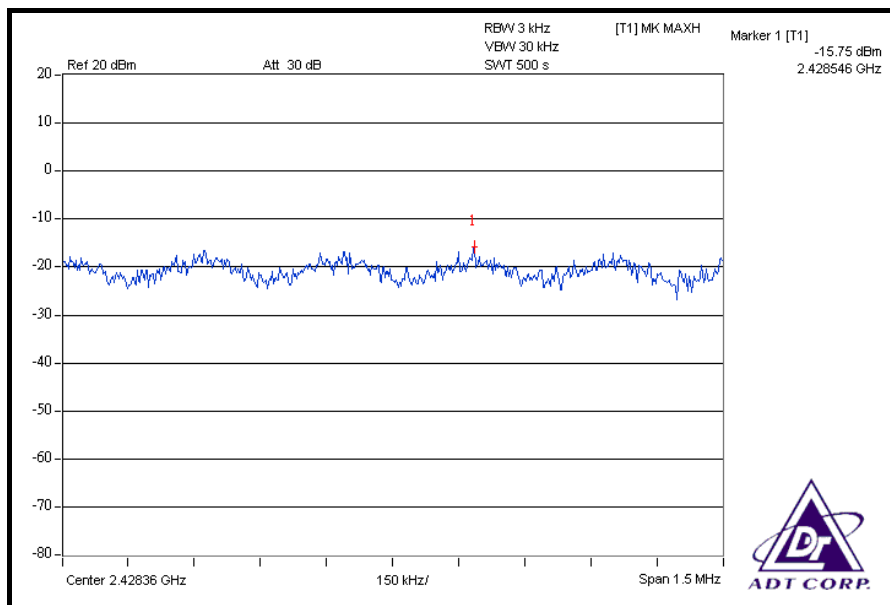



A D T

CH 4

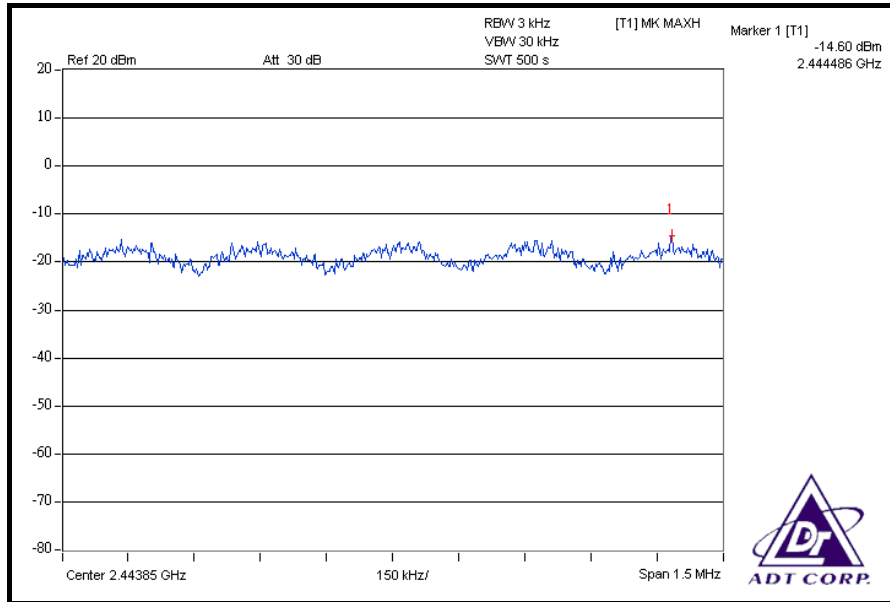

CH 7

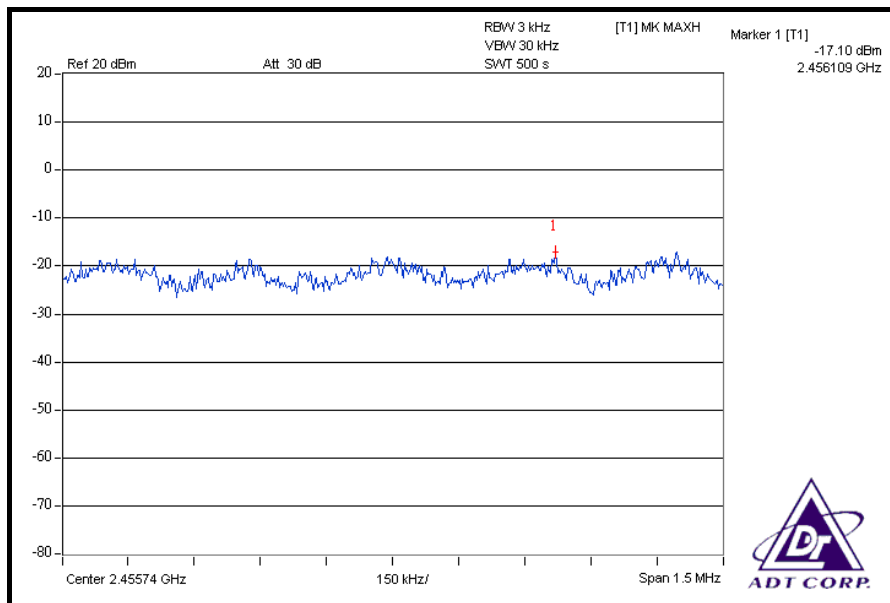



A D T

FOR CHAIN 1: CH 1

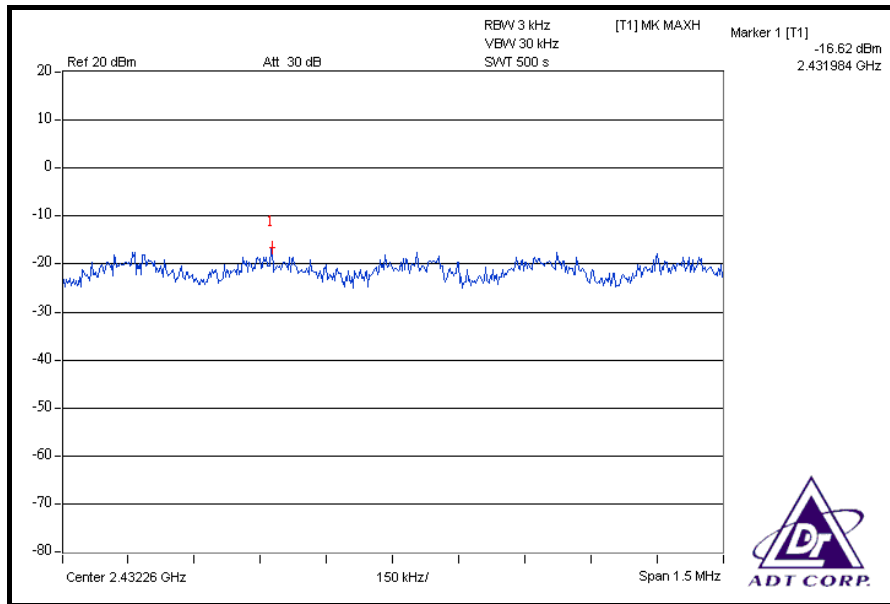

CH 4

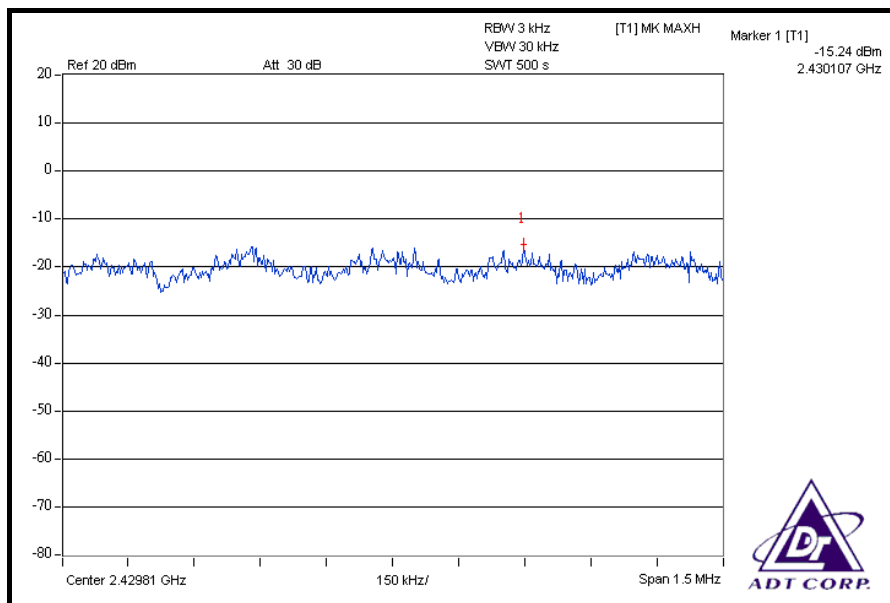



A D T

CH 7

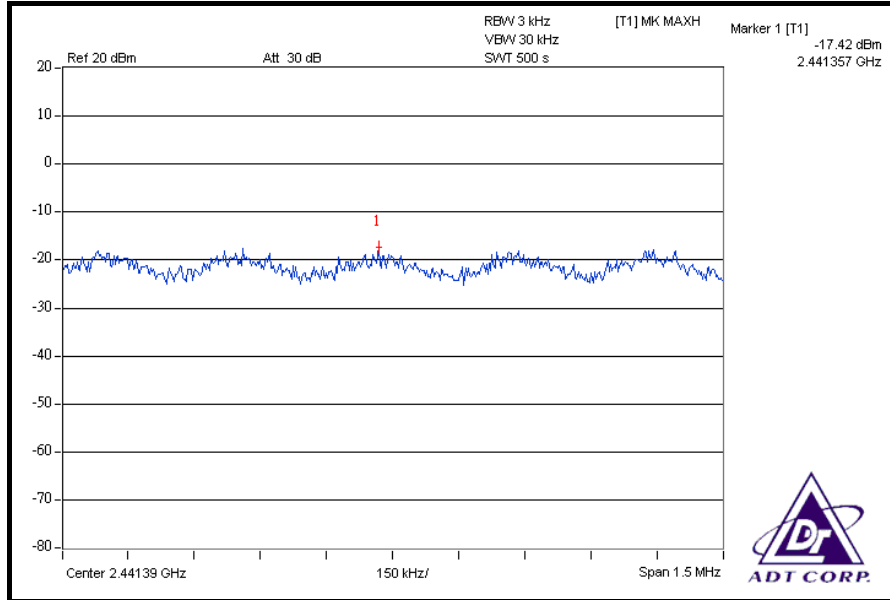

4.6 BAND EDGES MEASUREMENT

4.6.1 LIMITS OF BAND EDGES MEASUREMENT

Below -20dB of the highest emission level of operating band (in 100kHz Resolution Bandwidth).

4.6.2 TEST INSTRUMENTS

DESCRIPTION & MANUFACTURER	MODEL NO.	SERIAL NO.	DATE OF CALIBRATION	DUE DATE OF CALIBRATION
Spectrum Analyzer ROHDE & SCHWARZ	FSP40	100039	Dec. 03, 2007	Dec. 02, 2008
HORN Antenna SCHWARZBECK	BBHA 9120D	9120D-408	Jan. 22, 2008	Jan. 21, 2009
HORN Antenna SCHWARZBECK	BBHA 9170	BBHA9170242	Jan. 07, 2008	Jan. 06, 2009
RF signal cable HUBER+SUHNNER	SUCOFLEX 104	274397/4	Nov. 08, 2007	Nov. 07, 2008
RF signal cable HUBER+SUHNNER	SUCOFLEX 104	283401/4	Nov. 08, 2007	Nov. 07, 2008
Software ADT.	ADT_Radiated_V7.6	NA	NA	NA
Antenna Tower inn-co GmbH	MA 4000	010303	NA	NA
Antenna Tower Controller inn-co GmbH	CO2000	019303	NA	NA
Turn Table ADT.	TT100.	TT93021704	NA	NA
Turn Table Controller ADT.	SC100.	SC93021704	NA	NA

NOTE: The calibration interval of the above test instruments is 12 months and the calibrations are traceable to NML/ROC and NIST/USA.

4.6.3 TEST PROCEDURE

- a. The EUT was placed on the top of a rotating table 0.8 meters above the ground at a 3 meter semi-anechoic chamber. The table was rotated 360 degrees to determine the position of the highest radiation.
- b. The EUT was set 3 meters away from the interference-receiving antenna, which was mounted on the top of a variable-height antenna tower.
- c. The antenna is a broadband antenna, and its height is varied from one meter to four meters above the ground to determine the maximum value of the field strength. Both horizontal and vertical polarizations of the antenna are set to make the measurement.
- d. For each suspected emission, the EUT was arranged to its worst case and then the antenna was tuned to heights from 1 meter to 4 meters and the rotatable table was turned from 0 degrees to 360 degrees to find the maximum reading.
- e. Set both RBW and VBW of spectrum analyzer to 100kHz and 300kHz with suitable frequency span including 100MHz bandwidth from band edge. The band edges was measured and recorded.

The spectrum plots (Peak RBW = 100kHz, VBW = 300kHz) are attached on the following pages.

NOTE: The resolution bandwidth of test receiver/spectrum analyzer is 1MHz and the video bandwidth is 10Hz for Average detection (AV) at frequency above 1GHz.

4.6.4 DEVIATION FROM TEST STANDARD

No deviation.

4.6.5 EUT OPERATING CONDITION

Same as Item 4.3.6.

4.6.6 TEST RESULTS

The spectrum plots are attached on the following pages. D1 line indicates the highest level, and D2 line indicates the 20dB offset below D1. It shows compliance with the requirement in part 15.247(d).

802.11b DSSS MODULATION

NOTE 1: The band edge emission plot on the next page shows 51.51dBc between carrier maximum power and local maximum emission in restrict band (2.34780GHz). The emission of carrier strength list in the test result of channel 1 at the item 4.1.7 is 110.13dBuV/m (Peak), so the maximum field strength in restrict band is $110.13 - 51.51 = 58.62$ dBuV/m which is under 74dBuV/m limit.

The band edge emission plot on the next page shows 64.67dBc between carrier maximum power and local maximum emission in restrict band (2.39000GHz). The emission of carrier strength list in the test result of channel 1 at the item 4.1.7 is 105.30dBuV/m (Average), so the maximum field strength in restrict band is $105.30 - 64.67 = 40.63$ dBuV/m which is under 54dBuV/m limit.

NOTE 2: The band edge emission plot on the next second page shows 52.94dBc between carrier maximum power and local maximum emission in restrict band (2.48350GHz). The emission of carrier strength list in the test result of channel 11 at the item 4.1.7 is 110.34dBuV/m (Peak), so the maximum field strength in restrict band is $110.34 - 52.94 = 57.40$ dBuV/m which is under 74dBuV/m limit.

The band edge emission plot on the next third page shows 61.80dBc between carrier maximum power and local maximum emission in restrict band (2.48350GHz). The emission of carrier strength list in the test result of channel 11 at the item 4.1.7 is 105.10dBuV/m (Average), so the maximum field strength in restrict band is $105.10 - 61.80 = 43.30$ dBuV/m which is under 54dBuV/m limit.



A D T

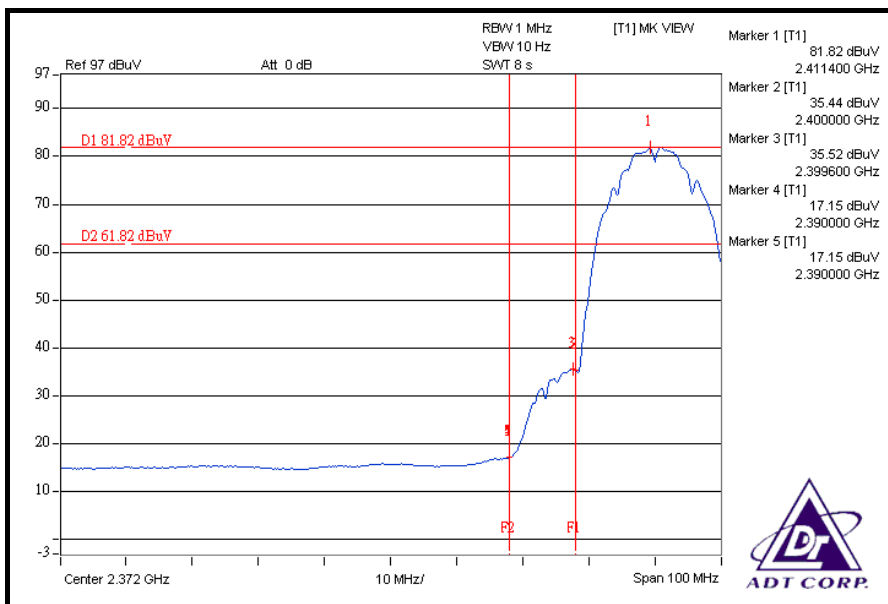
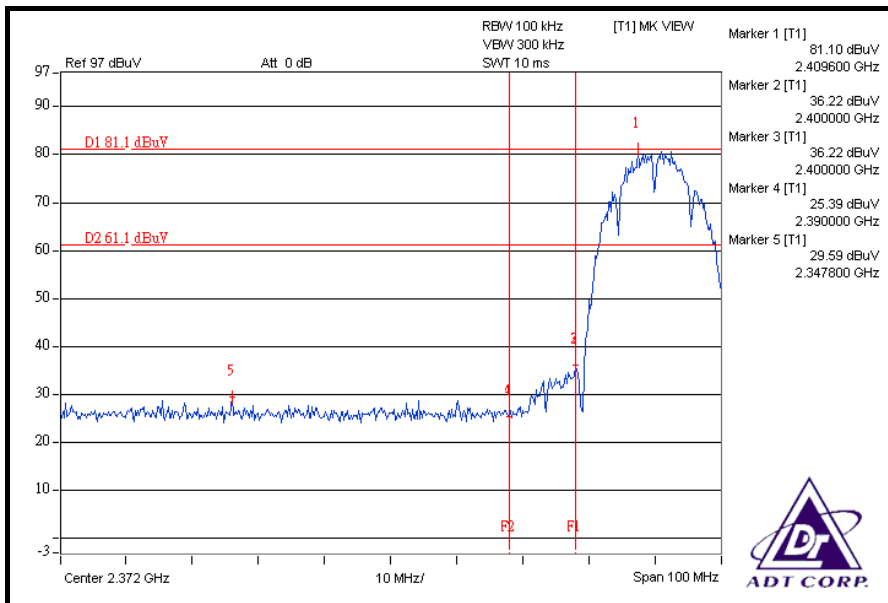



A D T

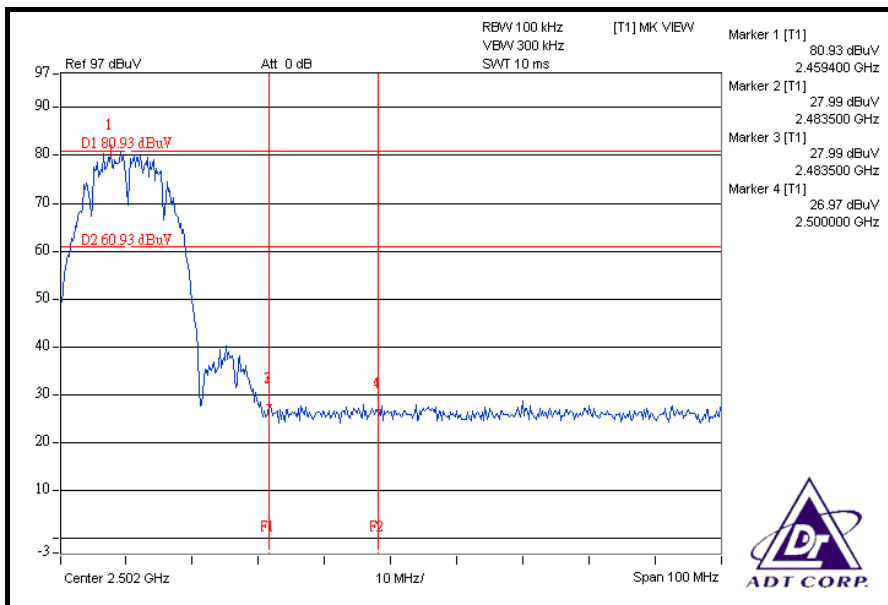
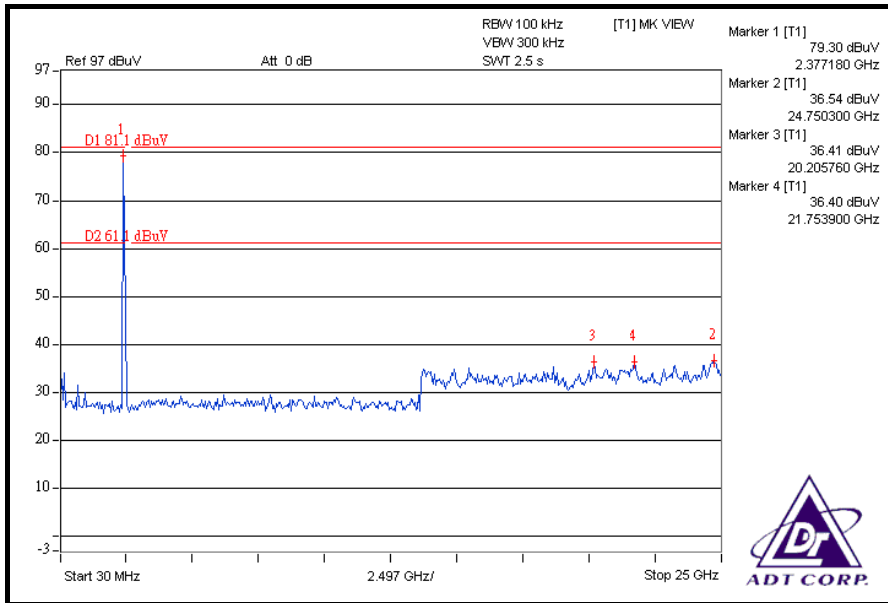



A D T

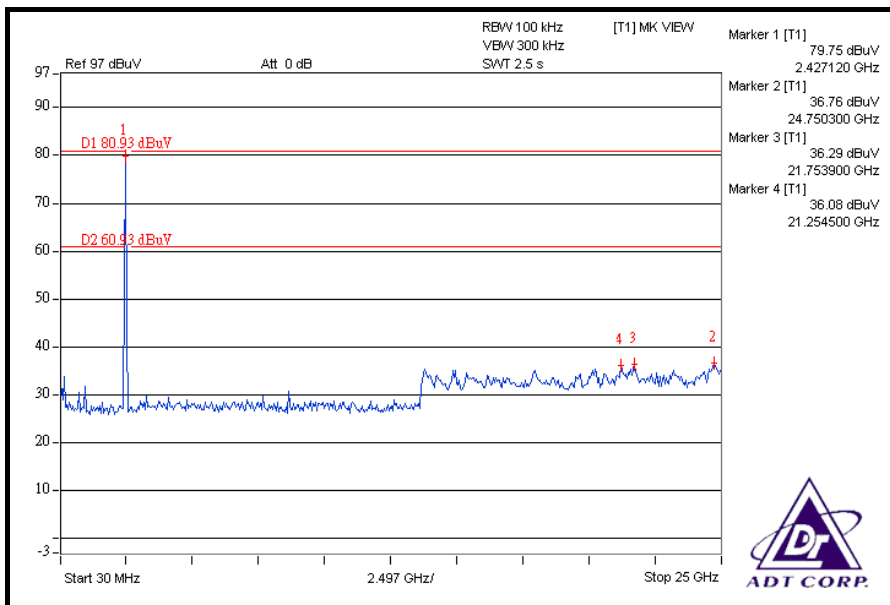
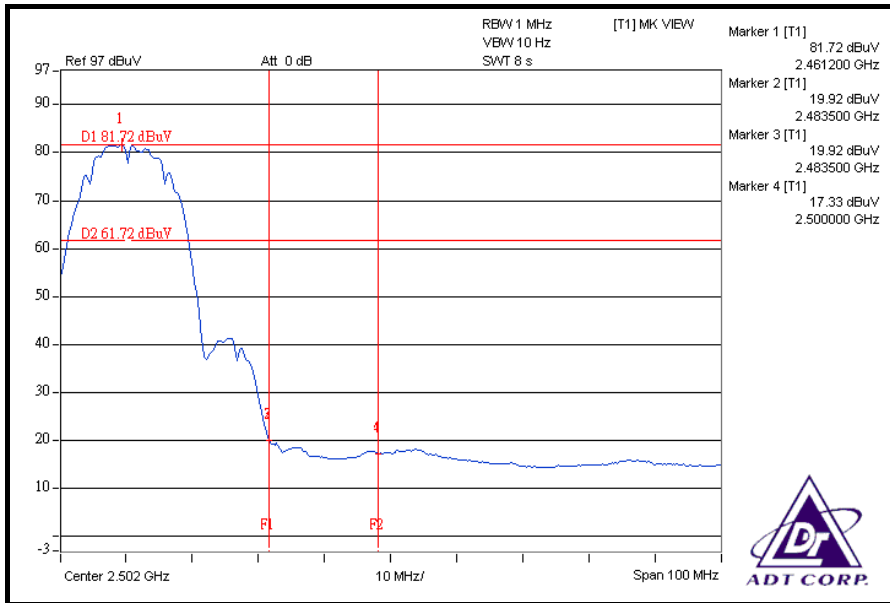

802.11g OFDM MODULATION

NOTE 1: The band edge emission plot on the next page shows 47.67dBc between carrier maximum power and local maximum emission in restrict band (2.33640GHz). The emission of carrier strength list in the test result of channel 1 at the item 4.1.7 is 112.24dBuV/m (Peak), so the maximum field strength in restrict band is $112.24 - 47.67 = 64.57$ dBuV/m which is under 74dBuV/m limit.

The band edge emission plot on the next page shows 56.53dBc between carrier maximum power and local maximum emission in restrict band (2.39000GHz). The emission of carrier strength list in the test result of channel 1 at the item 4.1.7 is 102.67dBuV/m (Average), so the maximum field strength in restrict band is $102.67 - 56.53 = 46.14$ dBuV/m which is under 54dBuV/m limit.

NOTE 2: The band edge emission plot on the next second page shows 45.91dBc between carrier maximum power and local maximum emission in restrict band (2.48440GHz). The emission of carrier strength list in the test result of channel 11 at the item 4.1.7 is 111.53dBuV/m (Peak), so the maximum field strength in restrict band is $111.53 - 45.91 = 65.62$ dBuV/m which is under 74dBuV/m limit.

The band edge emission plot on the next third page shows 51.36dBc between carrier maximum power and local maximum emission in restrict band (2.48350GHz). The emission of carrier strength list in the test result of channel 11 at the item 4.1.7 is 101.96dBuV/m (Average), so the maximum field strength in restrict band is $101.96 - 51.36 = 50.60$ dBuV/m which is under 54dBuV/m limit.



A D T

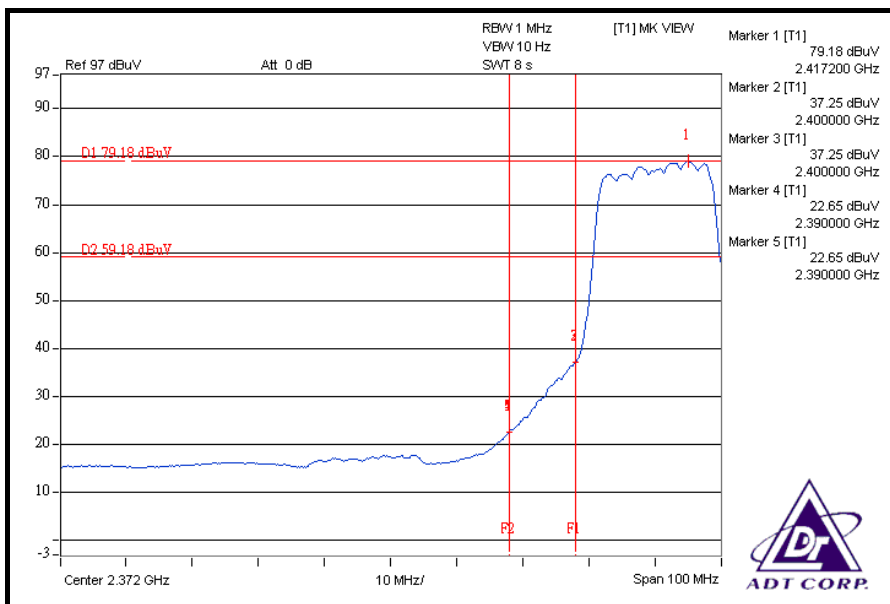
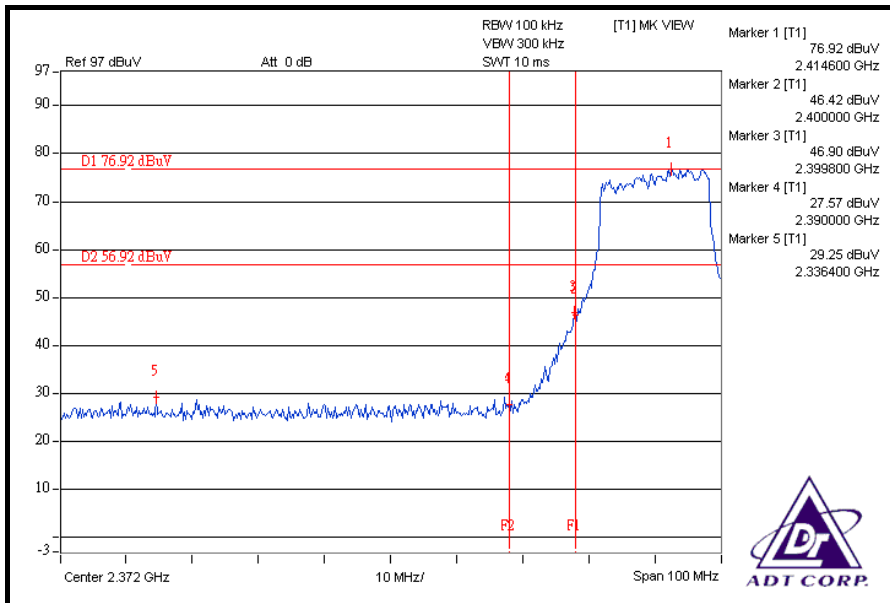



A D T

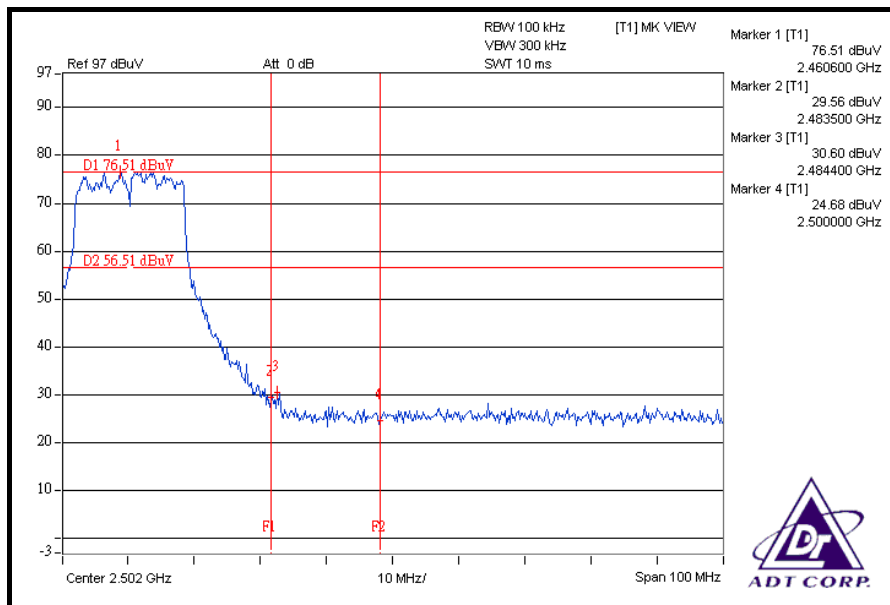
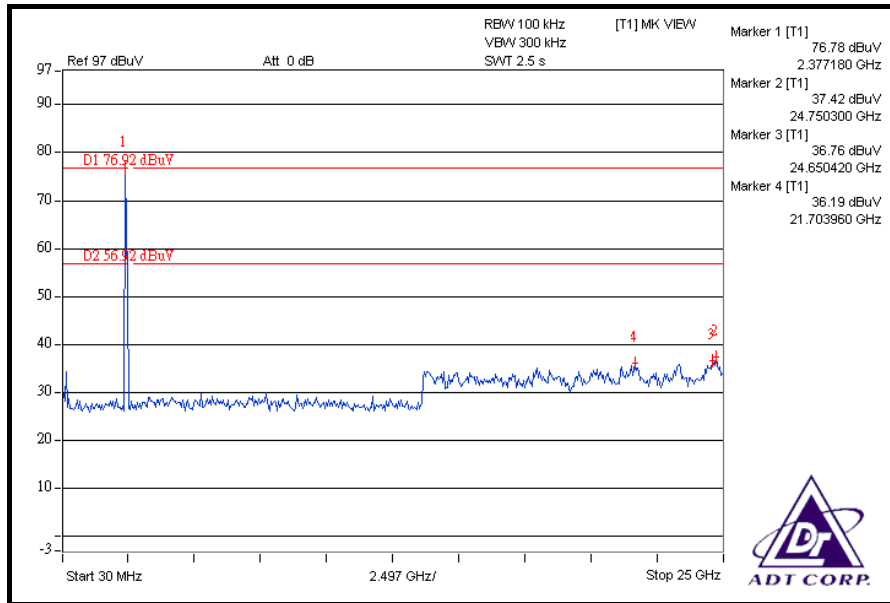



A D T

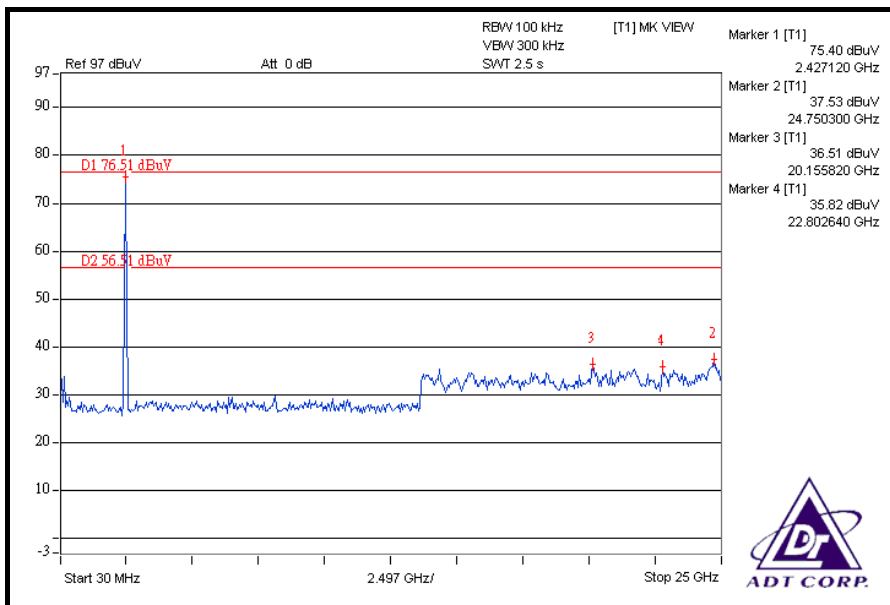
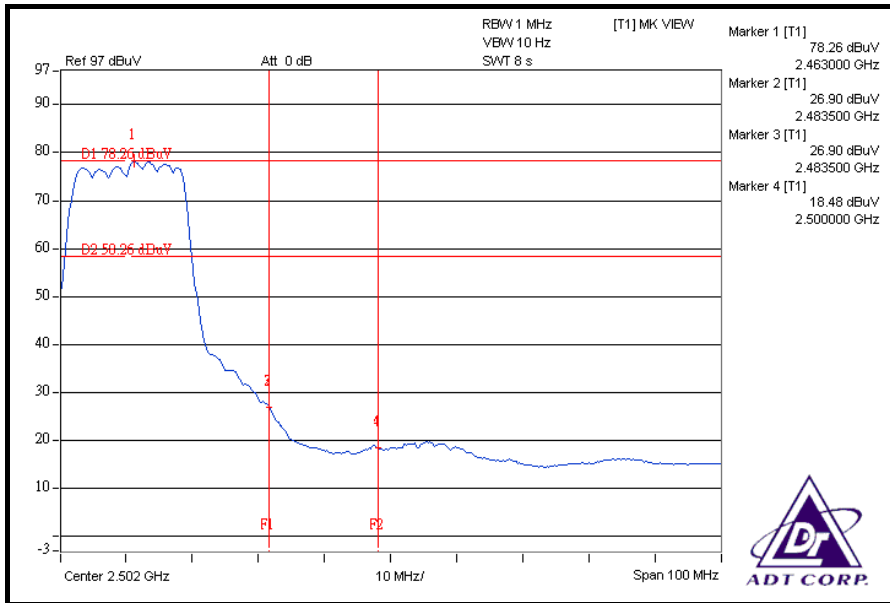

DRAFT 802.11n (20MHz) OFDM MODULATION

NOTE 1: The band edge emission plot on the next page shows 49.03dBc between carrier maximum power and local maximum emission in restrict band (2.32500GHz). The emission of carrier strength list in the test result of channel 1 at the item 4.1.7 is 112.32dBuV/m (Peak), so the maximum field strength in restrict band is $112.32 - 49.03 = 63.29$ dBuV/m which is under 74dBuV/m limit.

The band edge emission plot on the next page shows 56.83dBc between carrier maximum power and local maximum emission in restrict band (2.39000GHz). The emission of carrier strength list in the test result of channel 1 at the item 4.1.7 is 101.65dBuV/m (Average), so the maximum field strength in restrict band is $101.65 - 56.83 = 44.82$ dBuV/m which is under 54dBuV/m limit.

NOTE 2: The band edge emission plot on the next second page shows 45.80dBc between carrier maximum power and local maximum emission in restrict band (2.48350GHz). The emission of carrier strength list in the test result of channel 11 at the item 4.1.7 is 111.30dBuV/m (Peak), so the maximum field strength in restrict band is $111.30 - 45.80 = 65.50$ dBuV/m which is under 74dBuV/m limit.

The band edge emission plot on the next third page shows 51.65dBc between carrier maximum power and local maximum emission in restrict band (2.48350GHz). The emission of carrier strength list in the test result of channel 11 at the item 4.1.7 is 101.42dBuV/m (Average), so the maximum field strength in restrict band is $101.42 - 51.65 = 49.77$ dBuV/m which is under 54dBuV/m limit.



A D T

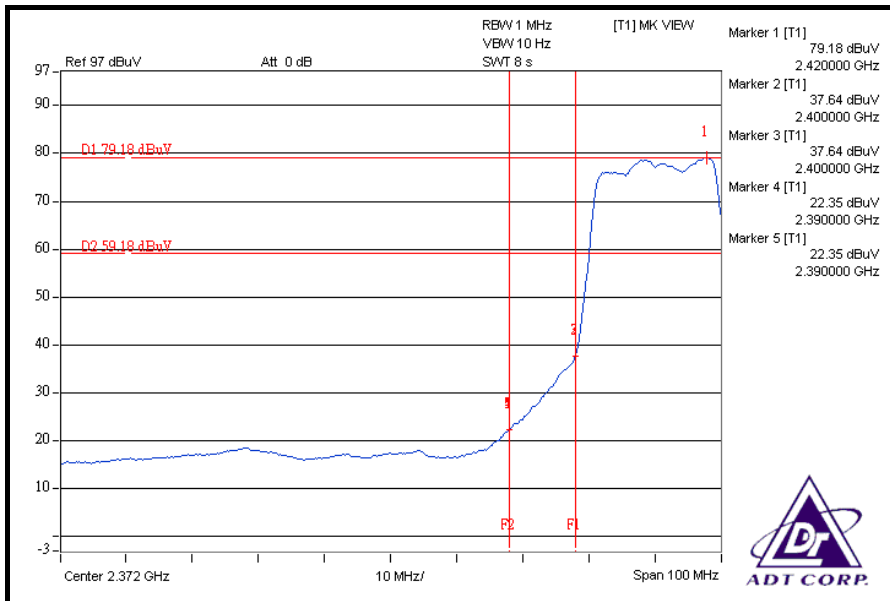
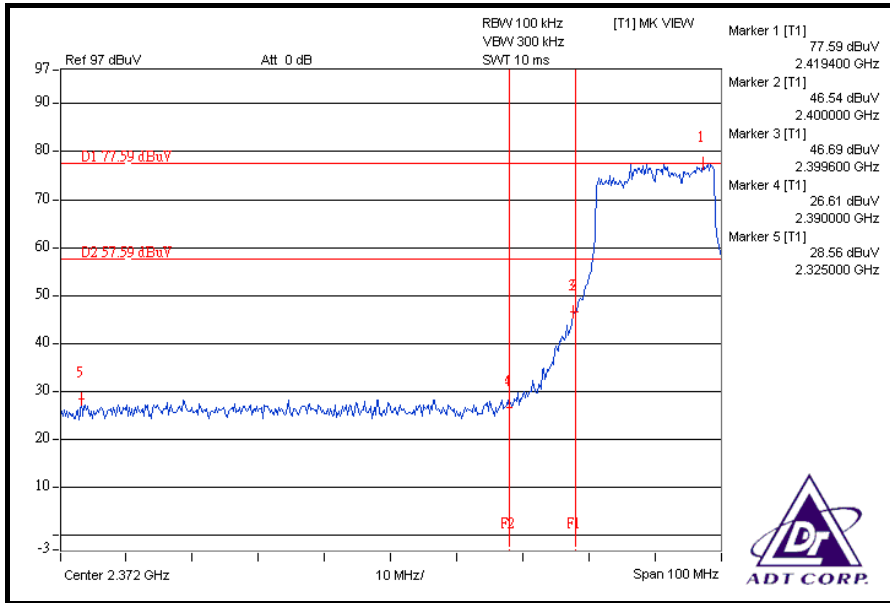



A D T

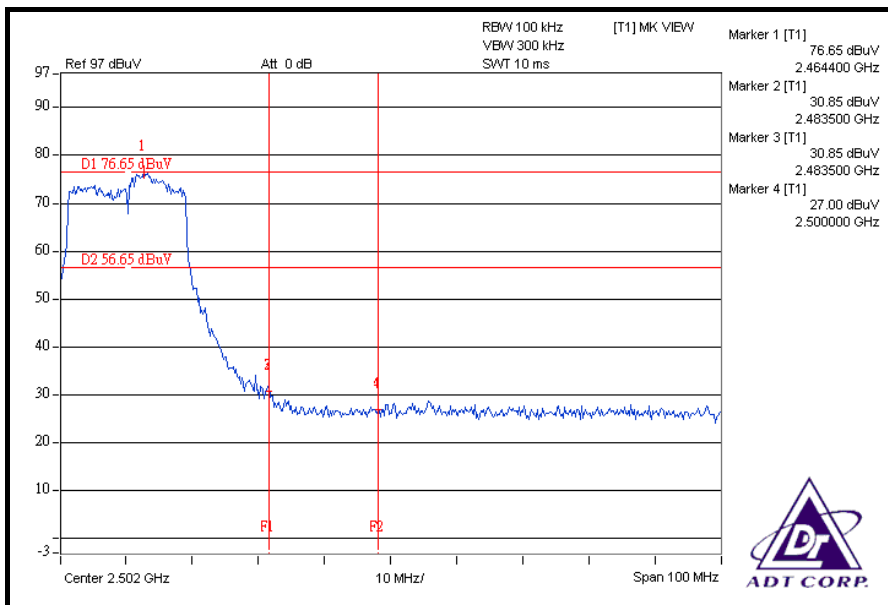
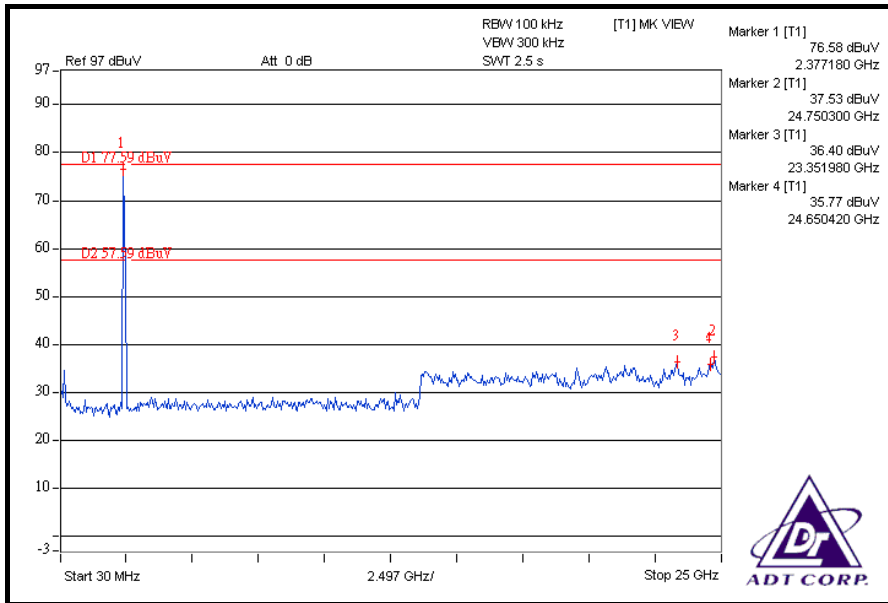



A D T

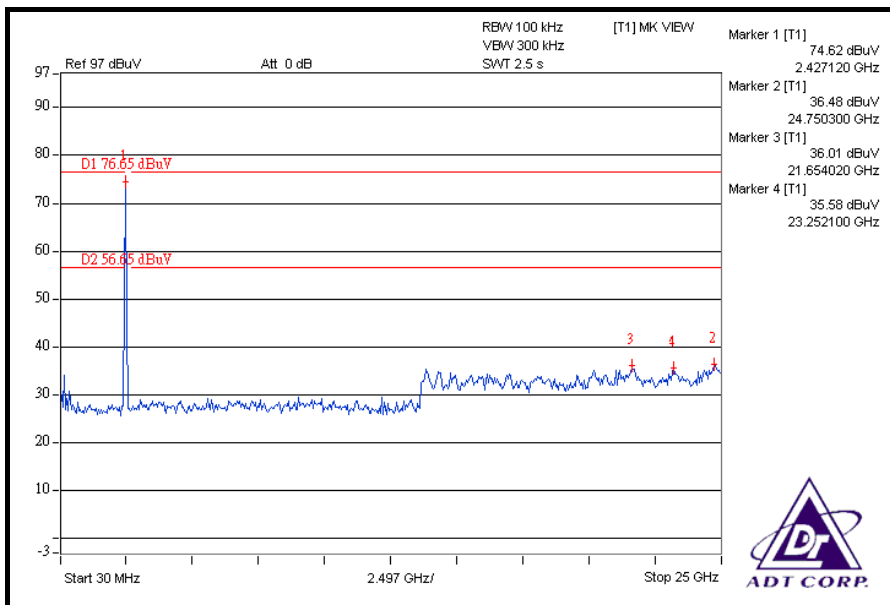
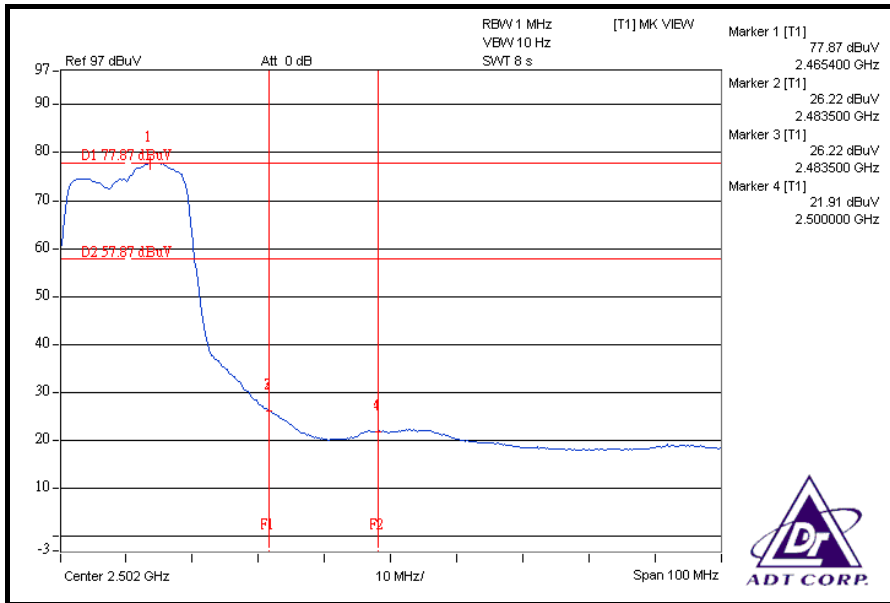

DRAFT 802.11n (40MHz) OFDM MODULATION

NOTE 1: The band edge emission plot on the next page shows 42.70dBc between carrier maximum power and local maximum emission in restrict band (2.38840GHz). The emission of carrier strength list in the test result of channel 1 at the item 4.1.7 is 109.79dBuV/m (Peak), so the maximum field strength in restrict band is $109.79 - 42.70 = 67.09$ dBuV/m which is under 74dBuV/m limit.

The band edge emission plot on the next page shows 48.21dBc between carrier maximum power and local maximum emission in restrict band (2.39000GHz). The emission of carrier strength list in the test result of channel 1 at the item 4.1.7 is 99.67dBuV/m (Average), so the maximum field strength in restrict band is $99.67 - 48.21 = 51.46$ dBuV/m which is under 54dBuV/m limit.

NOTE 2: The band edge emission plot on the next second page shows 41.66dBc between carrier maximum power and local maximum emission in restrict band (2.48350GHz). The emission of carrier strength list in the test result of channel 7 at the item 4.1.7 is 108.01dBuV/m (Peak), so the maximum field strength in restrict band is $108.01 - 41.66 = 66.35$ dBuV/m which is under 74dBuV/m limit.

The band edge emission plot on the next third page shows 45.58dBc between carrier maximum power and local maximum emission in restrict band (2.48400GHz). The emission of carrier strength list in the test result of channel 7 at the item 4.1.7 is 98.47dBuV/m (Average), so the maximum field strength in restrict band is $98.47 - 45.58 = 52.89$ dBuV/m which is under 54dBuV/m limit.



A D T

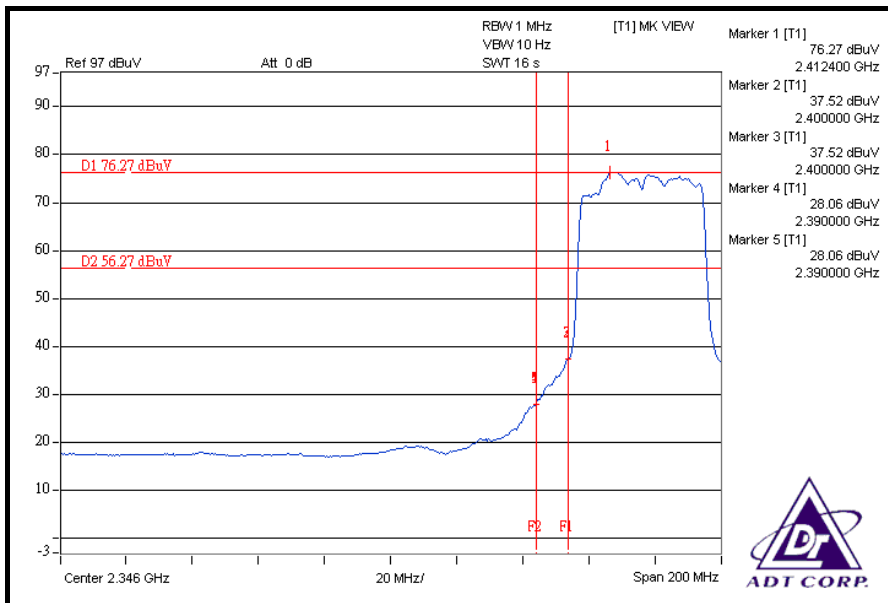
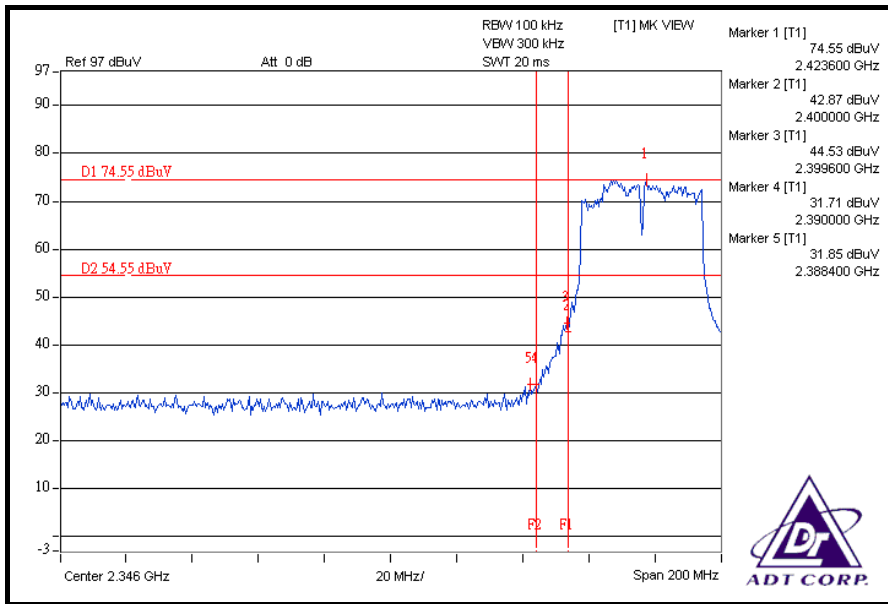



A D T

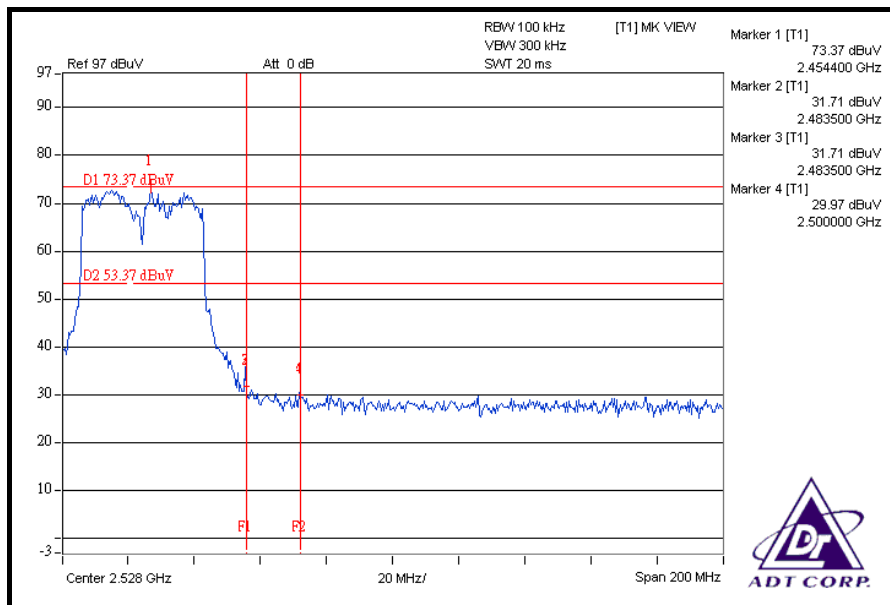
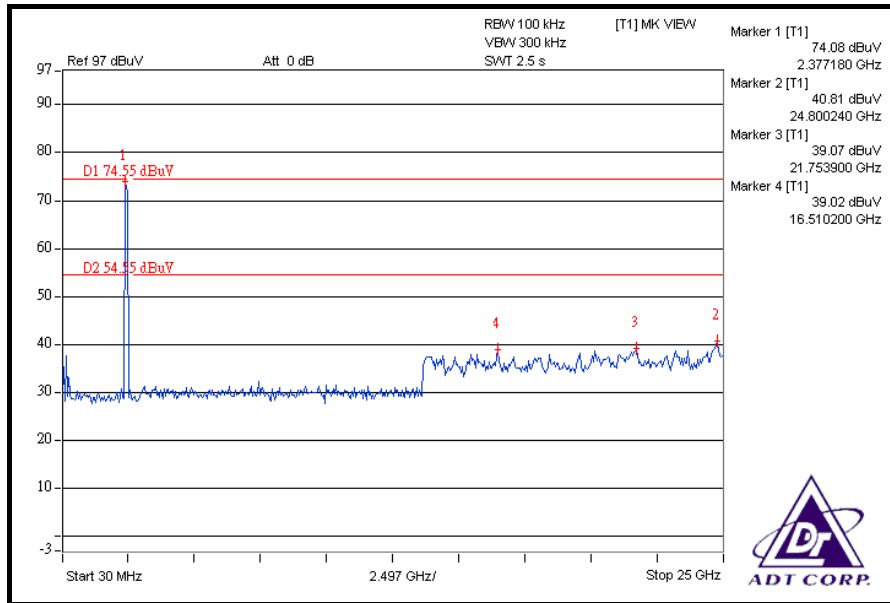



A D T

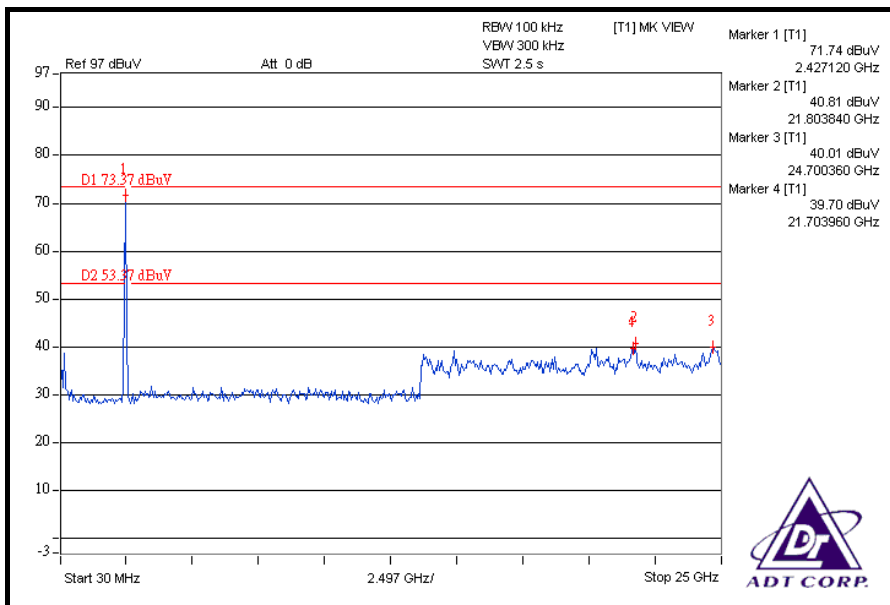
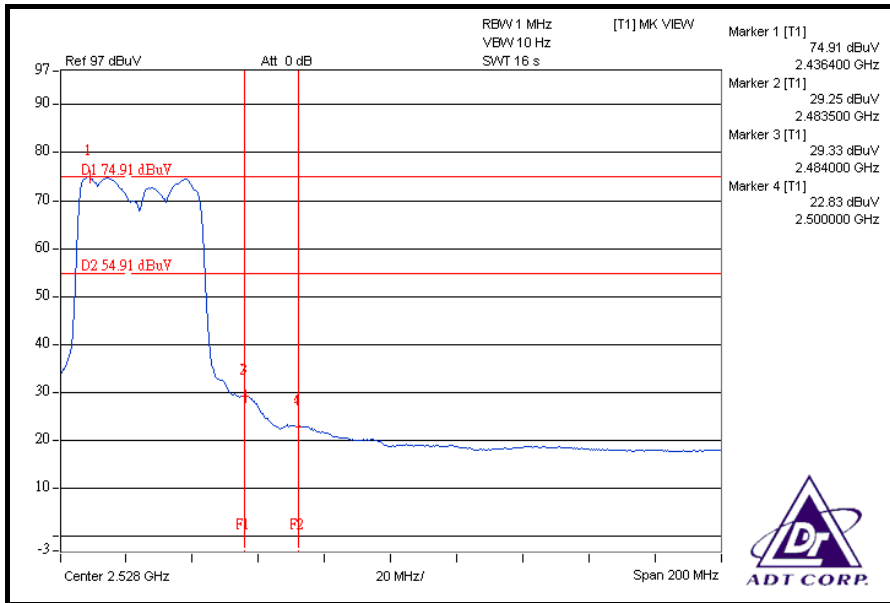

4.7 ANTENNA REQUIREMENT

4.7.1 STANDARD APPLICABLE

For intentional device, according to FCC 47 CFR Section 15.203, an intentional radiator shall be designed to ensure that no antenna other than that furnished by the responsible party shall be used with the device.

And according to FCC 47 CFR Section 15.247 (b), if transmitting antennas of directional gain greater than 6dBi are used, the power shall be reduced by the amount in dB that the directional gain of the antenna exceeds 6dBi.

4.7.2 ANTENNA CONNECTED CONSTRUCTION

The antenna used in this product is Dipole antenna with R-SMA connector. The maximum gain of the antenna is 2.0dBi.

5. PHOTOGRAPHS OF THE TEST CONFIGURATION

Please refer to the attached file (Test Setup Photo).



6. INFORMATION ON THE TESTING LABORATORIES

We, Bureau Veritas Consumer Products Services (H.K.) Ltd., Taoyuan Branch, were founded in 1988 to provide our best service in EMC, Radio, Telecom and Safety consultation. Our laboratories are accredited and approved by the following approval agencies according to ISO/IEC 17025.

USA	FCC, UL, NVLAP
Germany	TUV Rheinland
Japan	VCCI
Norway	NEMKO
Canada	INDUSTRY CANADA , CSA
R.O.C.	TAF, BSMI, NCC
Netherlands	Telefication
Singapore	GOST-ASIA(MOU)
Russia	CERTIS(MOU)

Copies of accreditation certificates of our laboratories obtained from approval agencies can be downloaded from our web site:

www.adt.com.tw/index.5/phtml. If you have any comments, please feel free to contact us at the following:

Linko EMC/RF Lab:

Tel: 886-2-26052180

Fax: 886-2-26051924

Hsin Chu EMC/RF Lab:

Tel: 886-3-5935343

Fax: 886-3-5935342

Hwa Ya EMC/RF/Safety Telecom Lab:

Tel: 886-3-3183232

Fax: 886-3-3185050

Web Site: www.adt.com.tw

The address and road map of all our labs can be found in our web site also.

7. APPENDIX A - MODIFICATIONS RECORDERS FOR ENGINEERING CHANGES TO THE EUT BY THE LAB

No any modifications are made to the EUT by the lab during the test.

---END---