



# FCC TEST REPORT

**REPORT NO.:** RF950525L11

**MODEL NO.:** DWA-542

**RECEIVED:** May 18, 2006

**TESTED:** May 18 ~ May 29, 2006

**ISSUED:** Jun. 28, 2006

**APPLICANT:** D-Link Corporation

**ADDRESS:** 17595 Mt. Herrmann, Fountain Valley, CA 92708,  
U.S.A.

**ISSUED BY:** Advance Data Technology Corporation

**LAB ADDRESS:** No.47, 14<sup>th</sup> Ling, Chia Pau Tsuen, Linko Hsiang  
244, Taipei Hsien, Taiwan, R.O.C.

**TEST LOCATION:** No. 19, Hwa Ya 2<sup>nd</sup> Rd, Wen Hwa Tsuen, Kwei  
Shan Hsiang, Taoyuan Hsien 333, Taiwan,  
R.O.C.

This test report consists of 111 pages in total. It may be duplicated completely for legal use with the approval of the applicant. It should not be reproduced except in full, without the written approval of our laboratory. The client should not use it to claim product endorsement by CNLA, A2LA or any government agencies. The test results in the report only apply to the tested sample.





## TABLE OF CONTENTS

1.	CERTIFICATION.....	4
2.	SUMMARY OF TEST RESULTS.....	5
2.1	MEASUREMENT UNCERTAINTY.....	5
3.	GENERAL INFORMATION.....	6
3.1	GENERAL DESCRIPTION OF EUT.....	6
3.2	DESCRIPTION OF TEST MODES.....	7
3.2.1	CONFIGURATION OF SYSTEM UNDER TEST.....	7
3.2.2	TEST MODE APPLICABILITY AND TESTED CHANNEL DETAIL.....	8
3.3	GENERAL DESCRIPTION OF APPLIED STANDARDS.....	10
3.4	DESCRIPTION OF SUPPORT UNITS.....	10
4.	TEST TYPES AND RESULTS.....	11
4.1	CONDUCTED EMISSION MEASUREMENT.....	11
4.1.1	LIMITS OF CONDUCTED EMISSION MEASUREMENT.....	11
4.1.2	TEST INSTRUMENTS.....	11
4.1.3	TEST PROCEDURES.....	12
4.1.4	DEVIATION FROM TEST STANDARD.....	12
4.1.5	TEST SETUP.....	13
4.1.6	EUT OPERATING CONDITIONS.....	13
4.1.7	TEST RESULTS.....	14
4.2	RADIATED EMISSION MEASUREMENT.....	32
4.2.1	LIMITS OF RADIATED EMISSION MEASUREMENT.....	32
4.2.2	TEST INSTRUMENTS.....	33
4.2.3	TEST PROCEDURES.....	34
4.2.4	DEVIATION FROM TEST STANDARD.....	34
4.2.5	TEST SETUP.....	35
4.2.6	EUT OPERATING CONDITIONS.....	35
4.2.7	TEST RESULTS.....	36
4.3	6dB BANDWIDTH MEASUREMENT.....	51
4.3.1	LIMITS OF 6dB BANDWIDTH MEASUREMENT.....	51
4.3.2	TEST INSTRUMENTS.....	51
4.3.3	TEST PROCEDURE.....	51
4.3.4	DEVIATION FROM TEST STANDARD.....	51
4.3.5	TEST SETUP.....	52
4.3.6	EUT OPERATING CONDITIONS.....	52
4.3.7	TEST RESULTS.....	53
4.4	MAXIMUM PEAK OUTPUT POWER.....	69
4.4.1	LIMITS OF MAXIMUM PEAK OUTPUT POWER MEASUREMENT.....	69
4.4.2	INSTRUMENTS.....	69
4.4.3	TEST PROCEDURES.....	69
4.4.4	DEVIATION FROM TEST STANDARD.....	69
4.4.5	TEST SETUP.....	70
4.4.6	EUT OPERATING CONDITIONS.....	70
4.4.7	TEST RESULTS.....	71
4.5	POWER SPECTRAL DENSITY MEASUREMENT.....	73
4.5.1	LIMITS OF POWER SPECTRAL DENSITY MEASUREMENT.....	73
4.5.2	TEST INSTRUMENTS.....	73
4.5.3	TEST PROCEDURE.....	73
4.5.4	DEVIATION FROM TEST STANDARD.....	73



4.5.5	TEST SETUP .....	74
4.5.6	EUT OPERATING CONDITION.....	74
4.5.7	TEST RESULTS .....	75
4.6	BAND EDGES MEASUREMENT .....	91
4.6.1	LIMITS OF BAND EDGES MEASUREMENT.....	91
4.6.2	TEST INSTRUMENTS.....	91
4.6.3	TEST PROCEDURE.....	92
4.6.4	DEVIATION FROM TEST STANDARD .....	92
4.6.5	EUT OPERATING CONDITION.....	92
4.6.6	TEST RESULTS .....	93
4.7	ANTENNA REQUIREMENT .....	109
4.7.1	STANDARD APPLICABLE .....	109
4.7.2	ANTENNA CONNECTED CONSTRUCTION .....	109
5.	INFORMATION ON THE TESTING LABORATORIES.....	110
	APPENDIX-A.....	A-1



# 1. CERTIFICATION

**PRODUCT:** D-Link DWA-542 RangeBooster N™ Desktop Adapter  
**MODEL:** DWA-542  
**BRAND:** D-Link  
**APPLICANT:** D-Link Corporation  
**TESTED:** May 18 ~ May 29, 2006  
**TEST SAMPLE:** ENGINEERING SAMPLE  
**STANDARDS:** FCC Part 15, Subpart C (Section 15.247),  
ANSI C63.4-2003

The above equipment has been tested by **Advance Data Technology Corporation**, and found compliance with the requirement of the above standards. The test record, data evaluation & Equipment Under Test (EUT) configurations represented herein are true and accurate accounts of the measurements of the sample's EMC characteristics under the conditions specified in this report.

**PREPARED BY** : Andrea Hsia , **DATE:** Jun. 28, 2006  
Andrea Hsia

**TECHNICAL ACCEPTANCE** : Long Chen , **DATE:** Jun. 28, 2006  
Responsible for RF Long Chen

**APPROVED BY** : Gary Chang , **DATE:** Jun. 28, 2006  
Gary Chang / Supervisor

## 2. SUMMARY OF TEST RESULTS

The EUT has been tested according to the following specifications:

APPLIED STANDARD: FCC Part 15, Subpart C			
STANDARD SECTION	TEST TYPE AND LIMIT	RESULT	REMARK
15.207	AC Power Conducted Emission	PASS	Meet the requirement of limit. Minimum passing margin is -14.95dB at 0.646MHz.
15.247(a)(2)	Spectrum Bandwidth of a Direct Sequence Spread Spectrum System Limit : min. 500kHz	PASS	Meet the requirement of limit.
15.247(b)	Maximum Peak Output Power Limit: max. 30dBm	PASS	Meet the requirement of limit.
15.247(d)	Transmitter Radiated Emissions Limit: Table 15.209	PASS	Meet the requirement of limit. Minimum passing margin is -1.06dB at 2483.5MHz.
15.247(e)	Power Spectral Density Limit: max. 8dBm	PASS	Meet the requirement of limit.
15.247(d)	Band Edge Measurement Limit: 20dB less than the peak value of fundamental frequency	PASS	Meet the requirement of limit.

### 2.1 MEASUREMENT UNCERTAINTY

Where relevant, the following measurement uncertainty levels have been estimated for tests performed on the EUT as specified in CISPR 16-4:

MEASUREMENT	FREQUENCY	UNCERTAINTY
Conducted emissions	9kHz ~ 30MHz	2.44 dB
Radiated emissions	30MHz ~ 200MHz	3.64 dB
	200MHz ~ 1000MHz	3.65 dB
	1GHz ~ 18GHz	2.26 dB
	18GHz ~ 40GHz	1.94 dB

This uncertainty represents an expanded uncertainty expressed at approximately the 95% confidence level using a coverage factor of  $k = 2$ .

### 3. GENERAL INFORMATION

#### 3.1 GENERAL DESCRIPTION OF EUT

<b>PRODUCT</b>	D-Link DWA-542 RangeBooster N™ Desktop Adapter
<b>MODEL NO.</b>	DWA-542
<b>FCC ID</b>	KA2WA542A2
<b>POWER SUPPLY</b>	5Vdc from host equipment
<b>MODULATION TYPE</b>	CCK, DQPSK, DBPSK for DSSS 64QAM, 16QAM, QPSK, BPSK for OFDM
<b>MODULATION TECHNOLOGY</b>	DSSS, OFDM
<b>TRANSFER RATE</b>	802.11b: 11/ 5.5/ 2/ 1Mbps 802.11g: 54/ 48/ 36/ 24/ 18/ 12/ 9/ 6Mbps Draft 802.11n (20MHz): 144.444/ 130.000/ 115.556/ 86.667/ 57.778/ 43.333/ 28.889/ 14.444/ 72.2/ 65.0/ 57.8/ 43.3/ 28.9/ 21.7/ 14.4/ 7.2Mbps Draft 802.11n (40MHz): 300/ 270/ 240/ 180/ 120/ 90/ 60/ 30/ 150/ 135/ 120/ 90/ 60/ 45/ 30/ 15Mbps
<b>FREQUENCY RANGE</b>	2400MHz ~ 2483.5MHz
<b>NUMBER OF CHANNEL</b>	11 for 802.11b, 802.11g, draft 802.11n (20MHz) 7 for draft 802.11n (40MHz)
<b>MAXIMUM OUTPUT POWER</b>	90.372mW
<b>ANTENNA TYPE</b>	Dipole antenna with 2.0dBi gain
<b>DATA CABLE</b>	NA
<b>I/O PORTS</b>	NA

**NOTE:**

1. The EUT incorporates a MIMO function with 802.11b, 802.11g, draft 802.11n. Physically, the card provides two completed transmitters and two receivers.
2. The EUT is 2 \* 2 spatial MIMO (2Tx & 2Rx) without beam forming function that only operate dual chain configuration (both chain 0 and chain 1 transceivers are operational).
3. When the EUT operating in 802.11b, 802.11g, the software operation, which is defined by manufacturer, only set dual Tx.
4. When the EUT operating in draft 802.11n, the software operation, which is defined by manufacturer, only set 0 ~ 15 of "MCS" (MCS: Modulation and Coding Schemes) for dual Tx.
5. The EUT complies with draft 802.11n standards and backwards compatible with 802.11b, 802.11g products.
6. The EUT operates in the 2.4GHz frequency spectrum with throughput of up to 300Mbps.
7. The above EUT information was declared by manufacturer and for more detailed features description, please refer to the manufacturer's specifications or user's manual.

### 3.2 DESCRIPTION OF TEST MODES

Eleven channels are provided for 802.11b, 802.11g, draft 802.11n (20MHz):

CHANNEL	FREQUENCY	CHANNEL	FREQUENCY
1	2412MHz	7	2442MHz
2	2417MHz	8	2447MHz
3	2422MHz	9	2452MHz
4	2427MHz	10	2457MHz
5	2432MHz	11	2462MHz
6	2437MHz		

Seven channels are provided for draft 802.11n (40MHz):

CHANNEL	FREQUENCY	CHANNEL	FREQUENCY
1	2422MHz	5	2442MHz
2	2427MHz	6	2447MHz
3	2432MHz	7	2452MHz
4	2437MHz		

#### 3.2.1 CONFIGURATION OF SYSTEM UNDER TEST

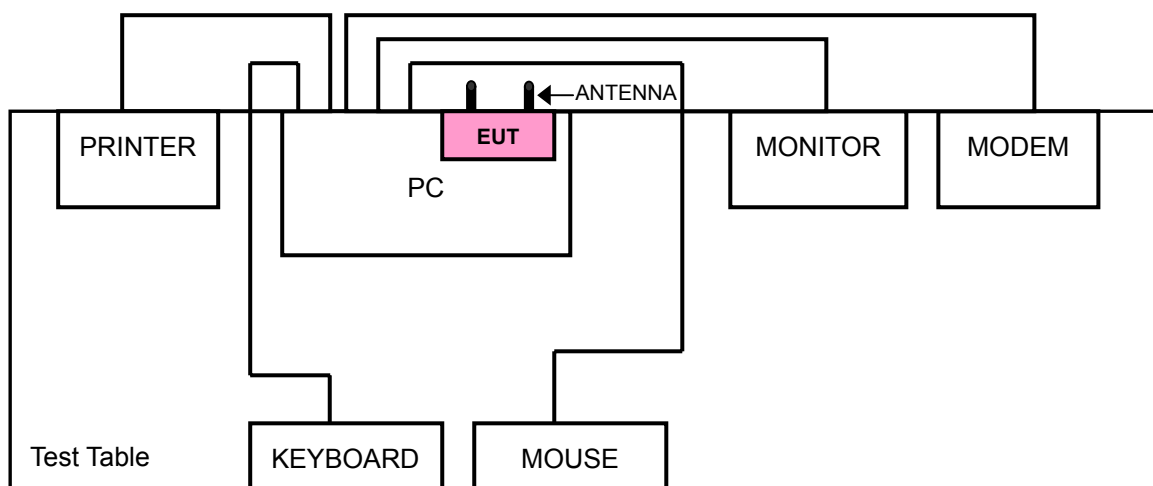

### 3.2.2 TEST MODE APPLICABILITY AND TESTED CHANNEL DETAIL

EUT CONFIGURE MODE	APPLICABLE TO				DESCRIPTION
	PLC	RE < 1G	RE ≥ 1G	APCM	
-	√	√	√	√	-

Where **PLC**: Power Line Conducted Emission      **RE < 1G**: Radiated Emission below 1GHz  
**RE ≥ 1G**: Radiated Emission above 1GHz      **APCM**: Antenna Port Conducted Measurement

#### **POWER LINE CONDUCTED EMISSION TEST:**

- Pre-Scan has been conducted to determine the worst-case mode from all possible combinations between available modulations, data rates and antenna ports (if EUT with antenna diversity architecture).
- Following channel(s) was (were) selected for the final test as listed below.

MODE	AVAILABLE CHANNEL	TESTED CHANNEL	MODULATION TECHNOLOGY	MODULATION TYPE	DATA RATE (Mbps)	TX CONDITION
802.11g	1 to 11	1, 6, 11	OFDM	BPSK	6	Dual
Draft 802.11n (20MHz)	1 to 11	1, 6, 11	OFDM	BPSK	7.2	Dual
Draft 802.11n (40MHz)	1 to 7	1, 4, 7	OFDM	BPSK	15	Dual

#### **RADIATED EMISSION TEST (BELOW 1 GHz):**

- Pre-Scan has been conducted to determine the worst-case mode from all possible combinations between available modulations, data rates and antenna ports (if EUT with antenna diversity architecture).
- Following channel(s) was (were) selected for the final test as listed below.

MODE	AVAILABLE CHANNEL	TESTED CHANNEL	MODULATION TECHNOLOGY	MODULATION TYPE	DATA RATE (Mbps)	TX CONDITION
802.11g	1 to 11	1	OFDM	BPSK	6	Dual
Draft 802.11n (20MHz)	1 to 11	1	OFDM	BPSK	7.2	Dual
Draft 802.11n (40MHz)	1 to 7	1	OFDM	BPSK	15	Dual





**RADIATED EMISSION TEST (ABOVE 1 GHz):**

- Pre-Scan has been conducted to determine the worst-case mode from all possible combinations between available modulations, data rates and antenna ports (if EUT with antenna diversity architecture).
- Following channel(s) was (were) selected for the final test as listed below.

MODE	AVAILABLE CHANNEL	TESTED CHANNEL	MODULATION TECHNOLOGY	MODULATION TYPE	DATA RATE (Mbps)	TX CONDITION
802.11b	1 to 11	1, 6, 11	DSSS	DBPSK	1	Dual
802.11g	1 to 11	1, 6, 11	OFDM	BPSK	6	Dual
Draft 802.11n (20MHz)	1 to 11	1, 6, 11	OFDM	BPSK	7.2	Dual
Draft 802.11n (40MHz)	1 to 7	1, 4, 7	OFDM	BPSK	15	Dual

**BANDEDGE MEASUREMENT:**

- Pre-Scan has been conducted to determine the worst-case mode from all possible combinations between available modulations, data rates and antenna ports (if EUT with antenna diversity architecture).
- Following channel(s) was (were) selected for the final test as listed below.

MODE	AVAILABLE CHANNEL	TESTED CHANNEL	MODULATION TECHNOLOGY	MODULATION TYPE	DATA RATE (Mbps)	TX CONDITION
802.11b	1 to 11	1, 11	DSSS	DBPSK	1	Dual
802.11g	1 to 11	1, 11	OFDM	BPSK	6	Dual
Draft 802.11n (20MHz)	1 to 11	1, 11	OFDM	BPSK	7.2	Dual
Draft 802.11n (40MHz)	1 to 7	1, 7	OFDM	BPSK	15	Dual

**ANTENNA PORT CONDUCTED MEASUREMENT:**

- Pre-Scan has been conducted to determine the worst-case mode from all possible combinations between available modulations, data rates and antenna ports (if EUT with antenna diversity architecture).
- Following channel(s) was (were) selected for the final test as listed below.

MODE	AVAILABLE CHANNEL	TESTED CHANNEL	MODULATION TECHNOLOGY	MODULATION TYPE	DATA RATE (Mbps)	TX CONDITION
802.11b	1 to 11	1, 6, 11	DSSS	DBPSK	1	Dual
802.11g	1 to 11	1, 6, 11	OFDM	BPSK	6	Dual
Draft 802.11n (20MHz)	1 to 11	1, 6, 11	OFDM	BPSK	7.2	Dual
Draft 802.11n (40MHz)	1 to 7	1, 4, 7	OFDM	BPSK	15	Dual



### 3.3 GENERAL DESCRIPTION OF APPLIED STANDARDS

The EUT is a RF product. According to the specifications of the manufacturer, it must comply with the requirements of the following standards:

#### FCC Part 15, Subpart C. (15.247)

#### ANSI C63.4-2003

All test items have been performed and recorded as per the above standards.

**NOTE:** The EUT is also considered as a kind of computer peripheral, because the connection to computer is necessary for typical use. It has been verified to comply with the requirements of FCC Part 15, Subpart B, Class B (DoC). The test report has been issued separately.

### 3.4 DESCRIPTION OF SUPPORT UNITS

The EUT has been tested as an independent unit together with other necessary accessories or support units. The following support units or accessories were used to form a representative test configuration during the tests.

NO.	PRODUCT	BRAND	MODEL NO.	SERIAL NO.	FCC ID
1	PC	Micro Star	Hetis 865G	380125734	FCC DoC Approved
2	LCD MONITOR	ACER	AL1721	ET.L0408.0104 04001E6PK00	FCC DoC Approved
3	PRINTER	EPSON	LQ-300+	DCGY054147	FCC DoC Approved
4	MODEM	ACEEX	1414V/3	0401008269	IFAXDM1414
5	KEYBOARD	HP	SK-1688	C0306114659	GYUR84SK
6	MOUSE	HP	M-S69	M4-010565	INZ211443

NO.	SIGNAL CABLE DESCRIPTION OF THE ABOVE SUPPORT UNITS
1	NA
2	1.8m shielded cable
3	1.2m shielded cable
4	1.2m shielded cable
5	1.3m shielded cable
6	1.8m shielded cable

**NOTE:** All power cords of the above support units are non shielded (1.8m).

## 4. TEST TYPES AND RESULTS

### 4.1 CONDUCTED EMISSION MEASUREMENT

#### 4.1.1 LIMITS OF CONDUCTED EMISSION MEASUREMENT

FREQUENCY OF EMISSION (MHz)	CONDUCTED LIMIT (dB $\mu$ V)	
	Quasi-peak	Average
0.15-0.5	66 to 56	56 to 46
0.5-5	56	46
5-30	60	50

- NOTE:**
1. The lower limit shall apply at the transition frequencies.
  2. The limit decreases in line with the logarithm of the frequency in the range of 0.15 to 0.50 MHz.
  3. All emanations from a class A/B digital device or system, including any network of conductors and apparatus connected thereto, shall not exceed the level of field strengths specified above.

#### 4.1.2 TEST INSTRUMENTS

DESCRIPTION & MANUFACTURER	MODEL NO.	SERIAL NO.	CALIBRATED UNTIL
Test Receiver ROHDE & SCHWARZ	ESCS30	100291	Nov. 11, 2006
RF signal cable Woken	5D-FB	Cable-HYC01-01	Jan. 06, 2007
LISN ROHDE & SCHWARZ	ESH3-Z5	100312	Feb. 15, 2007
LISN ROHDE & SCHWARZ	ESH2-Z5	100104	Feb. 07, 2007
Software ADT	ADT_Cond_V3	NA	NA

- NOTE:**
1. The calibration interval of the above test instruments is 12 months and the calibrations are traceable to NML/ROC and NIST/USA.
  2. The test was performed in HwaYa Shielded Room 1.
  3. The VCCI Site Registration No. is C-2040.

#### 4.1.3 TEST PROCEDURES

- a. The EUT was placed 0.4 meters from the conducting wall of the shielded room with EUT being connected to the power mains through a line impedance stabilization network (LISN). Other support units were connected to the power mains through another LISN. The two LISNs provide 50 ohm/ 50uH of coupling impedance for the measuring instrument.
- b. Both lines of the power mains connected to the EUT were checked for maximum conducted interference.
- c. The frequency range from 150kHz to 30MHz was searched. Emission levels under (Limit - 20dB) was not recorded.

#### 4.1.4 DEVIATION FROM TEST STANDARD

No deviation

#### 4.1.5 TEST SETUP

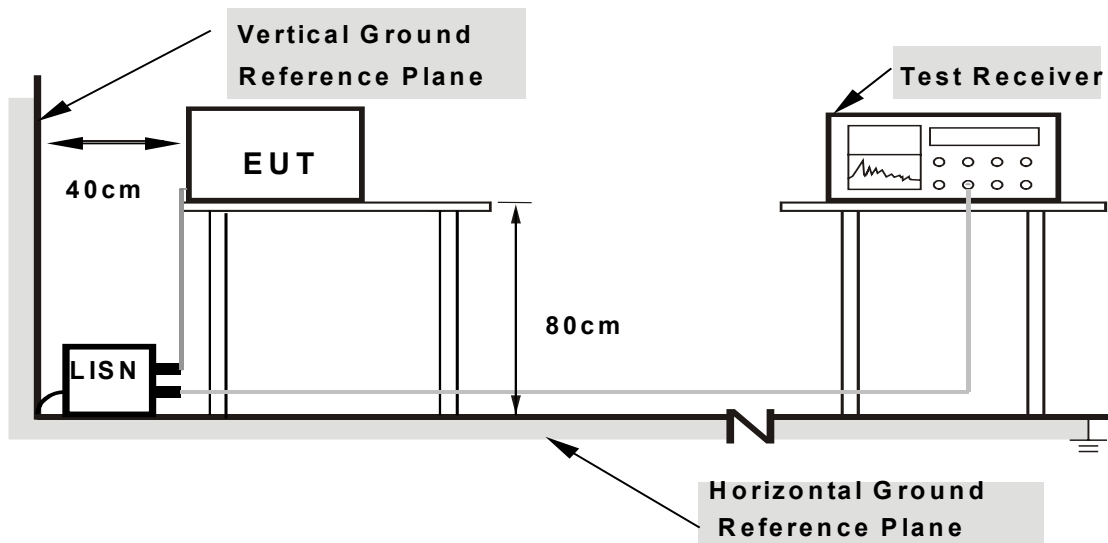

- Note: 1.Support units were connected to second LISN .**  
**2.Both of LISNs (AMN) are 80 cm from EUT and at least 80 from other units and other metal planes**

For the actual test configuration, please refer to the related item – Photographs of the Test Configuration.

#### 4.1.6 EUT OPERATING CONDITIONS

- Connected the EUT into the computer system and placed on a testing table.
- The computer system ran a test program (provided by manufacturer) to enable EUT under transmission/receiving condition continuously at specific channel frequency.
- The computer system sent "H" messages to monitor, and the monitor displayed them on the screen.
- The computer system show "H" messages to modem.
- The computer system sent "H" messages to printer and the printer prints them on paper.
- Repeated item c ~e.

#### 4.1.7 TEST RESULTS

##### CONDUCTED WORST-CASE DATA: 802.11g OFDM MODULATION:

EUT TEST CONDITION		MEASUREMENT DETAIL	
CHANNEL	Channel 1	PHASE	Line 1
MODULATION TYPE	BPSK	6dB BANDWIDTH	9 kHz
TRANSFER RATE	6Mbps	INPUT POWER (SYSTEM)	120Vac, 60 Hz
ENVIRONMENTAL CONDITIONS	25deg. C, 65%RH, 991hPa	TESTED BY	Long Chen

No	Freq. [MHz]	Corr. Factor (dB)	Reading Value [dB (uV)]		Emission Level [dB (uV)]		Limit [dB (uV)]		Margin (dB)	
			Q.P.	AV.	Q.P.	AV.	Q.P.	AV.	Q.P.	AV.
1	0.193	0.10	46.84	-	45.94	-	63.91	53.91	-17.97	-
2	0.259	0.10	39.01	-	39.11	-	61.45	51.45	-22.34	-
3	0.709	0.15	37.10	-	36.25	-	56.00	46.00	-19.75	-
4	1.547	0.20	37.34	-	37.54	-	56.00	46.00	-18.46	-
5	3.551	0.41	36.06	-	36.47	-	56.00	46.00	-19.53	-
6	22.570	0.93	38.94	-	39.87	-	60.00	50.00	-20.13	-

- REMARKS:**
1. Q.P. and AV. are abbreviations of quasi-peak and average individually.
  2. "-": The Quasi-peak reading value also meets average limit and measurement with the average detector is unnecessary.
  3. The emission levels of other frequencies were very low against the limit.
  4. Margin value = Emission level - Limit value
  5. Correction factor = Insertion loss + Cable loss
  6. Emission Level = Correction Factor + Reading Value.

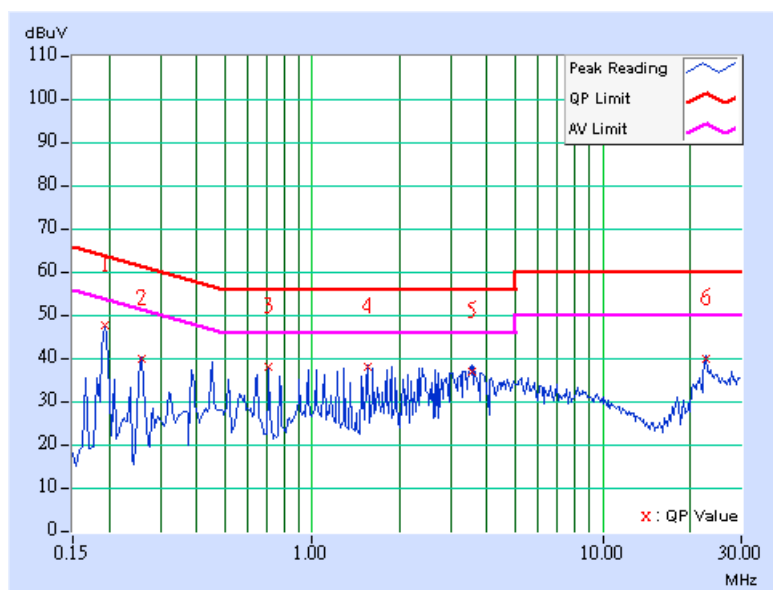

EUT TEST CONDITION		MEASUREMENT DETAIL	
CHANNEL	Channel 1	PHASE	Line 2
MODULATION TYPE	BPSK	6dB BANDWIDTH	9 kHz
TRANSFER RATE	6Mbps	INPUT POWER (SYSTEM)	120Vac, 60 Hz
ENVIRONMENTAL CONDITIONS	25deg. C, 65%RH, 991hPa	TESTED BY	Long Chen

No	Freq. [MHz]	Corr. Factor [dB]	Reading Value [dB (uV)]		Emission Level [dB (uV)]		Limit [dB (uV)]		Margin (dB)	
			Q.P.	AV.	Q.P.	AV.	Q.P.	AV.	Q.P.	AV.
			1	0.193	0.10	43.92	-	44.02	-	63.91
2	0.388	0.10	41.19	-	41.29	-	58.10	48.10	-16.81	-
3	0.709	0.10	40.59	-	40.69	-	56.00	46.00	-15.31	-
4	1.227	0.12	39.76	-	39.88	-	56.00	46.00	-16.12	-
5	3.289	0.31	35.97	-	36.28	-	56.00	46.00	-19.72	-
6	22.570	0.63	39.08	-	39.71	-	60.00	50.00	-20.29	-

- REMARKS:**
1. Q.P. and AV. are abbreviations of quasi-peak and average individually.
  2. "-": The Quasi-peak reading value also meets average limit and measurement with the average detector is unnecessary.
  3. The emission levels of other frequencies were very low against the limit.
  4. Margin value = Emission level - Limit value
  5. Correction factor = Insertion loss + Cable loss
  6. Emission Level = Correction Factor + Reading Value.

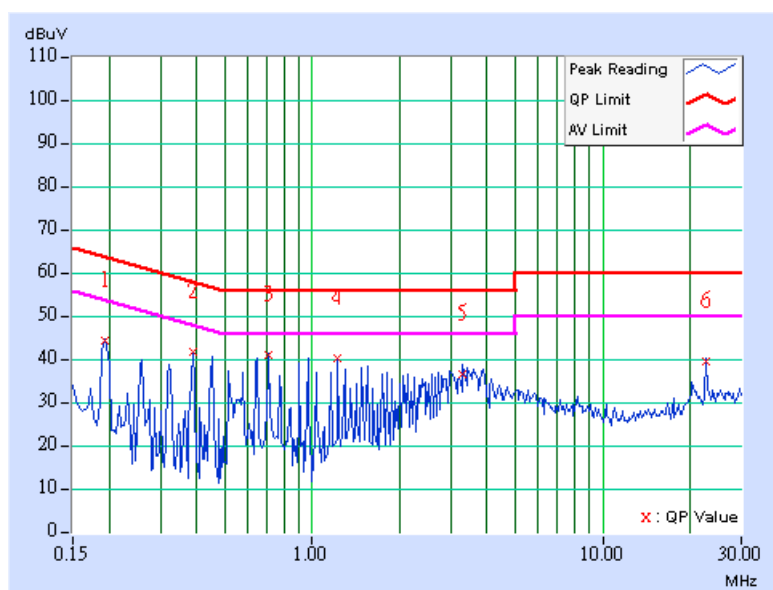

EUT TEST CONDITION		MEASUREMENT DETAIL	
CHANNEL	Channel 6	PHASE	Line 1
MODULATION TYPE	BPSK	6dB BANDWIDTH	9 kHz
TRANSFER RATE	6Mbps	INPUT POWER (SYSTEM)	120Vac, 60 Hz
ENVIRONMENTAL CONDITIONS	25deg. C, 65%RH, 991hPa	TESTED BY	Long Chen

No	Freq. [MHz]	Corr. Factor [dB]	Reading Value [dB (uV)]		Emission Level [dB (uV)]		Limit [dB (uV)]		Margin (dB)	
			Q.P.	AV.	Q.P.	AV.	Q.P.	AV.	Q.P.	AV.
1	0.193	0.10	45.73	-	45.83	-	63.91	53.91	-18.08	-
2	0.259	0.10	38.91	-	39.01	-	61.45	51.45	-22.44	-
3	0.709	0.15	36.94	-	37.09	-	56.00	46.00	-18.91	-
4	1.551	0.20	37.14	-	37.34	-	56.00	46.00	-18.66	-
5	3.547	0.41	35.68	-	36.09	-	56.00	46.00	-19.91	-
6	22.570	0.93	38.60	-	39.53	-	60.00	50.00	-20.47	-

- REMARKS:**
1. Q.P. and AV. are abbreviations of quasi-peak and average individually.
  2. "-": The Quasi-peak reading value also meets average limit and measurement with the average detector is unnecessary.
  3. The emission levels of other frequencies were very low against the limit.
  4. Margin value = Emission level - Limit value
  5. Correction factor = Insertion loss + Cable loss
  6. Emission Level = Correction Factor + Reading Value.

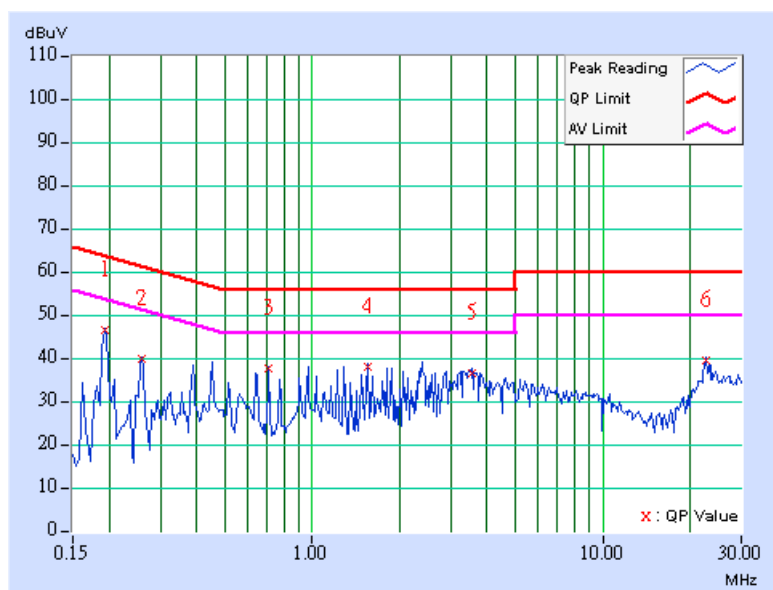



EUT TEST CONDITION		MEASUREMENT DETAIL	
CHANNEL	Channel 6	PHASE	Line 2
MODULATION TYPE	BPSK	6dB BANDWIDTH	9 kHz
TRANSFER RATE	6Mbps	INPUT POWER (SYSTEM)	120Vac, 60 Hz
ENVIRONMENTAL CONDITIONS	25deg. C, 65%RH, 991hPa	TESTED BY	Long Chen

No	Freq.	Corr.	Reading Value		Emission Level		Limit		Margin	
	[MHz]	Factor	[dB (uV)]		[dB (uV)]		[dB (uV)]		(dB)	
		(dB)	Q.P.	AV.	Q.P.	AV.	Q.P.	AV.	Q.P.	AV.
1	0.193	0.10	43.84	-	43.94	-	63.91	53.91	-19.97	-
2	0.384	0.10	40.12	-	40.22	-	58.18	48.18	-17.96	-
3	<b>0.646</b>	<b>0.10</b>	<b>40.95</b>	-	<b>41.05</b>	-	<b>56.00</b>	<b>46.00</b>	<b>-14.95</b>	-
4	0.966	0.10	40.07	-	40.17	-	56.00	46.00	-15.83	-
5	3.551	0.33	36.40	-	36.73	-	56.00	46.00	-19.27	-
6	22.570	0.63	39.92	-	40.55	-	60.00	50.00	-19.45	-

- REMARKS:**
1. Q.P. and AV. are abbreviations of quasi-peak and average individually.
  2. "-": The Quasi-peak reading value also meets average limit and measurement with the average detector is unnecessary.
  3. The emission levels of other frequencies were very low against the limit.
  4. Margin value = Emission level - Limit value
  5. Correction factor = Insertion loss + Cable loss
  6. Emission Level = Correction Factor + Reading Value.

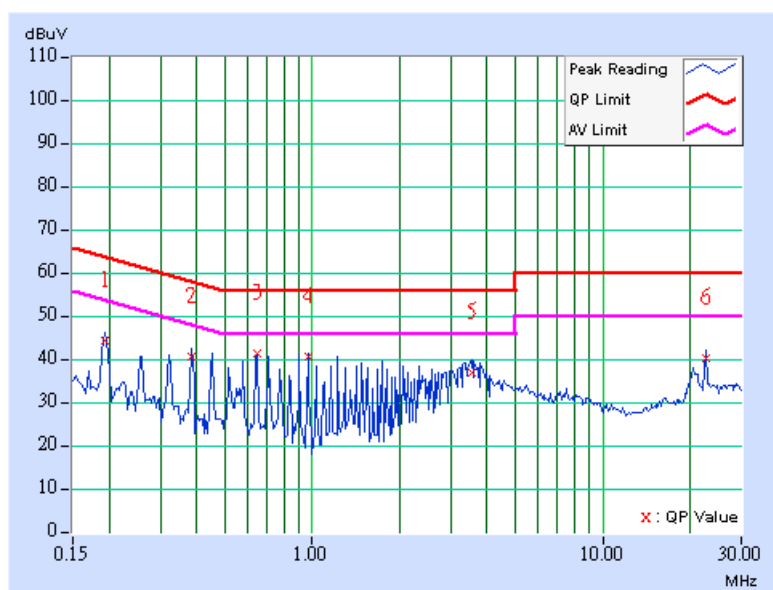

EUT TEST CONDITION		MEASUREMENT DETAIL	
CHANNEL	Channel 11	PHASE	Line 1
MODULATION TYPE	BPSK	6dB BANDWIDTH	9 kHz
TRANSFER RATE	6Mbps	INPUT POWER (SYSTEM)	120Vac, 60 Hz
ENVIRONMENTAL CONDITIONS	25deg. C, 65%RH, 991hPa	TESTED BY	Long Chen

No	Freq. [MHz]	Corr. Factor [dB]	Reading Value [dB (uV)]		Emission Level [dB (uV)]		Limit [dB (uV)]		Margin (dB)	
			Q.P.	AV.	Q.P.	AV.	Q.P.	AV.	Q.P.	AV.
			1	0.193	0.10	45.83	-	45.93	-	63.91
2	0.388	0.10	36.66	-	36.76	-	58.10	48.10	-21.34	-
3	0.713	0.15	36.13	-	36.28	-	56.00	46.00	-19.72	-
4	1.551	0.20	37.16	-	37.36	-	56.00	46.00	-18.64	-
5	3.484	0.40	36.14	-	36.54	-	56.00	46.00	-19.46	-
6	22.570	0.93	38.46	-	39.39	-	60.00	50.00	-20.61	-

- REMARKS:**
1. Q.P. and AV. are abbreviations of quasi-peak and average individually.
  2. "-": The Quasi-peak reading value also meets average limit and measurement with the average detector is unnecessary.
  3. The emission levels of other frequencies were very low against the limit.
  4. Margin value = Emission level - Limit value
  5. Correction factor = Insertion loss + Cable loss
  6. Emission Level = Correction Factor + Reading Value.

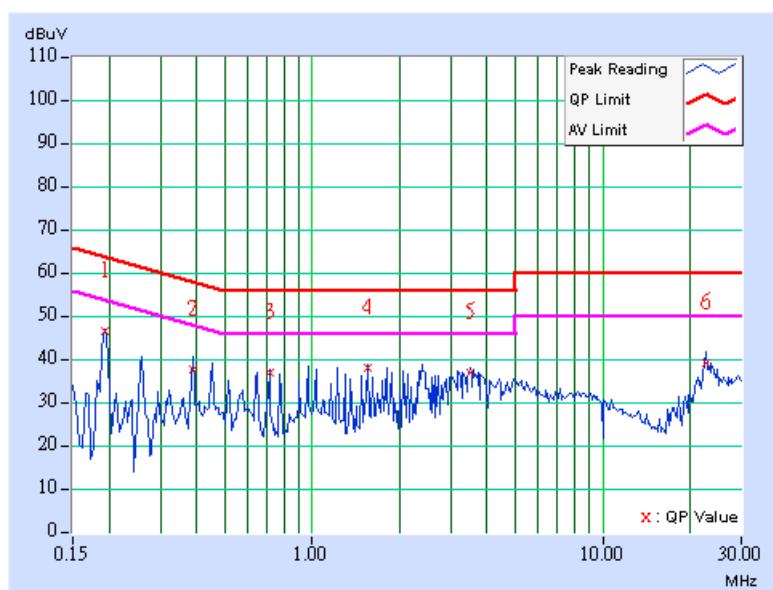

EUT TEST CONDITION		MEASUREMENT DETAIL	
CHANNEL	Channel 11	PHASE	Line 2
MODULATION TYPE	BPSK	6dB BANDWIDTH	9 kHz
TRANSFER RATE	6Mbps	INPUT POWER (SYSTEM)	120Vac, 60 Hz
ENVIRONMENTAL CONDITIONS	25deg. C, 65%RH, 991hPa	TESTED BY	Long Chen

No	Freq. [MHz]	Corr. Factor [dB]	Reading Value [dB (uV)]		Emission Level [dB (uV)]		Limit [dB (uV)]		Margin (dB)	
			Q.P.	AV.	Q.P.	AV.	Q.P.	AV.	Q.P.	AV.
			1	0.193	0.10	45.44	-	45.54	-	63.91
2	0.388	0.10	39.84	-	39.94	-	58.10	48.10	-18.16	-
3	0.646	0.10	40.51	-	40.61	-	56.00	46.00	-15.39	-
4	1.160	0.12	36.91	-	37.03	-	56.00	46.00	-18.97	-
5	3.547	0.33	35.26	-	35.59	-	56.00	46.00	-20.41	-
6	22.570	0.63	39.15	-	39.78	-	60.00	50.00	-20.22	-

- REMARKS:**
1. Q.P. and AV. are abbreviations of quasi-peak and average individually.
  2. "-": The Quasi-peak reading value also meets average limit and measurement with the average detector is unnecessary.
  3. The emission levels of other frequencies were very low against the limit.
  4. Margin value = Emission level - Limit value
  5. Correction factor = Insertion loss + Cable loss
  6. Emission Level = Correction Factor + Reading Value.

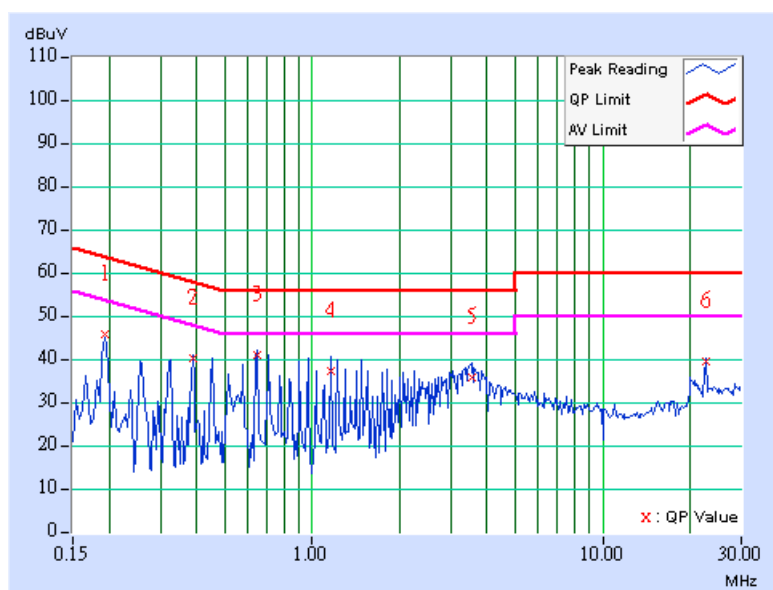

**DRAFT 802.11n (20MHz) OFDM MODULATION: DUAL TX:**

EUT TEST CONDITION		MEASUREMENT DETAIL	
CHANNEL	Channel 1	PHASE	Line 1
MODULATION TYPE	BPSK	6dB BANDWIDTH	9 kHz
TRANSFER RATE	7.2Mbps	INPUT POWER (SYSTEM)	120Vac, 60 Hz
ENVIRONMENTAL CONDITIONS	25deg. C, 65%RH, 991hPa	TESTED BY	Long Chen

No	Freq. [MHz]	Corr. Factor (dB)	Reading Value [dB (uV)]		Emission Level [dB (uV)]		Limit [dB (uV)]		Margin (dB)	
			Q.P.	AV.	Q.P.	AV.	Q.P.	AV.	Q.P.	AV.
1	0.193	0.10	47.00	-	47.10	-	63.91	53.91	-16.81	-
2	0.451	0.11	37.90	-	38.01	-	56.86	46.86	-18.85	-
3	0.709	0.15	37.24	-	37.39	-	56.00	46.00	-18.61	-
4	1.031	0.20	36.72	-	36.92	-	56.00	46.00	-19.08	-
5	3.480	0.40	35.29	-	35.69	-	56.00	46.00	-20.31	-
6	22.566	0.93	38.20	-	39.13	-	60.00	50.00	-20.87	-

- REMARKS:**
1. Q.P. and AV. are abbreviations of quasi-peak and average individually.
  2. "-": The Quasi-peak reading value also meets average limit and measurement with the average detector is unnecessary.
  3. The emission levels of other frequencies were very low against the limit.
  4. Margin value = Emission level - Limit value
  5. Correction factor = Insertion loss + Cable loss
  6. Emission Level = Correction Factor + Reading Value.

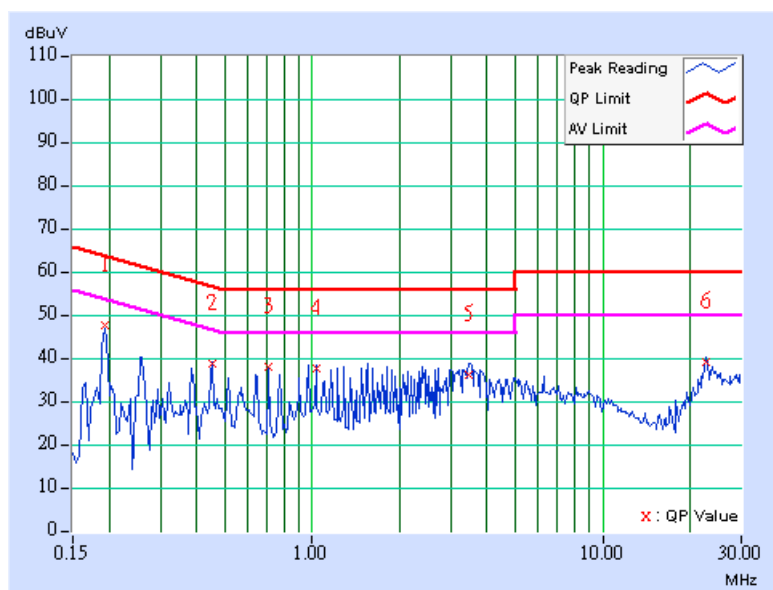

EUT TEST CONDITION		MEASUREMENT DETAIL	
CHANNEL	Channel 1	PHASE	Line 2
MODULATION TYPE	BPSK	6dB BANDWIDTH	9 kHz
TRANSFER RATE	7.2Mbps	INPUT POWER (SYSTEM)	120Vac, 60 Hz
ENVIRONMENTAL CONDITIONS	25deg. C, 65%RH, 991hPa	TESTED BY	Long Chen

No	Freq. [MHz]	Corr. Factor [dB]	Reading Value [dB (uV)]		Emission Level [dB (uV)]		Limit [dB (uV)]		Margin (dB)	
			Q.P.	AV.	Q.P.	AV.	Q.P.	AV.	Q.P.	AV.
			1	0.193	0.10	44.16	-	44.26	-	63.91
2	0.451	0.10	41.12	-	41.22	-	56.86	46.86	-15.64	-
3	0.709	0.10	40.93	-	41.03	-	56.00	46.00	-14.97	-
4	0.966	0.10	40.78	-	40.88	-	56.00	46.00	-15.12	-
5	3.543	0.33	36.48	-	36.81	-	56.00	46.00	-19.19	-
6	22.570	0.63	39.86	-	40.49	-	60.00	50.00	-19.51	-

- REMARKS:**
1. Q.P. and AV. are abbreviations of quasi-peak and average individually.
  2. "-": The Quasi-peak reading value also meets average limit and measurement with the average detector is unnecessary.
  3. The emission levels of other frequencies were very low against the limit.
  4. Margin value = Emission level - Limit value
  5. Correction factor = Insertion loss + Cable loss
  6. Emission Level = Correction Factor + Reading Value.

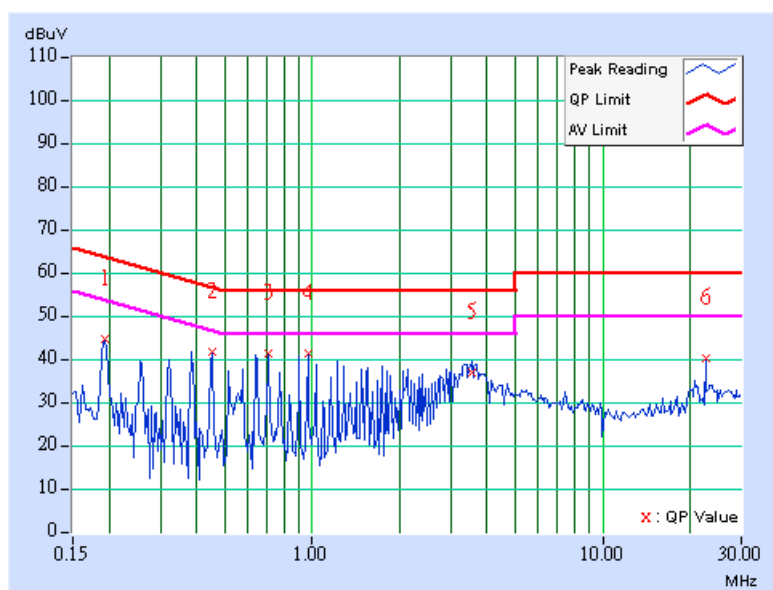

EUT TEST CONDITION		MEASUREMENT DETAIL	
CHANNEL	Channel 6	PHASE	Line 1
MODULATION TYPE	BPSK	6dB BANDWIDTH	9 kHz
TRANSFER RATE	7.2Mbps	INPUT POWER (SYSTEM)	120Vac, 60 Hz
ENVIRONMENTAL CONDITIONS	25deg. C, 65%RH, 991hPa	TESTED BY	Long Chen

No	Freq. [MHz]	Corr. Factor [dB]	Reading Value [dB (uV)]		Emission Level [dB (uV)]		Limit [dB (uV)]		Margin (dB)	
			Q.P.	AV.	Q.P.	AV.	Q.P.	AV.	Q.P.	AV.
			1	0.193	0.10	46.96	-	47.06	-	63.91
2	0.451	0.11	37.96	-	38.07	-	56.86	46.86	-18.79	-
3	0.966	0.19	36.35	-	36.54	-	56.00	46.00	-19.46	-
4	1.547	0.20	37.62	-	37.82	-	56.00	46.00	-18.18	-
5	3.547	0.41	36.10	-	36.51	-	56.00	46.00	-19.49	-
6	22.566	0.93	37.97	-	38.90	-	60.00	50.00	-21.10	-

- REMARKS:**
1. Q.P. and AV. are abbreviations of quasi-peak and average individually.
  2. "-": The Quasi-peak reading value also meets average limit and measurement with the average detector is unnecessary.
  3. The emission levels of other frequencies were very low against the limit.
  4. Margin value = Emission level - Limit value
  5. Correction factor = Insertion loss + Cable loss
  6. Emission Level = Correction Factor + Reading Value.

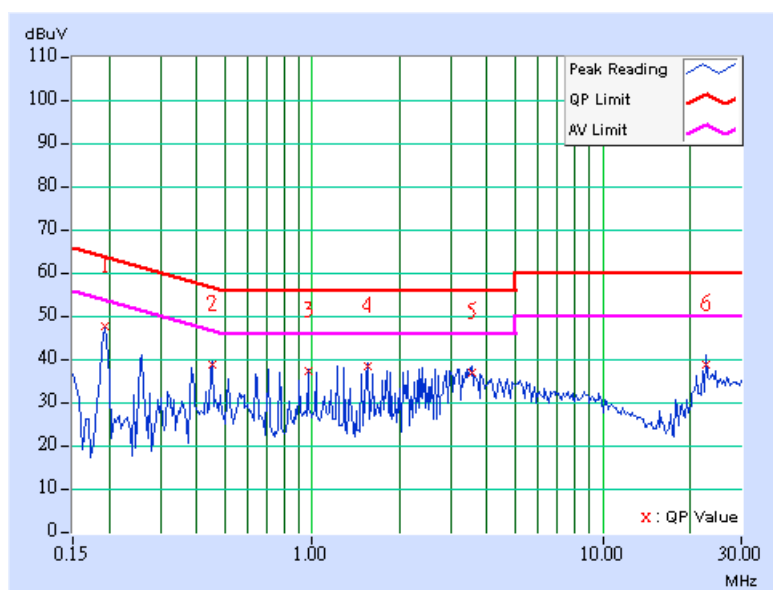

EUT TEST CONDITION		MEASUREMENT DETAIL	
CHANNEL	Channel 6	PHASE	Line 2
MODULATION TYPE	BPSK	6dB BANDWIDTH	9 kHz
TRANSFER RATE	7.2Mbps	INPUT POWER (SYSTEM)	120Vac, 60 Hz
ENVIRONMENTAL CONDITIONS	25deg. C, 65%RH, 991hPa	TESTED BY	Long Chen

No	Freq. [MHz]	Corr. Factor [dB]	Reading Value [dB (uV)]		Emission Level [dB (uV)]		Limit [dB (uV)]		Margin (dB)	
			Q.P.	AV.	Q.P.	AV.	Q.P.	AV.	Q.P.	AV.
			1	0.193	0.10	43.94	-	44.04	-	63.91
2	0.451	0.10	40.90	-	41.00	-	56.86	46.86	-15.86	-
3	0.709	0.10	40.81	-	40.91	-	56.00	46.00	-15.09	-
4	0.966	0.10	40.68	-	40.78	-	56.00	46.00	-15.22	-
5	3.348	0.31	33.74	-	34.05	-	56.00	46.00	-21.95	-
6	22.570	0.63	39.33	-	39.96	-	60.00	50.00	-20.04	-

- REMARKS:**
1. Q.P. and AV. are abbreviations of quasi-peak and average individually.
  2. "-": The Quasi-peak reading value also meets average limit and measurement with the average detector is unnecessary.
  3. The emission levels of other frequencies were very low against the limit.
  4. Margin value = Emission level - Limit value
  5. Correction factor = Insertion loss + Cable loss
  6. Emission Level = Correction Factor + Reading Value.

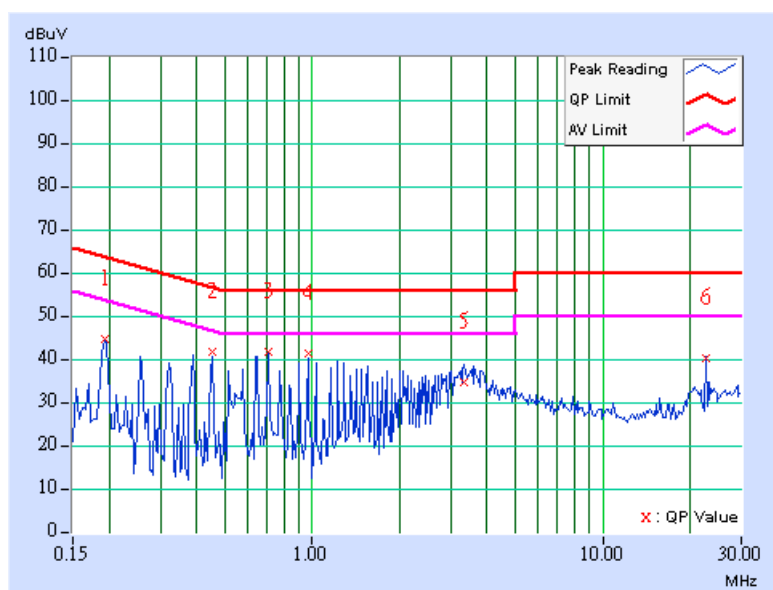

EUT TEST CONDITION		MEASUREMENT DETAIL	
CHANNEL	Channel 11	PHASE	Line 1
MODULATION TYPE	BPSK	6dB BANDWIDTH	9 kHz
TRANSFER RATE	7.2Mbps	INPUT POWER (SYSTEM)	120Vac, 60 Hz
ENVIRONMENTAL CONDITIONS	25deg. C, 65%RH, 991hPa	TESTED BY	Long Chen

No	Freq. [MHz]	Corr. Factor [dB]	Reading Value [dB (uV)]		Emission Level [dB (uV)]		Limit [dB (uV)]		Margin (dB)	
			Q.P.	AV.	Q.P.	AV.	Q.P.	AV.	Q.P.	AV.
1	0.193	0.10	46.94	-	47.04	-	63.91	53.91	-16.87	-
2	0.451	0.11	37.94	-	38.05	-	56.86	46.86	-18.81	-
3	0.966	0.19	36.35	-	36.54	-	56.00	46.00	-19.46	-
4	1.547	0.20	37.64	-	37.84	-	56.00	46.00	-18.16	-
5	3.547	0.41	36.20	-	36.61	-	56.00	46.00	-19.39	-
6	22.570	0.93	39.61	-	40.54	-	60.00	50.00	-19.46	-

- REMARKS:**
1. Q.P. and AV. are abbreviations of quasi-peak and average individually.
  2. "-": The Quasi-peak reading value also meets average limit and measurement with the average detector is unnecessary.
  3. The emission levels of other frequencies were very low against the limit.
  4. Margin value = Emission level - Limit value
  5. Correction factor = Insertion loss + Cable loss
  6. Emission Level = Correction Factor + Reading Value.

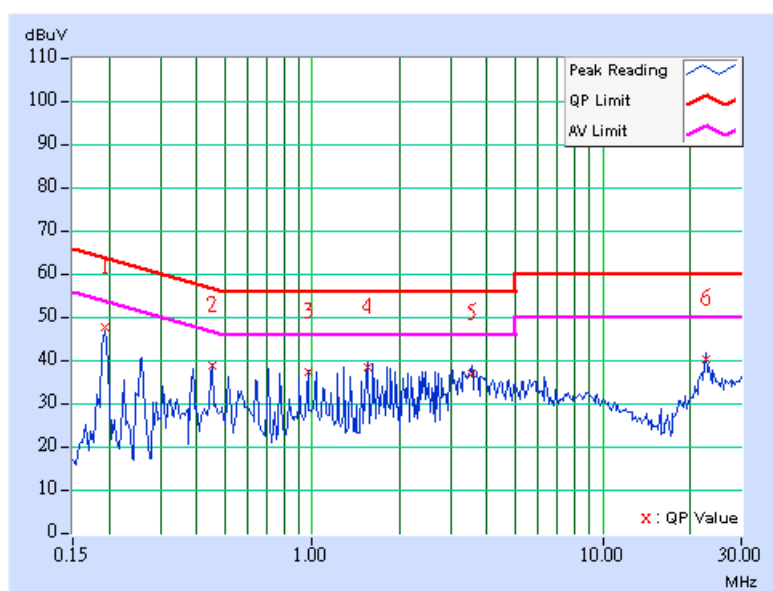



EUT TEST CONDITION		MEASUREMENT DETAIL	
CHANNEL	Channel 11	PHASE	Line 2
MODULATION TYPE	BPSK	6dB BANDWIDTH	9 kHz
TRANSFER RATE	7.2Mbps	INPUT POWER (SYSTEM)	120Vac, 60 Hz
ENVIRONMENTAL CONDITIONS	25deg. C, 65%RH, 991hPa	TESTED BY	Long Chen

No	Freq. [MHz]	Corr. Factor [dB]	Reading Value [dB (uV)]		Emission Level [dB (uV)]		Limit [dB (uV)]		Margin (dB)	
			Q.P.	AV.	Q.P.	AV.	Q.P.	AV.	Q.P.	AV.
			1	0.193	0.10	44.10	-	44.20	-	63.91
2	0.384	0.10	40.25	-	40.35	-	58.18	48.18	-17.83	-
3	0.646	0.10	40.77	-	40.87	-	56.00	46.00	-15.13	-
4	0.966	0.10	40.72	-	40.82	-	56.00	46.00	-15.18	-
5	3.547	0.33	36.50	-	36.83	-	56.00	46.00	-19.17	-
6	22.570	0.63	39.47	-	40.10	-	60.00	50.00	-19.90	-

- REMARKS:**
1. Q.P. and AV. are abbreviations of quasi-peak and average individually.
  2. "-": The Quasi-peak reading value also meets average limit and measurement with the average detector is unnecessary.
  3. The emission levels of other frequencies were very low against the limit.
  4. Margin value = Emission level - Limit value
  5. Correction factor = Insertion loss + Cable loss
  6. Emission Level = Correction Factor + Reading Value.

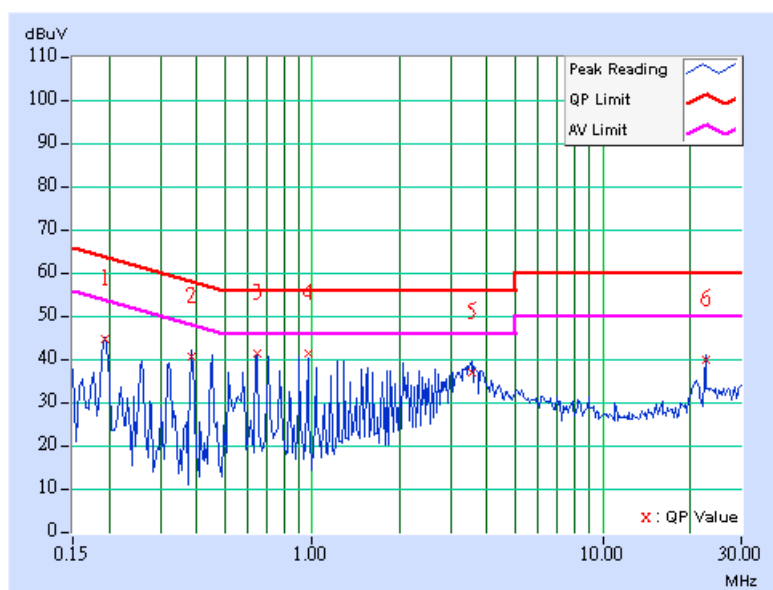

**DRAFT 802.11n (40MHz) OFDM MODULATION: DUAL TX:**

EUT TEST CONDITION		MEASUREMENT DETAIL	
CHANNEL	Channel 1	PHASE	Line 1
MODULATION TYPE	BPSK	6dB BANDWIDTH	9 kHz
TRANSFER RATE	15Mbps	INPUT POWER (SYSTEM)	120Vac, 60 Hz
ENVIRONMENTAL CONDITIONS	25deg. C, 65%RH, 991hPa	TESTED BY	Long Chen

No	Freq. [MHz]	Corr. Factor [dB]	Reading Value [dB (uV)]		Emission Level [dB (uV)]		Limit [dB (uV)]		Margin (dB)	
			Q.P.	AV.	Q.P.	AV.	Q.P.	AV.	Q.P.	AV.
1	0.193	0.10	45.92	-	46.02	-	63.91	53.91	-17.89	-
2	0.259	0.10	39.17	-	39.27	-	61.45	51.45	-22.18	-
3	0.709	0.15	36.96	-	37.11	-	56.00	46.00	-18.89	-
4	1.547	0.20	37.62	-	37.82	-	56.00	46.00	-18.18	-
5	3.480	0.40	35.43	-	35.83	-	56.00	46.00	-20.17	-
6	22.570	0.93	39.81	-	40.74	-	60.00	50.00	-19.26	-

- REMARKS:**
1. Q.P. and AV. are abbreviations of quasi-peak and average individually.
  2. "-": The Quasi-peak reading value also meets average limit and measurement with the average detector is unnecessary.
  3. The emission levels of other frequencies were very low against the limit.
  4. Margin value = Emission level - Limit value
  5. Correction factor = Insertion loss + Cable loss
  6. Emission Level = Correction Factor + Reading Value.

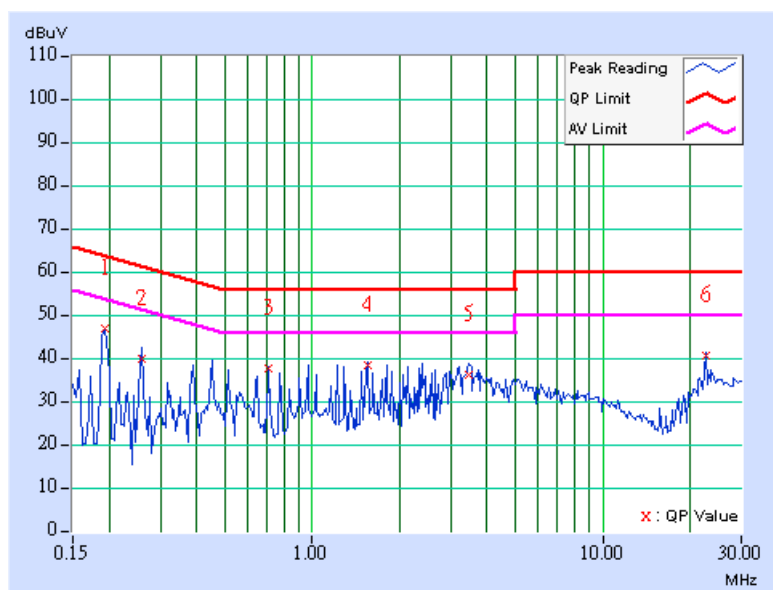

EUT TEST CONDITION		MEASUREMENT DETAIL	
CHANNEL	Channel 1	PHASE	Line 2
MODULATION TYPE	BPSK	6dB BANDWIDTH	9 kHz
TRANSFER RATE	15Mbps	INPUT POWER (SYSTEM)	120Vac, 60 Hz
ENVIRONMENTAL CONDITIONS	25deg. C, 65%RH, 991hPa	TESTED BY	Long Chen

No	Freq. [MHz]	Corr. Factor [dB]	Reading Value [dB (uV)]		Emission Level [dB (uV)]		Limit [dB (uV)]		Margin (dB)	
			Q.P.	AV.	Q.P.	AV.	Q.P.	AV.	Q.P.	AV.
			1	0.193	0.10	44.20	-	44.30	-	63.91
2	0.451	0.10	40.98	-	41.08	-	56.86	46.86	-15.78	-
3	0.709	0.10	40.91	-	41.01	-	56.00	46.00	-14.99	-
4	1.227	0.12	39.80	-	39.92	-	56.00	46.00	-16.08	-
5	3.223	0.30	34.95	-	35.25	-	56.00	46.00	-20.75	-
6	22.570	0.63	39.57	-	40.20	-	60.00	50.00	-19.80	-

- REMARKS:**
1. Q.P. and AV. are abbreviations of quasi-peak and average individually.
  2. "-": The Quasi-peak reading value also meets average limit and measurement with the average detector is unnecessary.
  3. The emission levels of other frequencies were very low against the limit.
  4. Margin value = Emission level - Limit value
  5. Correction factor = Insertion loss + Cable loss
  6. Emission Level = Correction Factor + Reading Value.

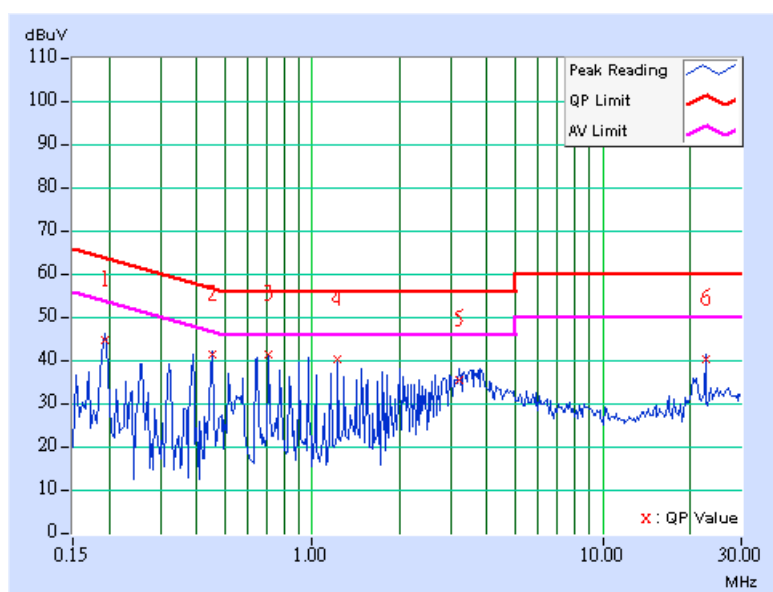

EUT TEST CONDITION		MEASUREMENT DETAIL	
CHANNEL	Channel 4	PHASE	Line 1
MODULATION TYPE	BPSK	6dB BANDWIDTH	9 kHz
TRANSFER RATE	15Mbps	INPUT POWER (SYSTEM)	120Vac, 60 Hz
ENVIRONMENTAL CONDITIONS	25deg. C, 65%RH, 991hPa	TESTED BY	Long Chen

No	Freq. [MHz]	Corr. Factor [dB]	Reading Value [dB (uV)]		Emission Level [dB (uV)]		Limit [dB (uV)]		Margin (dB)	
			Q.P.	AV.	Q.P.	AV.	Q.P.	AV.	Q.P.	AV.
			1	0.193	0.10	46.90	-	46.00	-	63.91
2	0.259	0.10	39.13	-	39.23	-	61.45	51.45	-22.22	-
3	0.451	0.11	37.88	-	37.99	-	56.86	46.86	-18.87	-
4	1.289	0.20	36.67	-	36.87	-	56.00	46.00	-19.13	-
5	3.547	0.41	36.44	-	36.85	-	56.00	46.00	-19.15	-
6	22.570	0.93	40.13	-	41.06	-	60.00	50.00	-18.94	-

- REMARKS:**
1. Q.P. and AV. are abbreviations of quasi-peak and average individually.
  2. "-": The Quasi-peak reading value also meets average limit and measurement with the average detector is unnecessary.
  3. The emission levels of other frequencies were very low against the limit.
  4. Margin value = Emission level - Limit value
  5. Correction factor = Insertion loss + Cable loss
  6. Emission Level = Correction Factor + Reading Value.

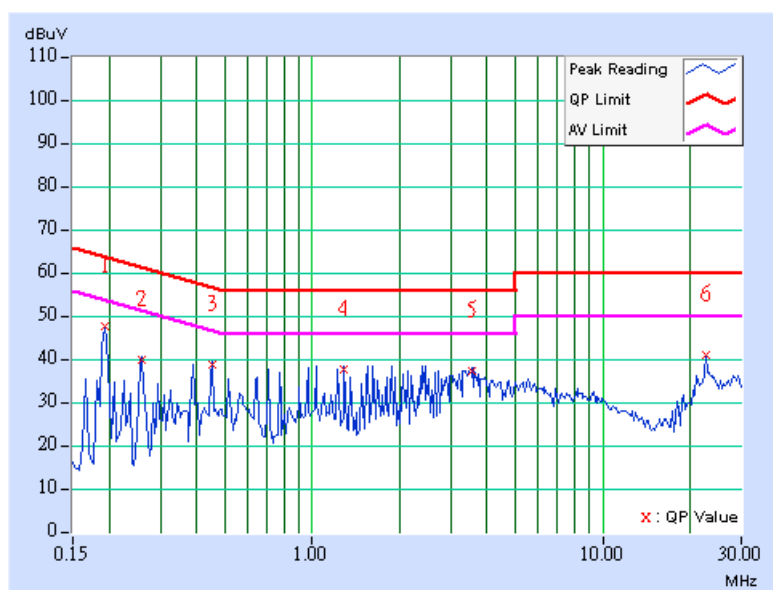

EUT TEST CONDITION		MEASUREMENT DETAIL	
CHANNEL	Channel 4	PHASE	Line 2
MODULATION TYPE	BPSK	6dB BANDWIDTH	9 kHz
TRANSFER RATE	15Mbps	INPUT POWER (SYSTEM)	120Vac, 60 Hz
ENVIRONMENTAL CONDITIONS	25deg. C, 65%RH, 991hPa	TESTED BY	Long Chen

No	Freq. [MHz]	Corr. Factor [dB]	Reading Value [dB (uV)]		Emission Level [dB (uV)]		Limit [dB (uV)]		Margin (dB)	
			Q.P.	AV.	Q.P.	AV.	Q.P.	AV.	Q.P.	AV.
			1	0.193	0.10	43.96	-	44.06	-	63.91
2	0.388	0.10	41.15	-	41.25	-	58.10	48.10	-16.85	-
3	0.646	0.10	40.71	-	40.81	-	56.00	46.00	-15.19	-
4	0.966	0.10	40.48	-	40.58	-	56.00	46.00	-15.42	-
5	3.289	0.31	36.07	-	36.38	-	56.00	46.00	-19.62	-
6	22.570	0.63	39.49	-	40.12	-	60.00	50.00	-19.88	-

- REMARKS:**
1. Q.P. and AV. are abbreviations of quasi-peak and average individually.
  2. "-": The Quasi-peak reading value also meets average limit and measurement with the average detector is unnecessary.
  3. The emission levels of other frequencies were very low against the limit.
  4. Margin value = Emission level - Limit value
  5. Correction factor = Insertion loss + Cable loss
  6. Emission Level = Correction Factor + Reading Value.

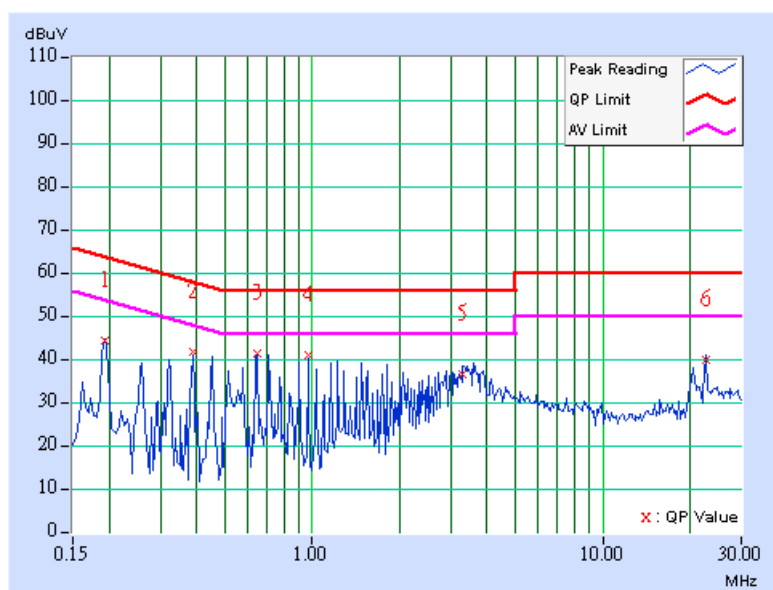

EUT TEST CONDITION		MEASUREMENT DETAIL	
CHANNEL	Channel 7	PHASE	Line 1
MODULATION TYPE	BPSK	6dB BANDWIDTH	9 kHz
TRANSFER RATE	15Mbps	INPUT POWER (SYSTEM)	120Vac, 60 Hz
ENVIRONMENTAL CONDITIONS	25deg. C, 65%RH, 991hPa	TESTED BY	Long Chen

No	Freq. [MHz]	Corr. Factor [dB]	Reading Value [dB (uV)]		Emission Level [dB (uV)]		Limit [dB (uV)]		Margin (dB)	
			Q.P.	AV.	Q.P.	AV.	Q.P.	AV.	Q.P.	AV.
1	0.193	0.10	45.90	-	46.00	-	63.91	53.91	-17.91	-
2	0.451	0.11	38.74	-	38.85	-	56.86	46.86	-18.01	-
3	1.031	0.20	36.38	-	36.58	-	56.00	46.00	-19.42	-
4	1.805	0.20	36.26	-	36.46	-	56.00	46.00	-19.54	-
5	3.613	0.42	36.23	-	36.65	-	56.00	46.00	-19.35	-
6	22.570	0.93	39.28	-	40.21	-	60.00	50.00	-19.79	-

- REMARKS:**
1. Q.P. and AV. are abbreviations of quasi-peak and average individually.
  2. "-": The Quasi-peak reading value also meets average limit and measurement with the average detector is unnecessary.
  3. The emission levels of other frequencies were very low against the limit.
  4. Margin value = Emission level - Limit value
  5. Correction factor = Insertion loss + Cable loss
  6. Emission Level = Correction Factor + Reading Value.

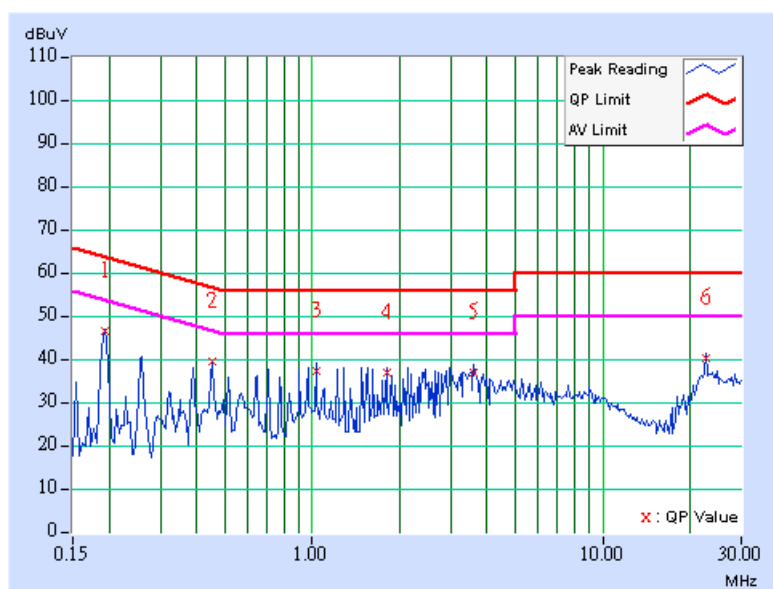

EUT TEST CONDITION		MEASUREMENT DETAIL	
CHANNEL	Channel 7	PHASE	Line 2
MODULATION TYPE	BPSK	6dB BANDWIDTH	9 kHz
TRANSFER RATE	15Mbps	INPUT POWER (SYSTEM)	120Vac, 60 Hz
ENVIRONMENTAL CONDITIONS	25deg. C, 65%RH, 991hPa	TESTED BY	Long Chen

No	Freq. [MHz]	Corr. Factor [dB]	Reading Value [dB (uV)]		Emission Level [dB (uV)]		Limit [dB (uV)]		Margin (dB)	
			Q.P.	AV.	Q.P.	AV.	Q.P.	AV.	Q.P.	AV.
			1	0.193	0.10	43.84	-	43.94	-	63.91
2	0.388	0.10	41.19	-	41.29	-	58.10	48.10	-16.81	-
3	0.709	0.10	40.63	-	40.73	-	56.00	46.00	-15.27	-
4	0.966	0.10	40.29	-	40.39	-	56.00	46.00	-15.61	-
5	3.484	0.33	35.68	-	36.01	-	56.00	46.00	-19.99	-
6	22.570	0.63	40.10	-	40.73	-	60.00	50.00	-19.27	-

- REMARKS:**
1. Q.P. and AV. are abbreviations of quasi-peak and average individually.
  2. "-": The Quasi-peak reading value also meets average limit and measurement with the average detector is unnecessary.
  3. The emission levels of other frequencies were very low against the limit.
  4. Margin value = Emission level - Limit value
  5. Correction factor = Insertion loss + Cable loss
  6. Emission Level = Correction Factor + Reading Value.

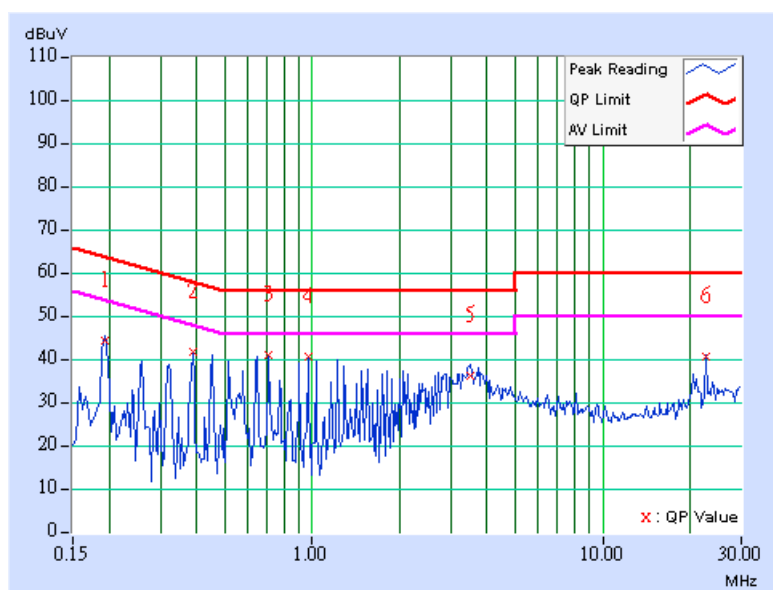

## 4.2 RADIATED EMISSION MEASUREMENT

### 4.2.1 LIMITS OF RADIATED EMISSION MEASUREMENT

Emissions radiated outside of the specified bands, shall be according to the general radiated limits in 15.209 as following:

FREQUENCIES (MHz)	FIELD STRENGTH (microvolts/meter)	MEASUREMENT DISTANCE (meters)
0.009 ~ 0.490	2400 / F(kHz)	300
0.490 ~ 1.705	24000 / F(kHz)	30
1.705 ~ 30.0	30	30
30 ~ 88	100	3
88 ~ 216	150	3
216 ~ 960	200	3
Above 960	500	3

**NOTE:**

1. The lower limit shall apply at the transition frequencies.
2. Emission level (dBuV/m) = 20 log Emission level (uV/m).
3. As shown in 15.35(b), for frequencies above 1000MHz, the field strength limits are based on average detector, however, the peak field strength of any emission shall not exceed the maximum permitted average limits, specified above by more than 20dB under any condition of modulation.



#### 4.2.2 TEST INSTRUMENTS

DESCRIPTION & MANUFACTURER	MODEL NO.	SERIAL NO.	CALIBRATED UNTIL
Test Receiver ROHDE & SCHWARZ	ESIB7	100188	Dec. 20, 2006
Spectrum Analyzer ROHDE & SCHWARZ	FSP40	100039	Nov. 27, 2006
BILOG Antenna SCHWARZBECK	VULB9168	9168-157	Jan. 15, 2007
HORN Antenna SCHWARZBECK	BBHA 9120 D	9120D-407	Jan. 22, 2007
HORN Antenna SCHWARZBECK	BBHA 9170	BBHA9170147	Jan. 26, 2007
Preamplifier Agilent	8449B	3008A01961	Oct. 23, 2006
Preamplifier Agilent	8447D	2944A10629	Oct. 27, 2006
RF signal cable HUBER+SUHNER	SUCOFLEX 104	214380/4	Jan. 16, 2007
RF signal cable HUBER+SUHNER	SUCOFLEX 104	219266/4	Jan. 16, 2007
Software ADT.	ADT_Radiated_V5.14	NA	NA
Antenna Tower ADT.	AT100	AT93021702	NA
Turn Table ADT.	TT100.	TT93021702	NA
Controller ADT.	SC100.	SC93021702	NA

- NOTE:**
1. The calibration interval of the above test instruments is 12 months and the calibrations are traceable to NML/ROC and NIST/USA.
  2. The test was performed in HwaYa Chamber 1.
  3. The horn antenna and HP preamplifier (model: 8449B) are used only for the measurement of emission frequency above 1GHz if tested.
  4. The IC Site Registration No. is IC4924-2.

#### 4.2.3 TEST PROCEDURES

- a. The EUT was placed on the top of a rotating table 0.8 meters above the ground at a 3 meters semi-anechoic chamber. The table was rotated 360 degrees to determine the position of the highest radiation.
- b. The EUT was set 3 meters away from the interference-receiving antenna, which was mounted on the top of a variable-height antenna tower.
- c. The antenna is a broadband antenna, and its height is varied from one meter to four meters above the ground to determine the maximum value of the field strength. Both horizontal and vertical polarizations of the antenna are set to make the measurement.
- d. For each suspected emission, the EUT was arranged to its worst case and then the antenna was tuned to heights from 1 meter to 4 meters and the rotatable table was turned from 0 degrees to 360 degrees to find the maximum reading.
- e. The test-receiver system was set to Peak Detect Function and Specified Bandwidth with Maximum Hold Mode.
- f. If the emission level of the EUT in peak mode was lower than the limit specified, then testing could be stopped and the peak values of the EUT would be reported. Otherwise the emissions would be re-tested one by one using peak, quasi-peak or average method as specified and then reported in a data sheet.

**NOTE:**

1. The resolution bandwidth and video bandwidth of test receiver/spectrum analyzer is 120kHz for Peak detection (PK) and Quasi-peak detection (QP) at frequency below 1GHz.
2. The resolution bandwidth and video bandwidth of test receiver/spectrum analyzer is 1 MHz for Peak detection at frequency above 1GHz.
3. The resolution bandwidth of test receiver/spectrum analyzer is 1MHz and the video bandwidth is 10Hz for Average detection (AV) at frequency above 1GHz.

#### 4.2.4 DEVIATION FROM TEST STANDARD

No deviation

#### 4.2.5 TEST SETUP

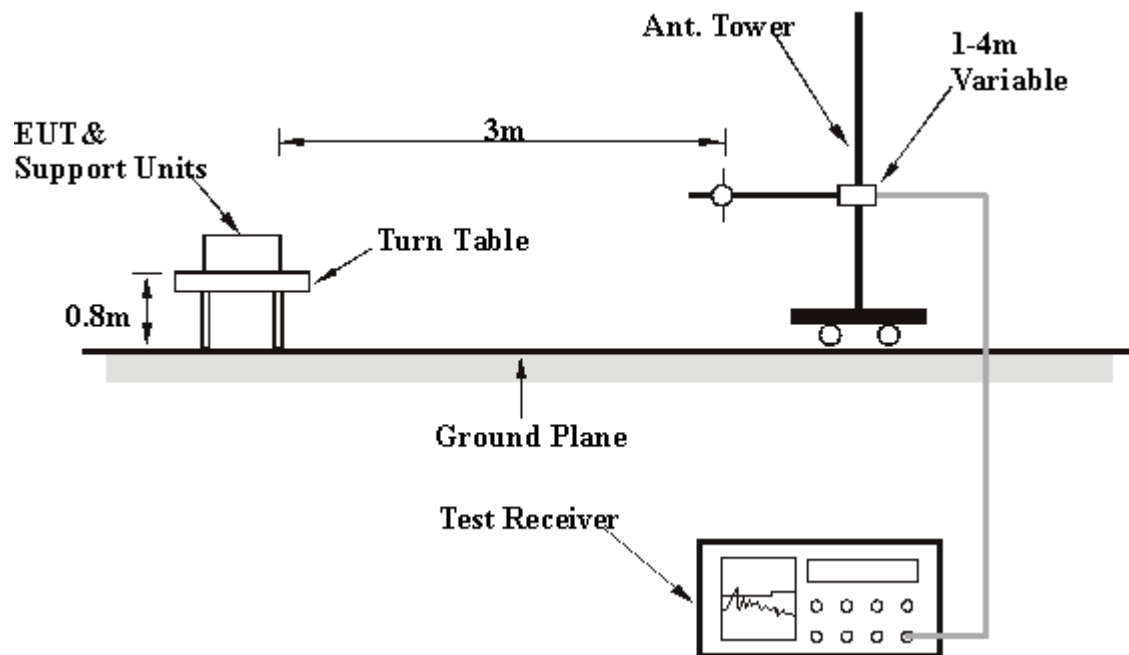

For the actual test configuration, please refer to the related item – Photographs of the Test Configuration.

#### 4.2.6 EUT OPERATING CONDITIONS

Same as item 4.1.6.



## 4.2.7 TEST RESULTS

### BELOW 1GHz WORST-CASE DATA: 802.11g OFDM MODULATION: DUAL TX:

EUT TEST CONDITION		MEASUREMENT DETAIL	
CHANNEL	Channel 1	FREQUENCY RANGE	Below 1000MHz
MODULATION TYPE	BPSK	INPUT POWER (SYSTEM)	120Vac, 60 Hz
TRANSFER RATE	6Mbps	DETECTOR FUNCTION	Quasi-Peak
ENVIRONMENTAL CONDITIONS	25deg. C, 70%RH, 991hPa	TESTED BY	Lori Chiu

ANTENNA POLARITY & TEST DISTANCE: HORIZONTAL AT 3 M								
No.	Freq. (MHz)	Emission Level (dBuV/m)	Limit (dBuV/m)	Margin (dB)	Antenna Height (m)	Table Angle (Degree)	Raw Value (dBuV)	Correction Factor (dB/m)
1	236.05	39.16 QP	46.00	-6.84	2.50 H	352	27.15	12.01
2	267.15	42.79 QP	46.00	-3.21	1.00 H	232	29.11	13.68
3	302.14	36.87 QP	46.00	-9.13	2.50 H	352	21.22	15.64
4	370.18	34.89 QP	46.00	-11.11	1.00 H	355	17.94	16.95
5	453.77	31.60 QP	46.00	-14.40	2.50 H	112	12.57	19.04
6	482.93	29.13 QP	46.00	-16.87	3.00 H	37	9.44	19.68
7	675.37	30.88 QP	46.00	-15.12	3.00 H	79	7.29	23.59
8	733.69	32.70 QP	46.00	-13.30	1.50 H	349	7.46	25.24
9	768.68	31.33 QP	46.00	-14.67	4.00 H	13	5.47	25.86
10	811.44	31.70 QP	46.00	-14.30	2.50 H	112	5.55	26.15
11	817.27	29.64 QP	46.00	-16.36	1.00 H	280	3.40	26.23
12	873.65	31.59 QP	46.00	-14.41	2.50 H	112	4.72	26.87
13	881.42	32.67 QP	46.00	-13.33	1.00 H	232	5.74	26.93

ANTENNA POLARITY & TEST DISTANCE: VERTICAL AT 3 M								
No.	Freq. (MHz)	Emission Level (dBuV/m)	Limit (dBuV/m)	Margin (dB)	Antenna Height (m)	Table Angle (Degree)	Raw Value (dBuV)	Correction Factor (dB/m)
1	51.38	23.40 QP	40.00	-16.60	1.50 V	352	9.15	14.25
2	267.15	31.69 QP	46.00	-14.31	1.00 V	310	18.01	13.68
3	480.98	29.66 QP	46.00	-16.34	1.50 V	352	10.02	19.64
4	675.37	30.99 QP	46.00	-15.01	1.50 V	358	7.40	23.59
5	813.39	31.25 QP	46.00	-14.75	1.50 V	118	5.07	26.18
6	821.16	29.49 QP	46.00	-16.51	1.00 V	310	3.21	26.28
7	846.43	29.56 QP	46.00	-16.44	1.00 V	220	2.94	26.63
8	881.42	29.23 QP	46.00	-16.77	1.00 V	43	2.30	26.93
9	933.91	32.35 QP	46.00	-13.65	1.00 V	40	3.69	28.66
10	943.63	32.84 QP	46.00	-13.16	1.00 V	43	3.72	29.12

- REMARKS:**
1. Emission level(dBuV/m)=Raw Value(dBuV) + Correction Factor(dB/m)
  2. Correction Factor(dB/m) = Antenna Factor (dB/m) + Cable Factor (dB)
  3. The other emission levels were very low against the limit.
  4. Margin value = Emission level – Limit value.

**DRAFT 802.11n (20MHz) OFDM MODULATION: DUAL TX:**

EUT TEST CONDITION		MEASUREMENT DETAIL	
CHANNEL	Channel 1	FREQUENCY RANGE	Below 1000MHz
MODULATION TYPE	BPSK	INPUT POWER (SYSTEM)	120Vac, 60 Hz
TRANSFER RATE	7.2Mbps	DETECTOR FUNCTION	Quasi-Peak
ENVIRONMENTAL CONDITIONS	25deg. C, 70%RH, 991hPa	TESTED BY	Lori Chiu

**ANTENNA POLARITY & TEST DISTANCE: HORIZONTAL AT 3 M**

No.	Freq. (MHz)	Emission Level (dBuV/m)	Limit (dBuV/m)	Margin (dB)	Antenna Height (m)	Table Angle (Degree)	Raw Value (dBuV)	Correction Factor (dB/m)
1	236.05	38.16 QP	46.00	-7.84	1.00 H	67	26.15	12.01
2	269.10	40.49 QP	46.00	-5.51	1.00 H	67	26.47	14.01
3	302.14	36.12 QP	46.00	-9.88	1.00 H	67	20.48	15.64
4	368.24	34.82 QP	46.00	-11.18	1.00 H	67	17.93	16.89
5	453.77	31.47 QP	46.00	-14.53	1.50 H	301	12.43	19.04
6	488.76	30.74 QP	46.00	-15.26	2.00 H	349	10.92	19.81
7	675.37	30.06 QP	46.00	-15.94	1.00 H	10	6.47	23.59
8	733.69	31.56 QP	46.00	-14.44	1.00 H	19	6.32	25.24
9	768.68	31.73 QP	46.00	-14.27	2.50 H	73	5.87	25.86
10	811.44	32.86 QP	46.00	-13.14	1.50 H	301	6.71	26.15
11	817.27	30.21 QP	46.00	-15.79	1.50 H	142	3.98	26.23
12	881.42	31.20 QP	46.00	-14.80	2.50 H	103	4.27	26.93

**ANTENNA POLARITY & TEST DISTANCE: VERTICAL AT 3 M**

No.	Freq. (MHz)	Emission Level (dBuV/m)	Limit (dBuV/m)	Margin (dB)	Antenna Height (m)	Table Angle (Degree)	Raw Value (dBuV)	Correction Factor (dB/m)
1	37.78	27.27 QP	40.00	-12.73	1.50 V	346	13.47	13.80
2	302.14	31.43 QP	46.00	-14.57	1.50 V	346	15.79	15.64
3	453.77	29.64 QP	46.00	-16.36	1.00 V	127	10.60	19.04
4	482.93	29.00 QP	46.00	-17.00	1.00 V	217	9.32	19.68
5	607.33	29.13 QP	46.00	-16.87	2.00 V	352	6.56	22.57
6	675.37	29.47 QP	46.00	-16.53	1.00 V	352	5.88	23.59
7	698.70	30.10 QP	46.00	-15.90	1.50 V	346	5.99	24.11
8	737.58	29.10 QP	46.00	-16.90	2.00 V	352	3.73	25.37
9	809.50	30.11 QP	46.00	-15.89	1.00 V	91	3.98	26.13
10	881.42	29.81 QP	46.00	-16.19	1.00 V	163	2.88	26.93
11	933.91	33.36 QP	46.00	-12.64	1.00 V	91	4.70	28.66
12	951.40	30.41 QP	46.00	-15.59	1.00 V	319	1.02	29.39

- REMARKS:**
1. Emission level(dBuV/m)=Raw Value(dBuV) + Correction Factor(dB/m)
  2. Correction Factor(dB/m) = Antenna Factor (dB/m) + Cable Factor (dB)
  3. The other emission levels were very low against the limit.
  4. Margin value = Emission level – Limit value.



**DRAFT 802.11n (40MHz) OFDM MODULATION: DUAL TX:**

EUT TEST CONDITION		MEASUREMENT DETAIL	
CHANNEL	Channel 1	FREQUENCY RANGE	Below 1000MHz
MODULATION TYPE	BPSK	INPUT POWER (SYSTEM)	120Vac, 60 Hz
TRANSFER RATE	15Mbps	DETECTOR FUNCTION	Quasi-Peak
ENVIRONMENTAL CONDITIONS	25deg. C, 70%RH, 991hPa	TESTED BY	Lori Chiu

ANTENNA POLARITY & TEST DISTANCE: HORIZONTAL AT 3 M								
No.	Freq. (MHz)	Emission Level (dBuV/m)	Limit (dBuV/m)	Margin (dB)	Antenna Height (m)	Table Angle (Degree)	Raw Value (dBuV)	Correction Factor (dB/m)
1	236.05	37.78 QP	46.00	-8.22	1.00 H	109	25.77	12.01
2	269.10	39.79 QP	46.00	-6.21	1.00 H	109	25.78	14.01
3	302.14	36.44 QP	46.00	-9.56	1.00 H	109	20.80	15.64
4	368.24	34.52 QP	46.00	-11.48	1.00 H	109	17.63	16.89
5	453.77	31.54 QP	46.00	-14.46	2.50 H	70	12.51	19.04
6	733.69	31.42 QP	46.00	-14.58	2.00 H	22	6.18	25.24
7	768.68	32.40 QP	46.00	-13.60	2.50 H	52	6.54	25.86
8	805.61	32.44 QP	46.00	-13.56	1.00 H	307	6.37	26.07
9	817.27	31.59 QP	46.00	-14.41	1.50 H	184	5.36	26.23
10	881.42	32.82 QP	46.00	-13.18	2.00 H	46	5.89	26.93

ANTENNA POLARITY & TEST DISTANCE: VERTICAL AT 3 M								
No.	Freq. (MHz)	Emission Level (dBuV/m)	Limit (dBuV/m)	Margin (dB)	Antenna Height (m)	Table Angle (Degree)	Raw Value (dBuV)	Correction Factor (dB/m)
1	482.93	29.85 QP	46.00	-16.15	1.00 V	352	10.16	19.68
2	671.48	31.10 QP	46.00	-14.90	1.00 V	292	7.60	23.50
3	690.92	29.51 QP	46.00	-16.49	1.00 V	220	5.58	23.94
4	733.69	29.03 QP	46.00	-16.97	1.00 V	292	3.79	25.24
5	792.00	37.09 QP	46.00	-8.91	1.50 V	253	11.13	25.96
6	821.16	29.97 QP	46.00	-16.03	1.00 V	232	3.69	26.28
7	871.70	29.32 QP	46.00	-16.68	1.00 V	115	2.47	26.85
8	881.42	29.97 QP	46.00	-16.03	1.00 V	313	3.04	26.93
9	933.91	33.55 QP	46.00	-12.45	1.00 V	115	4.89	28.66
10	945.57	30.38 QP	46.00	-15.62	1.00 V	232	1.17	29.21

- REMARKS:**
1. Emission level(dBuV/m)=Raw Value(dBuV) + Correction Factor(dB/m)
  2. Correction Factor(dB/m) = Antenna Factor (dB/m) + Cable Factor (dB)
  3. The other emission levels were very low against the limit.
  4. Margin value = Emission level – Limit value.

**802.11b DSSS MODULATION: DUAL TX:**

EUT TEST CONDITION		MEASUREMENT DETAIL	
CHANNEL	Channel 1	FREQUENCY RANGE	1 ~ 25GHz
MODULATION TYPE	DBPSK	INPUT POWER (SYSTEM)	120Vac, 60 Hz
TRANSFER RATE	1Mbps	DETECTOR FUNCTION	Peak(PK) Average (AV)
ENVIRONMENTAL CONDITIONS	26deg. C, 70%RH, 991hPa	TESTED BY	Lori Chiu

ANTENNA POLARITY & TEST DISTANCE: HORIZONTAL AT 3 M								
No.	Freq. (MHz)	Emission Level (dBuV/m)	Limit (dBuV/m)	Margin (dB)	Antenna Height (m)	Table Angle (Degree)	Raw Value (dBuV)	Correction Factor (dB/m)
1	2390.00	57.81 PK	74.00	-16.19	1.25 H	133	26.42	31.39
1	2390.00	46.62 AV	54.00	-7.38	1.25 H	133	15.23	31.39
2	*2412.00	104.00 PK			1.22 H	135	72.54	31.46
2	*2412.00	100.00 AV			1.22 H	135	68.54	31.46
3	2483.50	58.98 PK	74.00	-15.02	1.24 H	132	27.28	31.70
3	2483.50	47.37 AV	54.00	-6.63	1.24 H	132	15.67	31.70
4	4824.00	46.72 PK	74.00	-27.28	1.35 H	227	9.59	37.13
4	4824.00	39.54 AV	54.00	-14.46	1.35 H	227	2.41	37.13

ANTENNA POLARITY & TEST DISTANCE: VERTICAL AT 3 M								
No.	Freq. (MHz)	Emission Level (dBuV/m)	Limit (dBuV/m)	Margin (dB)	Antenna Height (m)	Table Angle (Degree)	Raw Value (dBuV)	Correction Factor (dB/m)
1	2250.00	57.52 PK	74.00	-16.48	1.57 V	96	26.62	30.89
1	2250.00	50.80 AV	54.00	-3.20	1.57 V	96	19.91	30.89
2	2390.00	63.01 PK	74.00	-10.99	1.38 V	92	31.62	31.39
2	2390.00	52.03 AV	54.00	-1.97	1.38 V	92	20.64	31.39
3	*2412.00	110.88 PK			1.64 V	95	79.42	31.46
3	*2412.00	107.32 AV			1.64 V	95	75.86	31.46
4	2483.50	61.67 PK	74.00	-12.33	1.60 V	93	29.97	31.70
4	2483.50	52.42 AV	54.00	-1.58	1.60 V	93	20.72	31.70
5	3220.00	45.75 PK	74.00	-28.25	1.35 V	128	12.63	33.12
5	3220.00	36.51 AV	54.00	-17.49	1.35 V	128	3.39	33.12
6	4824.00	48.67 PK	74.00	-25.33	1.30 V	120	11.54	37.13
6	4824.00	41.23 AV	54.00	-12.77	1.30 V	120	4.10	37.13

- REMARKS:**
1. Emission level (dBuV/m) = Raw Value (dBuV) + Correction Factor (dB/m).
  2. Correction Factor (dB/m) = Antenna Factor (dB/m) + Cable Factor (dB).
  3. The other emission levels were very low against the limit.
  4. Margin value = Emission level – Limit value.
  5. The limit value is defined as per 15.247.
  6. “ \* “: Fundamental frequency.

EUT TEST CONDITION		MEASUREMENT DETAIL	
CHANNEL	Channel 6	FREQUENCY RANGE	1 ~ 25GHz
MODULATION TYPE	DBPSK	INPUT POWER (SYSTEM)	120Vac, 60 Hz
TRANSFER RATE	1Mbps	DETECTOR FUNCTION	Peak(PK) Average (AV)
ENVIRONMENTAL CONDITIONS	26deg. C, 70%RH, 991hPa	TESTED BY	Lori Chiu

ANTENNA POLARITY & TEST DISTANCE: HORIZONTAL AT 3 M								
No.	Freq. (MHz)	Emission Level (dBuV/m)	Limit (dBuV/m)	Margin (dB)	Antenna Height (m)	Table Angle (Degree)	Raw Value (dBuV)	Correction Factor (dB/m)
1	2234.00	54.11 PK	74.00	-19.89	1.39 H	129	23.27	30.84
1	2234.00	46.14 AV	54.00	-7.86	1.39 H	129	15.30	30.84
2	2390.00	56.87 PK	74.00	-17.13	1.47 H	128	25.48	31.39
2	2390.00	46.54 AV	54.00	-7.46	1.47 H	128	15.15	31.39
3	*2437.00	103.57 PK			1.44 H	129	72.03	31.54
3	*2437.00	99.86 AV			1.44 H	129	68.32	31.54
4	2483.50	57.59 PK	74.00	-16.41	1.39 H	126	25.89	31.70
4	2483.50	47.71 AV	54.00	-6.29	1.39 H	126	16.01	31.70

ANTENNA POLARITY & TEST DISTANCE: VERTICAL AT 3 M								
No.	Freq. (MHz)	Emission Level (dBuV/m)	Limit (dBuV/m)	Margin (dB)	Antenna Height (m)	Table Angle (Degree)	Raw Value (dBuV)	Correction Factor (dB/m)
1	2234.00	58.57 PK	74.00	-15.43	1.18 V	96	27.73	30.84
1	2234.00	49.90 AV	54.00	-4.10	1.18 V	96	19.06	30.84
2	2390.00	61.63 PK	74.00	-12.37	1.36 V	96	30.24	31.39
2	2390.00	51.97 AV	54.00	-2.03	1.36 V	96	20.58	31.39
3	*2437.00	110.79 PK			1.36 V	96	79.25	31.54
3	*2437.00	106.75 AV			1.36 V	96	75.21	31.54
4	2483.50	62.59 PK	74.00	-11.41	1.22 V	128	30.89	31.70
4	2483.50	52.70 AV	54.00	-1.30	1.22 V	128	21.00	31.70
5	3220.00	45.69 PK	74.00	-28.31	1.33 V	129	12.57	33.12
5	3220.00	36.55 AV	54.00	-17.45	1.33 V	129	3.43	33.12
6	4874.00	48.50 PK	74.00	-25.50	1.08 V	168	11.21	37.29
6	4874.00	41.42 AV	54.00	-12.58	1.08 V	168	4.13	37.29

- REMARKS:**
1. Emission level (dBuV/m) = Raw Value (dBuV) + Correction Factor (dB/m).
  2. Correction Factor (dB/m) = Antenna Factor (dB/m) + Cable Factor (dB).
  3. The other emission levels were very low against the limit.
  4. Margin value = Emission level – Limit value.
  5. The limit value is defined as per 15.247.
  6. “ \* “: Fundamental frequency.



EUT TEST CONDITION		MEASUREMENT DETAIL	
<b>CHANNEL</b>	Channel 11	<b>FREQUENCY RANGE</b>	1 ~ 25GHz
<b>MODULATION TYPE</b>	DBPSK	<b>INPUT POWER (SYSTEM)</b>	120Vac, 60 Hz
<b>TRANSFER RATE</b>	1Mbps	<b>DETECTOR FUNCTION</b>	Peak(PK) Average (AV)
<b>ENVIRONMENTAL CONDITIONS</b>	26deg. C, 70%RH, 991hPa	<b>TESTED BY</b>	Lori Chiu

ANTENNA POLARITY & TEST DISTANCE: HORIZONTAL AT 3 M								
No.	Freq. (MHz)	Emission Level (dBuV/m)	Limit (dBuV/m)	Margin (dB)	Antenna Height (m)	Table Angle (Degree)	Raw Value (dBuV)	Correction Factor (dB/m)
1	2260.00	53.63 PK	74.00	-20.37	1.19 H	205	22.70	30.93
1	2260.00	44.08 AV	54.00	-9.92	1.19 H	205	13.15	30.93
2	2390.00	57.22 PK	74.00	-16.78	1.19 H	133	25.83	31.39
2	2390.00	46.42 AV	54.00	-7.58	1.19 H	133	15.03	31.39
3	*2462.00	102.81 PK			1.16 H	130	71.19	31.62
3	*2462.00	98.24 AV			1.16 H	130	66.62	31.62
4	2483.50	57.60 PK	74.00	-16.40	1.20 H	131	25.90	31.70
4	2483.50	46.91 AV	54.00	-7.09	1.20 H	131	15.21	31.70

ANTENNA POLARITY & TEST DISTANCE: VERTICAL AT 3 M								
No.	Freq. (MHz)	Emission Level (dBuV/m)	Limit (dBuV/m)	Margin (dB)	Antenna Height (m)	Table Angle (Degree)	Raw Value (dBuV)	Correction Factor (dB/m)
1	2260.00	59.97 PK	74.00	-14.03	1.36 V	132	29.04	30.93
1	2260.00	50.25 AV	54.00	-3.75	1.36 V	132	19.32	30.93
2	2390.00	59.94 PK	74.00	-14.06	1.35 V	118	28.55	31.39
2	2390.00	52.03 AV	54.00	-1.97	1.35 V	118	20.64	31.39
3	*2462.00	109.30 PK			1.51 V	95	77.68	31.62
3	*2462.00	105.52 AV			1.51 V	95	73.90	31.62
4	2483.50	60.64 PK	74.00	-13.36	1.51 V	92	28.94	31.70
4	2483.50	52.22 AV	54.00	-1.78	1.51 V	92	20.52	31.70
5	3220.00	45.82 PK	74.00	-28.18	1.33 V	130	12.70	33.12
5	3220.00	36.64 AV	54.00	-17.36	1.33 V	130	3.52	33.12
6	4924.00	47.38 PK	74.00	-26.62	1.25 V	111	9.94	37.44
6	4924.00	39.25 AV	54.00	-14.75	1.25 V	111	1.81	37.44

- REMARKS:**
1. Emission level (dBuV/m) = Raw Value (dBuV) + Correction Factor (dB/m).
  2. Correction Factor (dB/m) = Antenna Factor (dB/m) + Cable Factor (dB).
  3. The other emission levels were very low against the limit.
  4. Margin value = Emission level – Limit value.
  5. The limit value is defined as per 15.247.
  6. “ \* “: Fundamental frequency.



**802.11g OFDM MODULATION: DUAL TX:**

EUT TEST CONDITION		MEASUREMENT DETAIL	
CHANNEL	Channel 1	FREQUENCY RANGE	1 ~ 25GHz
MODULATION TYPE	BPSK	INPUT POWER (SYSTEM)	120Vac, 60 Hz
TRANSFER RATE	6Mbps	DETECTOR FUNCTION	Peak(PK) Average (AV)
ENVIRONMENTAL CONDITIONS	26deg. C, 70%RH, 991hPa	TESTED BY	Lori Chiu

ANTENNA POLARITY & TEST DISTANCE: HORIZONTAL AT 3 M								
No.	Freq. (MHz)	Emission Level (dBuV/m)	Limit (dBuV/m)	Margin (dB)	Antenna Height (m)	Table Angle (Degree)	Raw Value (dBuV)	Correction Factor (dB/m)
1	2390.00	58.23 PK	74.00	-15.77	1.04 H	302	26.84	31.39
1	2390.00	47.26 AV	54.00	-6.74	1.04 H	302	15.87	31.39
2	*2412.00	103.35 PK			1.91 H	311	71.89	31.46
2	*2412.00	94.65 AV			1.91 H	311	63.19	31.46
3	2483.50	56.43 PK	74.00	-17.57	1.00 H	305	24.73	31.70
3	2483.50	46.63 AV	54.00	-7.37	1.00 H	305	14.93	31.70

ANTENNA POLARITY & TEST DISTANCE: VERTICAL AT 3 M								
No.	Freq. (MHz)	Emission Level (dBuV/m)	Limit (dBuV/m)	Margin (dB)	Antenna Height (m)	Table Angle (Degree)	Raw Value (dBuV)	Correction Factor (dB/m)
1	2254.00	58.70 PK	74.00	-15.30	1.35 V	144	27.79	30.91
1	2254.00	48.10 AV	54.00	-5.90	1.35 V	144	17.19	30.91
2	2390.00	64.62 PK	74.00	-9.38	1.56 V	92	33.23	31.39
2	2390.00	52.68 AV	54.00	-1.32	1.56 V	92	21.29	31.39
3	*2412.00	112.43 PK			1.64 V	94	80.97	31.46
3	*2412.00	103.24 AV			1.64 V	94	71.78	31.46
4	2483.50	63.22 PK	74.00	-10.78	1.49 V	94	31.52	31.70
4	2483.50	52.41 AV	54.00	-1.59	1.49 V	94	20.71	31.70
5	3216.00	44.09 PK	74.00	-29.91	1.14 V	137	10.98	33.11
5	3216.00	35.40 AV	54.00	-18.60	1.14 V	137	2.29	33.11
6	4824.00	45.61 PK	74.00	-28.39	1.35 V	20	8.48	37.13
6	4824.00	33.03 AV	54.00	-20.97	1.35 V	20	-4.10	37.13

- REMARKS:**
1. Emission level (dBuV/m) = Raw Value (dBuV) + Correction Factor (dB/m).
  2. Correction Factor (dB/m) = Antenna Factor (dB/m) + Cable Factor (dB).
  3. The other emission levels were very low against the limit.
  4. Margin value = Emission level – Limit value.
  5. The limit value is defined as per 15.247.
  6. " \* ": Fundamental frequency.

EUT TEST CONDITION		MEASUREMENT DETAIL	
CHANNEL	Channel 6	FREQUENCY RANGE	1 ~ 25GHz
MODULATION TYPE	BPSK	INPUT POWER (SYSTEM)	120Vac, 60 Hz
TRANSFER RATE	6Mbps	DETECTOR FUNCTION	Peak(PK) Average (AV)
ENVIRONMENTAL CONDITIONS	26deg. C, 70%RH, 991hPa	TESTED BY	Lori Chiu

ANTENNA POLARITY & TEST DISTANCE: HORIZONTAL AT 3 M								
No.	Freq. (MHz)	Emission Level (dBuV/m)	Limit (dBuV/m)	Margin (dB)	Antenna Height (m)	Table Angle (Degree)	Raw Value (dBuV)	Correction Factor (dB/m)
1	2390.00	58.18 PK	74.00	-15.82	1.38 H	134	26.79	31.39
1	2390.00	46.85 AV	54.00	-7.15	1.38 H	134	15.46	31.39
2	*2437.00	103.11 PK			1.43 H	129	71.57	31.54
2	*2437.00	94.62 AV			1.43 H	129	63.08	31.54
3	2483.50	57.35 PK	74.00	-16.65	1.37 H	133	25.65	31.70
3	2483.50	45.68 AV	54.00	-8.32	1.37 H	133	13.98	31.70

ANTENNA POLARITY & TEST DISTANCE: VERTICAL AT 3 M								
No.	Freq. (MHz)	Emission Level (dBuV/m)	Limit (dBuV/m)	Margin (dB)	Antenna Height (m)	Table Angle (Degree)	Raw Value (dBuV)	Correction Factor (dB/m)
1	2390.00	62.11 PK	74.00	-11.89	1.28 V	131	30.72	31.39
1	2390.00	52.35 AV	54.00	-1.65	1.28 V	131	20.96	31.39
2	*2437.00	112.32 PK			1.30 V	120	80.78	31.54
2	*2437.00	103.02 AV			1.30 V	120	71.48	31.54
3	2483.50	61.85 PK	74.00	-12.15	1.28 V	131	30.15	31.70
3	2483.50	51.90 AV	54.00	-2.10	1.28 V	131	20.20	31.70
4	3168.00	46.55 PK	74.00	-27.45	1.28 V	156	13.54	33.01
4	3168.00	37.69 AV	54.00	-16.31	1.28 V	156	4.68	33.01
5	4874.00	45.62 PK	74.00	-28.38	1.33 V	215	8.33	37.29
5	4874.00	33.12 AV	54.00	-20.88	1.33 V	215	-4.17	37.29

- REMARKS:**
1. Emission level (dBuV/m) = Raw Value (dBuV) + Correction Factor (dB/m).
  2. Correction Factor (dB/m) = Antenna Factor (dB/m) + Cable Factor (dB).
  3. The other emission levels were very low against the limit.
  4. Margin value = Emission level – Limit value.
  5. The limit value is defined as per 15.247.
  6. “ \* “: Fundamental frequency.

EUT TEST CONDITION		MEASUREMENT DETAIL	
CHANNEL	Channel 11	FREQUENCY RANGE	1 ~ 25GHz
MODULATION TYPE	BPSK	INPUT POWER (SYSTEM)	120Vac, 60 Hz
TRANSFER RATE	6Mbps	DETECTOR FUNCTION	Peak(PK) Average (AV)
ENVIRONMENTAL CONDITIONS	26deg. C, 70%RH, 991hPa	TESTED BY	Lori Chiu

ANTENNA POLARITY & TEST DISTANCE: HORIZONTAL AT 3 M								
No.	Freq. (MHz)	Emission Level (dBuV/m)	Limit (dBuV/m)	Margin (dB)	Antenna Height (m)	Table Angle (Degree)	Raw Value (dBuV)	Correction Factor (dB/m)
1	2390.00	54.21 PK	74.00	-19.79	1.21 H	307	22.82	31.39
1	2390.00	45.93 AV	54.00	-8.07	1.21 H	307	14.54	31.39
2	*2462.00	101.18 PK			1.24 H	303	69.56	31.62
2	*2462.00	91.64 AV			1.24 H	303	60.02	31.62
3	2483.50	54.87 PK	74.00	-19.13	1.21 H	299	23.17	31.70
3	2483.50	46.76 AV	54.00	-7.24	1.21 H	299	15.06	31.70

ANTENNA POLARITY & TEST DISTANCE: VERTICAL AT 3 M								
No.	Freq. (MHz)	Emission Level (dBuV/m)	Limit (dBuV/m)	Margin (dB)	Antenna Height (m)	Table Angle (Degree)	Raw Value (dBuV)	Correction Factor (dB/m)
1	2390.00	59.32 PK	74.00	-14.68	1.37 V	94	27.93	31.39
1	2390.00	51.32 AV	54.00	-2.68	1.37 V	94	19.93	31.39
2	*2462.00	111.14 PK			1.57 V	93	79.52	31.62
2	*2462.00	101.60 AV			1.57 V	93	69.98	31.62
3	2483.50	63.75 PK	74.00	-10.25	1.44 V	91	32.05	31.70
3	2483.50	52.50 AV	54.00	-1.50	1.44 V	91	20.80	31.70
4	3220.00	44.04 PK	74.00	-29.96	1.10 V	133	10.92	33.12
4	3220.00	35.34 AV	54.00	-18.66	1.10 V	133	2.22	33.12
5	4924.00	45.59 PK	74.00	-28.41	1.35 V	245	8.15	37.44
5	4924.00	33.01 AV	54.00	-20.99	1.35 V	245	-4.43	37.44

- REMARKS:**
1. Emission level (dBuV/m) = Raw Value (dBuV) + Correction Factor (dB/m).
  2. Correction Factor (dB/m) = Antenna Factor (dB/m) + Cable Factor (dB).
  3. The other emission levels were very low against the limit.
  4. Margin value = Emission level – Limit value.
  5. The limit value is defined as per 15.247.
  6. “ \* “: Fundamental frequency.

**DRAFT 802.11n (20MHz) OFDM MODULATION: DUAL TX:**

EUT TEST CONDITION		MEASUREMENT DETAIL	
<b>CHANNEL</b>	Channel 1	<b>FREQUENCY RANGE</b>	1 ~ 25GHz
<b>MODULATION TYPE</b>	BPSK	<b>INPUT POWER (SYSTEM)</b>	120Vac, 60 Hz
<b>TRANSFER RATE</b>	7.2Mbps	<b>DETECTOR FUNCTION</b>	Peak(PK) Average (AV)
<b>ENVIRONMENTAL CONDITIONS</b>	26deg. C, 70%RH, 991hPa	<b>TESTED BY</b>	Lori Chiu

ANTENNA POLARITY & TEST DISTANCE: HORIZONTAL AT 3 M								
No.	Freq. (MHz)	Emission Level (dBuV/m)	Limit (dBuV/m)	Margin (dB)	Antenna Height (m)	Table Angle (Degree)	Raw Value (dBuV)	Correction Factor (dB/m)
1	2250.00	54.06 PK	74.00	-19.94	1.01 H	309	23.17	30.89
1	2250.00	45.70 AV	54.00	-8.30	1.01 H	309	14.80	30.89
2	2390.00	64.27 PK	74.00	-9.73	1.04 H	303	32.88	31.39
2	2390.00	47.96 AV	54.00	-6.04	1.04 H	303	16.57	31.39
3	*2412.00	103.60 PK			1.06 H	310	72.14	31.46
3	*2412.00	94.83 AV			1.06 H	310	63.37	31.46
4	2483.50	60.72 PK	74.00	-13.28	1.05 H	311	29.02	31.70
4	2483.50	48.34 AV	54.00	-5.66	1.05 H	311	16.64	31.70

ANTENNA POLARITY & TEST DISTANCE: VERTICAL AT 3 M								
No.	Freq. (MHz)	Emission Level (dBuV/m)	Limit (dBuV/m)	Margin (dB)	Antenna Height (m)	Table Angle (Degree)	Raw Value (dBuV)	Correction Factor (dB/m)
1	2250.00	60.67 PK	74.00	-13.33	1.38 V	133	29.78	30.89
1	2250.00	48.70 AV	54.00	-5.30	1.38 V	133	17.81	30.89
2	2390.00	65.97 PK	74.00	-8.03	1.41 V	95	34.58	31.39
2	2390.00	52.44 AV	54.00	-1.56	1.41 V	95	21.05	31.39
3	*2412.00	112.47 PK			1.41 V	95	81.01	31.46
3	*2412.00	102.16 AV			1.41 V	95	70.70	31.46
4	2483.50	64.06 PK	74.00	-9.94	1.44 V	91	32.36	31.70
4	2483.50	52.77 AV	54.00	-1.23	1.44 V	91	21.07	31.70
5	3220.00	46.24 PK	74.00	-27.76	1.34 V	227	13.12	33.12
5	3220.00	37.59 AV	54.00	-16.41	1.34 V	227	4.47	33.12
6	4824.00	45.93 PK	74.00	-28.07	1.44 V	20	8.80	37.13
6	4824.00	32.94 AV	54.00	-21.06	1.44 V	20	-4.19	37.13

- REMARKS:**
1. Emission level (dBuV/m) = Raw Value (dBuV) + Correction Factor (dB/m).
  2. Correction Factor (dB/m) = Antenna Factor (dB/m) + Cable Factor (dB).
  3. The other emission levels were very low against the limit.
  4. Margin value = Emission level – Limit value.
  5. The limit value is defined as per 15.247.
  6. “ \* “: Fundamental frequency.

EUT TEST CONDITION		MEASUREMENT DETAIL	
CHANNEL	Channel 6	FREQUENCY RANGE	1 ~ 25GHz
MODULATION TYPE	BPSK	INPUT POWER (SYSTEM)	120Vac, 60 Hz
TRANSFER RATE	7.2Mbps	DETECTOR FUNCTION	Peak(PK) Average (AV)
ENVIRONMENTAL CONDITIONS	26deg. C, 70%RH, 991hPa	TESTED BY	Lori Chiu

ANTENNA POLARITY & TEST DISTANCE: HORIZONTAL AT 3 M								
No.	Freq. (MHz)	Emission Level (dBuV/m)	Limit (dBuV/m)	Margin (dB)	Antenna Height (m)	Table Angle (Degree)	Raw Value (dBuV)	Correction Factor (dB/m)
1	2238.00	54.07 PK	74.00	-19.93	1.10 H	324	23.22	30.85
1	2238.00	45.67 AV	54.00	-8.33	1.10 H	324	14.82	30.85
2	2390.00	60.21 PK	74.00	-13.79	1.10 H	321	28.82	31.39
2	2390.00	47.88 AV	54.00	-6.12	1.10 H	321	16.49	31.39
3	*2437.00	103.52 PK			1.10 H	320	71.98	31.54
3	*2437.00	94.76 AV			1.10 H	320	63.22	31.54
4	2483.50	61.24 PK	74.00	-12.76	1.11 H	323	29.54	31.70
4	2483.50	48.26 AV	54.00	-5.74	1.11 H	323	16.56	31.70

ANTENNA POLARITY & TEST DISTANCE: VERTICAL AT 3 M								
No.	Freq. (MHz)	Emission Level (dBuV/m)	Limit (dBuV/m)	Margin (dB)	Antenna Height (m)	Table Angle (Degree)	Raw Value (dBuV)	Correction Factor (dB/m)
1	2238.00	58.71 PK	74.00	-15.29	1.52 V	98	27.86	30.85
1	2238.00	50.20 AV	54.00	-3.80	1.52 V	98	19.35	30.85
2	2390.00	61.74 PK	74.00	-12.26	1.52 V	97	30.35	31.39
2	2390.00	52.03 AV	54.00	-1.97	1.52 V	97	20.64	31.39
3	*2437.00	112.20 PK			1.52 V	96	80.66	31.54
3	*2437.00	102.12 AV			1.52 V	96	70.58	31.54
4	2483.50	62.61 PK	74.00	-11.39	1.55 V	99	30.91	31.70
4	2483.50	52.80 AV	54.00	-1.20	1.55 V	99	21.10	31.70
5	3220.00	46.32 PK	74.00	-27.68	1.32 V	113	13.20	33.12
5	3220.00	37.67 AV	54.00	-16.33	1.32 V	113	4.55	33.12
6	4874.00	45.85 PK	74.00	-28.15	1.45 V	324	8.56	37.29
6	4874.00	32.69 AV	54.00	-21.31	1.45 V	324	-4.60	37.29

- REMARKS:**
1. Emission level (dBuV/m) = Raw Value (dBuV) + Correction Factor (dB/m).
  2. Correction Factor (dB/m) = Antenna Factor (dB/m) + Cable Factor (dB).
  3. The other emission levels were very low against the limit.
  4. Margin value = Emission level – Limit value.
  5. The limit value is defined as per 15.247.
  6. “ \* “: Fundamental frequency.

EUT TEST CONDITION		MEASUREMENT DETAIL	
CHANNEL	Channel 11	FREQUENCY RANGE	1 ~ 25GHz
MODULATION TYPE	BPSK	INPUT POWER (SYSTEM)	120Vac, 60 Hz
TRANSFER RATE	7.2Mbps	DETECTOR FUNCTION	Peak(PK) Average (AV)
ENVIRONMENTAL CONDITIONS	26deg. C, 70%RH, 991hPa	TESTED BY	Lori Chiu

ANTENNA POLARITY & TEST DISTANCE: HORIZONTAL AT 3 M								
No.	Freq. (MHz)	Emission Level (dBuV/m)	Limit (dBuV/m)	Margin (dB)	Antenna Height (m)	Table Angle (Degree)	Raw Value (dBuV)	Correction Factor (dB/m)
1	2260.00	53.49 PK	74.00	-20.51	1.18 H	248	22.56	30.93
1	2260.00	43.77 AV	54.00	-10.23	1.18 H	248	12.84	30.93
2	2390.00	55.91 PK	74.00	-18.09	1.18 H	130	24.52	31.39
2	2390.00	46.50 AV	54.00	-7.50	1.18 H	130	15.11	31.39
3	*2462.00	102.65 PK			1.44 H	128	71.03	31.62
3	*2462.00	93.30 AV			1.44 H	128	61.68	31.62
4	2483.50	59.32 PK	74.00	-14.68	1.38 H	127	27.62	31.70
4	2483.50	47.72 AV	54.00	-6.28	1.38 H	127	16.02	31.70

ANTENNA POLARITY & TEST DISTANCE: VERTICAL AT 3 M								
No.	Freq. (MHz)	Emission Level (dBuV/m)	Limit (dBuV/m)	Margin (dB)	Antenna Height (m)	Table Angle (Degree)	Raw Value (dBuV)	Correction Factor (dB/m)
1	2260.00	57.52 PK	74.00	-16.48	1.08 V	142	26.59	30.93
1	2260.00	47.41 AV	54.00	-6.59	1.08 V	142	16.48	30.93
2	2390.00	60.51 PK	74.00	-13.49	1.58 V	94	29.12	31.39
2	2390.00	51.58 AV	54.00	-2.42	1.58 V	94	20.19	31.39
3	*2462.00	111.22 PK			1.36 V	93	79.60	31.62
3	*2462.00	101.90 AV			1.36 V	93	70.28	31.62
4	2483.50	66.88 PK	74.00	-7.12	1.30 V	92	35.18	31.70
<b>4</b>	<b>2483.50</b>	<b>52.94 AV</b>	<b>54.00</b>	<b>-1.06</b>	<b>1.30 V</b>	<b>92</b>	<b>21.24</b>	<b>31.70</b>
5	3220.00	46.21 PK	74.00	-27.79	1.08 V	224	13.09	33.12
5	3220.00	37.65 AV	54.00	-16.35	1.08 V	224	4.53	33.12
6	4924.00	45.87 PK	74.00	-28.13	1.45 V	220	8.43	37.44
6	4924.00	32.90 AV	54.00	-21.10	1.45 V	220	-4.54	37.44

- REMARKS:**
1. Emission level (dBuV/m) = Raw Value (dBuV) + Correction Factor (dB/m).
  2. Correction Factor (dB/m) = Antenna Factor (dB/m) + Cable Factor (dB).
  3. The other emission levels were very low against the limit.
  4. Margin value = Emission level – Limit value.
  5. The limit value is defined as per 15.247.
  6. “ \* “: Fundamental frequency.



**DRAFT 802.11n (40MHz) OFDM MODULATION: DUAL TX:**

EUT TEST CONDITION		MEASUREMENT DETAIL	
CHANNEL	Channel 1	FREQUENCY RANGE	1 ~ 25GHz
MODULATION TYPE	BPSK	INPUT POWER (SYSTEM)	120Vac, 60 Hz
TRANSFER RATE	15Mbps	DETECTOR FUNCTION	Peak(PK) Average (AV)
ENVIRONMENTAL CONDITIONS	26deg. C, 70%RH, 991hPa	TESTED BY	Lori Chiu

ANTENNA POLARITY & TEST DISTANCE: HORIZONTAL AT 3 M								
No.	Freq. (MHz)	Emission Level (dBuV/m)	Limit (dBuV/m)	Margin (dB)	Antenna Height (m)	Table Angle (Degree)	Raw Value (dBuV)	Correction Factor (dB/m)
1	2390.00	59.07 PK	74.00	-14.93	1.18 H	130	27.68	31.39
1	2390.00	47.73 AV	54.00	-6.27	1.18 H	130	16.34	31.39
2	*2422.00	97.33 PK			1.19 H	127	65.84	31.49
2	*2422.00	88.56 AV			1.19 H	127	57.07	31.49
3	2483.50	59.51 PK	74.00	-14.49	1.39 H	129	27.81	31.70
3	2483.50	48.37 AV	54.00	-5.63	1.39 H	129	16.67	31.70

ANTENNA POLARITY & TEST DISTANCE: VERTICAL AT 3 M								
No.	Freq. (MHz)	Emission Level (dBuV/m)	Limit (dBuV/m)	Margin (dB)	Antenna Height (m)	Table Angle (Degree)	Raw Value (dBuV)	Correction Factor (dB/m)
1	2390.00	65.36 PK	74.00	-8.64	1.48 V	93	33.97	31.39
1	2390.00	52.21 AV	54.00	-1.79	1.48 V	93	20.82	31.39
2	*2422.00	106.65 PK			1.58 V	93	75.16	31.49
2	*2422.00	97.09 AV			1.58 V	93	65.60	31.49
3	2483.50	62.11 PK	74.00	-11.89	1.44 V	92	30.41	31.70
3	2483.50	52.47 AV	54.00	-1.53	1.44 V	92	20.77	31.70
4	3114.00	46.37 PK	74.00	-27.63	1.36 V	222	13.47	32.90
4	3114.00	37.58 AV	54.00	-16.42	1.36 V	222	4.68	32.90
5	4844.00	45.67 PK	74.00	-28.33	1.54 V	36	8.48	37.19
5	4844.00	32.86 AV	54.00	-21.14	1.54 V	36	-4.33	37.19

- REMARKS:**
1. Emission level (dBuV/m) = Raw Value (dBuV) + Correction Factor (dB/m).
  2. Correction Factor (dB/m) = Antenna Factor (dB/m) + Cable Factor (dB).
  3. The other emission levels were very low against the limit.
  4. Margin value = Emission level – Limit value.
  5. The limit value is defined as per 15.247.
  6. “ \* “: Fundamental frequency.



EUT TEST CONDITION		MEASUREMENT DETAIL	
<b>CHANNEL</b>	Channel 4	<b>FREQUENCY RANGE</b>	1 ~ 25GHz
<b>MODULATION TYPE</b>	BPSK	<b>INPUT POWER (SYSTEM)</b>	120Vac, 60 Hz
<b>TRANSFER RATE</b>	15Mbps	<b>DETECTOR FUNCTION</b>	Peak(PK) Average (AV)
<b>ENVIRONMENTAL CONDITIONS</b>	26deg. C, 70%RH, 991hPa	<b>TESTED BY</b>	Lori Chiu

ANTENNA POLARITY & TEST DISTANCE: HORIZONTAL AT 3 M								
No.	Freq. (MHz)	Emission Level (dBuV/m)	Limit (dBuV/m)	Margin (dB)	Antenna Height (m)	Table Angle (Degree)	Raw Value (dBuV)	Correction Factor (dB/m)
1	2390.00	59.12 PK	74.00	-14.88	1.20 H	133	27.73	31.39
1	2390.00	47.69 AV	54.00	-6.31	1.20 H	133	16.30	31.39
2	*2437.00	97.28 PK			1.20 H	137	65.74	31.54
2	*2437.00	88.43 AV			1.20 H	137	56.89	31.54
3	2483.50	59.42 PK	74.00	-14.58	1.22 H	132	27.72	31.70
3	2483.50	47.66 AV	54.00	-6.34	1.22 H	132	15.96	31.70

ANTENNA POLARITY & TEST DISTANCE: VERTICAL AT 3 M								
No.	Freq. (MHz)	Emission Level (dBuV/m)	Limit (dBuV/m)	Margin (dB)	Antenna Height (m)	Table Angle (Degree)	Raw Value (dBuV)	Correction Factor (dB/m)
1	2390.00	62.07 PK	74.00	-11.93	1.29 V	132	30.68	31.39
1	2390.00	52.25 AV	54.00	-1.75	1.29 V	132	20.86	31.39
2	*2437.00	106.20 PK			1.26 V	132	74.66	31.54
2	*2437.00	97.05 AV			1.26 V	132	65.51	31.54
3	2483.50	62.03 PK	74.00	-11.97	1.23 V	130	30.33	31.70
3	2483.50	52.24 AV	54.00	-1.76	1.23 V	130	20.54	31.70
4	3168.00	46.97 PK	74.00	-27.03	1.23 V	62	13.96	33.01
4	3168.00	37.53 AV	54.00	-16.47	1.23 V	62	4.52	33.01
5	4874.00	45.62 PK	74.00	-28.38	1.52 V	246	8.33	37.29
5	4874.00	32.55 AV	54.00	-21.45	1.52 V	246	-4.74	37.29

- REMARKS:**
1. Emission level (dBuV/m) = Raw Value (dBuV) + Correction Factor (dB/m).
  2. Correction Factor (dB/m) = Antenna Factor (dB/m) + Cable Factor (dB).
  3. The other emission levels were very low against the limit.
  4. Margin value = Emission level – Limit value.
  5. The limit value is defined as per 15.247.
  6. “ \* “: Fundamental frequency.

EUT TEST CONDITION		MEASUREMENT DETAIL	
CHANNEL	Channel 7	FREQUENCY RANGE	1 ~ 25GHz
MODULATION TYPE	BPSK	INPUT POWER (SYSTEM)	120Vac, 60 Hz
TRANSFER RATE	15Mbps	DETECTOR FUNCTION	Peak(PK) Average (AV)
ENVIRONMENTAL CONDITIONS	26deg. C, 70%RH, 991hPa	TESTED BY	Lori Chiu

ANTENNA POLARITY & TEST DISTANCE: HORIZONTAL AT 3 M								
No.	Freq. (MHz)	Emission Level (dBuV/m)	Limit (dBuV/m)	Margin (dB)	Antenna Height (m)	Table Angle (Degree)	Raw Value (dBuV)	Correction Factor (dB/m)
1	2390.00	56.48 PK	74.00	-17.52	1.22 H	134	25.09	31.39
1	2390.00	44.52 AV	54.00	-9.48	1.22 H	134	13.13	31.39
2	*2452.00	97.18 PK			1.20 H	134	65.59	31.59
2	*2452.00	88.37 AV			1.20 H	134	56.78	31.59
3	2483.50	59.64 PK	74.00	-14.36	1.21 H	133	27.94	31.70
3	2483.50	48.42 AV	54.00	-5.58	1.21 H	133	16.72	31.70

ANTENNA POLARITY & TEST DISTANCE: VERTICAL AT 3 M								
No.	Freq. (MHz)	Emission Level (dBuV/m)	Limit (dBuV/m)	Margin (dB)	Antenna Height (m)	Table Angle (Degree)	Raw Value (dBuV)	Correction Factor (dB/m)
1	2390.00	60.31 PK	74.00	-13.69	1.34 V	113	28.92	31.39
1	2390.00	50.95 AV	54.00	-3.05	1.34 V	113	19.56	31.39
2	*2452.00	106.02 PK			1.41 V	92	74.43	31.59
2	*2452.00	96.33 AV			1.41 V	92	64.74	31.59
3	2483.50	65.97 PK	74.00	-8.03	1.32 V	91	34.27	31.70
3	2483.50	52.90 AV	54.00	-1.10	1.32 V	91	21.20	31.70
4	3168.00	46.19 PK	74.00	-27.81	1.39 V	54	13.18	33.01
4	3168.00	37.42 AV	54.00	-16.58	1.39 V	54	4.41	33.01
5	4904.00	45.54 PK	74.00	-28.46	1.55 V	242	8.16	37.38
5	4904.00	32.76 AV	54.00	-21.24	1.55 V	242	-4.62	37.38

- REMARKS:**
1. Emission level (dBuV/m) = Raw Value (dBuV) + Correction Factor (dB/m).
  2. Correction Factor (dB/m) = Antenna Factor (dB/m) + Cable Factor (dB).
  3. The other emission levels were very low against the limit.
  4. Margin value = Emission level – Limit value.
  5. The limit value is defined as per 15.247.
  6. “ \* “: Fundamental frequency.



### 4.3 6dB BANDWIDTH MEASUREMENT

#### 4.3.1 LIMITS OF 6dB BANDWIDTH MEASUREMENT

The minimum of 6dB Bandwidth Measurement is 0.5 MHz.

#### 4.3.2 TEST INSTRUMENTS

DESCRIPTION & MANUFACTURER	MODEL NO.	SERIAL NO.	CALIBRATED UNTIL
SPECTRUM ANALYZER	FSEK 30	100049	Aug. 14, 2006

**NOTE:** The calibration interval of the above test instruments is 12 months and the calibrations are traceable to NML/ROC and NIST/USA.

#### 4.3.3 TEST PROCEDURE

The transmitter output was connected to the spectrum analyzer through an attenuator. The bandwidth of the fundamental frequency was measured by spectrum analyzer with 100kHz RBW and 100kHz VBW. The 6dB bandwidth is defined as the total spectrum the power of which is higher than peak power minus 6dB.

#### 4.3.4 DEVIATION FROM TEST STANDARD

No deviation

#### 4.3.5 TEST SETUP

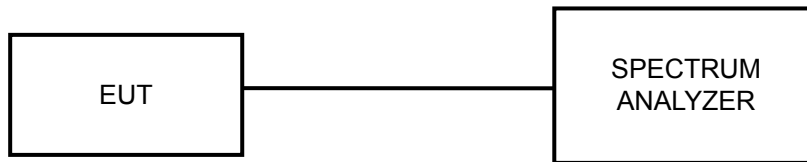

#### 4.3.6 EUT OPERATING CONDITIONS

The software provided by client to enable the EUT under transmission condition continuously at lowest, middle and highest channel frequencies individually.

### 4.3.7 TEST RESULTS

#### 802.11b DSSS MODULATION:

<b>MODULATION TYPE</b>	DBPSK	<b>TRANSFER RATE</b>	1Mbps
<b>INPUT POWER (SYSTEM)</b>	120Vac, 60 Hz	<b>ENVIRONMENTAL CONDITIONS</b>	25deg.C, 63%RH, 991hPa
<b>TESTED BY</b>	Lori Chiu		

CHANNEL	CHANNEL FREQUENCY (MHz)	6dB BANDWIDTH (MHz)		MINIMUM LIMIT (MHz)	PASS / FAIL
		CHAIN 0	CHAIN 1		
1	2412	12.08	12.04	0.5	PASS
6	2437	12.00	12.04	0.5	PASS
11	2462	12.04	12.04	0.5	PASS

#### FOR CHAIN 0: CH 1

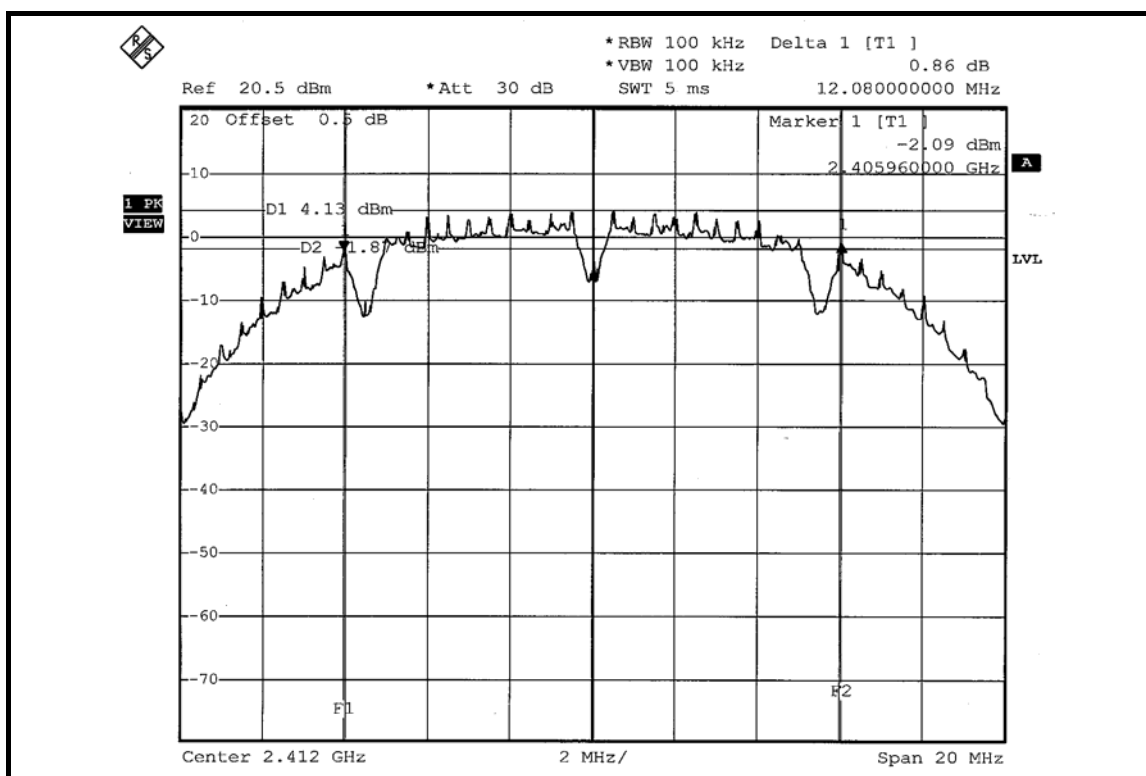

CH 6

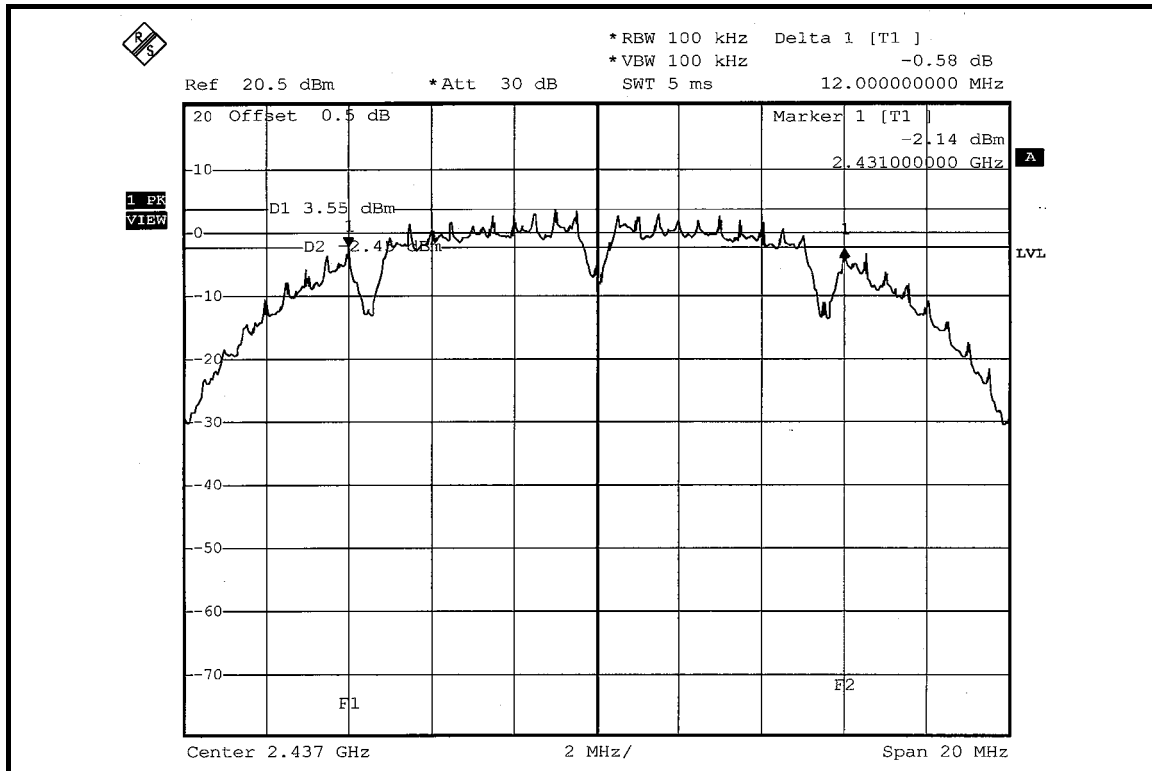

CH 11

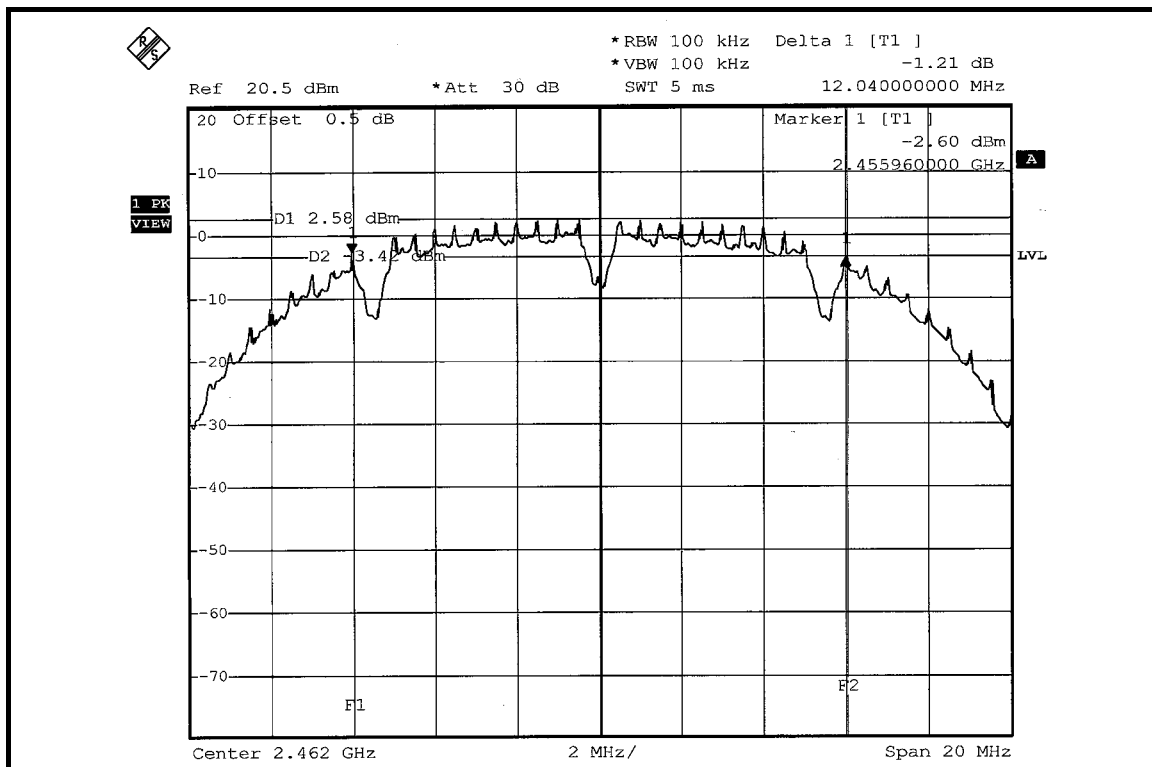

FOR CHAIN 1: CH 1

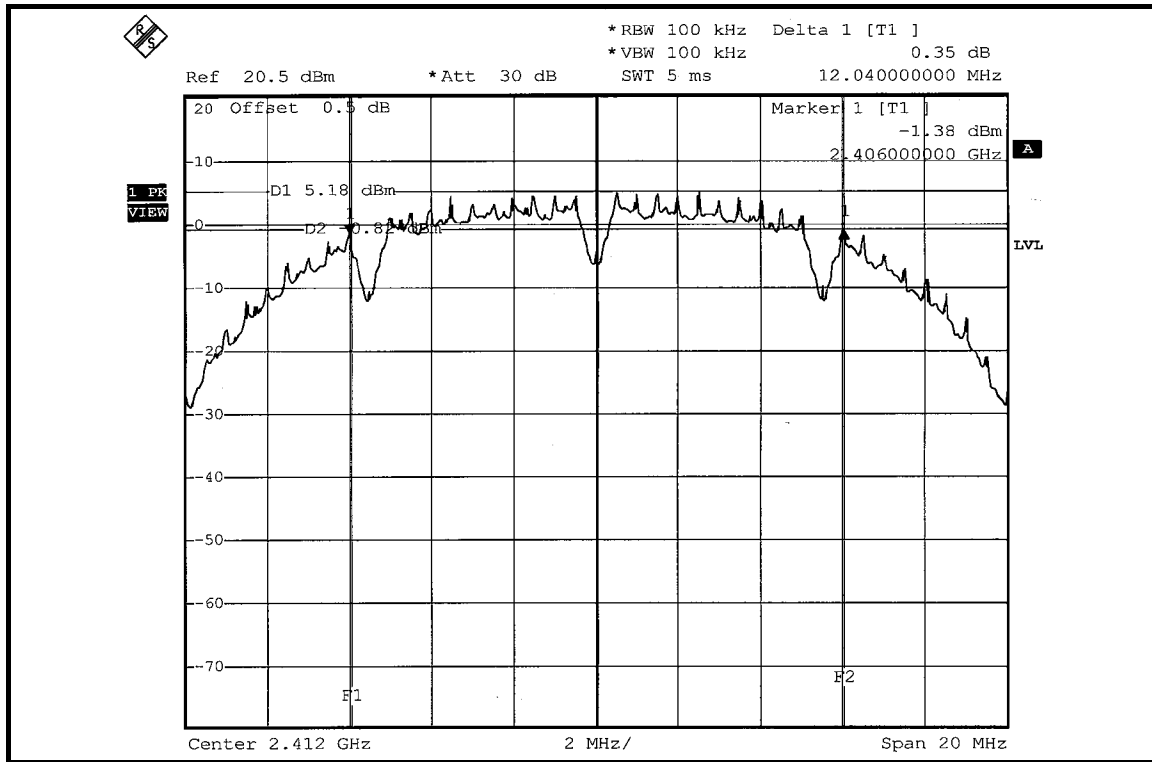

CH 6

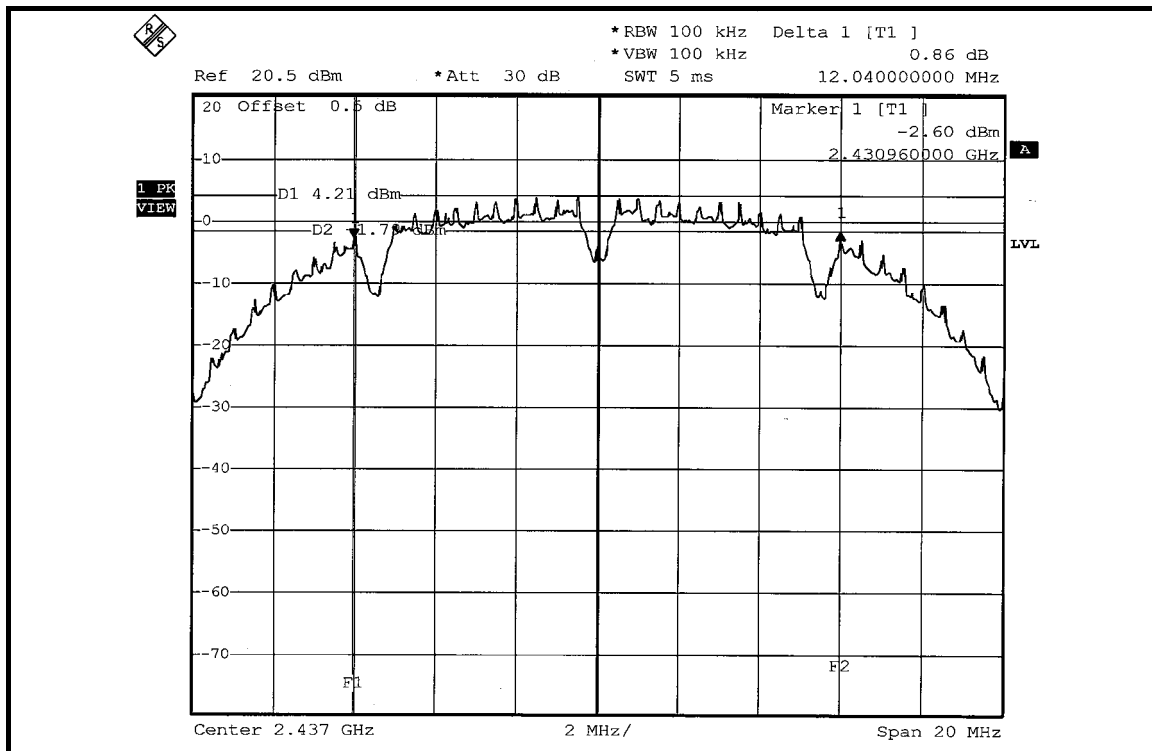

CH 11

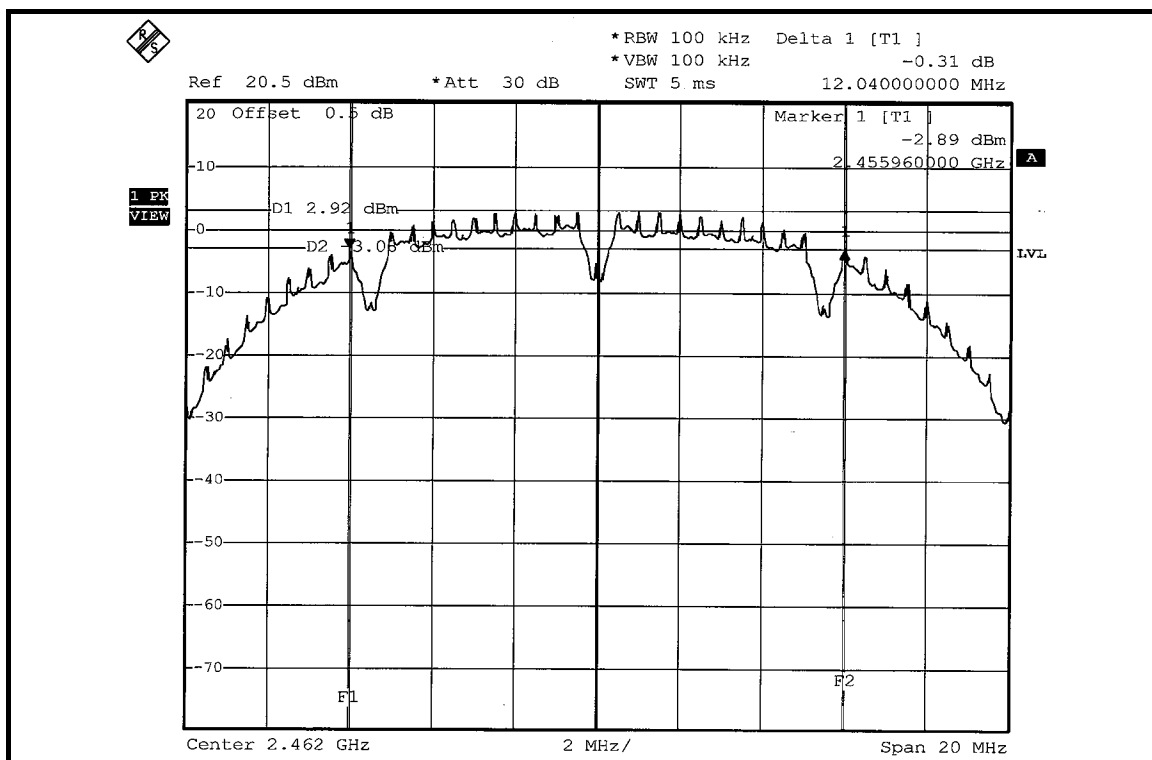



### 802.11g OFDM MODULATION:

<b>MODULATION TYPE</b>	BPSK	<b>TRANSFER RATE</b>	6Mbps
<b>INPUT POWER (SYSTEM)</b>	120Vac, 60 Hz	<b>ENVIRONMENTAL CONDITIONS</b>	25deg.C, 63%RH, 991hPa
<b>TESTED BY</b>	Lori Chiu		

CHANNEL	CHANNEL FREQUENCY (MHz)	6dB BANDWIDTH (MHz)		MINIMUM LIMIT (MHz)	PASS / FAIL
		CHAIN 0	CHAIN 1		
1	2412	16.40	16.40	0.5	PASS
6	2437	16.40	16.36	0.5	PASS
11	2462	16.40	16.40	0.5	PASS

### FOR CHAIN 0: CH 1

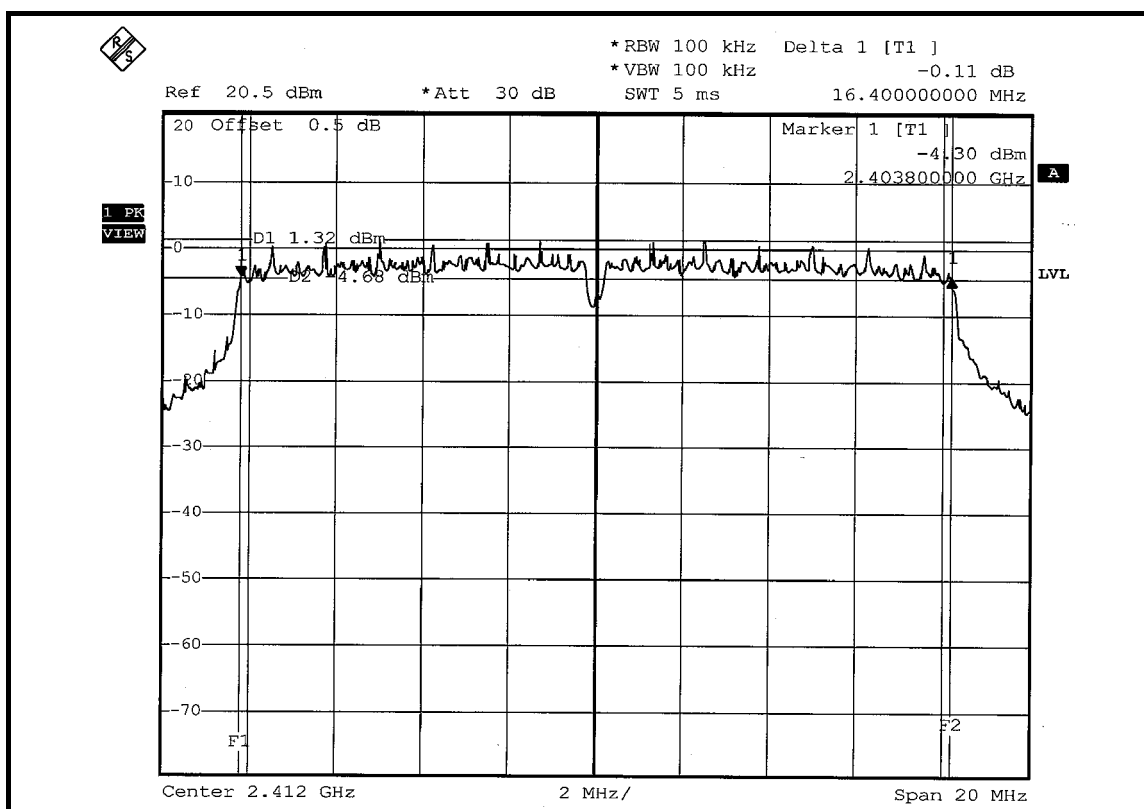

CH 6

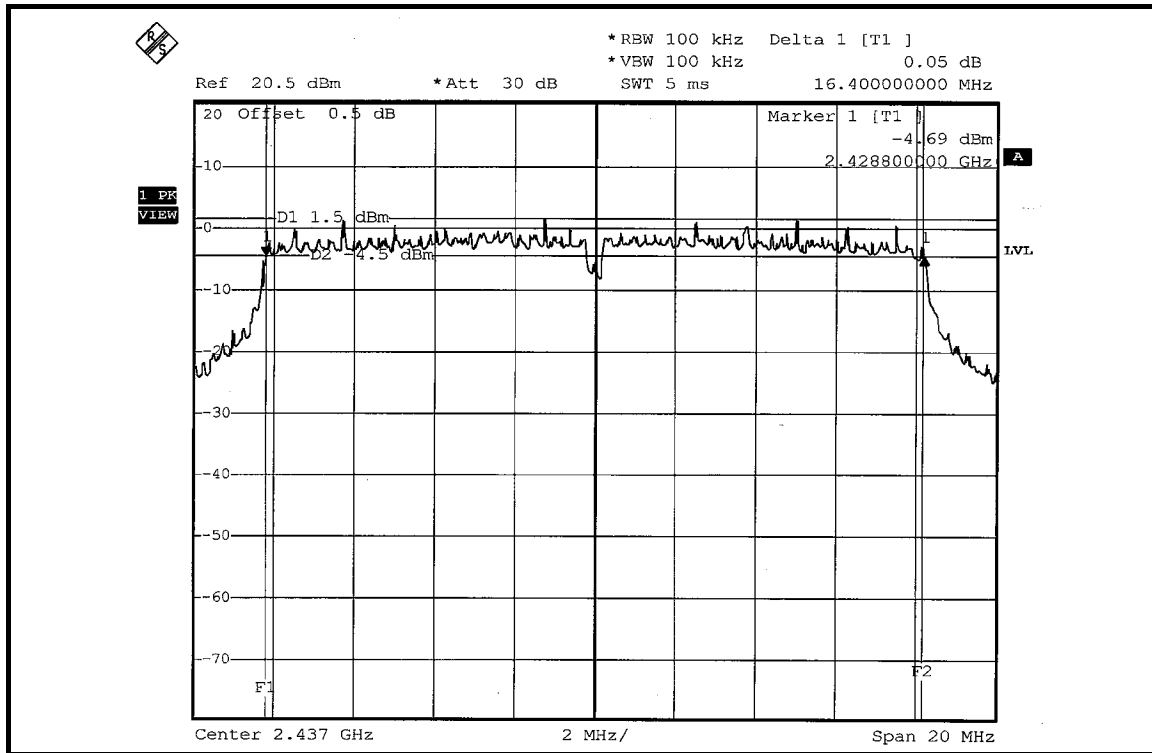

CH 11

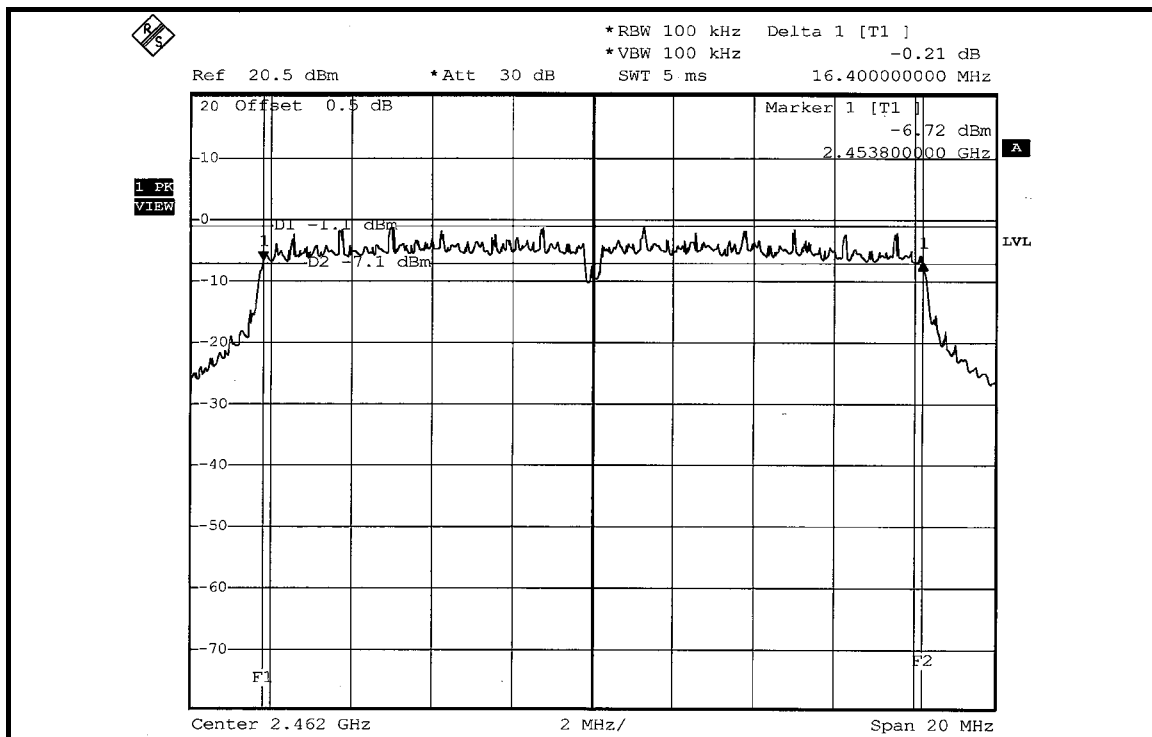

FOR CHAIN 1: CH 1

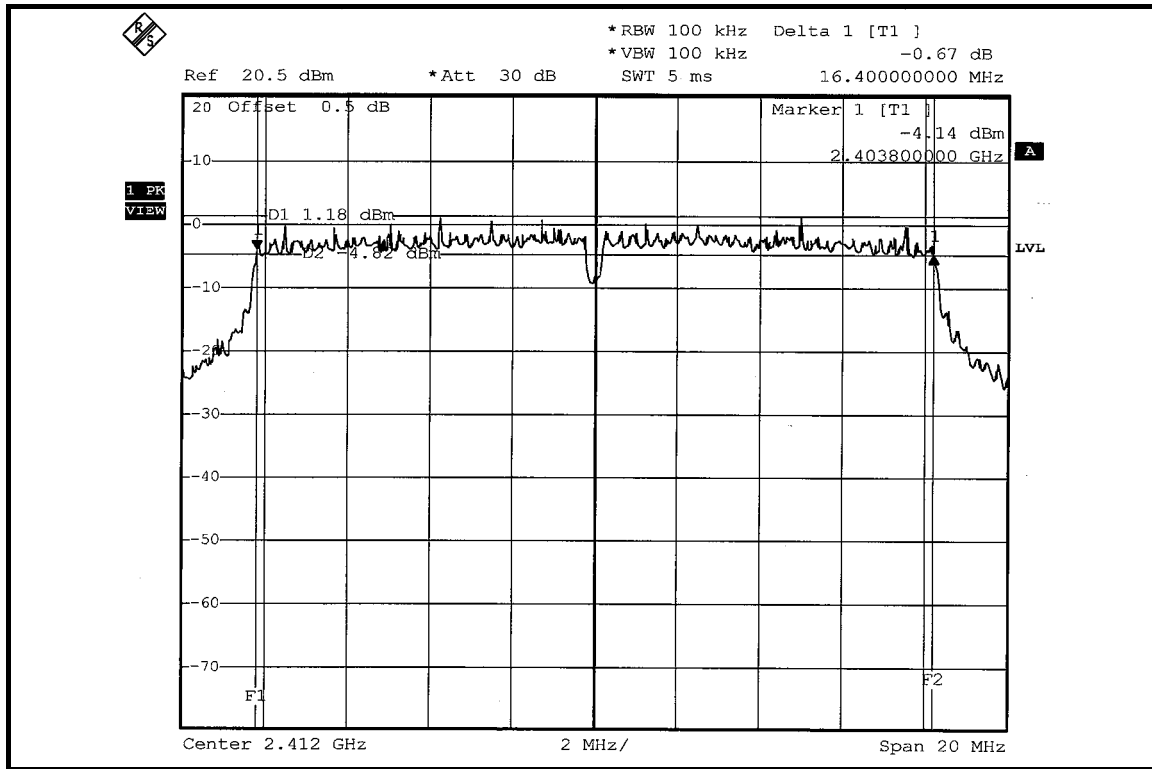

CH 6

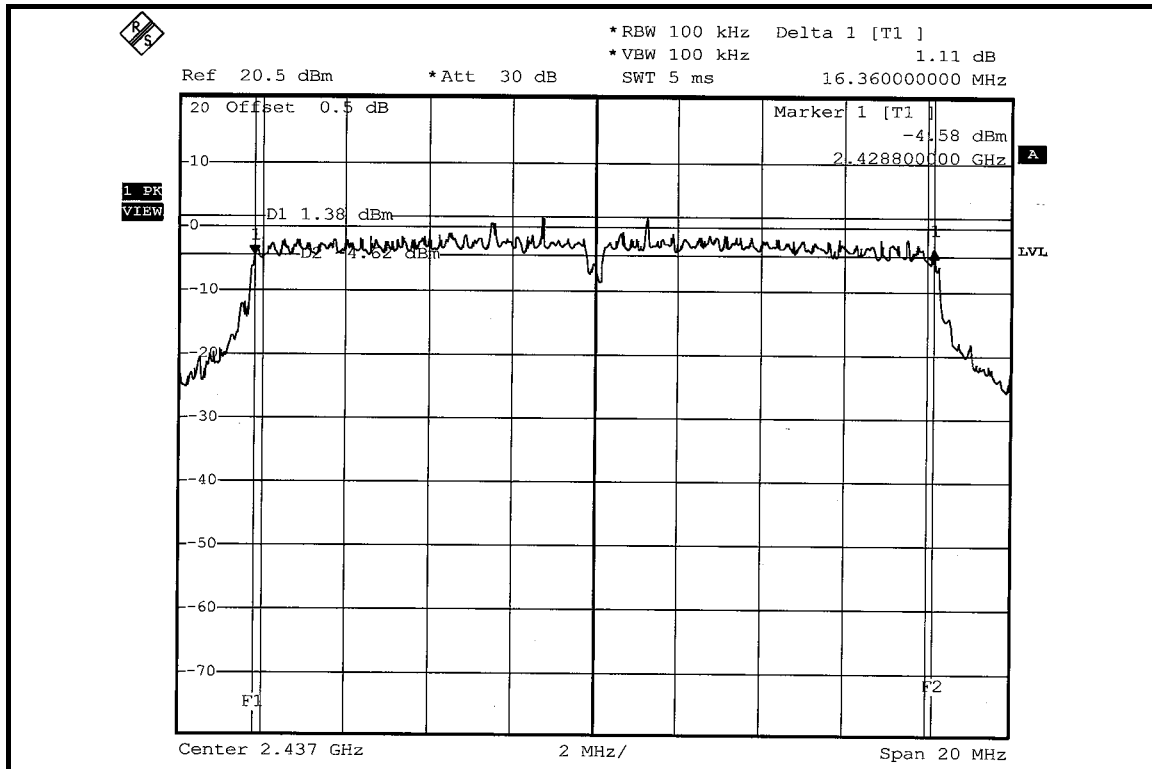

CH 11

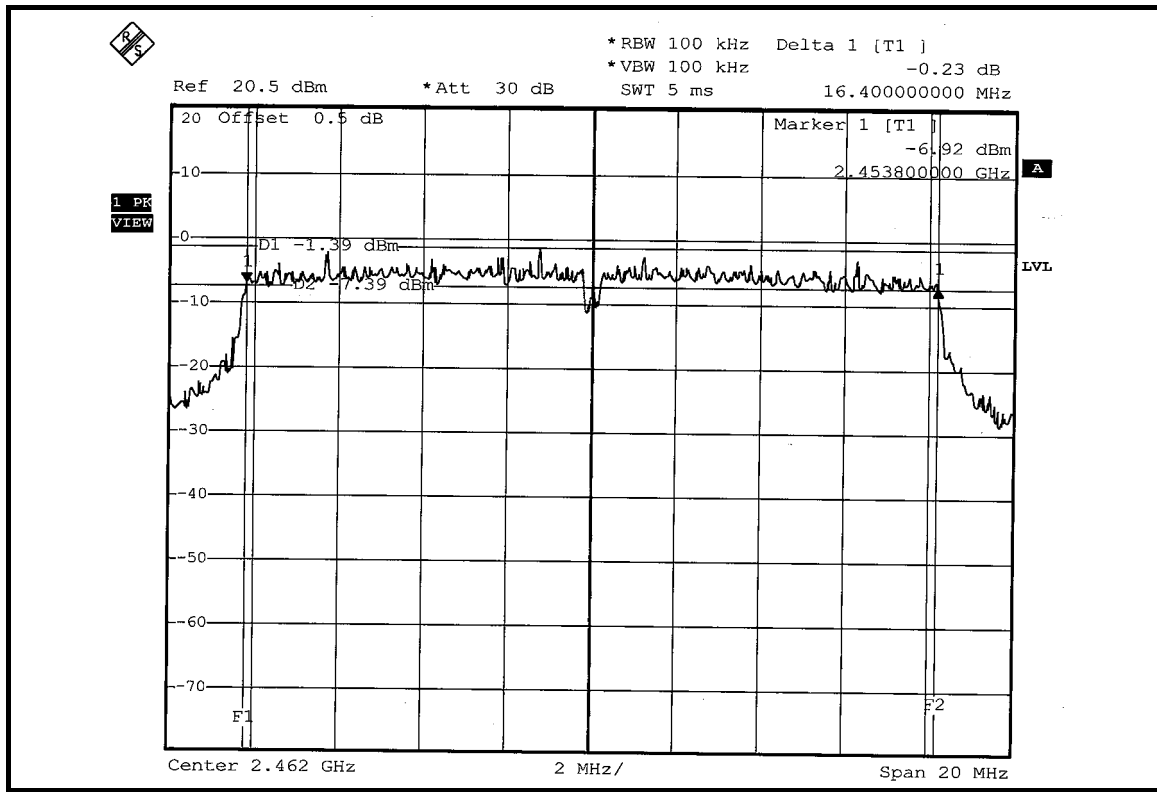



**DRAFT 802.11n (20MHz) OFDM MODULATION: DUAL TX:**

<b>MODULATION TYPE</b>	BPSK	<b>TRANSFER RATE</b>	7.2Mbps
<b>INPUT POWER (SYSTEM)</b>	120Vac, 60 Hz	<b>ENVIRONMENTAL CONDITIONS</b>	25deg.C, 63%RH, 991hPa
<b>TESTED BY</b>	Lori Chiu		

CHANNEL	CHANNEL FREQUENCY (MHz)	6dB BANDWIDTH (MHz)		MINIMUM LIMIT (MHz)	PASS / FAIL
		CHAIN 0	CHAIN 1		
1	2412	17.64	17.60	0.5	PASS
6	2437	17.60	17.64	0.5	PASS
11	2462	17.55	17.60	0.5	PASS

**FOR CHAIN 0: CH 1**

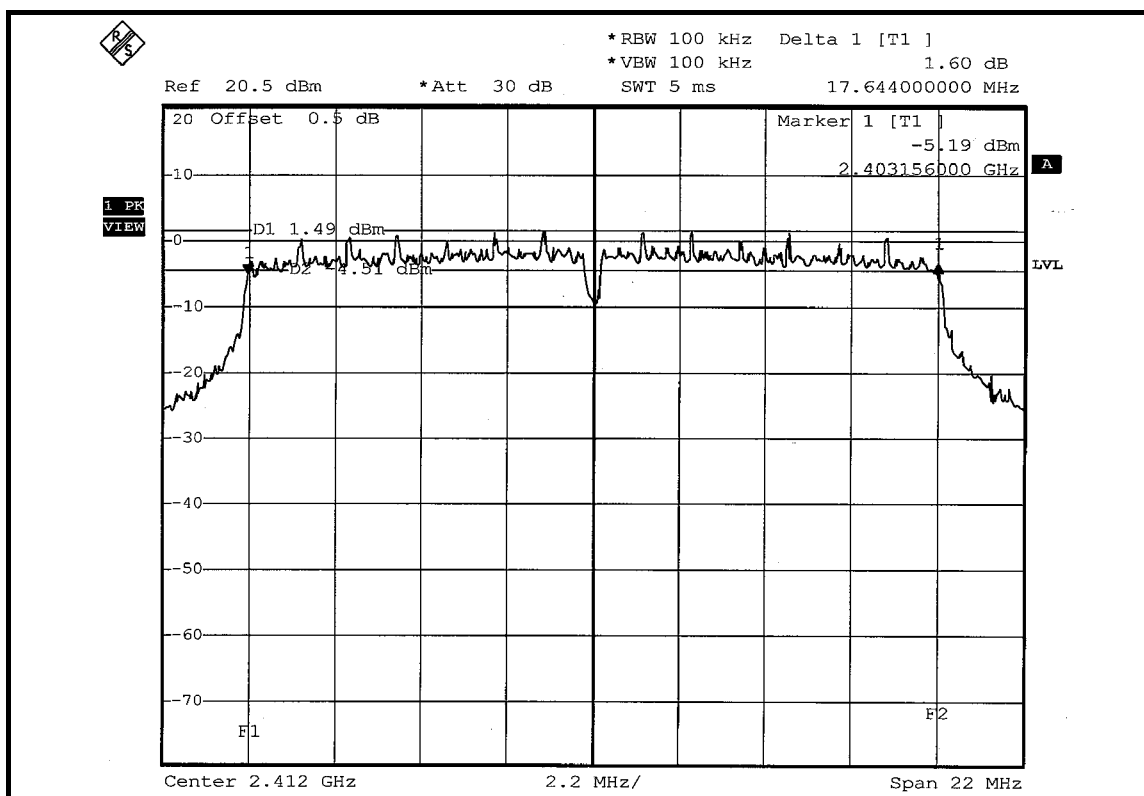

CH 6

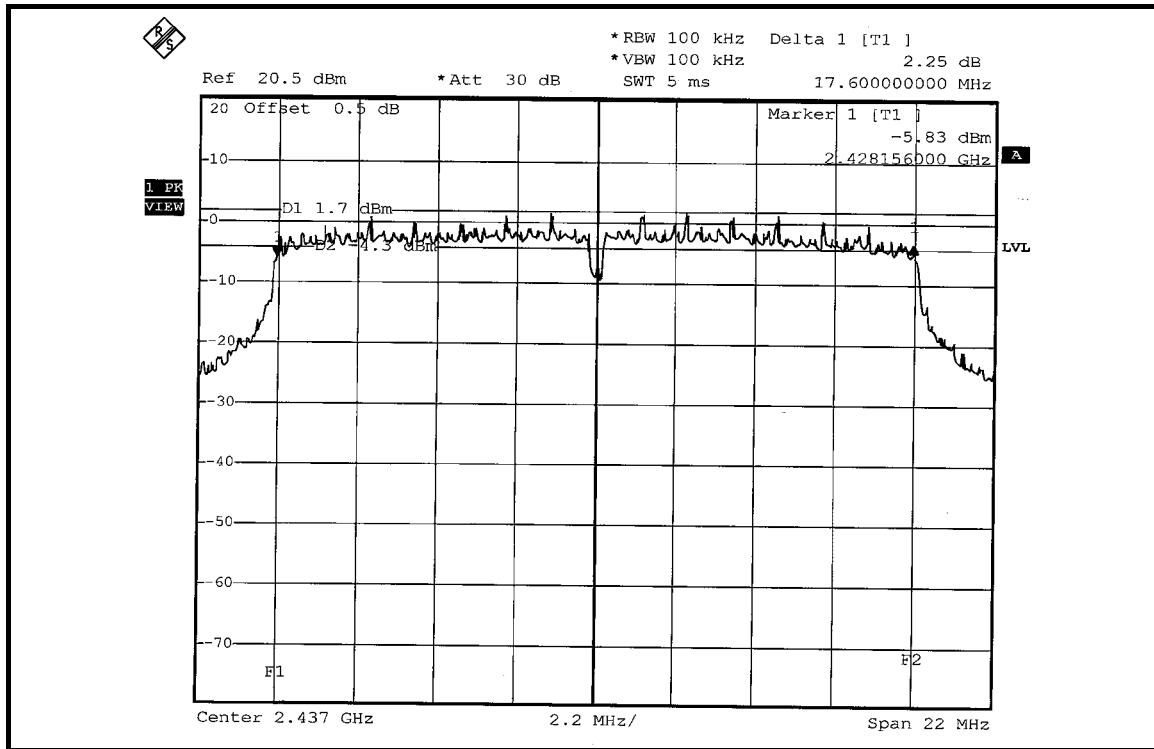

CH 11

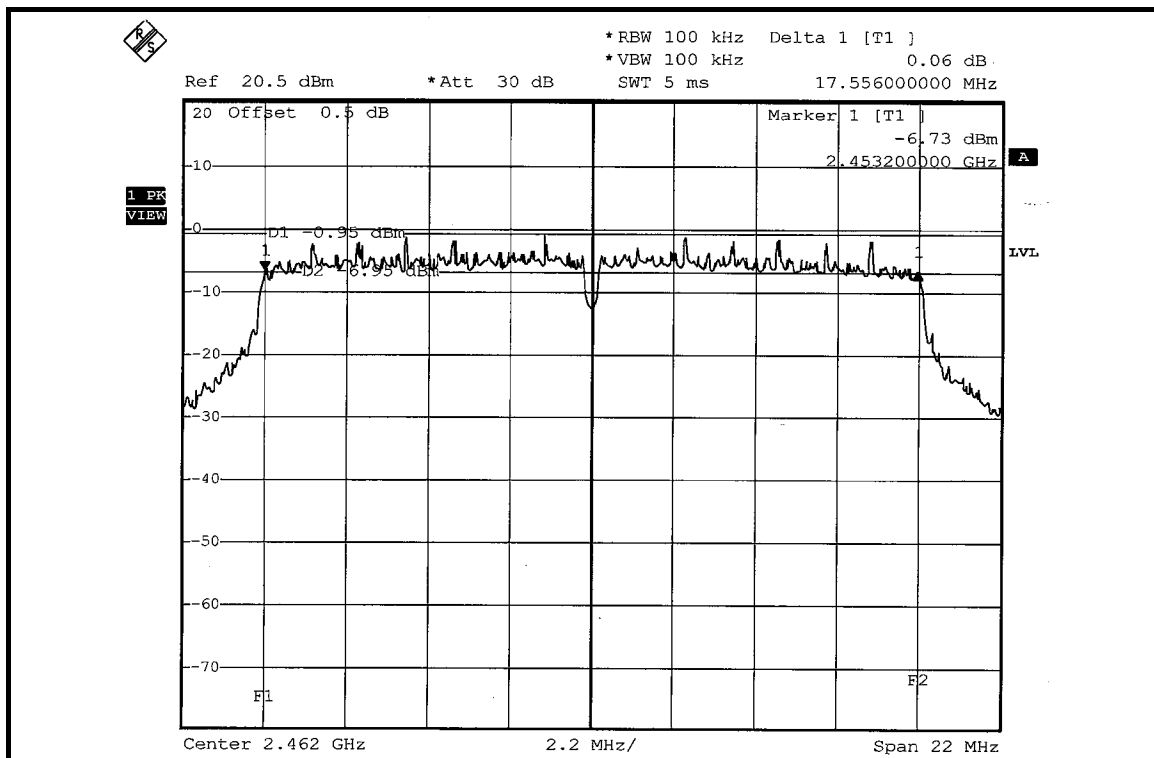

FOR CHAIN 1: CH 1

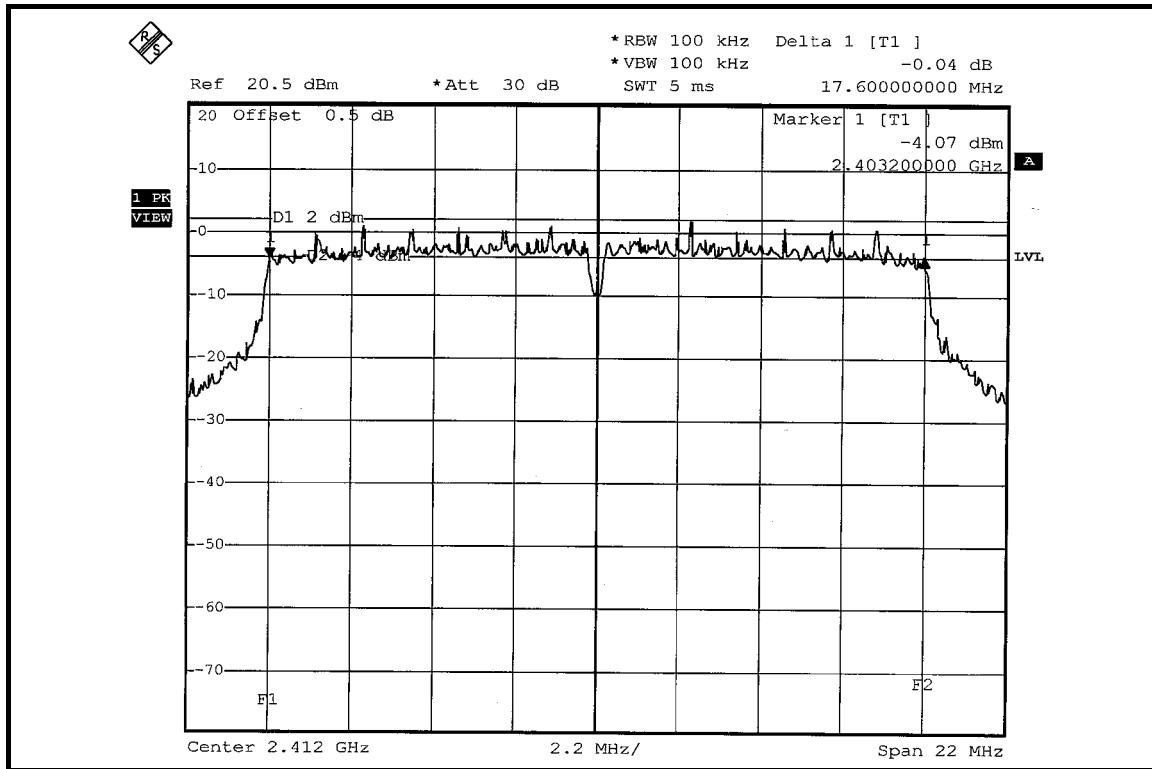

CH 6

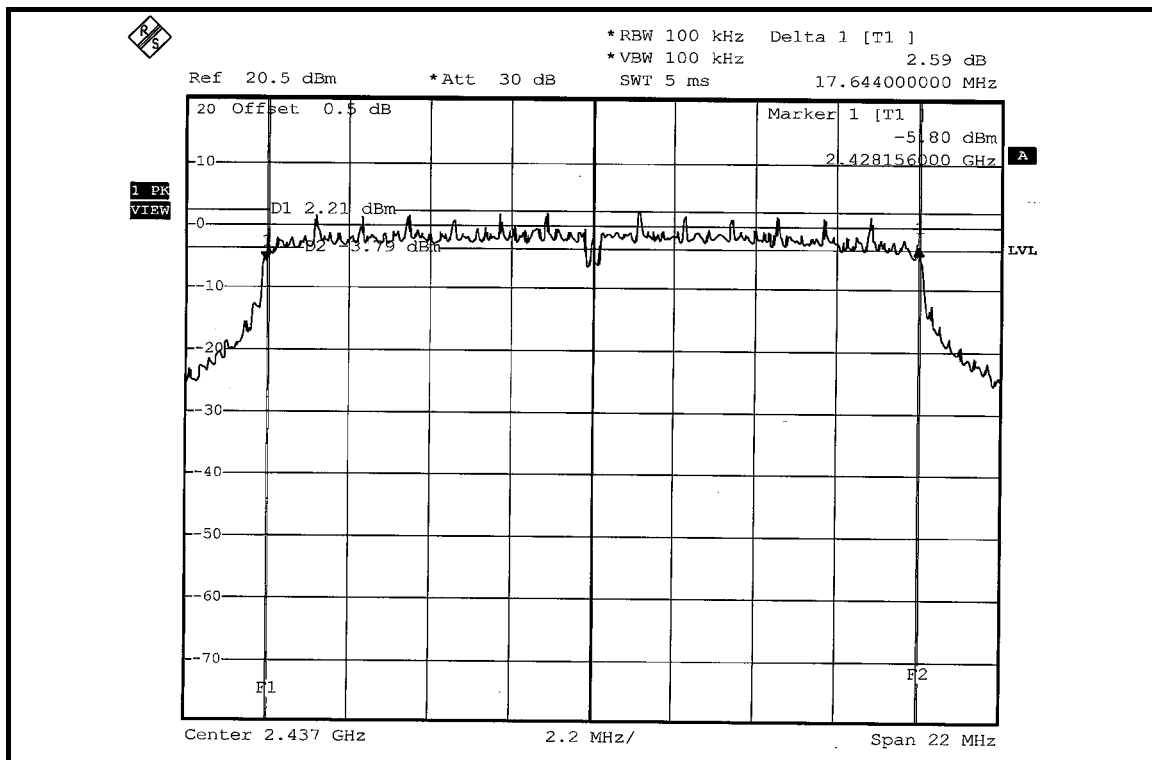

CH 11

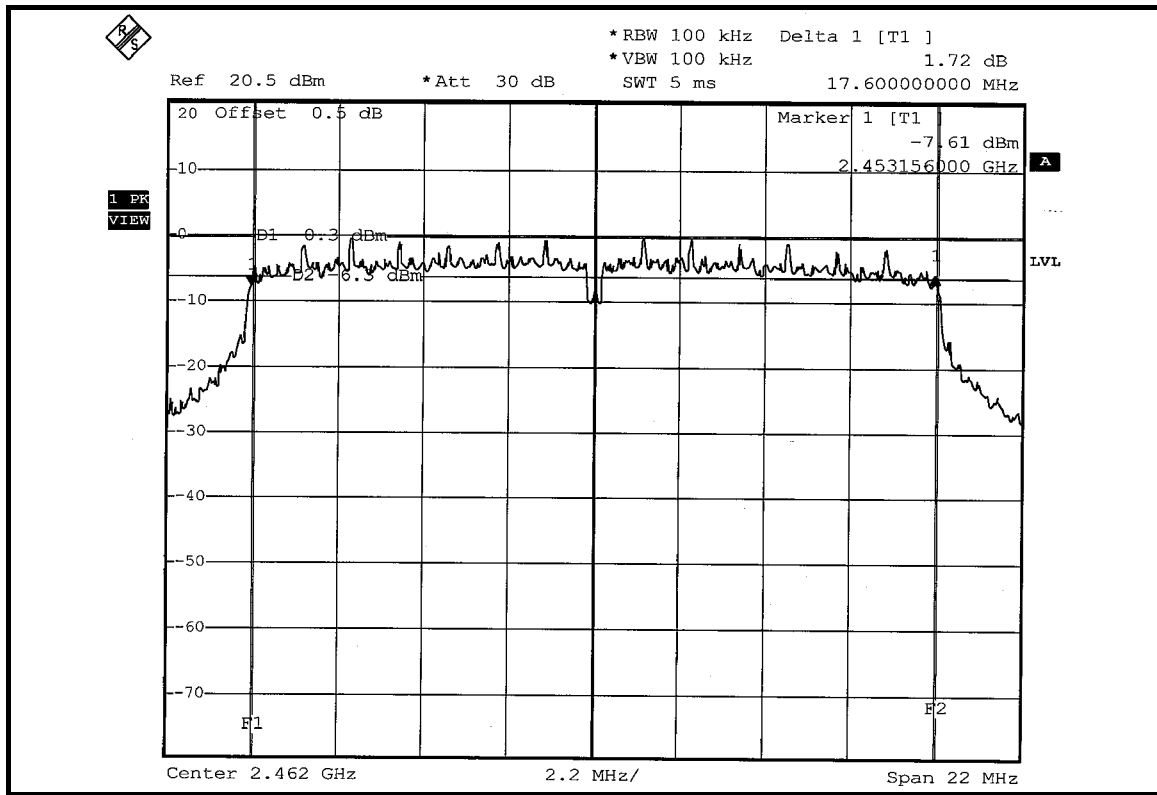



### DRAFT 802.11n (40MHz) OFDM MODULATION: DUAL TX:

<b>MODULATION TYPE</b>	BPSK	<b>TRANSFER RATE</b>	15Mbps
<b>INPUT POWER (SYSTEM)</b>	120Vac, 60 Hz	<b>ENVIRONMENTAL CONDITIONS</b>	25deg.C, 63%RH, 991hPa
<b>TESTED BY</b>	Lori Chiu		

CHANNEL	CHANNEL FREQUENCY (MHz)	6dB BANDWIDTH (MHz)		MINIMUM LIMIT (MHz)	PASS / FAIL
		CHAIN 0	CHAIN 1		
1	2422	36.48	36.48	0.5	PASS
4	2437	36.48	36.48	0.5	PASS
7	2452	36.56	36.48	0.5	PASS

### FOR CHAIN 0: CH 1

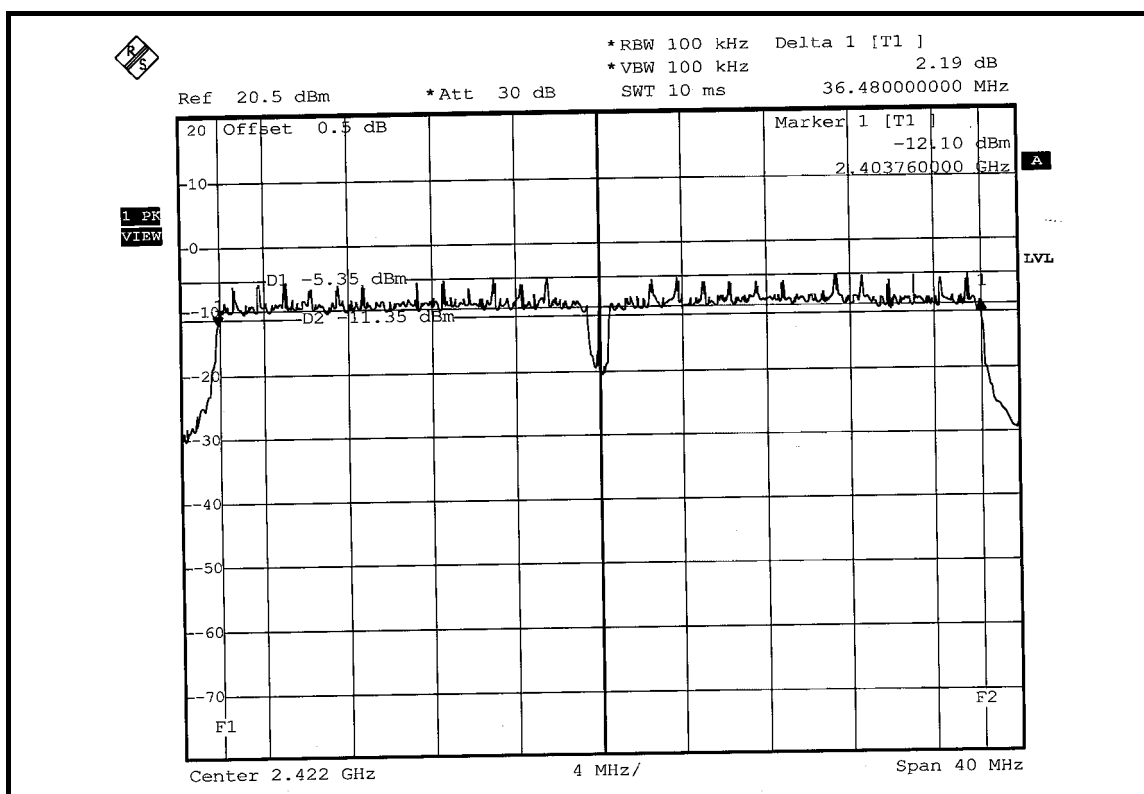

CH 4

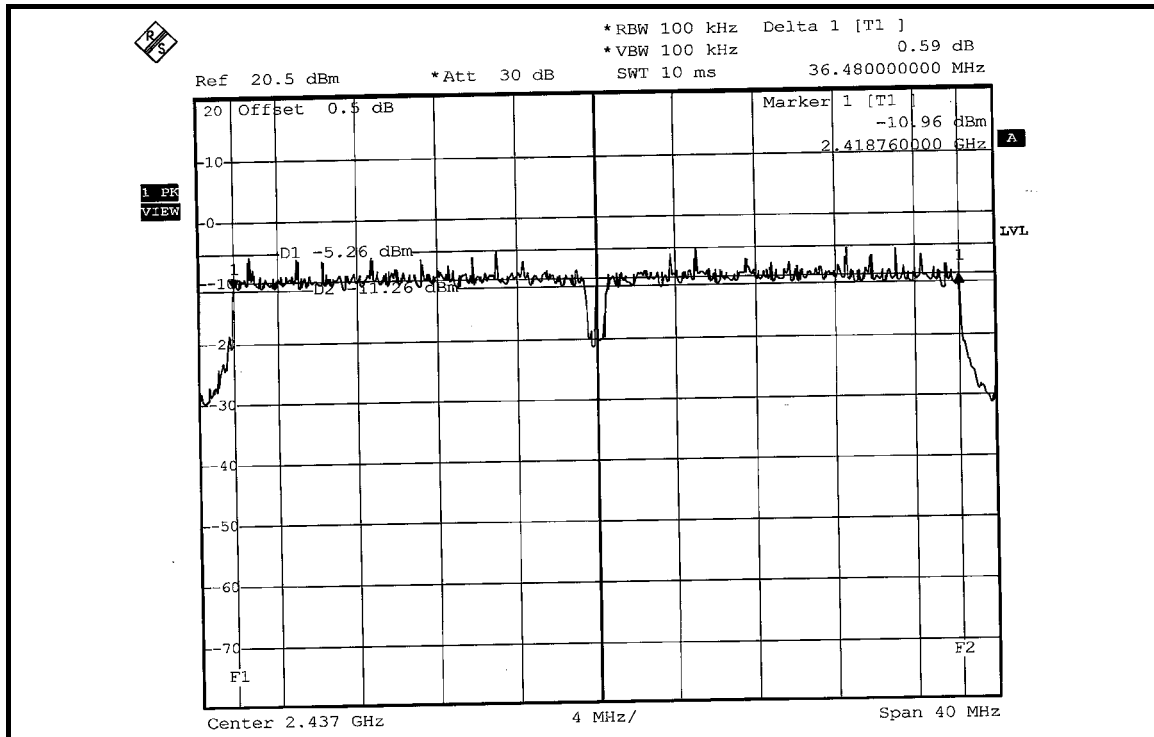

CH 7

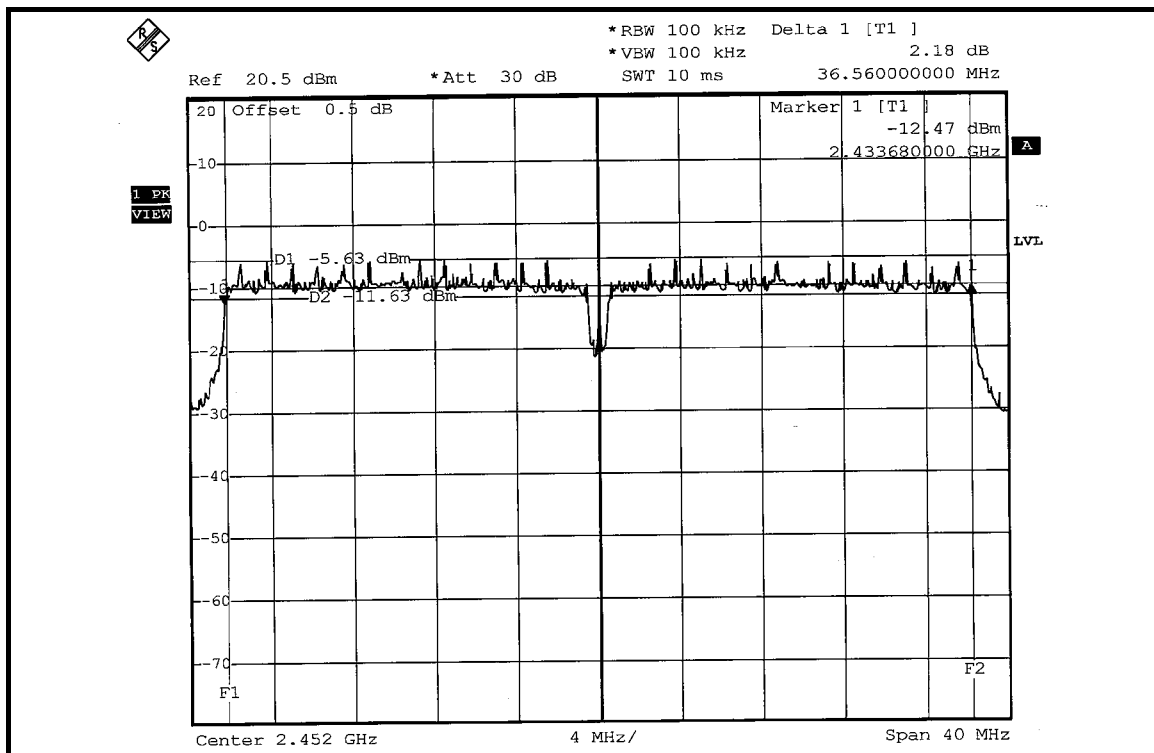

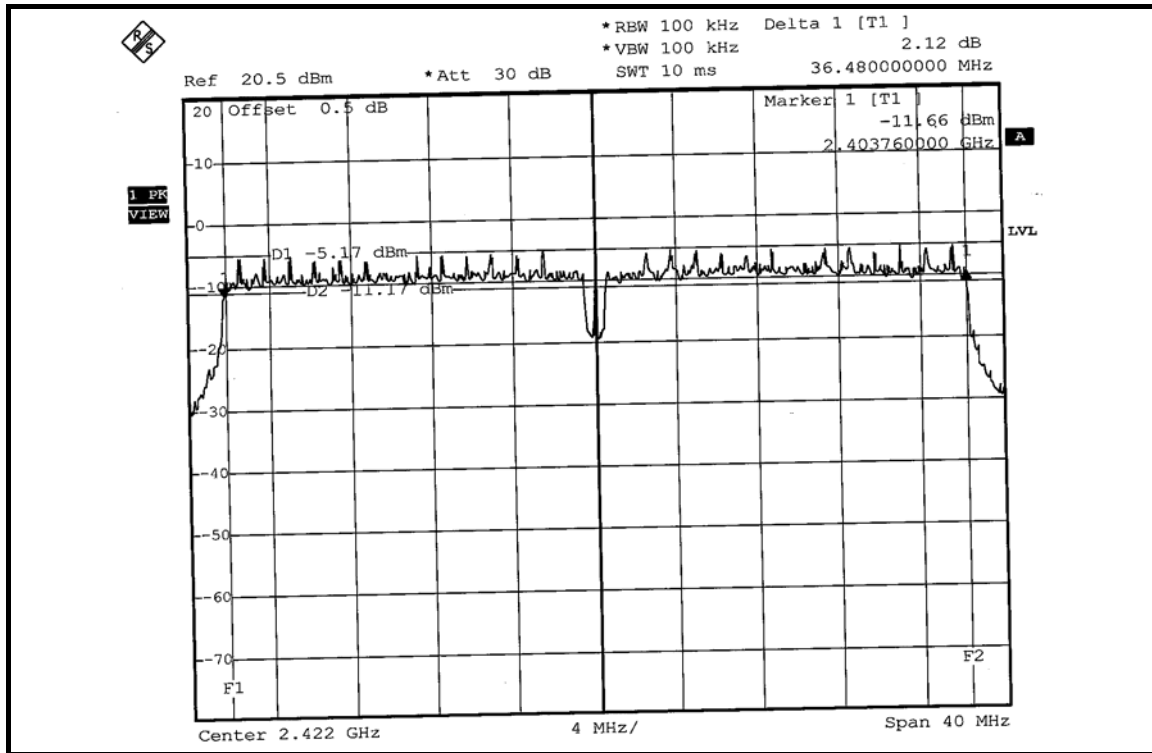
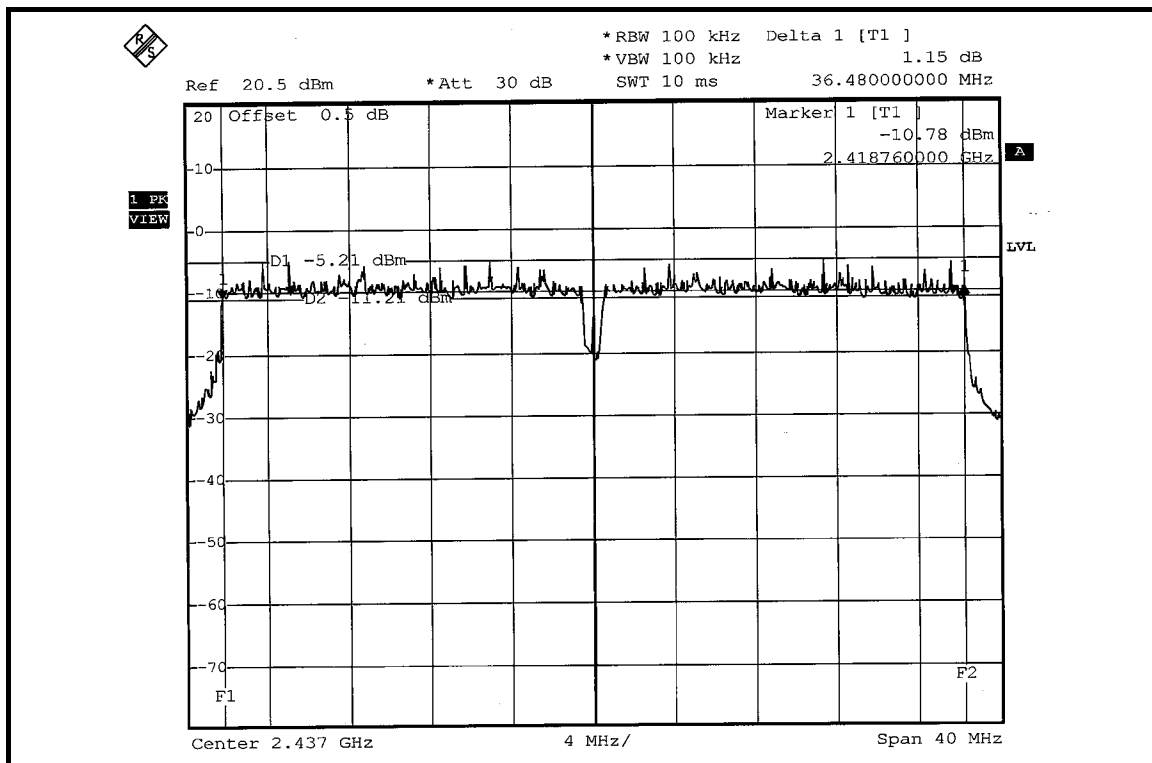
**FOR CHAIN 1: CH 1**

**CH 4**

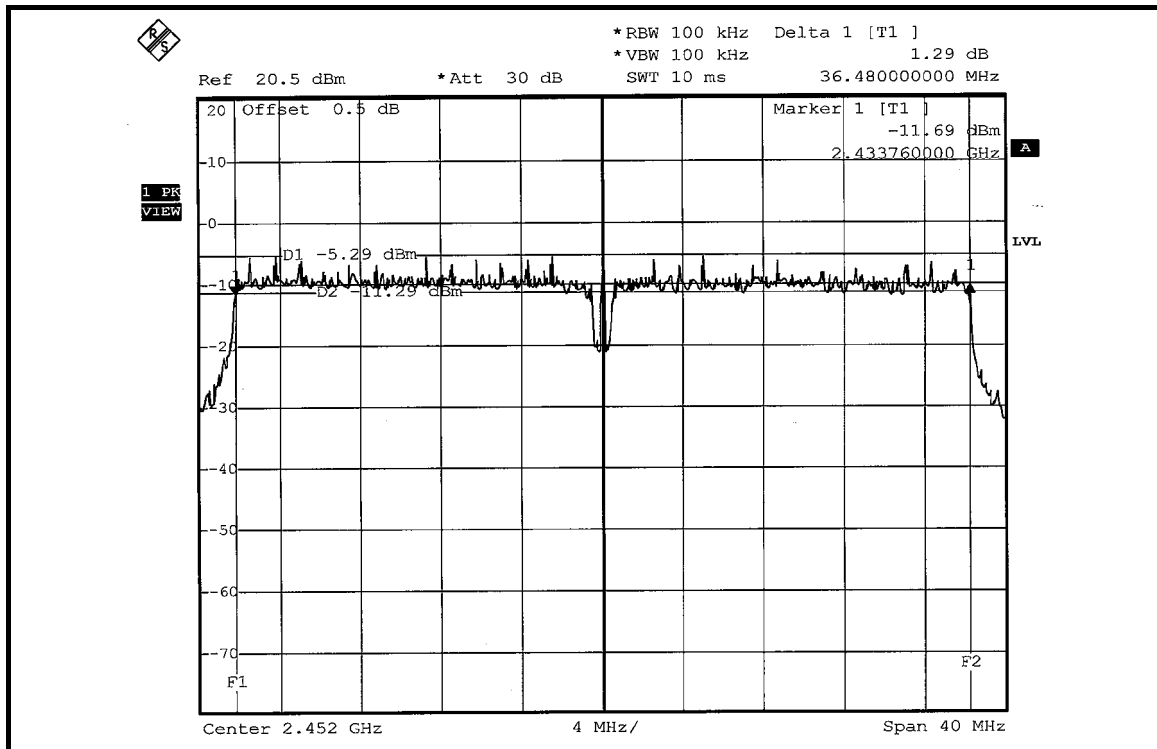
CH 7





#### 4.4 MAXIMUM PEAK OUTPUT POWER

##### 4.4.1 LIMITS OF MAXIMUM PEAK OUTPUT POWER MEASUREMENT

The Maximum Peak Output Power Measurement is 30dBm.

##### 4.4.2 INSTRUMENTS

DESCRIPTION & MANUFACTURER	MODEL NO.	SERIAL NO.	CALIBRATED UNTIL
R&S SPECTRUM ANALYZER	FSEK30	100049	Aug. 14, 2006
AGILENT SIGNAL GENERATOR	E8257C	MY43320668	Dec. 07, 2006
DIGITAL RT OSCILLOSCOPE	TDS1012	C037299	Nov. 28, 2006
NARDA DETECTOR	4503A	FSCM99899	NA

**NOTE:** The calibration interval of the above test instruments is 12 months and the calibrations are traceable to NML/ROC and NIST/USA.

##### 4.4.3 TEST PROCEDURES

1. A detector was used on the output port of the EUT. An oscilloscope was used to read the response of the detector.
2. Replaced the EUT by the signal generator. The center frequency of the S.G was adjusted to the center frequency of the measured channel.
3. Adjusted the power to have the same reading on oscilloscope. Record the power level.

##### 4.4.4 DEVIATION FROM TEST STANDARD

No deviation

#### 4.4.5 TEST SETUP



#### 4.4.6 EUT OPERATING CONDITIONS

Same as Item 4.3.6.

#### 4.4.7 TEST RESULTS

##### 802.11b DSSS MODULATION:

<b>MODULATION TYPE</b>	DBPSK	<b>TRANSFER RATE</b>	1Mbps
<b>INPUT POWER (SYSTEM)</b>	120Vac, 60 Hz	<b>ENVIRONMENTAL CONDITIONS</b>	25deg.C, 63%RH, 991hPa
<b>TESTED BY</b>	Lori Chiu		

CHANNEL	CHANNEL FREQUENCY (MHz)	PEAK POWER OUTPUT (mW)		PEAK POWER OUTPUT (dBm)		TOTAL PEAK POWER (mW)	TOTAL PEAK POWER (dBm)	PEAK POWER LIMIT (dBm)	PASS / FAIL
		CHAIN 0	CHAIN 1	CHAIN 0	CHAIN 1				
1	2412	25.235	31.989	14.02	15.05	57.224	17.576	30	PASS
6	2437	20.184	25.177	13.05	14.01	45.361	16.567	30	PASS
11	2462	17.906	20.137	12.53	13.04	38.043	15.803	30	PASS

##### 802.11g OFDM MODULATION:

<b>MODULATION TYPE</b>	BPSK	<b>TRANSFER RATE</b>	6Mbps
<b>INPUT POWER (SYSTEM)</b>	120Vac, 60 Hz	<b>ENVIRONMENTAL CONDITIONS</b>	25deg.C, 63%RH, 991hPa
<b>TESTED BY</b>	Lori Chiu		

CHANNEL	CHANNEL FREQUENCY (MHz)	PEAK POWER OUTPUT (mW)		PEAK POWER OUTPUT (dBm)		TOTAL PEAK POWER (mW)	TOTAL PEAK POWER (dBm)	PEAK POWER LIMIT (dBm)	PASS / FAIL
		CHAIN 0	CHAIN 1	CHAIN 0	CHAIN 1				
1	2412	44.668	44.978	16.50	16.53	89.646	19.525	30	PASS
6	2437	45.082	45.290	16.54	16.56	90.372	19.560	30	PASS
11	2462	25.235	25.410	14.02	14.05	50.645	17.045	30	PASS



**DRAFT 802.11n (20MHz) OFDM MODULATION: DUAL TX:**

<b>MODULATION TYPE</b>	BPSK	<b>TRANSFER RATE</b>	7.2Mbps
<b>INPUT POWER (SYSTEM)</b>	120Vac, 60 Hz	<b>ENVIRONMENTAL CONDITIONS</b>	25deg.C, 63%RH, 991hPa
<b>TESTED BY</b>	Lori Chiu		

CHANNEL	CHANNEL FREQUENCY (MHz)	PEAK POWER OUTPUT (mW)		PEAK POWER OUTPUT (dBm)		TOTAL PEAK POWER (mW)	TOTAL PEAK POWER (dBm)	PEAK POWER LIMIT (dBm)	PASS / FAIL
		CHAIN 0	CHAIN 1	CHAIN 0	CHAIN 1				
1	2412	44.771	44.875	16.51	16.52	89.586	19.522	30	PASS
6	2437	44.771	45.186	16.51	16.55	89.897	19.537	30	PASS
11	2462	31.915	32.063	15.04	15.06	63.978	18.060	30	PASS

**DRAFT 802.11n (40MHz) OFDM MODULATION: DUAL TX:**

<b>MODULATION TYPE</b>	BPSK	<b>TRANSFER RATE</b>	15Mbps
<b>INPUT POWER (SYSTEM)</b>	120Vac, 60 Hz	<b>ENVIRONMENTAL CONDITIONS</b>	25deg.C, 63%RH, 991hPa
<b>TESTED BY</b>	Lori Chiu		

CHANNEL	CHANNEL FREQUENCY (MHz)	PEAK POWER OUTPUT (mW)		PEAK POWER OUTPUT (dBm)		TOTAL PEAK POWER (mW)	TOTAL PEAK POWER (dBm)	PEAK POWER LIMIT (dBm)	PASS / FAIL
		CHAIN 0	CHAIN 1	CHAIN 0	CHAIN 1				
1	2422	17.865	20.137	12.52	13.04	38.002	15.798	30	PASS
4	2437	17.865	20.184	12.52	13.05	38.049	15.803	30	PASS
7	2452	15.922	17.906	12.02	12.53	33.828	15.292	30	PASS





## 4.5 POWER SPECTRAL DENSITY MEASUREMENT

### 4.5.1 LIMITS OF POWER SPECTRAL DENSITY MEASUREMENT

The Maximum of Power Spectral Density Measurement is 8dBm.

### 4.5.2 TEST INSTRUMENTS

DESCRIPTION & MANUFACTURER	MODEL NO.	SERIAL NO.	CALIBRATED UNTIL
R&S SPECTRUM ANALYZER	FSEK30	100049	Aug. 14, 2006

**NOTE:** The calibration interval of the above test instruments is 12 months and the calibrations are traceable to NML/ROC and NIST/USA.

### 4.5.3 TEST PROCEDURE

The transmitter output was connected to the spectrum analyzer through an attenuator, the bandwidth of the fundamental frequency was measured with the spectrum analyzer using 3kHz RBW and 30kHz VBW, set sweep time = span/3kHz. The power spectral density was measured and recorded.

The sweep time is allowed to be longer than span/3kHz for a full response of the mixer in the spectrum analyzer.

### 4.5.4 DEVIATION FROM TEST STANDARD

No deviation

#### 4.5.5 TEST SETUP

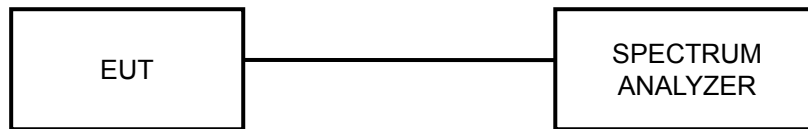

#### 4.5.6 EUT OPERATING CONDITION

Same as Item 4.3.6.

## 4.5.7 TEST RESULTS

### 802.11b DSSS MODULATION:

<b>MODULATION TYPE</b>	DBPSK	<b>TRANSFER RATE</b>	1Mbps
<b>INPUT POWER (SYSTEM)</b>	120Vac, 60 Hz	<b>ENVIRONMENTAL CONDITIONS</b>	25deg.C, 63%RH, 991hPa
<b>TESTED BY</b>	Lori Chiu		

CHANNEL	CHANNEL FREQUENCY (MHz)	RF POWER LEVEL IN 3kHz BW (mW)		RF POWER LEVEL IN 3kHz BW (dBm)		TOTAL POWER DENSITY (mW)	TOTAL POWER DENSITY (dBm)	MAX. LIMIT (dBm)	PASS / FAIL
		CHAIN 0	CHAIN 1	CHAIN 0	CHAIN 1				
1	2412	0.094	0.116	-10.27	-9.35	0.210	-6.778	8	PASS
6	2437	0.073	0.093	-11.36	-10.33	0.166	-7.799	8	PASS
11	2462	0.067	0.073	-11.71	-11.39	0.140	-8.539	8	PASS

### FOR CHAIN 0: CH 1

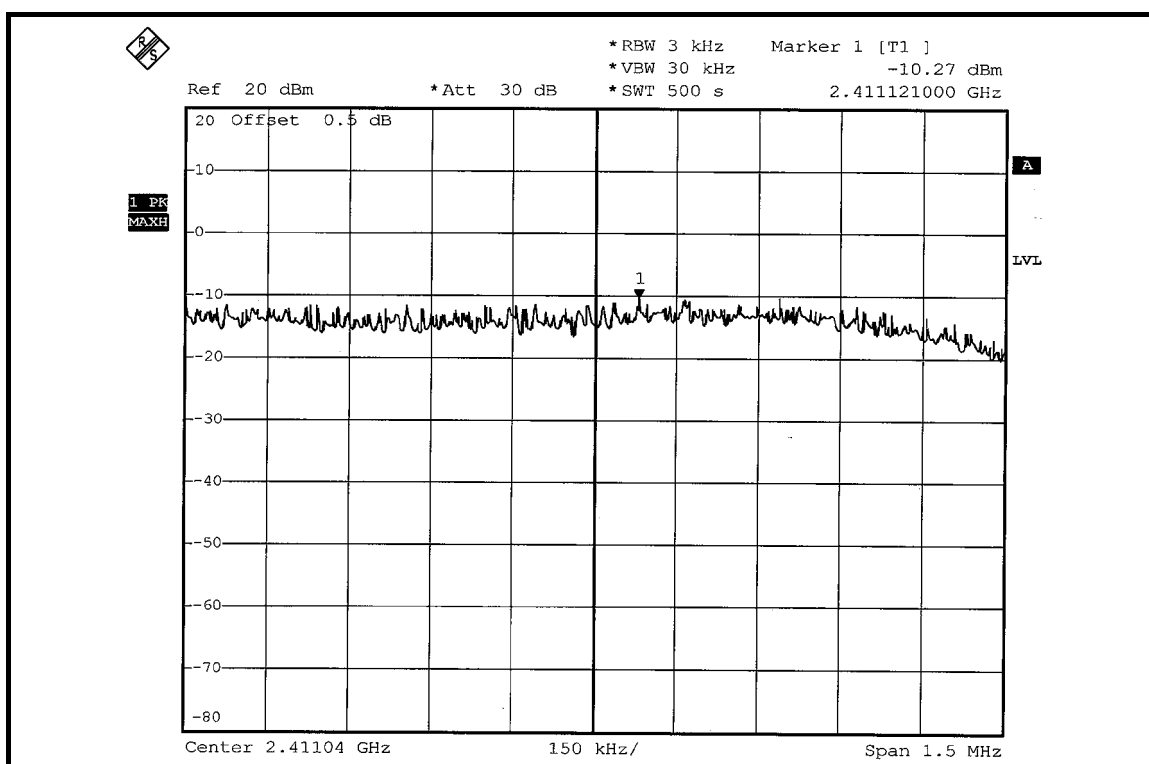

CH 6

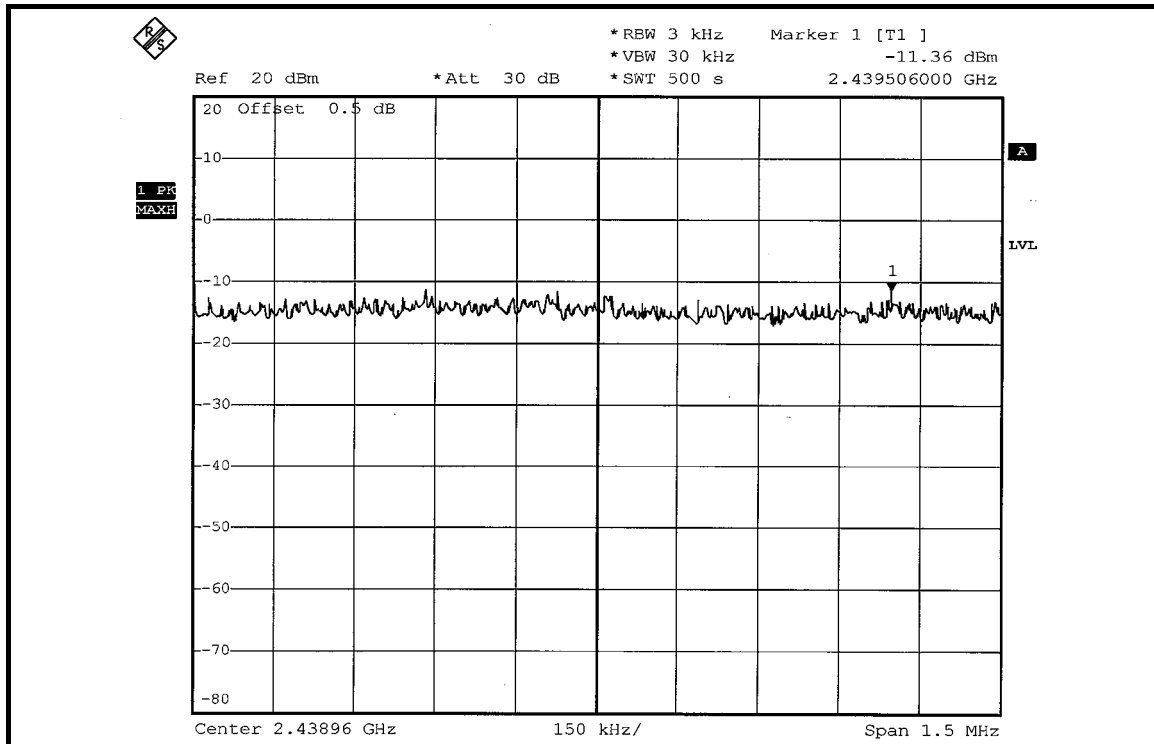

CH 11

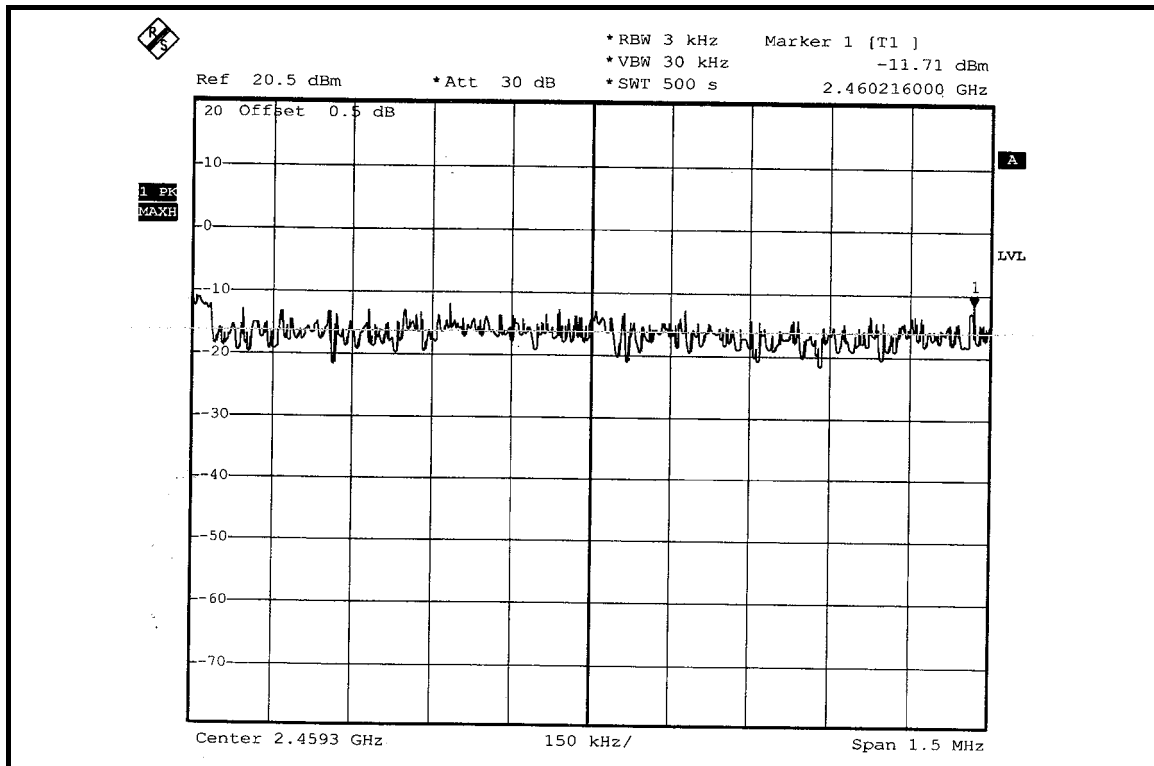

FOR CHAIN 1: CH 1

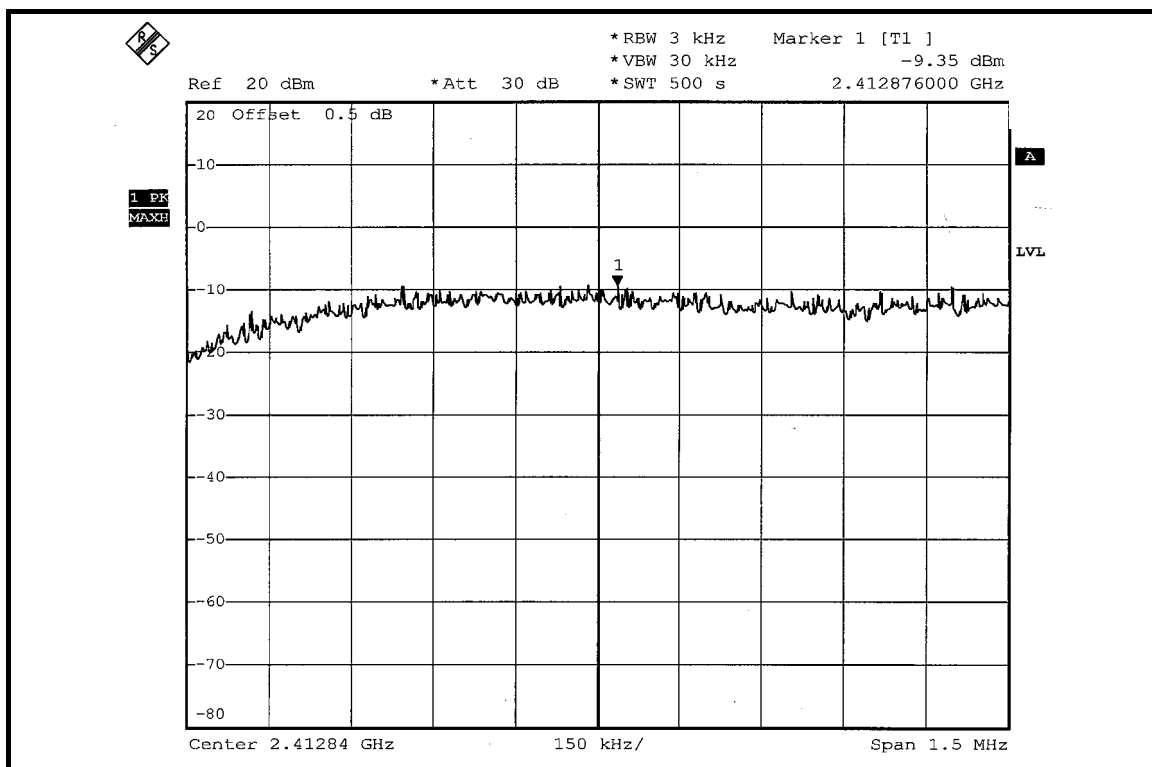

CH 6

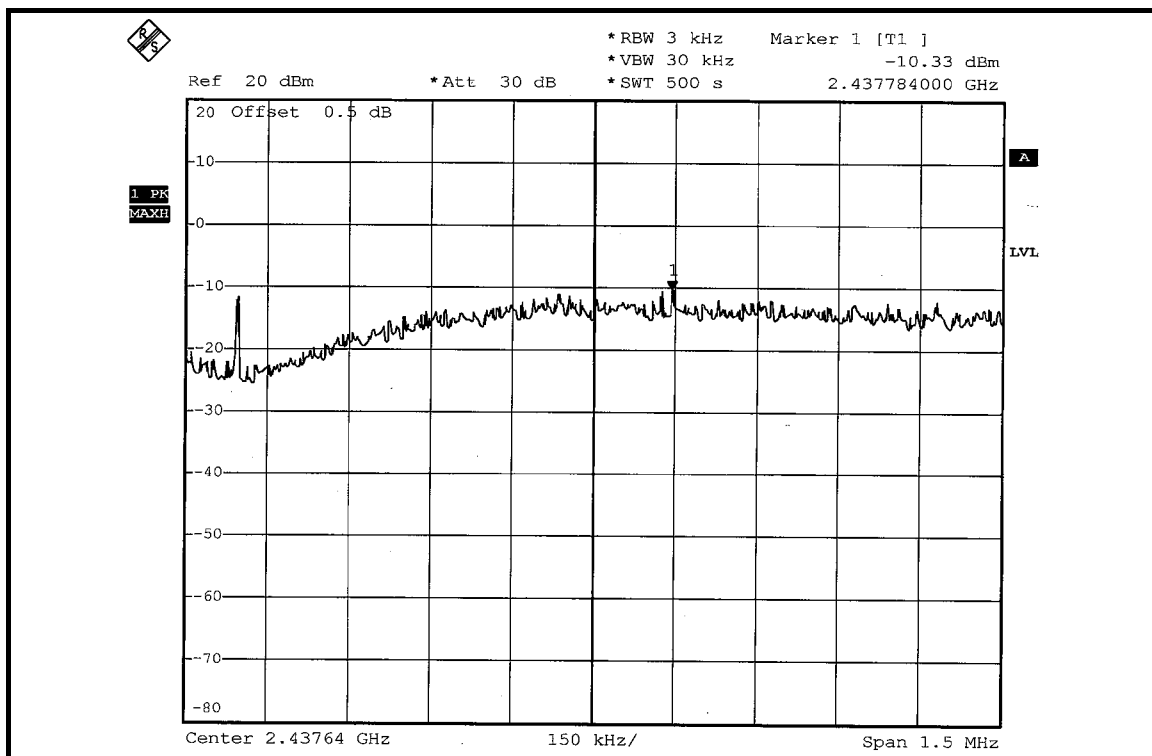

CH 11

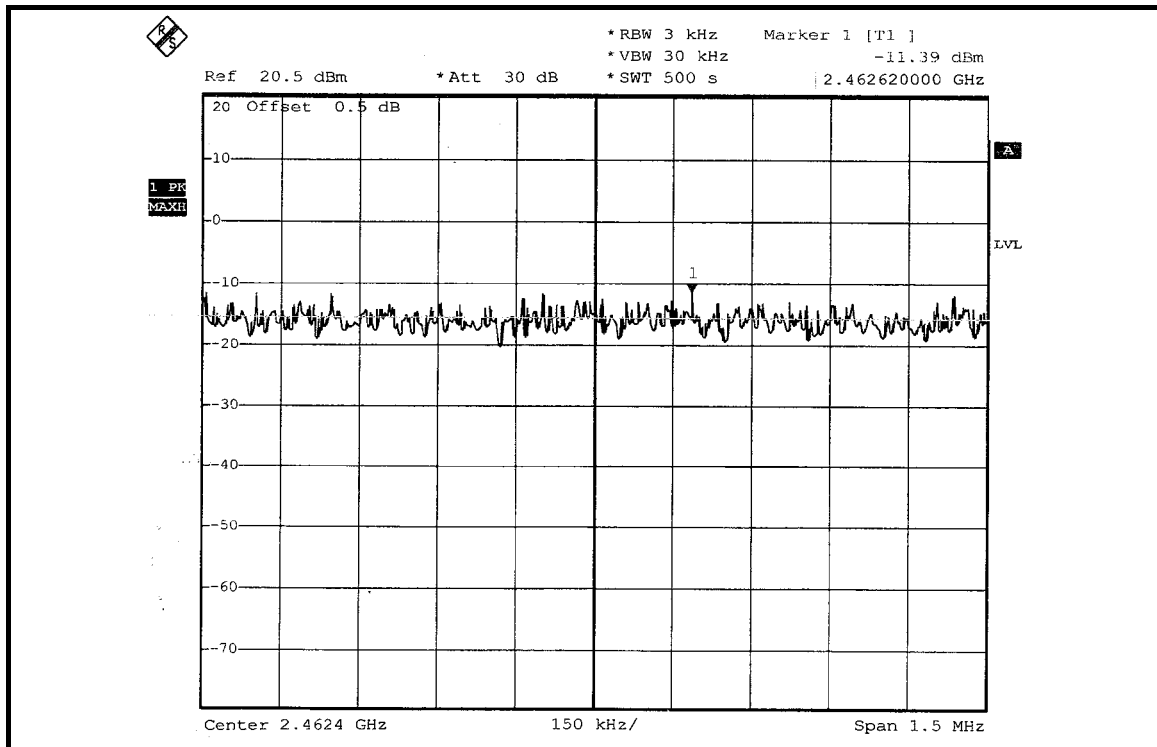



**802.11g OFDM MODULATION:**

<b>MODULATION TYPE</b>	BPSK	<b>TRANSFER RATE</b>	6Mbps
<b>INPUT POWER (SYSTEM)</b>	120Vac, 60 Hz	<b>ENVIRONMENTAL CONDITIONS</b>	25deg.C, 63%RH, 991hPa
<b>TESTED BY</b>	Lori Chiu		

CHANNEL	CHANNEL FREQUENCY (MHz)	RF POWER LEVEL IN 3kHz BW (mW)		RF POWER LEVEL IN 3kHz BW (dBm)		TOTAL POWER DENSITY (mW)	TOTAL POWER DENSITY (dBm)	MAX. LIMIT (dBm)	PASS / FAIL
		CHAIN 0	CHAIN 1	CHAIN 0	CHAIN 1				
1	2412	0.072	0.074	-11.44	-11.31	0.146	-8.356	8	PASS
6	2437	0.070	0.077	-11.52	-11.14	0.147	-8.327	8	PASS
11	2462	0.039	0.040	-14.11	-13.97	0.079	-11.024	8	PASS

**FOR CHAIN 0: CH 1**

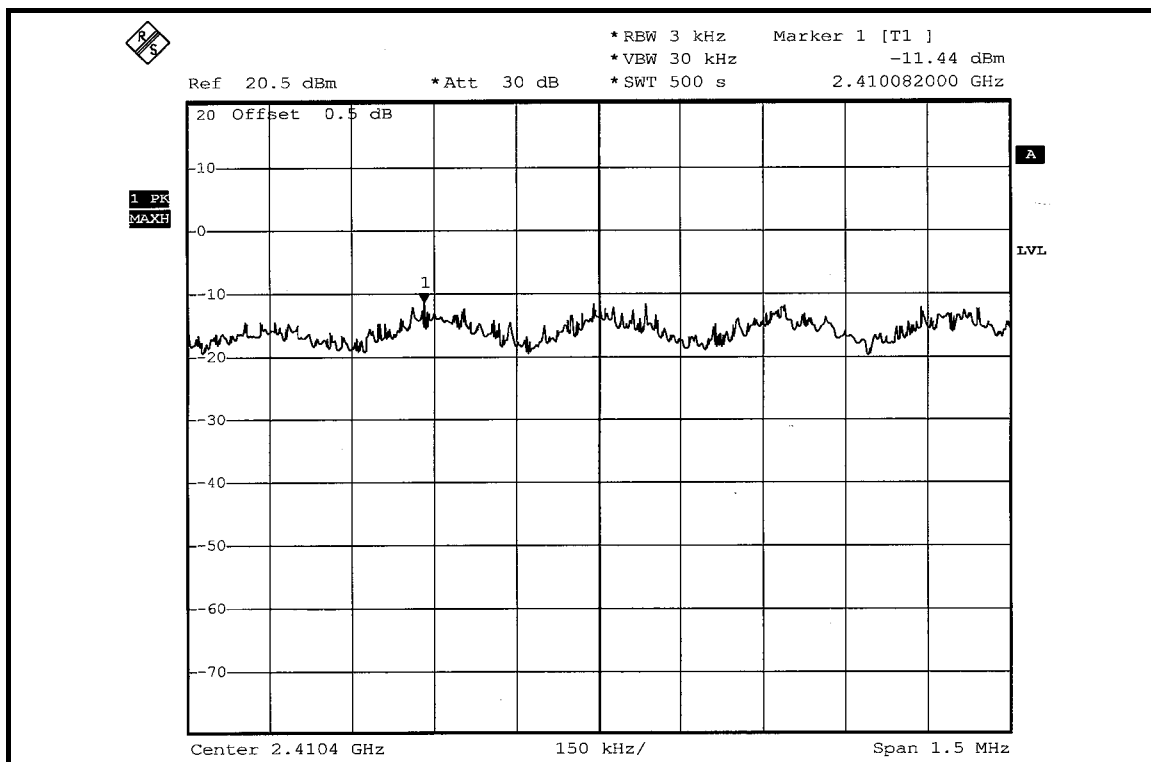

CH 6

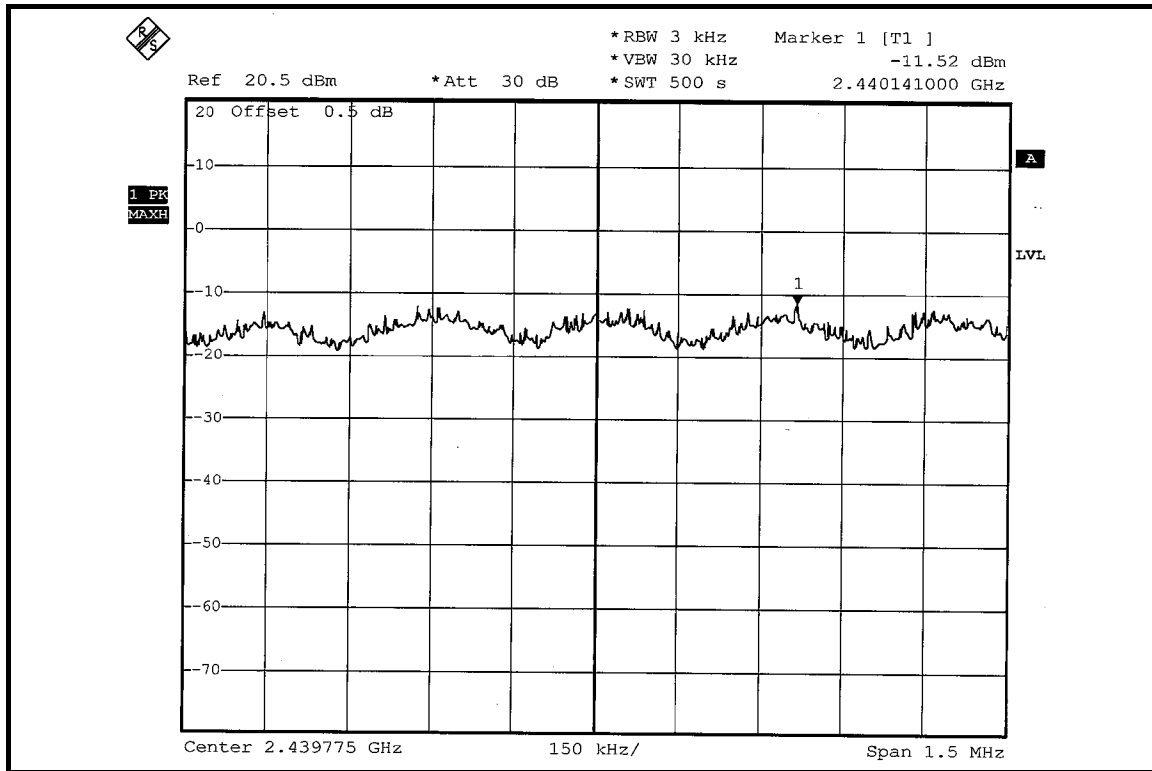

CH 11

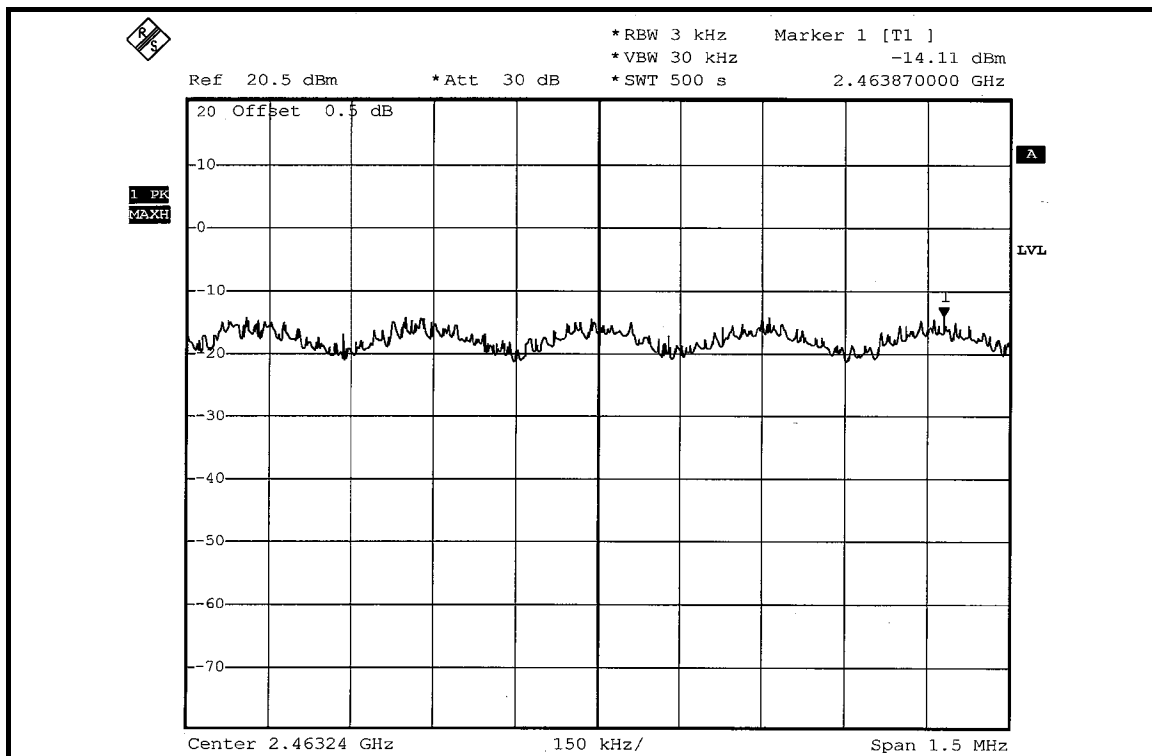





CH 11

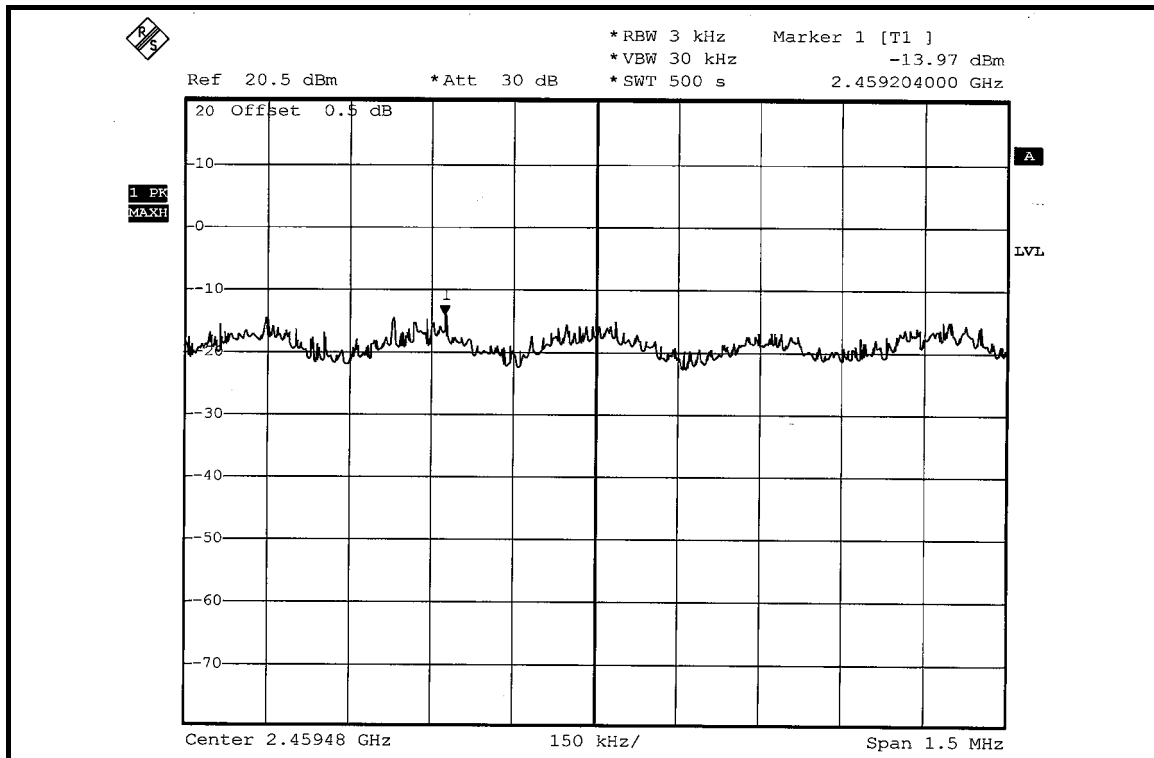



**DRAFT 802.11n (20MHz) OFDM MODULATION: DUAL TX:**

<b>MODULATION TYPE</b>	BPSK	<b>TRANSFER RATE</b>	7.2Mbps
<b>INPUT POWER (SYSTEM)</b>	120Vac, 60 Hz	<b>ENVIRONMENTAL CONDITIONS</b>	25deg.C, 63%RH, 991hPa
<b>TESTED BY</b>	Lori Chiu		

CHANNEL	CHANNEL FREQUENCY (MHz)	RF POWER LEVEL IN 3kHz BW (mW)		RF POWER LEVEL IN 3kHz BW (dBm)		TOTAL POWER DENSITY (mW)	TOTAL POWER DENSITY (dBm)	MAX. LIMIT (dBm)	PASS / FAIL
		CHAIN 0	CHAIN 1	CHAIN 0	CHAIN 1				
1	2412	0.071	0.077	-11.49	-11.14	0.148	-8.297	8	PASS
6	2437	0.069	0.077	-11.64	-11.15	0.146	-7.851	8	PASS
11	2462	0.050	0.056	-12.97	-12.48	0.106	-9.747	8	PASS

**FOR CHAIN 0: CH 1**

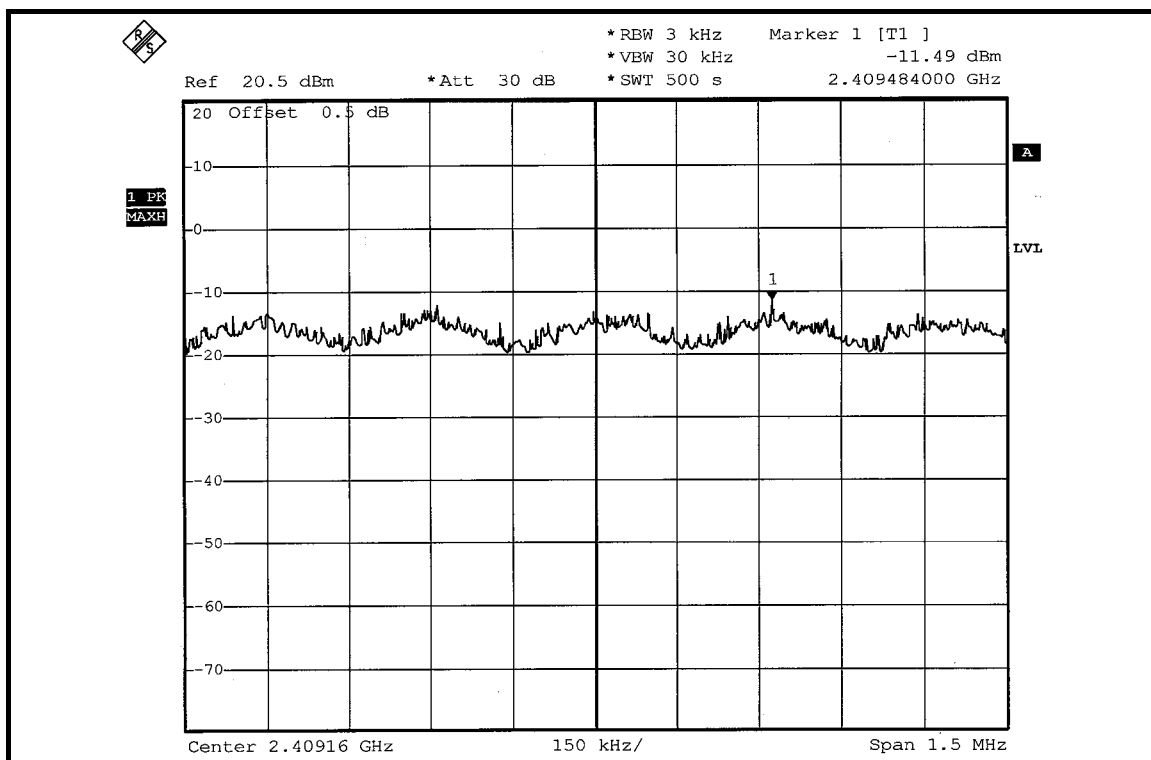

CH 6

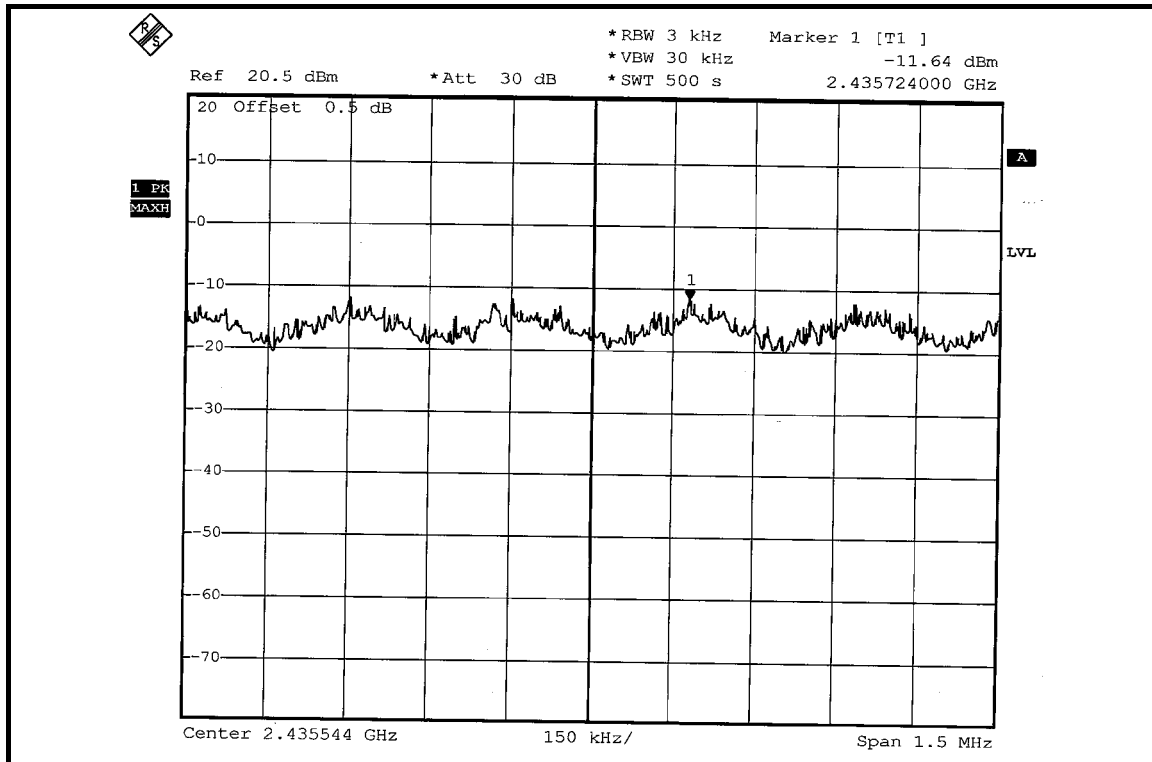

CH 11

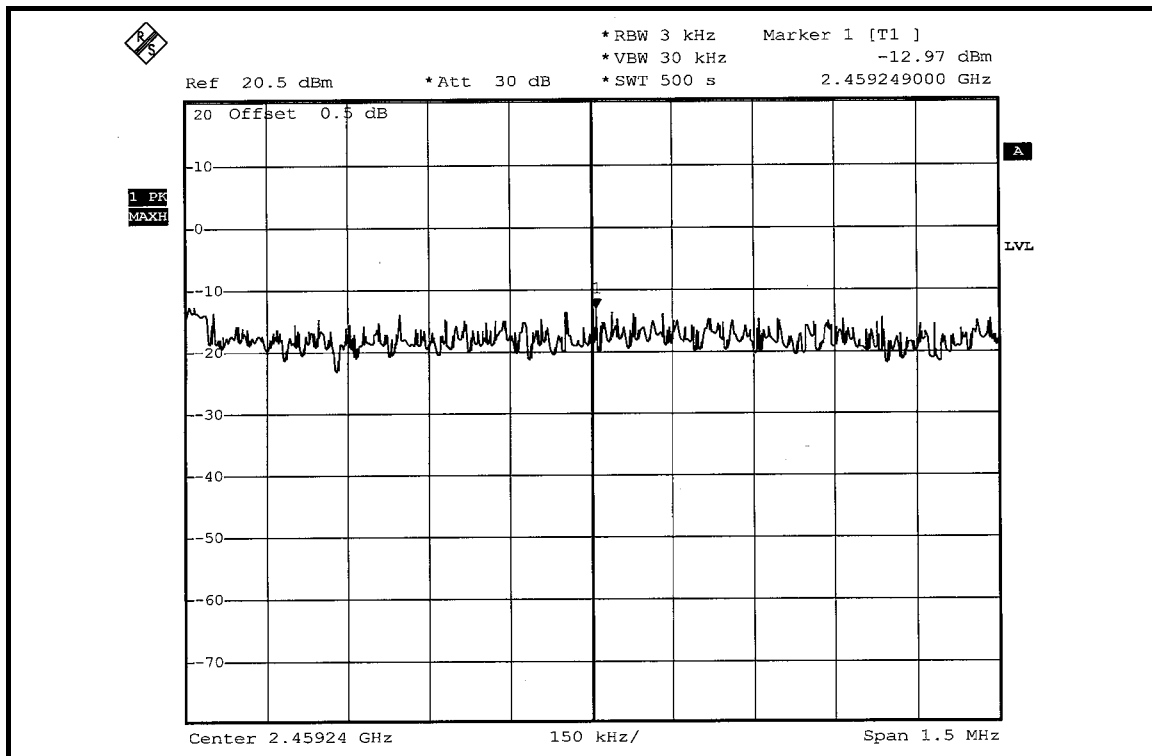

FOR CHAIN 1: CH 1

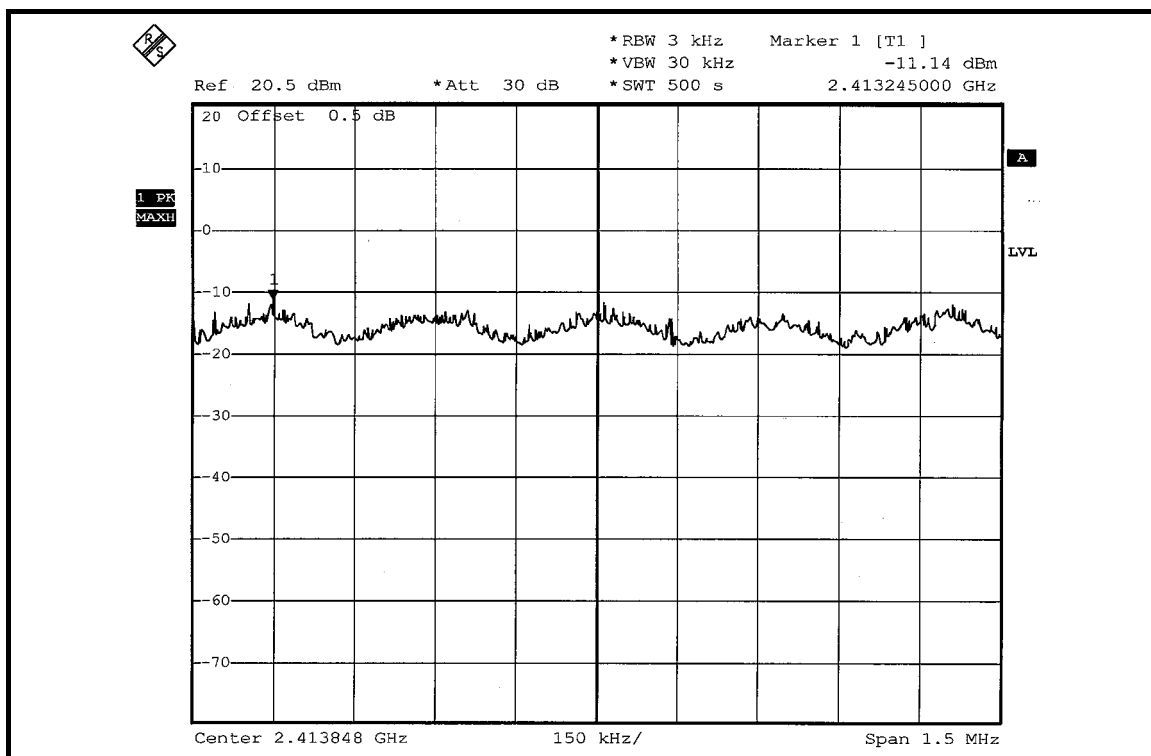

CH 6

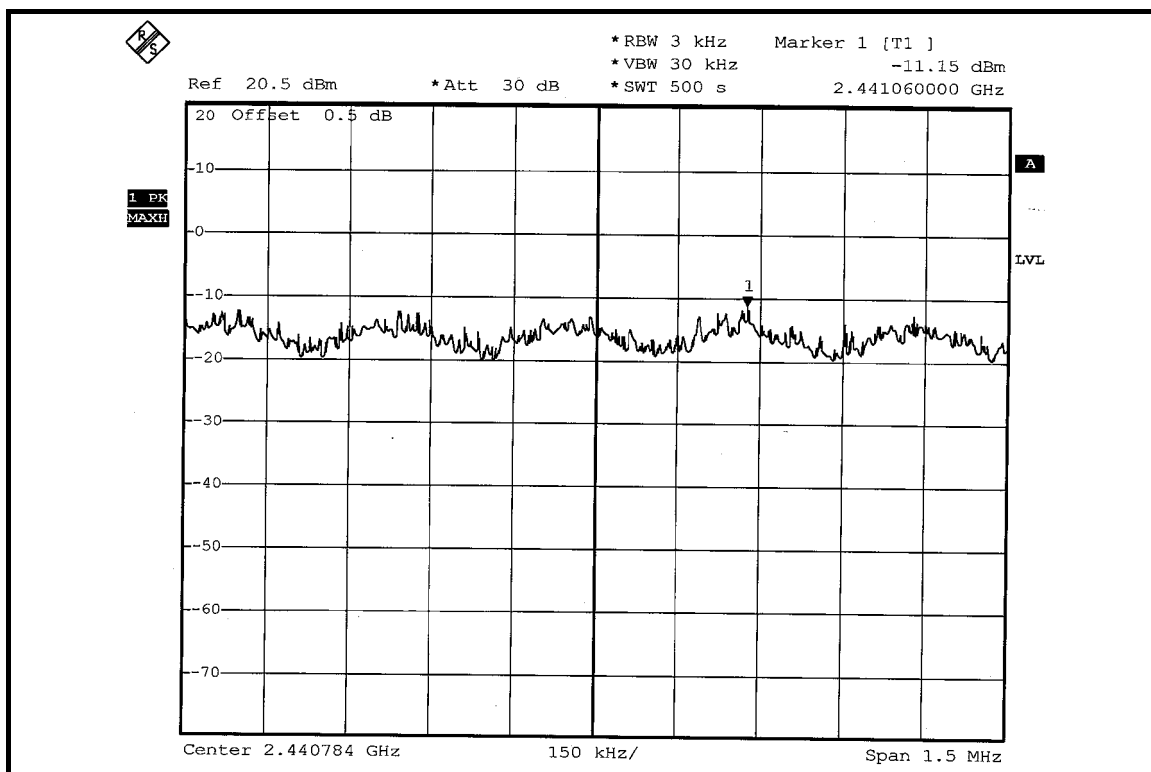





**DRAFT 802.11n (40MHz) OFDM MODULATION: DUAL TX:**

<b>MODULATION TYPE</b>	BPSK	<b>TRANSFER RATE</b>	15Mbps
<b>INPUT POWER (SYSTEM)</b>	120Vac, 60 Hz	<b>ENVIRONMENTAL CONDITIONS</b>	25deg.C, 63%RH, 991hPa
<b>TESTED BY</b>	Lori Chiu		

CHANNEL	CHANNEL FREQUENCY (MHz)	RF POWER LEVEL IN 3kHz BW (mW)		RF POWER LEVEL IN 3kHz BW (dBm)		TOTAL POWER DENSITY (mW)	TOTAL POWER DENSITY (dBm)	MAX. LIMIT (dBm)	PASS / FAIL
		CHAIN 0	CHAIN 1	CHAIN 0	CHAIN 1				
1	2422	0.013	0.015	-18.99	-18.27	0.028	-15.528	8	PASS
4	2437	0.013	0.014	-18.86	-18.39	0.027	-15.686	8	PASS
7	2452	0.015	0.013	-18.27	-18.71	0.028	-15.528	8	PASS

**FOR CHAIN 0: CH 1**

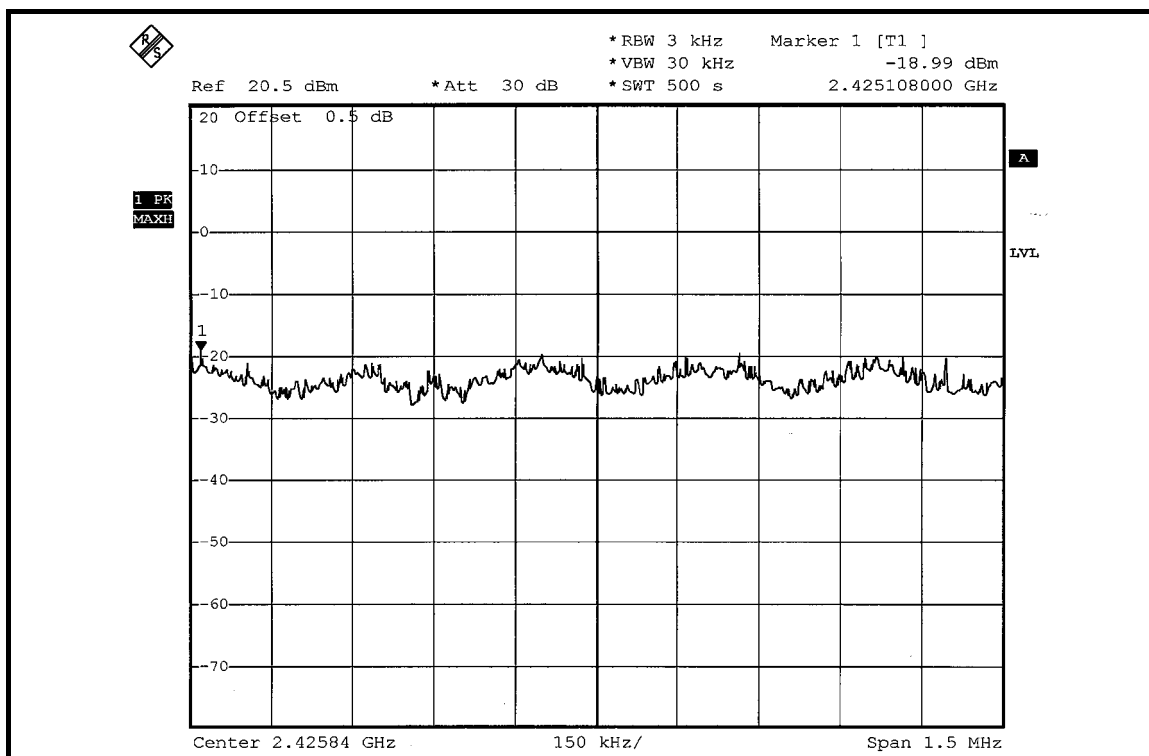

CH 4

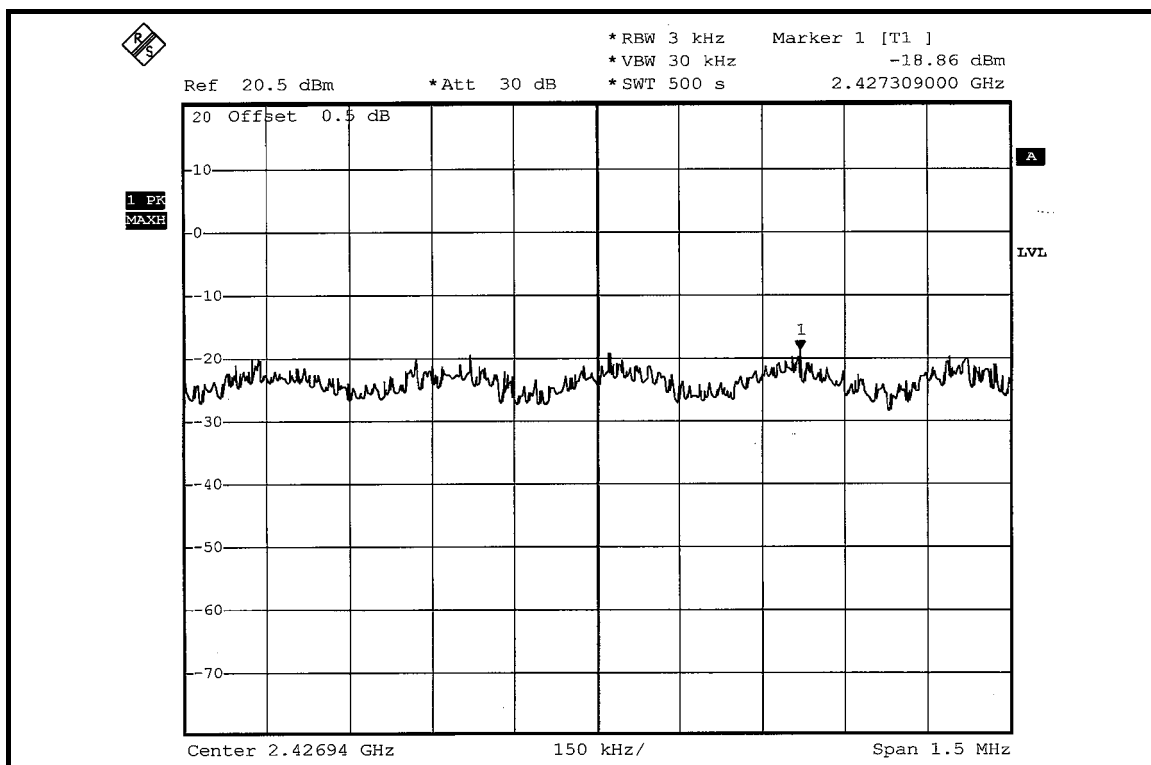

CH 7

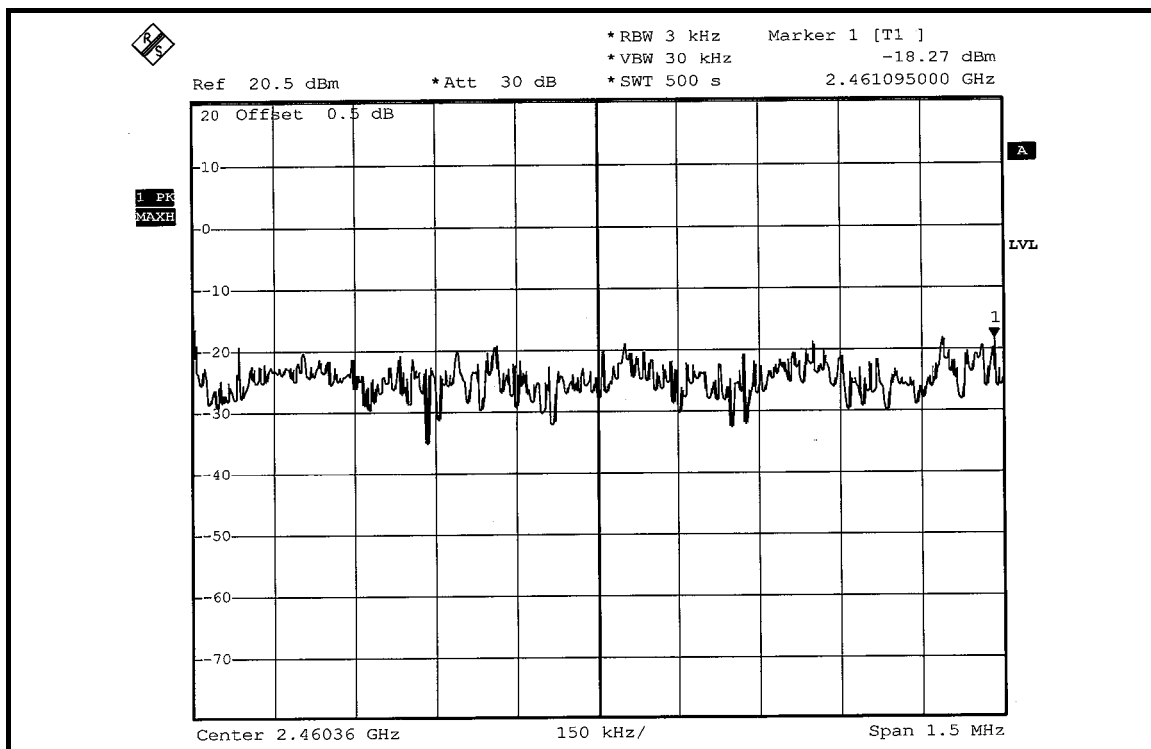









## 4.6 BAND EDGES MEASUREMENT

### 4.6.1 LIMITS OF BAND EDGES MEASUREMENT

Below  $-20\text{dB}$  of the highest emission level of operating band (in 100kHz Resolution Bandwidth).

### 4.6.2 TEST INSTRUMENTS

DESCRIPTION & MANUFACTURER	MODEL NO.	SERIAL NO.	CALIBRATED UNTIL
R&S SPECTRUM ANALYZER	FSEK30	100049	Aug. 14, 2006

**NOTE:** The calibration interval of the above test instruments is 12 months and the calibrations are traceable to NML/ROC and NIST/USA.

#### 4.6.3 TEST PROCEDURE

- a. The EUT was placed on the top of a rotating table 0.8 meters above the ground at a 3 meter semi-anechoic chamber. The table was rotated 360 degrees to determine the position of the highest radiation.
- b. The EUT was set 3 meters away from the interference-receiving antenna, which was mounted on the top of a variable-height antenna tower.
- c. The antenna is a broadband antenna, and its height is varied from one meter to four meters above the ground to determine the maximum value of the field strength. Both horizontal and vertical polarizations of the antenna are set to make the measurement.
- d. For each suspected emission, the EUT was arranged to its worst case and then the antenna was tuned to heights from 1 meter to 4 meters and the rotatable table was turned from 0 degrees to 360 degrees to find the maximum reading.
- e. Set both RBW and VBW of spectrum analyzer to 100kHz with suitable frequency span including 100MHz bandwidth from band edge. The band edges was measured and recorded.

The spectrum plots (Peak RBW = VBW = 100kHz; Average RBW = 1MHz, VBW = 10Hz)

**NOTE:** The resolution bandwidth of test receiver/spectrum analyzer is 1 MHz and the video bandwidth is 10Hz for Average detection (AV) at frequency above 1GHz.

#### 4.6.4 DEVIATION FROM TEST STANDARD

No deviation

#### 4.6.5 EUT OPERATING CONDITION

Same as Item 4.3.6.

#### 4.6.6 TEST RESULTS

The spectrum plots are attached on the following 24 images. D1 line indicates the highest level, and D2 line indicates the 20dB offset below D1. It shows compliance with the requirement in part 15.247(d).

#### **802.11b DSSS MODULATION:**

##### **NOTE 1:**

The band edge emission plot of DSSS technique on the next page shows 51.29dBc between carrier maximum power and local maximum emission in restrict band (2.3520GHz). The emission of carrier strength list in the test result of channel 1 at the item 4.2.7 is 110.88dBuV/m (Peak), so the maximum field strength in restrict band is  $110.88 - 51.29 = 59.59$ dBuV/m which is under 74dBuV/m limit.

The band edge emission plot of DSSS technique on the next page shows 59.06dBc between carrier maximum power and local maximum emission in restrict band (2.3894GHz). The emission of carrier strength list in the test result of channel 1 at the item 4.2.7 is 107.32dBuV/m (Average), so the maximum field strength in restrict band is  $107.32 - 59.06 = 48.26$ dBuV/m which is under 54dBuV/m limit.

##### **NOTE 2:**

The band edge emission plot of DSSS technique on the next second page shows 50.28dBc between carrier maximum power and local maximum emission in restrict band (2.4911GHz). The emission of carrier strength list in the test result of channel 11 at the item 4.2.7 is 109.30dBuV/m (Peak), so the maximum field strength in restrict band is  $109.30 - 50.28 = 59.02$ dBuV/m which is under 74dBuV/m limit.

The band edge emission plot of DSSS technique on the next third page shows 55.24dBc between carrier maximum power and local maximum emission in restrict band (2.4835GHz). The emission of carrier strength list in the test result of channel 11 at the item 4.2.7 is 105.52dBuV/m (Average), so the maximum field strength in restrict band is  $105.52 - 55.24 = 50.28$ dBuV/m which is under 54dBuV/m limit.

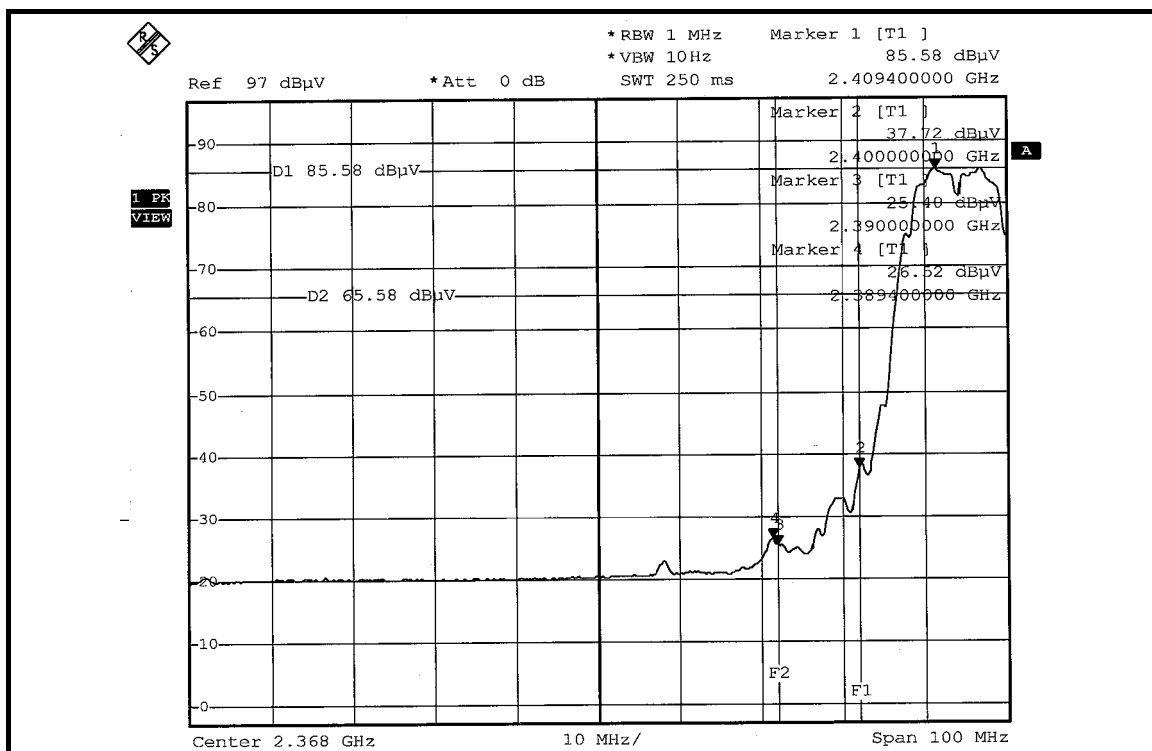
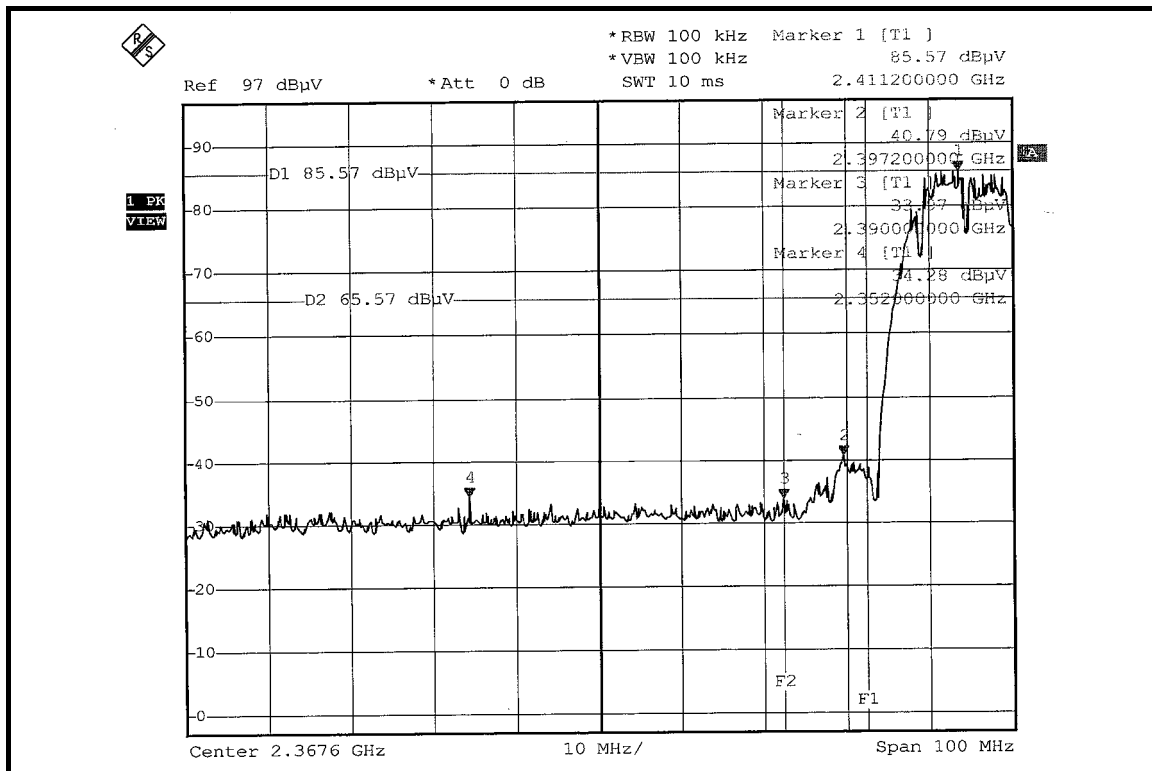

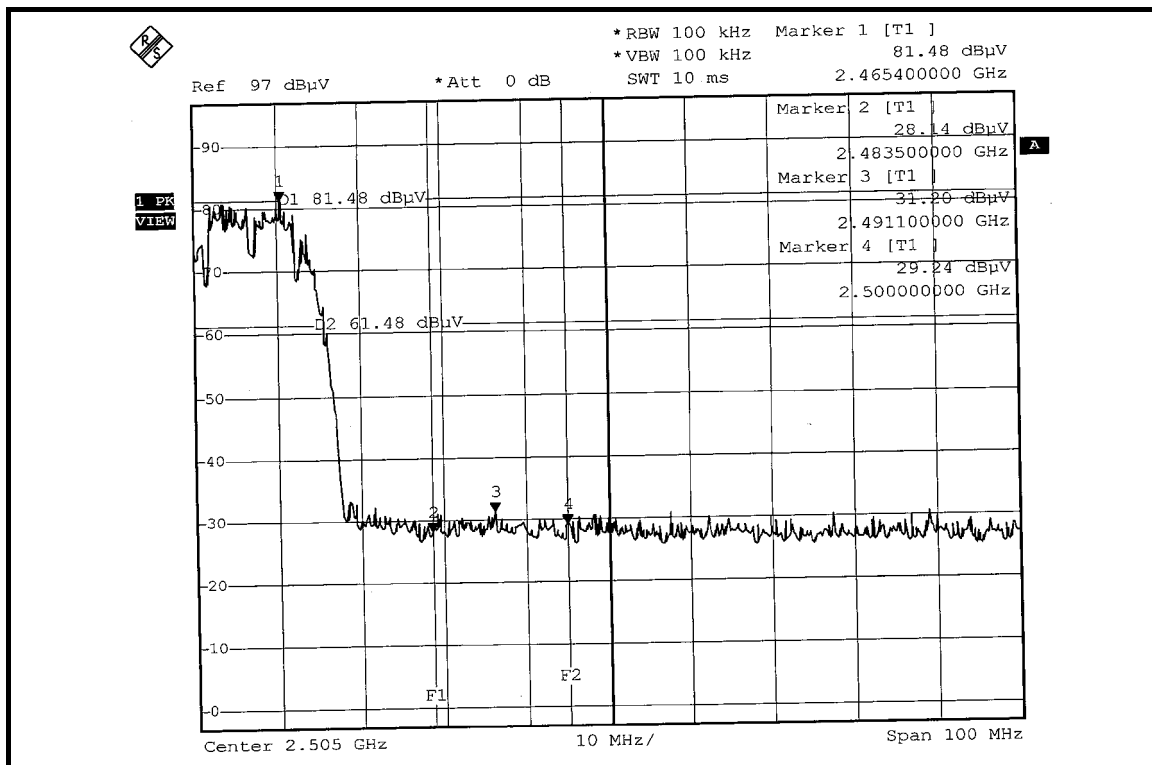
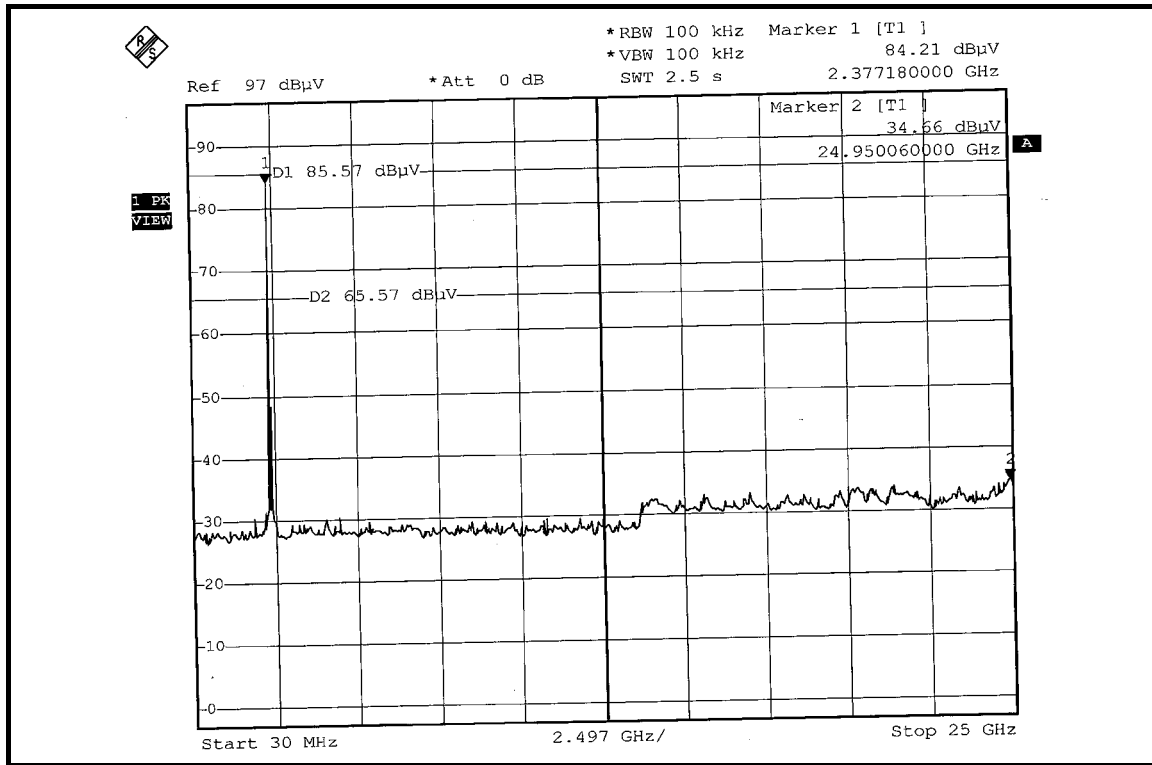

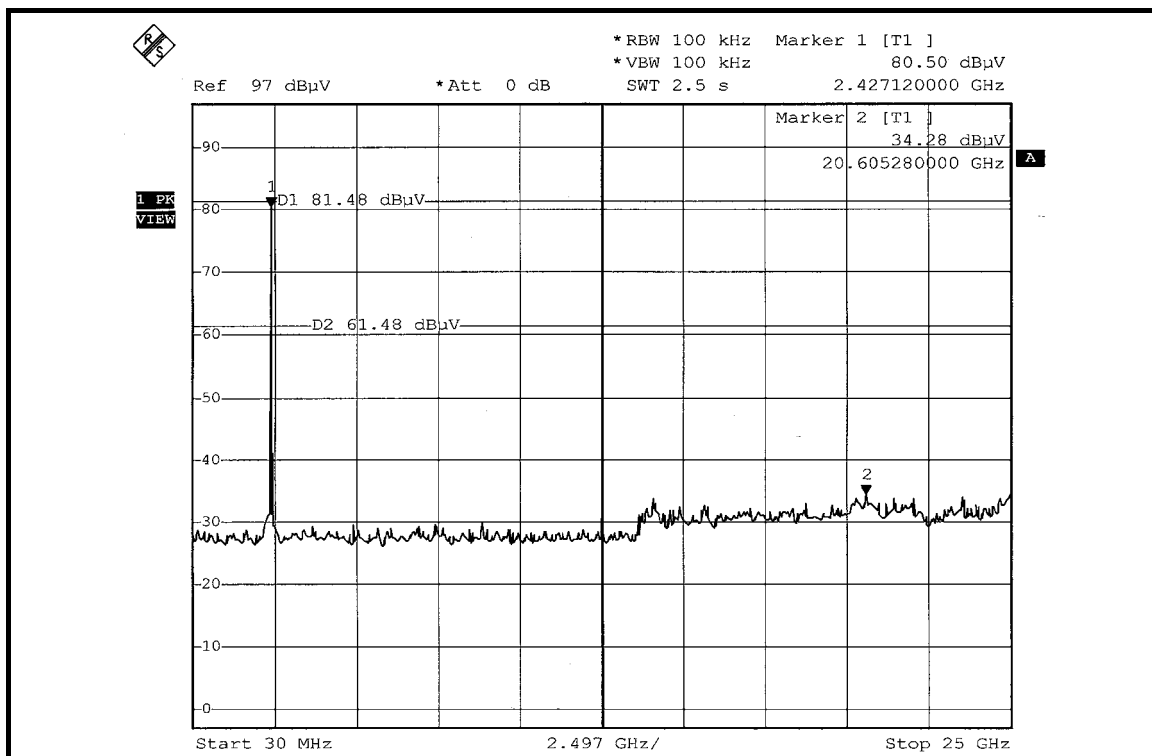
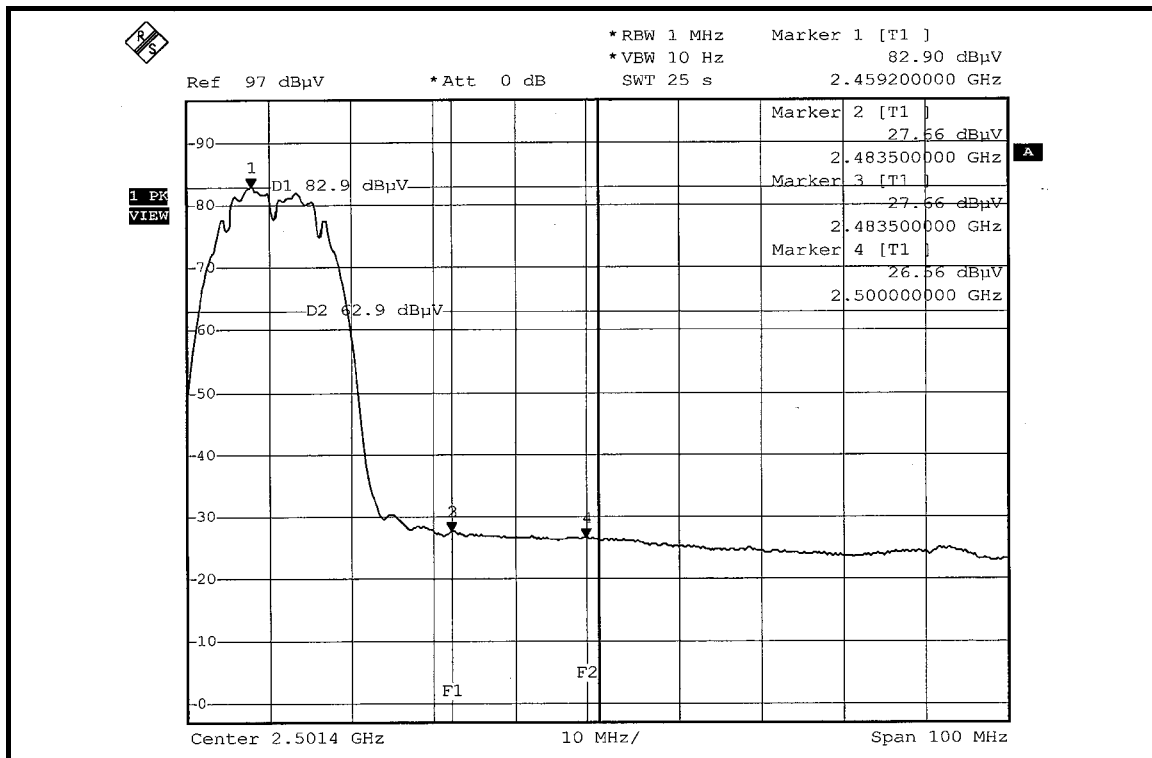



## 802.11g OFDM MODULATION:

### NOTE 1:

The band edge emission plot of OFDM technique on the next page shows 48.82dBc between carrier maximum power and local maximum emission in restrict band (2.3504GHz). The emission of carrier strength list in the test result of channel 1 at the item 4.2.7 is 112.43dBuV/m (Peak), so the maximum field strength in restrict band is  $112.43 - 48.82 = 63.61$ dBuV/m which is under 74dBuV/m limit.

The band edge emission plot of OFDM technique on the next page shows 50.94dBc between carrier maximum power and local maximum emission in restrict band (2.3900GHz). The emission of carrier strength list in the test result of channel 1 at the item 4.2.7 is 103.24dBuV/m (Average), so the maximum field strength in restrict band is  $103.24 - 50.94 = 52.30$ dBuV/m which is under 54dBuV/m limit.

### NOTE 2:

The band edge emission plot of OFDM technique on the next second page shows 47.84dBc between carrier maximum power and local maximum emission in restrict band (2.4899GHz). The emission of carrier strength list in the test result of channel 11 at the item 4.2.7 is 111.14dBuV/m (Peak), so the maximum field strength in restrict band is  $111.14 - 47.84 = 63.33$ dBuV/m which is under 74dBuV/m limit.

The band edge emission plot of OFDM technique on the next third page shows 50.55dBc between carrier maximum power and local maximum emission in restrict band (2.4835GHz). The emission of carrier strength list in the test result of channel 11 at the item 4.2.7 is 101.60dBuV/m (Average), so the maximum field strength in restrict band is  $101.60 - 50.55 = 51.05$ dBuV/m which is under 54dBuV/m limit.

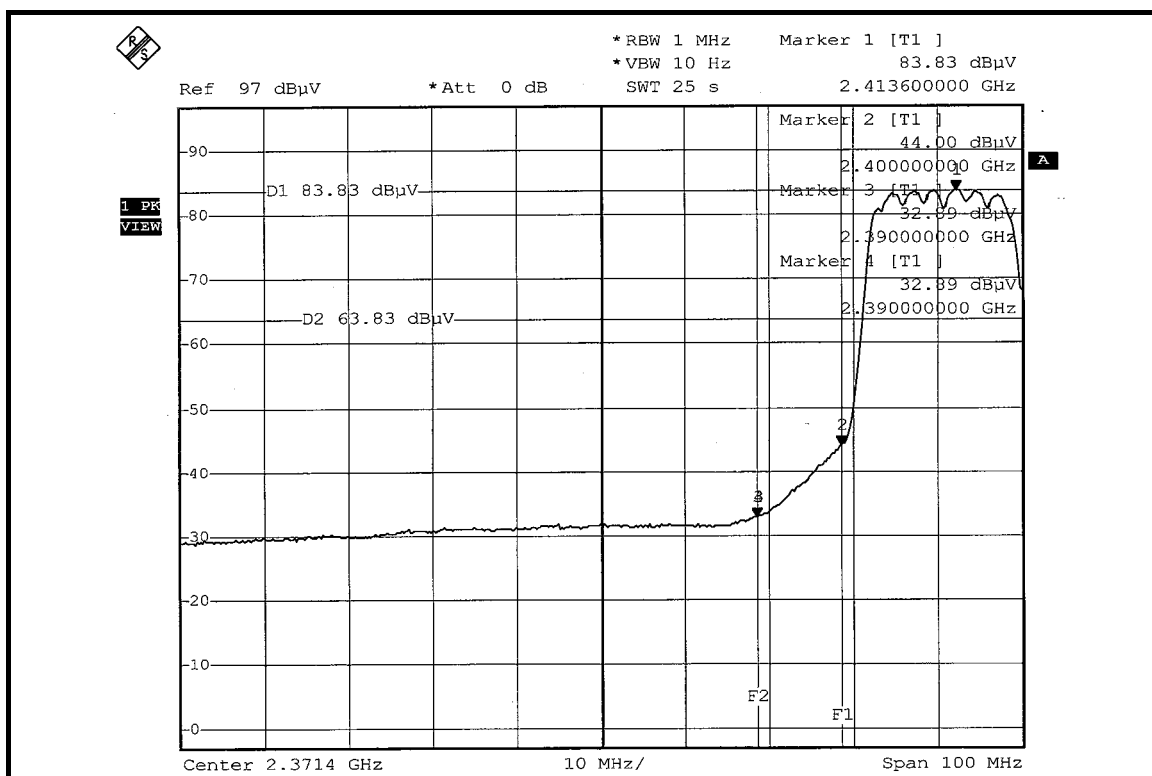
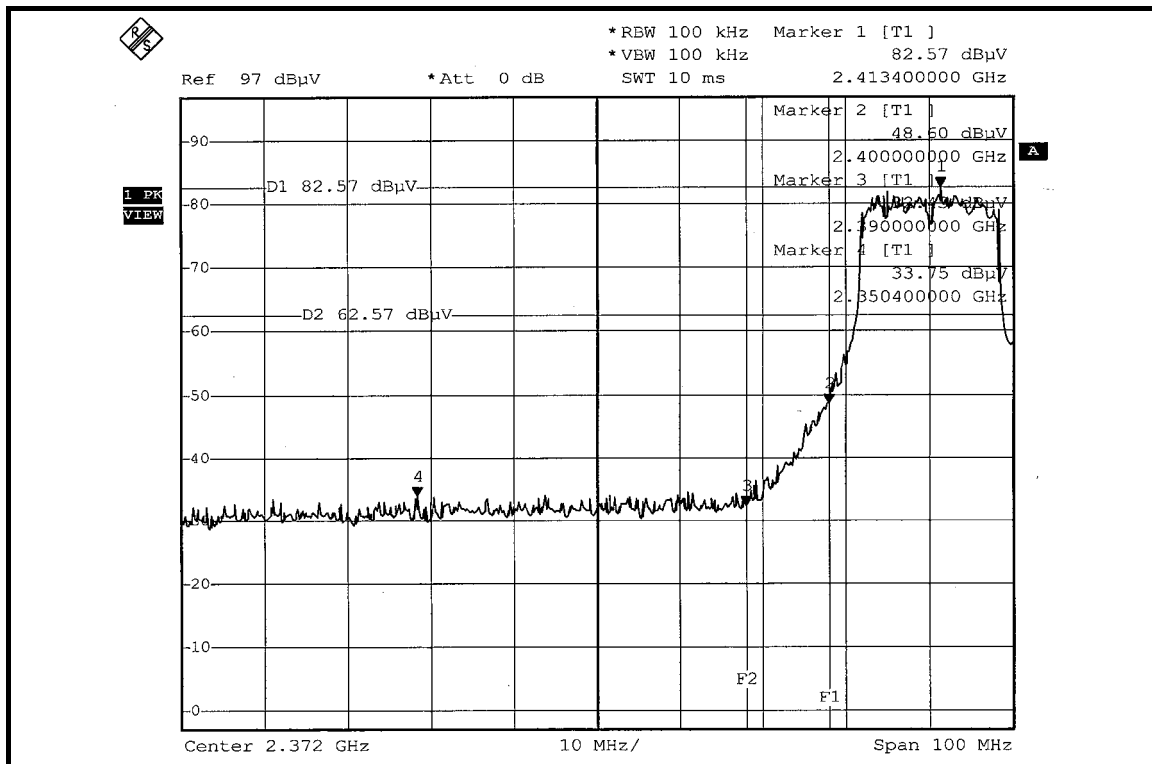

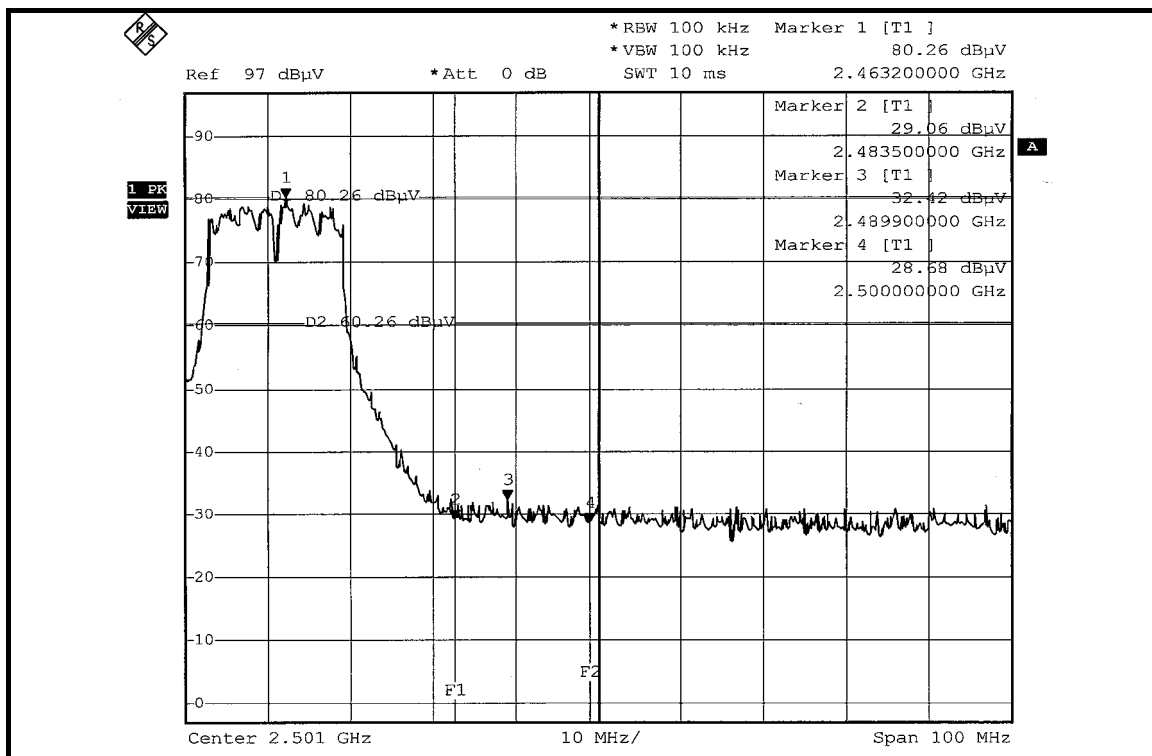
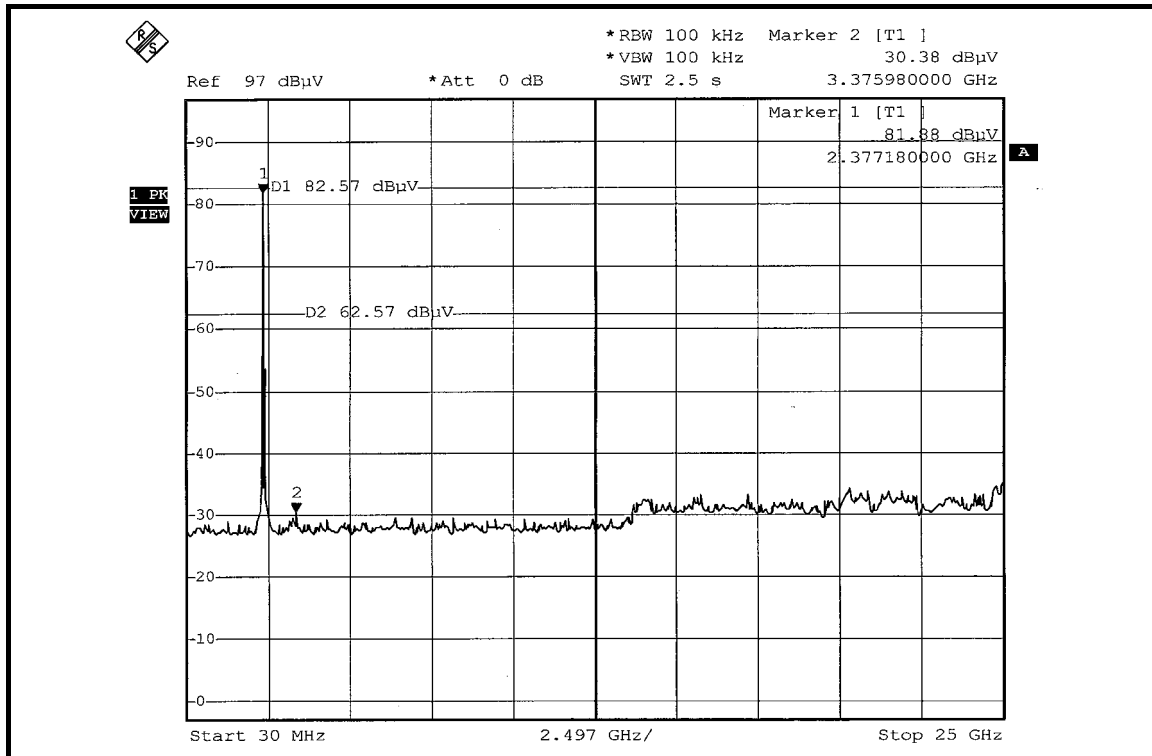

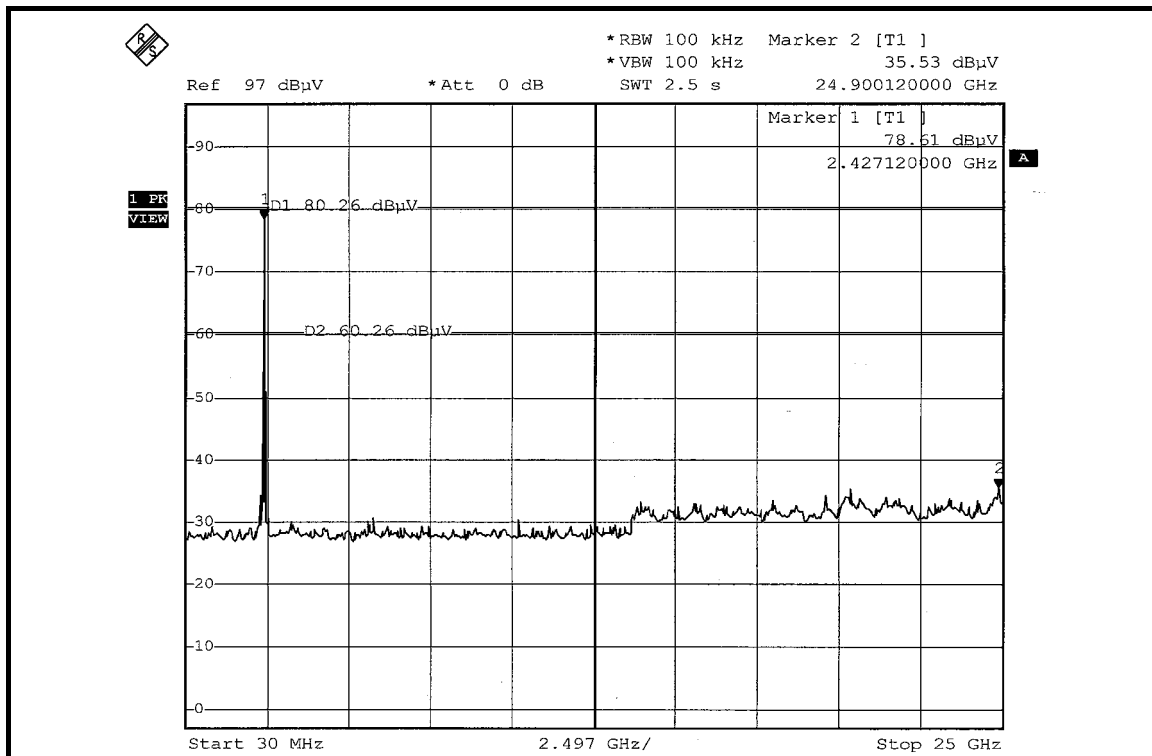
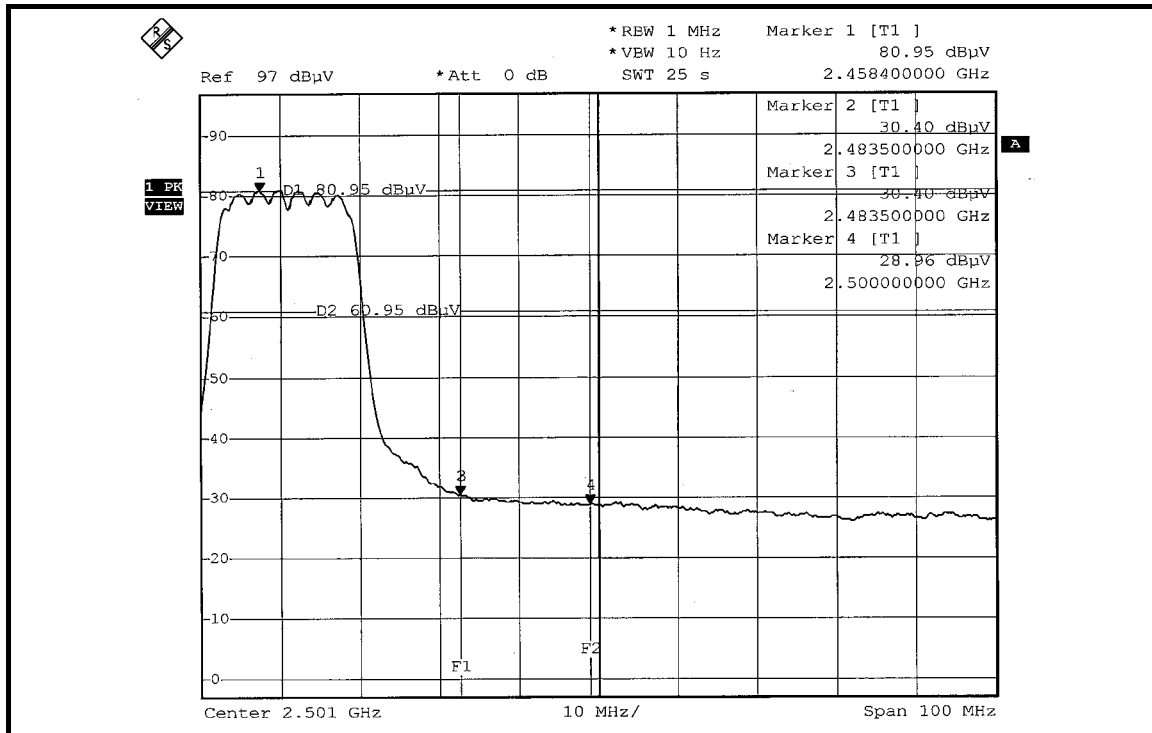



## **DRAFT 802.11n (20MHz) OFDM MODULATION: DUAL TX:**

### **NOTE 1:**

The band edge emission plot of OFDM technique on the next page shows 47.84dBc between carrier maximum power and local maximum emission in restrict band (2.3874GHz). The emission of carrier strength list in the test result of channel 1 at the item 4.2.7 is 112.47dBuV/m (Peak), so the maximum field strength in restrict band is  $112.47 - 47.84 = 64.63$ dBuV/m which is under 74dBuV/m limit.

The band edge emission plot of OFDM technique on the next page shows 50.22dBc between carrier maximum power and local maximum emission in restrict band (2.3900GHz). The emission of carrier strength list in the test result of channel 1 at the item 4.2.7 is 102.16dBuV/m (Average), so the maximum field strength in restrict band is  $102.16 - 50.22 = 51.94$ dBuV/m which is under 54dBuV/m limit.

### **NOTE 2:**

The band edge emission plot of OFDM technique on the next second page shows 47.89dBc between carrier maximum power and local maximum emission in restrict band (2.4835GHz). The emission of carrier strength list in the test result of channel 11 at the item 4.2.7 is 111.22dBuV/m (Peak), so the maximum field strength in restrict band is  $111.22 - 47.89 = 63.33$ dBuV/m which is under 74dBuV/m limit.

The band edge emission plot of OFDM technique on the next third page shows 49.33dBc between carrier maximum power and local maximum emission in restrict band (2.4835GHz). The emission of carrier strength list in the test result of channel 11 at the item 4.2.7 is 101.90dBuV/m (Average), so the maximum field strength in restrict band is  $101.90 - 49.33 = 52.57$ dBuV/m which is under 54dBuV/m limit.

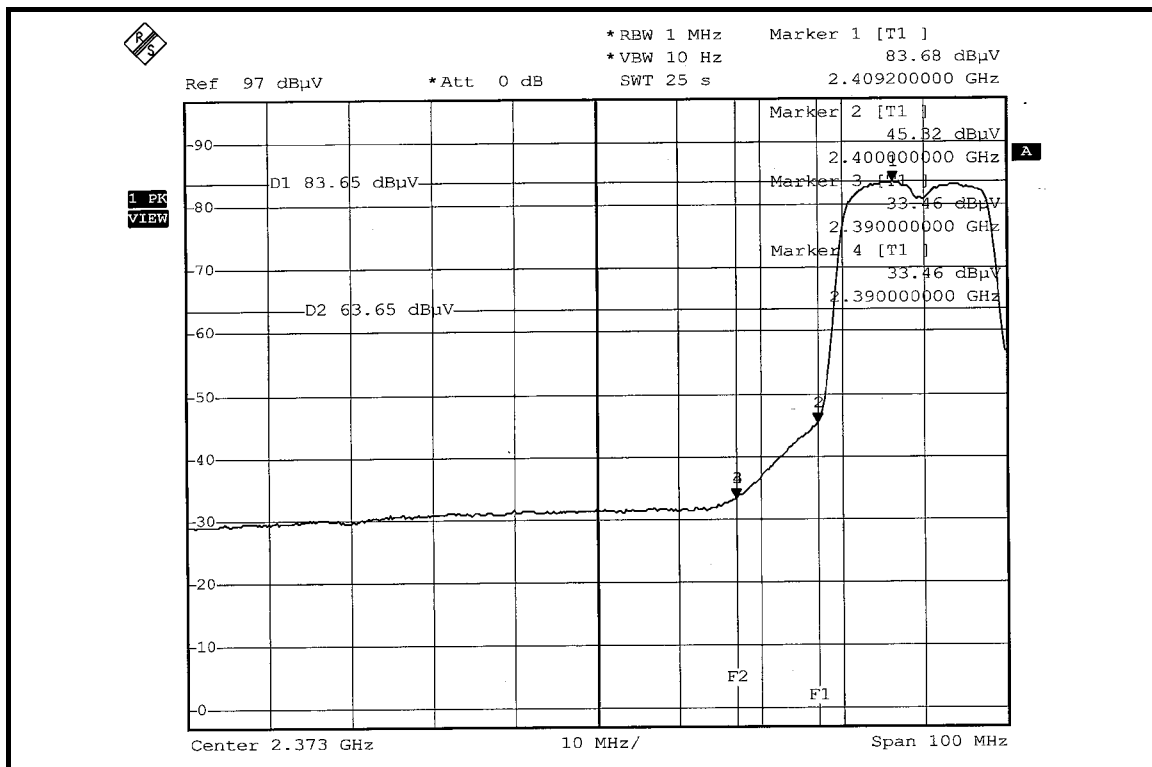
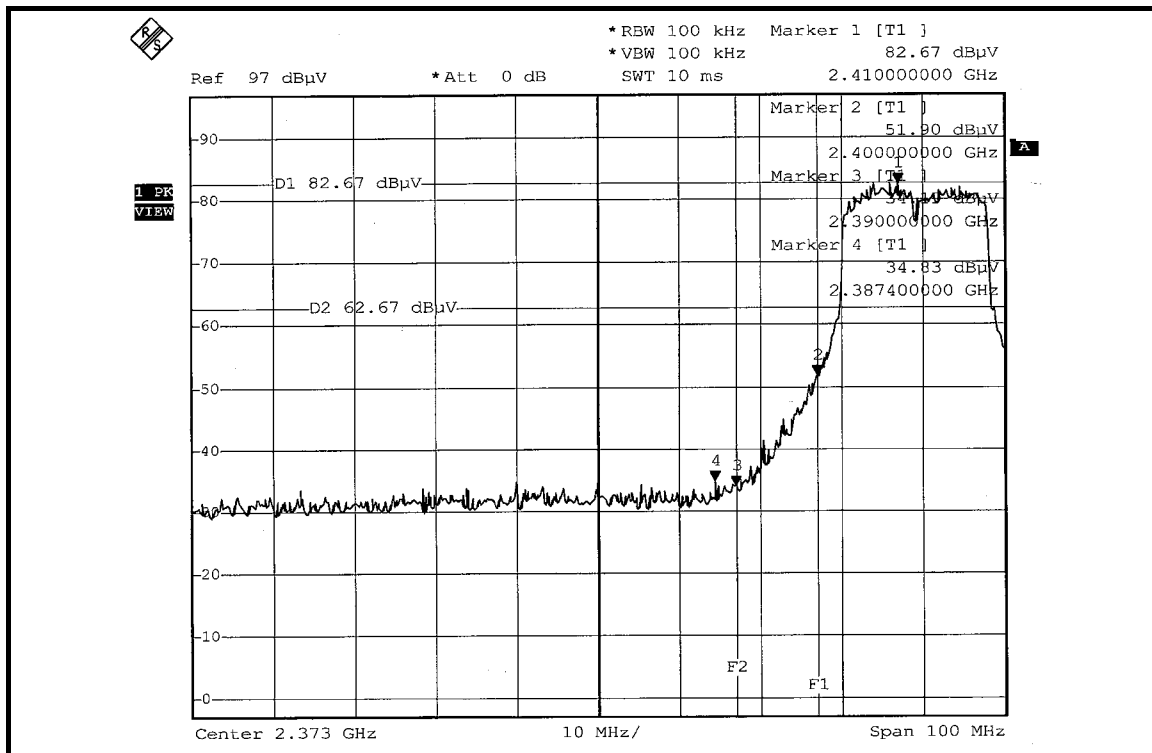

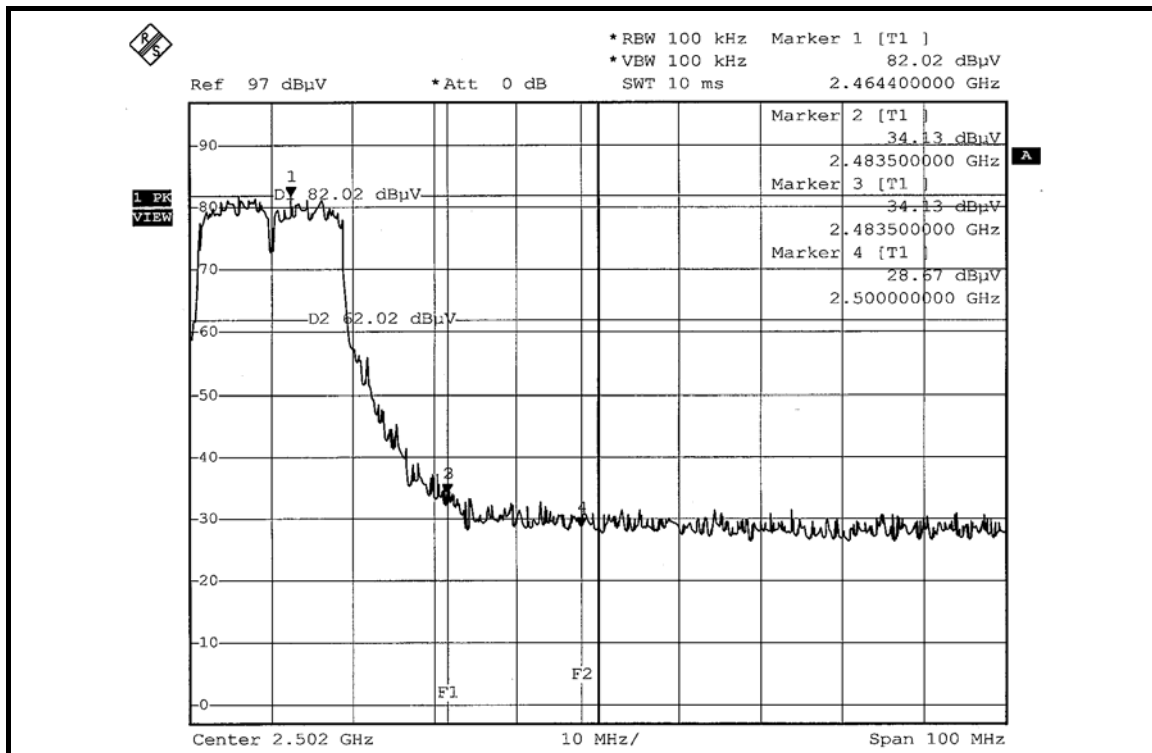
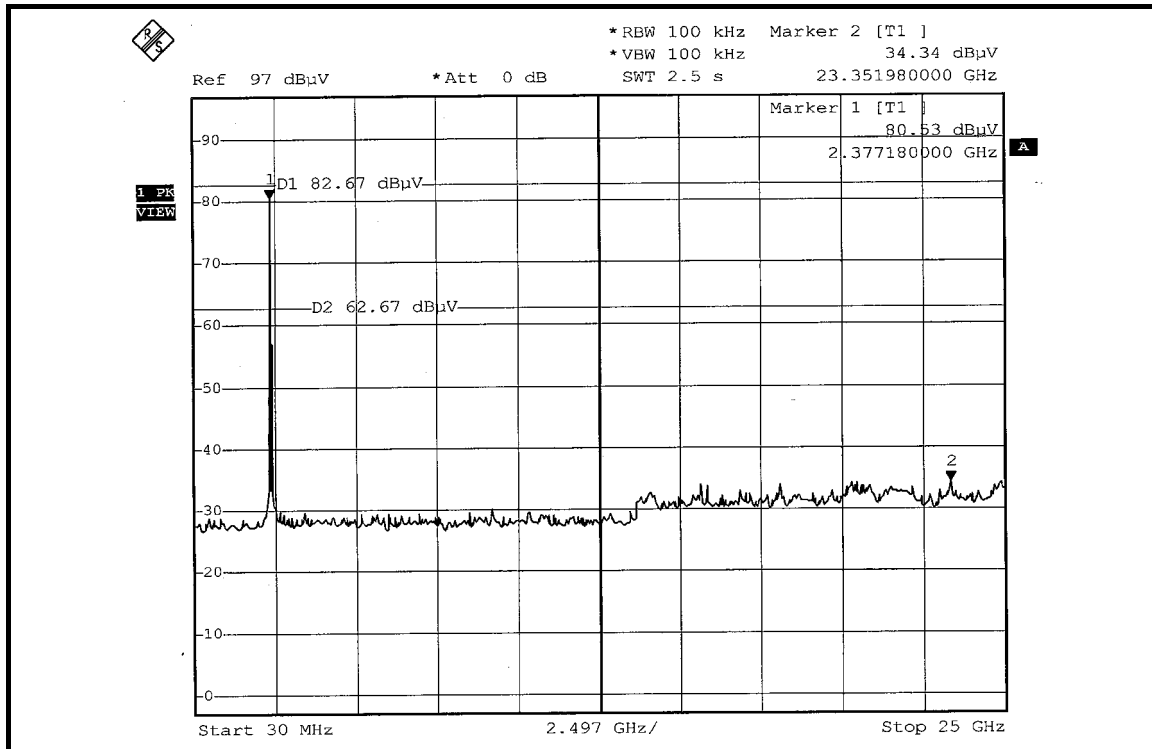

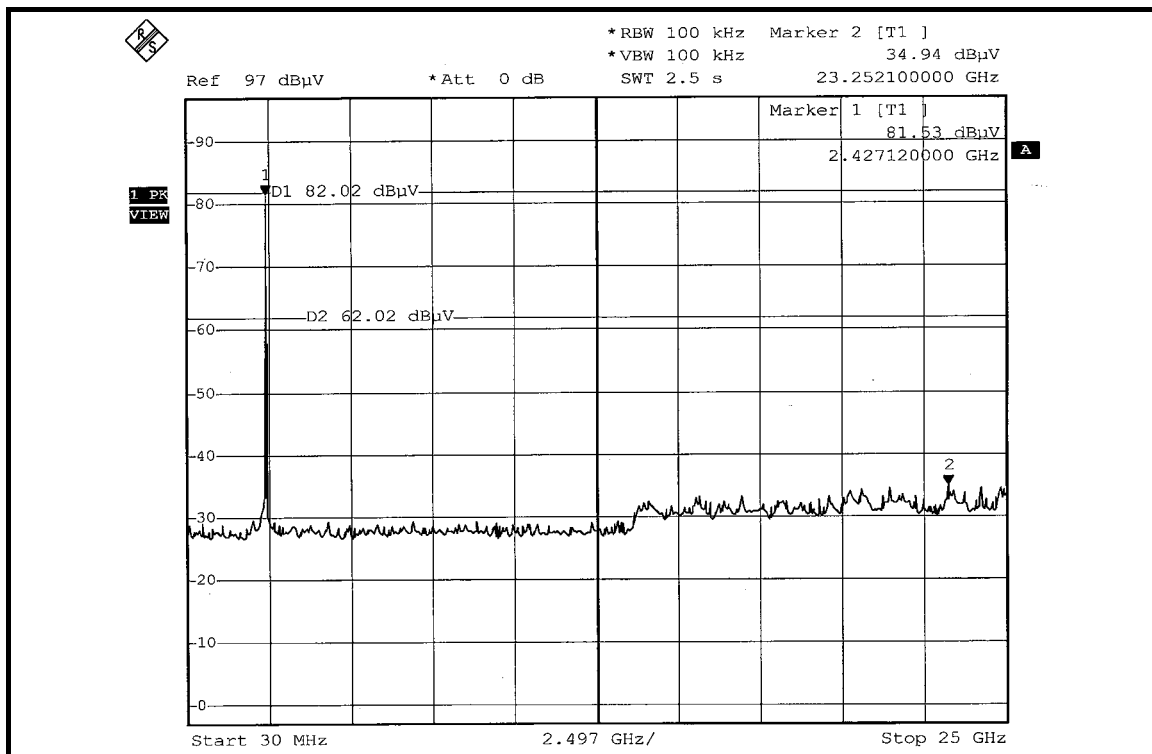
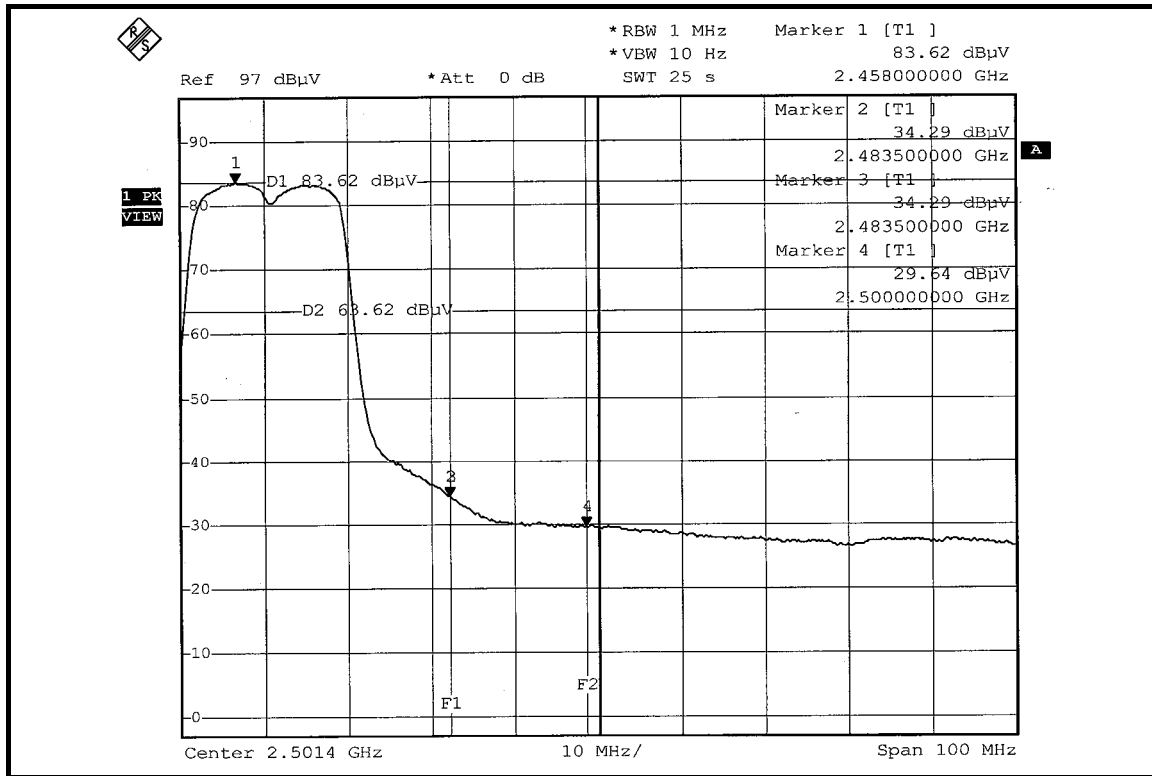





## **DRAFT 802.11n (40MHz) OFDM MODULATION: DUAL TX:**

### **NOTE 1:**

The band edge emission plot of OFDM technique on the next page shows 43.36dBc between carrier maximum power and local maximum emission in restrict band (2.3900GHz). The emission of carrier strength list in the test result of channel 1 at the item 4.2.7 is 106.65dBuV/m (Peak), so the maximum field strength in restrict band is  $106.65 - 43.36 = 63.29$ dBuV/m which is under 74dBuV/m limit.

The band edge emission plot of OFDM technique on the next page shows 44.90dBc between carrier maximum power and local maximum emission in restrict band (2.3900GHz). The emission of carrier strength list in the test result of channel 1 at the item 4.2.7 is 97.09dBuV/m (Average), so the maximum field strength in restrict band is  $97.09 - 44.90 = 52.19$ dBuV/m which is under 54dBuV/m limit.

### **NOTE 2:**

The band edge emission plot of OFDM technique on the next second page shows 42.72dBc between carrier maximum power and local maximum emission in restrict band (2.4835GHz). The emission of carrier strength list in the test result of channel 7 at the item 4.2.7 is 106.02dBuV/m (Peak), so the maximum field strength in restrict band is  $106.02 - 42.72 = 63.30$ dBuV/m which is under 74dBuV/m limit.

The band edge emission plot of OFDM technique on the next third page shows 43.86dBc between carrier maximum power and local maximum emission in restrict band (2.4860GHz). The emission of carrier strength list in the test result of channel 7 at the item 4.2.7 is 96.33dBuV/m (Average), so the maximum field strength in restrict band is  $96.33 - 43.86 = 52.47$ dBuV/m which is under 54dBuV/m limit.

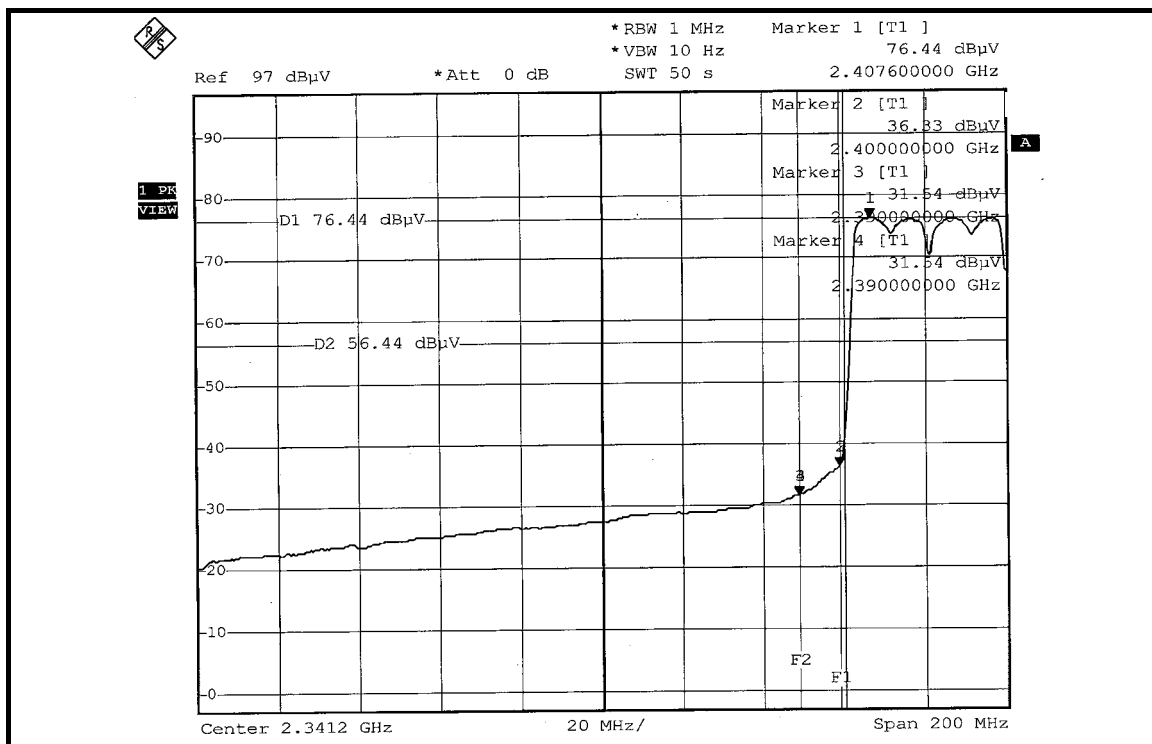
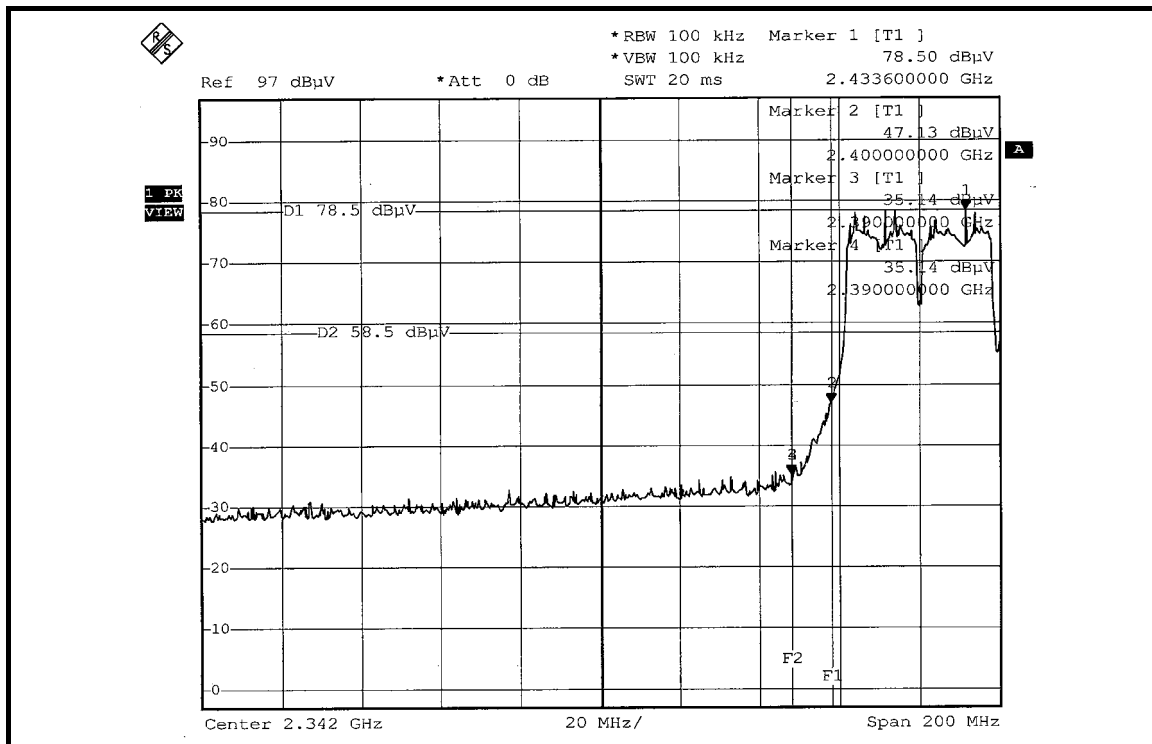

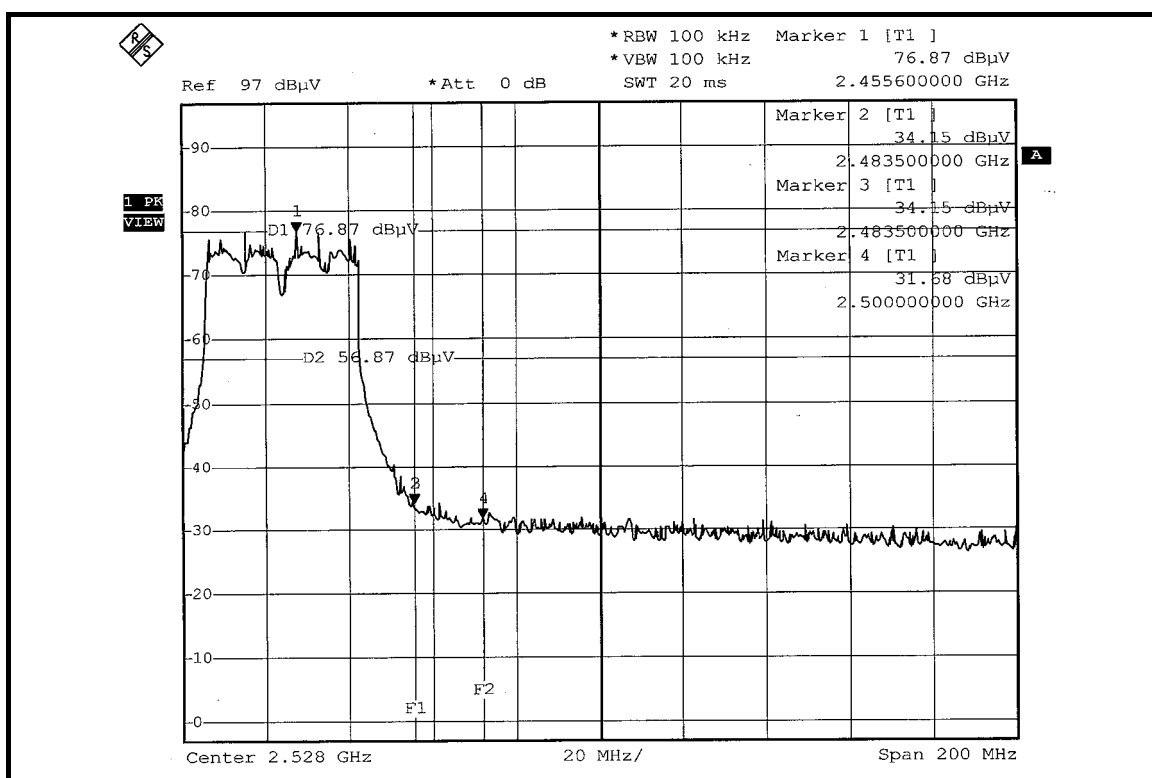
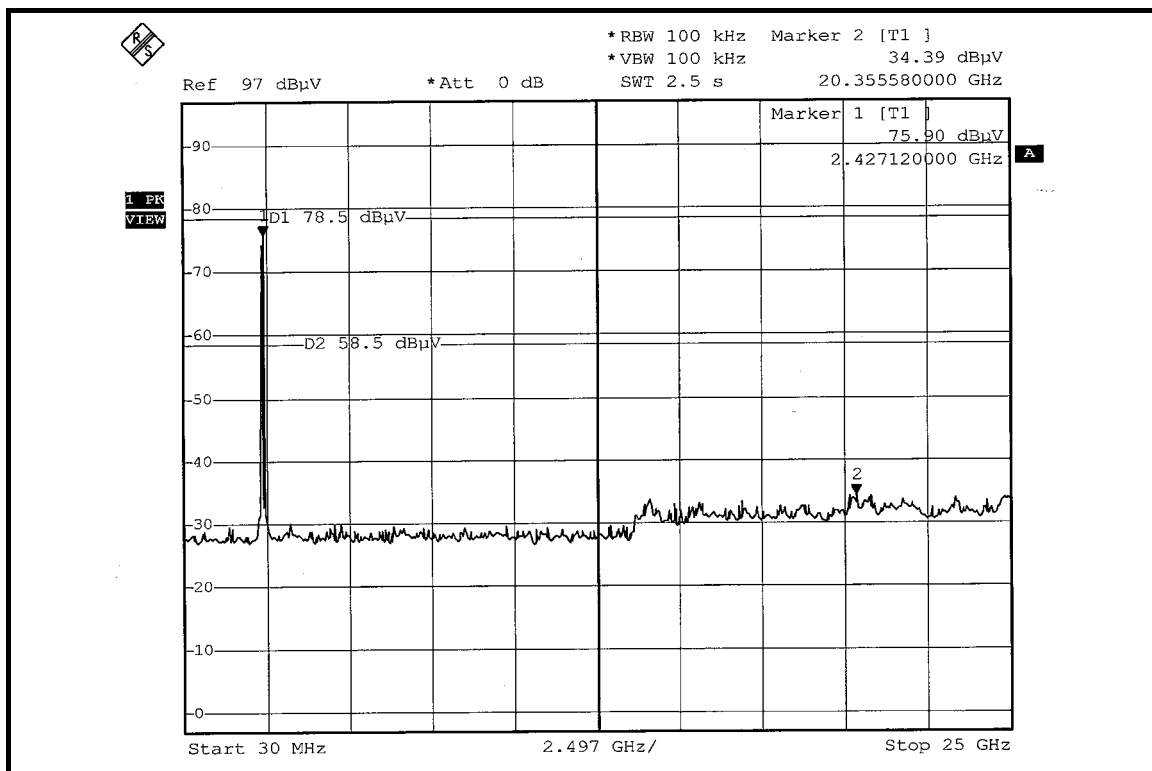

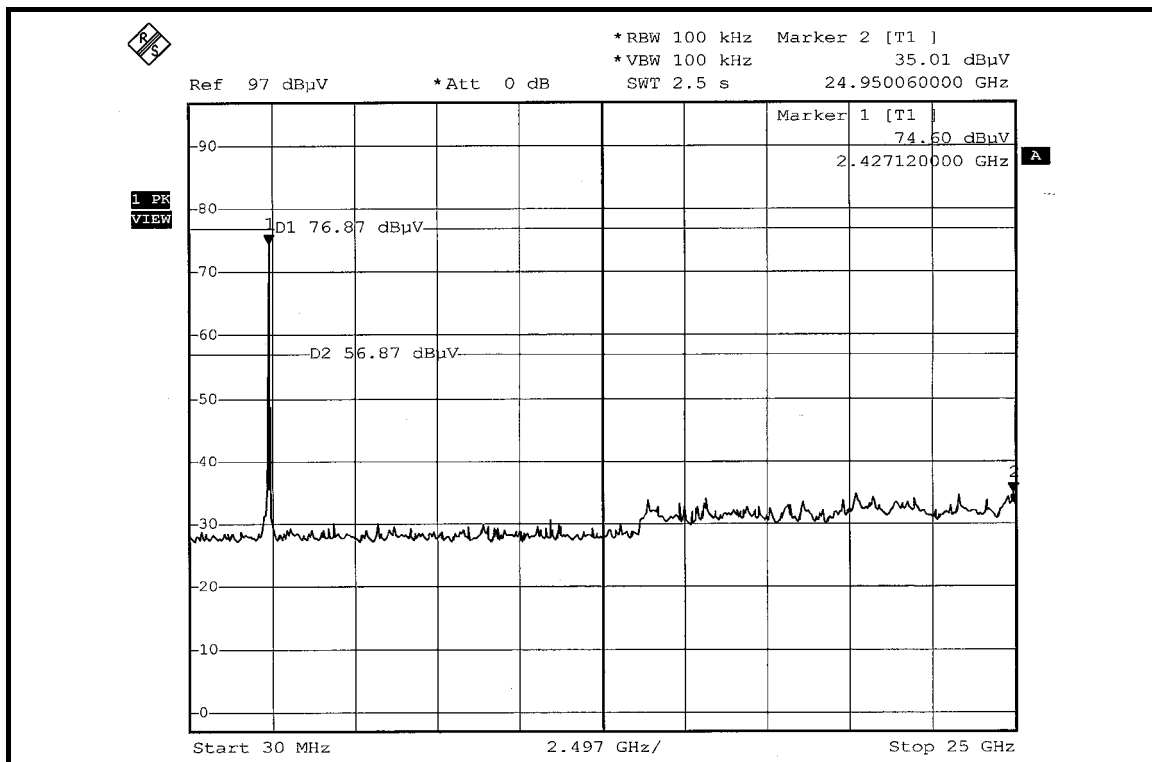
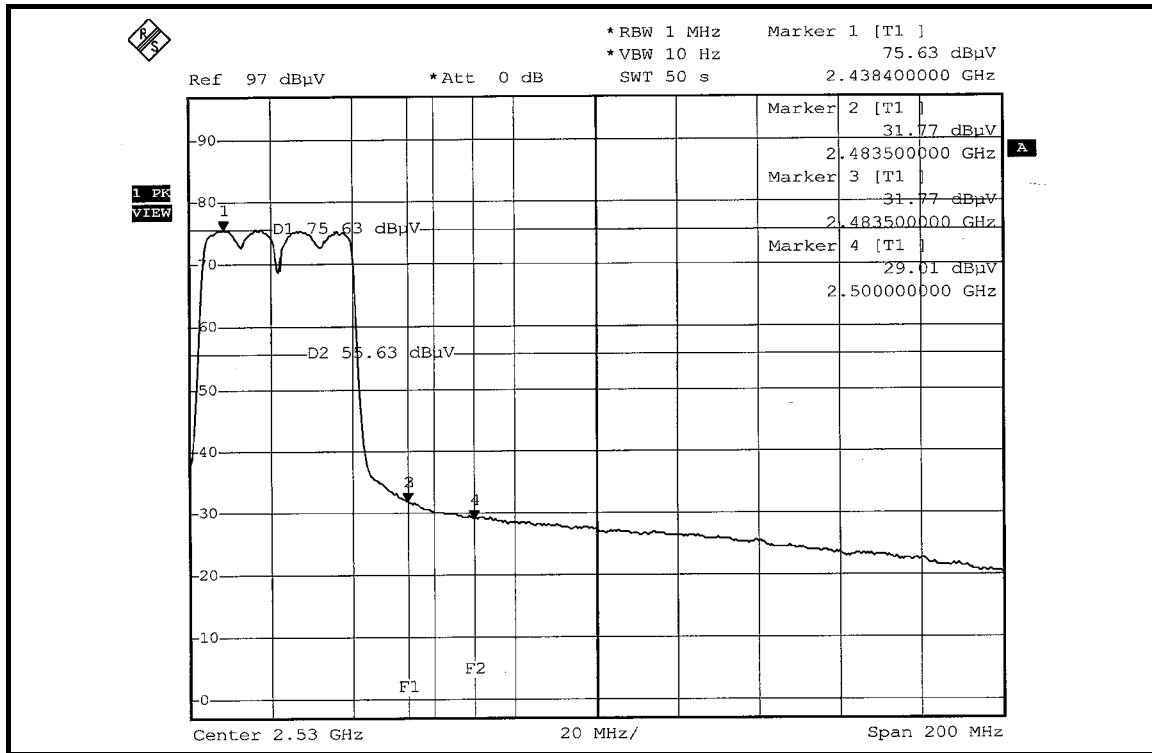



## **4.7 ANTENNA REQUIREMENT**

### **4.7.1 STANDARD APPLICABLE**

For intentional device, according to FCC 47 CFR Section 15.203, an intentional radiator shall be designed to ensure that no antenna other than that furnished by the responsible party shall be used with the device. And according to FCC 47 CFR Section 15.247 (b), if transmitting antennas of directional gain greater than 6dBi are used, the power shall be reduced by the amount in dB that the directional gain of the antenna exceeds 6dBi.

### **4.7.2 ANTENNA CONNECTED CONSTRUCTION**

The antenna used in this product is Dipole antenna with R-SMA connector. The maximum Gain of the antenna is 2.0dBi.



## 5. INFORMATION ON THE TESTING LABORATORIES

We, ADT Corp., were founded in 1988 to provide our best service in EMC, Radio, Telecom and Safety consultation. Our laboratories are accredited and approved by the following approval agencies according to ISO/IEC 17025.

<b>USA</b>	FCC, UL, A2LA
<b>Germany</b>	TUV Rheinland
<b>Japan</b>	VCCI
<b>Norway</b>	NEMKO
<b>Canada</b>	INDUSTRY CANADA , CSA
<b>R.O.C.</b>	CNLA, BSMI, DGT
<b>Netherlands</b>	Telefication
<b>Singapore</b>	PSB , GOST-ASIA(MOU)
<b>Russia</b>	CERTIS(MOU)

Copies of accreditation certificates of our laboratories obtained from approval agencies can be downloaded from our web site:

[www.adt.com.tw/index.5/phtml](http://www.adt.com.tw/index.5/phtml). If you have any comments, please feel free to contact us at the following:

**Linko EMC/RF Lab:**

Tel: 886-2-26052180

Fax: 886-2-26051924

**Hsin Chu EMC/RF Lab:**

Tel: 886-3-5935343

Fax: 886-3-5935342

**Hwa Ya EMC/RF/Safety Telecom Lab: Linko RF Lab.**

Tel: 886-3-3183232

Fax: 886-3-3185050

Tel: 886-3-3270910

Fax: 886-3-3270892

**Web Site:** [www.adt.com.tw](http://www.adt.com.tw)

The address and road map of all our labs can be found in our web site also.



## **APPENDIX-A**

### **MODIFICATIONS RECORDERS FOR ENGINEERING CHANGES TO THE EUT BY THE LAB**

No any modifications are made to the EUT by the lab during the test.