



A D T

DFS TEST REPORT

REPORT NO.: RF130614E11-2

MODEL NO.: DWA-171

FCC ID: KA2WA171B1

RECEIVED: June 14, 2013

TESTED: July 09, 2013

ISSUED: July 29, 2013

APPLICANT: D-Link Corporation

ADDRESS: No.289, Sinhu 3rd Rd., Neihu District, Taipei
City 114, Taiwan, R.O.C

ISSUED BY: Bureau Veritas Consumer Products Services
(H.K.) Ltd., Taoyuan Branch Hsin Chu Laboratory

LAB ADDRESS : No. 81-1, Lu Liao Keng, 9th Ling, Wu Lung Tsuen,
Chiung Lin Hsiang, Hsin Chu Hsien 307, Taiwan,
R.O.C.

This report should not be used by the client to claim product certification, approval, or endorsement by TAF or any government agencies.



This report is for your exclusive use. Any copying or replication of this report to or for any other person or entity, or use of our name or trademark, is permitted only with our prior written permission. This report sets forth our findings solely with respect to the test samples identified herein. The results set forth in this report are not indicative or representative of the quality or characteristics of the lot from which a test sample was taken or any similar or identical product unless specifically and expressly noted. Our report includes all of the tests requested by you and the results thereof based upon the information that you provided to us. You have 60 days from date of issuance of this report to notify us of any material error or omission caused by our negligence, provided, however, that such notice shall be in writing and shall specifically address the issue you wish to raise. A failure to raise such issue within the prescribed time shall constitute your unqualified acceptance of the completeness of this report, the tests conducted and the correctness of the report contents. Unless specific mention, the uncertainty of measurement has been explicitly taken into account to declare the compliance or non-compliance to the specification



A D T

Table of Contents

| | |
|--|----|
| RELEASE CONTROL RECORD | 3 |
| 1. CERTIFICATION | 4 |
| 2. EUT INFORMATION..... | 5 |
| 2.1 OPERATING FREQUENCY BANDS AND MODE OF EUT..... | 5 |
| 2.2 EUT SOFTWARE AND FIRMWARE VERSION | 5 |
| 2.3 DESCRIPTION OF AVAILABLE ANTENNAS TO THE EUT | 5 |
| 2.4 EUT MAXIMUM CONDUCTED POWER | 6 |
| 2.5 EUT MAXIMUM EIRP POWER..... | 7 |
| 2.6 TRANSMIT POWER CONTROL (TPC) | 8 |
| 2.7 STATEMENT OF MAUNFACTURER..... | 8 |
| 3. U-NII DFS RULE REQUIREMENTS | 9 |
| 3.1 WORKING MODES AND REQUIRED TEST ITEMS | 9 |
| 3.2 TEST LIMITS AND RADAR SIGNAL PARAMETERS | 10 |
| 4. TEST & SUPPORT EQUIPMENT LIST..... | 13 |
| 4.1 TEST INSTRUMENTS..... | 13 |
| 4.2 DESCRIPTION OF SUPPORT UNITS..... | 13 |
| 5. TEST PROCEDURE..... | 14 |
| 5.1 BVADT DFS MEASUREMENT SYSTEM:..... | 14 |
| 5.2 CALIBRATION OF DFS DETECTION THRESHOLD LEVEL:..... | 15 |
| 5.3 DEVIATION FROM TEST STANDARD..... | 16 |
| 5.4 CONDUCTED TEST SETUP CONFIGURATION..... | 16 |
| 5.4.1 CLIENT WITHOUT RADAR DETECTION MODE | 16 |
| 6. TEST RESULTS | 17 |
| 6.1 SUMMARY OF TEST RESULTS | 17 |
| 6.2 DETAILED TEST RESULTS | 18 |
| 6.2.1 TEST MODE: DEVICE OPERATING IN CLIENT WITHOUT RADAR DETECTION MODE..... | 18 |
| 6.2.1.1 DFS DETECTION THRESHOLD..... | 18 |
| 6.2.1.2 CHANNEL CLOSING TRANSMISSION AND CHANNEL MOVE TIME | 19 |
| 6.2.1.3 NON- OCCUPANCY PERIOD | 20 |
| 6.2.1.4 NON-ASSOCIATED TEST..... | 22 |
| 6.2.1.5 NON- CO-CHANNEL TEST | 22 |
| 7. INFORMATION ON THE TESTING LABORATORIES | 23 |
| 8. APPENDIX-A..... | 24 |
| 9. APPENDIX B - MODIFICATIONS RECORDERS FOR ENGINEERING CHANGES TO THE EUT BY THE LAB | 26 |



A D T

RELEASE CONTROL RECORD

| ISSUE NO. | REASON FOR CHANGE | DATE ISSUED |
|---------------|-------------------|---------------|
| RF130614E11-2 | Original release | July 29, 2013 |



A D T

1. CERTIFICATION

PRODUCT: Wireless AC Dual Band USB Adapter
BRAND NAME : D-Link
MODEL NO.: DWA-171
TEST SAMPLE: R&D SAMPLE
APPLICANT: D-Link Corporation
TESTED: July 09, 2013
STANDARDS: FCC Part 15, Subpart E (Section 15.407)
FCC 06-96

The above equipment (Model: DWA-171) has been tested by **Bureau Veritas Consumer Products Services (H.K.) Ltd., Taoyuan Branch**, and was in compliance with the requirement of the above standards. The test record, data evaluation & Equipment Under Test (EUT) configurations represented herein are true and accurate accounts of the measurements of the sample's EMC characteristics under the conditions specified in this report.

PREPARED BY : , **DATE:** July 29, 2013
(Midoli Peng, Specialist)

APPROVED BY : , **DATE:** July 29, 2013
(May Chen, Manager)



A D T

2. EUT INFORMATION

2.1 OPERATING FREQUENCY BANDS AND MODE OF EUT

TABLE 1: OPERATING FREQUENCY BANDS AND MODE OF EUT

| OPERATIONAL MODE | OPERATING FREQUENCY RANGE | |
|--|---------------------------|--|
| | 5250~5350MHz | 5470~5725MHz (Disable 5600 ~ 5650MHz) |
| Client without radar detection and ad hoc function | ü | ü |

2.2 EUT SOFTWARE AND FIRMWARE VERSION

TABLE 2: THE EUT SOFTWARE/FIRMWARE VERSION

| PLATFORM | NO. | PRODUCT | MODEL NO. | SOFTWARE/FIRMWARE VERSION |
|-----------|-----|-----------------------------------|-----------|-------------------------------------|
| Windows 7 | 1 | Wireless AC Dual Band USB Adapter | DWA-171 | Ralink 2013/06/5 (5.1.3.1015) |

2.3 DESCRIPTION OF AVAILABLE ANTENNAS TO THE EUT

TABLE 3: ANTENNA LIST

| Antenna Type | Connector | Antenna Gain (dB) | Frequency range (MHz to MHz) |
|--------------|-----------|-------------------|------------------------------|
| Loop | NA | 1.33 | 5250~5350 |
| Loop | NA | 1.97 | 5470~5725 |



A D T

2.4 EUT MAXIMUM CONDUCTED POWER

IEEE 802.11a

| ANT SET. | FREQUENCY BAND (MHz) | MAX. POWER | |
|----------|----------------------|-------------------|------------------|
| | | OUTPUT POWER(dBm) | OUTPUT POWER(mW) |
| 1 | 5250~5350 | 13.69 | 23.388 |
| 1 | 5470~5725 | 14.68 | 29.376 |

IEEE 802.11n HT20

| ANT SET. | FREQUENCY BAND (MHz) | MAX. POWER | |
|----------|----------------------|-------------------|------------------|
| | | OUTPUT POWER(dBm) | OUTPUT POWER(mW) |
| 1 | 5250~5350 | 11.68 | 14.723 |
| 1 | 5470~5725 | 14.53 | 28.379 |

IEEE 802.11n HT40

| ANT SET. | FREQUENCY BAND (MHz) | MAX. POWER | |
|----------|----------------------|-------------------|------------------|
| | | OUTPUT POWER(dBm) | OUTPUT POWER(mW) |
| 1 | 5250~5350 | 10.74 | 11.858 |
| 1 | 5470~5725 | 14.52 | 28.314 |



A D T

2.5 EUT MAXIMUM EIRP POWER

IEEE 802.11a

| ANT SET. | FREQUENCY BAND (MHz) | MAX. POWER | |
|----------|----------------------|-------------------|------------------|
| | | OUTPUT POWER(dBm) | OUTPUT POWER(mW) |
| 1 | 5250~5350 | 15.02 | 31.769 |
| 1 | 5470~5725 | 16.65 | 46.238 |

IEEE 802.11n HT20

| ANT SET. | FREQUENCY BAND (MHz) | MAX. POWER | |
|----------|----------------------|-------------------|------------------|
| | | OUTPUT POWER(dBm) | OUTPUT POWER(mW) |
| 1 | 5250~5350 | 13.01 | 19.999 |
| 1 | 5470~5725 | 16.5 | 44.668 |

IEEE 802.11n HT40

| ANT SET. | FREQUENCY BAND (MHz) | MAX. POWER | |
|----------|----------------------|-------------------|------------------|
| | | OUTPUT POWER(dBm) | OUTPUT POWER(mW) |
| 1 | 5250~5350 | 12.07 | 16.106 |
| 1 | 5470~5725 | 16.49 | 44.566 |



A D T

2.6 TRANSMIT POWER CONTROL (TPC)

U-NII devices operating in the 5.25-5.35 GHz band and the 5.47-5.725 GHz band shall employ a TPC mechanism. The U-NII device is required to have the capability to operate at least 6 dB below the mean EIRP value of 30 dBm. A TPC mechanism is not required for systems with an EIRP of less than 500 mW.

Maximum EIRP of this device is 46.238 mW which is less than 500mW, therefore it's not required to have TPC function.

2.7 STATEMENT OF MANUFACTURER

This device (Client) is without radar detection, then the manufacturer statement confirming that information regarding the parameters of the detected Radar Waveforms is not available to the end user. **And the device doesn't have Ad Hoc mode on DFS frequency band.**



3. U-NII DFS RULE REQUIREMENTS

3.1 WORKING MODES AND REQUIRED TEST ITEMS

The manufacturer shall state whether the UUT is capable of operating as a Master and/or a Client. If the UUT is capable of operating in more than one operating mode then each operating mode shall be tested separately. See tables 1 and 2 for the applicability of DFS requirements for each of the operational modes.

TABLE 6: APPLICABILITY OF DFS REQUIREMENTS PRIOR TO USE A CHANNEL

| REQUIREMENT | OPERATIONAL MODE | | |
|---------------------------------|------------------|--------------------------------|-----------------------------|
| | MASTER | CLIENT WITHOUT RADAR DETECTION | CLIENT WITH RADAR DETECTION |
| Non-Occupancy Period | ü | ü | ü |
| DFS Detection Threshold | ü | Not required | ü |
| Channel Availability Check Time | ü | Not required | Not required |
| Uniform Spreading | ü | Not required | Not required |
| U-NII Detection Bandwidth | ü | Not required | ü |

TABLE 7: APPLICABILITY OF DFS REQUIREMENTS DURING NORMAL OPERATION

| REQUIREMENT | OPERATIONAL MODE | | |
|-----------------------------------|------------------|--------------------------------|-----------------------------|
| | MASTER | CLIENT WITHOUT RADAR DETECTION | CLIENT WITH RADAR DETECTION |
| DFS Detection Threshold | ü | Not required | ü |
| Channel Closing Transmission Time | ü | ü | ü |
| Channel Move Time | ü | ü | ü |
| U-NII Detection Bandwidth | ü | Not required | ü |



A D T

3.2 TEST LIMITS AND RADAR SIGNAL PARAMETERS

DETECTION THRESHOLD VALUES

TABLE 8: DFS DETECTION THRESHOLDS FOR MASTER DEVICES AND CLIENT DEVICES WITH RADAR DETECTION

| MAXIMUM TRANSMIT POWER | VALUE (SEE Note 1 and 2) |
|------------------------|--------------------------|
| ≥ 200 milliwatt | -64 dBm |
| < 200 milliwatt | -62 dBm |

Note 1: This is the level at the input of the receiver assuming a 0 dBi receive antenna.

Note 2: Throughout these test procedures an additional 1 dB has been added to the amplitude of the test transmission waveforms to account for variations in measurement equipment. This will ensure that the test signal is at or above the detection threshold level to trigger a DFS response.



A D T

TABLE 9: DFS RESPONSE REQUIREMENT VALUES

| PARAMETER | VALUE |
|---|---|
| Non-occupancy period | Minimum 30 minutes |
| Channel Availability Check Time | 60 seconds |
| Channel Move Time | 10 seconds See Note 1. |
| Channel Closing Transmission Time | 200 milliseconds + an aggregate of 60 milliseconds over remaining 10 second period. See Notes 1 and 2. |
| U-NII Detection Bandwidth | Minimum 80% of the UNII 99% transmission power bandwidth. See Note 3. |
| <p>Note 1: The instant that the Channel Move Time and the Channel Closing Transmission Time begins is as follows:</p> <ul style="list-style-type: none">• For the Short Pulse Radar Test Signals this instant is the end of the Burst.• For the Frequency Hopping radar Test Signal, this instant is the end of the last radar Burst generated.• For the Long Pulse Radar Test Signal this instant is the end of the 12 second period defining the Radar Waveform. <p>Note 2: The Channel Closing Transmission Time is comprised of 200 milliseconds starting at the beginning of the Channel Move Time plus any additional intermittent control signals required to facilitate a Channel move (an aggregate of 60 milliseconds) during the remainder of the 10 second period. The aggregate duration of control signals will not count quiet periods in between transmissions.</p> <p>Note 3: During the U-NII Detection Bandwidth detection test, radar type 1 is used and for each frequency step the minimum percentage of detection is 90 percent. Measurements are performed with no data traffic.</p> | |



PARAMETERS OF DFS TEST SIGNALS

Step intervals of 0.1 microsecond for Pulse Width, 1 microsecond for PRI, 1 MHz for chirp width and 1 for the number of pulses will be utilized for the random determination of specific test waveforms.

TABLE 10: SHORT PULSE RADAR TEST WAVEFORMS

| RADAR TYPE | PULSE WIDTH (μsec) | PRI (μsec) | NUMBER OF PULSES | MINIMUM PERCENTAGE OF SUCCESSFUL DETECTION | MINIMUM NUMBER OF TRIALS |
|-----------------------------|--------------------|------------|------------------|--|--------------------------|
| 1 | 1 | 1428 | 18 | 60% | 30 |
| 2 | 1-5 | 150-230 | 23-29 | 60% | 30 |
| 3 | 6-10 | 200-500 | 16-18 | 60% | 30 |
| 4 | 11-20 | 200-500 | 12-16 | 60% | 30 |
| Aggregate (Radar Types 1-4) | | | | 80% | 120 |

TABLE 11: LONG PULSE RADAR TEST WAVEFORM

| RADAR TYPE | PULSE WIDTH (μsec) | CHIRP WIDTH (MHz) | PRI (μsec) | NUMBER OF PULSES PER BURST | NUMBER OF BURSTS | MINIMUM PERCENTAGE OF SUCCESSFUL DETECTION | MINIMUM NUMBER OF TRIALS |
|------------|--------------------|-------------------|------------|----------------------------|------------------|--|--------------------------|
| 5 | 50-100 | 5-20 | 1000-2000 | 1-3 | 8-20 | 80% | 30 |

TABLE 12: FREQUENCY HOPPING RADAR TEST WAVEFORM

| RADAR TYPE | PULSE WIDTH (μsec) | PRI (μsec) | PULSES PER HOP | HOPPING RATE (kHz) | HOPPING SEQUENCE LENGTH (msec) | MINIMUM PERCENTAGE OF SUCCESSFUL DETECTION | MINIMUM NUMBER OF TRIALS |
|------------|--------------------|------------|----------------|--------------------|--------------------------------|--|--------------------------|
| 6 | 1 | 333 | 9 | 0.333 | 300 | 70% | 30 |



A D T

4. TEST & SUPPORT EQUIPMENT LIST

4.1 TEST INSTRUMENTS

TABLE 1: TEST INSTRUMENTS LIST.

| DESCRIPTION & MANUFACTURER | MODEL NO. | BRAND | CALIBRATED DATE | CALIBRATED UNTIL |
|----------------------------|-----------|---------|-----------------|------------------|
| R&S Spectrum analyzer | FSP40 | R&S | Jan. 21, 2013 | Jan. 20, 2014 |
| Signal generator | 8645A | Agilent | Aug. 24, 2012 | Aug. 23, 2013 |

4.2 DESCRIPTION OF SUPPORT UNITS

TABLE 2: SUPPORT UNIT INFORMATION.

| NO. | PRODUCT | BRAND | MODEL NO. | ID | SPEC. |
|-----|------------------|----------|-----------|------------|--|
| 1 | 11n Access-Point | MOTOROLA | AP-7131N | UZ7AP7131N | The maximum EIRP is 13.6 dBm, Antenna Gain is -3.38dBi |

NOTE: This device was functioned as a Master Slave device during the DFS test.

TABLE 3: SOFTWARE/FIRMWARE INFORMATION.

| NO. | PRODUCT | MODEL NO. | SOFTWARE/FIRMWARE VERSION |
|-----|------------------|-----------|---------------------------|
| 1. | 11n Access-Point | AP-7131N | 4.0.0.0-036D |

5. TEST PROCEDURE

5.1 BVADT DFS MEASUREMENT SYSTEM:

A complete BVADT DFS Measurement System consists of two subsystems: (1) the Radar Signal Generating Subsystem and (2) the Traffic Monitoring Subsystem. The control PC is necessary for generating the Radar waveforms in Table 6, 7 and 8. The traffic monitoring subsystem is specified to the type of unit under test (UUT).

CONDUCTED SETUP CONFIGURATION OF ADT DFS MEASUREMENT SYSTEM

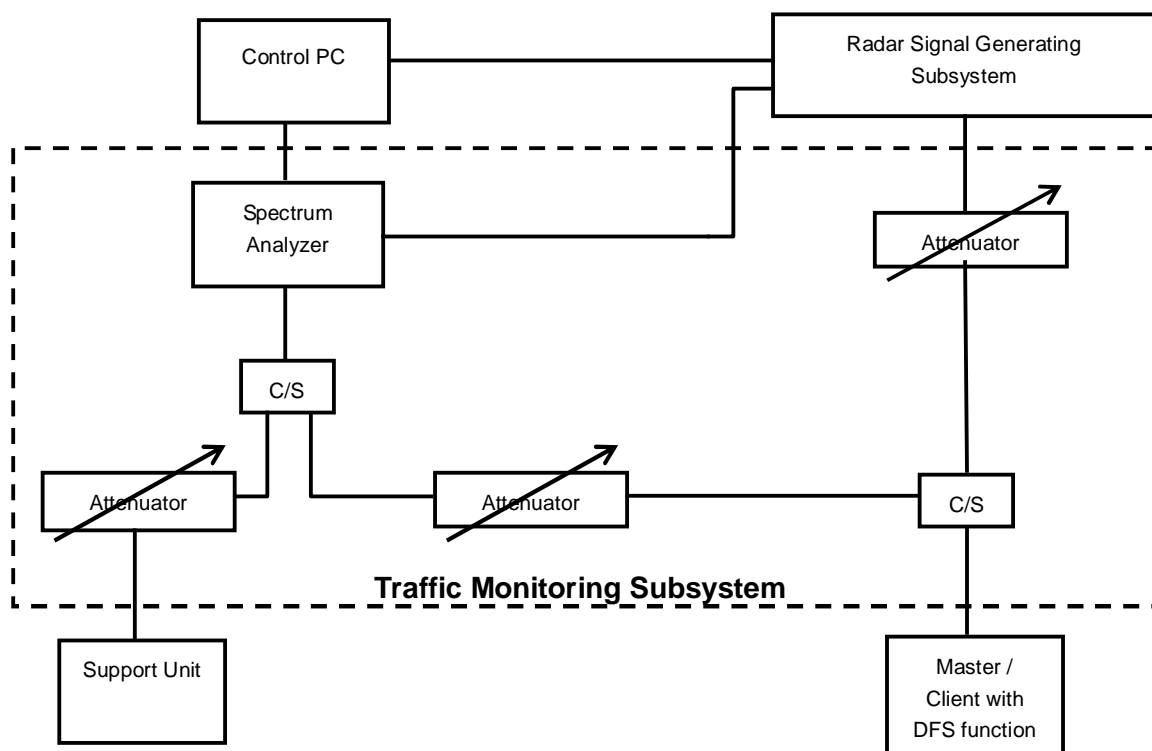

The test transmission will always be from the Master Device to the Client Device. While the Client device is set up to associate with the Master device and play the MPEG file (6 y Magic Hours) from Master device, the designated MPEG test file and instructions are located at:

<http://ntiacsd.ntia.doc.gov/dfs/>.

5.2 CALIBRATION OF DFS DETECTION THRESHOLD LEVEL:

The measured channel is 5500 MHz in 20MHz Bandwidth and 5510MHz in 40MHz Bandwidth. The radar signal was the same as transmitted channels, and injected into the antenna port of AP (master) or Client Device with Radar Detection, measured the channel closing transmission time and channel move time. The Master antenna gain is -3.38dBi and required detection threshold is -64.38dBm (= -62 +1 -3.38)dBm. The calibrated conducted detection threshold level is set to -64.38 dBm.

CONDUCTED SETUP CONFIGURATION OF CALIBRATION OF DFS DETECTION THRESHOLD LEVEL

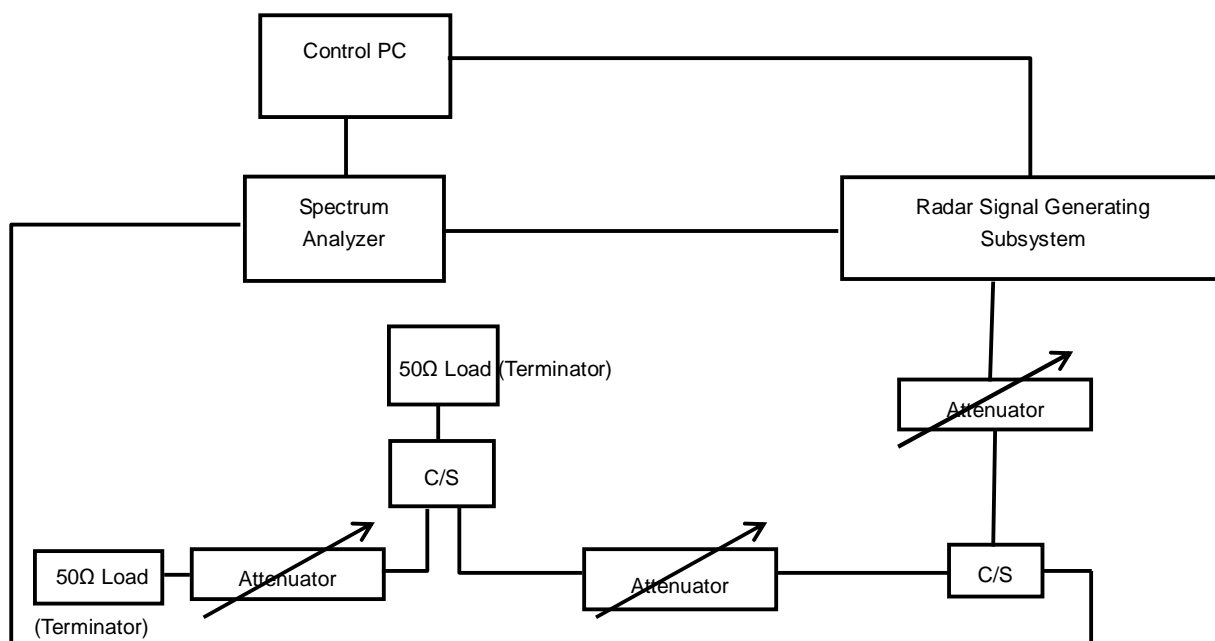

5.3 DEVIATION FROM TEST STANDARD

No deviation.

5.4 CONDUCTED TEST SETUP CONFIGURATION

5.4.1 CLIENT WITHOUT RADAR DETECTION MODE

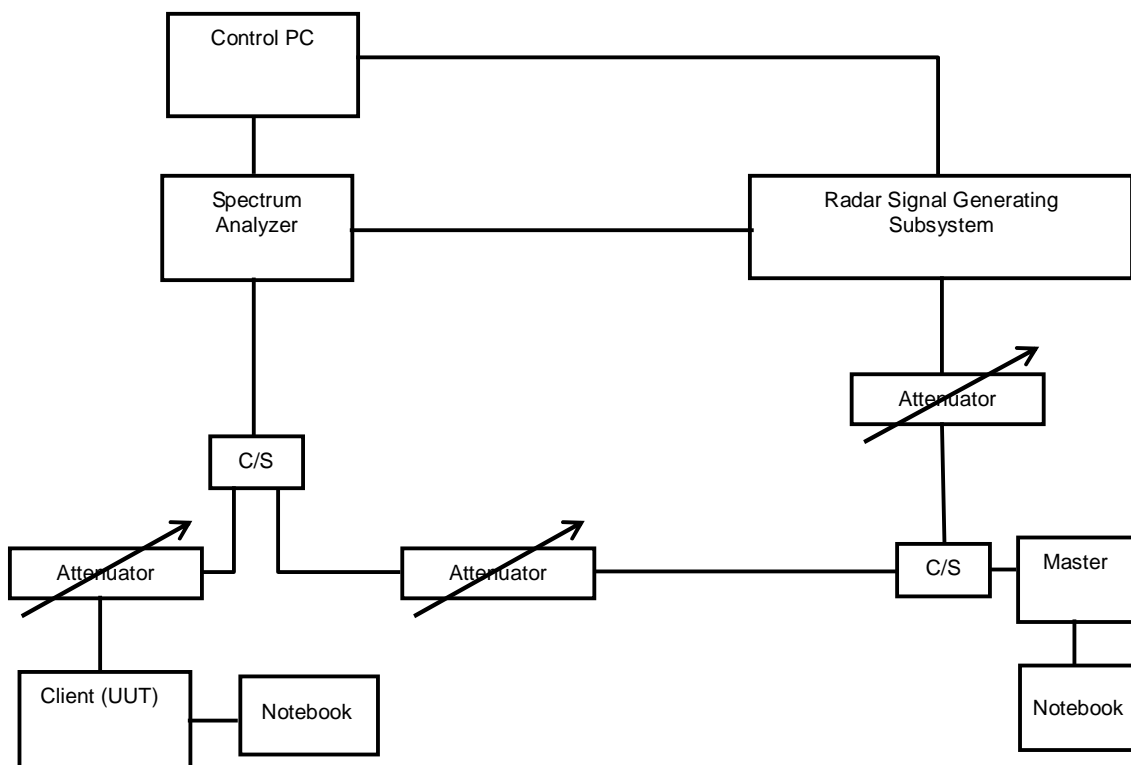

The UUT is a U-NII Device operating in Client mode without radar detection. The radar test signals are injected into the Master Device.



A D T

6. TEST RESULTS

6.1 SUMMARY OF TEST RESULTS

| CLAUSE | TEST PARAMETER | REMARKS | PASS/FAIL |
|--------|-----------------------------------|----------------|-----------|
| 15.407 | DFS Detection Threshold | Not Applicable | NA |
| 15.407 | Channel Availability Check Time | Not Applicable | NA |
| 15.407 | Channel Move Time | Applicable | Pass |
| 15.407 | Channel Closing Transmission Time | Applicable | Pass |
| 15.407 | Non- Occupancy Period | Applicable | Pass |
| 15.407 | Uniform Spreading | Not Applicable | NA |
| 15.407 | U-NII Detection Bandwidth | Not Applicable | NA |
| 15.407 | Non-associated test | Applicable | Pass |
| 15.407 | Non-Co-Channel test | Applicable | Pass |

6.2 DETAILED TEST RESULTS

6.2.1 TEST MODE: DEVICE OPERATING IN CLIENT WITHOUT RADAR DETECTION MODE.

The radar test signals are injected into the Master Device.

This test was investigated for different bandwidth (20MHz and 40MHz, except the 80MHz bandwidth, because master is not available.). The following plots was done on 40MHz as a representative

6.2.1.1 DFS DETECTION THRESHOLD

The Required detection threshold is -64.38dBm ($= -62 + 1 - 3.38$)dBm. The conducted radar burst level is set to -64.38dBm .

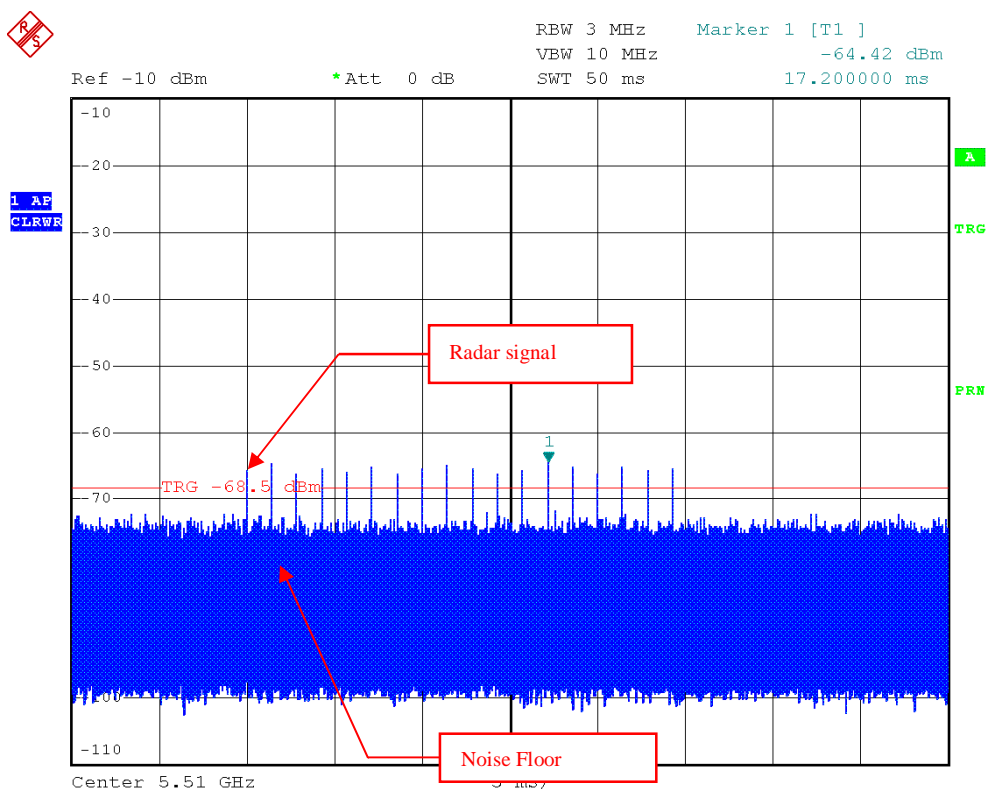

Radar Signal 1

6.2.1.2 CHANNEL CLOSING TRANSMISSION AND CHANNEL MOVE TIME

Channel Closing Transmission Time & Channel Move Time @ CH 102 5510MHz

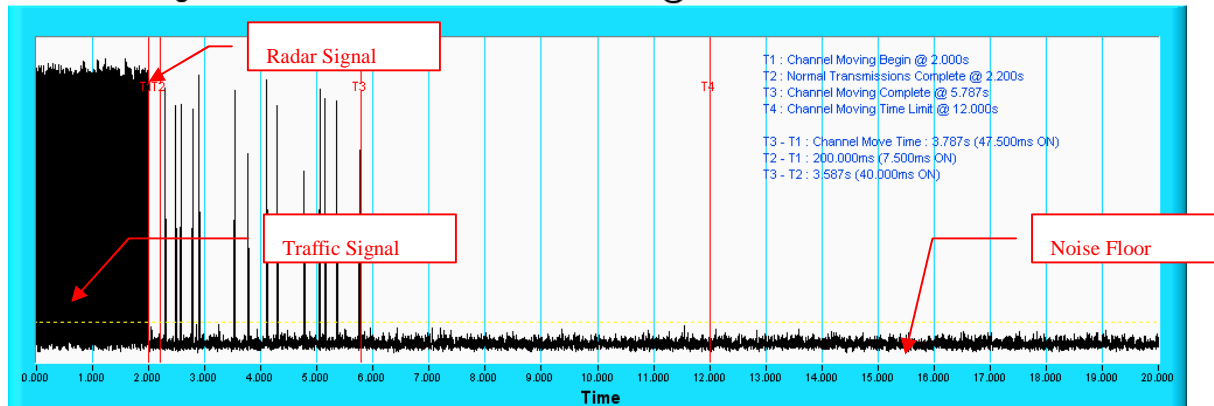

NOTE: T1 denotes the start of Channel Move Time upon the end of the last Radar burst. T2 denotes the data transmission time of 200ms from T1. T4 denotes the 10 second from T1 to observe the aggregate duration of transmissions.

Channel Closing Transmission Time & Channel Move Time @ CH 102 5510MHz

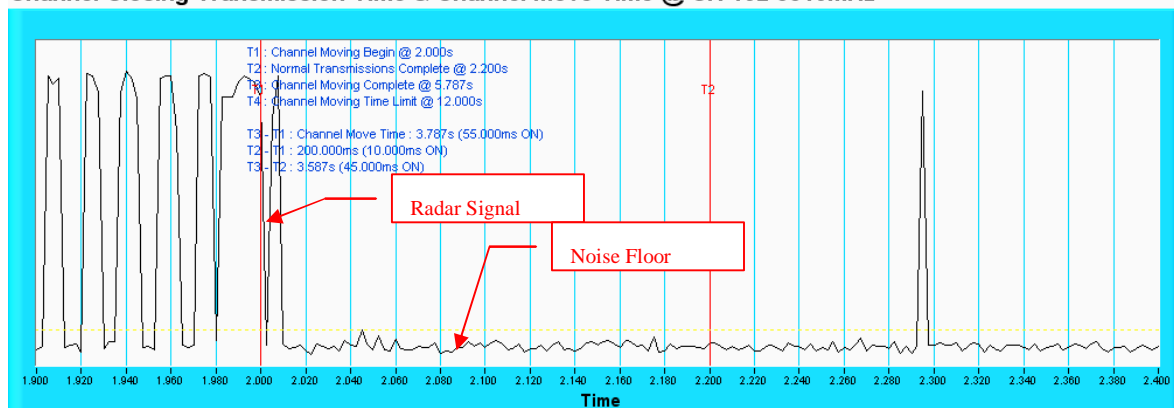

NOTE: An expanded plot for the device vacates the channel in the required 500ms.



A D T

6.2.1.3 NON- OCCUPANCY PERIOD

ASSOCIATED TEST

1) Test results demonstrating an associated client link is established with the master on a test frequency.

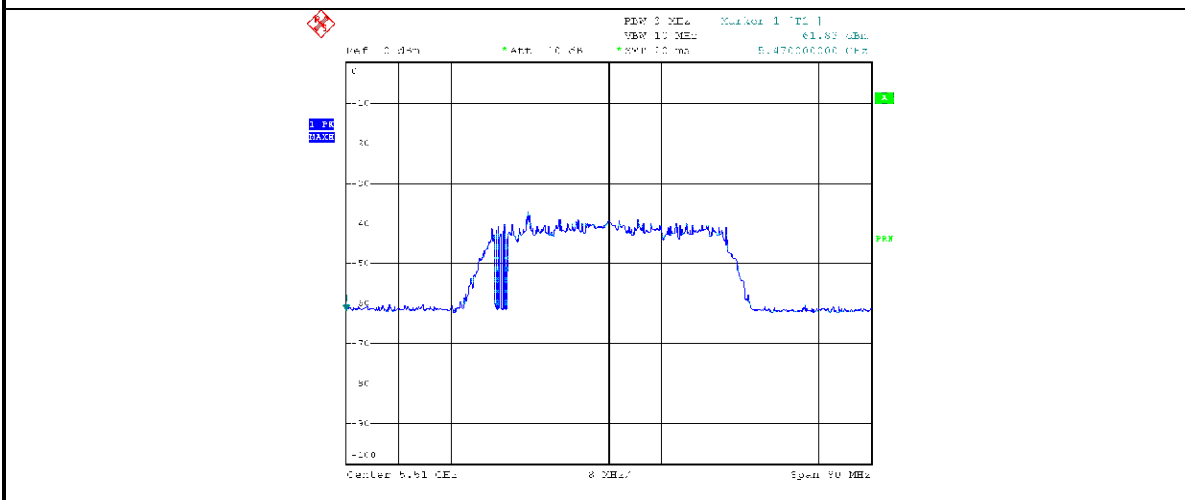

EUT (Client) links with master on 5510MHz

2) The client and DFS-certified master device are associated, and the movie can be streamed as specified in the DFS Order for a non-occupancy period test.

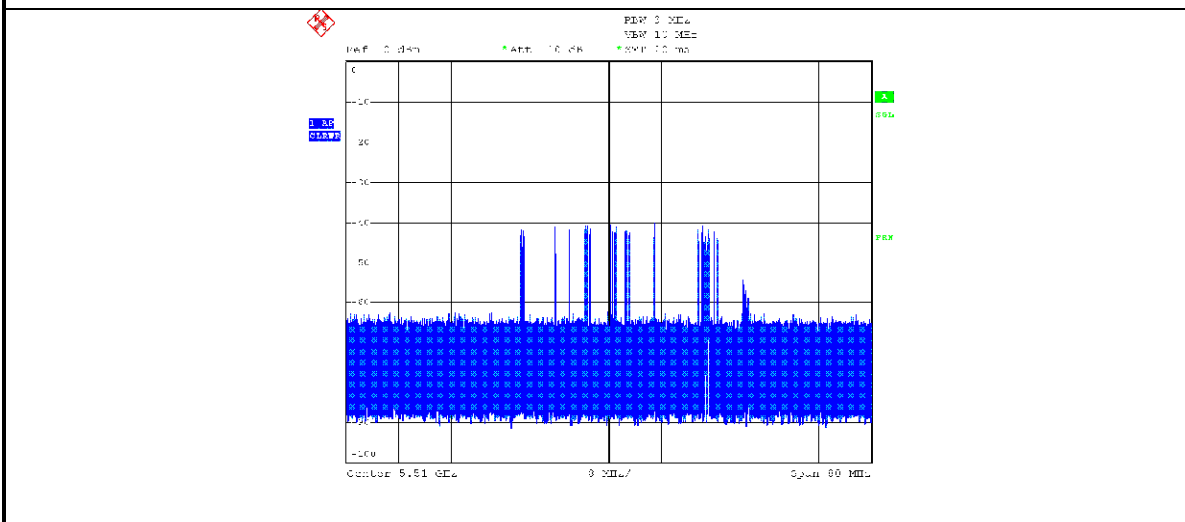

Client plays a specified files via master.

3). The device transmits one type of radar as specified in the DFS Order.

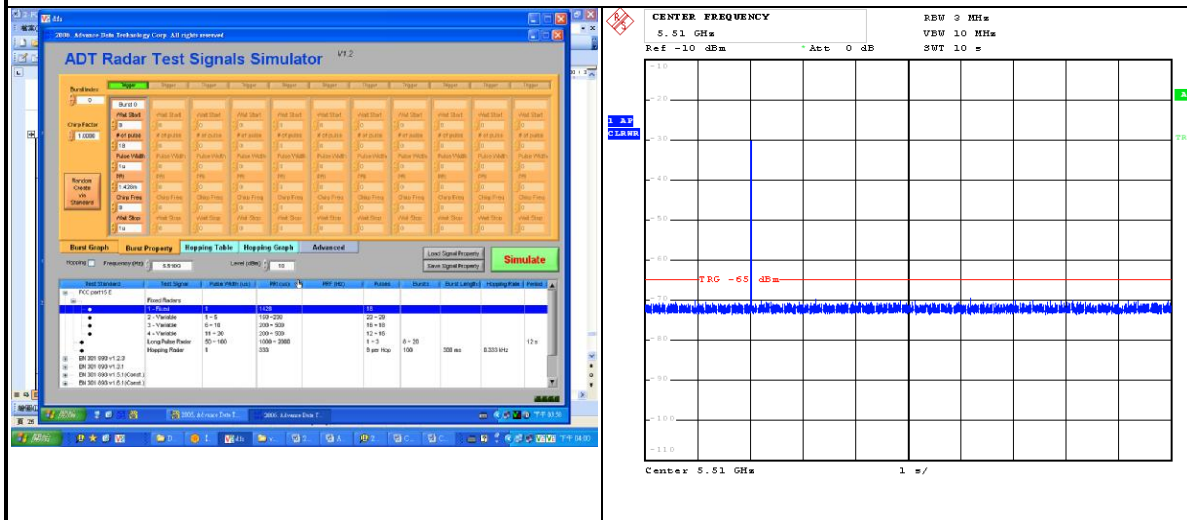

Radar 1 is used to test during DFS testing.

4) The test frequency has been monitored to ensure no transmission of any type has occurred for 30 minutes;

Note: If the client moves with the master, the device is considered compliant if nothing appears in the client non-occupancy period test. For devices that shut down (rather than moving channels), no beacons should appear;

5) An analyzer plot that contains a single 30-minute sweep on the original test frequency.

Non - Occupancy Period @ CH102 - 5510MHz

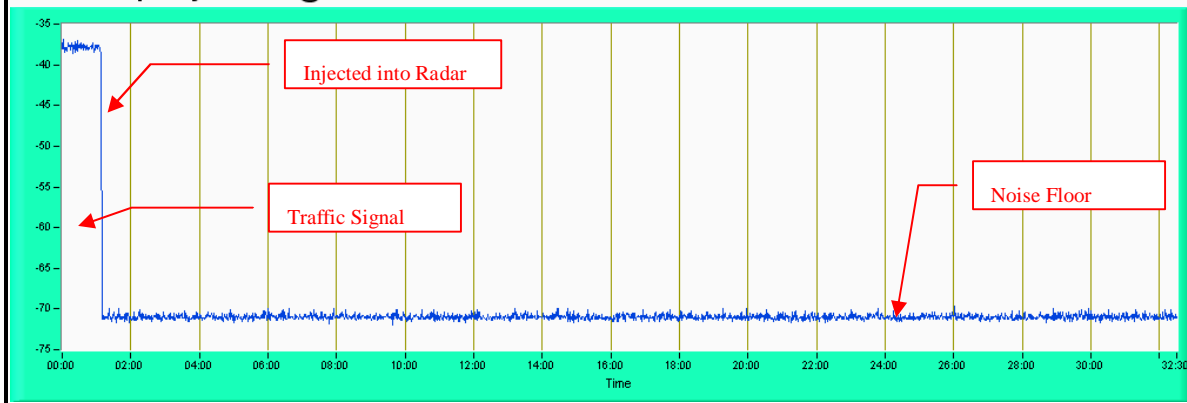

6.2.1.4 NON-ASSOCIATED TEST

Master was off.

During the 30 minutes observation time, The UUT did not make any transmissions in the DFS band after UUT power up.

Non - Associated Test @ CH102 - 5510MHz

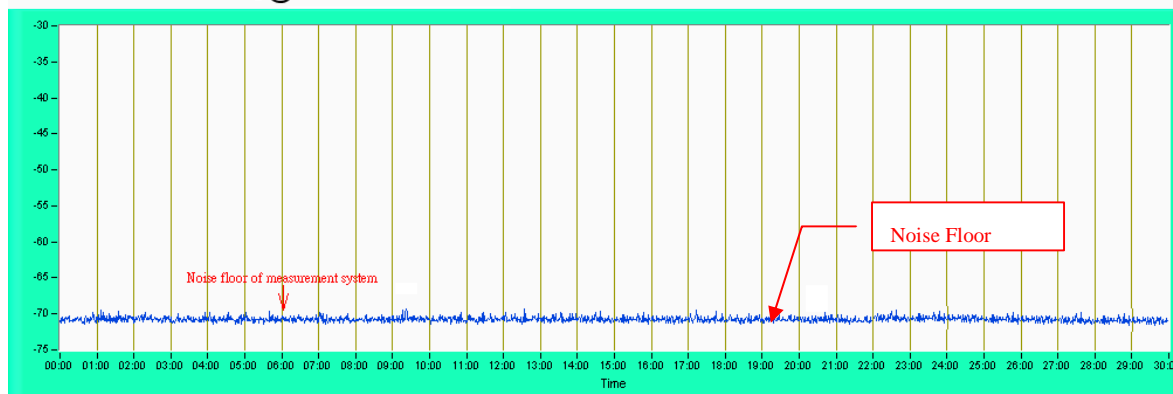

6.2.1.5 NON- CO-CHANNEL TEST

The UUT was investigated after radar was detected the channel and made sure no co-channel operation with radars.



A D T

7. INFORMATION ON THE TESTING LABORATORIES

We, Bureau Veritas Consumer Products Services (H.K.) Ltd., Taoyuan Branch, were founded in 1988 to provide our best service in EMC, Radio, Telecom and Safety consultation. Our laboratories are accredited and approved according to ISO/IEC 17025.

If you have any comments, please feel free to contact us at the following:

Linko EMC/RF Lab:

Tel: 886-2-26052180

Fax: 886-2-26052943

Hsin Chu EMC/RF Lab:

Tel: 886-3-5935343

Fax: 886-3-5935342

Hwa Ya EMC/RF/Safety/Telecom Lab:

Tel: 886-3-3183232

Fax: 886-3-3270892

Email: service.adt@tw.bureauveritas.com

Web Site: www.bureauveritas-adt.com

The address and road map of all our labs can be found in our web site also.



A D T

8. APPENDIX-A

Notch band in 5600-5650MHz

Verify that the 5600 - 5650 MHz band is notched.
Test results demonstrating last channel shall not exceed the band edge on 5600~5650MHz.

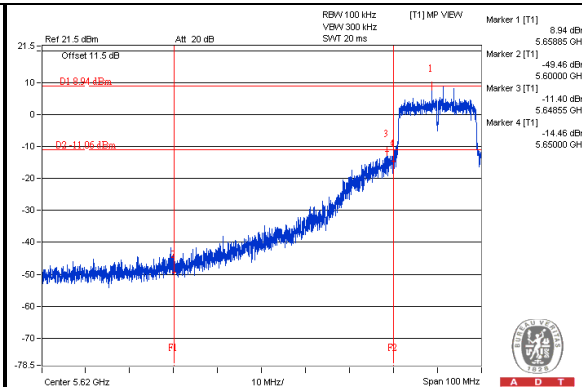
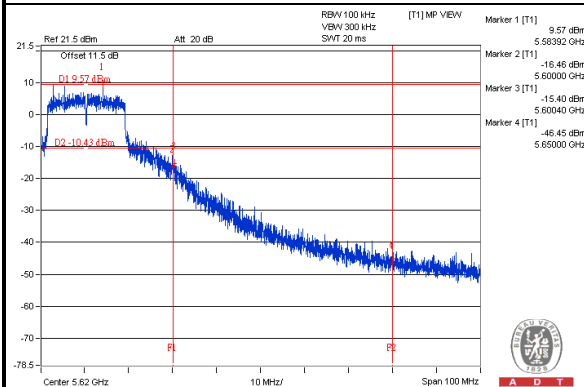

802.11n (20MHz) OFDM MODULATION (CH 116: 5580MHz)

802.11n (20MHz) OFDM MODULATION (CH 132: 5660MHz)

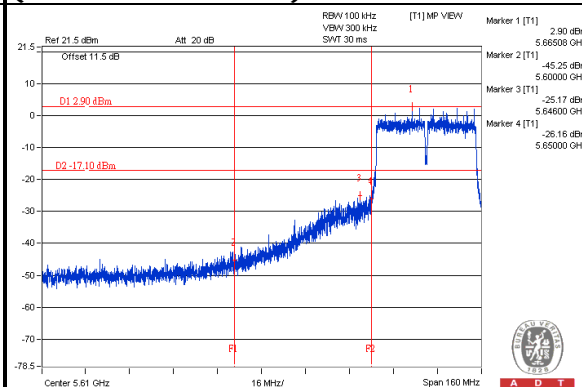
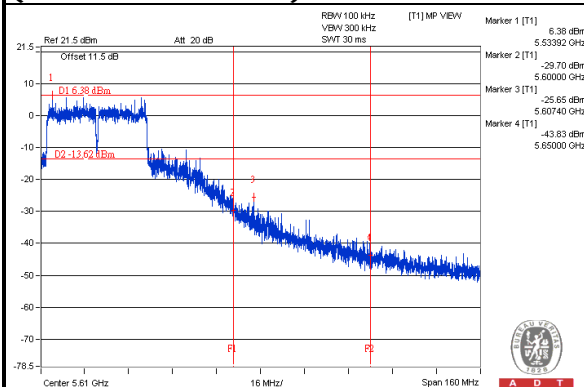

802.11n (40MHz) OFDM MODULATION (CH 110: 5550MHz)

802.11n (40MHz) OFDM MODULATION (CH 134: 5670MHz)

NON BEACON ON DFS BAND

- 1) Test results demonstrating no any beacon on DFS band after power up.
- 2) Observation time is 10min after power up.

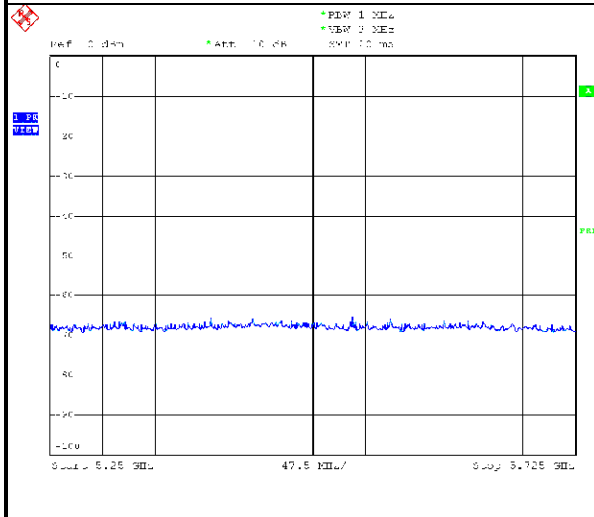

EUT (Client) links with master on 11n HT20 mode

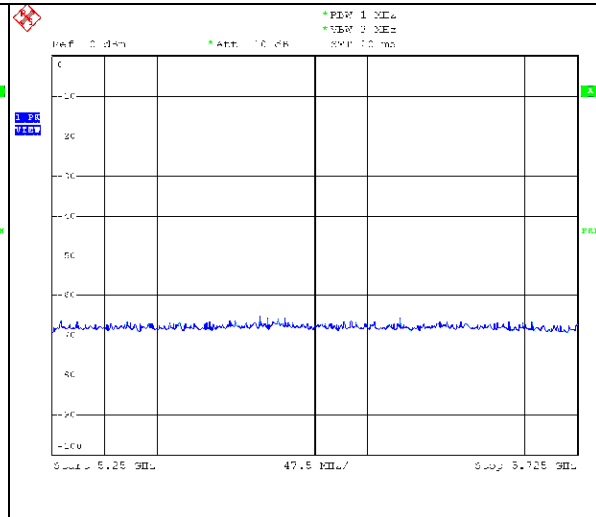

EUT (Client) links with master on 11n HT40 mode

BAND EDGE AT NEARBY DFS BAND

- 1) Test results demonstrating last channel (20dB BW) shall not exceed the band edge on 5150~5250MHz.

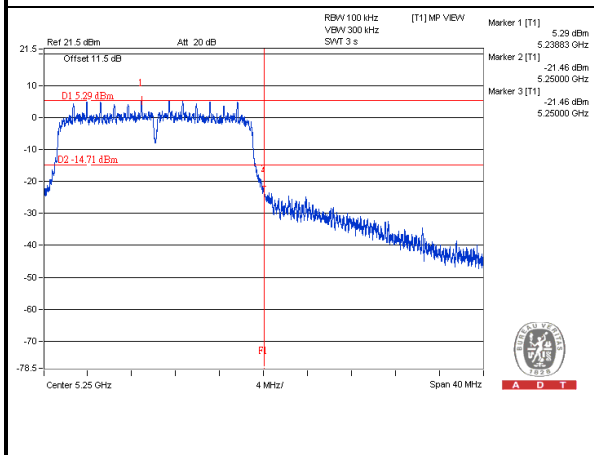

EUT (Client) links with master on 11n HT20 mode

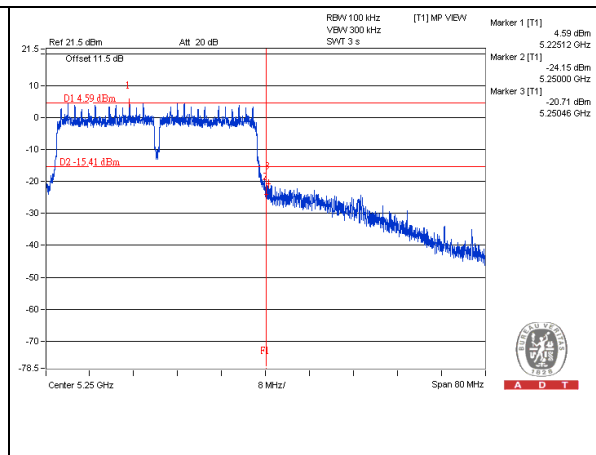

EUT (Client) links with master on 11n HT40 mode



A D T

9. APPENDIX B - MODIFICATIONS RECORDERS FOR ENGINEERING CHANGES TO THE EUT BY THE LAB

No modifications were made to the EUT by the lab during the test.

--- END ---