



A D T

# FCC TEST REPORT (15.247)

**REPORT NO.:** RF110913E01

**MODEL NO.:** DWA-160

**FCC ID:** KA2WA160B2

**RECEIVED:** Sep. 13, 2011

**TESTED:** Sep. 15 to Oct. 19, 2011

**ISSUED:** Dec. 07, 2011

**APPLICANT:** D-Link Corporation

**ADDRESS:** No.289, Sinhu 3rd Rd., Neihu District, Taipei  
City 114, Taiwan, R.O.C.

**ISSUED BY:** Bureau Veritas Consumer Products Services  
(H.K.) Ltd., Taoyuan Branch Hsin Chu Laboratory

**LAB ADDRESS :** No. 81-1, Lu Liao Keng, 9th Ling,Wu Lung Tsuen,  
Chiung Lin Hsiang, Hsin Chu Hsien 307, Taiwan

**TEST LOCATION (1):** No. 81-1, Lu Liao Keng, 9th Ling,Wu Lung Tsuen,  
Chiung Lin Hsiang, Hsin Chu Hsien 307, Taiwan

**TEST LOCATION (2):** No. 49, Ln. 206, Wende Rd., Shangshan Tsuen,  
Chiung Lin Hsiang, Hsin Chu Hsien 307, Taiwan

This test report consists of 119 pages in total. It may be duplicated completely for legal use with the approval of the applicant. It should not be reproduced except in full, without the written approval of our laboratory. The client should not use it to claim product certification, approval, or endorsement by TAF or any government agencies. The test results in the report only apply to the tested sample.





## Table of Contents

RELEASE CONTROL RECORD.....	5
1. CERTIFICATION.....	6
2. SUMMARY OF TEST RESULTS.....	7
2.1 MEASUREMENT UNCERTAINTY .....	9
3. GENERAL INFORMATION .....	10
3.1 GENERAL DESCRIPTION OF EUT.....	10
3.2 DESCRIPTION OF TEST MODES.....	13
3.2.1 TEST MODE APPLICABILITY AND TESTED CHANNEL DETAIL .....	14
3.3 GENERAL DESCRIPTION OF APPLIED STANDARDS .....	18
3.4 DESCRIPTION OF SUPPORT UNITS.....	19
3.5 CONFIGURATION OF SYSTEM UNDER TEST .....	20
4. TEST TYPES AND RESULTS (802.11b & g, 2400 ~ 2483.5MHz Band).....	21
4.1 CONDUCTED EMISSION MEASUREMENT .....	21
4.1.1 LIMITS OF CONDUCTED EMISSION MEASUREMENT.....	21
4.1.2 TEST INSTRUMENTS .....	21
4.1.3 TEST PROCEDURES.....	22
4.1.4 DEVIATION FROM TEST STANDARD .....	22
4.1.5 TEST SETUP .....	23
4.1.6 EUT OPERATING CONDITIONS.....	23
4.1.7 TEST RESULTS.....	24
4.2 RADIATED EMISSION MEASUREMENT .....	26
4.2.1 LIMITS OF RADIATED EMISSION MEASUREMENT.....	26
4.2.2 TEST INSTRUMENTS .....	27
4.2.3 TEST PROCEDURES.....	29
4.2.4 DEVIATION FROM TEST STANDARD .....	29
4.2.5 TEST SETUP .....	30
4.2.6 EUT OPERATING CONDITIONS.....	30
4.2.7 TEST RESULTS.....	31
4.3 6dB BANDWIDTH MEASUREMENT .....	60
4.3.1 LIMITS OF 6dB BANDWIDTH MEASUREMENT .....	60
4.3.2 TEST INSTRUMENTS .....	60
4.3.3 TEST PROCEDURE .....	60
4.3.4 DEVIATION FROM TEST STANDARD .....	60
4.3.5 TEST SETUP .....	60
4.3.6 EUT OPERATING CONDITIONS.....	60
4.3.7 TEST RESULTS.....	61
4.4 MAXIMUM PEAK OUTPUT POWER .....	65



4.4.1	LIMITS OF MAXIMUM PEAK OUTPUT POWER MEASUREMENT .....	65
4.4.2	INSTRUMENTS .....	65
4.4.3	TEST PROCEDURES.....	65
4.4.4	DEVIATION FROM TEST STANDARD .....	65
4.4.5	TEST SETUP .....	65
4.4.6	EUT OPERATING CONDITIONS.....	65
4.4.7	TEST RESULTS.....	66
4.5	POWER SPECTRAL DENSITY MEASUREMENT.....	68
4.5.1	LIMITS OF POWER SPECTRAL DENSITY MEASUREMENT .....	68
4.5.2	TEST INSTRUMENTS .....	68
4.5.3	TEST PROCEDURE .....	68
4.5.4	DEVIATION FROM TEST STANDARD .....	68
4.5.5	TEST SETUP .....	68
4.5.6	EUT OPERATING CONDITION .....	68
4.5.7	TEST RESULTS.....	69
4.6	CONDUCTED OUT-BAND EMISSION MEASUREMENT.....	73
4.6.1	LIMITS OF CONDUCTED OUT-BAND EMISSION MEASUREMENT .....	73
4.6.2	TEST INSTRUMENTS .....	73
4.6.3	TEST PROCEDURE .....	73
4.6.4	DEVIATION FROM TEST STANDARD .....	73
4.6.5	EUT OPERATING CONDITION .....	73
4.6.6	TEST RESULTS.....	73
5.	TEST TYPES AND RESULTS (802.11a, 5725~5850MHz Band) .....	82
5.1	CONDUCTED EMISSION MEASUREMENT .....	82
5.1.1	LIMITS OF CONDUCTED EMISSION MEASUREMENT.....	82
5.1.2	TEST INSTRUMENTS .....	82
5.1.3	TEST PROCEDURES.....	83
5.1.4	DEVIATION FROM TEST STANDARD .....	83
5.1.5	TEST SETUP .....	84
5.1.6	EUT OPERATING CONDITIONS.....	84
5.1.7	TEST RESULTS.....	85
5.2	RADIATED EMISSION MEASUREMENT .....	87
5.2.1	LIMITS OF RADIATED EMISSION MEASUREMENT.....	87
5.2.2	TEST INSTRUMENTS .....	88
5.2.3	TEST PROCEDURES.....	90
5.2.4	DEVIATION FROM TEST STANDARD .....	90
5.2.5	TEST SETUP .....	91
5.2.6	EUT OPERATING CONDITIONS.....	91
5.2.7	TEST RESULTS.....	92



5.3	6dB BANDWIDTH MEASUREMENT .....	101
5.3.1	LIMITS OF 6dB BANDWIDTH MEASUREMENT .....	101
5.3.2	TEST INSTRUMENTS .....	101
5.3.3	TEST PROCEDURE .....	101
5.3.4	DEVIATION FROM TEST STANDARD .....	101
5.3.5	TEST SETUP .....	101
5.3.6	EUT OPERATING CONDITIONS.....	101
5.3.7	TEST RESULTS.....	102
5.4	MAXIMUM PEAK OUTPUT POWER .....	105
5.4.1	LIMITS OF MAXIMUM PEAK OUTPUT POWER MEASUREMENT .....	105
5.4.2	INSTRUMENTS .....	105
5.4.3	TEST PROCEDURES.....	105
5.4.4	DEVIATION FROM TEST STANDARD .....	105
5.4.5	TEST SETUP .....	105
5.4.6	EUT OPERATING CONDITIONS.....	105
5.4.7	TEST RESULTS.....	106
5.5	POWER SPECTRAL DENSITY MEASUREMENT.....	107
5.5.1	LIMITS OF POWER SPECTRAL DENSITY MEASUREMENT .....	107
5.5.2	TEST INSTRUMENTS .....	107
5.5.3	TEST PROCEDURE .....	107
5.5.4	DEVIATION FROM TEST STANDARD .....	107
5.5.5	TEST SETUP .....	107
5.5.6	EUT OPERATING CONDITION .....	107
5.5.7	TEST RESULTS.....	108
5.6	CONDUCTED OUT-BAND EMISSION MEASUREMENT.....	111
5.6.1	LIMITS OF CONDUCTED OUT-BAND EMISSION MEASUREMENT .....	111
5.6.2	TEST INSTRUMENTS .....	111
5.6.3	TEST PROCEDURE .....	111
5.6.4	DEVIATION FROM TEST STANDARD .....	111
5.6.5	EUT OPERATING CONDITION .....	111
5.6.6	TEST RESULTS.....	111
6.	INFORMATION ON THE TESTING LABORATORIES .....	118
7.	APPENDIX A - MODIFICATIONS RECORDERS FOR ENGINEERING CHANGES TO THE EUT BY THE LAB.....	119



A D T

## RELEASE CONTROL RECORD

ISSUE NO.	REASON FOR CHANGE	DATE ISSUED
RF110913E01	Original release	Dec. 07, 2011



A D T

## 1. CERTIFICATION

**PRODUCT:** Xtreme N Dual Band USB Adapter  
**BRAND NAME:** D-Link  
**MODEL NO.:** DWA-160  
**TEST SAMPLE:** MASS-PRODUCTION  
**APPLICANT:** D-Link Corporation  
**TESTED:** Sep. 15 to Oct. 19, 2011  
**STANDARDS:** FCC Part 15, Subpart C (Section 15.247)  
ANSI C63.4-2003  
ANSI C63.10-2009

The above equipment (Model: DWA-160) has been tested by **Bureau Veritas Consumer Products Services (H.K.) Ltd., Taoyuan Branch**, and found compliance with the requirement of the above standards. The test record, data evaluation & Equipment Under Test (EUT) configurations represented herein are true and accurate accounts of the measurements of the sample's EMC characteristics under the conditions specified in this report.

**PREPARED BY** : , **DATE:** Dec. 07, 2011  
( Midoli Peng, Specialist )

**APPROVED BY** : , **DATE:** Dec. 07, 2011  
( May Chen, Deputy Manager )

## 2. SUMMARY OF TEST RESULTS

The EUT has been tested according to the following specifications:

For 2.4GHz, 2412~2462MHz Band

<b>APPLIED STANDARD: FCC Part 15, Subpart C</b>			
<b>Standard Section</b>	<b>Test Type and Limit</b>	<b>Result</b>	<b>Remark</b>
15.207	AC Power Conducted Emission	PASS	Meet the requirement of limit. Minimum passing margin is -26.01dB at 3.246MHz
15.247(a)(2)	Spectrum Bandwidth of a Direct Sequence Spread Spectrum System Limit: min. 500kHz	PASS	Meet the requirement of limit.
15.247(b)	Maximum Peak Output Power Limit: max. 30dBm	PASS	Meet the requirement of limit.
15.247(d)	Radiated Emissions Limit: Table 15.209	PASS	Meet the requirement of limit. Minimum passing margin is -0.5dB at 4874.0MHz, 4924.0MHz & 2483.5MHz
15.247(e)	Power Spectral Density Limit: max. 8dBm	PASS	Meet the requirement of limit.
15.247(d)	Conducted Out-Band Emission Measurement Limit: 20dB less than the peak value of fundamental frequency	PASS	Meet the requirement of limit.
15.203	Antenna Requirement	PASS	No antenna connector is used.



A D T

## For 5GHz, 5725~5850MHz Band

APPLIED STANDARD: FCC Part 15, Subpart C			
Standard Section	Test Type and Limit	Result	Remark
15.207	AC Power Conducted Emission	PASS	Meet the requirement of limit. Minimum passing margin is -25.07dB at 3.410MHz
15.247(a)(2)	Spectrum Bandwidth of a Direct Sequence Spread Spectrum System Limit: min. 500kHz	PASS	Meet the requirement of limit.
15.247(b)	Maximum Peak Output Power Limit: max. 30dBm	PASS	Meet the requirement of limit.
15.247(d)	Radiated Emissions Limit: Table 15.209	PASS	Meet the requirement of limit. Minimum passing margin is -0.6dB at 11490.0MHz, 11650.0MHz & 11590.0MHz
15.247(e)	Power Spectral Density Limit: max. 8dBm	PASS	Meet the requirement of limit.
15.247(d)	Conducted Out-Band Emission Measurement Limit: 20dB less than the peak value of fundamental frequency	PASS	Meet the requirement of limit.
15.203	Antenna Requirement	PASS	No antenna connector is used.

**NOTE:**

1. The EUT was operating in 2400 ~ 2483.5MHz, 5.15~5.35GHz, 5.47~5.6GHz & 5.65~5.725GHz and 5.725~5.850GHz frequencies band. This report was recorded the RF parameters including 2400 ~ 2483.5MHz and 5.725~5.850GHz. For the 5.15~5.35GHz, 5.47~5.6GHz & 5.65~5.725GHz RF parameters was recorded in another test report.





A D T

## 2.1 MEASUREMENT UNCERTAINTY

Where relevant, the following measurement uncertainty levels have been estimated for tests performed on the EUT as specified in CISPR 16-4-2:

This uncertainty represents an expanded uncertainty expressed at approximately the 95% confidence level using a coverage factor of  $k=2$ .

Measurement	Value
Conducted emissions	2.45 dB
Radiated emissions (30MHz-1GHz)	3.89 dB
Radiated emissions (1GHz -18GHz)	2.19 dB
Radiated emissions (18GHz -40GHz)	2.56 dB



A D T

### 3. GENERAL INFORMATION

#### 3.1 GENERAL DESCRIPTION OF EUT

<b>PRODUCT</b>	Xtreme N Dual Band USB Adapter
<b>MODEL NO.</b>	DWA-160
<b>FCC ID</b>	KA2WA160B2
<b>POWER SUPPLY</b>	DC 5V ± 10% from host equipment
<b>MODULATION TYPE</b>	CCK, DQPSK, DBPSK for DSSS 64QAM, 16QAM, QPSK, BPSK for OFDM
<b>MODULATION TECHNOLOGY</b>	DSSS, OFDM
<b>TRANSFER RATE</b>	802.11b: up to 11Mbps 802.11g: up to 54Mbps 802.11n (20MHz, 800ns GI): up to 130Mbps 802.11n (40MHz, 800ns GI): up to 270Mbps 802.11n (20MHz, 400ns GI): up to 144.444Mbps 802.11n (40MHz, 400ns GI): up to 300Mbps
<b>OPERATING FREQUENCY</b>	<b>For 15.407</b> 802.11a: 5.18 ~ 5.24GHz, 5.26 ~ 5.32GHz, 5.5~5.58GHz & 5.66~5.7GHz
	<b>For 15.247</b> 802.11b & 802.11g: 2.412 ~ 2.462GHz 802.11a: 5.745 ~ 5.825GHz
<b>NUMBER OF CHANNEL</b>	<b>For 15.407</b> 16 for 802.11a, 802.11n (20MHz) 7 for 802.11n (40MHz)
	<b>For 15.247(2.4GHz)</b> 11 for 802.11b, 802.11g, 802.11n (20MHz) 7 for 802.11n (40MHz) <b>For 15.247(5GHz)</b> 5 for 802.11a, 802.11n (20MHz) 2 for 802.11n (40MHz)

<b>MAXIMUM OUTPUT POWER</b>	<b>For 15.407</b> 802.11a: 75.9mW 802.11n (20MHz): 118.3mW 802.11n (40MHz): 120.1mW <b>For 15.247(2.4GHz)</b> 802.11b: 114.82mW 802.11g: 263.0mW 802.11n (20MHz): 709.8mW 802.11n (40MHz): 355.8mW <b>For 15.247(5GHz)</b> 802.11a: 251.2mW 802.11n (20MHz): 458.3mW 802.11n (40MHz): 486.1mW
<b>ANTENNA TYPE</b>	Please see note
<b>DATA CABLE</b>	USB Cable x 1(shielded, 0.97m)
<b>I/O PORTS</b>	NA
<b>ASSOCIATED DEVICES</b>	USB Cradle x 1

**NOTE:**

1. There are two antennas provided to this EUT, please refer to the following table:

Transmitter Circuit	Manufacture	Antenna Type	Gain (dBi)	Antenna Connector
Chain (0)	Alpha	PCB Printed	2.4GHz : 0.7 5.15~5.25GHz: 2.97 5.25~5.35GHz: 3.27 5.47~5.725GHz :2.60 5.725~5.850GHz :2.60	NA
Chain (1)	Alpha	PCB Printed	2.4GHz : 1.39 5.15~5.25GHz: 3.61 5.25~5.35GHz: 3.98 5.47~5.725GHz :2.87 5.725~5.850GHz :2.87	NA

2. The EUT must be supplied with a USB Cradle, and it has two different Model could be chosen:

No.	Model Name
1	581005241000G
2	581005241002G



3. The EUT was pre-tested in chamber as the following test modes:

Pre-test Mode	Description
<b>Mode A</b>	<b>EUT with USB Cradle (Model : 581005241000G)</b>
Mode B	EUT with USB Cradle (Model : 581005241002G)
<b>Mode C</b>	<b>EUT without USB Cradle</b>

From the above modes, the worst radiated test (below 1GHz) was found in **Mode A** and the worst radiated test (above 1GHz) was found in **Mode C**. Therefore only the test data of the mode was recorded in this report.

4. 2.4GHz & 5GHz technology cannot transmit at same time.
5. The EUT is 2 \* 2 spatial MIMO (2Tx & 2Rx) without beam forming function. The 11a, 11b and 11g legacy mode is limited to single transmitter only.
6. When the EUT operating in 802.11n, the software operation, which is defined by manufacturer, MCS (Modulation and Coding Schemes) from 0 to 15.
7. The above EUT information was declared by the manufacturer and for more detailed features description, please refer to the manufacturer's specifications or User's.

### 3.2 DESCRIPTION OF TEST MODES

#### Operated in 2400 ~ 2483.5MHz band:

Eleven channels are provided for 802.11b, 802.11g, 802.11n (20MHz):

CHANNEL	FREQUENCY	CHANNEL	FREQUENCY
1	2412MHz	7	2442MHz
2	2417MHz	8	2447MHz
3	2422MHz	9	2452MHz
4	2427MHz	10	2457MHz
5	2432MHz	11	2462MHz
6	2437MHz		

Seven channels are provided for 802.11n (40MHz):

CHANNEL	FREQUENCY	CHANNEL	FREQUENCY
3	2422MHz	7	2442MHz
4	2427MHz	8	2447MHz
5	2432MHz	9	2452MHz
6	2437MHz		

#### Operated in 5725 ~ 5850MHz band:

Five channels are provided for 802.11a, 802.11n (20MHz):

CHANNEL	FREQUENCY	CHANNEL	FREQUENCY
149	5745 MHz	161	5805 MHz
153	5765 MHz	165	5825 MHz
157	5785 MHz		

Two channels are provided for 802.11n (40MHz):

CHANNEL	FREQUENCY
151	5755 MHz
159	5795 MHz



A D T

### 3.2.1 TEST MODE APPLICABILITY AND TESTED CHANNEL DETAIL

EUT CONFIGURE MODE	APPLICABLE TO					DESCRIPTION
	PLC	RE < 1G	RE ≥ 1G	APCM	OB	
1	√	√	-	-	-	with USB Cradle
2	-	-	√	√	√	without USB Cradle

Where **PLC**: Power Line Conducted Emission      **RE < 1G**: Radiated Emission below 1GHz  
**RE ≥ 1G**: Radiated Emission above 1GHz      **APCM**: Antenna Port Conducted Measurement  
**OB**: Conducted Out-Band Emission Measurement

### ANTENNA COMBINATION MODE:

COMBINATION MODE	OPERATION MODE	TX CHAIN(0)	TX CHAIN(1)
A	802.11 b	√	-
B	802.11 g	√	-
C	802.11 a	√	-
D	802.11n(20MHz) for MCS0~15	√	√
E	802.11n(40MHz) for MCS0~15	√	√

Note: 1. The above information was declared by manufacturer and for more detailed features description, please refer to the manufacturer's specifications or user's manual.

### POWER LINE CONDUCTED EMISSION TEST:

- Pre-Scan has been conducted to determine the worst-case mode from all possible combinations between available modulations, data rates and antenna ports (if EUT with antenna diversity architecture).
- Following channel(s) was (were) selected for the final test as listed below.

MODE	AVAILABLE CHANNEL	TESTED CHANNEL	MODULATION TECHNOLOGY	MODULATION TYPE	DATA RATE (Mbps)	COMBINATION
For 2.4 GHz 802.11n (20MHz)	1 to 11	6	OFDM	BPSK	6.5	D
For 5 GHz 802.11n (20MHz)	149 to 165	149	OFDM	BPSK	6.5	D



A D T

**RADIATED EMISSION TEST (BELOW 1 GHz):**

- Pre-Scan has been conducted to determine the worst-case mode from all possible combinations between available modulations, data rates and antenna ports (if EUT with antenna diversity architecture).
- Following channel(s) was (were) selected for the final test as listed below.

MODE	AVAILABLE CHANNEL	TESTED CHANNEL	MODULATION TECHNOLOGY	MODULATION TYPE	DATA RATE (Mbps)	COMBINATION
For 2.4 GHz 802.11n (20MHz)	1 to 11	6	OFDM	BPSK	6.5	D
For 5 GHz 802.11n (20MHz)	149 to 165	149	OFDM	BPSK	6.5	D

**RADIATED EMISSION TEST (ABOVE 1 GHz):**

- Pre-Scan has been conducted to determine the worst-case mode from all possible combinations between available modulations, data rates and antenna ports (if EUT with antenna diversity architecture).
- Following channel(s) was (were) selected for the final test as listed below.

MODE	AVAILABLE CHANNEL	TESTED CHANNEL	MODULATION TECHNOLOGY	MODULATION TYPE	DATA RATE (Mbps)	COMBINATION
802.11b	1 to 11	1, 6, 11	DSSS	DBPSK	1	A
802.11g	1 to 11	1, 6, 11	OFDM	BPSK	6	B
For 2.4 GHz 802.11n (20MHz)	1 to 11	1, 6, 11	OFDM	BPSK	6.5	D
For 2.4 GHz 802.11n (40MHz)	3 to 9	3, 6, 9	OFDM	BPSK	13.5	E
802.11a	149 to 165	149, 157, 165	OFDM	BPSK	6	C
For 5 GHz 802.11n (20MHz)	149 to 165	149, 157, 165	OFDM	BPSK	6.5	D
For 5 GHz 802.11n (40MHz)	151 to 159	151, 159	OFDM	BPSK	13.5	E

### **ANTENNA PORT CONDUCTED MEASUREMENT:**

- This item includes all test value of each mode, but only includes spectrum plot of worst value of each mode.
- Pre-Scan has been conducted to determine the worst-case mode from all possible combinations between available modulations, data rates and antenna ports (if EUT with antenna diversity architecture).
- Following channel(s) was (were) selected for the final test as listed below.

MODE	AVAILABLE CHANNEL	TESTED CHANNEL	MODULATION TECHNOLOGY	MODULATION TYPE	DATA RATE (Mbps)	COMBINATION
802.11b	1 to 11	1, 6, 11	DSSS	DBPSK	1	A
802.11g	1 to 11	1, 6, 11	OFDM	BPSK	6	B
For 2.4 GHz 802.11n (20MHz)	1 to 11	1, 6, 11	OFDM	BPSK	6.5	D
For 2.4 GHz 802.11n (40MHz)	3 to 9	3, 6, 9	OFDM	BPSK	13.5	E
802.11a	149 to 165	149, 157, 165	OFDM	BPSK	6	C
For 5 GHz 802.11n (20MHz)	149 to 165	149, 157, 165	OFDM	BPSK	6.5	D
For 5 GHz 802.11n (40MHz)	151 to 159	151, 159	OFDM	BPSK	13.5	E

### **CONDUCTED OUT-BAND EMISSION MEASUREMENT:**

- Pre-Scan has been conducted to determine the worst-case mode from all possible combinations between available modulations, data rates and antenna ports (if EUT with antenna diversity architecture).
- Following channel(s) was (were) selected for the final test as listed below.

MODE	AVAILABLE CHANNEL	TESTED CHANNEL	MODULATION TECHNOLOGY	MODULATION TYPE	DATA RATE (Mbps)	COMBINATION MODE
802.11b	1 to 11	1, 11	DSSS	DBPSK	1	A
802.11g	1 to 11	1, 11	OFDM	BPSK	6	B
For 2.4 GHz 802.11n (20MHz)	1 to 11	1, 11	OFDM	BPSK	6.5	D
For 2.4 GHz 802.11n (40MHz)	3 to 9	3, 9	OFDM	BPSK	13.5	E
802.11a	149 to 165	149, 165	OFDM	BPSK	6	C
For 5 GHz 802.11n (20MHz)	149 to 165	149, 165	OFDM	BPSK	6.5	D
For 5 GHz 802.11n (40MHz)	151 to 159	151, 159	OFDM	BPSK	13.5	E





A D T

**TEST CONDITION:**

APPLICABLE TO	ENVIRONMENTAL CONDITIONS	INPUT POWER (SYSTEM)	TESTED BY
PLC	25deg. C, 68%RH	120Vac, 60Hz	Frank Liu
RE<1G	27deg. C, 72%RH	120Vac, 60Hz	Frank Liu
RE <sup>3</sup> 1G	25deg. C, 69%RH	120Vac, 60Hz	Nelson Teng
APCM	27deg. C, 60%RH	120Vac, 60Hz	Rex Huang
OB	27deg. C, 60%RH	120Vac, 60Hz	Rex Huang

### 3.3 GENERAL DESCRIPTION OF APPLIED STANDARDS

The EUT is a RF product. According to the specifications of the manufacturer, it must comply with the requirements of the following standards:

**FCC Part 15, Subpart C. (15.247)**

**ANSI C63.4-2003**

**ANSI C63.10-2009**

All test items have been performed and recorded as per the above standards.

**NOTE:** The EUT is also considered as a kind of computer peripheral, because the connection to computer is necessary for typical use. It has been verified to comply with the requirements of FCC Part 15, Subpart B, Class B (DoC). The test report has been issued separately.



A D T

### 3.4 DESCRIPTION OF SUPPORT UNITS

The EUT has been tested as an independent unit together with other necessary accessories or support units. The following support units or accessories were used to form a representative test configuration during the tests.

NO.	PRODUCT	BRAND	MODEL NO.	SERIAL NO.	FCC ID
1	NOTEBOOK COMPUTER	DELL	PP32LA	GSLB32S	FCC DoC
2	iPod shuffle	Apple	MC749TA/A	CC4DMFJUDFDM	NA

NO.	SIGNAL CABLE DESCRIPTION OF THE ABOVE SUPPORT UNITS
1	USB Cable (0.97m)
2	USB Cable (0.1m)

**NOTE:** All power cords of the above support units are non shielded (1.8m).

### 3.5 CONFIGURATION OF SYSTEM UNDER TEST

For conducted and radiated (below 1GHz) test:

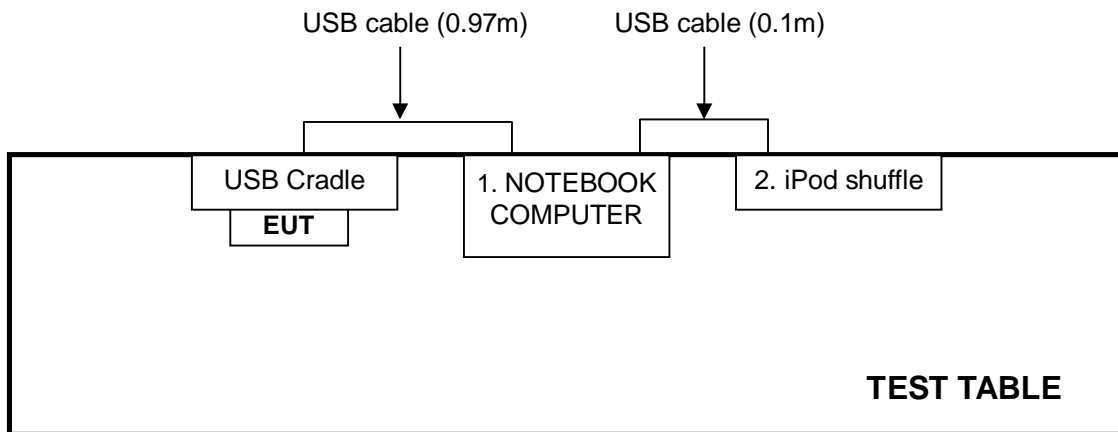

For other test items:

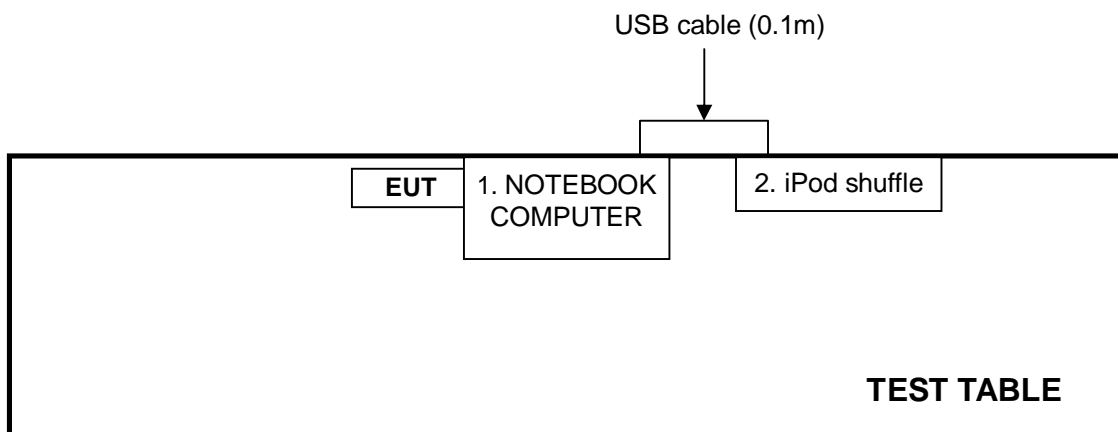



A D T

## 4. TEST TYPES AND RESULTS (802.11b & g, 2400 ~ 2483.5MHz Band)

### 4.1 CONDUCTED EMISSION MEASUREMENT

#### 4.1.1 LIMITS OF CONDUCTED EMISSION MEASUREMENT

FREQUENCY OF EMISSION (MHz)	CONDUCTED LIMIT (dB $\mu$ V)	
	Quasi-peak	Average
0.15-0.5	66 to 56	56 to 46
0.5-5	56	46
5-30	60	50

- NOTE:**
1. The lower limit shall apply at the transition frequencies.
  2. The limit decreases in line with the logarithm of the frequency in the range of 0.15 to 0.50 MHz.
  3. All emanations from a class A/B digital device or system, including any network of conductors and apparatus connected thereto, shall not exceed the level of field strengths specified above.

#### 4.1.2 TEST INSTRUMENTS

Test date: Oct. 19, 2011

DESCRIPTION & MANUFACTURER	MODEL NO.	SERIAL NO.	CALIBRATED DATE	CALIBRATED UNTIL
Test Receiver	ESCS 30	100375	Mar. 09, 2011	Mar. 08, 2012
Line-Impedance Stabilization Network (for EUT)	ENV216	100072	Jun. 10, 2011	Jun. 09, 2012
Line-Impedance Stabilization Network (for Peripheral)	ESH3-Z5	848773/004	Nov. 03, 2010	Nov. 02, 2011
RF Cable (JYEBAO)	5DFB	COCCAB-002	Aug. 29, 2011	Aug. 28, 2012
50 ohms Terminator	50	3	Nov. 03, 2010	Nov. 02, 2011
Software	BV ADT_Cond_V7.3.7	NA	NA	NA

**Note:**

1. The calibration interval of the above test instruments is 12 months and the calibrations are traceable to NML/ROC and NIST/USA.
2. The test was performed in Shielded Room No. C.
3. The VCCI Con C Registration No. is C-3611.



A D T

#### 4.1.3 TEST PROCEDURES

- a. The EUT was placed 0.4 meters from the conducting wall of the shielded room with EUT being connected to the power mains through a line impedance stabilization network (LISN). Other support units were connected to the power mains through another LISN. The two LISNs provide 50 ohm/ 50uH of coupling impedance for the measuring instrument.
- b. Both lines of the power mains connected to the EUT were checked for maximum conducted interference.
- c. The frequency range from 150kHz to 30MHz was searched. Emission levels under (Limit - 20dB) were not recorded.

#### 4.1.4 DEVIATION FROM TEST STANDARD

No deviation

#### 4.1.5 TEST SETUP

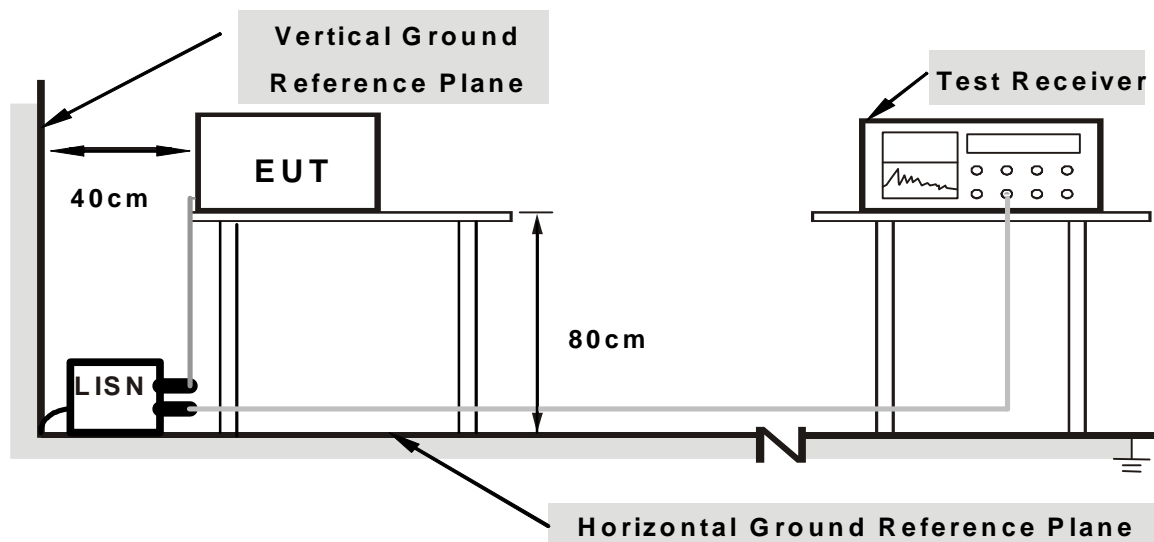

**Note: 1.Support units were connected to second LISN.**

**2.Both of LISNs (AMN) are 80 cm from EUT and at least 80 from other units and other metal planes**

For the actual test configuration, please refer to the related item – Photographs of the Test Configuration.

#### 4.1.6 EUT OPERATING CONDITIONS

1. Connect the EUT with the support unit 1 (Notebook Computer) which is placed on a testing table.
2. The communication partner run test program “RT5x7x V1.0.4.8.exe” to enable EUT under transmission/receiving condition continuously at specific channel frequency.

### 4.1.7 TEST RESULTS

<b>PHASE</b>	Line (L)	<b>6dB BANDWIDTH</b>	9 kHz
--------------	----------	----------------------	-------

No	Freq. [MHz]	Corr. Factor (dB)	Reading Value [dB (uV)]		Emission Level [dB (uV)]		Limit [dB (uV)]		Margin (dB)	
			Q.P.	AV.	Q.P.	AV.	Q.P.	AV.	Q.P.	AV.
			1	0.150	0.10	25.27	18.38	25.37	18.48	66.00
2	0.170	0.11	22.70	16.12	22.81	16.23	64.98	54.98	-42.17	-38.75
3	1.512	0.15	26.56	16.72	26.71	16.87	56.00	46.00	-29.29	-29.13
4	1.938	0.16	27.80	17.98	27.96	18.14	56.00	46.00	-28.04	-27.86
5	2.270	0.17	24.98	13.29	25.15	13.46	56.00	46.00	-30.85	-32.54
6	3.391	0.19	27.76	16.72	27.95	16.91	56.00	46.00	-28.05	-29.09

- REMARKS:**
1. Q.P. and AV. are abbreviations of quasi-peak and average individually.
  2. The emission levels of other frequencies were very low against the limit.
  3. Margin value = Emission level - Limit value
  4. Correction factor = Insertion loss + Cable loss
  5. Emission Level = Correction Factor + Reading Value.

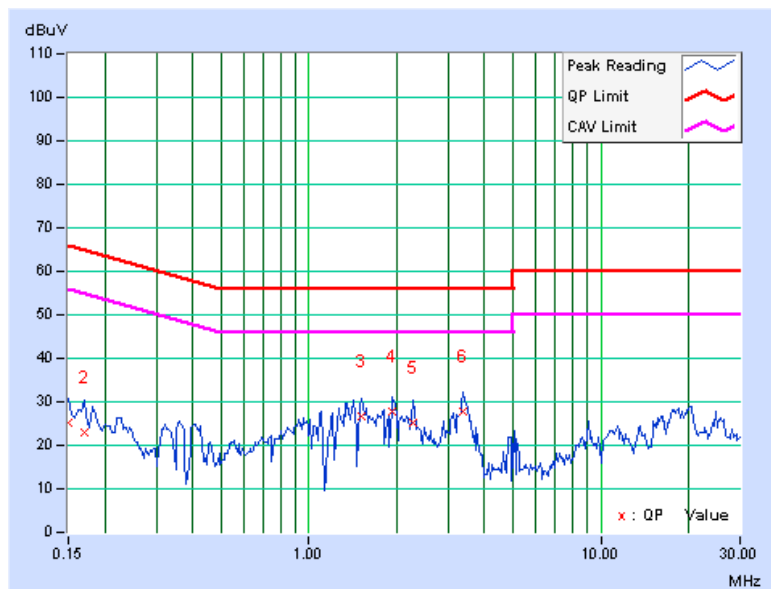



<b>PHASE</b>	Neutral (N)	<b>6dB BANDWIDTH</b>	9 kHz
--------------	-------------	----------------------	-------

No	Freq. [MHz]	Corr. Factor (dB)	Reading Value [dB (uV)]		Emission Level [dB (uV)]		Limit [dB (uV)]		Margin (dB)	
			Q.P.	AV.	Q.P.	AV.	Q.P.	AV.	Q.P.	AV.
			1	0.162	0.12	22.46	13.33	22.58	13.45	65.38
2	0.732	0.16	21.45	13.87	21.61	14.03	56.00	46.00	-34.39	-31.97
<b>3</b>	<b>3.246</b>	<b>0.25</b>	<b>26.19</b>	<b>19.74</b>	<b>26.44</b>	<b>19.99</b>	<b>56.00</b>	<b>46.00</b>	<b>-29.56</b>	<b>-26.01</b>
4	16.805	1.23	20.86	14.05	22.09	15.28	60.00	50.00	-37.91	-34.72
5	20.477	1.46	24.29	18.01	25.75	19.47	60.00	50.00	-34.25	-30.53
6	27.383	2.00	18.86	13.60	20.86	15.60	60.00	50.00	-39.14	-34.40

- REMARKS:**
1. Q.P. and AV. are abbreviations of quasi-peak and average individually.
  2. The emission levels of other frequencies were very low against the limit.
  3. Margin value = Emission level - Limit value
  4. Correction factor = Insertion loss + Cable loss
  5. Emission Level = Correction Factor + Reading Value.

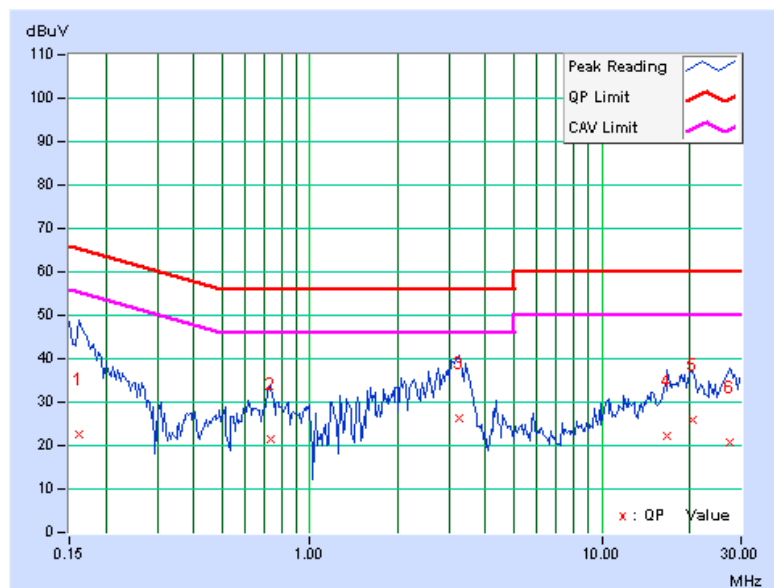

## 4.2 RADIATED EMISSION MEASUREMENT

### 4.2.1 LIMITS OF RADIATED EMISSION MEASUREMENT

Emissions radiated outside of the specified bands, shall be according to the general radiated limits in 15.209 as following:

Frequencies (MHz)	Field strength (microvolts/meter)	Measurement distance (meters)
0.009-0.490	2400/F(kHz)	300
0.490-1.705	24000/F(kHz)	30
1.705-30.0	30	30
30-88	100	3
88-216	150	3
216-960	200	3
Above 960	500	3

**NOTE:**

1. The lower limit shall apply at the transition frequencies.
2. Emission level (dBuV/m) = 20 log Emission level (uV/m).
3. As shown in 15.35(b), for frequencies above 1000MHz, the field strength limits are based on average detector, however, the peak field strength of any emission shall not exceed the maximum permitted average limits, specified above by more than 20dB under any condition of modulation.
4. Section 15.205 restricted bands of operation shall compliance with the limits in Section 15.209.



A D T

## 4.2.2 TEST INSTRUMENTS

For below 1GHz: Test date: Sep. 15, 2011

DESCRIPTION & MANUFACTURER	MODEL NO.	SERIAL NO.	CALIBRATED DATE	CALIBRATED UNTIL
Agilent Spectrum Analyzer	E4446A	MY48250253	Aug. 29, 2011	Aug. 28, 2012
Agilent Pre-Selector	N9039A	MY46520310	Aug. 29, 2011	Aug. 28, 2012
Agilent Signal Generator	N5181A	MY49060347	July 25, 2011	July 24, 2012
LIG NEX1 Test Receiver	ER-265	L09068005	Oct. 25, 2010	Oct. 24, 2011
Mini-Circuits Pre-Amplifier	ZFL-1000VH2B	AMP-ZFL-04	Nov. 16, 2010	Nov. 15, 2011
Agilent Pre-Amplifier	8449B	3008A02465	Feb. 28, 2011	Feb. 27, 2012
Miteq Pre-Amplifier	AFS33-1800265 0-30-8P-44	881786	Nov. 16, 2010	Nov. 15, 2011
SCHWARZBECK Trilog Broadband Antenna	VULB 9168	9168-361	Apr. 14, 2011	Apr. 13, 2012
AISI Horn_Antenna	AIH.8018	0000220091110	Nov. 22, 2010	Nov. 21, 2011
SCHWARZBECK Horn_Antenna	BBHA 9170	9170-424	Oct. 08, 2010	Oct. 07, 2011
RF CABLE	NA	RF104-205 RF104-207 RF104-202	Dec. 28, 2010	Dec. 27, 2011
RF Cable	NA	CHHCAB_001	Oct. 12, 2010	Oct. 11, 2011
Software	ADT_Radiated_V8.7.05	NA	NA	NA
CT Antenna Tower & Turn Table	NA	NA	NA	NA

Note: 1. The calibration interval of the above test instruments is 12 months and the calibrations are traceable to NML/ROC and NIST/USA.

2. The horn antenna, preamplifier (model: 8449B) are used only for the measurement of emission frequency above 1GHz if tested.

3. The test was performed in 966 Chamber No. H.

4. The FCC Site Registration No. is 797305.

5. The CANADA Site Registration No. is IC 7450H-3.



A D T

**For above 1GHz: Test date: Oct. 04, 2011**

DESCRIPTION & MANUFACTURER	MODEL NO.	SERIAL NO.	CALIBRATED DATE	CALIBRATED UNTIL
Agilent Spectrum Analyzer	E4446A	MY48250254	July 12, 2011	July 11, 2012
Agilent Pre-Selector	N9039A	MY46520311	July 12, 2011	July 11, 2012
Agilent Signal Generator	N5181A	MY49060517	July 12, 2011	July 11, 2012
Mini-Circuits Pre-Amplifier	ZFL-1000VH2B	AMP-ZFL-03	Nov. 16, 2010	Nov. 15, 2011
Agilent Pre-Amplifier	8449B	3008A02578	July 04, 2011	July 03, 2012
Miteq Pre-Amplifier	AFS33-1800265 0-30-8P-44	881786	Nov. 16, 2010	Nov. 15, 2011
SCHWARZBECK Trilog Broadband Antenna	VULB 9168	9168-360	Apr. 14, 2011	Apr. 13, 2012
AISI Horn_Antenna	AIH.8018	0000320091110	Nov. 12, 2010	Nov. 11, 2011
SCHWARZBECK Horn_Antenna	BBHA 9170	9170-424	Oct. 08, 2010	Oct. 07, 2011
RF CABLE	NA	RF104-201 RF104-203 RF104-204	Dec. 27, 2010	Dec. 26, 2011
RF Cable	NA	CHGCAB_001	Oct. 12, 2010	Oct. 11, 2011
Software	ADT_Radiated_V8.7.05	NA	NA	NA
CT Antenna Tower & Turn Table	NA	NA	NA	NA

- Note: 1. The calibration interval of the above test instruments is 12 months and the calibrations are traceable to NML/ROC and NIST/USA.  
2. The horn antenna, preamplifier (model: 8449B) are used only for the measurement of emission frequency above 1GHz if tested.  
3. The test was performed in 966 Chamber No. G.  
4. The FCC Site Registration No. is 966073.  
5. The VCCI Site Registration No. is G-137.  
6. The CANADA Site Registration No. is IC 7450H-2.



A D T

#### 4.2.3 TEST PROCEDURES

- a. The EUT was placed on the top of a rotating table 0.8 meters above the ground at 3 meter chamber room. The table was rotated 360 degrees to determine the position of the highest radiation.
- b. The EUT was set 3 meters away from the interference-receiving antenna, which was mounted on the top of a variable-height antenna tower.
- c. The height of antenna is varied from one meter to four meters above the ground to determine the maximum value of the field strength. Both horizontal and vertical polarizations of the antenna are set to make the measurement.
- d. For each suspected emission, the EUT was arranged to its worst case and then the antenna was tuned to heights from 1 meter to 4 meters and the rotatable table was turned from 0 degrees to 360 degrees to find the maximum reading.
- e. The test-receiver system was set to quasi-peak detect function and specified bandwidth with maximum hold mode when the test frequency is below 1 GHz.
- f. The test-receiver system was set to peak and average detect function and specified bandwidth with maximum hold mode when the test frequency is above 1 GHz. If the peak reading value also meets average limit, measurement with the average detector is unnecessary.

**NOTE:**

1. The resolution bandwidth and video bandwidth of test receiver/spectrum analyzer is 120kHz for Quasi-peak detection (QP) at frequency below 1GHz.
2. The resolution bandwidth of test receiver/spectrum analyzer is 1 MHz and the video bandwidth is 3 MHz for Peak detection (PK) at frequency above 1GHz.
3. The resolution bandwidth of test receiver/spectrum analyzer is 1 MHz and the video bandwidth is 10 Hz for Average detection (AV) at frequency above 1GHz.

#### 4.2.4 DEVIATION FROM TEST STANDARD

No deviation

#### 4.2.5 TEST SETUP

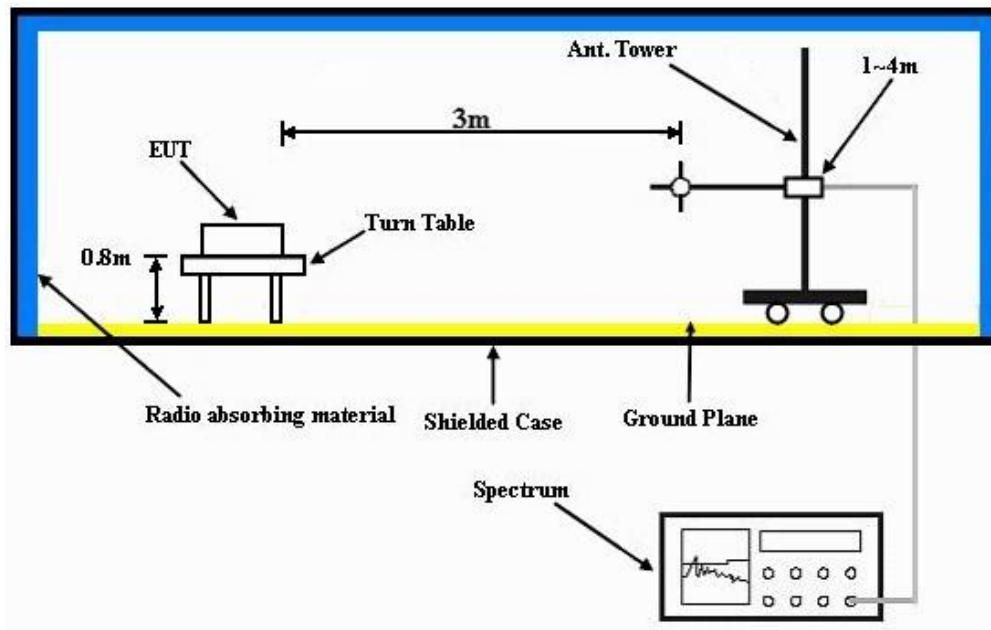

For the actual test configuration, please refer to the related item – Photographs of the Test Configuration.

#### 4.2.6 EUT OPERATING CONDITIONS

Same as 4.1.6



A D T

### 4.2.7 TEST RESULTS

#### BELOW 1GHz WORST-CASE DATA : 802.11n (20MHz) OFDM MODULATION

EUT TEST CONDITION		MEASUREMENT DETAIL	
CHANNEL	Channel 6	FREQUENCY RANGE	Below 1000MHz
INPUT POWER (SYSTEM)	120Vac, 60 Hz	DETECTOR FUNCTION	Quasi-Peak
ENVIRONMENTAL CONDITIONS	27deg. C, 72%RH	TESTED BY	Frank Liu

ANTENNA POLARITY & TEST DISTANCE: HORIZONTAL AT 3 M								
NO.	FREQ. (MHz)	EMISSION LEVEL (dBuV/m)	LIMIT (dBuV/m)	MARGIN (dB)	ANTENNA HEIGHT (m)	TABLE ANGLE (Degree)	RAW VALUE (dBuV)	CORRECTION FACTOR (dB/m)
1	216.99	38.1 QP	46.0	-7.9	1.50 H	81	26.28	11.83
2	234.99	39.1 QP	46.0	-6.9	1.50 H	70	26.60	12.49
3	321.79	41.7 QP	46.0	-4.3	1.00 H	242	26.09	15.65
4	409.19	34.8 QP	46.0	-11.3	2.00 H	269	17.22	17.53
5	604.82	39.9 QP	46.0	-6.2	1.50 H	265	18.22	21.63
6	959.97	32.2 QP	46.0	-13.8	1.00 H	31	5.72	26.50
ANTENNA POLARITY & TEST DISTANCE: VERTICAL AT 3 M								
NO.	FREQ. (MHz)	EMISSION LEVEL (dBuV/m)	LIMIT (dBuV/m)	MARGIN (dB)	ANTENNA HEIGHT (m)	TABLE ANGLE (Degree)	RAW VALUE (dBuV)	CORRECTION FACTOR (dB/m)
1	33.67	33.9 QP	40.0	-6.2	1.00 V	236	20.63	13.22
2	143.09	28.0 QP	43.5	-15.5	1.00 V	2	13.81	14.21
3	217.34	29.5 QP	46.0	-16.5	1.00 V	347	17.68	11.84
4	303.20	37.8 QP	46.0	-8.2	1.50 V	360	22.55	15.25
5	604.94	28.1 QP	46.0	-17.9	1.50 V	225	6.48	21.63
6	846.05	28.9 QP	46.0	-17.1	1.50 V	302	3.79	25.09

- REMARKS:**
1. Emission level (dBuV/m) = Raw Value (dBuV) + Correction Factor (dB/m).
  2. Correction Factor (dB/m) = Antenna Factor (dB/m) + Cable Factor (dB).
  3. The other emission levels were very low against the limit.
  4. Margin value = Emission level – Limit value.



A D T

ABOVE 1GHz WORST-CASE DATA

802.11b DSSS MODULATION

EUT TEST CONDITION		MEASUREMENT DETAIL	
CHANNEL	Channel 1	FREQUENCY RANGE	1 ~ 25GHz
INPUT POWER (SYSTEM)	120Vac, 60 Hz	DETECTOR FUNCTION	Peak (PK) Average (AV)
ENVIRONMENTAL CONDITIONS	25deg. C, 69%RH	TESTED BY	Nelson Teng

ANTENNA POLARITY & TEST DISTANCE: HORIZONTAL AT 3 M

NO.	FREQ. (MHz)	EMISSION LEVEL (dBuV/m)	LIMIT (dBuV/m)	MARGIN (dB)	ANTENNA HEIGHT (m)	TABLE ANGLE (Degree)	RAW VALUE (dBuV)	CORRECTION FACTOR (dB/m)
1	2390.00	54.6 PK	74.0	-19.4	1.00 H	258	22.85	31.75
2	2390.00	43.6 AV	54.0	-10.4	1.00 H	258	11.85	31.75
3	*2412.00	105.8 PK			1.00 H	111	73.98	31.82
4	*2412.00	103.4 AV			1.00 H	111	71.58	31.82
5	4824.00	47.3 PK	74.0	-26.7	1.00 H	248	7.94	39.36
6	4824.00	38.9 AV	54.0	-15.1	1.00 H	248	-0.46	39.36

ANTENNA POLARITY & TEST DISTANCE: VERTICAL AT 3 M

NO.	FREQ. (MHz)	EMISSION LEVEL (dBuV/m)	LIMIT (dBuV/m)	MARGIN (dB)	ANTENNA HEIGHT (m)	TABLE ANGLE (Degree)	RAW VALUE (dBuV)	CORRECTION FACTOR (dB/m)
1	2356.67	56.9 PK	74.0	-17.1	1.00 V	251	25.25	31.65
2	2356.67	46.1 AV	54.0	-7.9	1.00 V	251	14.45	31.65
3	*2412.00	104.7 PK			1.00 V	250	72.88	31.82
4	*2412.00	102.6 AV			1.00 V	250	70.78	31.82
5	4824.00	56.6 PK	74.0	-17.4	1.02 V	260	17.24	39.36
6	4824.00	53.0 AV	54.0	-1.0	1.02 V	260	13.64	39.36

- REMARKS:**
1. Emission level (dBuV/m) = Raw Value (dBuV) + Correction Factor (dB/m).
  2. Correction Factor (dB/m) = Antenna Factor (dB/m) + Cable Factor (dB).
  3. The other emission levels were very low against the limit.
  4. Margin value = Emission level – Limit value.
  5. “ \* “: Fundamental frequency.





A D T

EUT TEST CONDITION		MEASUREMENT DETAIL	
CHANNEL	Channel 6	FREQUENCY RANGE	1 ~ 25GHz
INPUT POWER (SYSTEM)	120Vac, 60 Hz	DETECTOR FUNCTION	Peak (PK) Average (AV)
ENVIRONMENTAL CONDITIONS	25deg. C, 69%RH	TESTED BY	Nelson Teng

ANTENNA POLARITY & TEST DISTANCE: HORIZONTAL AT 3 M								
NO.	FREQ. (MHz)	EMISSION LEVEL (dBuV/m)	LIMIT (dBuV/m)	MARGIN (dB)	ANTENNA HEIGHT (m)	TABLE ANGLE (Degree)	RAW VALUE (dBuV)	CORRECTION FACTOR (dB/m)
1	*2437.00	106.6 PK			1.00 H	117	74.68	31.92
2	*2437.00	104.2 AV			1.00 H	117	72.28	31.92
3	4874.00	48.3 PK	74.0	-25.7	1.00 H	251	8.80	39.50
4	4874.00	38.6 AV	54.0	-15.4	1.00 H	251	-0.90	39.50
5	7311.00	52.6 PK	74.0	-21.4	1.03 H	291	5.72	46.88
6	7311.00	39.7 AV	54.0	-14.3	1.03 H	291	-7.18	46.88
ANTENNA POLARITY & TEST DISTANCE: VERTICAL AT 3 M								
NO.	FREQ. (MHz)	EMISSION LEVEL (dBuV/m)	LIMIT (dBuV/m)	MARGIN (dB)	ANTENNA HEIGHT (m)	TABLE ANGLE (Degree)	RAW VALUE (dBuV)	CORRECTION FACTOR (dB/m)
1	*2437.00	105.4 PK			1.01 V	255	73.48	31.92
2	*2437.00	103.1 AV			1.01 V	255	71.18	31.92
3	4874.00	56.3 PK	74.0	-17.7	1.01 V	259	16.80	39.50
4	<b>4874.00</b>	<b>53.5 AV</b>	<b>54.0</b>	<b>-0.5</b>	<b>1.01 V</b>	<b>259</b>	<b>14.00</b>	<b>39.50</b>
5	7311.00	53.2 PK	74.0	-20.8	1.03 V	255	6.32	46.88
6	7311.00	40.5 AV	54.0	-13.5	1.03 V	255	-6.38	46.88

- REMARKS:**
1. Emission level (dBuV/m) = Raw Value (dBuV) + Correction Factor (dB/m).
  2. Correction Factor (dB/m) = Antenna Factor (dB/m) + Cable Factor (dB).
  3. The other emission levels were very low against the limit.
  4. Margin value = Emission level – Limit value.
  5. “ \* “: Fundamental frequency.



A D T

EUT TEST CONDITION		MEASUREMENT DETAIL	
CHANNEL	Channel 11	FREQUENCY RANGE	1 ~ 25GHz
INPUT POWER (SYSTEM)	120Vac, 60 Hz	DETECTOR FUNCTION	Peak (PK) Average (AV)
ENVIRONMENTAL CONDITIONS	25deg. C, 69%RH	TESTED BY	Nelson Teng

ANTENNA POLARITY & TEST DISTANCE: HORIZONTAL AT 3 M								
NO.	FREQ. (MHz)	EMISSION LEVEL (dBuV/m)	LIMIT (dBuV/m)	MARGIN (dB)	ANTENNA HEIGHT (m)	TABLE ANGLE (Degree)	RAW VALUE (dBuV)	CORRECTION FACTOR (dB/m)
1	*2462.00	106.7 PK			1.00 H	115	74.69	32.01
2	*2462.00	104.3 AV			1.00 H	115	72.29	32.01
3	2483.50	59.5 PK	74.0	-14.5	1.00 H	115	27.41	32.09
4	2483.50	49.8 AV	54.0	-4.2	1.00 H	115	17.71	32.09
5	4924.00	51.5 PK	74.0	-22.5	1.04 H	331	11.83	39.67
6	4924.00	45.4 AV	54.0	-8.6	1.04 H	331	5.73	39.67
7	7386.00	52.4 PK	74.0	-21.6	1.02 H	287	5.60	46.80
8	7386.00	40.3 AV	54.0	-13.7	1.02 H	287	-6.50	46.80
ANTENNA POLARITY & TEST DISTANCE: VERTICAL AT 3 M								
NO.	FREQ. (MHz)	EMISSION LEVEL (dBuV/m)	LIMIT (dBuV/m)	MARGIN (dB)	ANTENNA HEIGHT (m)	TABLE ANGLE (Degree)	RAW VALUE (dBuV)	CORRECTION FACTOR (dB/m)
1	*2462.00	105.2 PK			1.00 V	252	73.19	32.01
2	*2462.00	102.9 AV			1.00 V	252	70.89	32.01
3	2483.50	59.3 PK	74.0	-14.7	1.00 V	253	27.21	32.09
4	2483.50	48.5 AV	54.0	-5.5	1.00 V	253	16.41	32.09
5	4924.00	56.2 PK	74.0	-17.8	1.00 V	260	16.53	39.67
<b>6</b>	<b>4924.00</b>	<b>53.5 AV</b>	<b>54.0</b>	<b>-0.5</b>	<b>1.00 V</b>	<b>260</b>	<b>13.83</b>	<b>39.67</b>
7	7386.00	52.3 PK	74.0	-21.7	1.02 V	257	5.50	46.80
8	7386.00	40.4 AV	54.0	-13.6	1.02 V	257	-6.40	46.80

- REMARKS:**
1. Emission level (dBuV/m) = Raw Value (dBuV) + Correction Factor (dB/m).
  2. Correction Factor (dB/m) = Antenna Factor (dB/m) + Cable Factor (dB).
  3. The other emission levels were very low against the limit.
  4. Margin value = Emission level – Limit value.
  5. “ \* “: Fundamental frequency.

RESTRICTED BANDEDGE (802.11b MODE, CH1, HORIZONTAL )

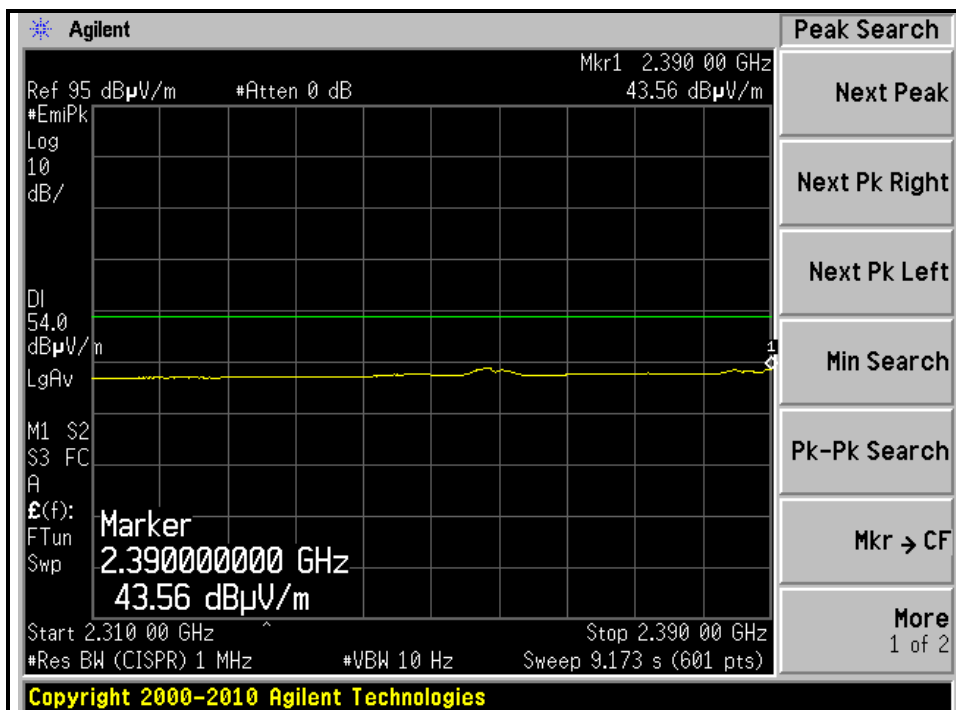
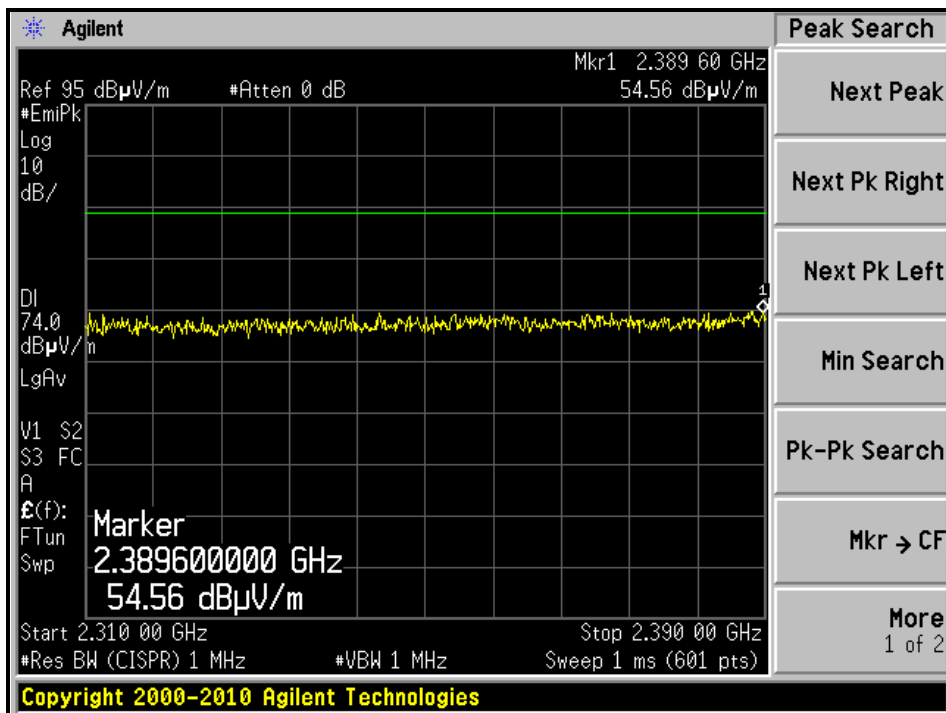



A D T

RESTRICTED BANDEDGE (802.11b MODE, CH1, VERTICAL )

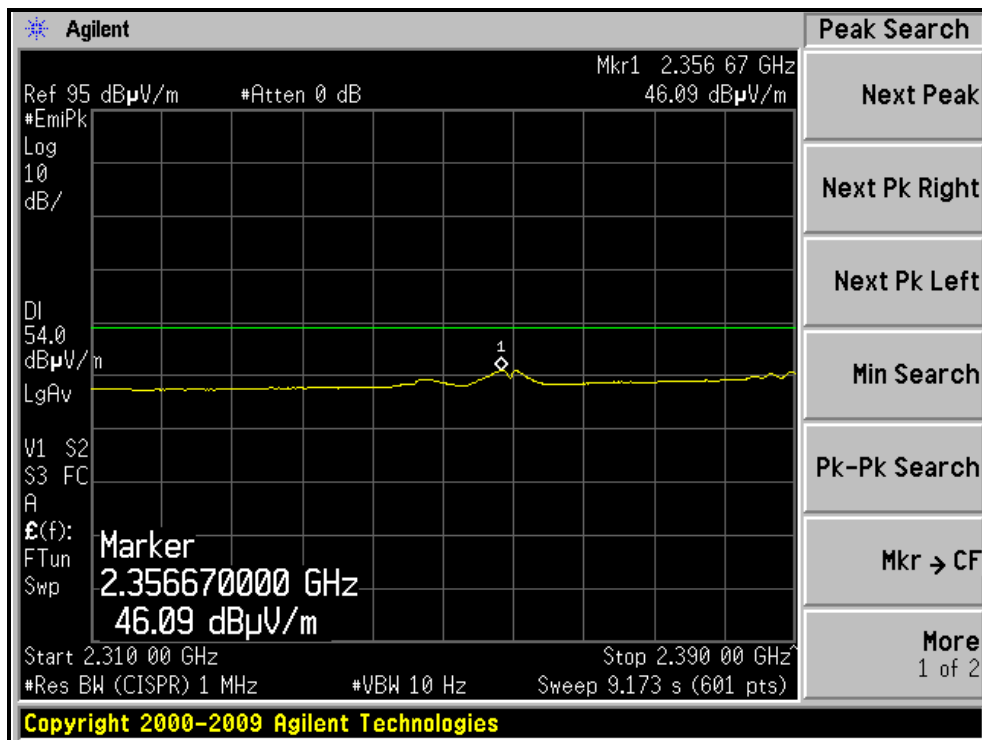
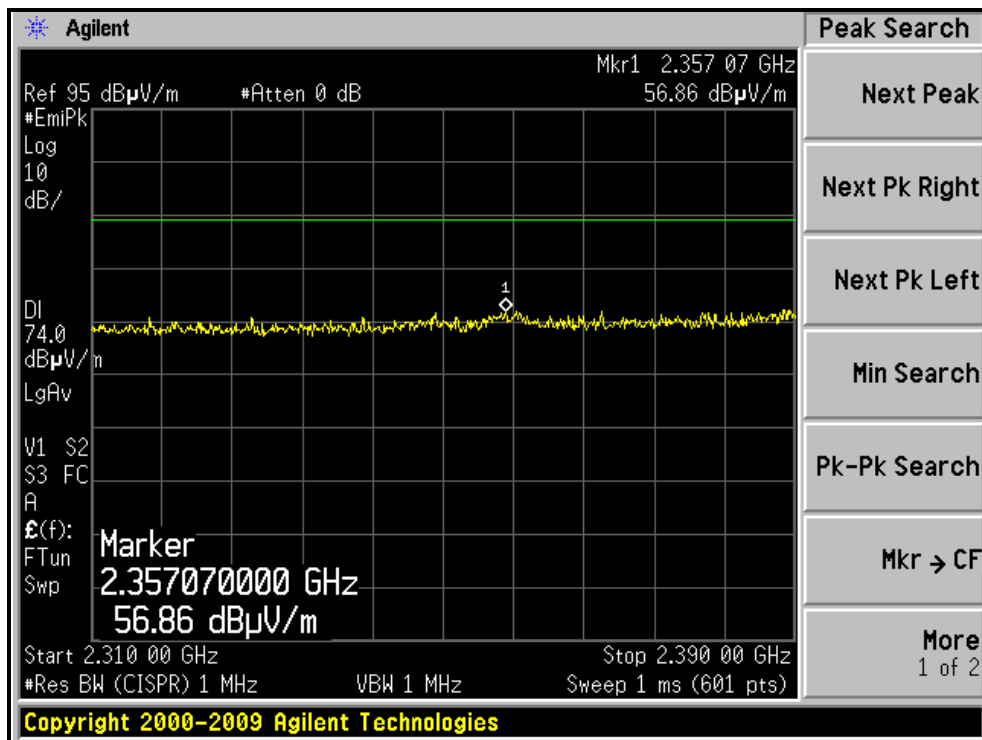



A D T

RESTRICTED BANDEDGE (802.11b MODE, CH11, HORIZONTAL )

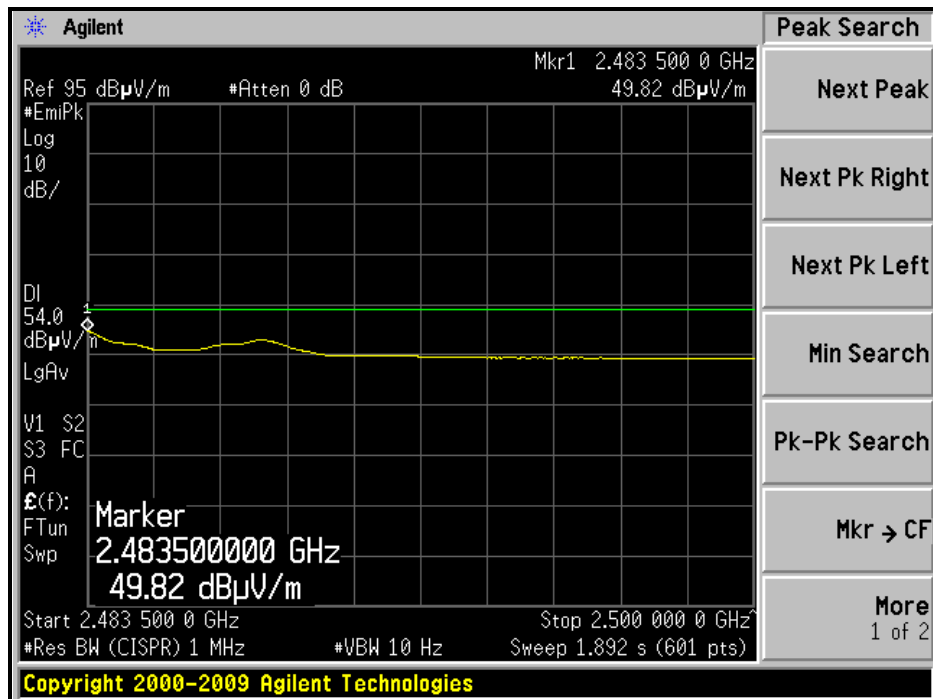
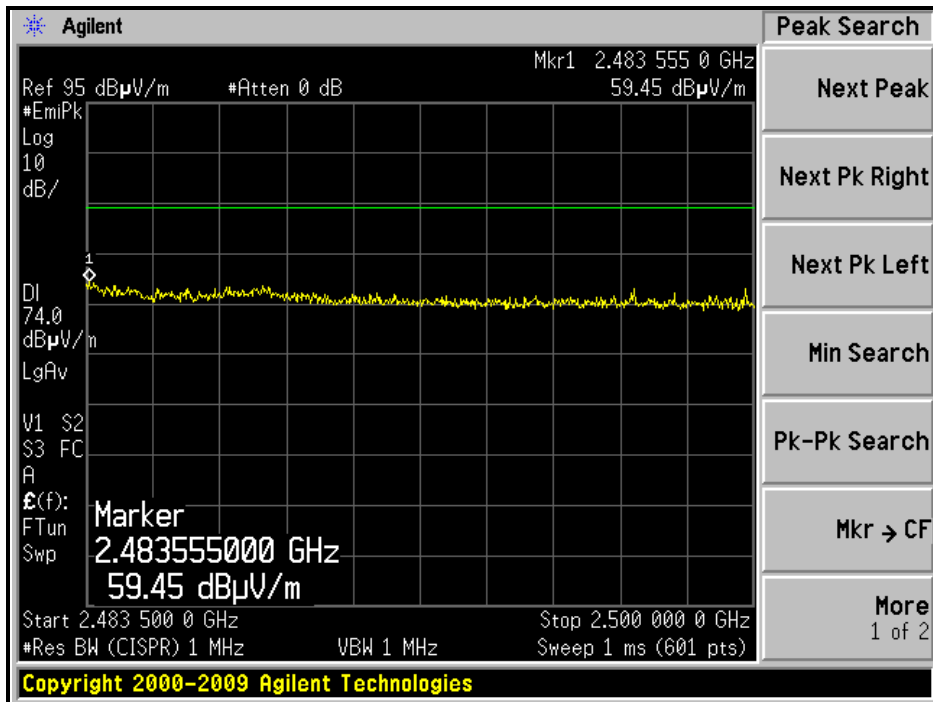



A D T

### RESTRICTED BANDEDGE (802.11b MODE, CH11, VERTICAL)

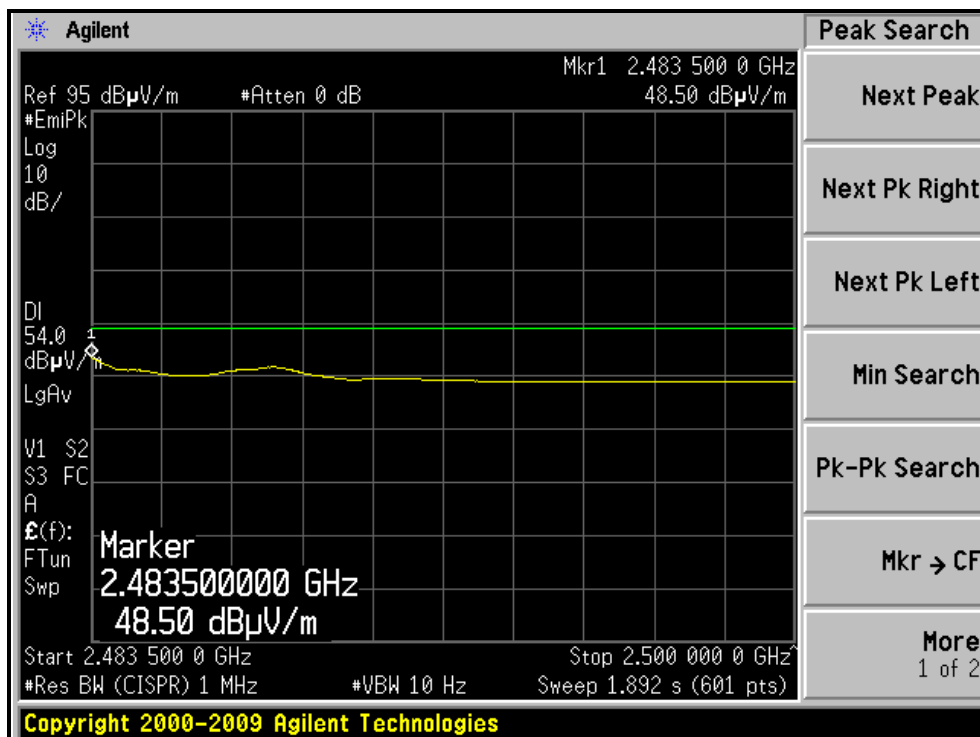
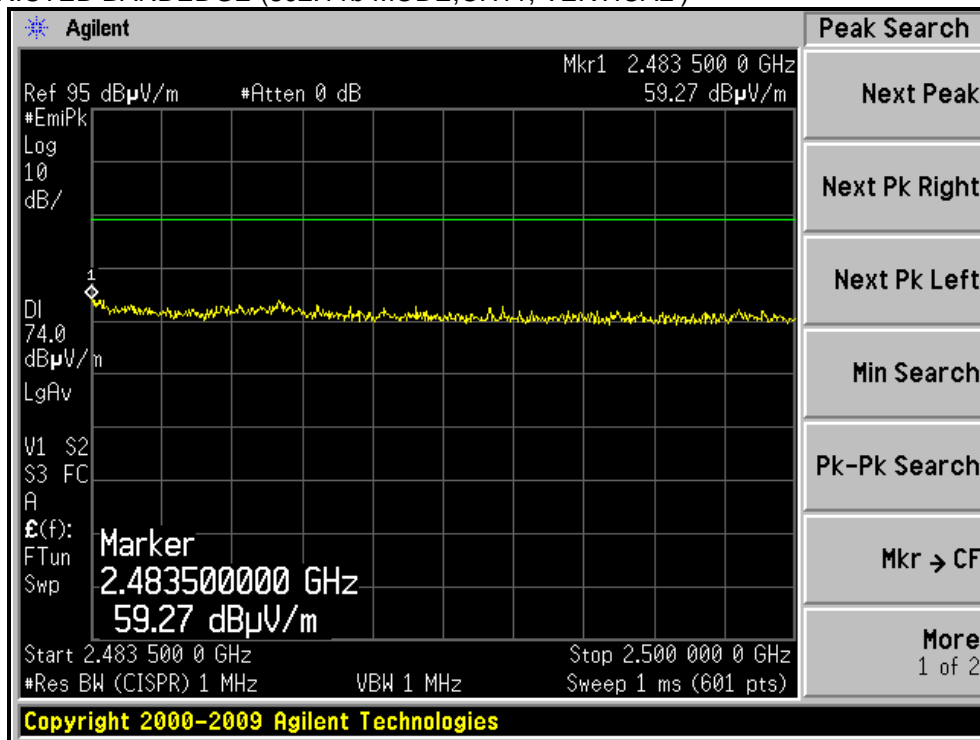



A D T

802.11g OFDM MODULATION

EUT TEST CONDITION		MEASUREMENT DETAIL	
CHANNEL	Channel 1	FREQUENCY RANGE	1 ~ 25GHz
INPUT POWER (SYSTEM)	120Vac, 60 Hz	DETECTOR FUNCTION	Peak (PK) Average (AV)
ENVIRONMENTAL CONDITIONS	25deg. C, 69%RH	TESTED BY	Nelson Teng

ANTENNA POLARITY & TEST DISTANCE: HORIZONTAL AT 3 M

NO.	FREQ. (MHz)	EMISSION LEVEL (dBuV/m)	LIMIT (dBuV/m)	MARGIN (dB)	ANTENNA HEIGHT (m)	TABLE ANGLE (Degree)	RAW VALUE (dBuV)	CORRECTION FACTOR (dB/m)
1	2390.00	67.4 PK	74.0	-6.6	1.13 H	352	35.65	31.75
2	2390.00	53.1 AV	54.0	-0.9	1.13 H	352	21.35	31.75
3	*2412.00	108.1 PK			1.00 H	248	76.28	31.82
4	*2412.00	98.1 AV			1.00 H	248	66.28	31.82
5	4824.00	46.2 PK	74.0	-27.8	1.00 H	254	6.84	39.36
6	4824.00	33.1 AV	54.0	-20.9	1.00 H	254	-6.26	39.36

ANTENNA POLARITY & TEST DISTANCE: VERTICAL AT 3 M

NO.	FREQ. (MHz)	EMISSION LEVEL (dBuV/m)	LIMIT (dBuV/m)	MARGIN (dB)	ANTENNA HEIGHT (m)	TABLE ANGLE (Degree)	RAW VALUE (dBuV)	CORRECTION FACTOR (dB/m)
1	2390.00	69.2 PK	74.0	-4.8	1.00 V	255	37.45	31.75
2	2390.00	52.1 AV	54.0	-1.9	1.00 V	255	20.35	31.75
3	*2412.00	107.0 PK			1.17 V	334	75.18	31.82
4	*2412.00	96.7 AV			1.17 V	334	64.88	31.82
5	4824.00	45.7 PK	74.0	-28.3	1.14 V	329	6.34	39.36
6	4824.00	33.2 AV	54.0	-20.8	1.14 V	329	-6.16	39.36

- REMARKS:**
1. Emission level (dBuV/m) = Raw Value (dBuV) + Correction Factor (dB/m).
  2. Correction Factor (dB/m) = Antenna Factor (dB/m) + Cable Factor (dB).
  3. The other emission levels were very low against the limit.
  4. Margin value = Emission level – Limit value.
  5. “ \* “: Fundamental frequency.



A D T

EUT TEST CONDITION		MEASUREMENT DETAIL	
CHANNEL	Channel 6	FREQUENCY RANGE	1 ~ 25GHz
INPUT POWER (SYSTEM)	120Vac, 60 Hz	DETECTOR FUNCTION	Peak (PK) Average (AV)
ENVIRONMENTAL CONDITIONS	25deg. C, 69%RH	TESTED BY	Nelson Teng

**ANTENNA POLARITY & TEST DISTANCE: HORIZONTAL AT 3 M**

NO.	FREQ. (MHz)	EMISSION LEVEL (dBuV/m)	LIMIT (dBuV/m)	MARGIN (dB)	ANTENNA HEIGHT (m)	TABLE ANGLE (Degree)	RAW VALUE (dBuV)	CORRECTION FACTOR (dB/m)
1	2384.60	60.5 PK	74.0	-13.5	1.00 H	254	28.77	31.73
2	2384.60	49.5 AV	54.0	-4.5	1.00 H	254	17.77	31.73
3	*2437.00	110.5 PK			1.00 H	248	78.58	31.92
4	*2437.00	100.5 AV			1.00 H	248	68.58	31.92
5	2489.30	70.1 PK	74.0	-3.9	1.00 H	274	37.99	32.11
6	2489.30	52.6 AV	54.0	-1.4	1.00 H	274	20.49	32.11
7	4874.00	47.7 PK	74.0	-26.3	1.00 H	252	8.20	39.50
8	4874.00	34.5 AV	54.0	-19.5	1.00 H	252	-5.00	39.50
9	7311.00	53.5 PK	74.0	-20.5	1.04 H	243	6.62	46.88
10	7311.00	39.7 AV	54.0	-14.3	1.04 H	243	-7.18	46.88

**ANTENNA POLARITY & TEST DISTANCE: VERTICAL AT 3 M**

NO.	FREQ. (MHz)	EMISSION LEVEL (dBuV/m)	LIMIT (dBuV/m)	MARGIN (dB)	ANTENNA HEIGHT (m)	TABLE ANGLE (Degree)	RAW VALUE (dBuV)	CORRECTION FACTOR (dB/m)
1	*2437.00	109.9 PK			1.00 V	250	77.98	31.92
2	*2437.00	99.7 AV			1.00 V	250	67.08	31.92
3	4874.00	60.1 PK	74.0	-13.9	1.00 V	250	20.60	39.50
4	4874.00	46.7 AV	54.0	-7.3	1.00 V	250	7.20	39.50
5	7311.00	51.5 PK	74.0	-22.5	1.00 V	235	4.62	46.88
6	7311.00	40.0 AV	54.0	-14.0	1.00 V	235	-6.88	46.88

- REMARKS:**
1. Emission level (dBuV/m) = Raw Value (dBuV) + Correction Factor (dB/m).
  2. Correction Factor (dB/m) = Antenna Factor (dB/m) + Cable Factor (dB).
  3. The other emission levels were very low against the limit.
  4. Margin value = Emission level – Limit value.
  5. “ \* “: Fundamental frequency.





A D T

EUT TEST CONDITION		MEASUREMENT DETAIL	
CHANNEL	Channel 11	FREQUENCY RANGE	1 ~ 25GHz
INPUT POWER (SYSTEM)	120Vac, 60 Hz	DETECTOR FUNCTION	Peak (PK) Average (AV)
ENVIRONMENTAL CONDITIONS	25deg. C, 69%RH	TESTED BY	Nelson Teng

ANTENNA POLARITY & TEST DISTANCE: HORIZONTAL AT 3 M								
NO.	FREQ. (MHz)	EMISSION LEVEL (dBuV/m)	LIMIT (dBuV/m)	MARGIN (dB)	ANTENNA HEIGHT (m)	TABLE ANGLE (Degree)	RAW VALUE (dBuV)	CORRECTION FACTOR (dB/m)
1	*2462.00	106.0 PK			1.00 H	264	73.99	32.01
2	*2462.00	96.3 AV			1.00 H	264	64.29	32.01
3	2483.50	72.2 PK	74.0	-1.8	1.00 H	274	40.11	32.09
4	2483.50	53.1 AV	54.0	-0.9	1.00 H	274	21.01	32.09
5	4924.00	46.5 PK	74.0	-27.5	1.04 H	245	6.83	39.67
6	4924.00	33.9 AV	54.0	-20.1	1.04 H	245	-5.77	39.67
7	7386.00	52.6 PK	74.0	-21.4	1.08 H	249	5.80	46.80
8	7386.00	40.0 AV	54.0	-14.0	1.08 H	249	-6.80	46.80

ANTENNA POLARITY & TEST DISTANCE: VERTICAL AT 3 M								
NO.	FREQ. (MHz)	EMISSION LEVEL (dBuV/m)	LIMIT (dBuV/m)	MARGIN (dB)	ANTENNA HEIGHT (m)	TABLE ANGLE (Degree)	RAW VALUE (dBuV)	CORRECTION FACTOR (dB/m)
1	*2462.00	105.6 PK			1.00 V	252	73.59	32.01
2	*2462.00	94.9 AV			1.00 V	252	62.89	32.01
3	2483.50	72.7 PK	74.0	-1.3	1.00 V	251	40.61	32.09
4	2483.50	51.3 AV	54.0	-2.7	1.00 V	251	19.21	32.09
5	4924.00	46.8 PK	74.0	-27.2	1.01 V	265	7.13	39.67
6	4924.00	33.8 AV	54.0	-20.2	1.01 V	265	-5.87	39.67

- REMARKS:**
1. Emission level (dBuV/m) = Raw Value (dBuV) + Correction Factor (dB/m).
  2. Correction Factor (dB/m) = Antenna Factor (dB/m) + Cable Factor (dB).
  3. The other emission levels were very low against the limit.
  4. Margin value = Emission level – Limit value.
  5. “ \* “: Fundamental frequency.



A D T

RESTRICTED BANDEDGE (802.11g MODE, CH1, HORIZONTAL )

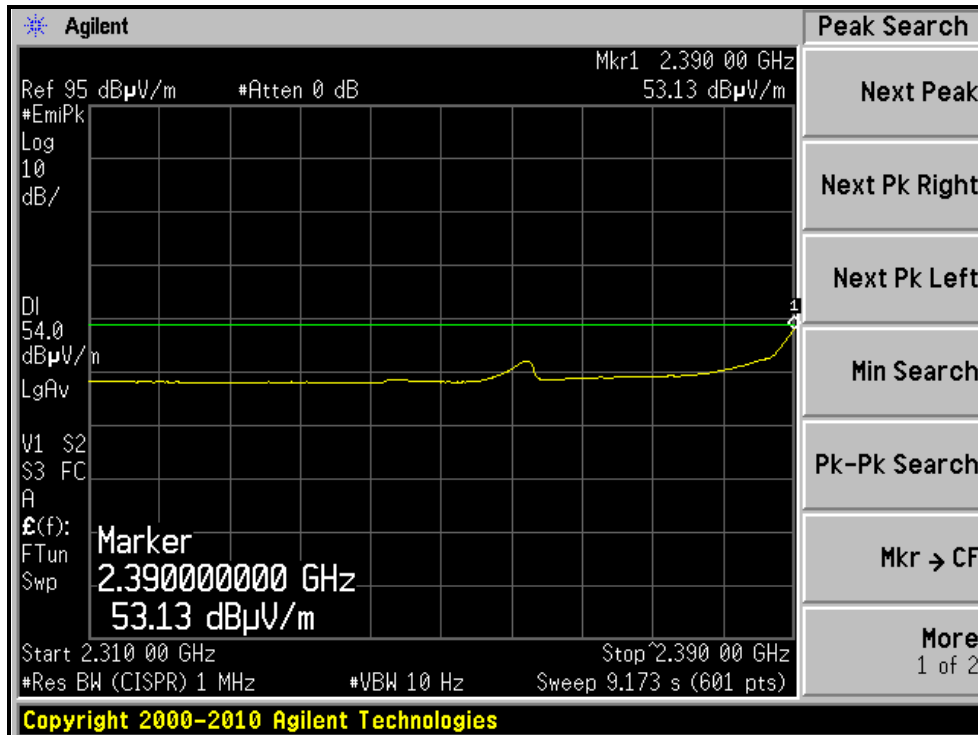
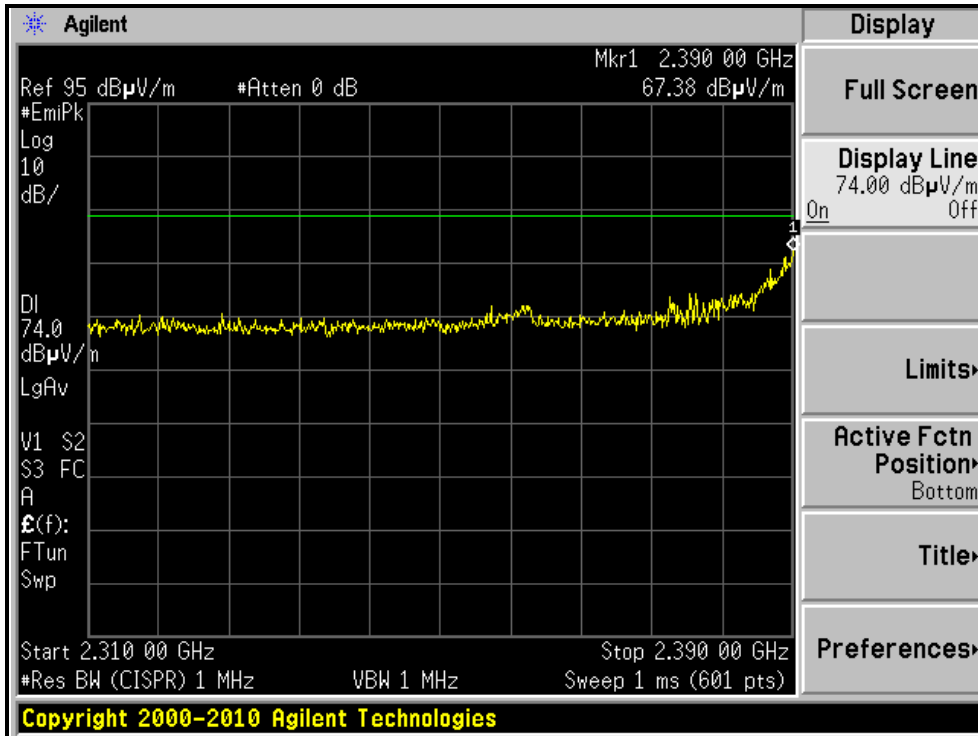



A D T

RESTRICTED BANDEDGE (802.11g MODE,CH1, VERTICAL )

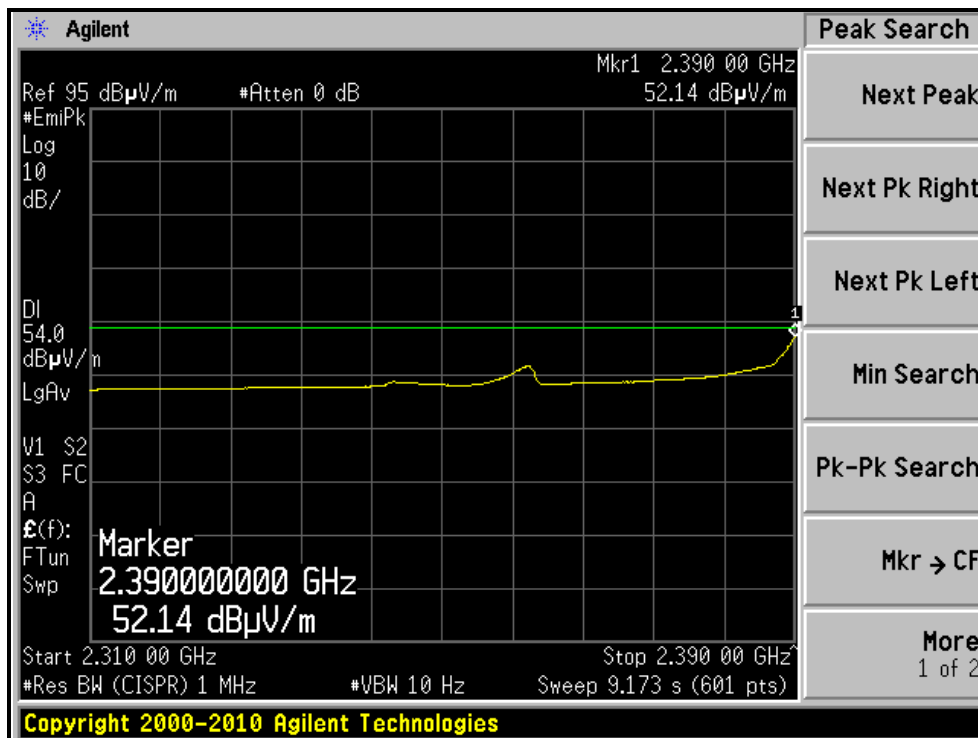
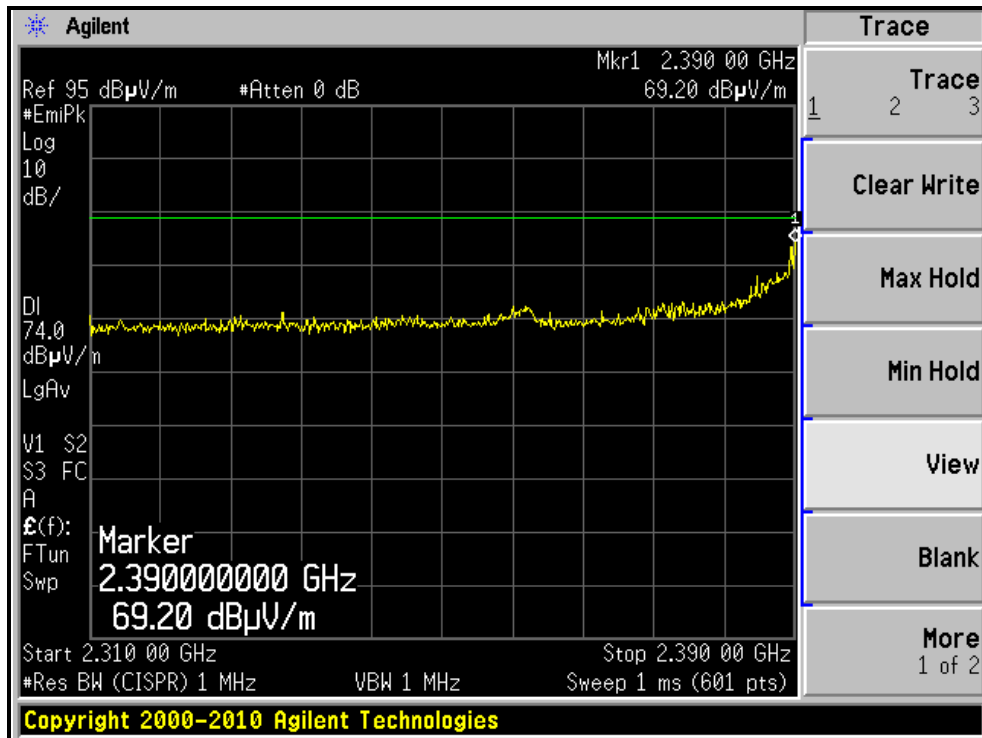



A D T

RESTRICTED BANDEDGE (802.11g MODE, CH11, HORIZONTAL )

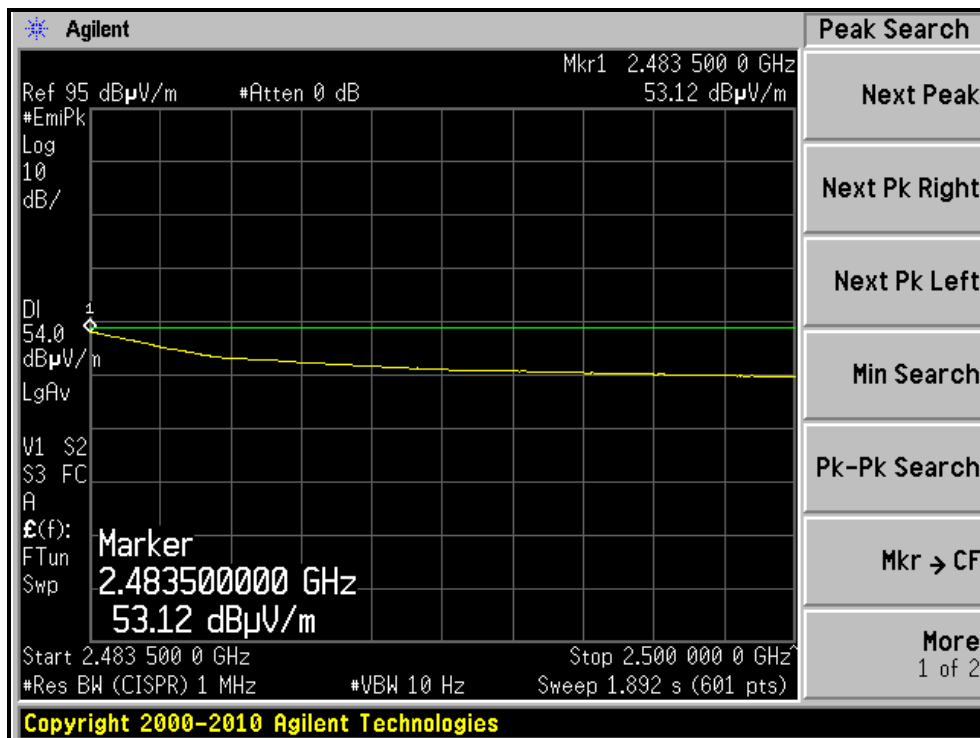
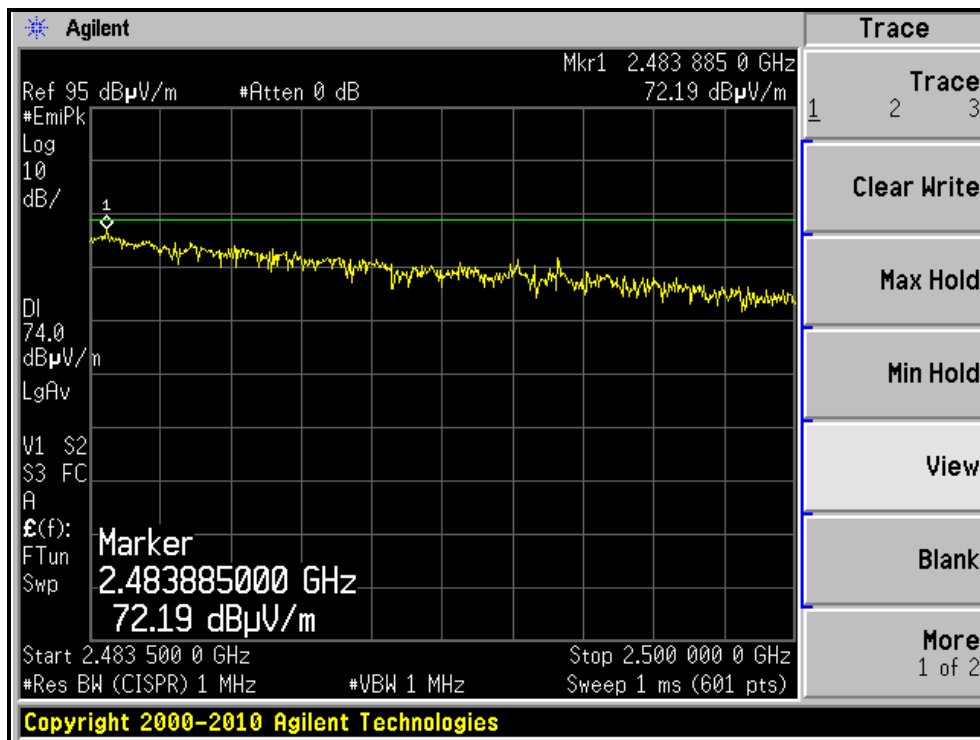

RESTRICTED BANDEDGE (802.11g MODE, CH11, VERTICAL )

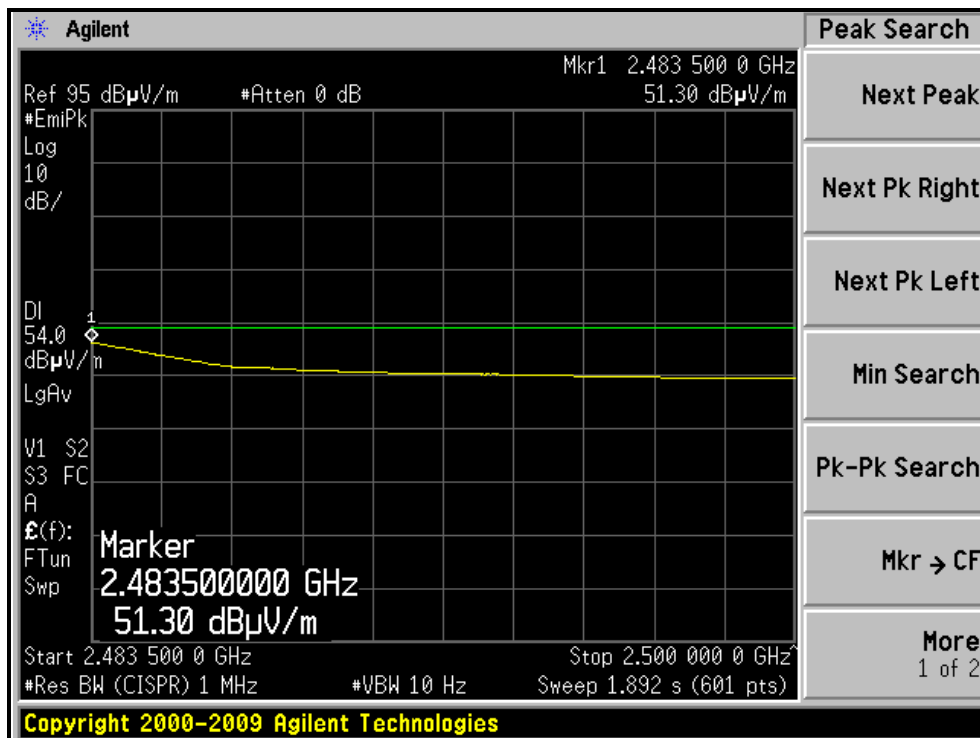
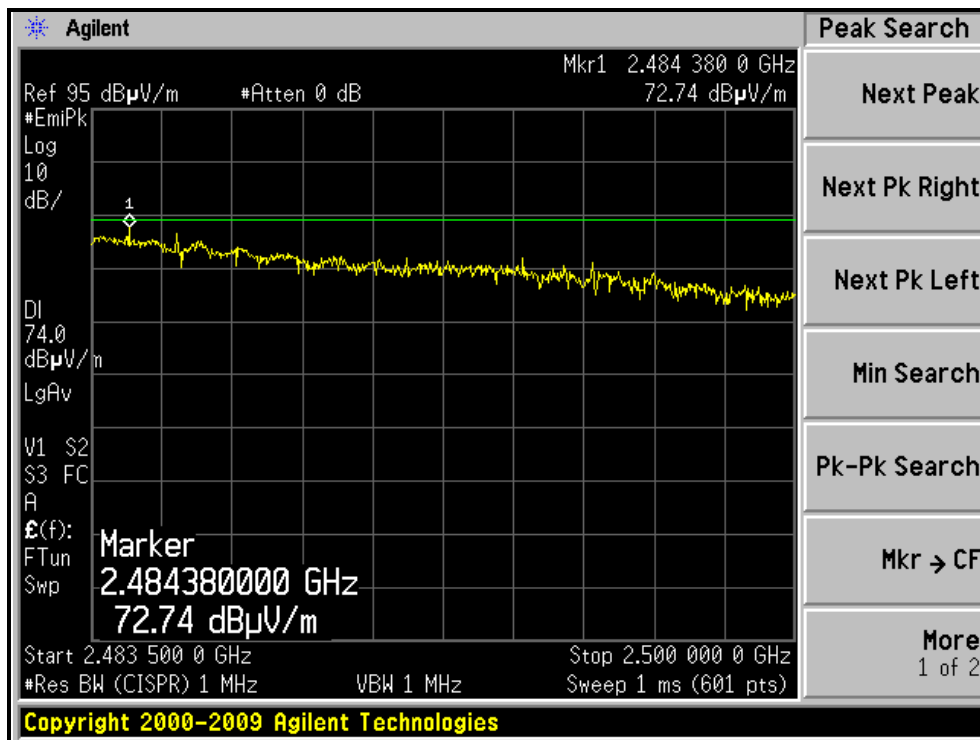



A D T

**802.11n (20MHz) OFDM MODULATION**

EUT TEST CONDITION		MEASUREMENT DETAIL	
CHANNEL	Channel 1	FREQUENCY RANGE	1 ~ 25GHz
INPUT POWER (SYSTEM)	120Vac, 60 Hz	DETECTOR FUNCTION	Peak (PK) Average (AV)
ENVIRONMENTAL CONDITIONS	25deg. C, 69%RH	TESTED BY	Nelson Teng

ANTENNA POLARITY & TEST DISTANCE: HORIZONTAL AT 3 M								
NO.	FREQ. (MHz)	EMISSION LEVEL (dBuV/m)	LIMIT (dBuV/m)	MARGIN (dB)	ANTENNA HEIGHT (m)	TABLE ANGLE (Degree)	RAW VALUE (dBuV)	CORRECTION FACTOR (dB/m)
1	2390.00	69.8 PK	74.0	-4.2	1.00 H	116	38.05	31.75
2	2390.00	52.9 AV	54.0	-1.1	1.00 H	116	21.15	31.75
3	*2412.00	109.6 PK			1.00 H	117	77.78	31.82
4	*2412.00	98.7 AV			1.00 H	117	66.88	31.82
5	4824.00	45.0 PK	74.0	-29.0	1.10 H	253	5.64	39.36
6	4824.00	33.1 AV	54.0	-20.9	1.10 H	253	-6.26	39.36
ANTENNA POLARITY & TEST DISTANCE: VERTICAL AT 3 M								
NO.	FREQ. (MHz)	EMISSION LEVEL (dBuV/m)	LIMIT (dBuV/m)	MARGIN (dB)	ANTENNA HEIGHT (m)	TABLE ANGLE (Degree)	RAW VALUE (dBuV)	CORRECTION FACTOR (dB/m)
1	2389.87	66.3 PK	74.0	-7.7	1.00 V	252	34.55	31.75
2	2389.87	49.5 AV	54.0	-4.5	1.00 V	252	17.75	31.75
3	*2412.00	108.5 PK			1.00 V	276	76.68	31.82
4	*2412.00	97.3 AV			1.00 V	276	65.48	31.82
5	4824.00	47.1 PK	74.0	-26.9	1.03 V	249	7.74	39.36
6	4824.00	34.9 AV	54.0	-19.1	1.03 V	249	-4.46	39.36

- REMARKS:**
1. Emission level (dBuV/m) = Raw Value (dBuV) + Correction Factor (dB/m).
  2. Correction Factor (dB/m) = Antenna Factor (dB/m) + Cable Factor (dB).
  3. The other emission levels were very low against the limit.
  4. Margin value = Emission level – Limit value.
  5. “ \* “: Fundamental frequency.



A D T

EUT TEST CONDITION		MEASUREMENT DETAIL	
CHANNEL	Channel 6	FREQUENCY RANGE	1 ~ 25GHz
INPUT POWER (SYSTEM)	120Vac, 60 Hz	DETECTOR FUNCTION	Peak (PK) Average (AV)
ENVIRONMENTAL CONDITIONS	25deg. C, 69%RH	TESTED BY	Nelson Teng

ANTENNA POLARITY & TEST DISTANCE: HORIZONTAL AT 3 M								
NO.	FREQ. (MHz)	EMISSION LEVEL (dBuV/m)	LIMIT (dBuV/m)	MARGIN (dB)	ANTENNA HEIGHT (m)	TABLE ANGLE (Degree)	RAW VALUE (dBuV)	CORRECTION FACTOR (dB/m)
1	*2437.00	110.6 PK			1.00 H	117	78.68	31.92
2	*2437.00	99.9 AV			1.00 H	117	67.98	31.92
3	2484.90	60.6 PK	74.0	-13.4	1.00 H	118	28.51	32.09
4	2484.90	50.4 AV	54.0	-3.6	1.00 H	118	18.31	32.09
5	2488.70	65.5 PK	74.0	-8.5	1.00 H	118	33.39	32.11
6	2488.70	51.1 AV	54.0	-2.9	1.00 H	118	18.99	32.11
7	4874.00	46.4 PK	74.0	-27.6	1.03 H	235	6.90	39.50
8	4874.00	34.7 AV	54.0	-19.3	1.03 H	235	-4.80	39.50
9	7311.00	52.1 PK	74.0	-21.9	1.01 H	260	5.22	46.88
10	7311.00	40.6 AV	54.0	-13.4	1.01 H	260	-6.28	46.88
ANTENNA POLARITY & TEST DISTANCE: VERTICAL AT 3 M								
NO.	FREQ. (MHz)	EMISSION LEVEL (dBuV/m)	LIMIT (dBuV/m)	MARGIN (dB)	ANTENNA HEIGHT (m)	TABLE ANGLE (Degree)	RAW VALUE (dBuV)	CORRECTION FACTOR (dB/m)
1	*2437.00	110.0 PK			1.00 V	251	78.08	31.92
2	*2437.00	98.8 AV			1.00 V	251	66.88	31.92
3	4874.00	50.1 PK	74.0	-23.9	1.04 V	259	10.60	39.50
4	4874.00	37.3 AV	54.0	-16.7	1.04 V	259	-2.20	39.50
5	7311.00	52.3 PK	74.0	-21.7	1.04 V	251	5.42	46.88
6	7311.00	40.5 AV	54.0	-13.5	1.04 V	251	-6.38	46.88

- REMARKS:**
1. Emission level (dBuV/m) = Raw Value (dBuV) + Correction Factor (dB/m).
  2. Correction Factor (dB/m) = Antenna Factor (dB/m) + Cable Factor (dB).
  3. The other emission levels were very low against the limit.
  4. Margin value = Emission level – Limit value.
  5. “ \* “: Fundamental frequency.



A D T

EUT TEST CONDITION		MEASUREMENT DETAIL	
CHANNEL	Channel 11	FREQUENCY RANGE	1 ~ 25GHz
INPUT POWER (SYSTEM)	120Vac, 60 Hz	DETECTOR FUNCTION	Peak (PK) Average (AV)
ENVIRONMENTAL CONDITIONS	25deg. C, 69%RH	TESTED BY	Nelson Teng

ANTENNA POLARITY & TEST DISTANCE: HORIZONTAL AT 3 M								
NO.	FREQ. (MHz)	EMISSION LEVEL (dBuV/m)	LIMIT (dBuV/m)	MARGIN (dB)	ANTENNA HEIGHT (m)	TABLE ANGLE (Degree)	RAW VALUE (dBuV)	CORRECTION FACTOR (dB/m)
1	*2462.00	107.8 PK			1.00 H	117	75.79	32.01
2	*2462.00	96.7 AV			1.00 H	117	64.69	32.01
3	2483.50	71.2 PK	74.0	-2.8	1.00 H	115	39.11	32.09
4	2483.50	52.2 AV	54.0	-1.8	1.00 H	115	20.11	32.09
5	4924.00	44.4 PK	74.0	-29.6	1.08 H	254	4.73	39.67
6	4924.00	32.5 AV	54.0	-21.5	1.08 H	254	-7.17	39.67
7	7386.00	51.9 PK	74.0	-22.1	1.00 H	276	5.10	46.80
8	7386.00	40.3 AV	54.0	-13.7	1.00 H	276	-6.50	46.80

ANTENNA POLARITY & TEST DISTANCE: VERTICAL AT 3 M								
NO.	FREQ. (MHz)	EMISSION LEVEL (dBuV/m)	LIMIT (dBuV/m)	MARGIN (dB)	ANTENNA HEIGHT (m)	TABLE ANGLE (Degree)	RAW VALUE (dBuV)	CORRECTION FACTOR (dB/m)
1	*2462.00	108.9 PK			1.00 V	266	76.89	32.01
2	*2462.00	98.2 AV			1.00 V	266	66.19	32.01
3	2483.50	70.7 PK	74.0	-3.3	1.00 V	246	38.61	32.09
4	2483.50	51.1 AV	54.0	-2.9	1.00 V	246	19.01	32.09
5	4924.00	47.5 PK	74.0	-26.5	1.02 V	264	7.83	39.67
6	4924.00	35.2 AV	54.0	-18.8	1.02 V	264	-4.47	39.67
7	7386.00	52.6 PK	74.0	-21.4	1.04 V	282	5.80	46.80
8	7386.00	40.5 AV	54.0	-13.5	1.04 V	282	-6.30	46.80

- REMARKS:**
1. Emission level (dBuV/m) = Raw Value (dBuV) + Correction Factor (dB/m).
  2. Correction Factor (dB/m) = Antenna Factor (dB/m) + Cable Factor (dB).
  3. The other emission levels were very low against the limit.
  4. Margin value = Emission level – Limit value.
  5. “ \* “: Fundamental frequency.





A D T

RESTRICTED BANDEDGE (802.11n (20MHz) MODE,CH1, HORIZONTAL )

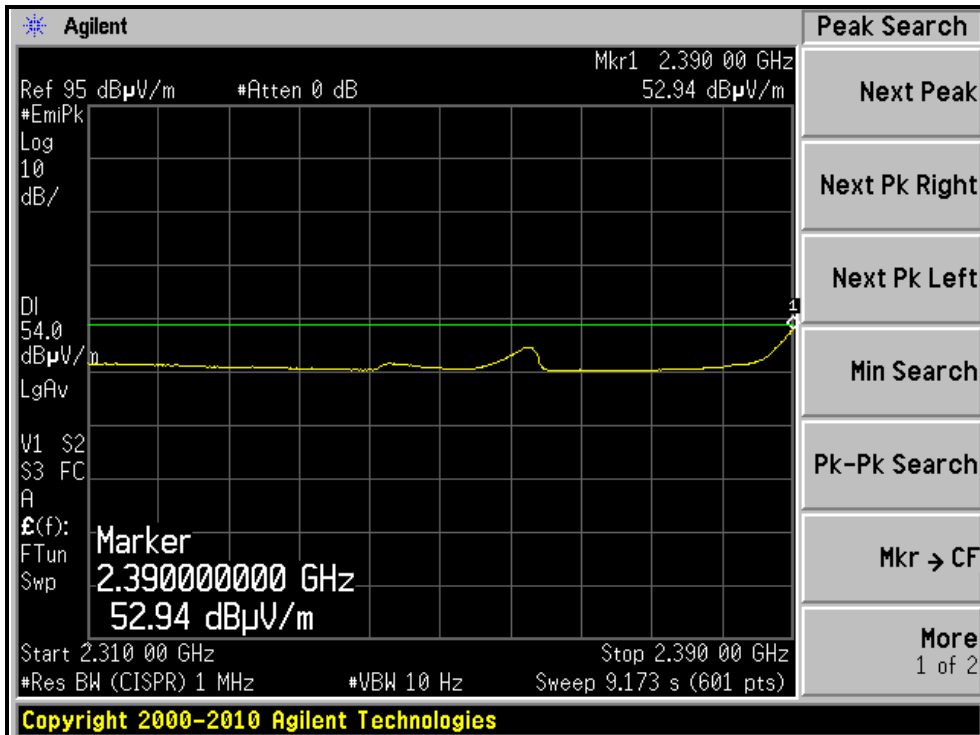
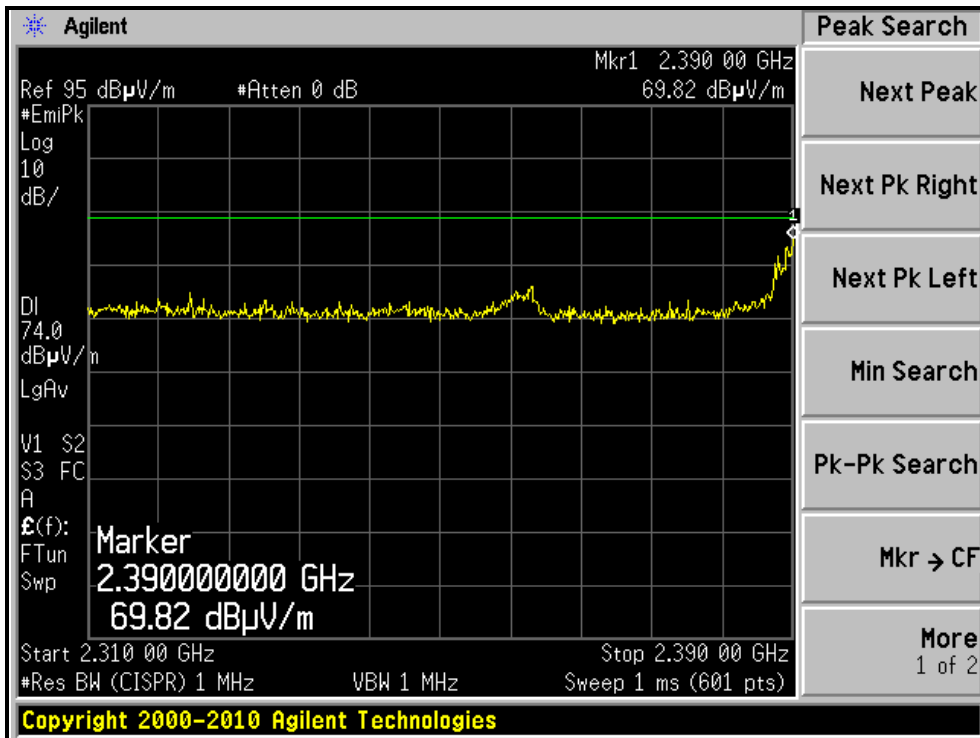

RESTRICTED BANDEDGE (802.11n (20MHz) MODE,CH1, VERTICAL )

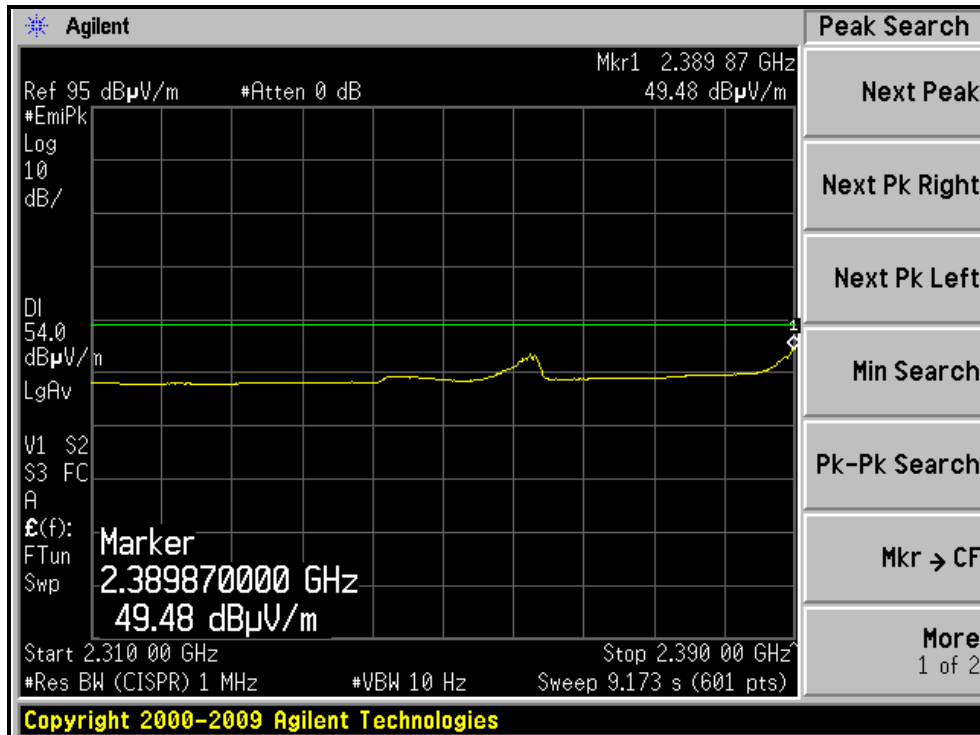
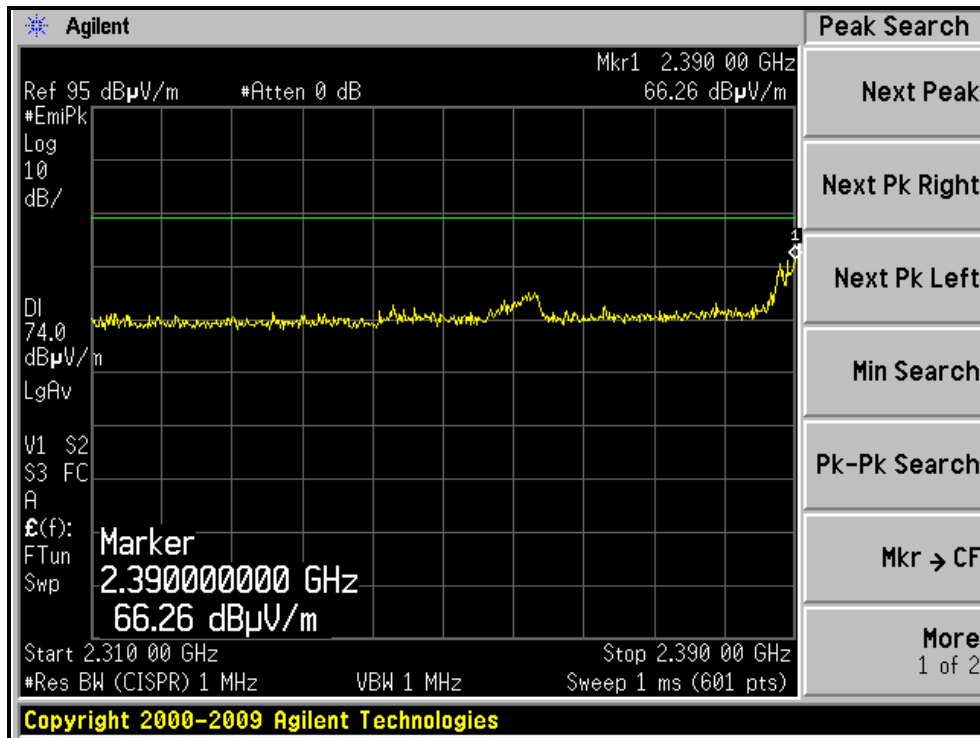



A D T

RESTRICTED BANDEDGE (802.11n (20MHz) MODE,CH11, HORIZONTAL )

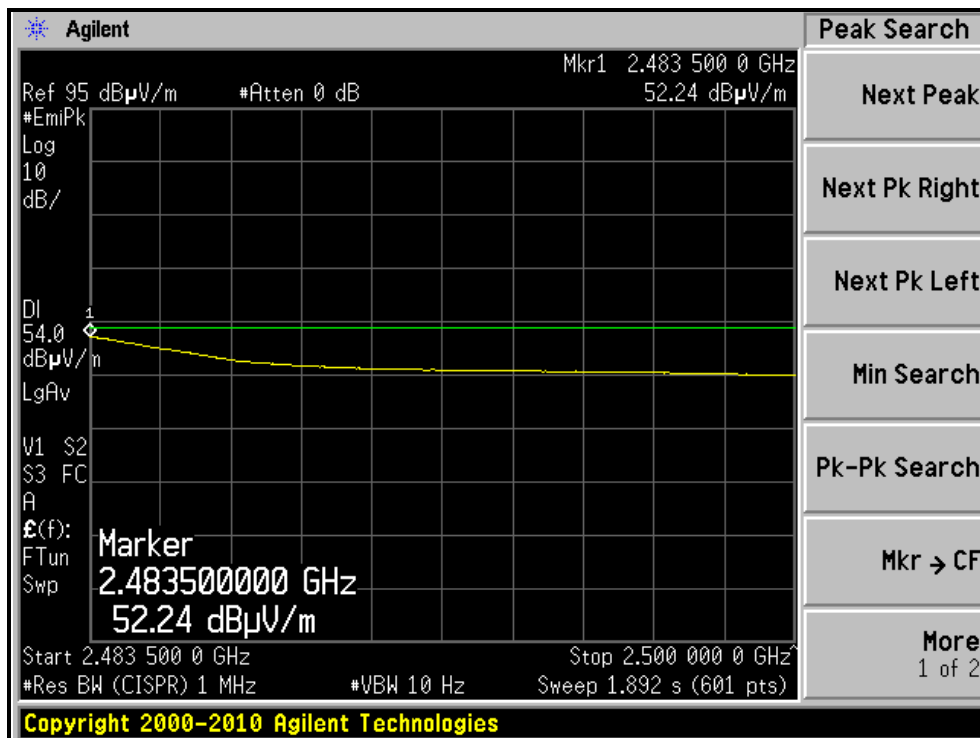
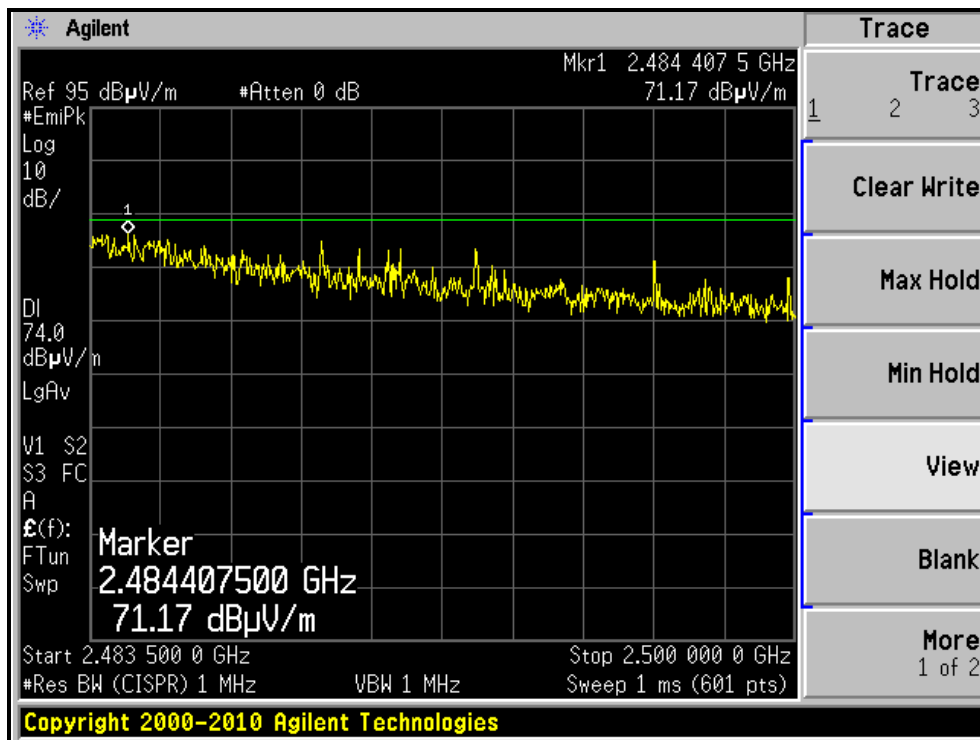

RESTRICTED BANDEDGE (802.11n (20MHz) MODE,CH11, VERTICAL )

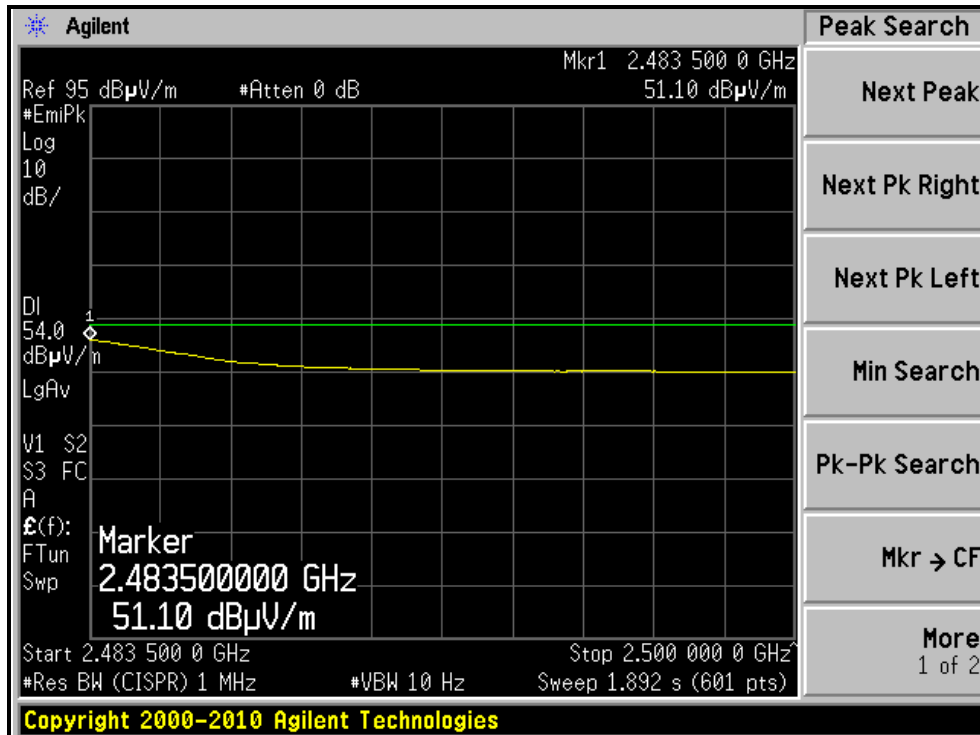
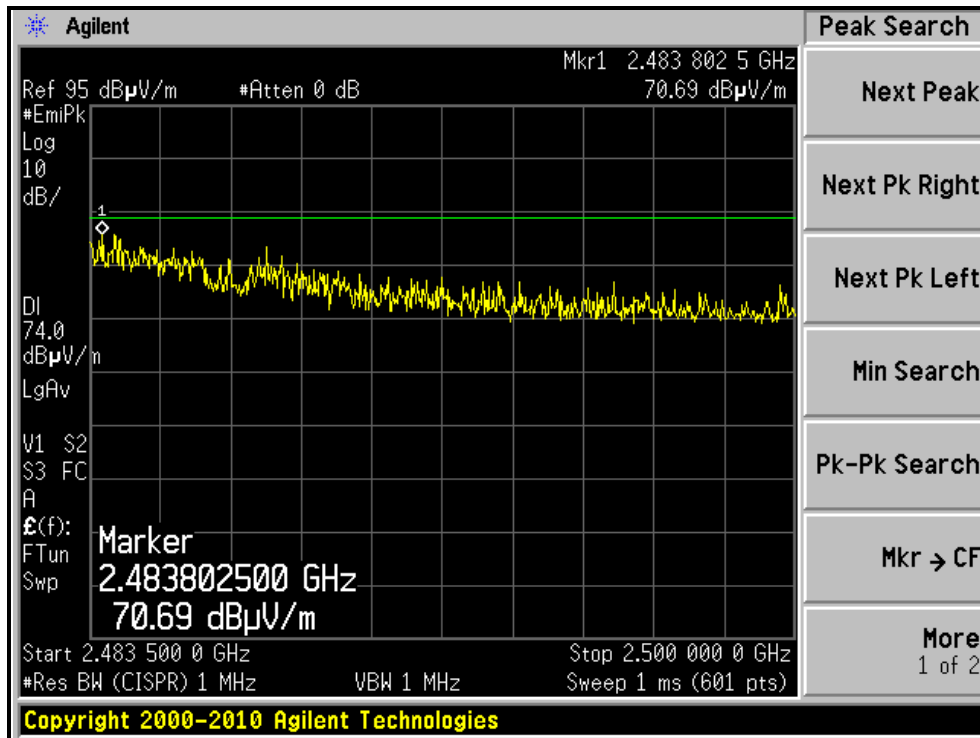



A D T

**802.11n (40MHz) OFDM MODULATION**

EUT TEST CONDITION		MEASUREMENT DETAIL	
CHANNEL	Channel 3	FREQUENCY RANGE	1 ~ 25GHz
INPUT POWER (SYSTEM)	120Vac, 60 Hz	DETECTOR FUNCTION	Peak (PK) Average (AV)
ENVIRONMENTAL CONDITIONS	25deg. C, 69%RH	TESTED BY	Nelson Teng

ANTENNA POLARITY & TEST DISTANCE: HORIZONTAL AT 3 M								
NO.	FREQ. (MHz)	EMISSION LEVEL (dBuV/m)	LIMIT (dBuV/m)	MARGIN (dB)	ANTENNA HEIGHT (m)	TABLE ANGLE (Degree)	RAW VALUE (dBuV)	CORRECTION FACTOR (dB/m)
1	2389.60	69.7 PK	74.0	-4.3	1.00 H	116	37.95	31.75
2	2389.60	53.2 AV	54.0	-0.8	1.00 H	116	21.45	31.75
3	*2422.00	104.6 PK			1.00 H	118	72.74	31.86
4	*2422.00	93.5 AV			1.00 H	118	61.64	31.86
5	4844.00	44.8 PK	74.0	-29.2	1.10 H	244	5.38	39.42
6	4844.00	32.9 AV	54.0	-21.1	1.10 H	244	-6.52	39.42
7	7266.00	52.0 PK	74.0	-22.0	1.00 H	269	5.09	46.91
8	7266.00	40.3 AV	54.0	-13.7	1.00 H	269	-6.61	46.91
ANTENNA POLARITY & TEST DISTANCE: VERTICAL AT 3 M								
NO.	FREQ. (MHz)	EMISSION LEVEL (dBuV/m)	LIMIT (dBuV/m)	MARGIN (dB)	ANTENNA HEIGHT (m)	TABLE ANGLE (Degree)	RAW VALUE (dBuV)	CORRECTION FACTOR (dB/m)
1	2389.60	67.5 PK	74.0	-6.5	1.00 V	294	35.75	31.75
2	2389.60	50.2 AV	54.0	-3.8	1.00 V	294	18.45	31.75
3	*2422.00	104.0 PK			1.00 V	278	72.14	31.86
4	*2422.00	94.7 AV			1.00 V	278	62.84	31.86
5	4844.00	47.5 PK	74.0	-26.5	1.02 V	262	8.08	39.42
6	4844.00	35.1 AV	54.0	-18.9	1.02 V	262	-4.32	39.42
7	7266.00	52.4 PK	74.0	-21.6	1.00 V	266	5.49	46.91
8	7266.00	40.4 AV	54.0	-13.6	1.00 V	266	-6.51	46.91

- REMARKS:**
1. Emission level (dBuV/m) = Raw Value (dBuV) + Correction Factor (dB/m).
  2. Correction Factor (dB/m) = Antenna Factor (dB/m) + Cable Factor (dB).
  3. The other emission levels were very low against the limit.
  4. Margin value = Emission level – Limit value.
  5. “ \* “: Fundamental frequency.



A D T

EUT TEST CONDITION		MEASUREMENT DETAIL	
CHANNEL	Channel 6	FREQUENCY RANGE	1 ~ 25GHz
INPUT POWER (SYSTEM)	120Vac, 60 Hz	DETECTOR FUNCTION	Peak (PK) Average (AV)
ENVIRONMENTAL CONDITIONS	25deg. C, 69%RH	TESTED BY	Nelson Teng

ANTENNA POLARITY & TEST DISTANCE: HORIZONTAL AT 3 M								
NO.	FREQ. (MHz)	EMISSION LEVEL (dBuV/m)	LIMIT (dBuV/m)	MARGIN (dB)	ANTENNA HEIGHT (m)	TABLE ANGLE (Degree)	RAW VALUE (dBuV)	CORRECTION FACTOR (dB/m)
1	*2437.00	105.2 PK			1.00 H	115	73.28	31.92
2	*2437.00	94.0 AV			1.00 H	115	62.08	31.92
3	2483.50	73.5 PK	74.0	-0.5	1.00 H	113	41.41	32.09
4	2483.50	53.4 AV	54.0	-0.6	1.00 H	113	21.31	32.09
5	4874.00	47.1 PK	74.0	-26.9	1.00 H	249	7.60	39.50
6	4874.00	35.1 AV	54.0	-18.9	1.00 H	249	-4.40	39.50
7	7311.00	51.8 PK	74.0	-22.2	1.00 H	262	4.92	46.88
8	7311.00	40.1 AV	54.0	-13.9	1.00 H	262	-6.78	46.88
ANTENNA POLARITY & TEST DISTANCE: VERTICAL AT 3 M								
NO.	FREQ. (MHz)	EMISSION LEVEL (dBuV/m)	LIMIT (dBuV/m)	MARGIN (dB)	ANTENNA HEIGHT (m)	TABLE ANGLE (Degree)	RAW VALUE (dBuV)	CORRECTION FACTOR (dB/m)
1	*2437.00	107.4 PK			1.00 V	268	75.48	31.92
2	*2437.00	97.2 AV			1.00 V	268	65.31	31.92
3	4874.00	49.9 PK	74.0	-24.1	1.05 V	264	10.40	39.50
4	4874.00	37.0 AV	54.0	-17.0	1.05 V	264	-2.50	39.50
5	7311.00	51.9 PK	74.0	-22.1	1.01 V	254	5.02	46.88
6	7311.00	40.1 AV	54.0	-13.9	1.01 V	254	-6.78	46.88

- REMARKS:**
1. Emission level (dBuV/m) = Raw Value (dBuV) + Correction Factor (dB/m).
  2. Correction Factor (dB/m) = Antenna Factor (dB/m) + Cable Factor (dB).
  3. The other emission levels were very low against the limit.
  4. Margin value = Emission level – Limit value.
  5. “ \* “: Fundamental frequency.



A D T

EUT TEST CONDITION		MEASUREMENT DETAIL	
CHANNEL	Channel 9	FREQUENCY RANGE	1 ~ 25GHz
INPUT POWER (SYSTEM)	120Vac, 60 Hz	DETECTOR FUNCTION	Peak (PK) Average (AV)
ENVIRONMENTAL CONDITIONS	25deg. C, 69%RH	TESTED BY	Nelson Teng

ANTENNA POLARITY & TEST DISTANCE: HORIZONTAL AT 3 M								
NO.	FREQ. (MHz)	EMISSION LEVEL (dBuV/m)	LIMIT (dBuV/m)	MARGIN (dB)	ANTENNA HEIGHT (m)	TABLE ANGLE (Degree)	RAW VALUE (dBuV)	CORRECTION FACTOR (dB/m)
1	*2452.00	102.6 PK			1.00 H	117	70.63	31.97
2	*2452.00	91.9 AV			1.00 H	117	59.93	31.97
3	2483.50	72.8 PK	74.0	-1.2	1.00 H	116	40.71	32.09
4	2483.50	52.6 AV	54.0	-1.4	1.00 H	116	20.51	32.09
5	4904.00	44.6 PK	74.0	-29.4	1.05 H	243	5.00	39.60
6	4904.00	32.7 AV	54.0	-21.3	1.05 H	243	-6.90	39.60
7	7356.00	51.9 PK	74.0	-22.1	1.00 H	278	5.07	46.83
8	7356.00	40.4 AV	54.0	-13.6	1.00 H	278	-6.43	46.83
ANTENNA POLARITY & TEST DISTANCE: VERTICAL AT 3 M								
NO.	FREQ. (MHz)	EMISSION LEVEL (dBuV/m)	LIMIT (dBuV/m)	MARGIN (dB)	ANTENNA HEIGHT (m)	TABLE ANGLE (Degree)	RAW VALUE (dBuV)	CORRECTION FACTOR (dB/m)
1	*2452.00	102.5 PK			1.00 V	252	70.53	31.97
2	*2452.00	91.4 AV			1.00 V	252	59.43	31.97
3	2483.50	71.8 PK	74.0	-2.2	1.00 V	252	39.71	32.09
4	2483.50	49.6 AV	54.0	-4.4	1.00 V	252	17.51	32.09
5	4904.00	47.1 PK	74.0	-26.9	1.01 V	256	7.50	39.60
6	4904.00	34.8 AV	54.0	-19.2	1.01 V	256	-4.80	39.60
7	7356.00	52.0 PK	74.0	-22.0	1.03 V	269	5.17	46.83
8	7356.00	40.2 AV	54.0	-13.8	1.03 V	269	-6.63	46.83

- REMARKS:**
1. Emission level (dBuV/m) = Raw Value (dBuV) + Correction Factor (dB/m).
  2. Correction Factor (dB/m) = Antenna Factor (dB/m) + Cable Factor (dB).
  3. The other emission levels were very low against the limit.
  4. Margin value = Emission level – Limit value.
  5. “ \* “: Fundamental frequency.



A D T

RESTRICTED BANDEDGE (802.11n (40MHz) MODE,CH3, HORIZONTAL )

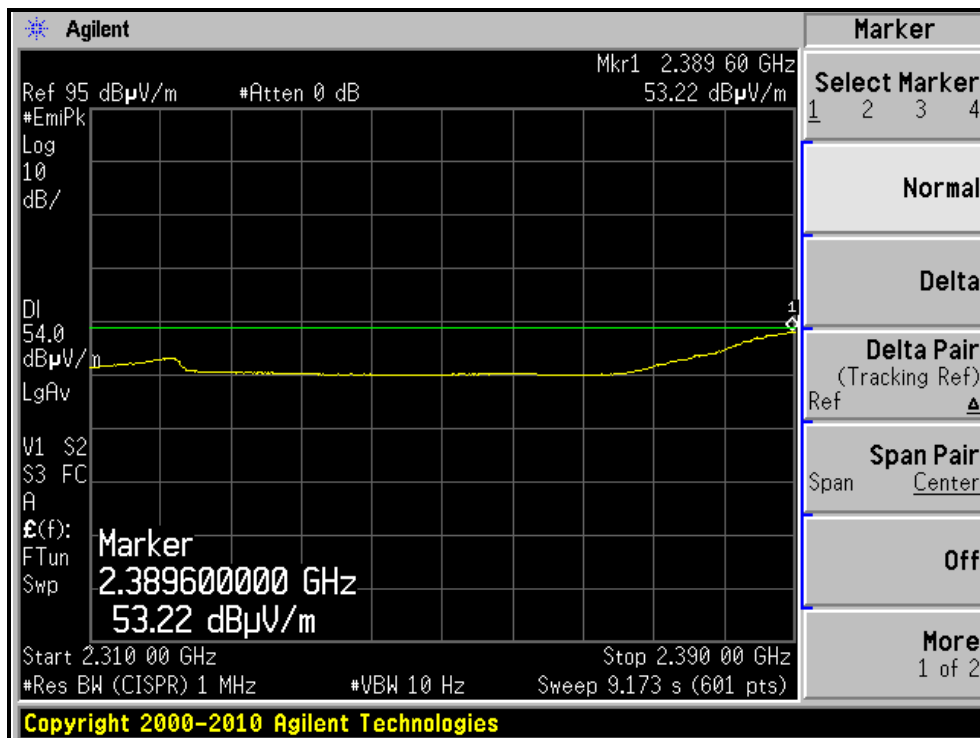
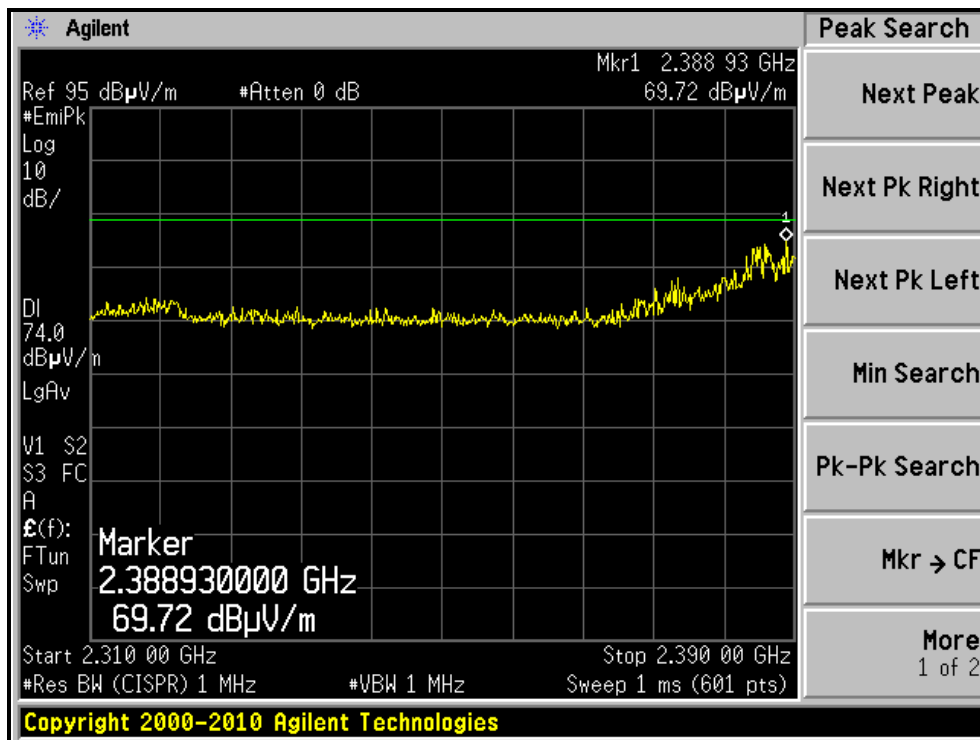





A D T

RESTRICTED BANDEDGE (802.11n (40MHz) MODE,CH3, VERTICAL )

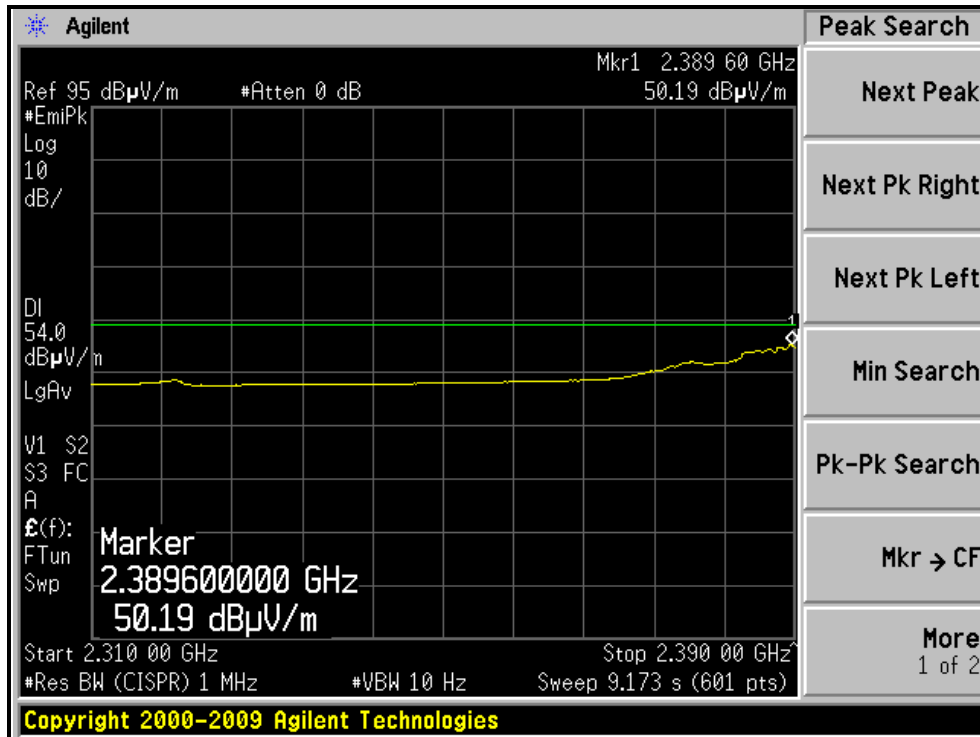
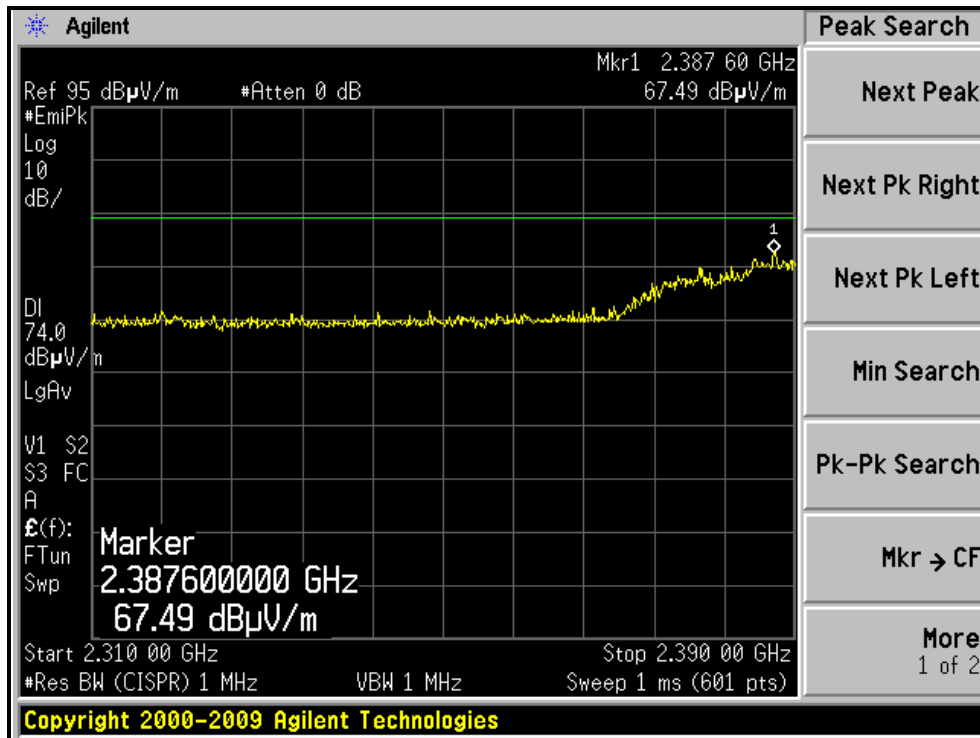

RESTRICTED BANDEDGE (802.11n (40MHz) MODE,CH9, HORIZONTAL )

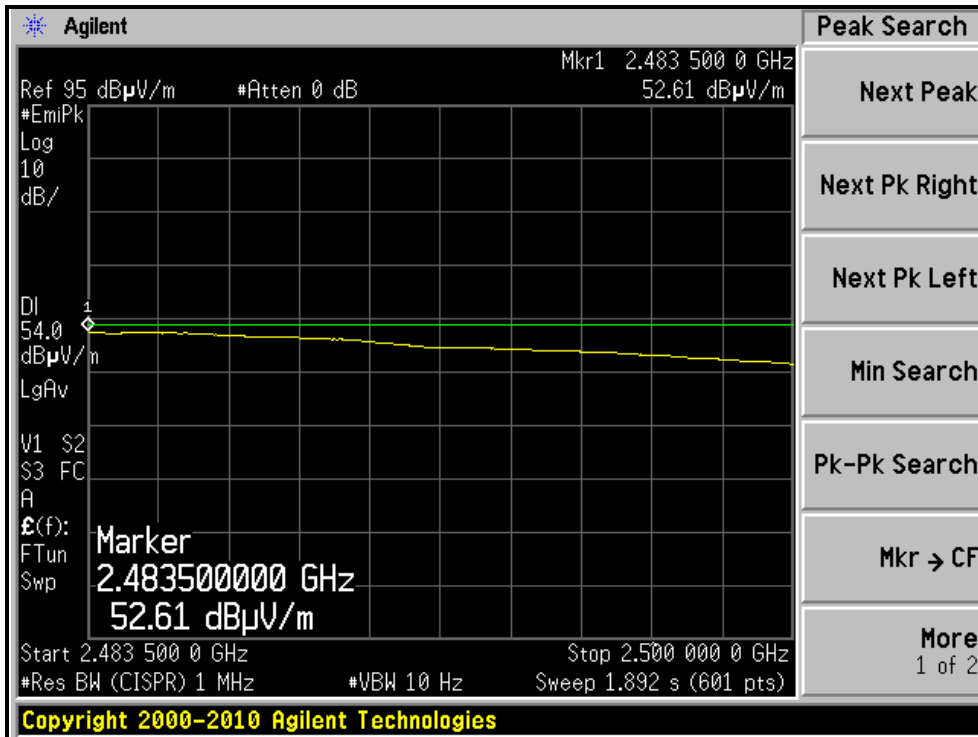
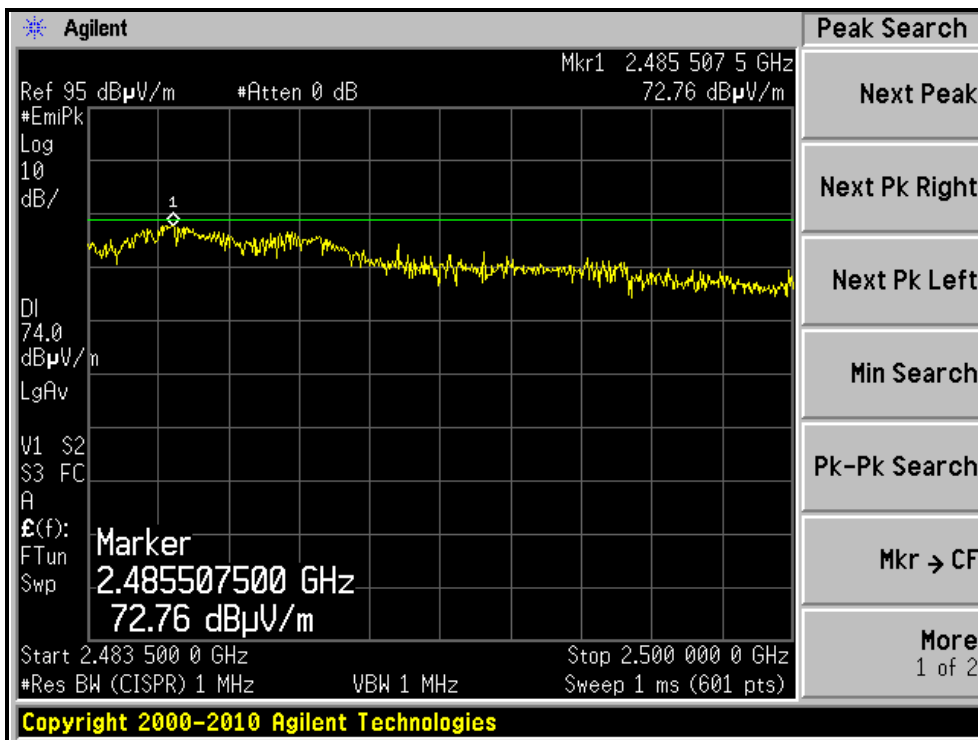

RESTRICTED BANDEDGE (802.11n (40MHz) MODE,CH9, VERTICAL )

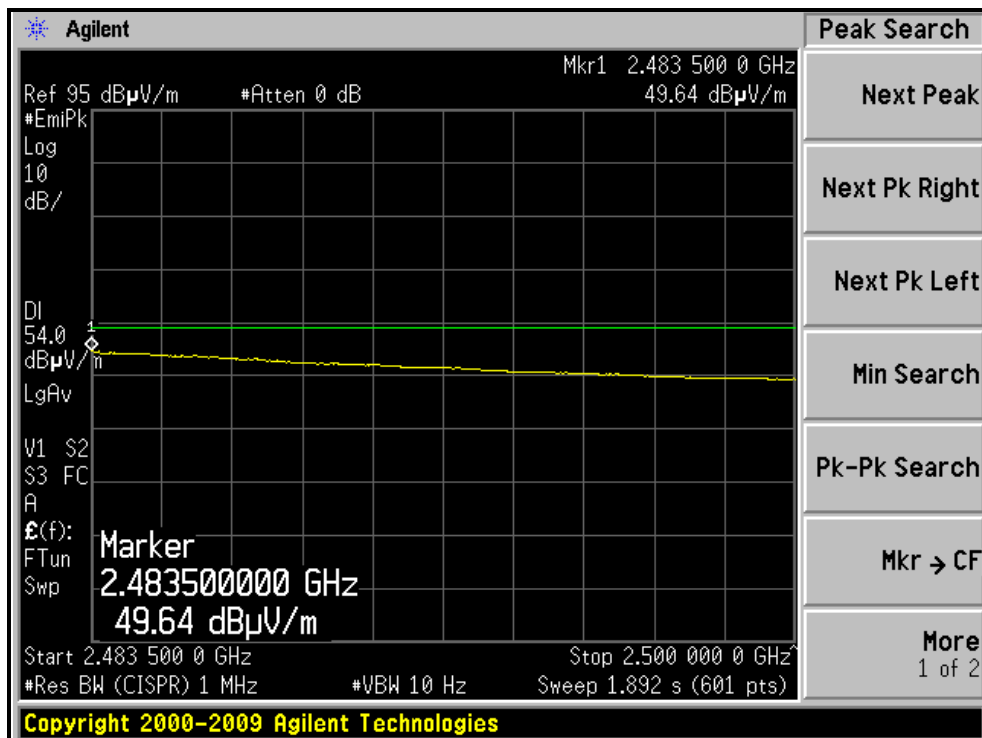
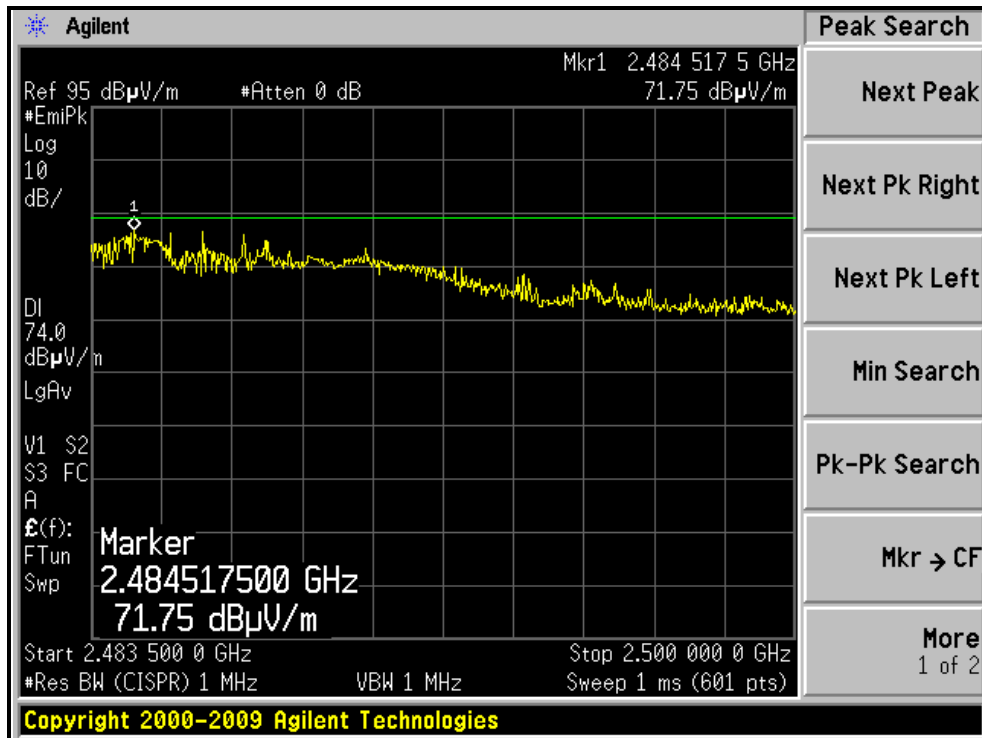

### 4.3 6dB BANDWIDTH MEASUREMENT

#### 4.3.1 LIMITS OF 6dB BANDWIDTH MEASUREMENT

The minimum of 6dB Bandwidth Measurement is 0.5 MHz.

#### 4.3.2 TEST INSTRUMENTS

Test date: Oct. 18, 2011

DESCRIPTION & MANUFACTURER	MODEL NO.	SERIAL NO.	CALIBRATED DATE	CALIBRATED UNTIL
R&S Spectrum Analyzer	FSP40	100036	Dec. 08, 2010	Dec. 07, 2011

**NOTE:** The calibration interval of the above test instruments is 12 months and the calibrations are traceable to NML/ROC and NIST/USA.

#### 4.3.3 TEST PROCEDURE

The transmitter output was connected to the spectrum analyzer through an attenuator. The bandwidth of the fundamental frequency was measured by spectrum analyzer with 100kHz RBW and 300kHz VBW. The 6dB bandwidth is defined as the total spectrum the power of which is higher than peak power minus 6dB.

#### 4.3.4 DEVIATION FROM TEST STANDARD

No deviation

#### 4.3.5 TEST SETUP



#### 4.3.6 EUT OPERATING CONDITIONS

The software provided by client to enable the EUT under transmission condition continuously at lowest, middle and highest channel frequencies individually.

### 4.3.7 TEST RESULTS

#### 802.11b DSSS MODULATION:

CHANNEL	CHANNEL FREQUENCY (MHz)	6dB BANDWIDTH (MHz)	MINIMUM LIMIT (MHz)	PASS / FAIL
1	2412	8.97	0.5	PASS
6	2437	10.49	0.5	PASS
11	2462	10.24	0.5	PASS

CH6

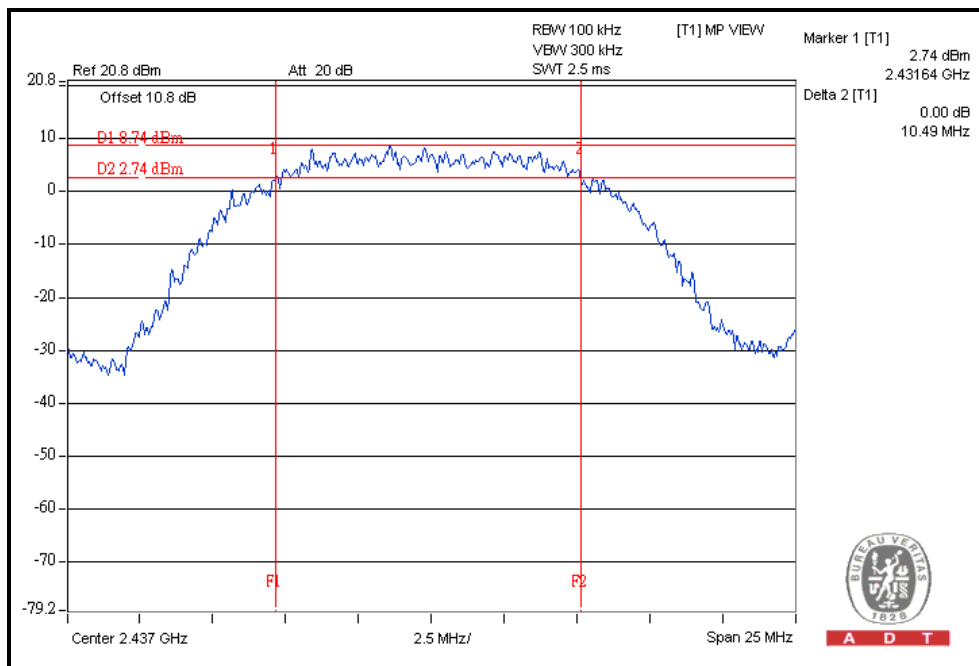

**802.11g OFDM MODULATION:**

CHANNEL	CHANNEL FREQUENCY (MHz)	6dB BANDWIDTH (MHz)	MINIMUM LIMIT (MHz)	PASS / FAIL
1	2412	16.23	0.5	PASS
6	2437	16.32	0.5	PASS
11	2462	16.37	0.5	PASS

**CH11**

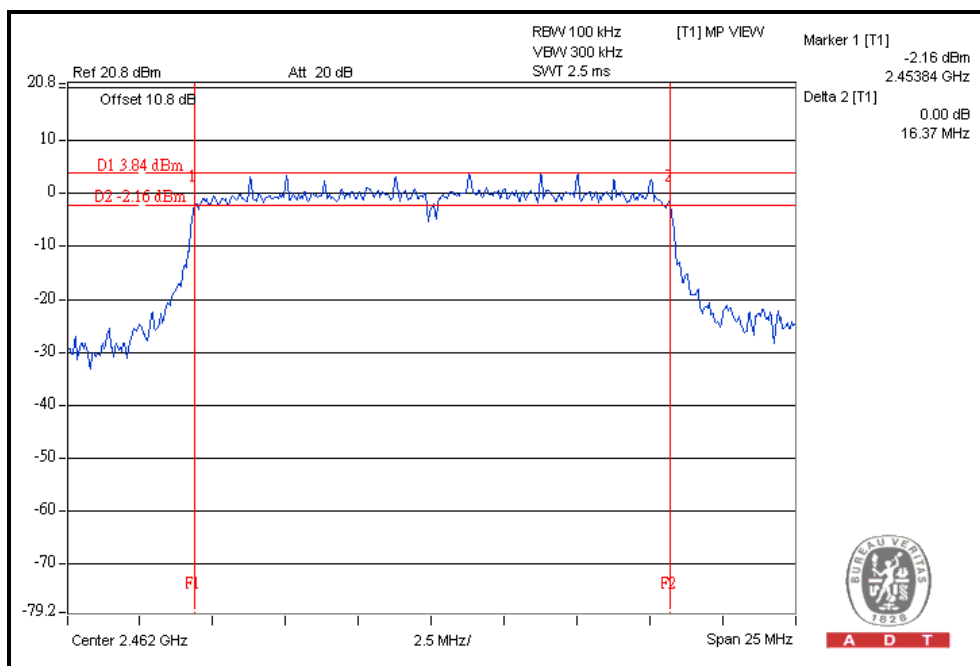

**802.11n (20MHz) OFDM modulation:**

CHANNEL	CHANNEL FREQUENCY (MHz)	6dB BANDWIDTH (MHz)		MINIMUM LIMIT (MHz)	PASS / FAIL
		CHAIN(0)	CHAIN(1)		
1	2412	16.71	17.04	0.5	PASS
6	2437	16.58	16.64	0.5	PASS
11	2462	15.97	16.33	0.5	PASS

For Chain(1) : CH1

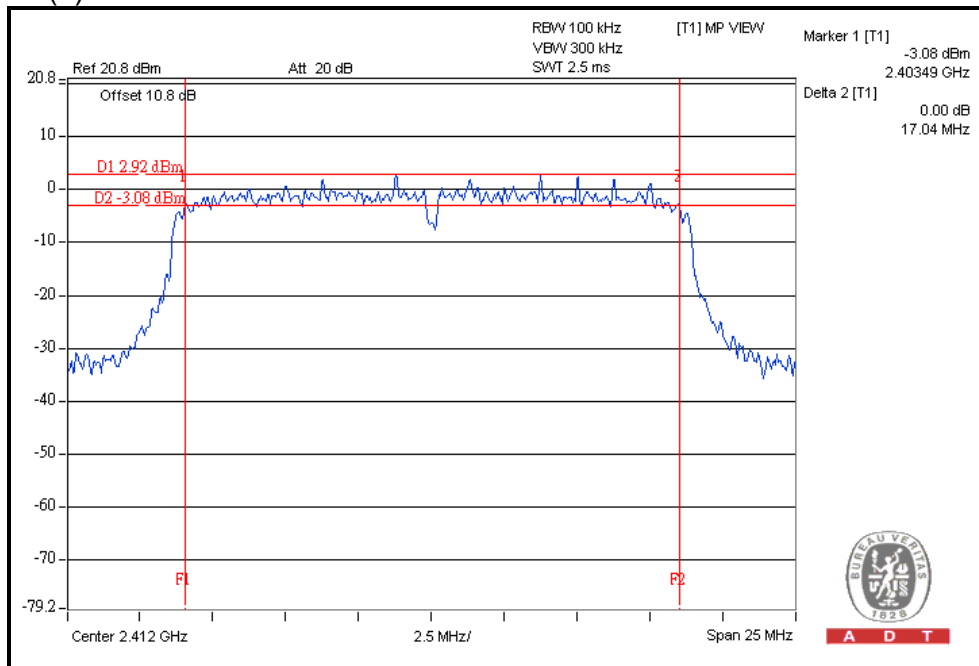

**802.11n (40MHz) OFDM MODULATION:**

CHANNEL	CHANNEL FREQUENCY (MHz)	6dB BANDWIDTH (MHz)		MINIMUM LIMIT (MHz)	PASS / FAIL
		CHAIN(0)	CHAIN(1)		
3	2422	35.46	35.56	0.5	PASS
6	2437	35.51	35.59	0.5	PASS
9	2452	35.48	35.50	0.5	PASS

For Chain(1) : CH6

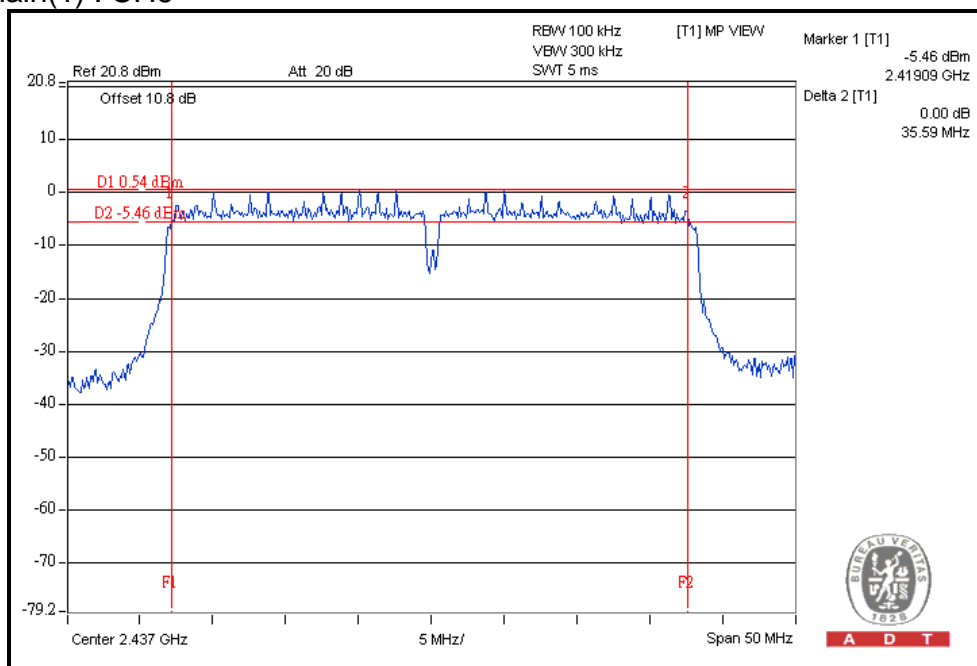



#### 4.4 MAXIMUM PEAK OUTPUT POWER

##### 4.4.1 LIMITS OF MAXIMUM PEAK OUTPUT POWER MEASUREMENT

The Maximum Peak Output Power Measurement is 30dBm.

##### 4.4.2 INSTRUMENTS

Test date: Oct. 18, 2011

DESCRIPTION & MANUFACTURER	MODEL NO.	SERIAL NO.	CALIBRATED DATE	CALIBRATED UNTIL
Peak Power Meter	ML2495A	0824006	May 04, 2011	May 03, 2012
Power Sensor	MA2411B	0738172	May 03, 2011	May 02, 2012

**NOTE:** The calibration interval of the above test instruments is 12 months and the calibrations are traceable to NML/ROC and NIST/USA.

##### 4.4.3 TEST PROCEDURES

1. The transmitter output was connected to the power meter through an attenuator; the bandwidth of the fundamental frequency was measured with the power meter.
2. Record the power level.

##### 4.4.4 DEVIATION FROM TEST STANDARD

No deviation

##### 4.4.5 TEST SETUP

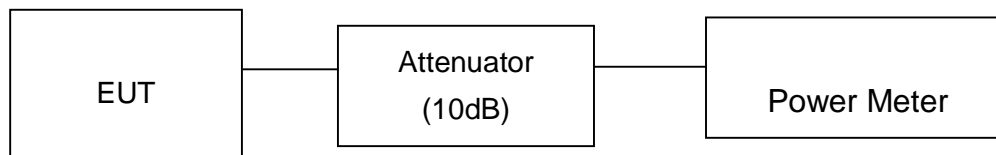

##### 4.4.6 EUT OPERATING CONDITIONS

Same as Item 4.3.6



A D T

#### 4.4.7 TEST RESULTS

##### 802.11b DSSS MODULATION:

CHANNEL	CHANNEL FREQUENCY (MHz)	PEAK POWER OUTPUT (mW)	PEAK POWER OUTPUT (dBm)	PEAK POWER LIMIT (dBm)	PASS/FAIL
1	2412	114.8	20.6	30	PASS
6	2437	114.8	20.6	30	PASS
11	2462	114.8	20.6	30	PASS

##### 802.11g OFDM MODULATION:

CHANNEL	CHANNEL FREQUENCY (MHz)	PEAK POWER OUTPUT (mW)	PEAK POWER OUTPUT (dBm)	PEAK POWER LIMIT (dBm)	PASS/FAIL
1	2412	257.0	24.1	30	PASS
6	2437	263.0	24.2	30	PASS
11	2462	257.0	24.1	30	PASS



A D T

### 802.11n (20MHz) OFDM MODULATION:

CHANNEL	CHANNEL FREQUENCY (MHz)	PEAK POWER OUTPUT (dBm)		TOTAL PEAK POWER (mW)	TOTAL PEAK POWER (dBm)	PEAK POWER LIMIT (dBm)	PASS / FAIL
		CHAIN(0)	CHAIN(1)				
1	2412	23.4	23.5	442.6	26.5	30	PASS
6	2437	25.4	25.6	709.8	28.5	30	PASS
11	2462	23.0	23.1	403.7	26.1	30	PASS

### 802.11n (40MHz) OFDM MODULATION:

CHANNEL	CHANNEL FREQUENCY (MHz)	PEAK POWER OUTPUT (dBm)		TOTAL PEAK POWER (mW)	TOTAL PEAK POWER (dBm)	PEAK POWER LIMIT (dBm)	PASS / FAIL
		CHAIN(0)	CHAIN(1)				
3	2422	20.4	20.6	224.5	23.5	30	PASS
6	2437	22.4	22.6	355.8	25.5	30	PASS
9	2452	20.4	20.9	232.7	23.7	30	PASS

## 4.5 POWER SPECTRAL DENSITY MEASUREMENT

### 4.5.1 LIMITS OF POWER SPECTRAL DENSITY MEASUREMENT

The Maximum of Power Spectral Density Measurement is 8dBm.

### 4.5.2 TEST INSTRUMENTS

Test date: Oct. 18, 2011

DESCRIPTION & MANUFACTURER	MODEL NO.	SERIAL NO.	CALIBRATED DATE	CALIBRATED UNTIL
R&S Spectrum Analyzer	FSP40	100036	Dec. 08, 2010	Dec. 07, 2011

**NOTE:** The calibration interval of the above test instruments is 12 months and the calibrations are traceable to NML/ROC and NIST/USA.

### 4.5.3 TEST PROCEDURE

The transmitter output was connected to the spectrum analyzer through an attenuator, the bandwidth of the fundamental frequency was measured with the spectrum analyzer using 3kHz RBW and 30kHz VBW, set sweep time = span/3kHz. The power spectral density was measured and recorded. The sweep time is allowed to be longer than span/3kHz for a full response of the mixer in the spectrum analyzer.

### 4.5.4 DEVIATION FROM TEST STANDARD

No deviation

### 4.5.5 TEST SETUP

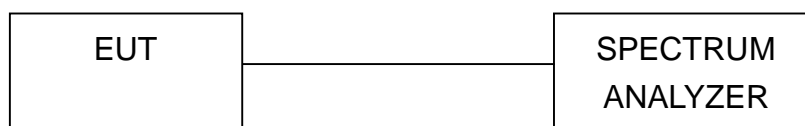

### 4.5.6 EUT OPERATING CONDITION

Same as Item 4.3.6



A D T

### 4.5.7 TEST RESULTS

#### 802.11b DSSS MODULATION:

CHANNEL	CHANNEL FREQUENCY (MHz)	RF POWER LEVEL IN 3kHz BW (dBm)	MAXIMUM LIMIT (dBm)	PASS / FAIL
1	2412	-4.0	8	PASS
6	2437	-4.6	8	PASS
11	2462	-4.8	8	PASS

CH1

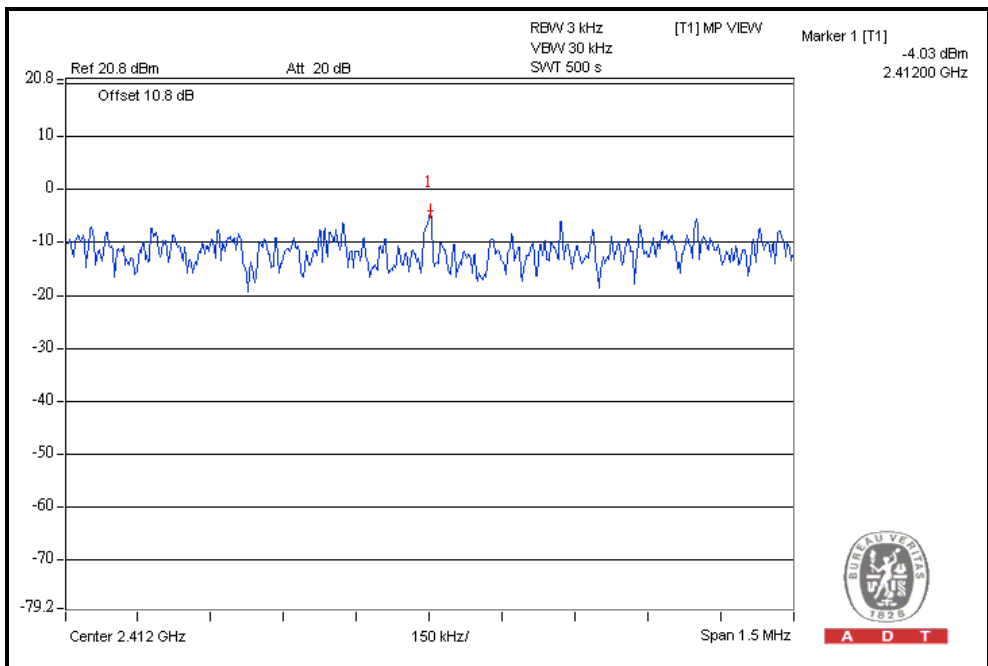



A D T

### 802.11g OFDM MODULATION:

CHANNEL	CHANNEL FREQUENCY (MHz)	RF POWER LEVEL IN 3kHz BW (dBm)	MAXIMUM LIMIT (dBm)	PASS / FAIL
1	2412	-3.8	8	PASS
6	2437	-1.6	8	PASS
11	2462	-6.7	8	PASS

CH6

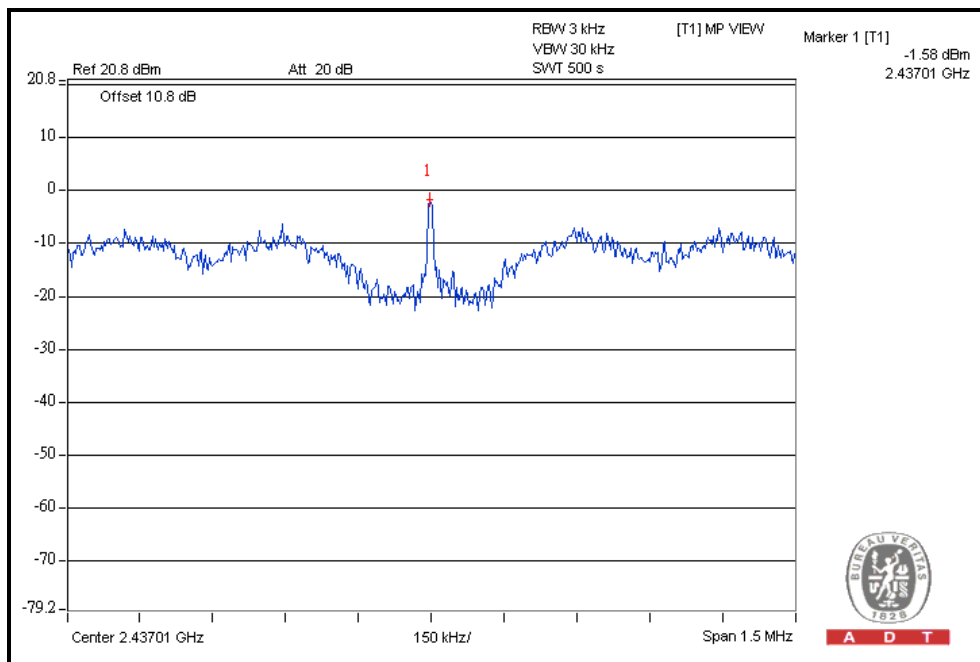



A D T

### 802.11n (20MHz) OFDM MODULATION:

CHANNEL	CHANNEL FREQUENCY (MHz)	RF POWER LEVEL IN 3kHz BW (dBm)		TOTAL POWER DENSITY (dBm)	MAXIMUM LIMIT (dBm)	PASS / FAIL
		CHAIN(0)	CHAIN(1)			
1	2412	-6.6	-10.0	-5.0	8	PASS
6	2437	-4.9	-11.2	-4.0	8	PASS
11	2462	-8.3	-11.9	-6.7	8	PASS

For Chain(0): CH6

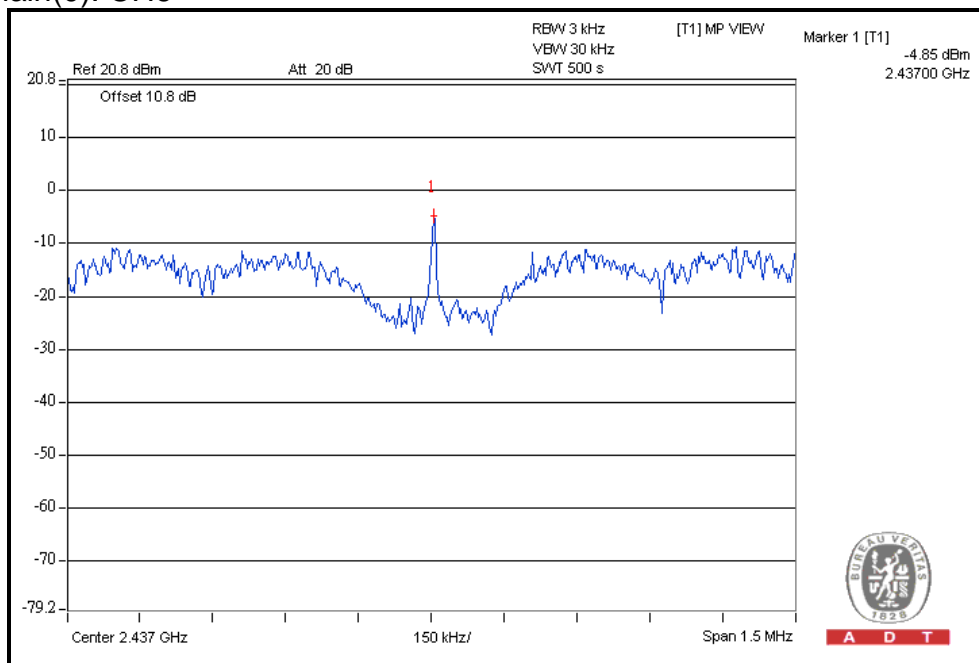



A D T

### 802.11n (40MHz) OFDM MODULATION:

CHANNEL	CHANNEL FREQUENCY (MHz)	RF POWER LEVEL IN 3kHz BW (dBm)		TOTAL POWER DENSITY (dBm)	MAXIMUM LIMIT (dBm)	PASS / FAIL
		CHAIN(0)	CHAIN(1)			
3	2422	-9.0	-16.9	-8.3	8	PASS
6	2437	-7.2	-14.9	-6.5	8	PASS
9	2452	-8.6	-18.3	-8.2	8	PASS

For Chain(0): CH6

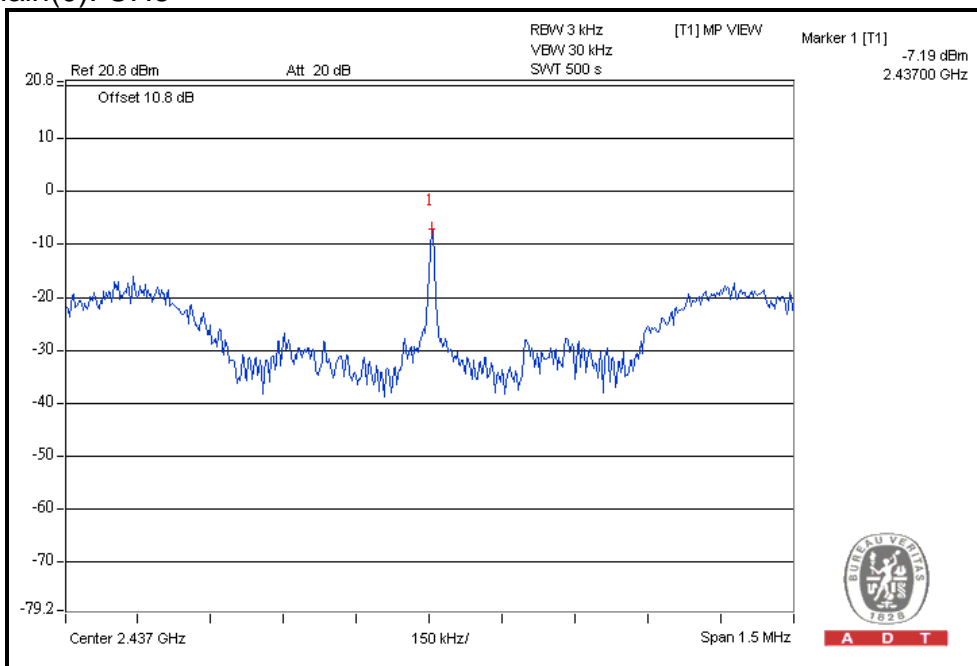

A D T



## 4.6 CONDUCTED OUT-BAND EMISSION MEASUREMENT

### 4.6.1 LIMITS OF CONDUCTED OUT-BAND EMISSION MEASUREMENT

Below  $-20\text{dB}$  of the highest emission level of operating band (in 100kHz Resolution Bandwidth).

### 4.6.2 TEST INSTRUMENTS

Test date: Oct. 18, 2011

DESCRIPTION & MANUFACTURER	MODEL NO.	SERIAL NO.	CALIBRATED DATE	CALIBRATED UNTIL
R&S Spectrum Analyzer	FSP40	100036	Dec. 08, 2010	Dec. 07, 2011

**NOTE:** The calibration interval of the above test instruments is 12 months and the calibrations are traceable to NML/ROC and NIST/USA.

### 4.6.3 TEST PROCEDURE

The transmitter output was connected to the spectrum analyzer via a low loss cable. Set RBW of spectrum analyzer to 100kHz and VBW of spectrum analyzer to 300kHz with suitable frequency span including 100MHz or 200MHz bandwidth from band edge. The band edges was measured and recorded.

The spectrum plots (RBW = 100kHz, VBW = 300kHz) are attached on the following pages.

### 4.6.4 DEVIATION FROM TEST STANDARD

No deviation

### 4.6.5 EUT OPERATING CONDITION

Same as Item 4.3.6

### 4.6.6 TEST RESULTS

The spectrum plots are attached on the following images. D1 line indicates the highest level, and D2 line indicates the 20dB offset below D1. It shows compliance with the requirement in part 15.247(d).



A D T

### Performing measurements: Measure and add 10 log(N) dB 802.11b DSSS MODULATION:

CH1

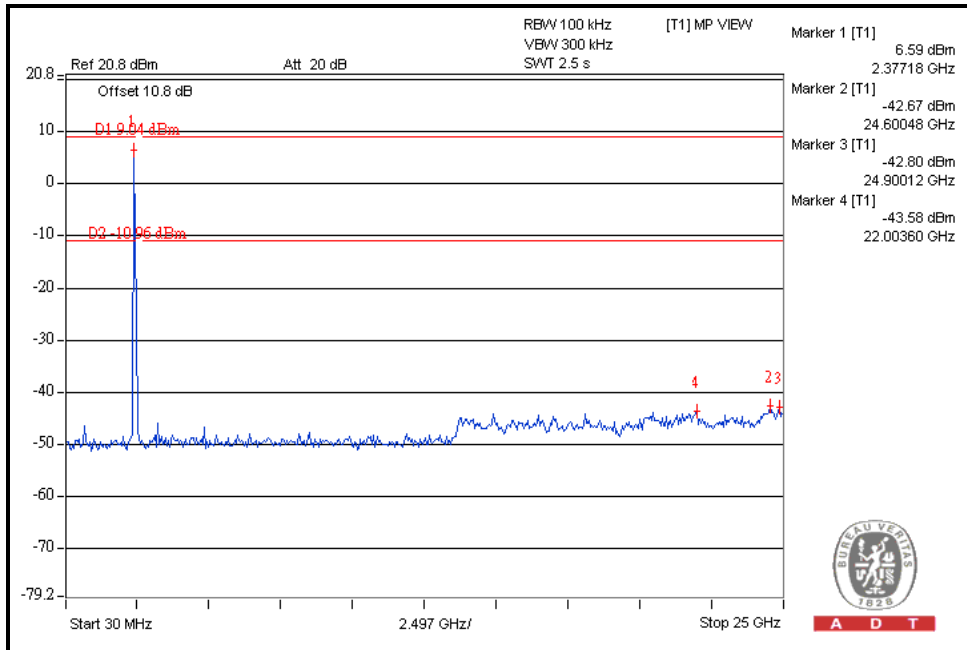
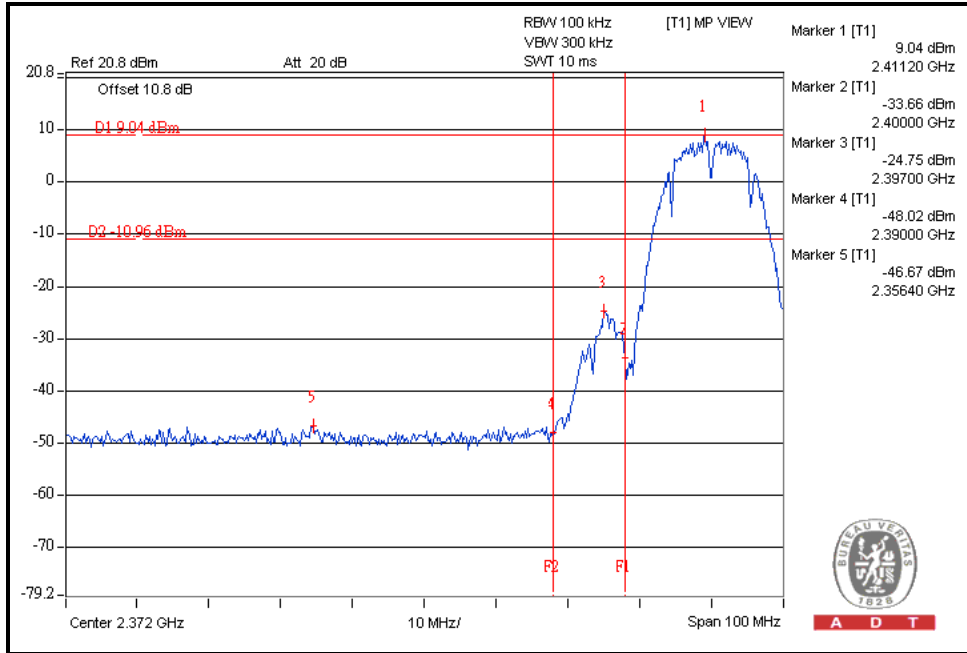



A D T

# CH11

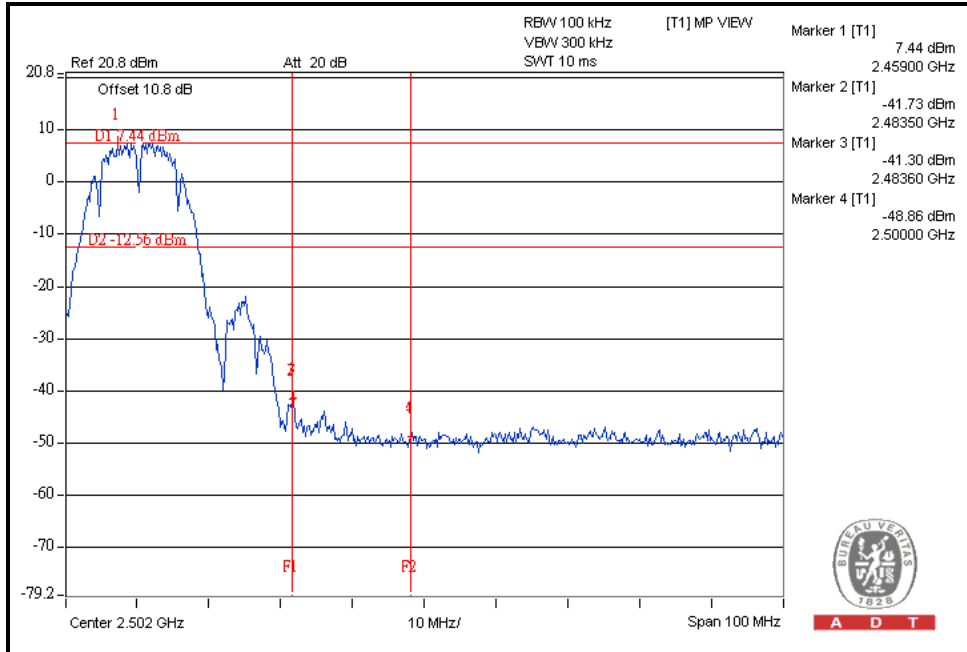

A D T

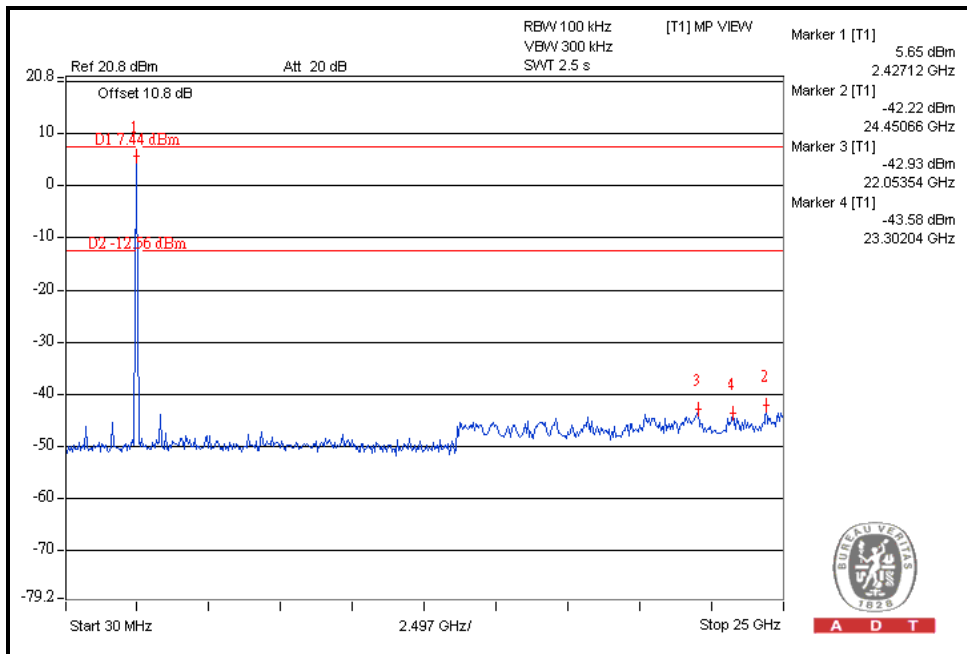

A D T

## 802.11g OFDM MODULATION:

CH1

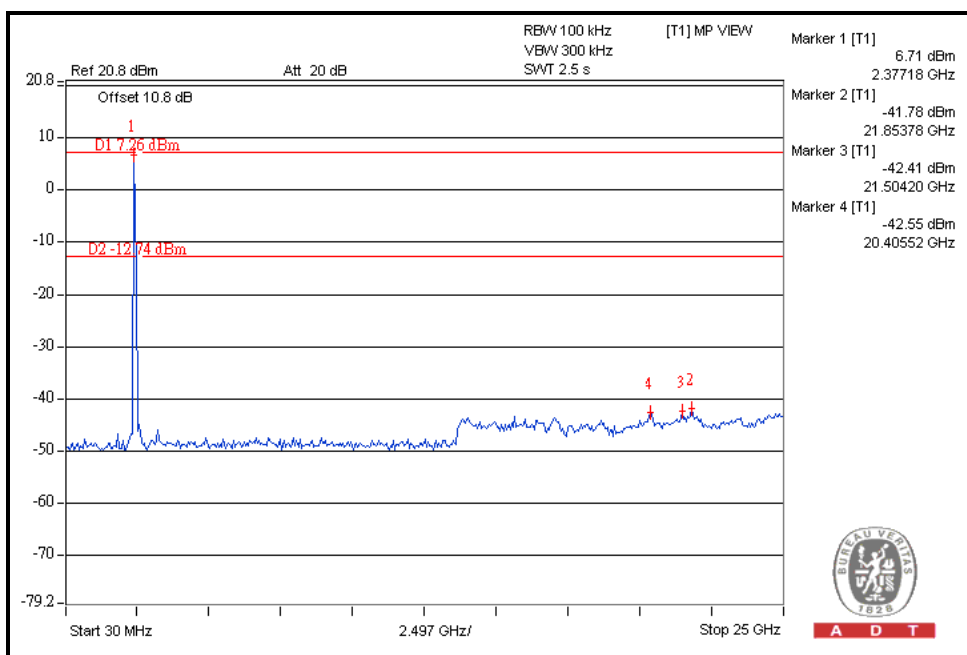
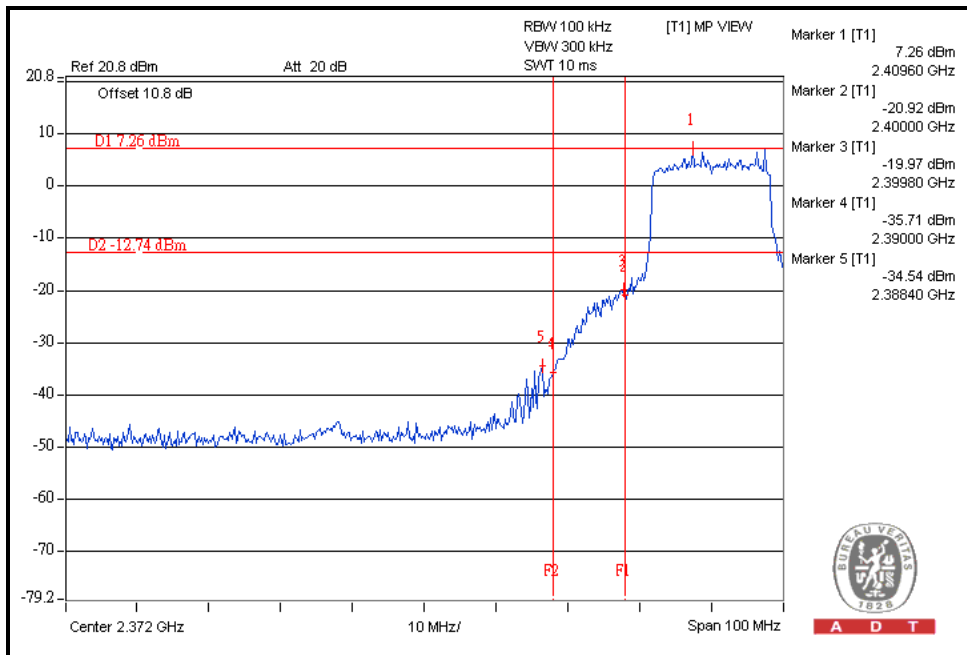



A D T

# CH11

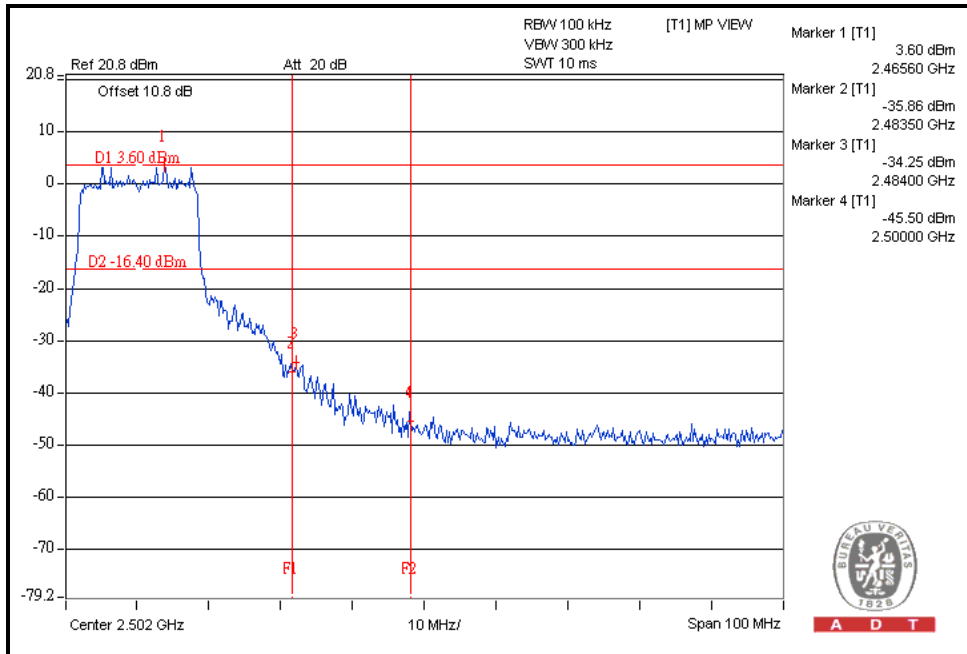

A D T

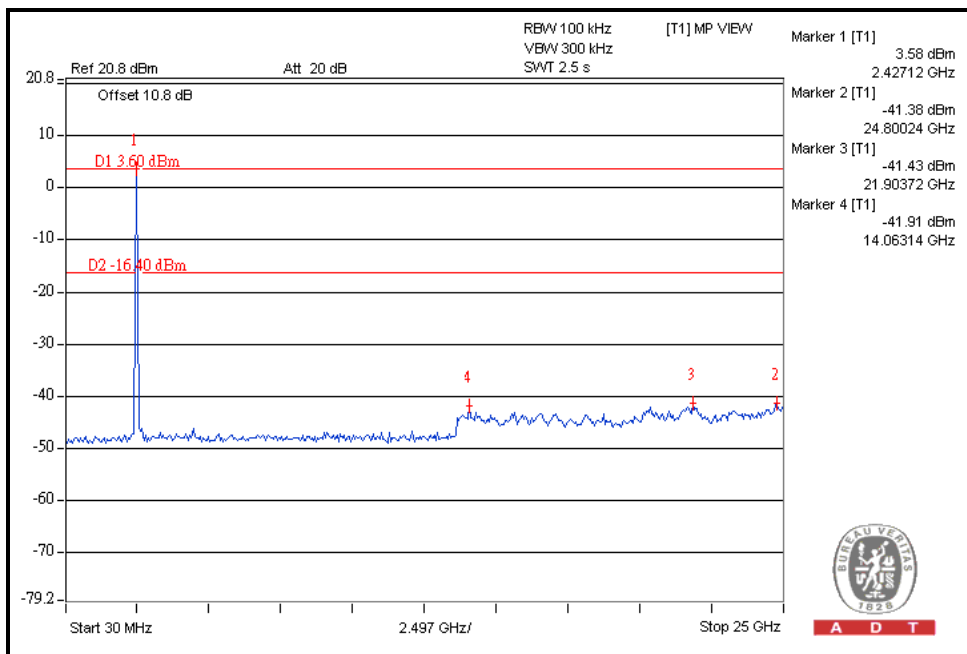

A D T



A D T

## 802.11n (20MHz) OFDM MODULATION:

CH1

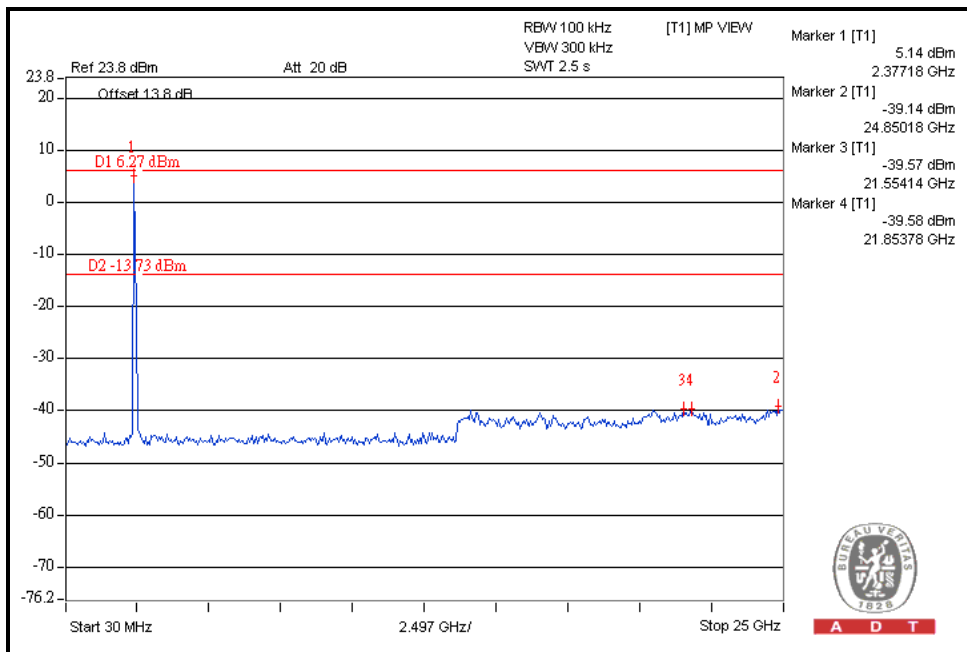
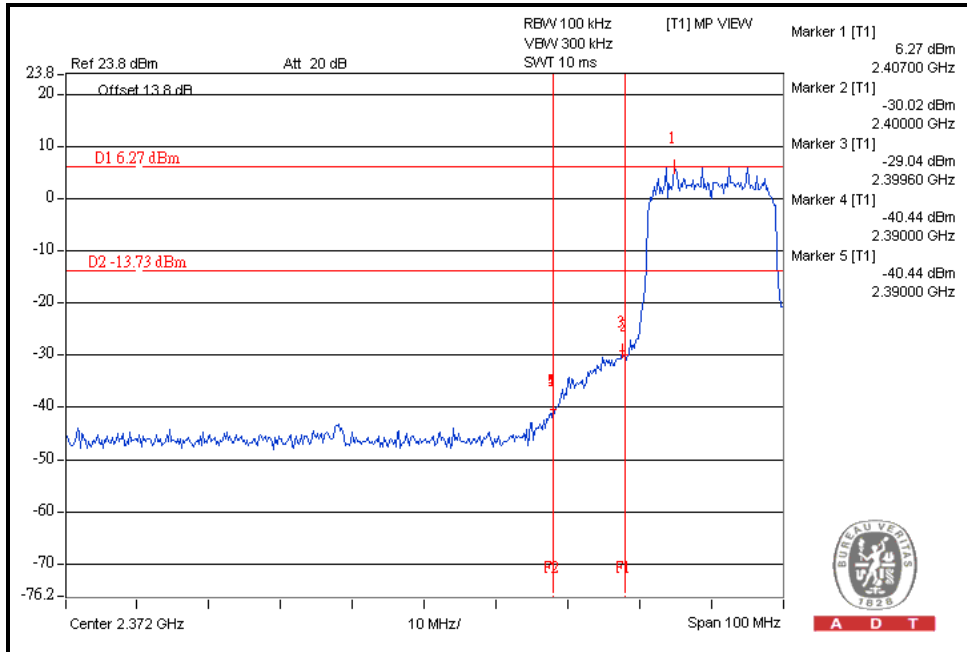



A D T

# CH11

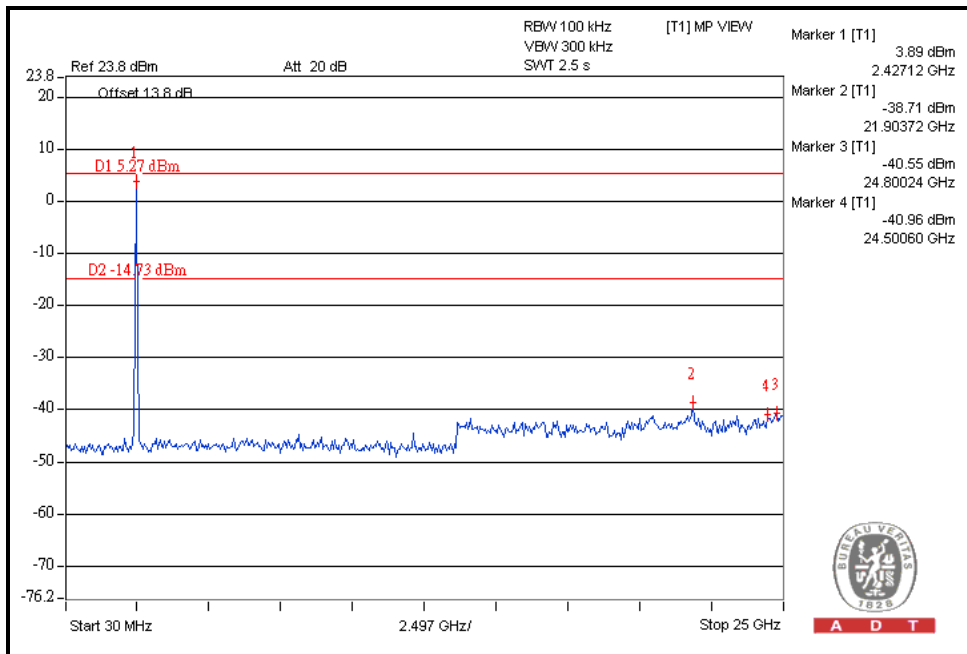
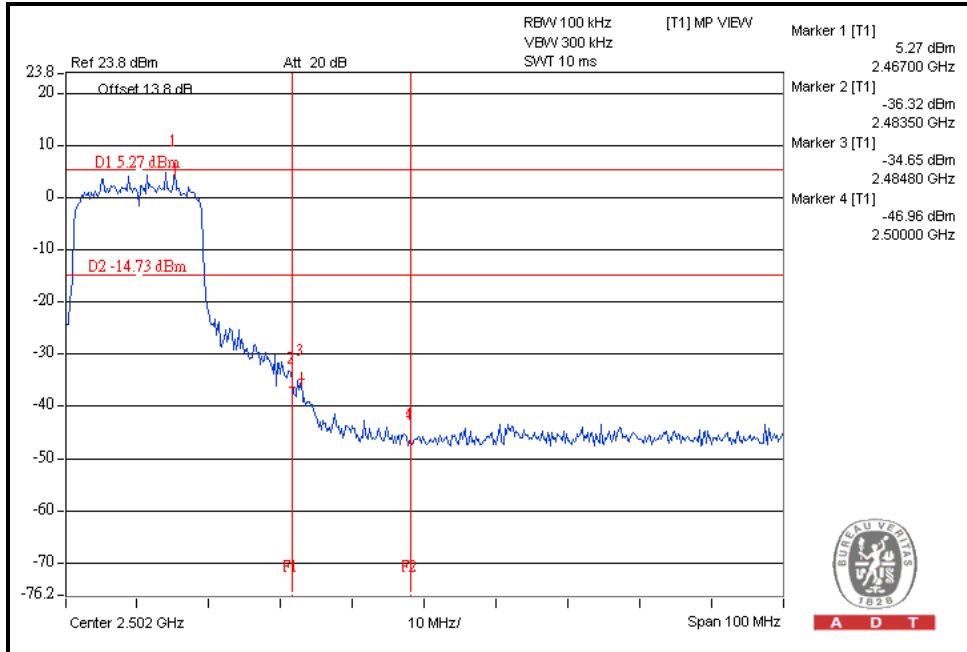



A D T

## 802.11n (40MHz) OFDM MODULATION:

CH3

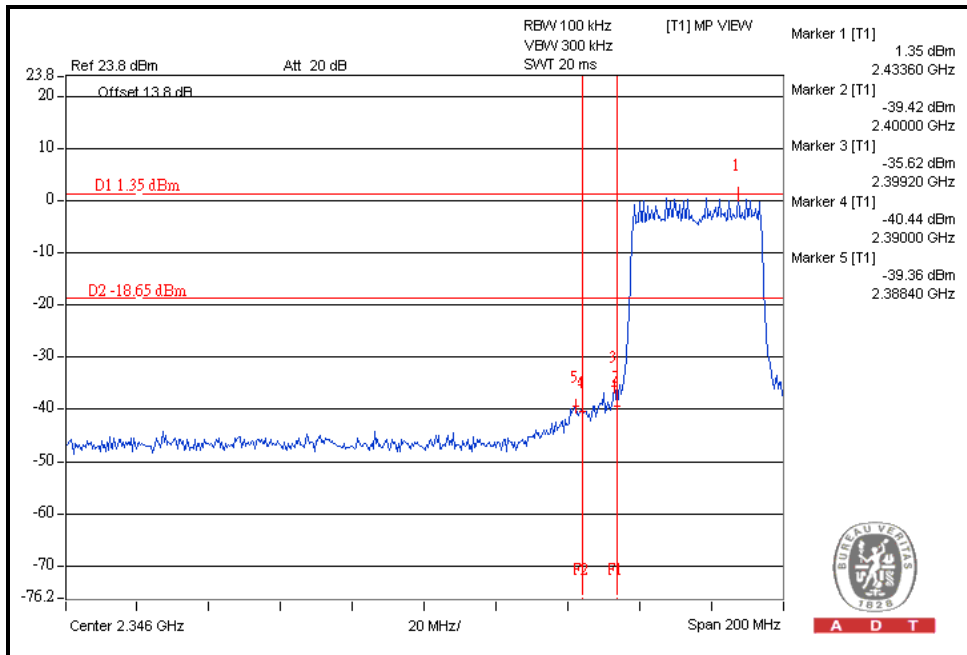

A D T

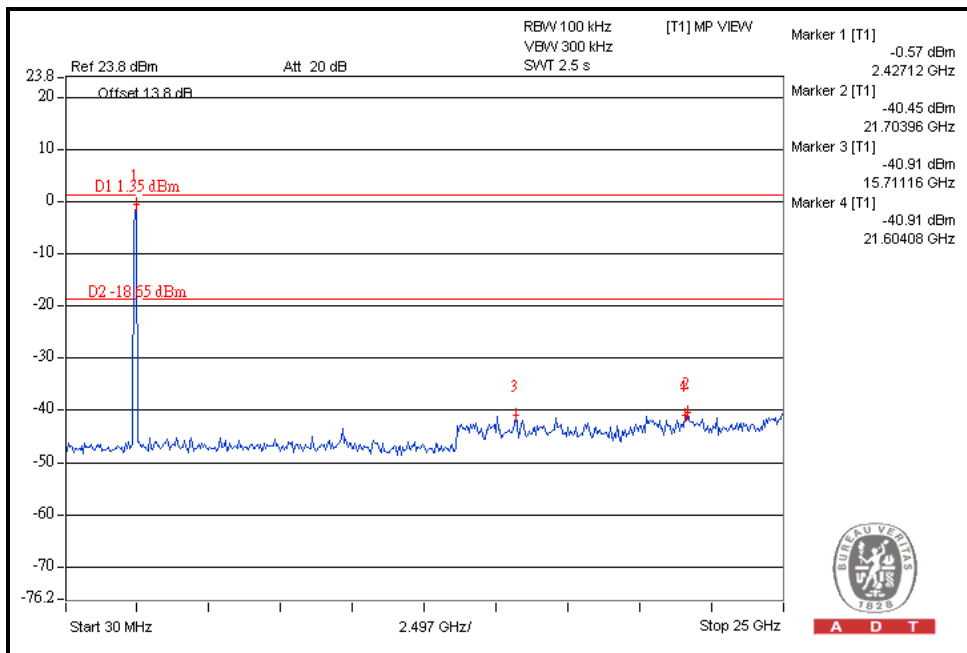

A D T





A D T

# CH9

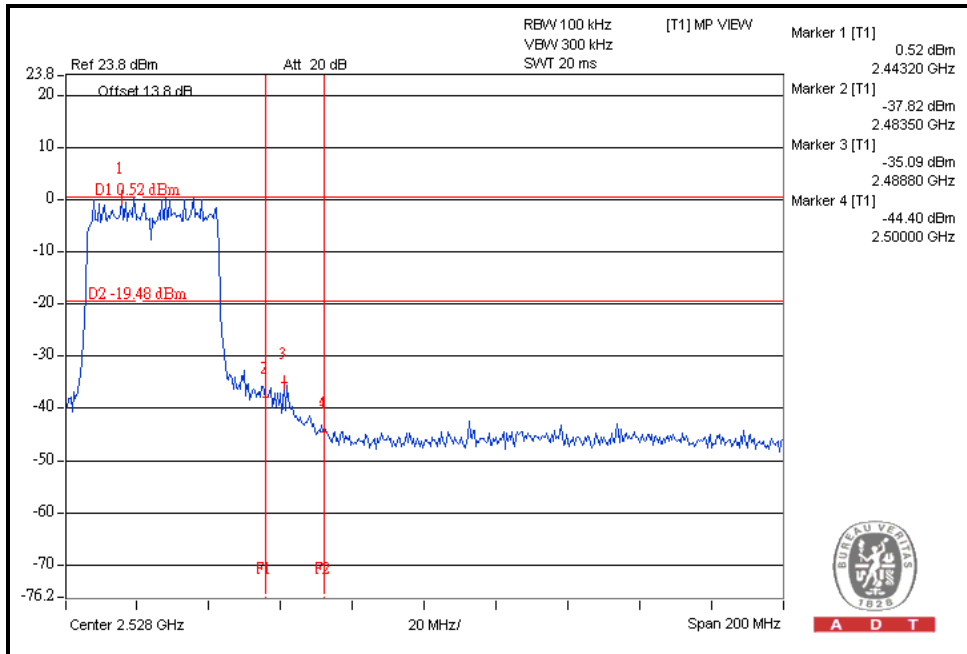

A D T

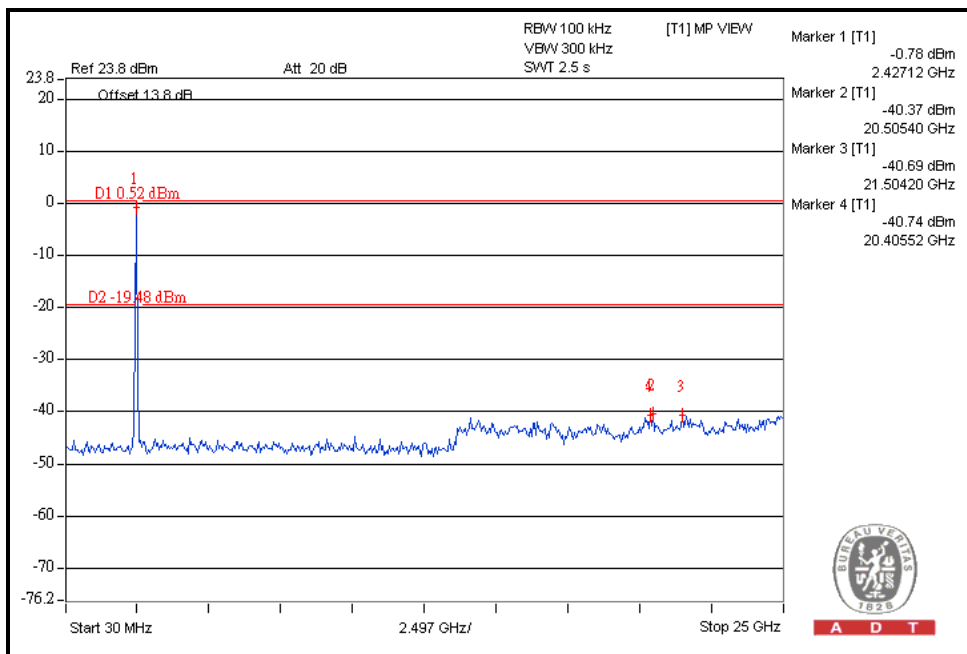

A D T

## 5. TEST TYPES AND RESULTS (802.11a, 5725~5850MHz Band)

### 5.1 CONDUCTED EMISSION MEASUREMENT

#### 5.1.1 LIMITS OF CONDUCTED EMISSION MEASUREMENT

FREQUENCY OF EMISSION (MHz)	CONDUCTED LIMIT (dB $\mu$ V)	
	Quasi-peak	Average
0.15-0.5	66 to 56	56 to 46
0.5-5	56	46
5-30	60	50

- NOTE:**
1. The lower limit shall apply at the transition frequencies.
  2. The limit decreases in line with the logarithm of the frequency in the range of 0.15 to 0.50 MHz.
  3. All emanations from a class A/B digital device or system, including any network of conductors and apparatus connected thereto, shall not exceed the level of field strengths specified above.

#### 5.1.2 TEST INSTRUMENTS

Test date: Oct. 19, 2011

DESCRIPTION & MANUFACTURER	MODEL NO.	SERIAL NO.	CALIBRATED DATE	CALIBRATED UNTIL
Test Receiver	ESCS 30	100375	Mar. 09, 2011	Mar. 08, 2012
Line-Impedance Stabilization Network (for EUT)	ENV216	100072	Jun. 10, 2011	Jun. 09, 2012
Line-Impedance Stabilization Network (for Peripheral)	ESH3-Z5	848773/004	Nov. 03, 2010	Nov. 02, 2011
RF Cable (JYEBAO)	5DFB	COCCAB-002	Aug. 29, 2011	Aug. 28, 2012
50 ohms Terminator	50	3	Nov. 03, 2010	Nov. 02, 2011
Software	BV ADT_Cond_V7.3.7	NA	NA	NA

**Note:**

1. The calibration interval of the above test instruments is 12 months and the calibrations are traceable to NML/ROC and NIST/USA.
2. The test was performed in Shielded Room No. C.
- 3 The VCCI Con C Registration No. is C-3611.



A D T

### 5.1.3 TEST PROCEDURES

- a. The EUT was placed 0.4 meters from the conducting wall of the shielded room with EUT being connected to the power mains through a line impedance stabilization network (LISN). Other support units were connected to the power mains through another LISN. The two LISNs provide 50 ohm/50uH of coupling impedance for the measuring instrument.
- b. Both lines of the power mains connected to the EUT were checked for maximum conducted interference.
- c. The frequency range from 150kHz to 30MHz was searched. Emission levels under (Limit – 20dB) were not recorded.

### 5.1.4 DEVIATION FROM TEST STANDARD

No deviation

### 5.1.5 TEST SETUP

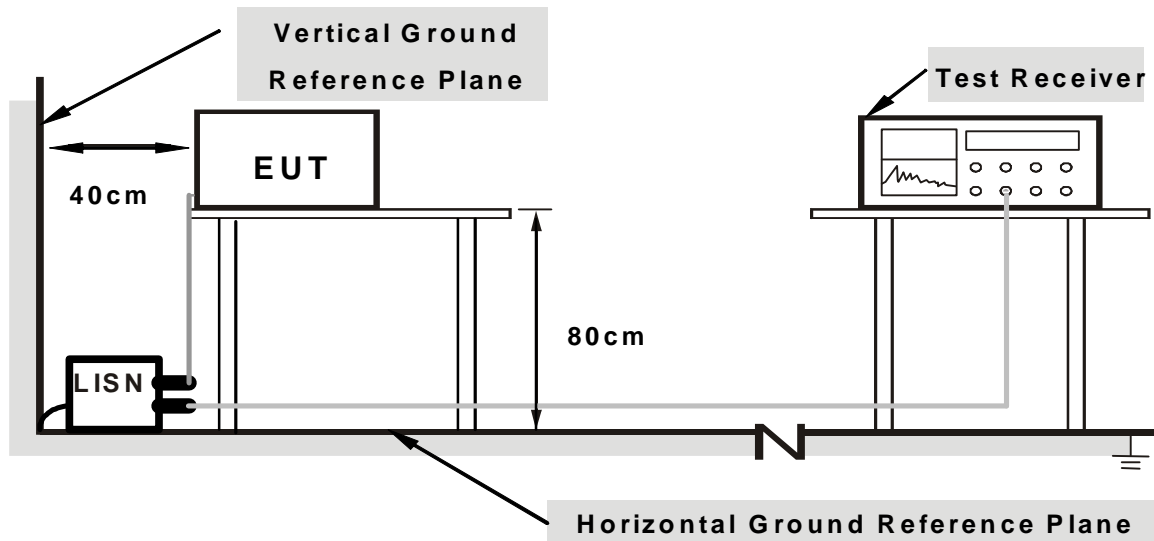

**Note: 1. Support units were connected to second LISN.**

**2. Both of LISNs (AMN) are 80 cm from EUT and at least 80 from other units and other metal planes**

For the actual test configuration, please refer to the related item – Photographs of the Test Configuration.

### 5.1.6 EUT OPERATING CONDITIONS

Same as the 4.1.6

### 5.1.7 TEST RESULTS

<b>PHASE</b>	Line (L)	<b>6dB BANDWIDTH</b>	9 kHz
--------------	----------	----------------------	-------

No	Freq.	Corr.	Reading Value		Emission Level		Limit		Margin	
	[MHz]	Factor (dB)	[dB (uV)]		[dB (uV)]		[dB (uV)]		(dB)	
			Q.P.	AV.	Q.P.	AV.	Q.P.	AV.	Q.P.	AV.
1	0.150	0.10	26.14	20.58	26.24	20.68	66.00	56.00	-39.76	-35.32
2	1.852	0.16	27.92	20.65	28.08	20.81	56.00	46.00	-27.92	-25.19
<b>3</b>	<b>3.410</b>	<b>0.19</b>	<b>28.33</b>	<b>20.74</b>	<b>28.52</b>	<b>20.93</b>	<b>56.00</b>	<b>46.00</b>	<b>-27.48</b>	<b>-25.07</b>
4	12.043	0.51	20.91	14.26	21.42	14.77	60.00	50.00	-38.58	-35.23
5	18.883	0.64	25.19	19.71	25.83	20.35	60.00	50.00	-34.17	-29.65
6	27.348	0.91	20.36	15.33	21.27	16.24	60.00	50.00	-38.73	-33.76

- REMARKS:**
1. Q.P. and AV. are abbreviations of quasi-peak and average individually.
  2. The emission levels of other frequencies were very low against the limit.
  3. Margin value = Emission level - Limit value
  4. Correction factor = Insertion loss + Cable loss
  5. Emission Level = Correction Factor + Reading Value.

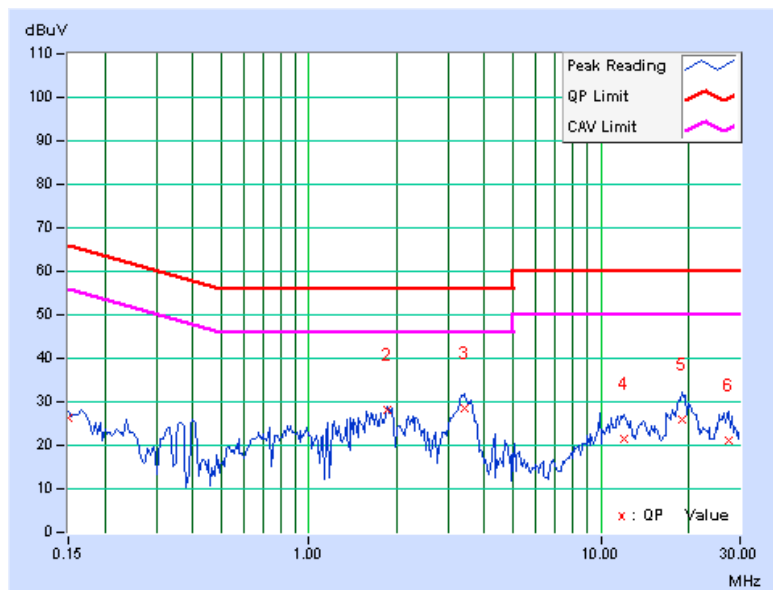

<b>PHASE</b>	Neutral (N)	<b>6dB BANDWIDTH</b>	9 kHz
--------------	-------------	----------------------	-------

No	Freq. [MHz]	Corr. Factor (dB)	Reading Value [dB (uV)]		Emission Level [dB (uV)]		Limit [dB (uV)]		Margin (dB)	
			Q.P.	AV.	Q.P.	AV.	Q.P.	AV.	Q.P.	AV.
			1	0.150	0.12	22.57	15.75	22.69	15.87	66.00
2	1.621	0.18	26.22	19.13	26.40	19.31	56.00	46.00	-29.60	-26.69
3	1.840	0.19	27.64	18.42	27.83	18.61	56.00	46.00	-28.17	-27.39
4	3.395	0.25	28.52	18.16	28.77	18.41	56.00	46.00	-27.23	-27.59
5	12.023	0.95	15.89	9.14	16.84	10.09	60.00	50.00	-43.16	-39.91
6	20.215	1.44	23.39	17.57	24.83	19.01	60.00	50.00	-35.17	-30.99

- REMARKS:**
1. Q.P. and AV. are abbreviations of quasi-peak and average individually.
  2. The emission levels of other frequencies were very low against the limit.
  3. Margin value = Emission level - Limit value
  4. Correction factor = Insertion loss + Cable loss
  5. Emission Level = Correction Factor + Reading Value.

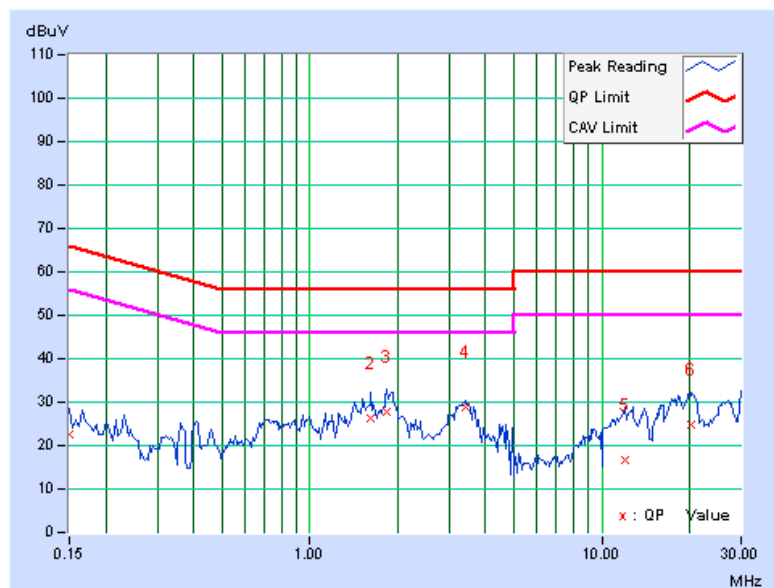

## 5.2 RADIATED EMISSION MEASUREMENT

### 5.2.1 LIMITS OF RADIATED EMISSION MEASUREMENT

Emissions radiated outside of the specified bands, shall be according to the general radiated limits in 15.209 as following:

Frequencies (MHz)	Field strength (microvolts/meter)	Measurement distance (meters)
0.009-0.490	2400/F(kHz)	300
0.490-1.705	24000/F(kHz)	30
1.705-30.0	30	30
30-88	100	3
88-216	150	3
216-960	200	3
Above 960	500	3

**NOTE:**

1. The lower limit shall apply at the transition frequencies.
2. Emission level (dBuV/m) = 20 log Emission level (uV/m).
3. As shown in 15.35(b), for frequencies above 1000MHz, the field strength limits are based on average detector, however, the peak field strength of any emission shall not exceed the maximum permitted average limits, specified above by more than 20dB under any condition of modulation.
4. Section 15.205 restricted bands of operation shall compliance with the limits in Section 15.209.



A D T

## 5.2.2 TEST INSTRUMENTS

**For below 1GHz: Test date: Sep. 15, 2011**

DESCRIPTION & MANUFACTURER	MODEL NO.	SERIAL NO.	CALIBRATED DATE	CALIBRATED UNTIL
Agilent Spectrum Analyzer	E4446A	MY48250253	Aug. 29, 2011	Aug. 28, 2012
Agilent Pre-Selector	N9039A	MY46520310	Aug. 29, 2011	Aug. 28, 2012
Agilent Signal Generator	N5181A	MY49060347	July 25, 2011	July 24, 2012
LIG NEX1 Test Receiver	ER-265	L09068005	Oct. 25, 2010	Oct. 24, 2011
Mini-Circuits Pre-Amplifier	ZFL-1000VH2B	AMP-ZFL-04	Nov. 16, 2010	Nov. 15, 2011
Agilent Pre-Amplifier	8449B	3008A02465	Feb. 28, 2011	Feb. 27, 2012
Miteq Pre-Amplifier	AFS33-1800265 0-30-8P-44	881786	Nov. 16, 2010	Nov. 15, 2011
SCHWARZBECK Trilog Broadband Antenna	VULB 9168	9168-361	Apr. 14, 2011	Apr. 13, 2012
AISI Horn_Antenna	AIH.8018	0000220091110	Nov. 22, 2010	Nov. 21, 2011
SCHWARZBECK Horn_Antenna	BBHA 9170	9170-424	Oct. 08, 2010	Oct. 07, 2011
RF CABLE	NA	RF104-205 RF104-207 RF104-202	Dec. 28, 2010	Dec. 27, 2011
RF Cable	NA	CHHCAB_001	Oct. 12, 2010	Oct. 11, 2011
Software	ADT_Radiated_V8.7.05	NA	NA	NA
CT Antenna Tower & Turn Table	NA	NA	NA	NA

Note: 1. The calibration interval of the above test instruments is 12 months and the calibrations are traceable to NML/ROC and NIST/USA.

2. The horn antenna, preamplifier (model: 8449B) are used only for the measurement of emission frequency above 1GHz if tested.

3. The test was performed in 966 Chamber No. H.

4. The FCC Site Registration No. is 797305.

5. The CANADA Site Registration No. is IC 7450H-3.





A D T

**For above 1GHz: Test date: Oct. 04, 2011**

DESCRIPTION & MANUFACTURER	MODEL NO.	SERIAL NO.	CALIBRATED DATE	CALIBRATED UNTIL
Agilent Spectrum Analyzer	E4446A	MY48250254	July 12, 2011	July 11, 2012
Agilent Pre-Selector	N9039A	MY46520311	July 12, 2011	July 11, 2012
Agilent Signal Generator	N5181A	MY49060517	July 12, 2011	July 11, 2012
Mini-Circuits Pre-Amplifier	ZFL-1000VH2B	AMP-ZFL-03	Nov. 16, 2010	Nov. 15, 2011
Agilent Pre-Amplifier	8449B	3008A02578	July 04, 2011	July 03, 2012
Miteq Pre-Amplifier	AFS33-1800265 0-30-8P-44	881786	Nov. 16, 2010	Nov. 15, 2011
SCHWARZBECK Trilog Broadband Antenna	VULB 9168	9168-360	Apr. 14, 2011	Apr. 13, 2012
AISI Horn_Antenna	AIH.8018	0000320091110	Nov. 12, 2010	Nov. 11, 2011
SCHWARZBECK Horn_Antenna	BBHA 9170	9170-424	Oct. 08, 2010	Oct. 07, 2011
RF CABLE	NA	RF104-201 RF104-203 RF104-204	Dec. 27, 2010	Dec. 26, 2011
RF Cable	NA	CHGCAB_001	Oct. 12, 2010	Oct. 11, 2011
Software	ADT_Radiated_V8.7.05	NA	NA	NA
CT Antenna Tower & Turn Table	NA	NA	NA	NA

- Note: 1. The calibration interval of the above test instruments is 12 months and the calibrations are traceable to NML/ROC and NIST/USA.  
2. The horn antenna, preamplifier (model: 8449B) are used only for the measurement of emission frequency above 1GHz if tested.  
3. The test was performed in 966 Chamber No. G.  
4. The FCC Site Registration No. is 966073.  
5. The VCCI Site Registration No. is G-137.  
6. The CANADA Site Registration No. is IC 7450H-2.

### 5.2.3 TEST PROCEDURES

- a. The EUT was placed on the top of a rotating table 0.8 meters above the ground at a 3 meter chamber room. The table was rotated 360 degrees to determine the position of the highest radiation.
- b. The EUT was set 3 meters away from the interference-receiving antenna, which was mounted on the top of a variable-height antenna tower.
- c. The height of antenna is varied from one meter to four meters above the ground to determine the maximum value of the field strength. Both horizontal and vertical polarizations of the antenna are set to make the measurement.
- d. For each suspected emission, the EUT was arranged to its worst case and then the antenna was tuned to heights from 1 meter to 4 meters and the rotatable table was turned from 0 degrees to 360 degrees to find the maximum reading.
- e. The test-receiver system was set to quasi-peak detect function and specified bandwidth with maximum hold mode when the test frequency is below 1 GHz.
- f. The test-receiver system was set to peak and average detect function and specified bandwidth with maximum hold mode when the test frequency is above 1 GHz. If the peak reading value also meets average limit, measurement with the average detector is unnecessary.

**NOTE:**

1. The resolution bandwidth and video bandwidth of test receiver/spectrum analyzer is 120kHz for Quasi-peak detection (QP) at frequency below 1GHz.
2. The resolution bandwidth of test receiver/spectrum analyzer is 1 MHz and the video bandwidth is 3 MHz for Peak detection (PK) at frequency above 1GHz.
3. The resolution bandwidth of test receiver/spectrum analyzer is 1 MHz and the video bandwidth is 10 Hz for Average detection (AV) at frequency above 1GHz.

### 5.2.4 DEVIATION FROM TEST STANDARD

No deviation

### 5.2.5 TEST SETUP

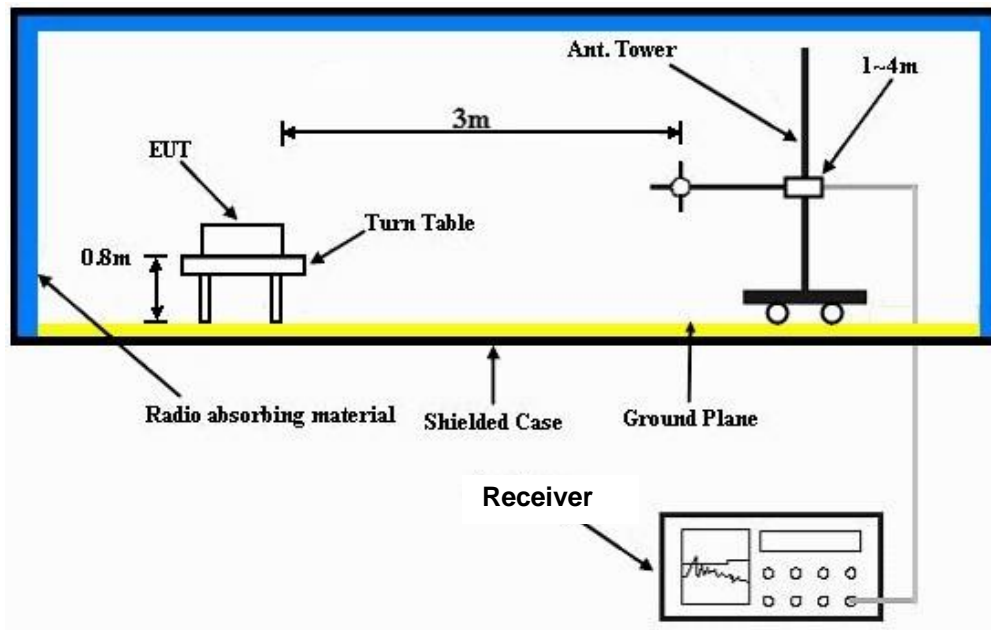

For the actual test configuration, please refer to the related item – Photographs of the Test Configuration.

### 5.2.6 EUT OPERATING CONDITIONS

Same as the 4.1.6

## 5.2.7 TEST RESULTS

### BELOW 1GHz WORST-CASE DATA : 802.11n (20MHz) OFDM MODULATION

EUT TEST CONDITION		MEASUREMENT DETAIL	
CHANNEL	Channel 149	FREQUENCY RANGE	Below 1000MHz
INPUT POWER (SYSTEM)	120Vac, 60 Hz	DETECTOR FUNCTION	Quasi-Peak
ENVIRONMENTAL CONDITIONS	27deg. C, 72%RH	TESTED BY	Frank Liu

ANTENNA POLARITY & TEST DISTANCE: HORIZONTAL AT 3 M								
NO.	FREQ. (MHz)	EMISSION LEVEL (dBuV/m)	LIMIT (dBuV/m)	MARGIN (dB)	ANTENNA HEIGHT (m)	TABLE ANGLE (Degree)	RAW VALUE (dBuV)	CORRECTION FACTOR (dB/m)
1	216.99	38.6 QP	46.0	-7.4	1.50 H	12	26.73	11.83
2	234.99	39.7 QP	46.0	-6.3	1.50 H	135	27.24	12.49
3	321.79	41.3 QP	46.0	-4.7	1.00 H	213	25.61	15.65
4	409.19	34.4 QP	46.0	-11.6	2.00 H	234	16.90	17.53
5	604.82	39.7 QP	46.0	-6.3	1.50 H	244	18.05	21.63
6	959.97	32.8 QP	46.0	-13.2	1.00 H	131	6.28	26.50
ANTENNA POLARITY & TEST DISTANCE: VERTICAL AT 3 M								
NO.	FREQ. (MHz)	EMISSION LEVEL (dBuV/m)	LIMIT (dBuV/m)	MARGIN (dB)	ANTENNA HEIGHT (m)	TABLE ANGLE (Degree)	RAW VALUE (dBuV)	CORRECTION FACTOR (dB/m)
1	33.67	33.8 QP	40.0	-6.2	1.00 V	115	20.62	13.22
2	143.09	28.5 QP	43.5	-15.0	1.00 V	126	14.32	14.21
3	217.34	29.7 QP	46.0	-16.3	1.00 V	138	17.83	11.84
4	303.20	37.5 QP	46.0	-8.5	1.50 V	113	22.27	15.25
5	604.94	28.2 QP	46.0	-17.8	1.50 V	214	6.56	21.63
6	846.05	28.8 QP	46.0	-17.2	1.50 V	113	3.75	25.09

- REMARKS:**
1. Emission level (dBuV/m) = Raw Value (dBuV) + Correction Factor (dB/m).
  2. Correction Factor (dB/m) = Antenna Factor (dB/m) + Cable Factor (dB).
  3. The other emission levels were very low against the limit.
  4. Margin value = Emission level – Limit value.



A D T

**ABOVE 1GHz WORST-CASE DATA**

**802.11a OFDM MODULATION**

EUT TEST CONDITION		MEASUREMENT DETAIL	
CHANNEL	Channel 149	FREQUENCY RANGE	1 ~ 40GHz
INPUT POWER (SYSTEM)	120Vac, 60 Hz	DETECTOR FUNCTION	Peak (PK) Average (AV)
ENVIRONMENTAL CONDITIONS	25deg. C, 69%RH	TESTED BY	Nelson Teng

ANTENNA POLARITY & TEST DISTANCE: HORIZONTAL AT 3 M								
NO.	FREQ. (MHz)	EMISSION LEVEL (dBuV/m)	LIMIT (dBuV/m)	MARGIN (dB)	ANTENNA HEIGHT (m)	TABLE ANGLE (Degree)	RAW VALUE (dBuV)	CORRECTION FACTOR (dB/m)
1	*5745.00	104.3 PK			1.44 H	56	62.27	42.03
2	*5745.00	94.5 AV			1.44 H	56	52.47	42.03
3	11490.00	58.7 PK	74.0	-15.3	1.19 H	259	10.52	48.18
4	11490.00	49.4 AV	54.0	-4.6	1.19 H	259	1.22	48.18
ANTENNA POLARITY & TEST DISTANCE: VERTICAL AT 3 M								
NO.	FREQ. (MHz)	EMISSION LEVEL (dBuV/m)	LIMIT (dBuV/m)	MARGIN (dB)	ANTENNA HEIGHT (m)	TABLE ANGLE (Degree)	RAW VALUE (dBuV)	CORRECTION FACTOR (dB/m)
1	*5745.00	110.3 PK			1.42 V	263	68.27	42.03
2	*5745.00	100.4 AV			1.42 V	263	58.37	42.03
3	11490.00	64.6 PK	74.0	-9.4	1.00 V	21	16.42	48.18
4	11490.00	53.4 AV	54.0	-0.6	1.00 V	21	5.22	48.18

- REMARKS:**
1. Emission level (dBuV/m) = Raw Value (dBuV) + Correction Factor (dB/m).
  2. Correction Factor (dB/m) = Antenna Factor (dB/m) + Cable Factor (dB).
  3. The other emission levels were very low against the limit.
  4. Margin value = Emission level – Limit value.
  5. “ \* “: Fundamental frequency.
  6. The limit value is defined as per 15.247.



A D T

EUT TEST CONDITION		MEASUREMENT DETAIL	
CHANNEL	Channel 157	FREQUENCY RANGE	1 ~ 40GHz
INPUT POWER (SYSTEM)	120Vac, 60 Hz	DETECTOR FUNCTION	Peak (PK) Average (AV)
ENVIRONMENTAL CONDITIONS	25deg. C, 69%RH	TESTED BY	Nelson Teng

ANTENNA POLARITY & TEST DISTANCE: HORIZONTAL AT 3 M								
NO.	FREQ. (MHz)	EMISSION LEVEL (dBuV/m)	LIMIT (dBuV/m)	MARGIN (dB)	ANTENNA HEIGHT (m)	TABLE ANGLE (Degree)	RAW VALUE (dBuV)	CORRECTION FACTOR (dB/m)
1	*5785.00	104.6 PK			1.44 H	72	62.43	42.17
2	*5785.00	94.3 AV			1.44 H	72	52.13	42.17
3	11570.00	58.3 PK	74.0	-15.7	1.13 H	254	10.11	48.19
4	11570.00	49.2 AV	54.0	-4.8	1.13 H	254	1.01	48.19

ANTENNA POLARITY & TEST DISTANCE: VERTICAL AT 3 M								
NO.	FREQ. (MHz)	EMISSION LEVEL (dBuV/m)	LIMIT (dBuV/m)	MARGIN (dB)	ANTENNA HEIGHT (m)	TABLE ANGLE (Degree)	RAW VALUE (dBuV)	CORRECTION FACTOR (dB/m)
1	*5785.00	110.6 PK			1.43 V	269	68.43	42.17
2	*5785.00	100.7 AV			1.43 V	269	58.53	42.17
3	11570.00	64.5 PK	74.0	-9.5	1.00 V	26	16.31	48.19
4	11570.00	53.1 AV	54.0	-0.9	1.00 V	26	4.91	48.19

- REMARKS:**
1. Emission level (dBuV/m) = Raw Value (dBuV) + Correction Factor (dB/m).
  2. Correction Factor (dB/m) = Antenna Factor (dB/m) + Cable Factor (dB).
  3. The other emission levels were very low against the limit.
  4. Margin value = Emission level – Limit value.
  5. “ \* ”: Fundamental frequency.
  6. The limit value is defined as per 15.247.



A D T

EUT TEST CONDITION		MEASUREMENT DETAIL	
CHANNEL	Channel 165	FREQUENCY RANGE	1 ~ 40GHz
INPUT POWER (SYSTEM)	120Vac, 60 Hz	DETECTOR FUNCTION	Peak (PK) Average (AV)
ENVIRONMENTAL CONDITIONS	25deg. C, 69%RH	TESTED BY	Nelson Teng

ANTENNA POLARITY & TEST DISTANCE: HORIZONTAL AT 3 M								
NO.	FREQ. (MHz)	EMISSION LEVEL (dBuV/m)	LIMIT (dBuV/m)	MARGIN (dB)	ANTENNA HEIGHT (m)	TABLE ANGLE (Degree)	RAW VALUE (dBuV)	CORRECTION FACTOR (dB/m)
1	*5825.00	104.9 PK			1.42 H	55	62.65	42.25
2	*5825.00	95.1 AV			1.42 H	55	52.85	42.25
3	11650.00	59.2 PK	74.0	-14.8	1.24 H	255	10.89	48.31
4	11650.00	50.0 AV	54.0	-4.0	1.24 H	255	1.69	48.31

ANTENNA POLARITY & TEST DISTANCE: VERTICAL AT 3 M								
NO.	FREQ. (MHz)	EMISSION LEVEL (dBuV/m)	LIMIT (dBuV/m)	MARGIN (dB)	ANTENNA HEIGHT (m)	TABLE ANGLE (Degree)	RAW VALUE (dBuV)	CORRECTION FACTOR (dB/m)
1	*5825.00	110.6 PK			1.42 V	273	68.35	42.25
2	*5825.00	100.5 AV			1.42 V	273	58.25	42.25
3	11650.00	64.7 PK	74.0	-9.3	1.00 V	27	16.39	48.31
4	11650.00	53.4 AV	54.0	-0.6	1.00 V	27	5.09	48.31

- REMARKS:**
1. Emission level (dBuV/m) = Raw Value (dBuV) + Correction Factor (dB/m).
  2. Correction Factor (dB/m) = Antenna Factor (dB/m) + Cable Factor (dB).
  3. The other emission levels were very low against the limit.
  4. Margin value = Emission level – Limit value.
  5. “ \* ”: Fundamental frequency.
  6. The limit value is defined as per 15.247.



A D T

**802.11n (20MHz) OFDM MODULATION**

EUT TEST CONDITION		MEASUREMENT DETAIL	
CHANNEL	Channel 149	FREQUENCY RANGE	1 ~ 40GHz
INPUT POWER (SYSTEM)	120Vac, 60 Hz	DETECTOR FUNCTION	Peak (PK) Average (AV)
ENVIRONMENTAL CONDITIONS	25deg. C, 69%RH	TESTED BY	Nelson Teng

ANTENNA POLARITY & TEST DISTANCE: HORIZONTAL AT 3 M								
NO.	FREQ. (MHz)	EMISSION LEVEL (dBuV/m)	LIMIT (dBuV/m)	MARGIN (dB)	ANTENNA HEIGHT (m)	TABLE ANGLE (Degree)	RAW VALUE (dBuV)	CORRECTION FACTOR (dB/m)
1	*5745.00	104.3 PK			1.47 H	43	62.27	42.03
2	*5745.00	94.5 AV			1.47 H	43	52.47	42.03
3	11490.00	58.6 PK	74.0	-15.4	1.16 H	250	10.42	48.18
4	11490.00	49.3 AV	54.0	-4.7	1.16 H	250	1.12	48.18
ANTENNA POLARITY & TEST DISTANCE: VERTICAL AT 3 M								
NO.	FREQ. (MHz)	EMISSION LEVEL (dBuV/m)	LIMIT (dBuV/m)	MARGIN (dB)	ANTENNA HEIGHT (m)	TABLE ANGLE (Degree)	RAW VALUE (dBuV)	CORRECTION FACTOR (dB/m)
1	*5745.00	110.7 PK			1.43 V	263	68.67	42.03
2	*5745.00	100.4 AV			1.43 V	263	58.37	42.03
3	11490.00	64.2 PK	74.0	-9.8	1.00 V	12	16.02	48.18
4	11490.00	53.4 AV	54.0	-0.6	1.00 V	12	5.22	48.18

- REMARKS:**
1. Emission level (dBuV/m) = Raw Value (dBuV) + Correction Factor (dB/m).
  2. Correction Factor (dB/m) = Antenna Factor (dB/m) + Cable Factor (dB).
  3. The other emission levels were very low against the limit.
  4. Margin value = Emission level – Limit value.
  5. “ \* “: Fundamental frequency.
  6. The limit value is defined as per 15.247.





A D T

EUT TEST CONDITION		MEASUREMENT DETAIL	
CHANNEL	Channel 157	FREQUENCY RANGE	1 ~ 40GHz
INPUT POWER (SYSTEM)	120Vac, 60 Hz	DETECTOR FUNCTION	Peak (PK) Average (AV)
ENVIRONMENTAL CONDITIONS	25deg. C, 69%RH	TESTED BY	Nelson Teng

ANTENNA POLARITY & TEST DISTANCE: HORIZONTAL AT 3 M								
NO.	FREQ. (MHz)	EMISSION LEVEL (dBuV/m)	LIMIT (dBuV/m)	MARGIN (dB)	ANTENNA HEIGHT (m)	TABLE ANGLE (Degree)	RAW VALUE (dBuV)	CORRECTION FACTOR (dB/m)
1	*5785.00	104.6 PK			1.45 H	68	62.43	42.17
2	*5785.00	94.9 AV			1.45 H	68	52.73	42.17
3	11570.00	58.7 PK	74.0	-15.3	1.13 H	241	10.51	48.19
4	11570.00	49.8 AV	54.0	-4.2	1.13 H	241	1.61	48.19
ANTENNA POLARITY & TEST DISTANCE: VERTICAL AT 3 M								
NO.	FREQ. (MHz)	EMISSION LEVEL (dBuV/m)	LIMIT (dBuV/m)	MARGIN (dB)	ANTENNA HEIGHT (m)	TABLE ANGLE (Degree)	RAW VALUE (dBuV)	CORRECTION FACTOR (dB/m)
1	*5785.00	110.4 PK			1.42 V	261	68.23	42.17
2	*5785.00	100.3 AV			1.42 V	261	58.13	42.17
3	11570.00	64.4 PK	74.0	-9.6	1.00 V	14	16.21	48.19
4	11570.00	53.1 AV	54.0	-0.9	1.00 V	14	4.91	48.19

- REMARKS:**
1. Emission level (dBuV/m) = Raw Value (dBuV) + Correction Factor (dB/m).
  2. Correction Factor (dB/m) = Antenna Factor (dB/m) + Cable Factor (dB).
  3. The other emission levels were very low against the limit.
  4. Margin value = Emission level – Limit value.
  5. “ \* ”: Fundamental frequency.
  6. The limit value is defined as per 15.247.



A D T

EUT TEST CONDITION		MEASUREMENT DETAIL	
CHANNEL	Channel 165	FREQUENCY RANGE	1 ~ 40GHz
INPUT POWER (SYSTEM)	120Vac, 60 Hz	DETECTOR FUNCTION	Peak (PK) Average (AV)
ENVIRONMENTAL CONDITIONS	25deg. C, 69%RH	TESTED BY	Nelson Teng

ANTENNA POLARITY & TEST DISTANCE: HORIZONTAL AT 3 M								
NO.	FREQ. (MHz)	EMISSION LEVEL (dBuV/m)	LIMIT (dBuV/m)	MARGIN (dB)	ANTENNA HEIGHT (m)	TABLE ANGLE (Degree)	RAW VALUE (dBuV)	CORRECTION FACTOR (dB/m)
1	*5825.00	105.1 PK			1.50 H	48	62.85	42.25
2	*5825.00	95.1 AV			1.50 H	48	52.85	42.25
3	11650.00	57.9 PK	74.0	-16.1	1.15 H	261	9.59	48.31
4	11650.00	49.0 AV	54.0	-5.0	1.15 H	261	0.69	48.31
ANTENNA POLARITY & TEST DISTANCE: VERTICAL AT 3 M								
NO.	FREQ. (MHz)	EMISSION LEVEL (dBuV/m)	LIMIT (dBuV/m)	MARGIN (dB)	ANTENNA HEIGHT (m)	TABLE ANGLE (Degree)	RAW VALUE (dBuV)	CORRECTION FACTOR (dB/m)
1	*5825.00	110.7 PK			1.41 V	265	68.45	42.25
2	*5825.00	100.6 AV			1.41 V	265	58.35	42.25
3	11650.00	64.2 PK	74.0	-9.8	1.00 V	23	15.89	48.31
4	11650.00	53.3 AV	54.0	-0.7	1.00 V	23	4.99	48.31

- REMARKS:**
1. Emission level (dBuV/m) = Raw Value (dBuV) + Correction Factor (dB/m).
  2. Correction Factor (dB/m) = Antenna Factor (dB/m) + Cable Factor (dB).
  3. The other emission levels were very low against the limit.
  4. Margin value = Emission level – Limit value.
  5. “ \* “: Fundamental frequency.
  6. The limit value is defined as per 15.247.



A D T

802.11n (40MHz) OFDM MODULATION

EUT TEST CONDITION		MEASUREMENT DETAIL	
CHANNEL	Channel 151	FREQUENCY RANGE	1 ~ 40GHz
INPUT POWER (SYSTEM)	120Vac, 60 Hz	DETECTOR FUNCTION	Peak (PK) Average (AV)
ENVIRONMENTAL CONDITIONS	25deg. C, 69%RH	TESTED BY	Nelson Teng

ANTENNA POLARITY & TEST DISTANCE: HORIZONTAL AT 3 M

NO.	FREQ. (MHz)	EMISSION LEVEL (dBuV/m)	LIMIT (dBuV/m)	MARGIN (dB)	ANTENNA HEIGHT (m)	TABLE ANGLE (Degree)	RAW VALUE (dBuV)	CORRECTION FACTOR (dB/m)
1	*5755.00	105.3 PK			1.54 H	73	63.24	42.06
2	*5755.00	95.2 AV			1.54 H	73	53.14	42.06
3	11510.00	58.6 PK	74.0	-15.4	1.16 H	259	10.42	48.18
4	11510.00	49.2 AV	54.0	-4.8	1.16 H	259	1.02	48.18

ANTENNA POLARITY & TEST DISTANCE: VERTICAL AT 3 M

NO.	FREQ. (MHz)	EMISSION LEVEL (dBuV/m)	LIMIT (dBuV/m)	MARGIN (dB)	ANTENNA HEIGHT (m)	TABLE ANGLE (Degree)	RAW VALUE (dBuV)	CORRECTION FACTOR (dB/m)
1	*5755.00	109.4 PK			1.42 V	264	67.34	42.06
2	*5755.00	99.3 AV			1.42 V	264	57.24	42.06
3	11510.00	64.4 PK	74.0	-9.6	1.00 V	25	16.22	48.18
4	11510.00	53.3 AV	54.0	-0.7	1.00 V	25	5.12	48.18

- REMARKS:**
1. Emission level (dBuV/m) = Raw Value (dBuV) + Correction Factor (dB/m).
  2. Correction Factor (dB/m) = Antenna Factor (dB/m) + Cable Factor (dB).
  3. The other emission levels were very low against the limit.
  4. Margin value = Emission level – Limit value.
  5. “ \* “: Fundamental frequency.
  6. The limit value is defined as per 15.247.



A D T

EUT TEST CONDITION		MEASUREMENT DETAIL	
CHANNEL	Channel 159	FREQUENCY RANGE	1 ~ 40GHz
INPUT POWER (SYSTEM)	120Vac, 60 Hz	DETECTOR FUNCTION	Peak (PK) Average (AV)
ENVIRONMENTAL CONDITIONS	25deg. C, 69%RH	TESTED BY	Nelson Teng

ANTENNA POLARITY & TEST DISTANCE: HORIZONTAL AT 3 M								
NO.	FREQ. (MHz)	EMISSION LEVEL (dBuV/m)	LIMIT (dBuV/m)	MARGIN (dB)	ANTENNA HEIGHT (m)	TABLE ANGLE (Degree)	RAW VALUE (dBuV)	CORRECTION FACTOR (dB/m)
1	*5795.00	105.2 PK			1.51 H	69	63.00	42.20
2	*5795.00	95.1 AV			1.51 H	69	52.90	42.20
3	11590.00	58.4 PK	74.0	-15.6	1.12 H	247	10.20	48.20
4	11590.00	49.5 AV	54.0	-4.5	1.12 H	247	1.30	48.20
ANTENNA POLARITY & TEST DISTANCE: VERTICAL AT 3 M								
NO.	FREQ. (MHz)	EMISSION LEVEL (dBuV/m)	LIMIT (dBuV/m)	MARGIN (dB)	ANTENNA HEIGHT (m)	TABLE ANGLE (Degree)	RAW VALUE (dBuV)	CORRECTION FACTOR (dB/m)
1	*5795.00	109.2 PK			1.41 V	264	67.00	42.20
2	*5795.00	99.1 AV			1.41 V	264	56.90	42.20
3	11590.00	64.5 PK	74.0	-9.5	1.00 V	49	16.30	48.20
4	11590.00	53.4 AV	54.0	-0.6	1.00 V	49	5.20	48.20

- REMARKS:**
1. Emission level (dBuV/m) = Raw Value (dBuV) + Correction Factor (dB/m).
  2. Correction Factor (dB/m) = Antenna Factor (dB/m) + Cable Factor (dB).
  3. The other emission levels were very low against the limit.
  4. Margin value = Emission level – Limit value.
  5. “ \* ”: Fundamental frequency.
  6. The limit value is defined as per 15.247.

### 5.3 6dB BANDWIDTH MEASUREMENT

#### 5.3.1 LIMITS OF 6dB BANDWIDTH MEASUREMENT

The minimum of 6dB Bandwidth Measurement is 0.5 MHz.

#### 5.3.2 TEST INSTRUMENTS

Test date: Oct. 18, 2011

DESCRIPTION & MANUFACTURER	MODEL NO.	SERIAL NO.	CALIBRATED DATE	CALIBRATED UNTIL
R&S Spectrum Analyzer	FSP40	100036	Dec. 08, 2010	Dec. 07, 2011

**NOTE:** The calibration interval of the above test instruments is 12 months and the calibrations are traceable to NML/ROC and NIST/USA.

#### 5.3.3 TEST PROCEDURE

The transmitter output was connected to the spectrum analyzer through an attenuator. The bandwidth of the fundamental frequency was measured by spectrum analyzer with 100kHz RBW and 300kHz VBW. The 6dB bandwidth is defined as the total spectrum the power of which is higher than peak power minus 6dB.

#### 5.3.4 DEVIATION FROM TEST STANDARD

No deviation

#### 5.3.5 TEST SETUP

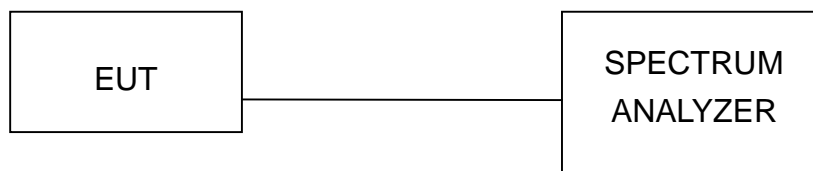

#### 5.3.6 EUT OPERATING CONDITIONS

The software provided by client to enable the EUT under transmission condition continuously at lowest, middle and highest channel frequencies individually.



A D T

### 5.3.7 TEST RESULTS

#### 802.11a OFDM MODULATION:

CHANNEL	CHANNEL FREQUENCY (MHz)	6dB BANDWIDTH (MHz)	MINIMUM LIMIT (MHz)	PASS / FAIL
149	5745	16.34	0.5	PASS
157	5785	16.35	0.5	PASS
165	5825	16.33	0.5	PASS

#### CH157

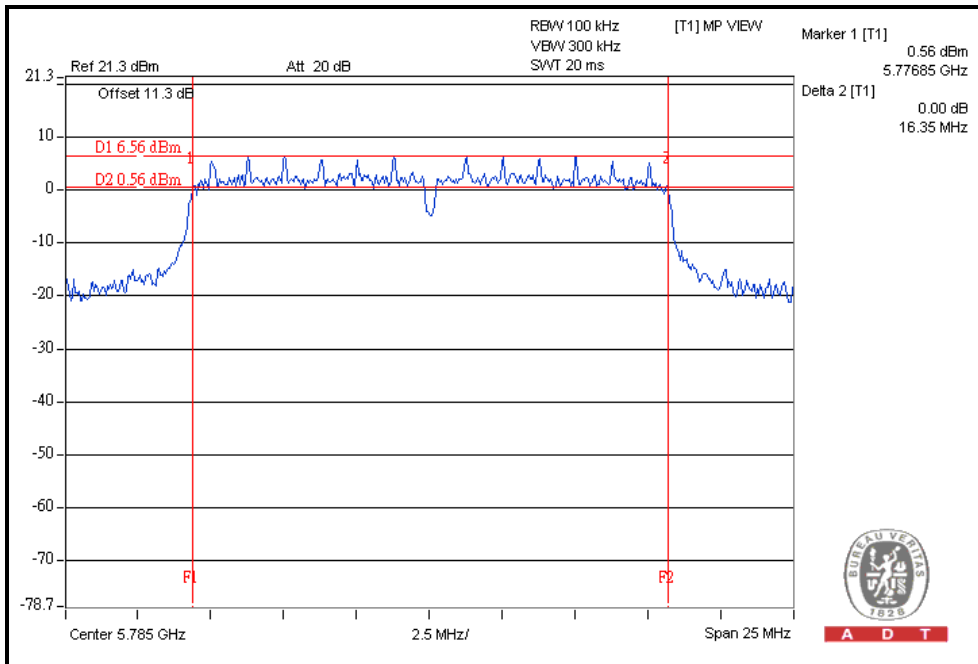



A D T

### 802.11n (20MHz) OFDM MODULATION:

CHANNEL	CHANNEL FREQUENCY (MHz)	6dB BANDWIDTH (MHz)		MINIMUM LIMIT (MHz)	PASS / FAIL
		CHAIN(0)	CHAIN(1)		
149	5745	16.57	16.18	0.5	PASS
157	5785	16.10	16.58	0.5	PASS
165	5825	16.56	16.58	0.5	PASS

For Chain(1): CH157

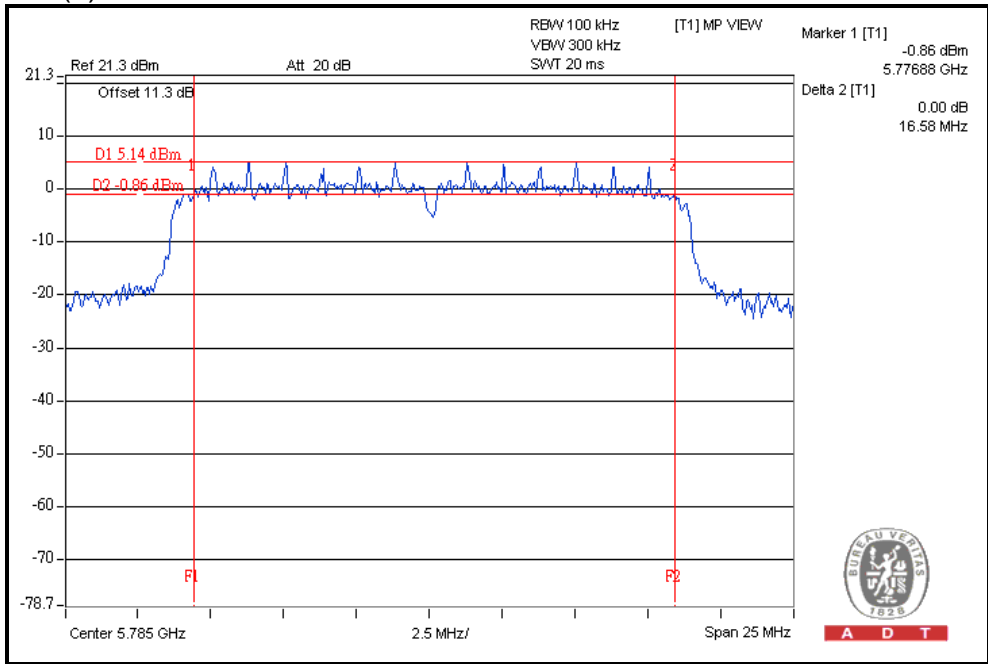



A D T

### 802.11n (40MHz) OFDM MODULATION:

CHANNEL	CHANNEL FREQUENCY (MHz)	6dB BANDWIDTH (MHz)		MINIMUM LIMIT (MHz)	PASS / FAIL
		CHAIN(0)	CHAIN(1)		
151	5755	35.53	35.36	0.5	PASS
159	5795	35.73	35.76	0.5	PASS

For Chain(1): CH159

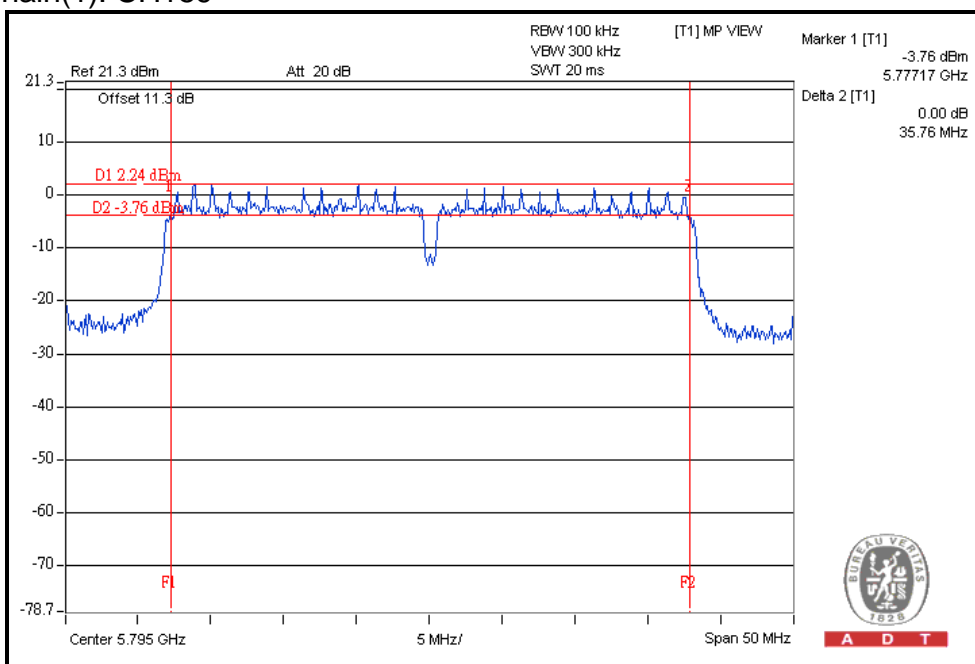



## 5.4 MAXIMUM PEAK OUTPUT POWER

### 5.4.1 LIMITS OF MAXIMUM PEAK OUTPUT POWER MEASUREMENT

The Maximum Peak Output Power Measurement is 30dBm.

### 5.4.2 INSTRUMENTS

Test date: Oct. 18, 2011

DESCRIPTION & MANUFACTURER	MODEL NO.	SERIAL NO.	CALIBRATED DATE	CALIBRATED UNTIL
Peak Power Meter	ML2495A	0824006	May 04, 2011	May 03, 2012
Power Sensor	MA2411B	0738172	May 03, 2011	May 02, 2012

**NOTE:** The calibration interval of the above test instruments is 12 months and the calibrations are traceable to NML/ROC and NIST/USA.

### 5.4.3 TEST PROCEDURES

1. The transmitter output was connected to the power meter through an attenuator; the bandwidth of the fundamental frequency was measured with the power meter.
2. Record the power level.

### 5.4.4 DEVIATION FROM TEST STANDARD

No deviation

### 5.4.5 TEST SETUP

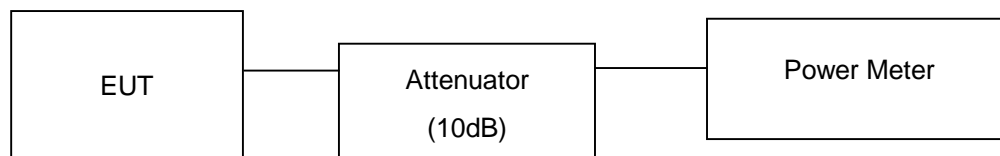

### 5.4.6 EUT OPERATING CONDITIONS

Same as Item 4.3.6



A D T

### 5.4.7 TEST RESULTS

#### 802.11a OFDM MODULATION:

CHANNEL	CHANNEL FREQUENCY (MHz)	PEAK POWER OUTPUT (mW)	PEAK POWER OUTPUT (dBm)	PEAK POWER LIMIT (dBm)	PASS / FAIL
149	5745	245.5	23.9	30	PASS
157	5785	245.5	23.9	30	PASS
165	5825	251.2	24.0	30	PASS

#### 802.11n (20MHz) OFDM MODULATION:

CHANNEL	CHANNEL FREQUENCY (MHz)	PEAK POWER OUTPUT (dBm)		TOTAL PEAK POWER (mW)	TOTAL PEAK POWER (dBm)	PEAK POWER LIMIT (dBm)	PASS / FAIL
		CHAIN(0)	CHAIN(1)				
149	5745	23.7	23.5	458.3	26.6	30	PASS
157	5785	23.6	23.3	442.9	26.5	30	PASS
165	5825	23.4	23.3	432.6	26.4	30	PASS

#### 802.11n (40MHz) OFDM MODULATION:

CHANNEL	CHANNEL FREQUENCY (MHz)	PEAK POWER OUTPUT (dBm)		TOTAL PEAK POWER (mW)	TOTAL PEAK POWER (dBm)	PEAK POWER LIMIT (dBm)	PASS / FAIL
		CHAIN(0)	CHAIN(1)				
151	5755	24.1	23.6	486.1	26.9	30	PASS
159	5795	23.7	23.7	468.8	26.7	30	PASS

## 5.5 POWER SPECTRAL DENSITY MEASUREMENT

### 5.5.1 LIMITS OF POWER SPECTRAL DENSITY MEASUREMENT

The Maximum of Power Spectral Density Measurement is 8dBm.

### 5.5.2 TEST INSTRUMENTS

Test date: Oct. 18, 2011

DESCRIPTION & MANUFACTURER	MODEL NO.	SERIAL NO.	CALIBRATED DATE	CALIBRATED UNTIL
R&S Spectrum Analyzer	FSP40	100036	Dec. 08, 2010	Dec. 07, 2011

**NOTE:** The calibration interval of the above test instruments is 12 months and the calibrations are traceable to NML/ROC and NIST/USA.

### 5.5.3 TEST PROCEDURE

The transmitter output was connected to the spectrum analyzer through an attenuator, the bandwidth of the fundamental frequency was measured with the spectrum analyzer using 3 kHz RBW and 30 kHz VBW, set sweep time = span/3 kHz. The power spectral density was measured and recorded.

The sweep time is allowed to be longer than span/3 kHz for a full response of the mixer in the spectrum analyzer.

### 5.5.4 DEVIATION FROM TEST STANDARD

No deviation

### 5.5.5 TEST SETUP



### 5.5.6 EUT OPERATING CONDITION

Same as Item 4.3.6



A D T

### 5.5.7 TEST RESULTS

#### 802.11a OFDM MODULATION:

CHANNEL	CHANNEL FREQUENCY (MHz)	RF POWER LEVEL IN 3kHz BW (dBm)	MAXIMUM LIMIT (dBm)	PASS / FAIL
149	5745	-9.3	8	PASS
157	5785	-10.4	8	PASS
165	5825	-10.7	8	PASS

#### CH149

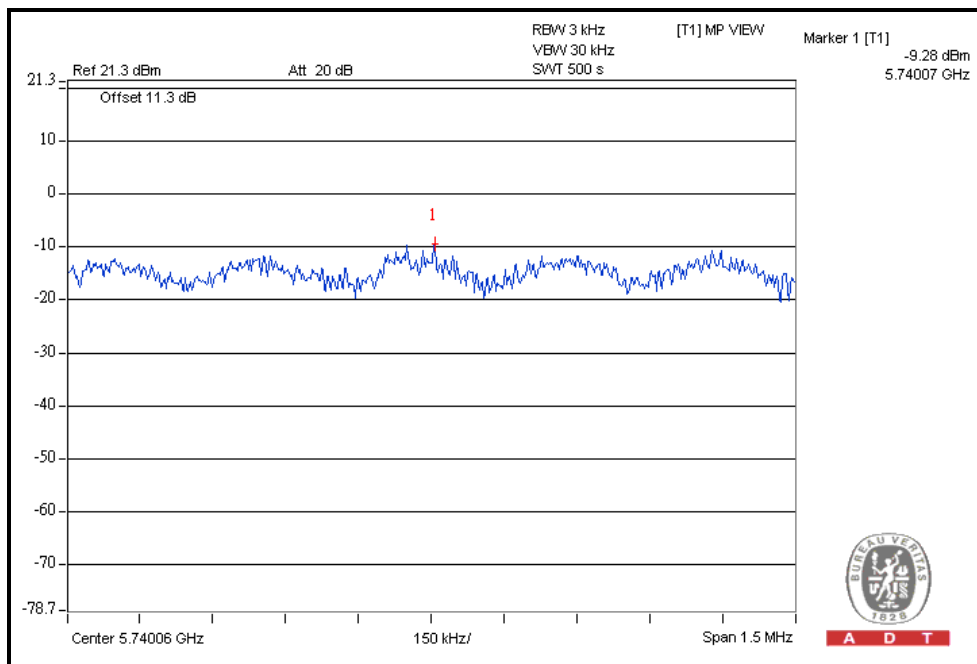



A D T

### 802.11n (20MHz) OFDM MODULATION:

CHANNEL	CHANNEL FREQUENCY (MHz)	RF POWER LEVEL IN 3kHz BW (dBm)		TOTAL POWER DENSITY (dBm)	MAXIMUM LIMIT (dBm)	PASS / FAIL
		CHAIN(0)	CHAIN(1)			
149	5745	-7.9	-10.1	-5.9	8	PASS
157	5785	-9.3	-11.7	-7.3	8	PASS
165	5825	-10.6	-11.0	-7.8	8	PASS

For Chain(0): CH149

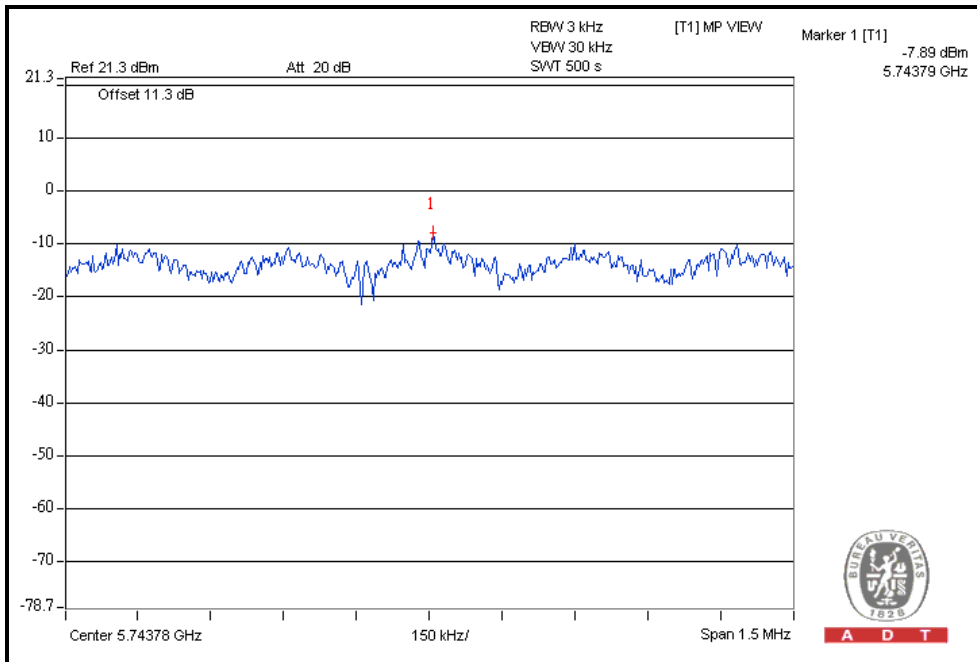



A D T

### 802.11n (40MHz) OFDM MODULATION:

CHANNEL	CHANNEL FREQUENCY (MHz)	RF POWER LEVEL IN 3kHz BW (dBm)		TOTAL POWER DENSITY (dBm)	MAXIMUM LIMIT (dBm)	PASS / FAIL
		CHAIN(0)	CHAIN(1)			
151	5755	-12.3	-12.2	-9.2	8	PASS
159	5795	-13.1	-13.4	-10.2	8	PASS

For Chain(1): CH151

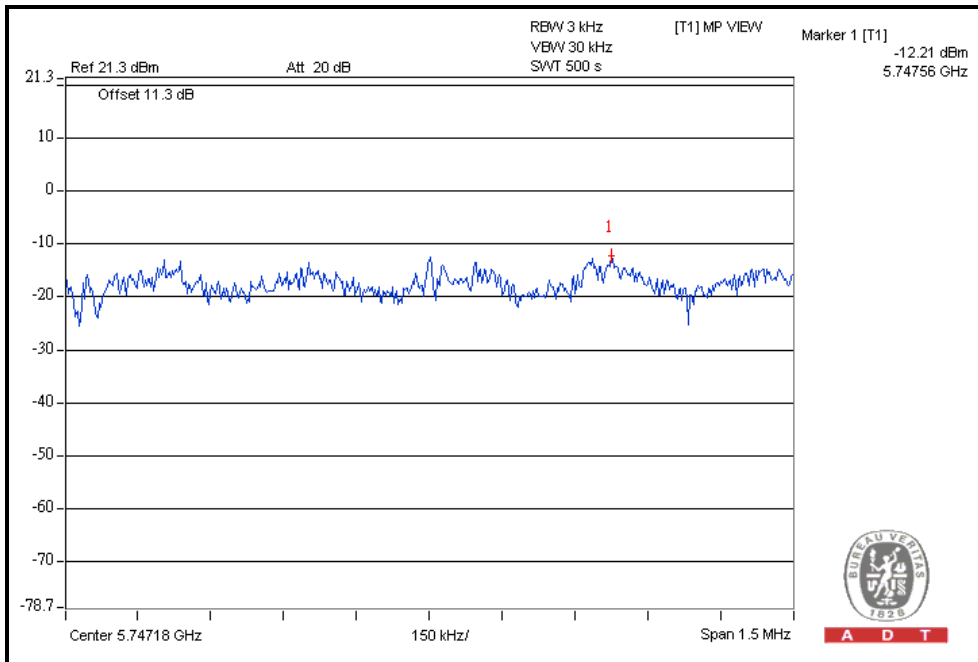

## 5.6 CONDUCTED OUT-BAND EMISSION MEASUREMENT

### 5.6.1 LIMITS OF CONDUCTED OUT-BAND EMISSION MEASUREMENT

Below  $-20\text{dB}$  of the highest emission level of operating band (in 100kHz Resolution Bandwidth).

### 5.6.2 TEST INSTRUMENTS

**Test date: Oct. 18, 2011**

DESCRIPTION & MANUFACTURER	MODEL NO.	SERIAL NO.	CALIBRATED DATE	CALIBRATED UNTIL
R&S Spectrum Analyzer	FSP40	100036	Dec. 08, 2010	Dec. 07, 2011

**NOTE:** The calibration interval of the above test instruments is 12 months and the calibrations are traceable to NML/ROC and NIST/USA.

### 5.6.3 TEST PROCEDURE

The transmitter output was connected to the spectrum analyzer via a low loss cable. Set RBW of spectrum analyzer to 100 kHz with suitable frequency span including 100MHz or 200MHz bandwidth from band edge. The band edges was measured and recorded.

### 5.6.4 DEVIATION FROM TEST STANDARD

No deviation

### 5.6.5 EUT OPERATING CONDITION

Same as Item 4.3.6

### 5.6.6 TEST RESULTS

The spectrum plots are attached on the following pages. D2 line indicates the highest level, D1 line indicates the 20dB offset below D2. It shows compliance with the requirement in part 15.247(d).



A D T

## Performing measurements: Measure and add 10 log(N) dB 802.11a OFDM modulation

CH149

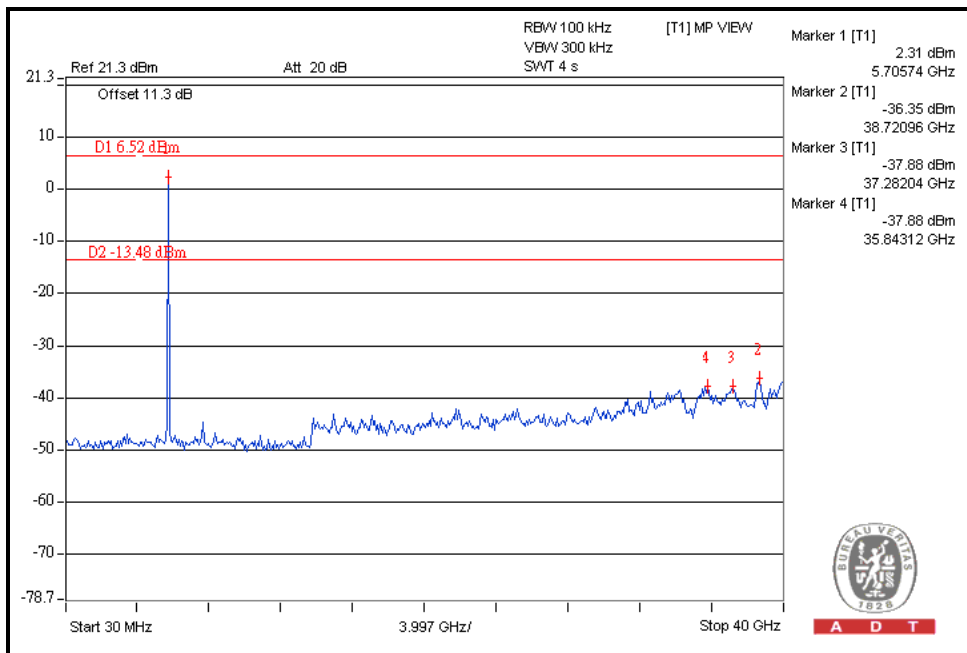
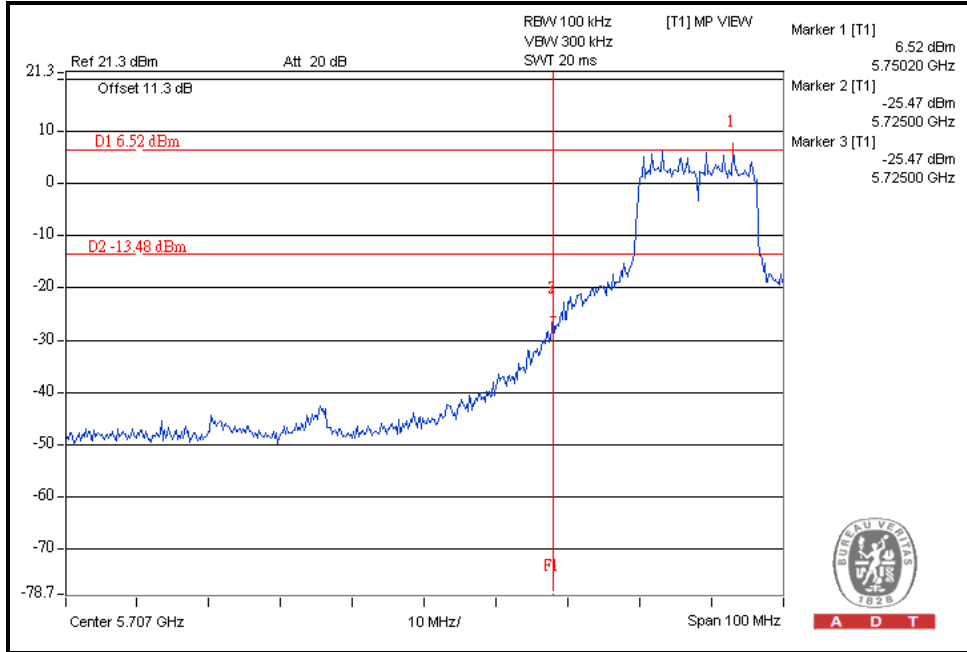





A D T

# CH165

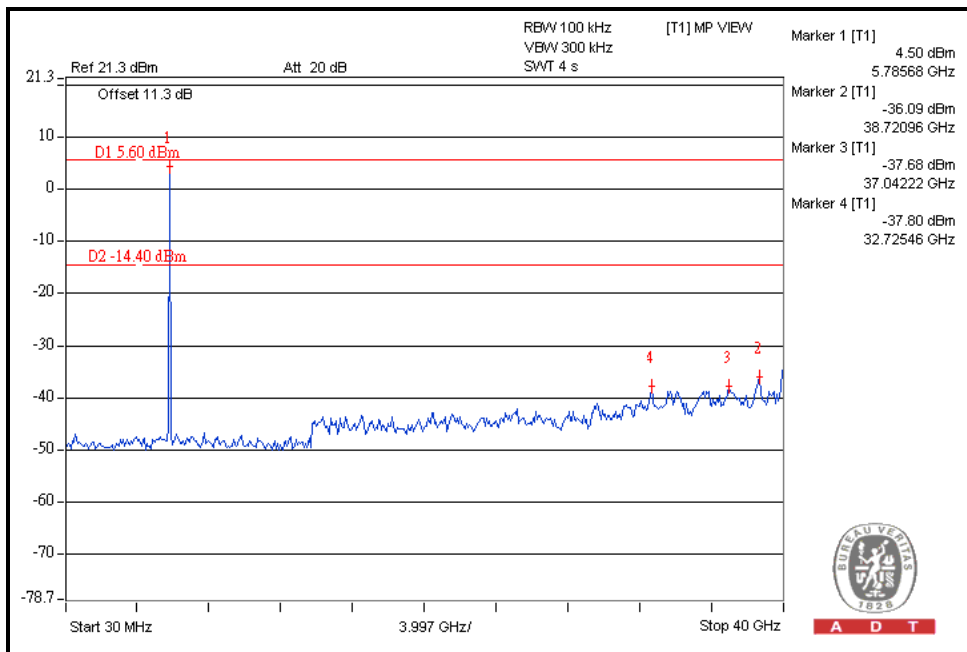
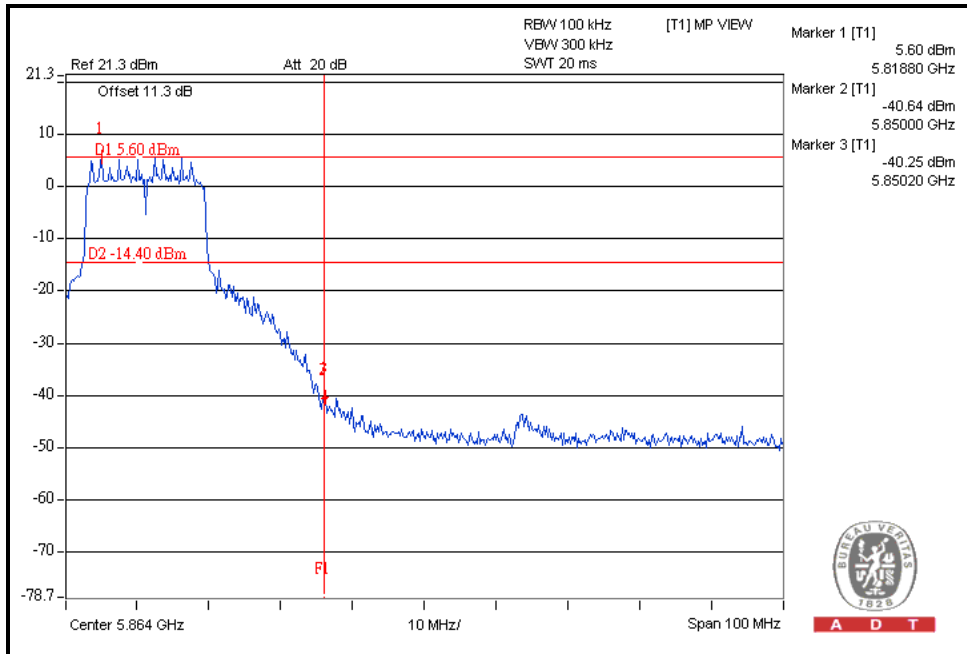



A D T

## 802.11n (20MHz) OFDM MODULATION:

### CH149

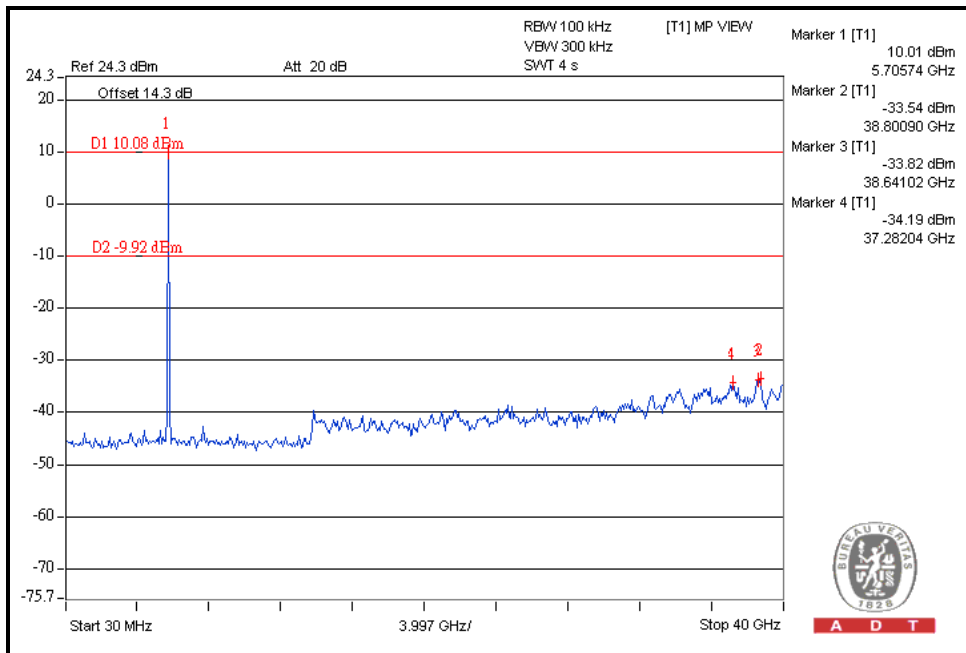
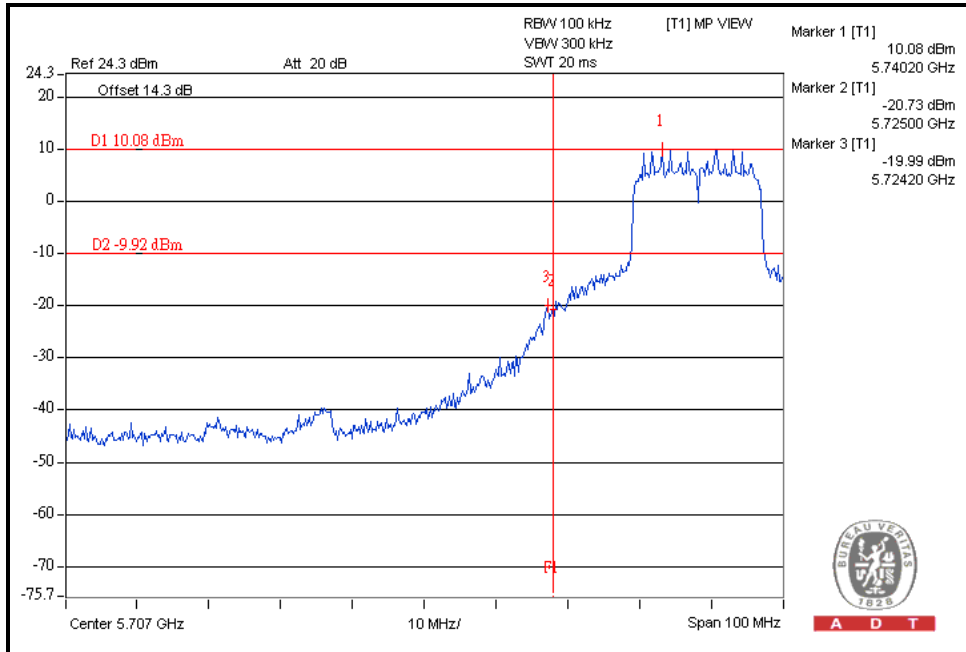



A D T

# CH165

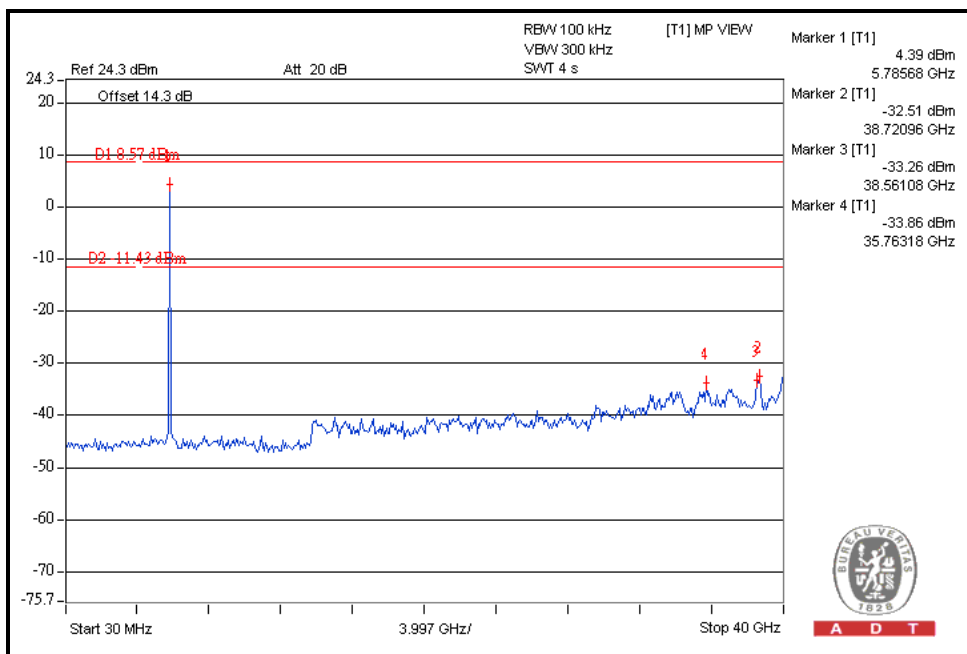
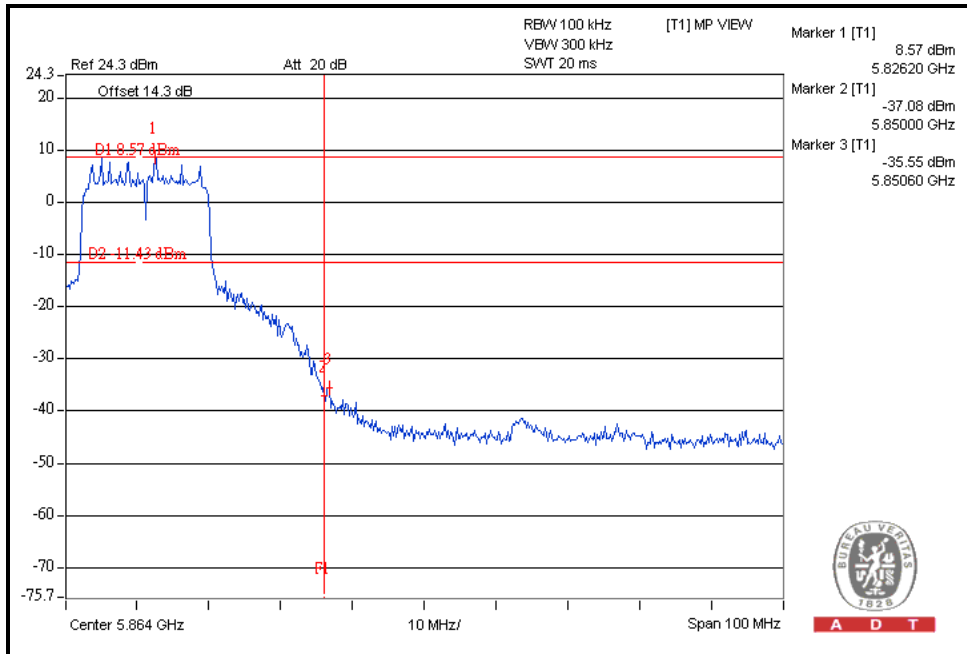



A D T

### 802.11n (40MHz) OFDM MODULATION:

### CH151

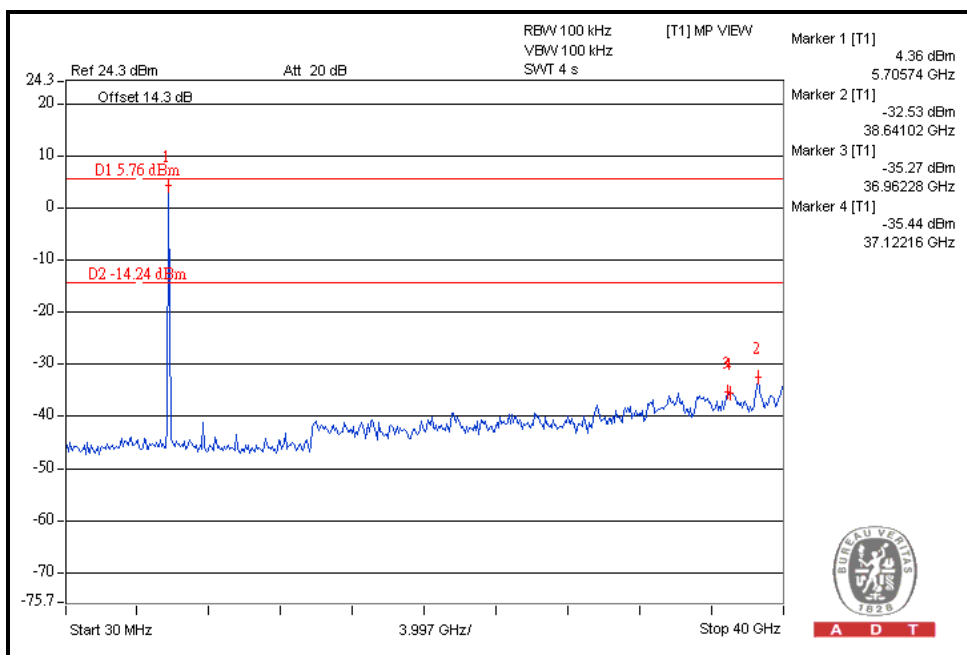
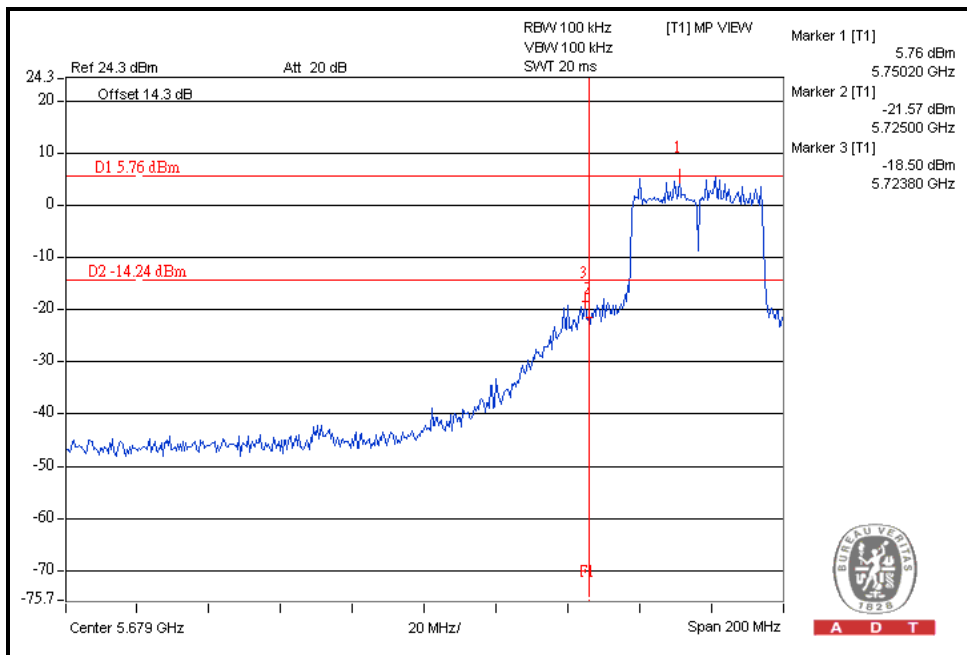



A D T

# CH159

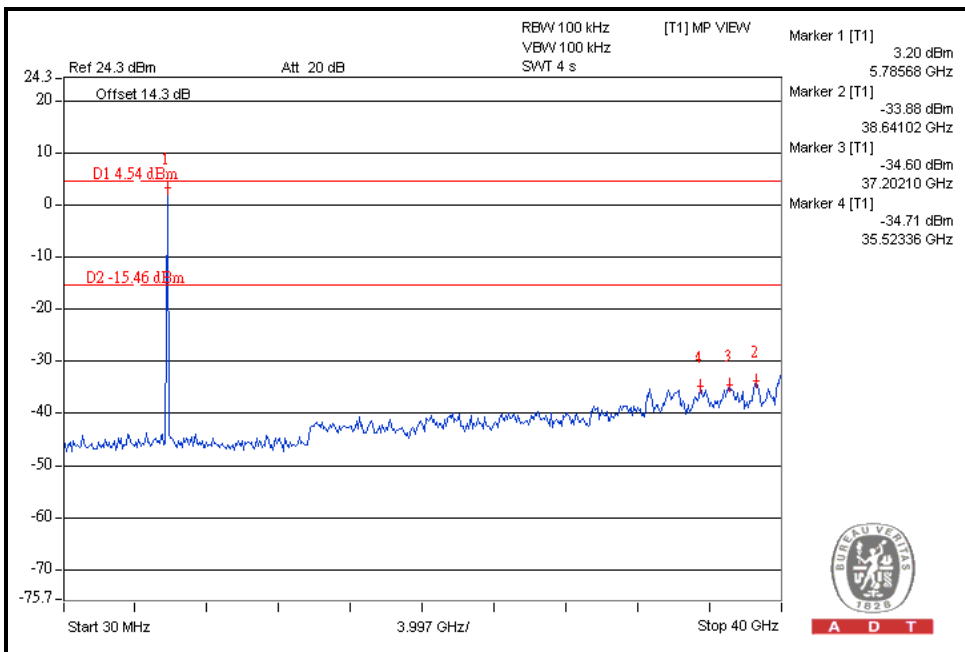
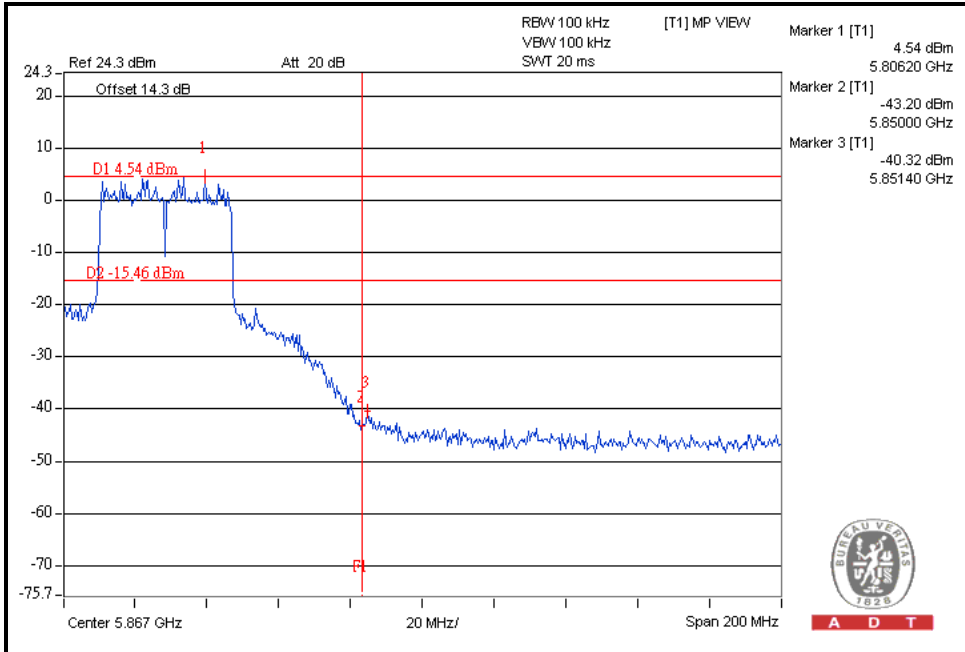



## 6. INFORMATION ON THE TESTING LABORATORIES

We, Bureau Veritas Consumer Products Services (H.K.) Ltd., Taoyuan Branch, were founded in 1988 to provide our best service in EMC, Radio, Telecom and Safety consultation. Our laboratories are accredited and approved according to ISO/IEC 17025.

Copies of accreditation and authorization certificates of our laboratories obtained from approval agencies can be downloaded from our web site:

[www.adt.com.tw/index.5.phtml](http://www.adt.com.tw/index.5.phtml).

If you have any comments, please feel free to contact us at the following:

**Linko EMC/RF Lab:**

Tel: 886-2-26052180

Fax: 886-2-26052943

**Hsin Chu EMC/RF Lab:**

Tel: 886-3-5935343

Fax: 886-3-5935342

**Hwa Ya EMC/RF/Safety/Telecom Lab:**

Tel: 886-3-3183232

Fax: 886-3-3185050

**Email:** [service.adt@tw.bureauveritas.com](mailto:service.adt@tw.bureauveritas.com)

**Web Site:** [www.adt.com.tw](http://www.adt.com.tw)

The address and road map of all our labs can be found in our web site also.



A D T

## **7.APPENDIX A - MODIFICATIONS RECORDERS FOR ENGINEERING CHANGES TO THE EUT BY THE LAB**

No any modifications are made to the EUT by the lab during the test.

**--- END ---**