



# FCC TEST REPORT (15.407)

**REPORT NO.:** RF980110H01-1

**MODEL NO.:** DWA-160

**RECEIVED:** Jan. 10, 2009

**TESTED:** March 17 to April 09, 2009

**ISSUED:** May 19, 2009

**APPLICANT:** D-Link Co.

**ADDRESS:** No.289, Shinhu 3rd Rd., Neihu District,  
Taipei City 114, Taiwan, R.O.C.

**ISSUED BY:** Bureau Veritas Consumer Products Services  
(H.K.) Ltd., Taoyuan Branch

**TEST LOCATION:** No. 81-1, Lu Liao Keng, 9th Ling,Wu Lung  
Tsuen, Chiung Lin Hsiang, Hsin Chu Hsien  
307, Taiwan

This test report consists of 247 pages in total. It may be duplicated completely for legal use with the approval of the applicant. It should not be reproduced except in full, without the written approval of our laboratory. The client should not use it to claim product endorsement by TAF or any government agencies. The test results in the report only apply to the tested sample.





## Table of Contents

1.	CERTIFICATION .....	4
2.	SUMMARY OF TEST RESULTS .....	5
2.1	MEASUREMENT UNCERTAINTY .....	6
3.	GENERAL INFORMATION .....	7
3.1	GENERAL DESCRIPTION OF EUT .....	7
3.2	DESCRIPTION OF TEST MODES .....	10
3.2.1	TEST MODE APPLICABILITY AND TESTED CHANNEL DETAIL: .....	12
3.3	GENERAL DESCRIPTION OF APPLIED STANDARDS .....	15
3.4	DESCRIPTION OF SUPPORT UNITS.....	16
3.5	CONFIGURATION OF SYSTEM UNDER TEST .....	17
4.	TEST TYPES AND RESULTS .....	19
4.1	CONDUCTED EMISSION MEASUREMENT .....	19
4.1.1	LIMITS OF CONDUCTED EMISSION MEASUREMENT .....	19
4.1.2	TEST INSTRUMENTS.....	19
4.1.3	TEST PROCEDURES .....	20
4.1.4	DEVIATION FROM TEST STANDARD .....	20
4.1.5	TEST SETUP .....	21
4.1.6	EUT OPERATING CONDITIONS .....	21
4.1.7	TEST RESULTS .....	22
4.2	RADIATED EMISSION MEASUREMENT .....	24
4.2.1	LIMITS OF RADIATED EMISSION MEASUREMENT.....	24
4.2.2	LIMITS OF UNWANTED EMISSION OUT OF THE RESTRICTED BANDS.....	25
4.2.3	TEST INSTRUMENTS.....	26
4.2.4	TEST PROCEDURES .....	27
4.2.5	DEVIATION FROM TEST STANDARD .....	27
4.2.6	TEST SETUP .....	28
4.2.7	EUT OPERATING CONDITION.....	28
	<b>BELOW 1GHZ TEST DATA</b> .....	29
4.2.8	TEST RESULTS .....	29
	<b>ABOVE 1GHZ TEST DATA</b> .....	30
4.2.9	TEST RESULTS .....	30
4.3	PEAK TRANSMIT POWER MEASUREMENT .....	81
4.3.1	LIMITS OF PEAK TRANSMIT POWER MEASUREMENT .....	81
4.3.2	TEST INSTRUMENTS.....	81
4.3.3	TEST PROCEDURE.....	82
4.3.4	DEVIATION FROM TEST STANDARD .....	82
4.3.5	TEST SETUP .....	82
4.3.6	EUT OPERATING CONDITIONS .....	82



4.3.7	TEST RESULTS .....	83
4.4	PEAK POWER EXCURSION MEASUREMENT .....	142
4.4.1	LIMITS OF PEAK POWER EXCURSION MEASUREMENT .....	142
4.4.2	TEST INSTRUMENTS.....	142
4.4.3	TEST PROCEDURE.....	143
4.4.4	DEVIATION FROM TEST STANDARD .....	143
4.4.5	TEST SETUP .....	143
4.4.6	EUT OPERATING CONDITIONS .....	143
4.4.7	TEST RESULTS .....	144
4.5	PEAK POWER SPECTRAL DENSITY MEASUREMENT .....	175
4.5.1	LIMITS OF PEAK POWER SPECTRAL DENSITY MEASUREMENT .....	175
4.5.2	TEST INSTRUMENTS.....	175
4.5.3	TEST PROCEDURES .....	176
4.5.4	DEVIATION FROM TEST STANDARD .....	176
4.5.5	TEST SETUP .....	176
4.5.6	EUT OPERATING CONDITIONS .....	176
4.5.7	TEST RESULTS .....	177
4.6	FREQUENCY STABILITY.....	208
4.6.1	LIMITS OF FREQUENCY STABILITY MEASUREMENT .....	208
4.6.2	TEST INSTRUMENTS.....	208
4.6.3	TEST PROCEDURE.....	208
4.6.4	DEVIATION FROM TEST STANDARD .....	209
4.6.5	TEST SETUP .....	209
4.6.6	EUT OPERATING CONDITION.....	209
4.6.7	TEST RESULTS .....	210
4.7	CONDUCTED OUT-BAND EMISSION MEASUREMENT .....	211
4.7.1	TEST INSTRUMENTS.....	211
4.7.2	TEST PROCEDURE.....	211
4.7.3	EUT OPERATING CONDITION.....	211
4.7.4	TEST RESULTS .....	212
4.8	ANTENNA REQUIREMENT .....	245
4.8.1	STANDARD APPLICABLE.....	245
4.8.2	ANTENNA CONNECTED CONSTRUCTION.....	245
5.	INFORMATION ON THE TESTING LABORATORIES .....	246
6.	APPENDIX-A- MODIFICATIONS RECORDERS FOR ENGINEERING CHANGES TO THE EUT BY THE LAB.....	247



## 1. CERTIFICATION

**PRODUCT:** Xtreme N Dual Band USB Adapter  
**BRAND NAME:** D-Link  
**MODEL NO.:** DWA-160  
**TEST SAMPLE:** MASS-PRODUCTION  
**TESTED:** March 17 to April 09, 2009  
**APPLICANT:** D-Link Co.  
**STANDARDS:** FCC Part 15, Subpart E (Section 15.407),  
ANSI C63.4-2003

The above equipment (Model: DWA-160) has been tested by **Bureau Veritas Consumer Products Services (H.K.) Ltd., Taoyuan Branch**, and found compliance with the requirement of the above standards. The test record, data evaluation & Equipment Under Test (EUT) configurations represented herein are true and accurate accounts of the measurements of the sample's EMC characteristics under the conditions specified in this report.

**PREPARED BY** :  , **DATE:** May 19, 2009  
( Claire Kuan, Specialist )

**TECHNICAL ACCEPTANCE** :  , **DATE:** May 19, 2009  
Responsible for RF ( Hank Chung, Deputy Manager )

**APPROVED BY** :  , **DATE:** May 19, 2009  
(May Chen, Deputy Manager )



## 2. SUMMARY OF TEST RESULTS

The EUT has been tested according to the following specifications:

For [802.11a](#)

APPLIED STANDARD: FCC Part 15, Subpart E (Section 15.407)			
Standard Section	Test Type	Result	Remark
15.407(b)(5)	AC Power Conducted Emission	PASS	Meet the requirement of limit. Minimum passing margin is -3.98dB at 0.176MHz
15.407(b/1/2/3)(b)(5)	Electric Field Strength Spurious Emissions, 30MHz ~ 40000MHz	PASS	Meet the requirement of limit. Minimum passing margin is -1.44dB at 5350.00MHz
15.407(a/1/2/3)	Peak Transmit Power	PASS	Meet the requirement of limit.
15.407(a)(6)	Peak Power Excursion	PASS	Meet the requirement of limit.
15.407(a/1/2/3)	Peak Power Spectral Density	PASS	Meet the requirement of limit.
15.407(g)	Frequency Stability	PASS	Meet the requirement of limit.

**NOTE:**

1. The EUT was operating in 2.412 ~ 2.462GHz, 5.15~5.35GHz, 5.47~5.725GHz and 5.725~5.825GHz frequencies band. This report was recorded the RF parameters including 5.15~5.35GHz, 5.47~5.725GHz and 5.725~5.825GHz. For the 2.412 ~ 2.462GHz RF parameters was recorded in another test report.

## 2.1 MEASUREMENT UNCERTAINTY

Where relevant, the following measurement uncertainty levels have been estimated for tests performed on the EUT as specified in CISPR 16-4-2:

This uncertainty represents an expanded uncertainty expressed at approximately the 95% confidence level using a coverage factor of  $k=2$ .

Measurement	Value
Conducted emissions	2.44 dB
Radiated emissions (30MHz-1GHz)	3.94 dB
Radiated emissions (1GHz -18GHz)	2.49 dB
Radiated emissions (18GHz -40GHz)	2.70 dB



### 3. GENERAL INFORMATION

#### 3.1 GENERAL DESCRIPTION OF EUT

<b>PRODUCT</b>	Xtreme N Dual Band USB Adapter
<b>MODEL NO.</b>	DWA-160
<b>FCC ID</b>	KA2WA160A2
<b>POWER SUPPLY</b>	DC 5V ±10% from host equipment
<b>MODULATION TYPE</b>	CCK, DQPSK, DBPSK for DSSS 64QAM, 16QAM, QPSK, BPSK for OFDM
<b>MODULATION TECHNOLOGY</b>	DSSS, OFDM
<b>TRANSFER RATE</b>	802.11b: 11 / 5.5 / 2 / 1Mbps 802.11a / g: 54 / 48 / 36 / 24 / 18 / 12 / 9 / 6Mbps HT20 MCS0~7 (800ns GI): 65 / 58.5 / 52 / 39 / 26 / 19.5 / 13 / 6.5Mbps. HT20 MCS8~15 (800ns GI): 130 / 117 / 104 / 78 / 52 / 39 / 26 / 13Mbps. HT40 MCS0~7 (800ns GI): 135 / 121.5 / 108 / 81 / 54 / 40.5 / 27 / 13.5Mbps. HT40 MCS8~15 (800ns GI): 270 / 243 / 216 / 162 / 108 / 81 / 54 / 27Mbps.
<b>OPERATING FREQUENCY</b>	<b>For 15.247</b> 802.11b & 802.11g: 2412 ~ 2462MHz <b>For 15.407</b> 5.18 ~ 5.32GHz, 5.50 ~ 5.70GHz, 5.745 ~ 5.805GHz
<b>NUMBER OF CHANNEL</b>	<b>For 15.247(2.4GHz)</b> 11 for 802.11b, 802.11g, draft 802.11n (20MHz) 7 for draft 802.11n (40MHz) <b>For 15.407(5GHz)</b> 23 for 802.11a, draft 802.11n (20MHz) 11 for draft 802.11n (40MHz)



<b>MAXIMUM OUTPUT POWER</b>	<b>For 15.247(2.4GHz)</b> 802.11b: 133.045mW 802.11g: 193.642mW draft 802.11n (20MHz): 246.315mW draft 802.11n (40MHz): 223.365mW
	<b>For 15.407(5GHz)</b> <b>5150MHz ~ 5350MHz</b> 802.11a: 39.084mW draft 802.11n (20MHz): 67.871mW draft 802.11n (40MHz): 61.532mW
	<b>5470MHz ~ 5725MHz</b> 802.11a: 41.210mW draft 802.11n (20MHz): 66.088mW draft 802.11n (40MHz): 56.916mW
	<b>5725 ~ 5825MHz</b> 802.11a: 38.994mW draft 802.11n (20MHz): 63.535mW draft 802.11n (40MHz): 58.440mW
	<b>ANTENNA TYPE</b>
<b>DATA CABLE</b>	NA
<b>INTERFACE</b>	USB
<b>ASSOCIATED DEVICES</b>	Cradle (with 1m cable, Unshielded)

**NOTE:**

1. There are two antennas provided to this EUT, please refer to the following table:

Chain	Antenna Type	For 2.4GHz Gain (dBi)	For 5GHz Gain (dBi)				Antenna Connector
			5.15~5.25GHz	5.25~5.35GHz	5.47~5.725GHz	5.725~5.825GHz	
0	PCB Printed	0.29	-0.14	-0.86	0.21	0.14	NA
1	PCB Printed						

2. The EUT incorporates a MIMO function with 802.11a, 802.11b, 802.11g, draft 802.11n. Physically, the EUT provides two completed transmit and two completed receivers.

3. The EUT is 2 \* 2 spatial MIMO (2Tx & 2Rx) without beam forming function. The antenna configurations are two transmitter antennas and two receiver antennas, as there are 2 PCB Printed antennas. Spatial multiplexing modes for simultaneous transmission using 2 antennas, and for simultaneous receiver using 2 antennas. The legacy 11bg and legacy 11a modes are limited to single transmitter mode only.

4. When the EUT operating in draft 802.11n, the software operation, which is defined by manufacturer, MCS (Modulation and Coding Schemes) from 0 to 15.





A D T

5. The EUT complies with draft 802.11n standards and backwards compatible with 802.11a, 802.11b, 802.11g products.

6. The EUT was pre-tested in chamber as the following test modes:

TEST MODE	DESCRIPTION
Mode A	With Cradle
Mode B	Without Cradle

The worst case was found in Mode A. Its test data were recorded in this report individually.

7. The above EUT information was declared by manufacturer and for more detailed features description, please refer to the manufacturer's specifications or user's manual.

### 3.2 DESCRIPTION OF TEST MODES

#### Operated in 5150MHz ~ 5350MHz bands:

Eight channels are provided for 802.11a and draft 802.11n (20MHz):

CHANNEL	FREQUENCY
1	5180 MHz
2	5200 MHz
3	5220 MHz
4	5240 MHz
5	5260 MHz
6	5280 MHz
7	5300 MHz
8	5320 MHz

Four channels are provided for draft 802.11n (40MHz):

CHANNEL	FREQUENCY
1	5190 MHz
2	5230 MHz
3	5270 MHz
4	5310 MHz



**Operated in 5470MHz ~ 5725MHz bands:**

Eleven channels are provided for 802.11a and draft 802.11n (20MHz):

CHANNEL	FREQUENCY
9	5500 MHz
10	5520 MHz
11	5540 MHz
12	5560 MHz
13	5580 MHz
14	5600 MHz
15	5620 MHz
16	5640 MHz
17	5660 MHz
18	5680 MHz
19	5700 MHz

Five channels are provided for draft 802.11n (40MHz):

CHANNEL	FREQUENCY
5	5510 MHz
6	5550 MHz
7	5590 MHz
8	5630 MHz
9	5670 MHz

**Operated in 5725 ~ 5825MHz band:**

Four channels are provided for 802.11a, draft 802.11n (20MHz):

CHANNEL	FREQUENCY
20	5745 MHz
21	5765 MHz
22	5785 MHz
23	5805 MHz

Two channels are provided for draft 802.11n (40MHz):

CHANNEL	FREQUENCY
10	5755 MHz
11	5795 MHz



### 3.2.1 TEST MODE APPLICABILITY AND TESTED CHANNEL DETAIL:

EUT CONFIGURE MODE	APPLICABLE TO				DESCRIPTION
	PLC	RE < 1G	RE ≥ 1G	APCM	
-	√	√	√	√	-

Where **PLC:** Power Line Conducted Emission

**RE < 1G:** Radiated Emission below 1GHz

**RE ≥ 1G:** Radiated Emission above 1GHz

**APCM:** Antenna Port Conducted Measurement

### ANTENNA COMBINATION MODE:

COMBINATION MODE	OPERATION MODE	CHAIN(0) (TX/RX)	CHAIN(1) (TX/RX)
A	802.11a	√	-
B	DRAFT 802.11n(20MHz) MCS0~7	√	-
C	DRAFT 802.11n(20MHz) MCS8~15	√	√
D	DRAFT 802.11n(40MHz) MCS0~7	√	-
E	DRAFT 802.11n(40MHz) MCS8~15	√	√

Note:

1. The above information was declared by manufacturer and for more detailed features description, please refer to the manufacturer's specifications or user's manual.
2. Antenna 1 and Antenna 2 are PCB Printed antennas.



**POWER LINE CONDUCTED EMISSION TEST:**

- Pre-Scan has been conducted to determine the worst-case mode from all possible combinations between available modulations, data rates and antenna ports (if EUT with antenna diversity architecture).
- Following channel(s) was (were) selected for the final test as listed below.

MODE	AVAILABLE CHANNEL	TESTED CHANNEL	MODULATION TECHNOLOGY	MODULATION TYPE	DATA RATE (Mbps)	TX COMBINATION
Draft 802.11n (20MHz)	1 to 8	8	OFDM	BPSK	13	C

**RADIATED EMISSION TEST (BELOW 1 GHz):**

- Pre-Scan has been conducted to determine the worst-case mode from all possible combinations between available modulations, data rates and antenna ports (if EUT with antenna diversity architecture).
- Following channel(s) was (were) selected for the final test as listed below.

MODE	AVAILABLE CHANNEL	TESTED CHANNEL	MODULATION TECHNOLOGY	MODULATION TYPE	DATA RATE (Mbps)	TX COMBINATION
Draft 802.11n (20MHz)	1 to 8	8	OFDM	BPSK	13	C

**RADIATED EMISSION TEST (ABOVE 1 GHz):**

- Pre-Scan has been conducted to determine the worst-case mode from all possible combinations between available modulations, data rates and antenna ports (if EUT with antenna diversity architecture).
- Following channel(s) was (were) selected for the final test as listed below.

MODE	AVAILABLE CHANNEL	TESTED CHANNEL	MODULATION TECHNOLOGY	MODULATION TYPE	DATA RATE (Mbps)	TX COMBINATION
802.11a	1 to 23	1, 2, 4, 5, 7, 8, 9, 14, 19, 20, 22, 23	OFDM	BPSK	6	A
For 5 GHz Draft 802.11n (20MHz)	1 to 23	1, 2, 4, 5, 7, 8, 9, 14, 19, 20, 22, 23	OFDM	BPSK	13	C
For 5 GHz Draft 802.11n (40MHz)	1 to 12	1, 2, 3, 4, 5, 7, 9, 10, 11	OFDM	BPSK	27	E



**CONDUCTED OUT-BAND EMISSION MEASUREMENT:**

- Pre-Scan has been conducted to determine the worst-case mode from all possible combinations between available modulations, data rates and antenna ports (if EUT with antenna diversity architecture).
- Following channel(s) was (were) selected for the final test as listed below.

MODE	AVAILABLE CHANNEL	TESTED CHANNEL	MODULATION TECHNOLOGY	MODULATION TYPE	DATA RATE (Mbps)	TX COMBINATION
802.11a	1 to 23	1, 8, 9, 19, 20, 23	OFDM	BPSK	6	A
For 5 GHz Draft 802.11n (20MHz)	1 to 23	1, 8, 9, 19, 20, 23	OFDM	BPSK	13	C
For 5 GHz Draft 802.11n (40MHz)	1 to 12	1, 4, 5, 9, 10, 11	OFDM	BPSK	27	E

**ANTENNA PORT CONDUCTED MEASUREMENT:**

- Pre-Scan has been conducted to determine the worst-case mode from all possible combinations between available modulations, data rates and antenna ports (if EUT with antenna diversity architecture).
- Following channel(s) was (were) selected for the final test as listed below.

MODE	AVAILABLE CHANNEL	TESTED CHANNEL	MODULATION TECHNOLOGY	MODULATION TYPE	DATA RATE (Mbps)	TX COMBINATION
802.11a	1 to 23	1, 2, 4, 5, 7, 8, 9, 14, 19, 20, 22, 23	OFDM	BPSK	6	A
For 5 GHz Draft 802.11n (20MHz)	1 to 23	1, 2, 4, 5, 7, 8, 9, 14, 19, 20, 22, 23	OFDM	BPSK	13	C
For 5 GHz Draft 802.11n (40MHz)	1 to 12	1, 2, 3, 4, 5, 7, 9, 10, 11	OFDM	BPSK	27	E

### 3.3 GENERAL DESCRIPTION OF APPLIED STANDARDS

The EUT is a Xtreme N Dual Band USB Adapter. According to the specifications of the manufacturer, it must comply with the requirements of the following standards:

**FCC Part 15, Subpart E (15.407)**

**ANSI C63.4-2003**

All test items have been performed and recorded as per the above standards.

**NOTE:** The EUT is also considered as a kind of computer peripheral, because the connection to computer is necessary for typical use. It has been verified to comply with the requirements of FCC Part 15, Subpart B, Class B (DoC). The test report has been issued separately.



### 3.4 DESCRIPTION OF SUPPORT UNITS

The EUT has been tested as an independent unit together with other necessary accessories or support units. The following support units or accessories were used to form a representative test configuration during the tests.

NO.	PRODUCT	BRAND	MODEL NO.	SERIAL NO.	FCC ID
1	NOTEBOOK COMPUTER	DELL	D531	CN-0XM006-48643-86 L-4472	QDS-BRCM1019
2	MODEM	ACEEX	1414	0206026776	IFAXDM1414
3	NOTEBOOK COMPUTER	DELL	PP17L	CN-ONF743-48643-7A V-0124	FCC DoC
4	iPod	Apple	A1137	6U6078FMUPR	FCC DoC

NO.	SIGNAL CABLE DESCRIPTION OF THE ABOVE SUPPORT UNITS
1	NA
2	1.2 m braid shielded wire, terminated with DB25 and DB9 connector via metallic frame, w/o core.
3	NA
4	1 m shielded cable, terminated with USB connector, w/o core.

**NOTE:** All power cords of the above support units are non shielded (1.8m).



### 3.5 CONFIGURATION OF SYSTEM UNDER TEST

For conducted emission test:

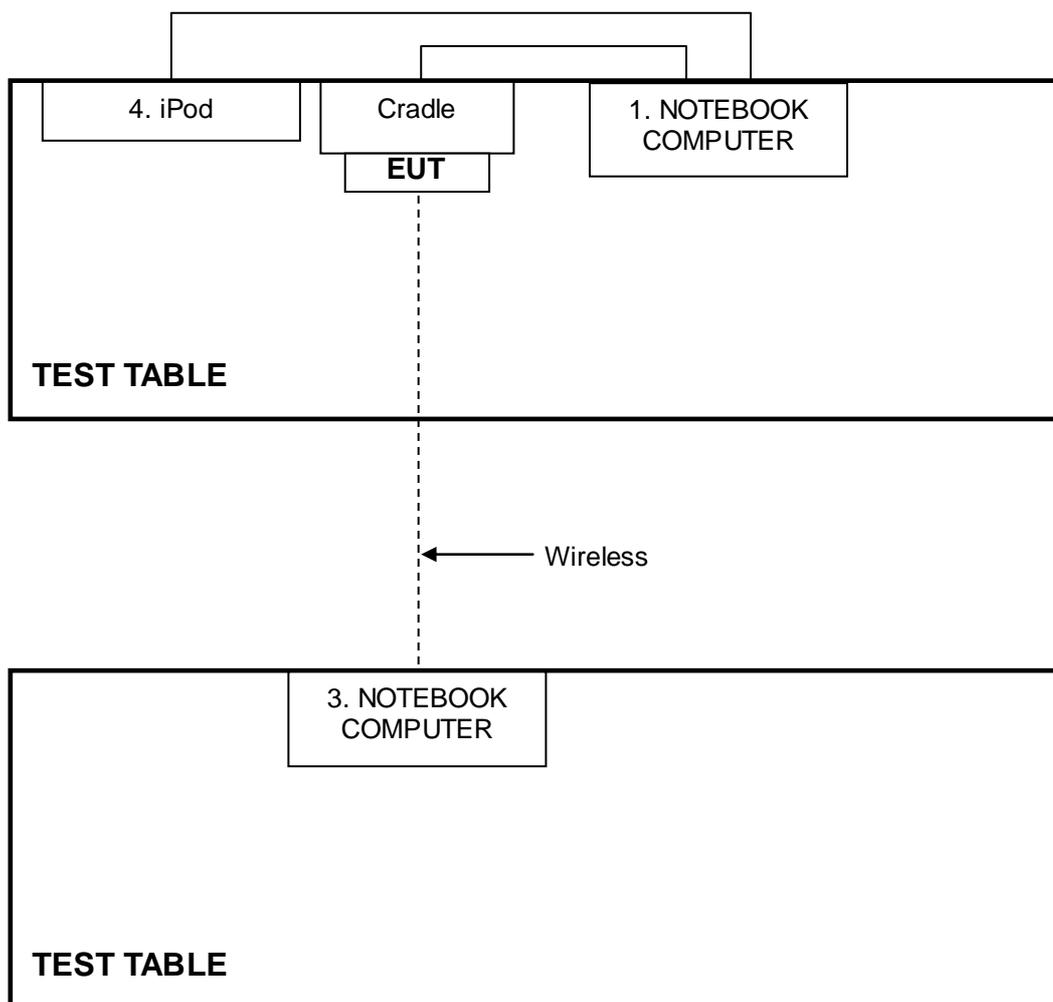



**For other test:**

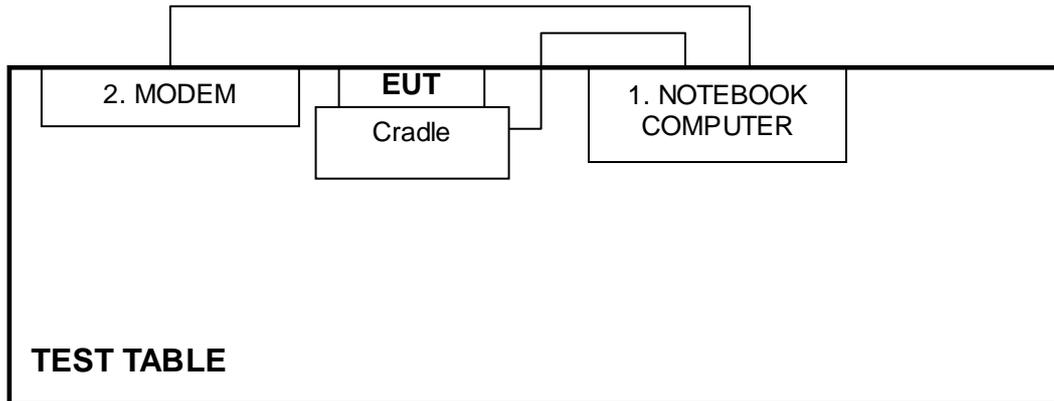



A D T

## 4. TEST TYPES AND RESULTS

### 4.1 CONDUCTED EMISSION MEASUREMENT

#### 4.1.1 LIMITS OF CONDUCTED EMISSION MEASUREMENT

FREQUENCY OF EMISSION (MHz)	CONDUCTED LIMIT (dB $\mu$ V)	
	Quasi-peak	Average
0.15-0.5	66 to 56	56 to 46
0.5-5	56	46
5-30	60	50

- NOTE:**
1. The lower limit shall apply at the transition frequencies.
  2. The limit decreases in line with the logarithm of the frequency in the range of 0.15 to 0.50 MHz.
  3. All emanations from a class A/B digital device or system, including any network of conductors and apparatus connected thereto, shall not exceed the level of field strengths specified above.

#### 4.1.2 TEST INSTRUMENTS

DESCRIPTION & MANUFACTURER	MODEL NO.	SERIAL NO.	CALIBRATED DATE	CALIBRATED UNTIL
Test Receiver	ESCS 30	100375	Mar. 31, 2009	Mar. 30, 2010
Line-Impedance Stabilization Network (for EUT)	ENV-216	100071	Nov. 26, 2008	Nov. 25, 2009
Line-Impedance Stabilization Network (for Peripheral)	ESH3-Z5	848773/004	Nov. 05, 2008	Nov. 04, 2009
RF Cable (JYEBAO)	5DFB	COBCAB-001	Aug 15, 2008	Aug 14, 2009
50 ohms Terminator	50	3	Nov. 05, 2008	Nov. 04, 2009
Software	BV ADT_Cond_V7.3.7	NA	NA	NA

**Note:**

1. The calibration interval of the above test instruments is 12 months and the calibrations are traceable to NML/ROC and NIST/USA.
2. The test was performed in Shielded Room No. B.
3. The VCCI Con B Registration No. is C-2193.

#### 4.1.3 TEST PROCEDURES

- a. The EUT was placed 0.4 meters from the conducting wall of the shielded room with EUT being connected to the power mains through a line impedance stabilization network (LISN). Other support units were connected to the power mains through another LISN. The two LISNs
- b. provide 50 ohm/ 50uH of coupling impedance for the measuring instrument.
- c. Both lines of the power mains connected to the EUT were checked for maximum conducted interference.
- d. The frequency range from 150kHz to 30MHz was searched. Emission level under (Limit – 20dB) was not recorded.

#### 4.1.4 DEVIATION FROM TEST STANDARD

No deviation

#### 4.1.5 TEST SETUP

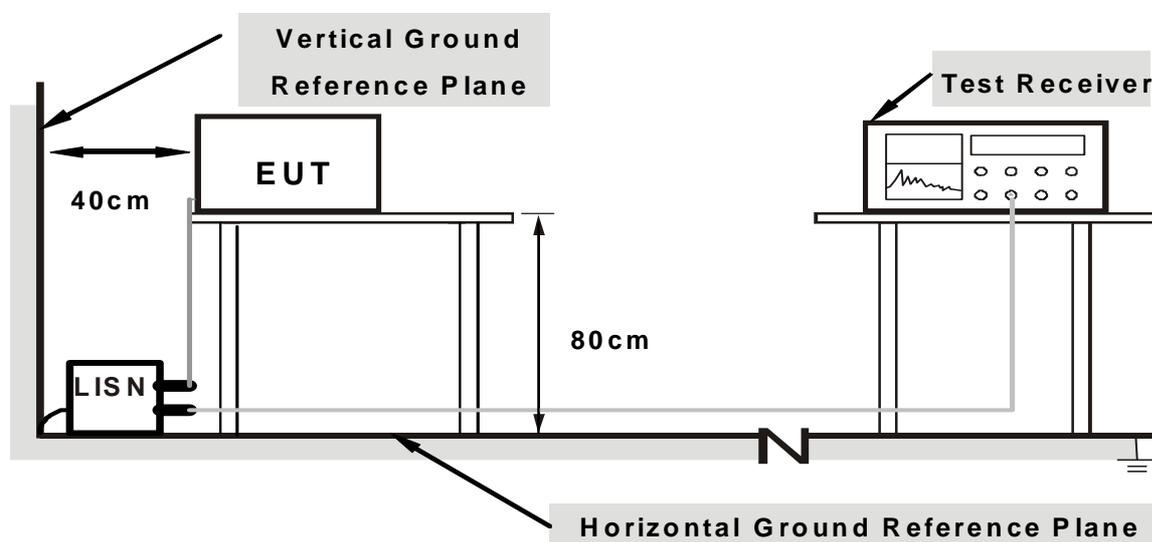

**Note: 1. Support units were connected to second LISN.**

**2. Both of LISNs (AMN) are 80 cm from EUT and at least 80 from other units and other metal planes**

For the actual test configuration, please refer to the related item – Photographs of the Test Configuration.

#### 4.1.6 EUT OPERATING CONDITIONS

- a. Placed the EUT on testing table.
- b. The communication partner run test program “Ping.exe” to enable EUT under transmission/receiving condition continuously at specific channel frequency via one UTP cable and wireless.



### 4.1.7 TEST RESULTS

#### DRAFT 802.11N (20MHZ) OFDM MODULATION:

EUT TEST CONDITION		MEASUREMENT DETAIL	
CHANNEL	Channel 8	PHASE	Line (L)
MODULATION TYPE	BPSK	6dB BANDWIDTH	9 kHz
TRANSFER RATE	6Mbps	INPUT POWER	120Vac, 60 Hz
ENVIRONMENTAL CONDITIONS	20deg. C, 60%RH, 965hPa	TESTED BY	Kent Liu

No	Freq. [MHz]	Corr. Factor [dB]	Reading Value [dB (uV)]		Emission Level [dB (uV)]		Limit [dB (uV)]		Margin (dB)	
			Q.P.	AV.	Q.P.	AV.	Q.P.	AV.	Q.P.	AV.
	1	0.178	0.21	56.75	49.85	56.96	50.06	64.57	54.57	-7.61
2	0.232	0.26	48.85	-	49.11	-	62.39	52.39	-13.29	-
3	0.293	0.33	45.00	-	45.33	-	60.43	50.43	-15.09	-
4	0.421	0.45	39.88	-	40.33	-	57.43	47.43	-17.09	-
5	0.776	0.35	32.77	-	33.12	-	56.00	46.00	-22.88	-
6	0.889	0.32	39.80	-	40.12	-	56.00	46.00	-15.88	-

- REMARKS:**
1. Q.P. and AV. are abbreviations of quasi-peak and average individually.
  2. "-": The Quasi-peak reading value also meets average limit and measurement with the average detector is unnecessary.
  3. The emission levels of other frequencies were very low against the limit.
  4. Margin value = Emission level - Limit value
  5. Correction factor = Insertion loss + Cable loss
  6. Emission Level = Correction Factor + Reading Value.

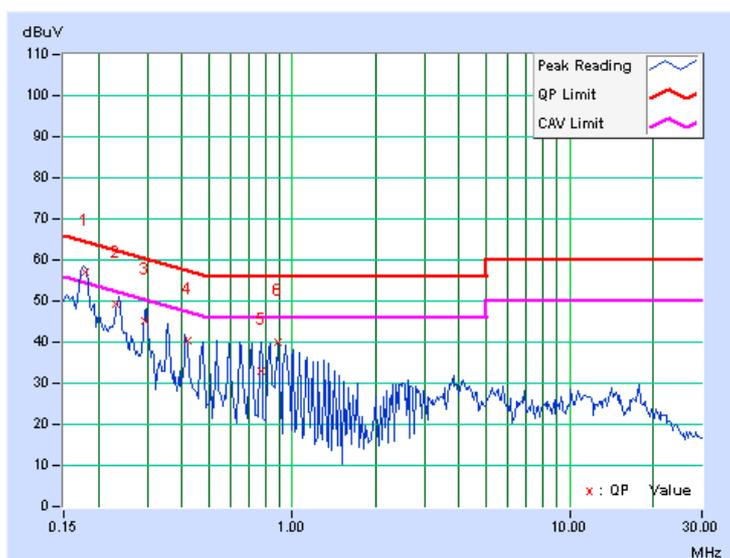



A D T

EUT TEST CONDITION		MEASUREMENT DETAIL	
CHANNEL	Channel 8	PHASE	Neutral (N)
MODULATION TYPE	BPSK	6dB BANDWIDTH	9 kHz
TRANSFER RATE	6Mbps	INPUT POWER	120Vac, 60 Hz
ENVIRONMENTAL CONDITIONS	20deg. C, 60%RH, 965hPa	TESTED BY	Kent Liu

No	Freq. [MHz]	Corr. Factor (dB)	Reading Value [dB (uV)]		Emission Level [dB (uV)]		Limit [dB (uV)]		Margin (dB)	
			Q.P.	AV.	Q.P.	AV.	Q.P.	AV.	Q.P.	AV.
			1	0.176	0.14	57.54	50.57	57.68	50.71	64.69
2	0.235	0.19	48.02	-	48.21	-	62.26	52.26	-14.05	-
3	0.245	0.21	43.40	-	43.61	-	61.92	51.92	-18.31	-
4	0.294	0.27	45.57	-	45.84	-	60.42	50.42	-14.59	-
5	0.599	0.33	36.55	-	36.88	-	56.00	46.00	-19.12	-
6	2.789	0.40	24.77	-	25.17	-	56.00	46.00	-30.83	-

- REMARKS:**
1. Q.P. and AV. are abbreviations of quasi-peak and average individually.
  2. "-": The Quasi-peak reading value also meets average limit and measurement with the average detector is unnecessary.
  3. The emission levels of other frequencies were very low against the limit.
  4. Margin value = Emission level - Limit value
  5. Correction factor = Insertion loss + Cable loss
  6. Emission Level = Correction Factor + Reading Value.

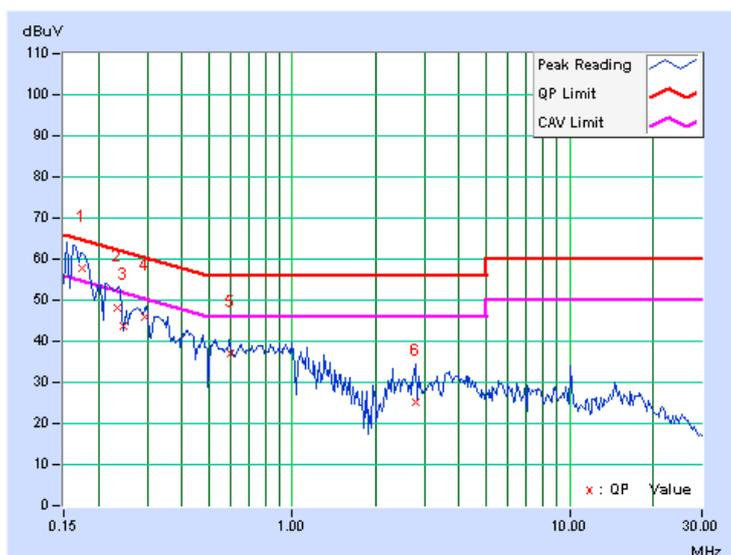

## 4.2 RADIATED EMISSION MEASUREMENT

### 4.2.1 LIMITS OF RADIATED EMISSION MEASUREMENT

Emissions radiated outside of the specified bands, shall be according to the general radiated limits in 15.209 as following:

Frequencies (MHz)	Field strength (microvolts/meter)	Measurement distance (meters)
0.009-0.490	2400/F(kHz)	300
0.490-1.705	24000/F(kHz)	30
1.705-30.0	30	30
30-88	100	3
88-216	150	3
216-960	200	3
Above 960	500	3

**NOTE:**

1. The lower limit shall apply at the transition frequencies.
2. Emission level (dBuV/m) = 20 log Emission level (uV/m).
3. As shown in 15.35(b), for frequencies above 1000MHz, the field strength limits are based on average detector, however, the peak field strength of any emission shall not exceed the maximum permitted average limits, specified above by more than 20dB under any condition of modulation.





#### 4.2.2 LIMITS OF UNWANTED EMISSION OUT OF THE RESTRICTED BANDS

<b>Frequencies (MHz)</b>	<b>EIRP Limit (dBm)</b>	<b>Equivalent Field Strength at 3m (dB<math>\mu</math>V/m) *note 3</b>
5150~5250	-27	68.3
5250~5350	-27	68.3
5470~5725	-27	68.3
5725~5825	-27 *note 1	68.3
	-17 *note 2	78.3

**NOTE:**

1. For frequencies 10MHz or greater above or below the band edge.
2. All emissions within the frequency range from the band edge to 10MHz above or below the band edge.
3. The following formula is used to convert the equipment isotropic radiated power (eirp) to field strength

$$E = \frac{1000000 \sqrt{30P}}{3} \mu\text{V/m, where } P \text{ is the eirp (Watts)}$$



A D T

### 4.2.3 TEST INSTRUMENTS

DESCRIPTION & MANUFACTURER	MODEL NO.	SERIAL NO.	CALIBRATED DATE	CALIBRATED UNTIL
ROHDE & SCHWARZ Spectrum Analyzer	FSP40	100036	Dec. 09, 2008	Dec. 08, 2009
HP Pre_Amplifier	8449B	3008A01923	Nov. 10, 2008	Nov. 09, 2009
ROHDE & SCHWARZ Test Receiver	ESCS30	847124/029	Sep. 09, 2008	Sep. 08, 2009
SCHWARZBECK TRILOG Broadband Antenna	VULB 9168	138	April 30, 2008	April 29, 2009
Schwarzbeck Horn_Antenna	BBHA9120	D124	Dec. 09, 2008	Dec. 08, 2009
Schwarzbeck Horn_Antenna	BBHA 9170	BBHA9170153	Jan. 22, 2009	Jan. 21, 2010
RF Switches	EMH-011	08009	Oct. 07, 2008	Oct. 06, 2009
RF CABLE (Chaintek)	Sucoflex 106	28077	Aug. 15, 2008	Aug. 14, 2009
RF Cable	8DFB	STCCAB-30M-1GHz	Oct. 07, 2008	Oct. 06, 2009
Software	ADT_Radiated_V7.6.15.9.2	NA	NA	NA
CT Antenna Tower & Turn Table	NA	NA	NA	NA

Note: 1. The calibration interval of the above test instruments is 12 months and the calibrations are traceable to NML/ROC and NIST/USA.

2. The horn antenna, HP preamplifier (model: 8449B) and Spectrum Analyzer (model: FSP40) are used only for the measurement of emission frequency above 1GHz if tested.

3. The test was performed in Open Site No. C.

4. The FCC Site Registration No. is 656396.

5. The VCCI Site Registration No. is R-1626.

6. The CANADA Site Registration No. is IC 7450G-3.

#### 4.2.4 TEST PROCEDURES

- a. The EUT was placed on the top of a rotating table 0.8 meters above the ground at a 10 meter open area test site. The table was rotated 360 degrees to determine the position of the highest radiation.
- b. The EUT was set 3 meters away from the interference-receiving antenna, which was mounted on the top of a variable-height antenna tower.
- c. The antenna is a broadband antenna, and its height is varied from one meter to four meters above the ground to determine the maximum value of the field strength. Both horizontal and vertical polarizations of the antenna are set to make the measurement.
- d. For each suspected emission, the EUT was arranged to its worst case and then the antenna was tuned to heights from 1 meter to 4 meters and the rotatable table was turned from 0 degrees to 360 degrees to find the maximum reading.
- e. The test-receiver system was set to Peak Detect Function and Specified Bandwidth with Maximum Hold Mode.
- f. If the emission level of the EUT in peak mode was 10dB lower than the limit specified, then testing could be stopped and the peak values of the EUT would be reported. Otherwise the emissions that did not have 10dB margin would be re-tested one by one using peak, quasi-peak or average method as specified and then reported in a data sheet.

**NOTE:**

1. The resolution bandwidth and video bandwidth of test receiver/spectrum analyzer is 120kHz for Peak detection (PK) and Quasi-peak detection (QP) at frequency below 1GHz.
2. The resolution bandwidth of test receiver/spectrum analyzer is 1 MHz and the video bandwidth is 3 MHz for Peak detection (PK) at frequency above 1GHz.
3. The resolution bandwidth of test receiver/spectrum analyzer is 1 MHz and the video bandwidth is 10 Hz for Average detection (AV) at frequency above 1GHz.

#### 4.2.5 DEVIATION FROM TEST STANDARD

No deviation

#### 4.2.6 TEST SETUP

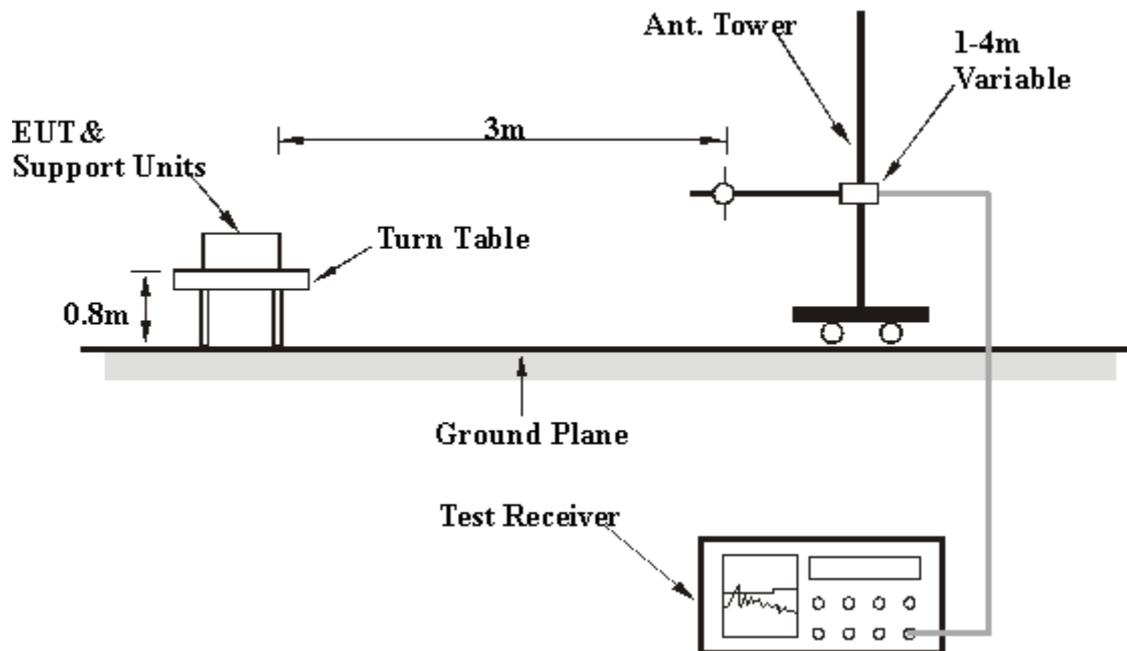

For the actual test configuration, please refer to the related item – Photographs of the Test Configuration.

#### 4.2.7 EUT OPERATING CONDITION

1. Placed the EUT on testing table.
2. The communication partner run test program “ART\_V80\_b33” to enable EUT under transmission/receiving condition continuously at specific channel frequency.



### Below 1GHz Test Data

#### 4.2.8 TEST RESULTS

#### BELOW 1GHz WORST-CASE DATA : DRAFT 802.11n (20MHz) OFDM MODULATION

EUT TEST CONDITION		MEASUREMENT DETAIL	
CHANNEL	Channel 8	FREQUENCY RANGE	Below 1000MHz
INPUT POWER (SYSTEM)	120Vac, 60 Hz	DETECTOR FUNCTION	Quasi-Peak
ENVIRONMENTAL CONDITIONS	20deg. C, 65%RH 965hPa	TESTED BY	Phoenix Huang

ANTENNA POLARITY & TEST DISTANCE: HORIZONTAL AT 3 M								
NO.	FREQ. (MHz)	EMISSION LEVEL (dBuV/m)	LIMIT (dBuV/m)	MARGIN (dB)	ANTENNA HEIGHT (m)	TABLE ANGLE (Degree)	RAW VALUE (dBuV)	CORRECTION FACTOR (dB/m)
1	74.84	26.06 QP	40.00	-13.94	1.00 H	155	13.62	12.44
2	240.00	42.67 QP	46.00	-3.33	1.25 H	180	27.74	14.93
3	500.00	31.65 QP	46.00	-14.35	1.00 H	235	8.99	22.66
4	599.98	30.88 QP	46.00	-15.12	1.00 H	187	6.11	24.77
5	623.98	32.93 QP	46.00	-13.07	1.67 H	329	7.61	25.32
6	959.98	35.56 QP	46.00	-10.44	1.00 H	256	3.59	31.97

ANTENNA POLARITY & TEST DISTANCE: VERTICAL AT 3 M								
NO.	FREQ. (MHz)	EMISSION LEVEL (dBuV/m)	LIMIT (dBuV/m)	MARGIN (dB)	ANTENNA HEIGHT (m)	TABLE ANGLE (Degree)	RAW VALUE (dBuV)	CORRECTION FACTOR (dB/m)
1	75.14	30.79 QP	40.00	-9.21	1.00 V	256	18.39	12.40
2	240.00	37.29 QP	46.00	-8.71	1.00 V	80	22.36	14.93
3	479.99	40.85 QP	46.00	-5.15	1.00 V	4	18.50	22.35
4	599.99	31.67 QP	46.00	-14.33	1.23 V	38	6.90	24.77
5	623.99	35.18 QP	46.00	-10.82	1.00 V	190	9.86	25.32
6	959.97	40.27 QP	46.00	-5.73	1.00 V	193	8.30	31.97

- REMARKS:**
1. Emission level (dBuV/m) = Raw Value (dBuV) + Correction Factor (dB/m).
  2. Correction Factor (dB/m) = Antenna Factor (dB/m) + Cable Factor (dB).
  3. The other emission levels were very low against the limit.
  4. Margin value = Emission level – Limit value.



### Above 1GHz Test Data

#### 4.2.9 TEST RESULTS

##### 802.11a OFDM MODULATION

EUT TEST CONDITION		MEASUREMENT DETAIL	
CHANNEL	Channel 1	FREQUENCY RANGE	1 ~ 40GHz
INPUT POWER (SYSTEM)	120Vac, 60 Hz	DETECTOR FUNCTION	Peak (PK) Average (AV)
ENVIRONMENTAL CONDITIONS	18deg. C, 73%RH 965hPa	TESTED BY	Eric Lee

ANTENNA POLARITY & TEST DISTANCE: HORIZONTAL AT 3 M								
NO.	FREQ. (MHz)	EMISSION LEVEL (dBuV/m)	LIMIT (dBuV/m)	MARGIN (dB)	ANTENNA HEIGHT (m)	TABLE ANGLE (Degree)	RAW VALUE (dBuV)	CORRECTION FACTOR (dB/m)
1	5150.00	58.92 PK	74.00	-15.08	1.11 H	245	26.22	32.70
2	5150.00	44.69 AV	54.00	-9.31	1.11 H	245	11.99	32.70
3	*5180.00	99.98 PK			1.15 H	201	67.28	32.70
4	*5180.00	91.02 AV			1.15 H	201	58.32	32.70
5	#10360.00	58.21 PK	68.30	-10.09	1.65 H	24	25.51	32.70

ANTENNA POLARITY & TEST DISTANCE: VERTICAL AT 3 M								
NO.	FREQ. (MHz)	EMISSION LEVEL (dBuV/m)	LIMIT (dBuV/m)	MARGIN (dB)	ANTENNA HEIGHT (m)	TABLE ANGLE (Degree)	RAW VALUE (dBuV)	CORRECTION FACTOR (dB/m)
1	5150.00	60.42 PK	74.00	-13.58	1.24 V	254	27.72	32.70
2	5150.00	45.48 AV	54.00	-8.52	1.24 V	254	12.78	32.70
3	*5180.00	106.24 PK			1.20 V	352	73.54	32.70
4	*5180.00	96.10 AV			1.20 V	352	63.40	32.70
5	#10360.00	57.45 PK	68.30	-10.85	1.24 V	256	24.75	32.70

- REMARKS:**
1. Emission level (dBuV/m) = Raw Value (dBuV) + Correction Factor (dB/m).
  2. Correction Factor (dB/m) = Antenna Factor (dB/m) + Cable Factor (dB).
  3. The other emission levels were very low against the limit.
  4. Margin value = Emission level – Limit value.
  5. “ \* “: Fundamental frequency.
  6. “#”:The radiated frequency is out the restricted band.



A D T

EUT TEST CONDITION		MEASUREMENT DETAIL	
CHANNEL	Channel 2	FREQUENCY RANGE	1 ~ 40GHz
INPUT POWER (SYSTEM)	120Vac, 60 Hz	DETECTOR FUNCTION	Peak (PK) Average (AV)
ENVIRONMENTAL CONDITIONS	18deg. C, 73%RH 965hPa	TESTED BY	Eric Lee

ANTENNA POLARITY & TEST DISTANCE: HORIZONTAL AT 3 M								
NO.	FREQ. (MHz)	EMISSION LEVEL (dBuV/m)	LIMIT (dBuV/m)	MARGIN (dB)	ANTENNA HEIGHT (m)	TABLE ANGLE (Degree)	RAW VALUE (dBuV)	CORRECTION FACTOR (dB/m)
1	*5200.00	100.00 PK			1.19 H	201	67.30	32.70
2	*5200.00	91.01 AV			1.19 H	201	58.31	32.70
3	#10400.00	58.10 PK	68.30	-10.20	1.02 H	245	25.40	32.70
ANTENNA POLARITY & TEST DISTANCE: VERTICAL AT 3 M								
NO.	FREQ. (MHz)	EMISSION LEVEL (dBuV/m)	LIMIT (dBuV/m)	MARGIN (dB)	ANTENNA HEIGHT (m)	TABLE ANGLE (Degree)	RAW VALUE (dBuV)	CORRECTION FACTOR (dB/m)
1	*5200.00	107.21 PK			1.23 V	333	74.51	32.70
2	*5200.00	97.10 AV			1.23 V	333	64.40	32.70
3	#10400.00	57.69 PK	68.30	-10.61	1.24 V	52	24.99	32.70

- REMARKS:**
1. Emission level (dBuV/m) = Raw Value (dBuV) + Correction Factor (dB/m).
  2. Correction Factor (dB/m) = Antenna Factor (dB/m) + Cable Factor (dB).
  3. The other emission levels were very low against the limit.
  4. Margin value = Emission level – Limit value.
  5. “ \* “: Fundamental frequency.
  6. “#”:The radiated frequency is out the restricted band.



A D T

EUT TEST CONDITION		MEASUREMENT DETAIL	
CHANNEL	Channel 4	FREQUENCY RANGE	1 ~ 40GHz
INPUT POWER (SYSTEM)	120Vac, 60 Hz	DETECTOR FUNCTION	Peak (PK) Average (AV)
ENVIRONMENTAL CONDITIONS	18deg. C, 73%RH 965hPa	TESTED BY	Eric Lee

ANTENNA POLARITY & TEST DISTANCE: HORIZONTAL AT 3 M								
NO.	FREQ. (MHz)	EMISSION LEVEL (dBuV/m)	LIMIT (dBuV/m)	MARGIN (dB)	ANTENNA HEIGHT (m)	TABLE ANGLE (Degree)	RAW VALUE (dBuV)	CORRECTION FACTOR (dB/m)
1	*5240.00	100.45 PK			1.20 H	201	67.75	32.70
2	*5240.00	91.54 AV			1.20 H	201	58.84	32.70
3	#10480.00	57.98 PK	68.30	-10.32	1.45 H	256	25.28	32.70
ANTENNA POLARITY & TEST DISTANCE: VERTICAL AT 3 M								
NO.	FREQ. (MHz)	EMISSION LEVEL (dBuV/m)	LIMIT (dBuV/m)	MARGIN (dB)	ANTENNA HEIGHT (m)	TABLE ANGLE (Degree)	RAW VALUE (dBuV)	CORRECTION FACTOR (dB/m)
1	*5240.00	107.24 PK			1.23 V	326	74.54	32.70
2	*5240.00	97.30 AV			1.23 V	326	64.60	32.70
3	#10480.00	57.69 PK	68.30	-10.61	1.47 V	254	24.99	32.70

- REMARKS:**
1. Emission level (dBuV/m) = Raw Value (dBuV) + Correction Factor (dB/m).
  2. Correction Factor (dB/m) = Antenna Factor (dB/m) + Cable Factor (dB).
  3. The other emission levels were very low against the limit.
  4. Margin value = Emission level – Limit value.
  5. “ \* “: Fundamental frequency.
  6. "#":The radiated frequency is out the restricted band.





A D T

EUT TEST CONDITION		MEASUREMENT DETAIL	
CHANNEL	Channel 5	FREQUENCY RANGE	1 ~ 40GHz
INPUT POWER (SYSTEM)	120Vac, 60 Hz	DETECTOR FUNCTION	Peak (PK) Average (AV)
ENVIRONMENTAL CONDITIONS	18deg. C, 73%RH 965hPa	TESTED BY	Eric Lee

ANTENNA POLARITY & TEST DISTANCE: HORIZONTAL AT 3 M								
NO.	FREQ. (MHz)	EMISSION LEVEL (dBuV/m)	LIMIT (dBuV/m)	MARGIN (dB)	ANTENNA HEIGHT (m)	TABLE ANGLE (Degree)	RAW VALUE (dBuV)	CORRECTION FACTOR (dB/m)
1	*5260.00	101.10 PK			1.19 H	202	68.40	32.70
2	*5260.00	92.74 AV			1.19 H	202	60.04	32.70
3	#10520.00	58.01 PK	68.30	-10.29	1.09 H	326	25.31	32.70
ANTENNA POLARITY & TEST DISTANCE: VERTICAL AT 3 M								
NO.	FREQ. (MHz)	EMISSION LEVEL (dBuV/m)	LIMIT (dBuV/m)	MARGIN (dB)	ANTENNA HEIGHT (m)	TABLE ANGLE (Degree)	RAW VALUE (dBuV)	CORRECTION FACTOR (dB/m)
1	*5260.00	108.24 PK			1.17 V	324	75.54	32.70
2	*5260.00	98.32 AV			1.17 V	324	65.62	32.70
3	#10520.00	57.69 PK	68.30	-10.61	1.02 V	245	24.99	32.70

- REMARKS:**
1. Emission level (dBuV/m) = Raw Value (dBuV) + Correction Factor (dB/m).
  2. Correction Factor (dB/m) = Antenna Factor (dB/m) + Cable Factor (dB).
  3. The other emission levels were very low against the limit.
  4. Margin value = Emission level – Limit value.
  5. “ \* “: Fundamental frequency.
  6. "#":The radiated frequency is out the restricted band.



A D T

EUT TEST CONDITION		MEASUREMENT DETAIL	
CHANNEL	Channel 7	FREQUENCY RANGE	1 ~ 40GHz
INPUT POWER (SYSTEM)	120Vac, 60 Hz	DETECTOR FUNCTION	Peak (PK) Average (AV)
ENVIRONMENTAL CONDITIONS	18deg. C, 73%RH 965hPa	TESTED BY	Eric Lee

ANTENNA POLARITY & TEST DISTANCE: HORIZONTAL AT 3 M								
NO.	FREQ. (MHz)	EMISSION LEVEL (dBuV/m)	LIMIT (dBuV/m)	MARGIN (dB)	ANTENNA HEIGHT (m)	TABLE ANGLE (Degree)	RAW VALUE (dBuV)	CORRECTION FACTOR (dB/m)
1	*5300.00	101.24 PK			1.24 H	203	68.54	32.70
2	*5300.00	92.12 AV			1.24 H	203	59.42	32.70
3	10600.00	58.23 PK	74.00	-15.77	1.42 H	265	25.53	32.70
4	10600.00	44.01 AV	54.00	-9.99	1.42 H	265	11.31	32.70
ANTENNA POLARITY & TEST DISTANCE: VERTICAL AT 3 M								
NO.	FREQ. (MHz)	EMISSION LEVEL (dBuV/m)	LIMIT (dBuV/m)	MARGIN (dB)	ANTENNA HEIGHT (m)	TABLE ANGLE (Degree)	RAW VALUE (dBuV)	CORRECTION FACTOR (dB/m)
1	*5300.00	107.98 PK			1.23 V	345	75.28	32.70
2	*5300.00	97.98 AV			1.23 V	345	65.28	32.70
3	10600.00	57.21 PK	74.00	-16.79	1.24 V	254	24.51	32.70
4	10600.00	43.56 AV	54.00	-10.44	1.24 V	254	10.86	32.70

- REMARKS:**
1. Emission level (dBuV/m) = Raw Value (dBuV) + Correction Factor (dB/m).
  2. Correction Factor (dB/m) = Antenna Factor (dB/m) + Cable Factor (dB).
  3. The other emission levels were very low against the limit.
  4. Margin value = Emission level – Limit value.
  5. “ \* “: Fundamental frequency.



A D T

EUT TEST CONDITION		MEASUREMENT DETAIL	
CHANNEL	Channel 8	FREQUENCY RANGE	1 ~ 40GHz
INPUT POWER (SYSTEM)	120Vac, 60 Hz	DETECTOR FUNCTION	Peak (PK) Average (AV)
ENVIRONMENTAL CONDITIONS	18deg. C, 73%RH 965hPa	TESTED BY	Eric Lee

ANTENNA POLARITY & TEST DISTANCE: HORIZONTAL AT 3 M								
NO.	FREQ. (MHz)	EMISSION LEVEL (dBuV/m)	LIMIT (dBuV/m)	MARGIN (dB)	ANTENNA HEIGHT (m)	TABLE ANGLE (Degree)	RAW VALUE (dBuV)	CORRECTION FACTOR (dB/m)
1	*5320.00	101.36 PK			1.02 H	326	68.66	32.70
2	*5320.00	92.10 AV			1.02 H	326	59.40	32.70
3	5350.00	57.40 PK	74.00	-16.60	1.32 H	63	24.70	32.70
4	5350.00	43.48 AV	54.00	-10.52	1.32 H	63	10.78	32.70
5	10640.00	57.69 PK	74.00	-16.31	1.62 H	3	24.99	32.70
6	10640.00	43.67 AV	54.00	-10.33	1.62 H	3	10.97	32.70
ANTENNA POLARITY & TEST DISTANCE: VERTICAL AT 3 M								
NO.	FREQ. (MHz)	EMISSION LEVEL (dBuV/m)	LIMIT (dBuV/m)	MARGIN (dB)	ANTENNA HEIGHT (m)	TABLE ANGLE (Degree)	RAW VALUE (dBuV)	CORRECTION FACTOR (dB/m)
1	*5320.00	108.69 PK			1.24 V	343	75.99	32.70
2	*5320.00	98.65 AV			1.24 V	343	65.95	32.70
3	5350.00	57.71 PK	74.00	-16.29	1.37 V	249	25.01	32.70
4	5350.00	44.02 AV	54.00	-9.98	1.37 V	249	11.32	32.70
5	10640.00	57.69 PK	74.00	-16.31	1.32 V	62	24.99	32.70
6	10640.00	44.13 AV	54.00	-9.87	1.32 V	62	11.43	32.70

- REMARKS:**
1. Emission level (dBuV/m) = Raw Value (dBuV) + Correction Factor (dB/m).
  2. Correction Factor (dB/m) = Antenna Factor (dB/m) + Cable Factor (dB).
  3. The other emission levels were very low against the limit.
  4. Margin value = Emission level – Limit value.
  5. “ \* “: Fundamental frequency.



A D T

EUT TEST CONDITION		MEASUREMENT DETAIL	
CHANNEL	Channel 9	FREQUENCY RANGE	1 ~ 40GHz
INPUT POWER (SYSTEM)	120Vac, 60 Hz	DETECTOR FUNCTION	Peak (PK) Average (AV)
ENVIRONMENTAL CONDITIONS	18deg. C, 73%RH 965hPa	TESTED BY	Eric Lee

**ANTENNA POLARITY & TEST DISTANCE: HORIZONTAL AT 3 M**

NO.	FREQ. (MHz)	EMISSION LEVEL (dBuV/m)	LIMIT (dBuV/m)	MARGIN (dB)	ANTENNA HEIGHT (m)	TABLE ANGLE (Degree)	RAW VALUE (dBuV)	CORRECTION FACTOR (dB/m)
1	5460.00	55.99 PK	74.00	-18.01	1.24 H	56	23.29	32.70
2	5460.00	42.88 AV	54.00	-11.12	1.24 H	56	10.18	32.70
3	#5470.00	57.24 PK	68.30	-11.06	1.69 H	321	24.54	32.70
4	*5500.00	102.50 PK			1.13 H	201	69.80	32.70
5	*5500.00	93.24 AV			1.13 H	201	60.54	32.70
6	11000.00	57.42 PK	74.00	-16.58	1.32 H	56	24.72	32.70
7	11000.00	43.23 AV	54.00	-10.77	1.32 H	56	10.53	32.70

**ANTENNA POLARITY & TEST DISTANCE: VERTICAL AT 3 M**

NO.	FREQ. (MHz)	EMISSION LEVEL (dBuV/m)	LIMIT (dBuV/m)	MARGIN (dB)	ANTENNA HEIGHT (m)	TABLE ANGLE (Degree)	RAW VALUE (dBuV)	CORRECTION FACTOR (dB/m)
1	5452.00	57.68 PK	74.00	-16.32	1.45 V	52	24.98	32.70
2	5452.00	43.64 AV	54.00	-10.36	1.45 V	52	10.94	32.70
3	#5470.00	60.24 PK	68.30	-8.06	1.47 V	42	27.54	32.70
4	*5500.00	110.01 PK			1.54 V	24	77.31	32.70
5	*5500.00	99.64 AV			1.54 V	24	66.94	32.70
6	11000.00	58.24 PK	74.00	-15.76	1.02 V	23	25.54	32.70
7	11000.00	45.21 AV	54.00	-8.79	1.02 V	23	12.51	32.70

- REMARKS:**
1. Emission level (dBuV/m) = Raw Value (dBuV) + Correction Factor (dB/m).
  2. Correction Factor (dB/m) = Antenna Factor (dB/m) + Cable Factor (dB).
  3. The other emission levels were very low against the limit.
  4. Margin value = Emission level – Limit value.
  5. " \* ": Fundamental frequency.
  6. "#": The radiated frequency is out the restricted band.



A D T

EUT TEST CONDITION		MEASUREMENT DETAIL	
CHANNEL	Channel 14	FREQUENCY RANGE	1 ~ 40GHz
INPUT POWER (SYSTEM)	120Vac, 60 Hz	DETECTOR FUNCTION	Peak (PK) Average (AV)
ENVIRONMENTAL CONDITIONS	18deg. C, 73%RH 965hPa	TESTED BY	Eric Lee

ANTENNA POLARITY & TEST DISTANCE: HORIZONTAL AT 3 M								
NO.	FREQ. (MHz)	EMISSION LEVEL (dBuV/m)	LIMIT (dBuV/m)	MARGIN (dB)	ANTENNA HEIGHT (m)	TABLE ANGLE (Degree)	RAW VALUE (dBuV)	CORRECTION FACTOR (dB/m)
1	*5600.00	103.24 PK			1.24 H	209	70.54	32.70
2	*5600.00	94.23 AV			1.24 H	209	61.53	32.70
3	11200.00	57.23 PK	74.00	-16.77	1.54 H	198	24.53	32.70
4	11200.00	43.02 AV	54.00	-10.98	1.54 H	198	10.32	32.70

ANTENNA POLARITY & TEST DISTANCE: VERTICAL AT 3 M								
NO.	FREQ. (MHz)	EMISSION LEVEL (dBuV/m)	LIMIT (dBuV/m)	MARGIN (dB)	ANTENNA HEIGHT (m)	TABLE ANGLE (Degree)	RAW VALUE (dBuV)	CORRECTION FACTOR (dB/m)
1	*5600.00	110.24 PK			1.24 V	258	77.54	32.70
2	*5600.00	100.10 AV			1.24 V	258	67.40	32.70
3	11200.00	57.45 PK	74.00	-16.55	1.58 V	85	24.75	32.70
4	11200.00	44.16 AV	54.00	-9.84	1.58 V	85	11.46	32.70

- REMARKS:**
1. Emission level (dBuV/m) = Raw Value (dBuV) + Correction Factor (dB/m).
  2. Correction Factor (dB/m) = Antenna Factor (dB/m) + Cable Factor (dB).
  3. The other emission levels were very low against the limit.
  4. Margin value = Emission level – Limit value.
  5. “ \* “: Fundamental frequency.



A D T

EUT TEST CONDITION		MEASUREMENT DETAIL	
CHANNEL	Channel 19	FREQUENCY RANGE	1 ~ 40GHz
INPUT POWER (SYSTEM)	120Vac, 60 Hz	DETECTOR FUNCTION	Peak (PK) Average (AV)
ENVIRONMENTAL CONDITIONS	18deg. C, 73%RH 965hPa	TESTED BY	Eric Lee

ANTENNA POLARITY & TEST DISTANCE: HORIZONTAL AT 3 M								
NO.	FREQ. (MHz)	EMISSION LEVEL (dBuV/m)	LIMIT (dBuV/m)	MARGIN (dB)	ANTENNA HEIGHT (m)	TABLE ANGLE (Degree)	RAW VALUE (dBuV)	CORRECTION FACTOR (dB/m)
1	*5700.00	103.50 PK			1.18 H	201	70.80	32.70
2	*5700.00	94.10 AV			1.18 H	201	61.40	32.70
3	#5725.00	57.85 PK	68.30	-10.45	1.42 H	51	25.15	32.70
4	11400.00	58.24 PK	74.00	-15.76	1.59 H	64	25.54	32.70
5	11400.00	43.62 AV	54.00	-10.38	1.59 H	64	10.92	32.70
ANTENNA POLARITY & TEST DISTANCE: VERTICAL AT 3 M								
NO.	FREQ. (MHz)	EMISSION LEVEL (dBuV/m)	LIMIT (dBuV/m)	MARGIN (dB)	ANTENNA HEIGHT (m)	TABLE ANGLE (Degree)	RAW VALUE (dBuV)	CORRECTION FACTOR (dB/m)
1	*5700.00	110.42 PK			1.25 V	42	77.72	32.70
2	*5700.00	100.24 AV			1.25 V	42	67.54	32.70
3	#5725.00	61.24 PK	68.30	-7.06	1.02 V	342	28.54	32.70
4	11400.00	58.42 PK	74.00	-15.58	1.66 V	223	25.72	32.70
5	11400.00	43.61 AV	54.00	-10.39	1.66 V	223	10.91	32.70

- REMARKS:**
1. Emission level (dBuV/m) = Raw Value (dBuV) + Correction Factor (dB/m).
  2. Correction Factor (dB/m) = Antenna Factor (dB/m) + Cable Factor (dB).
  3. The other emission levels were very low against the limit.
  4. Margin value = Emission level – Limit value.
  5. “ \* “: Fundamental frequency.
  6. “#”:The radiated frequency is out the restricted band.



A D T

EUT TEST CONDITION		MEASUREMENT DETAIL	
CHANNEL	Channel 20	FREQUENCY RANGE	1 ~ 40GHz
INPUT POWER	120Vac, 60 Hz	DETECTOR FUNCTION	Peak (PK) Average (AV)
ENVIRONMENTAL CONDITIONS	18deg. C, 73%RH 965hPa	TESTED BY	Eric Lee

**ANTENNA POLARITY & TEST DISTANCE: HORIZONTAL AT 3 M**

NO.	FREQ. (MHz)	EMISSION LEVEL (dBuV/m)	LIMIT (dBuV/m)	MARGIN (dB)	ANTENNA HEIGHT (m)	TABLE ANGLE (Degree)	RAW VALUE (dBuV)	CORRECTION FACTOR (dB/m)
1	#5715.000	56.54 PK	68.30	-11.76	1.14 H	294	23.84	32.70
2	5725.000	68.24 PK	78.30	-10.06	1.13 H	294	35.54	32.70
3	*5745.000	102.43 PK			1.13 H	193	69.73	32.70
4	*5745.000	93.99 AV			1.13 H	193	61.29	32.70
5	11490.000	58.46 PK	74.00	-15.54	1.57 H	42	25.76	32.70
6	11490.000	45.28 AV	54.00	-8.72	1.57 H	42	12.58	32.70

**ANTENNA POLARITY & TEST DISTANCE: VERTICAL AT 3 M**

NO.	FREQ. (MHz)	EMISSION LEVEL (dBuV/m)	LIMIT (dBuV/m)	MARGIN (dB)	ANTENNA HEIGHT (m)	TABLE ANGLE (Degree)	RAW VALUE (dBuV)	CORRECTION FACTOR (dB/m)
1	#5715.000	61.09 PK	68.30	-7.21	1.20 V	333	28.39	32.70
2	#5725.000	72.21 PK	78.30	-6.09	1.19 V	233	39.51	32.70
3	*5745.000	109.42 PK			1.19 V	332	76.72	32.70
4	*5745.000	99.25 AV			1.19 V	332	66.55	32.70
5	11490.000	58.56 PK	74.00	-15.44	1.15 V	210	25.86	32.70
6	11490.000	45.23 AV	54.00	-8.77	1.15 V	210	12.53	32.70

- REMARKS:**
1. Emission level (dBuV/m) = Raw Value (dBuV) + Correction Factor (dB/m).
  2. Correction Factor (dB/m) = Antenna Factor (dB/m) + Cable Factor (dB).
  3. The other emission levels were very low against the limit.
  4. Margin value = Emission level – Limit value.
  5. “ \* “: Fundamental frequency.
  6. "#":The radiated frequency is out the restricted band.



A D T

EUT TEST CONDITION		MEASUREMENT DETAIL	
CHANNEL	Channel 22	FREQUENCY RANGE	1 ~ 40GHz
INPUT POWER	120Vac, 60 Hz	DETECTOR FUNCTION	Peak (PK) Average (AV)
ENVIRONMENTAL CONDITIONS	18deg. C, 73%RH 965hPa	TESTED BY	Eric Lee

ANTENNA POLARITY & TEST DISTANCE: HORIZONTAL AT 3 M								
NO.	FREQ. (MHz)	EMISSION LEVEL (dBuV/m)	LIMIT (dBuV/m)	MARGIN (dB)	ANTENNA HEIGHT (m)	TABLE ANGLE (Degree)	RAW VALUE (dBuV)	CORRECTION FACTOR (dB/m)
1	*5785.000	102.87 PK			1.20 H	200	70.17	32.70
2	*5785.000	94.32 AV			1.20 H	200	61.62	32.70
3	11570.000	58.24 PK	74.00	-15.76	1.43 H	152	25.54	32.70
4	11570.000	45.68 AV	54.00	-8.32	1.43 H	152	12.98	32.70
ANTENNA POLARITY & TEST DISTANCE: VERTICAL AT 3 M								
NO.	FREQ. (MHz)	EMISSION LEVEL (dBuV/m)	LIMIT (dBuV/m)	MARGIN (dB)	ANTENNA HEIGHT (m)	TABLE ANGLE (Degree)	RAW VALUE (dBuV)	CORRECTION FACTOR (dB/m)
1	*5785.000	109.78 PK			1.14 V	187	71.71	38.07
2	*5785.000	100.10 AV			1.14 V	187	62.03	38.07
3	11570.000	57.24 PK	74.00	-16.76	1.54 V	25	10.02	47.22
4	11570.000	43.26 AV	54.00	-10.74	1.54 V	25	-3.96	47.22

- REMARKS:**
1. Emission level (dBuV/m) = Raw Value (dBuV) + Correction Factor (dB/m).
  2. Correction Factor (dB/m) = Antenna Factor (dB/m) + Cable Factor (dB).
  3. The other emission levels were very low against the limit.
  4. Margin value = Emission level – Limit value.
  5. “ \* “: Fundamental frequency.
  6. "#":The radiated frequency is out the restricted band.





A D T

EUT TEST CONDITION		MEASUREMENT DETAIL	
CHANNEL	Channel 23	FREQUENCY RANGE	1 ~ 40GHz
INPUT POWER	120Vac, 60 Hz	DETECTOR FUNCTION	Peak (PK) Average (AV)
ENVIRONMENTAL CONDITIONS	18deg. C, 73%RH 965hPa	TESTED BY	Eric Lee

ANTENNA POLARITY & TEST DISTANCE: HORIZONTAL AT 3 M								
NO.	FREQ. (MHz)	EMISSION LEVEL (dBuV/m)	LIMIT (dBuV/m)	MARGIN (dB)	ANTENNA HEIGHT (m)	TABLE ANGLE (Degree)	RAW VALUE (dBuV)	CORRECTION FACTOR (dB/m)
1	*5805.000	103.45 PK			1.14 H	209	70.75	32.70
2	*5805.000	95.20 AV			1.14 H	209	62.50	32.70
3	#5825.000	67.00 PK	78.30	-11.30	1.15 H	212	34.30	32.70
4	#5835.000	56.30 PK	68.30	-12.00	1.13 H	200	23.60	32.70
5	11650.000	58.31 PK	74.00	-15.69	1.85 H	321	25.61	32.70
6	11650.000	45.00 AV	54.00	-9.00	1.85 H	321	12.30	32.70
ANTENNA POLARITY & TEST DISTANCE: VERTICAL AT 3 M								
NO.	FREQ. (MHz)	EMISSION LEVEL (dBuV/m)	LIMIT (dBuV/m)	MARGIN (dB)	ANTENNA HEIGHT (m)	TABLE ANGLE (Degree)	RAW VALUE (dBuV)	CORRECTION FACTOR (dB/m)
1	*5805.000	111.01 PK			1.18 V	134	78.31	32.70
2	*5805.000	101.23 AV			1.18 V	134	68.53	32.70
3	#5825.000	73.23 PK	78.30	-5.07	1.20 V	142	40.53	32.70
4	#5835.000	59.90 PK	68.30	-8.40	1.15 V	120	27.20	32.70
5	11650.000	58.36 PK	74.00	-15.64	1.64 V	249	25.66	32.70
6	11650.000	44.90 AV	54.00	-9.10	1.64 V	249	12.20	32.70

- REMARKS:**
1. Emission level (dBuV/m) = Raw Value (dBuV) + Correction Factor (dB/m).
  2. Correction Factor (dB/m) = Antenna Factor (dB/m) + Cable Factor (dB).
  3. The other emission levels were very low against the limit.
  4. Margin value = Emission level – Limit value.
  5. “ \* “: Fundamental frequency.
  6. “#”:The radiated frequency is out the restricted band.



A D T

### RESTRICTED BANDEDGE (802.11a MODE, CH1, HORIZONTAL)

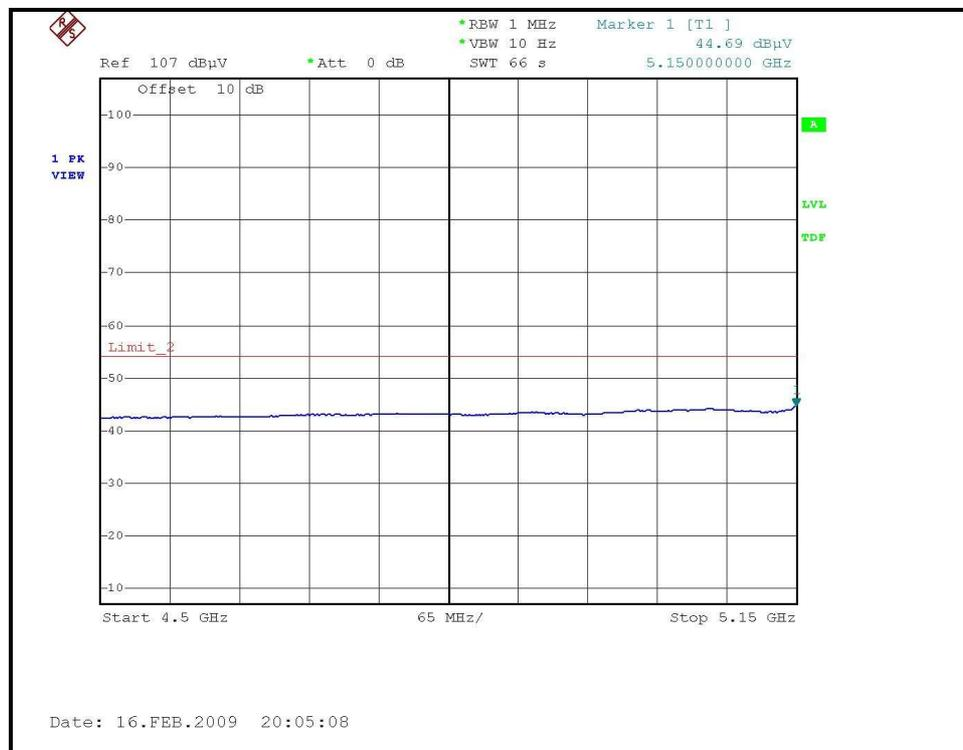
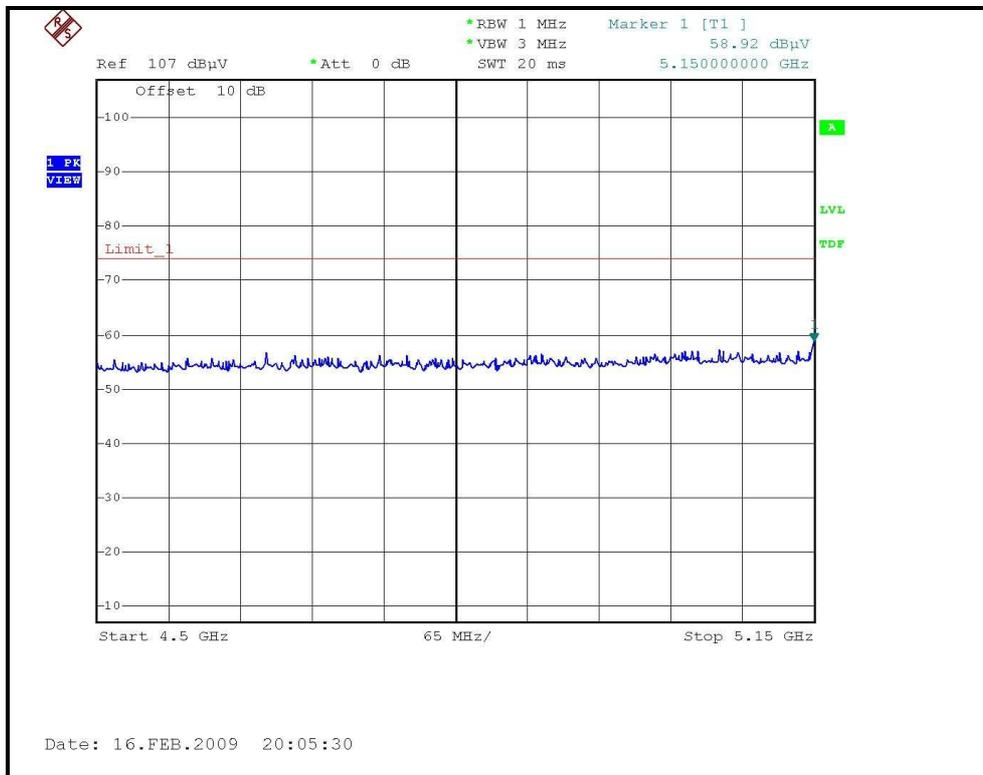



A D T

### RESTRICTED BANDEDGE (802.11a MODE, CH1, VERTICAL)

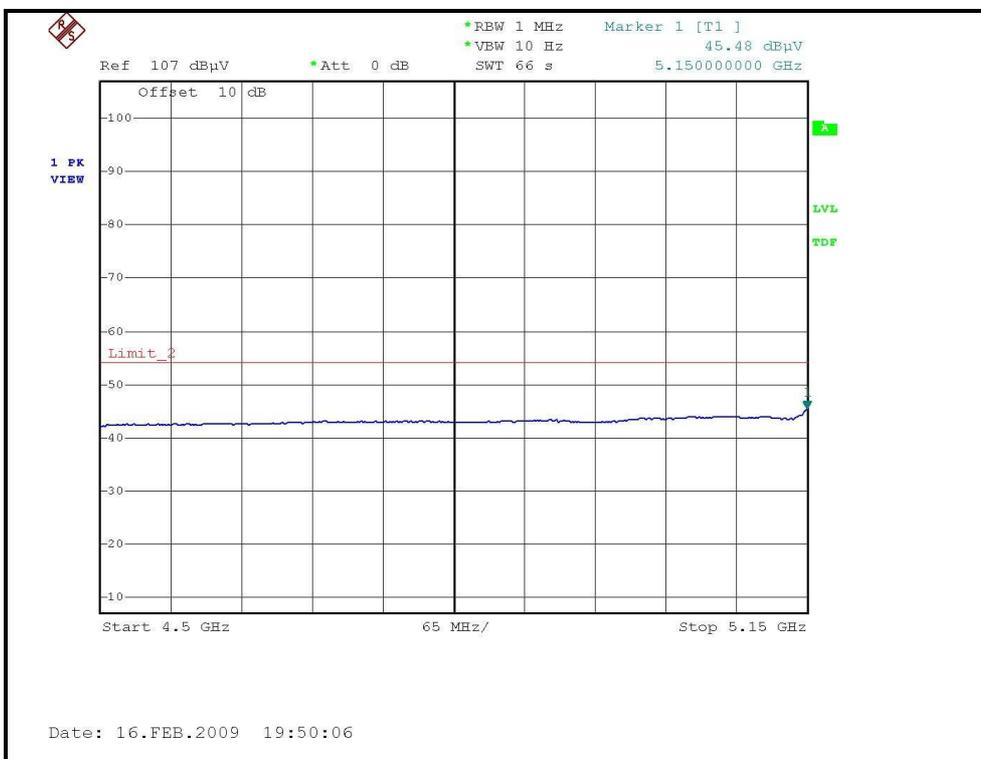
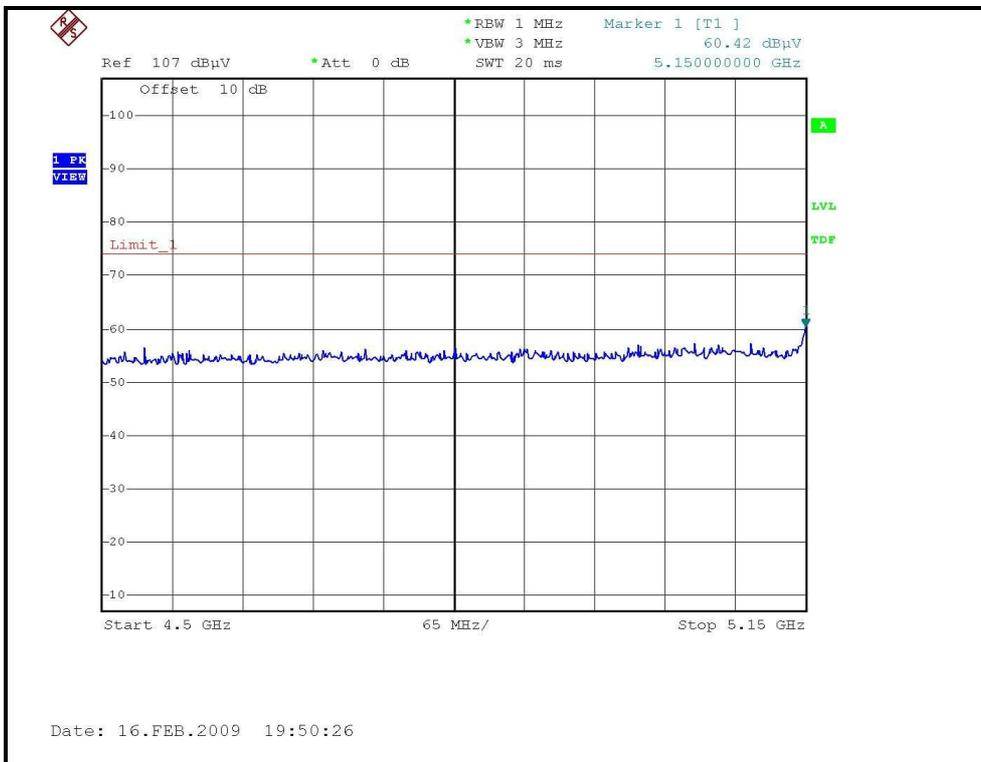



A D T

### RESTRICTED BANDEDGE (802.11a MODE, CH8, HORIZONTAL)

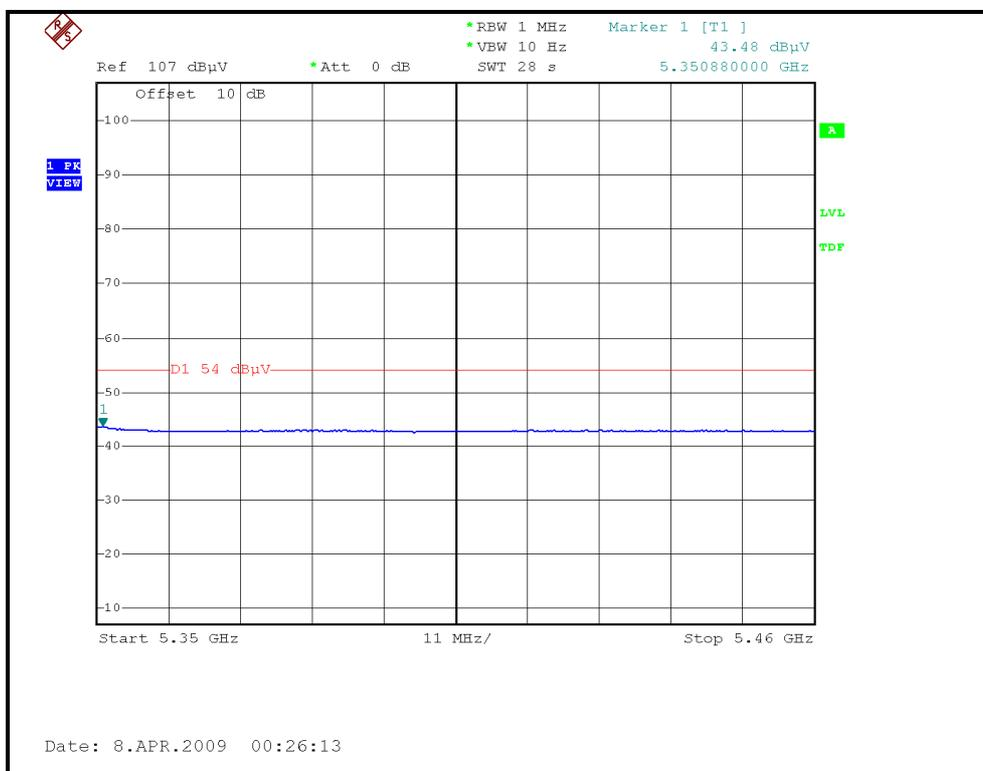
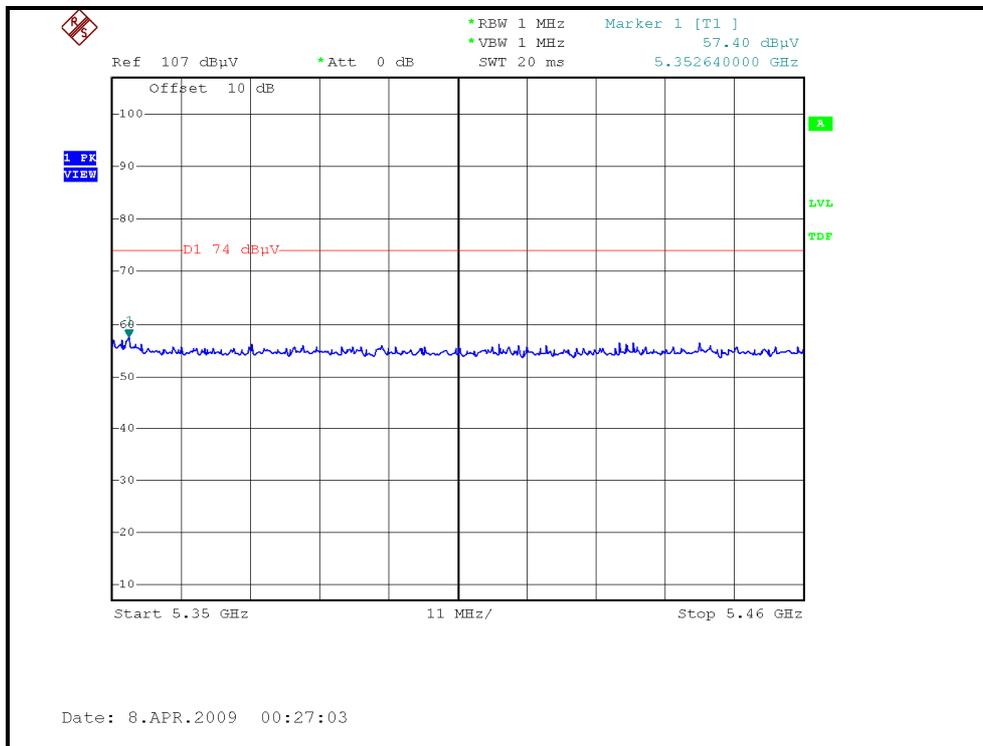



A D T

### RESTRICTED BANDEDGE (802.11a MODE, CH8, VERTICAL)

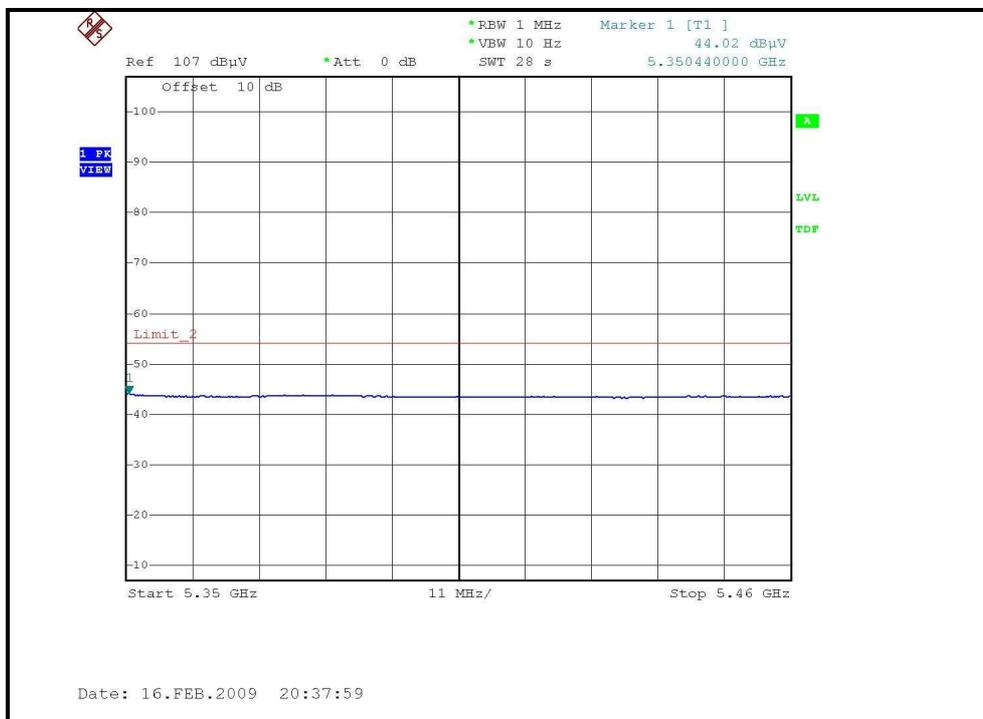
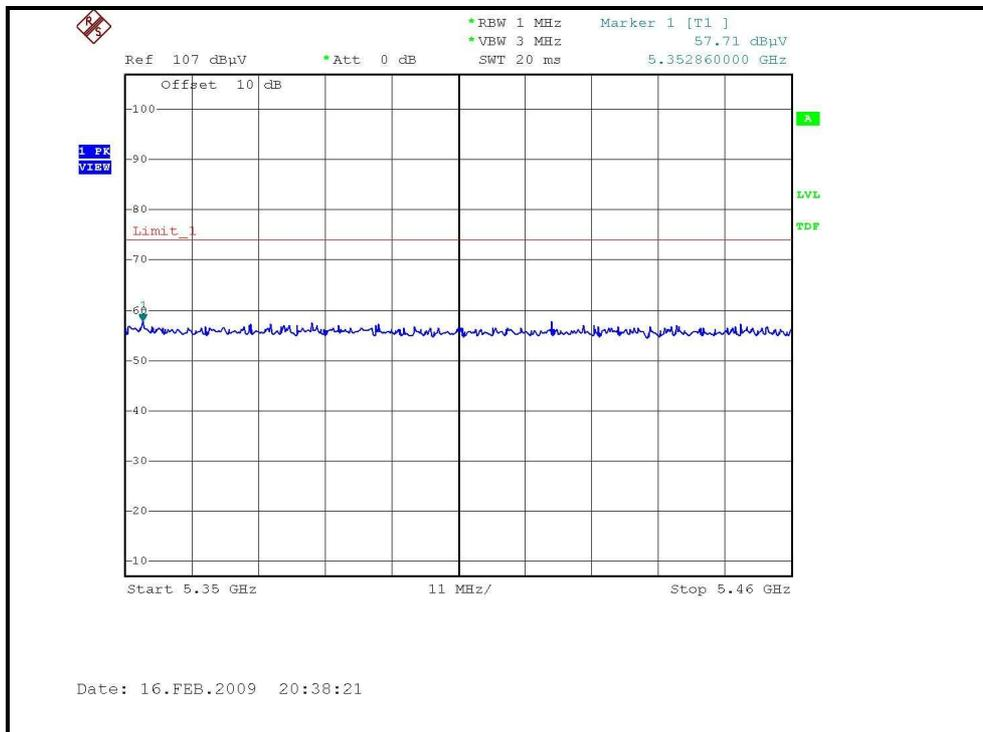



A D T

### RESTRICTED BANDEDGE (802.11a MODE, CH9, HORIZONTAL)

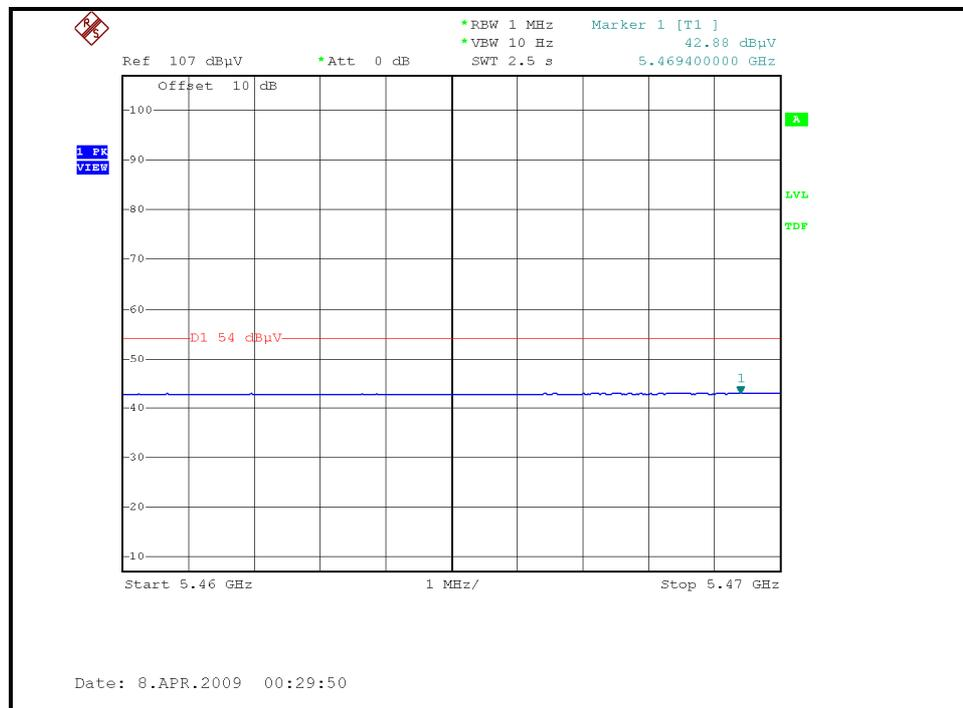
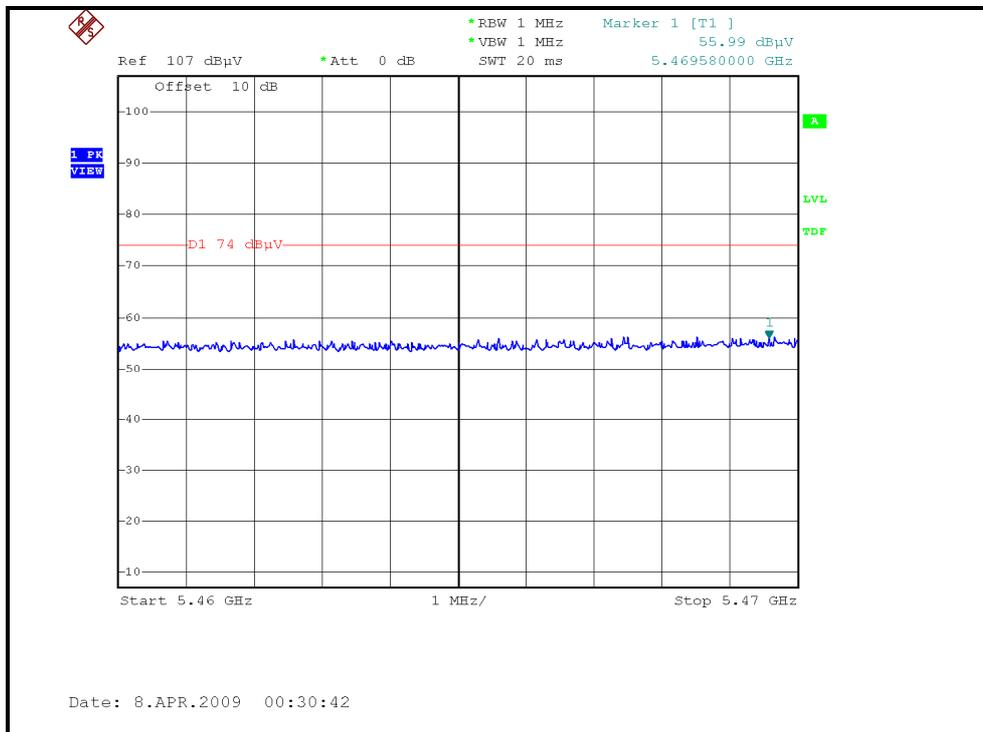



A D T

### RESTRICTED BANDEDGE (802.11a MODE, CH9, VERTICAL)

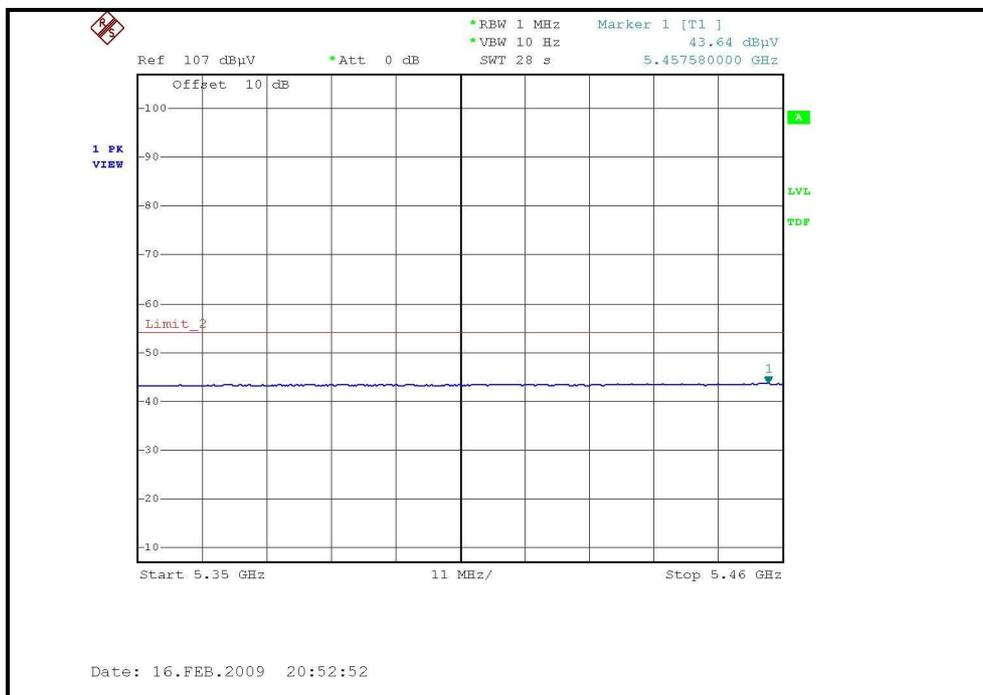
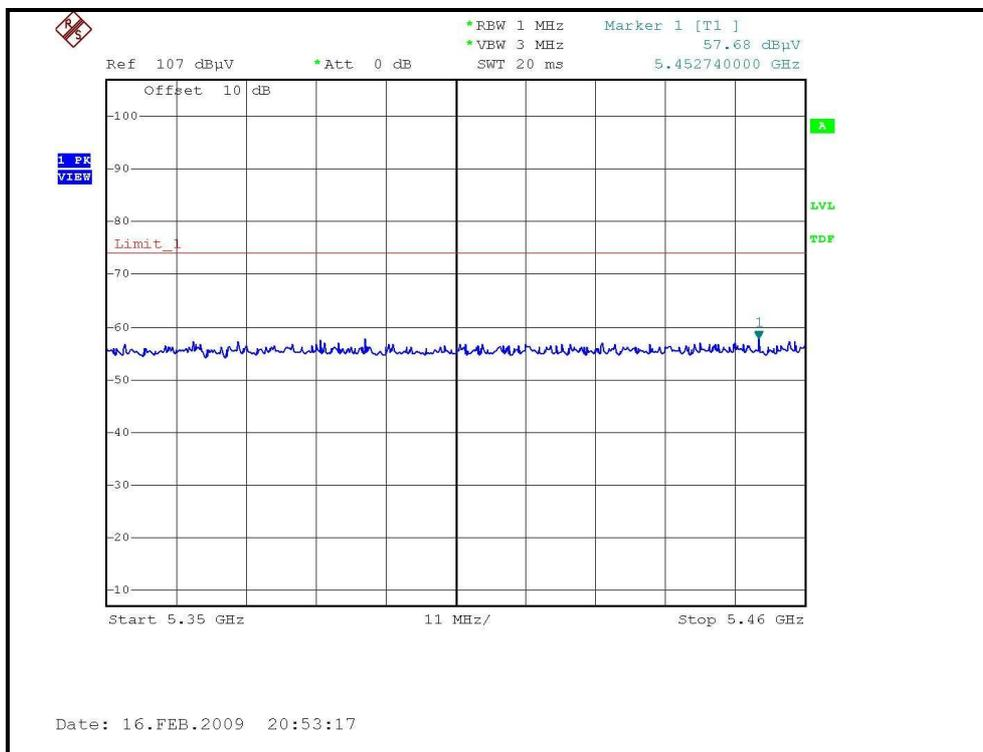



DRAFT 802.11n (20MHz) OFDM MODULATION

EUT TEST CONDITION		MEASUREMENT DETAIL	
CHANNEL	Channel 1	FREQUENCY RANGE	1 ~ 40GHz
INPUT POWER (SYSTEM)	120Vac, 60 Hz	DETECTOR FUNCTION	Peak (PK) Average (AV)
ENVIRONMENTAL CONDITIONS	18deg. C, 73%RH 965hPa	TESTED BY	Eric Lee

ANTENNA POLARITY & TEST DISTANCE: HORIZONTAL AT 3 M

NO.	FREQ. (MHz)	EMISSION LEVEL (dBuV/m)	LIMIT (dBuV/m)	MARGIN (dB)	ANTENNA HEIGHT (m)	TABLE ANGLE (Degree)	RAW VALUE (dBuV)	CORRECTION FACTOR (dB/m)
1	5150.00	60.36 PK	74.00	-13.64	1.20 H	180	27.66	32.70
2	5150.00	47.56 AV	54.00	-6.44	1.20 H	180	14.86	32.70
3	*5180.00	100.20 PK			1.11 H	180	67.50	32.70
4	*5180.00	89.24 AV			1.11 H	180	56.54	32.70
5	#10360.00	57.45 PK	68.30	-10.85	1.65 H	222	24.75	32.70

ANTENNA POLARITY & TEST DISTANCE: VERTICAL AT 3 M

NO.	FREQ. (MHz)	EMISSION LEVEL (dBuV/m)	LIMIT (dBuV/m)	MARGIN (dB)	ANTENNA HEIGHT (m)	TABLE ANGLE (Degree)	RAW VALUE (dBuV)	CORRECTION FACTOR (dB/m)
1	5150.00	61.75 PK	74.00	-12.25	1.24 V	50	29.05	32.70
2	5150.00	47.23 AV	54.00	-6.77	1.24 V	50	14.53	32.70
3	*5180.00	107.21 PK			1.23 V	45	74.51	32.70
4	*5180.00	95.24 AV			1.23 V	45	62.54	32.70
5	#10360.00	56.21 PK	68.30	-12.09	1.59 V	69	23.51	32.70

- REMARKS:**
1. Emission level (dBuV/m) = Raw Value (dBuV) + Correction Factor (dB/m).
  2. Correction Factor (dB/m) = Antenna Factor (dB/m) + Cable Factor (dB).
  3. The other emission levels were very low against the limit.
  4. Margin value = Emission level – Limit value.
  5. “ \* “: Fundamental frequency.
  6. “#”:The radiated frequency is out the restricted band.





A D T

EUT TEST CONDITION		MEASUREMENT DETAIL	
CHANNEL	Channel 2	FREQUENCY RANGE	1 ~ 40GHz
INPUT POWER (SYSTEM)	120Vac, 60 Hz	DETECTOR FUNCTION	Peak (PK) Average (AV)
ENVIRONMENTAL CONDITIONS	18deg. C, 73%RH 965hPa	TESTED BY	Eric Lee

ANTENNA POLARITY & TEST DISTANCE: HORIZONTAL AT 3 M								
NO.	FREQ. (MHz)	EMISSION LEVEL (dBuV/m)	LIMIT (dBuV/m)	MARGIN (dB)	ANTENNA HEIGHT (m)	TABLE ANGLE (Degree)	RAW VALUE (dBuV)	CORRECTION FACTOR (dB/m)
1	*5200.00	101.21 PK			1.10 H	200	68.51	32.70
2	*5200.00	90.20 AV			1.10 H	200	57.50	32.70
3	#10400.00	58.20 PK	68.30	-10.10	1.54 H	1	25.50	32.70
ANTENNA POLARITY & TEST DISTANCE: VERTICAL AT 3 M								
NO.	FREQ. (MHz)	EMISSION LEVEL (dBuV/m)	LIMIT (dBuV/m)	MARGIN (dB)	ANTENNA HEIGHT (m)	TABLE ANGLE (Degree)	RAW VALUE (dBuV)	CORRECTION FACTOR (dB/m)
1	*5200.00	108.64 PK			1.23 V	30	75.94	32.70
2	*5200.00	96.40 AV			1.23 V	30	63.70	32.70
3	#10400.00	57.00 PK	68.30	-11.30	1.02 V	92	24.30	32.70

- REMARKS:**
1. Emission level (dBuV/m) = Raw Value (dBuV) + Correction Factor (dB/m).
  2. Correction Factor (dB/m) = Antenna Factor (dB/m) + Cable Factor (dB).
  3. The other emission levels were very low against the limit.
  4. Margin value = Emission level – Limit value.
  5. “ \* “: Fundamental frequency.
  6. "#":The radiated frequency is out the restricted band.



A D T

EUT TEST CONDITION		MEASUREMENT DETAIL	
CHANNEL	Channel 4	FREQUENCY RANGE	1 ~ 40GHz
INPUT POWER (SYSTEM)	120Vac, 60 Hz	DETECTOR FUNCTION	Peak (PK) Average (AV)
ENVIRONMENTAL CONDITIONS	18deg. C, 73%RH 965hPa	TESTED BY	Eric Lee

ANTENNA POLARITY & TEST DISTANCE: HORIZONTAL AT 3 M								
NO.	FREQ. (MHz)	EMISSION LEVEL (dBuV/m)	LIMIT (dBuV/m)	MARGIN (dB)	ANTENNA HEIGHT (m)	TABLE ANGLE (Degree)	RAW VALUE (dBuV)	CORRECTION FACTOR (dB/m)
1	*5240.00	101.02 PK			1.10 H	163	68.32	32.70
2	*5240.00	90.21 AV			1.10 H	163	57.51	32.70
3	#10480.00	59.30 PK	68.30	-9.00	1.69 H	253	26.60	32.70
ANTENNA POLARITY & TEST DISTANCE: VERTICAL AT 3 M								
NO.	FREQ. (MHz)	EMISSION LEVEL (dBuV/m)	LIMIT (dBuV/m)	MARGIN (dB)	ANTENNA HEIGHT (m)	TABLE ANGLE (Degree)	RAW VALUE (dBuV)	CORRECTION FACTOR (dB/m)
1	*5240.00	108.60 PK			1.20 V	33	75.90	32.70
2	*5240.00	97.20 AV			1.20 V	33	64.50	32.70
3	#10480.00	57.90 PK	68.30	-10.40	1.35 V	96	25.20	32.70

- REMARKS:**
1. Emission level (dBuV/m) = Raw Value (dBuV) + Correction Factor (dB/m).
  2. Correction Factor (dB/m) = Antenna Factor (dB/m) + Cable Factor (dB).
  3. The other emission levels were very low against the limit.
  4. Margin value = Emission level – Limit value.
  5. “ \* “: Fundamental frequency.
  6. "#":The radiated frequency is out the restricted band.



A D T

EUT TEST CONDITION		MEASUREMENT DETAIL	
CHANNEL	Channel 5	FREQUENCY RANGE	1 ~ 40GHz
INPUT POWER (SYSTEM)	120Vac, 60 Hz	DETECTOR FUNCTION	Peak (PK) Average (AV)
ENVIRONMENTAL CONDITIONS	18deg. C, 73%RH 965hPa	TESTED BY	Eric Lee

ANTENNA POLARITY & TEST DISTANCE: HORIZONTAL AT 3 M								
NO.	FREQ. (MHz)	EMISSION LEVEL (dBuV/m)	LIMIT (dBuV/m)	MARGIN (dB)	ANTENNA HEIGHT (m)	TABLE ANGLE (Degree)	RAW VALUE (dBuV)	CORRECTION FACTOR (dB/m)
1	*5260.00	106.24 PK			1.11 H	190	73.54	32.70
2	*5260.00	94.30 AV			1.11 H	190	61.60	32.70
3	#10520.00	59.49 PK	68.30	-8.81	1.47 H	46	26.79	32.70
ANTENNA POLARITY & TEST DISTANCE: VERTICAL AT 3 M								
NO.	FREQ. (MHz)	EMISSION LEVEL (dBuV/m)	LIMIT (dBuV/m)	MARGIN (dB)	ANTENNA HEIGHT (m)	TABLE ANGLE (Degree)	RAW VALUE (dBuV)	CORRECTION FACTOR (dB/m)
1	*5260.00	113.24 PK			1.21 V	45	80.54	32.70
2	*5260.00	101.23 AV			1.21 V	45	68.53	32.70
3	#10520.00	58.24 PK	68.30	-10.06	1.49 V	326	25.54	32.70

- REMARKS:**
1. Emission level (dBuV/m) = Raw Value (dBuV) + Correction Factor (dB/m).
  2. Correction Factor (dB/m) = Antenna Factor (dB/m) + Cable Factor (dB).
  3. The other emission levels were very low against the limit.
  4. Margin value = Emission level – Limit value.
  5. “ \* “: Fundamental frequency.
  6. "#":The radiated frequency is out the restricted band.



A D T

EUT TEST CONDITION		MEASUREMENT DETAIL	
CHANNEL	Channel 7	FREQUENCY RANGE	1 ~ 40GHz
INPUT POWER (SYSTEM)	120Vac, 60 Hz	DETECTOR FUNCTION	Peak (PK) Average (AV)
ENVIRONMENTAL CONDITIONS	18deg. C, 73%RH 965hPa	TESTED BY	Eric Lee

ANTENNA POLARITY & TEST DISTANCE: HORIZONTAL AT 3 M								
NO.	FREQ. (MHz)	EMISSION LEVEL (dBuV/m)	LIMIT (dBuV/m)	MARGIN (dB)	ANTENNA HEIGHT (m)	TABLE ANGLE (Degree)	RAW VALUE (dBuV)	CORRECTION FACTOR (dB/m)
1	*5300.00	105.23 PK			1.10 H	200	72.53	32.70
2	*5300.00	93.64 AV			1.10 H	200	60.94	32.70
3	10600.00	59.54 PK	74.00	-14.46	1.53 H	62	26.84	32.70
4	10600.00	43.15 AV	54.00	-10.85	1.53 H	62	10.45	32.70
ANTENNA POLARITY & TEST DISTANCE: VERTICAL AT 3 M								
NO.	FREQ. (MHz)	EMISSION LEVEL (dBuV/m)	LIMIT (dBuV/m)	MARGIN (dB)	ANTENNA HEIGHT (m)	TABLE ANGLE (Degree)	RAW VALUE (dBuV)	CORRECTION FACTOR (dB/m)
1	*5300.00	112.24 PK			1.18 V	46	79.54	32.70
2	*5300.00	100.90 AV			1.18 V	46	68.20	32.70
3	10600.00	58.10 PK	74.00	-15.90	1.84 V	356	25.40	32.70
4	10600.00	43.26 AV	54.00	-10.74	1.84 V	356	10.56	32.70

- REMARKS:**
1. Emission level (dBuV/m) = Raw Value (dBuV) + Correction Factor (dB/m).
  2. Correction Factor (dB/m) = Antenna Factor (dB/m) + Cable Factor (dB).
  3. The other emission levels were very low against the limit.
  4. Margin value = Emission level – Limit value.
  5. “ \* “: Fundamental frequency.



A D T

EUT TEST CONDITION		MEASUREMENT DETAIL	
CHANNEL	Channel 8	FREQUENCY RANGE	1 ~ 40GHz
INPUT POWER (SYSTEM)	120Vac, 60 Hz	DETECTOR FUNCTION	Peak (PK) Average (AV)
ENVIRONMENTAL CONDITIONS	18deg. C, 73%RH 965hPa	TESTED BY	Eric Lee

ANTENNA POLARITY & TEST DISTANCE: HORIZONTAL AT 3 M								
NO.	FREQ. (MHz)	EMISSION LEVEL (dBuV/m)	LIMIT (dBuV/m)	MARGIN (dB)	ANTENNA HEIGHT (m)	TABLE ANGLE (Degree)	RAW VALUE (dBuV)	CORRECTION FACTOR (dB/m)
1	*5320.00	105.24 PK			1.10 H	200	72.54	32.70
2	*5320.00	94.00 AV			1.10 H	200	61.30	32.70
3	5350.00	62.45 PK	74.00	-11.55	1.53 H	62	29.75	32.70
4	5350.00	46.86 AV	54.00	-7.14	1.53 H	62	14.16	32.70
5	10640.00	59.25 PK	74.00	-14.75	1.69 H	54	26.55	32.70
6	10640.00	46.30 AV	54.00	-7.70	1.69 H	54	13.60	32.70
ANTENNA POLARITY & TEST DISTANCE: VERTICAL AT 3 M								
NO.	FREQ. (MHz)	EMISSION LEVEL (dBuV/m)	LIMIT (dBuV/m)	MARGIN (dB)	ANTENNA HEIGHT (m)	TABLE ANGLE (Degree)	RAW VALUE (dBuV)	CORRECTION FACTOR (dB/m)
1	*5320.00	112.24 PK			1.19 V	41	79.54	32.70
2	*5320.00	101.24 AV			1.19 V	41	68.54	32.70
3	5350.00	63.21 PK	74.00	-10.79	1.62 V	42	30.51	32.70
4	5350.00	46.68 AV	54.00	-7.32	1.62 V	42	13.98	32.70
5	10640.00	57.45 PK	74.00	-16.55	1.11 V	250	24.75	32.70
6	10640.00	45.21 AV	54.00	-8.79	1.11 V	250	12.51	32.70

- REMARKS:**
1. Emission level (dBuV/m) = Raw Value (dBuV) + Correction Factor (dB/m).
  2. Correction Factor (dB/m) = Antenna Factor (dB/m) + Cable Factor (dB).
  3. The other emission levels were very low against the limit.
  4. Margin value = Emission level – Limit value.
  5. “ \* “: Fundamental frequency.



A D T

EUT TEST CONDITION		MEASUREMENT DETAIL	
CHANNEL	Channel 9	FREQUENCY RANGE	1 ~ 40GHz
INPUT POWER (SYSTEM)	120Vac, 60 Hz	DETECTOR FUNCTION	Peak (PK) Average (AV)
ENVIRONMENTAL CONDITIONS	18deg. C, 73%RH 965hPa	TESTED BY	Eric Lee

**ANTENNA POLARITY & TEST DISTANCE: HORIZONTAL AT 3 M**

NO.	FREQ. (MHz)	EMISSION LEVEL (dBuV/m)	LIMIT (dBuV/m)	MARGIN (dB)	ANTENNA HEIGHT (m)	TABLE ANGLE (Degree)	RAW VALUE (dBuV)	CORRECTION FACTOR (dB/m)
1	5384.00	57.21 PK	74.00	-16.79	1.43 H	62	24.51	32.70
2	5384.00	43.22 AV	54.00	-10.78	1.43 H	62	10.52	32.70
3	#5470.00	57.64 PK	68.30	-10.66	1.11 H	2	24.94	32.70
4	*5500.00	103.21 PK			1.24 H	21	70.51	32.70
5	*5500.00	91.68 AV			1.24 H	21	58.98	32.70
6	11000.00	59.25 PK	74.00	-14.75	1.02 H	123	26.55	32.70
7	11000.00	45.00 AV	54.00	-9.00	1.02 H	123	12.30	32.70

**ANTENNA POLARITY & TEST DISTANCE: VERTICAL AT 3 M**

NO.	FREQ. (MHz)	EMISSION LEVEL (dBuV/m)	LIMIT (dBuV/m)	MARGIN (dB)	ANTENNA HEIGHT (m)	TABLE ANGLE (Degree)	RAW VALUE (dBuV)	CORRECTION FACTOR (dB/m)
1	5454.00	57.72 PK	74.00	-16.28	1.55 V	20	25.02	32.70
2	5454.00	43.21 AV	54.00	-10.79	1.55 V	20	10.51	32.70
3	#5470.00	62.24 PK	68.30	-6.06	1.54 V	29	29.54	32.70
4	*5500.00	110.54 PK			1.20 V	10	77.84	32.70
5	*5500.00	98.36 AV			1.20 V	10	65.66	32.70
6	11000.00	58.24 PK	74.00	-15.76	1.47 V	360	25.54	32.70
7	11000.00	43.15 AV	54.00	-10.85	1.47 V	360	10.45	32.70

- REMARKS:**
1. Emission level (dBuV/m) = Raw Value (dBuV) + Correction Factor (dB/m).
  2. Correction Factor (dB/m) = Antenna Factor (dB/m) + Cable Factor (dB).
  3. The other emission levels were very low against the limit.
  4. Margin value = Emission level – Limit value.
  5. " \* ": Fundamental frequency.
  6. "#":The radiated frequency is out the restricted band.



A D T

EUT TEST CONDITION		MEASUREMENT DETAIL	
CHANNEL	Channel 14	FREQUENCY RANGE	1 ~ 40GHz
INPUT POWER (SYSTEM)	120Vac, 60 Hz	DETECTOR FUNCTION	Peak (PK) Average (AV)
ENVIRONMENTAL CONDITIONS	18deg. C, 73%RH 965hPa	TESTED BY	Eric Lee

ANTENNA POLARITY & TEST DISTANCE: HORIZONTAL AT 3 M								
NO.	FREQ. (MHz)	EMISSION LEVEL (dBuV/m)	LIMIT (dBuV/m)	MARGIN (dB)	ANTENNA HEIGHT (m)	TABLE ANGLE (Degree)	RAW VALUE (dBuV)	CORRECTION FACTOR (dB/m)
1	*5600.00	104.24 PK			1.20 H	22	71.54	32.70
2	*5600.00	93.20 AV			1.20 H	22	60.50	32.70
3	11200.00	59.65 PK	74.00	-14.35	1.35 H	326	26.95	32.70
4	11200.00	46.23 AV	54.00	-7.77	1.35 H	326	13.53	32.70
ANTENNA POLARITY & TEST DISTANCE: VERTICAL AT 3 M								
NO.	FREQ. (MHz)	EMISSION LEVEL (dBuV/m)	LIMIT (dBuV/m)	MARGIN (dB)	ANTENNA HEIGHT (m)	TABLE ANGLE (Degree)	RAW VALUE (dBuV)	CORRECTION FACTOR (dB/m)
1	*5600.00	112.00 PK			1.32 V	25	79.30	32.70
2	*5600.00	100.21 AV			1.32 V	25	67.51	32.70
3	11200.00	57.41 PK	74.00	-16.59	1.58 V	52	24.71	32.70
4	11200.00	43.23 AV	54.00	-10.77	1.58 V	52	10.53	32.70

- REMARKS:**
1. Emission level (dBuV/m) = Raw Value (dBuV) + Correction Factor (dB/m).
  2. Correction Factor (dB/m) = Antenna Factor (dB/m) + Cable Factor (dB).
  3. The other emission levels were very low against the limit.
  4. Margin value = Emission level – Limit value.
  5. “ \* “: Fundamental frequency.



A D T

EUT TEST CONDITION		MEASUREMENT DETAIL	
CHANNEL	Channel 19	FREQUENCY RANGE	1 ~ 40GHz
INPUT POWER (SYSTEM)	120Vac, 60 Hz	DETECTOR FUNCTION	Peak (PK) Average (AV)
ENVIRONMENTAL CONDITIONS	18deg. C, 73%RH 965hPa	TESTED BY	Eric Lee

ANTENNA POLARITY & TEST DISTANCE: HORIZONTAL AT 3 M								
NO.	FREQ. (MHz)	EMISSION LEVEL (dBuV/m)	LIMIT (dBuV/m)	MARGIN (dB)	ANTENNA HEIGHT (m)	TABLE ANGLE (Degree)	RAW VALUE (dBuV)	CORRECTION FACTOR (dB/m)
1	*5700.00	104.21 PK			1.11 H	42	71.51	32.70
2	*5700.00	91.24 AV			1.11 H	42	58.54	32.70
3	#5725.00	56.90 PK	68.30	-11.40	1.02 H	23	24.20	32.70
4	11400.00	60.24 PK	74.00	-13.76	1.30 H	20	27.54	32.70
5	11400.00	46.30 AV	54.00	-7.70	1.30 H	20	13.60	32.70
ANTENNA POLARITY & TEST DISTANCE: VERTICAL AT 3 M								
NO.	FREQ. (MHz)	EMISSION LEVEL (dBuV/m)	LIMIT (dBuV/m)	MARGIN (dB)	ANTENNA HEIGHT (m)	TABLE ANGLE (Degree)	RAW VALUE (dBuV)	CORRECTION FACTOR (dB/m)
1	*5700.00	111.24 PK			1.20 V	41	78.54	32.70
2	*5700.00	100.14 AV			1.20 V	41	67.44	32.70
3	#5725.00	62.40 PK	68.30	-5.90	1.33 V	189	29.70	32.70
4	11520.00	58.54 PK	74.00	-15.46	1.20 V	111	25.84	32.70
5	11520.00	46.23 AV	54.00	-7.77	1.20 V	111	13.53	32.70

- REMARKS:**
1. Emission level (dBuV/m) = Raw Value (dBuV) + Correction Factor (dB/m).
  2. Correction Factor (dB/m) = Antenna Factor (dB/m) + Cable Factor (dB).
  3. The other emission levels were very low against the limit.
  4. Margin value = Emission level – Limit value.
  5. “ \* “: Fundamental frequency.
  6. “#”:The radiated frequency is out the restricted band.





A D T

EUT TEST CONDITION		MEASUREMENT DETAIL	
CHANNEL	Channel 20	FREQUENCY RANGE	1 ~ 40GHz
INPUT POWER	120Vac, 60 Hz	DETECTOR FUNCTION	Peak (PK) Average (AV)
ENVIRONMENTAL CONDITIONS	27deg. C, 67%RH 965hPa	TESTED BY	Frank Liu

ANTENNA POLARITY & TEST DISTANCE: HORIZONTAL AT 3 M								
NO.	FREQ. (MHz)	EMISSION LEVEL (dBuV/m)	LIMIT (dBuV/m)	MARGIN (dB)	ANTENNA HEIGHT (m)	TABLE ANGLE (Degree)	RAW VALUE (dBuV)	CORRECTION FACTOR (dB/m)
1	#5715.000	56.30 PK	68.30	-12.00	1.56 H	63	23.60	32.70
2	#5725.000	67.20 PK	78.30	-11.10	1.24 H	54	34.50	32.70
3	*5745.000	105.21 PK			1.11 H	186	72.51	32.70
4	*5745.000	92.10 AV			1.11 H	186	59.40	32.70
5	11490.000	59.50 PK	74.00	-14.50	1.19 H	51	26.80	32.70
6	11490.000	43.20 AV	54.00	-10.80	1.19 H	51	10.50	32.70
ANTENNA POLARITY & TEST DISTANCE: VERTICAL AT 3 M								
NO.	FREQ. (MHz)	EMISSION LEVEL (dBuV/m)	LIMIT (dBuV/m)	MARGIN (dB)	ANTENNA HEIGHT (m)	TABLE ANGLE (Degree)	RAW VALUE (dBuV)	CORRECTION FACTOR (dB/m)
1	#5715.000	61.30 PK	68.30	-7.00	1.20 V	150	28.60	32.70
2	#5725.000	73.24 PK	78.30	-5.06	1.20 V	149	40.54	32.70
3	*5745.000	111.83 PK			1.19 V	138	79.13	32.70
4	*5745.000	99.18 AV			1.19 V	138	66.48	32.70
5	11490.000	57.45 PK	74.00	-16.55	1.00 V	115	24.75	32.70
6	11490.000	43.20 AV	54.00	-10.80	1.00 V	115	10.50	32.70

- REMARKS:**
1. Emission level (dBuV/m) = Raw Value (dBuV) + Correction Factor (dB/m).
  2. Correction Factor (dB/m) = Antenna Factor (dB/m) + Cable Factor (dB).
  3. The other emission levels were very low against the limit.
  4. Margin value = Emission level – Limit value.
  5. “ \* “: Fundamental frequency.
  6. “#”:The radiated frequency is out the restricted band.



A D T

EUT TEST CONDITION		MEASUREMENT DETAIL	
CHANNEL	Channel 22	FREQUENCY RANGE	1 ~ 40GHz
INPUT POWER	120Vac, 60 Hz	DETECTOR FUNCTION	Peak (PK) Average (AV)
ENVIRONMENTAL CONDITIONS	27deg. C, %RH 965hPa	TESTED BY	Frank Liu

ANTENNA POLARITY & TEST DISTANCE: HORIZONTAL AT 3 M								
NO.	FREQ. (MHz)	EMISSION LEVEL (dBuV/m)	LIMIT (dBuV/m)	MARGIN (dB)	ANTENNA HEIGHT (m)	TABLE ANGLE (Degree)	RAW VALUE (dBuV)	CORRECTION FACTOR (dB/m)
1	*5785.000	103.20 PK			1.11 H	186	70.50	32.70
2	*5785.000	91.08 AV			1.11 H	186	58.38	32.70
3	11570.000	59.25 PK	74.00	-14.75	1.62 H	203	26.55	32.70
4	11570.000	45.23 AV	54.00	-8.77	1.62 H	203	12.53	32.70
ANTENNA POLARITY & TEST DISTANCE: VERTICAL AT 3 M								
NO.	FREQ. (MHz)	EMISSION LEVEL (dBuV/m)	LIMIT (dBuV/m)	MARGIN (dB)	ANTENNA HEIGHT (m)	TABLE ANGLE (Degree)	RAW VALUE (dBuV)	CORRECTION FACTOR (dB/m)
1	*5785.000	113.24 PK			1.20 V	40	80.54	32.70
2	*5785.000	102.21 AV			1.20 V	40	69.51	32.70
3	11570.000	56.20 PK	74.00	-17.80	1.00 V	23	23.50	32.70
4	11570.000	42.10 AV	54.00	-11.90	1.00 V	23	9.40	32.70

- REMARKS:**
1. Emission level (dBuV/m) = Raw Value (dBuV) + Correction Factor (dB/m).
  2. Correction Factor (dB/m) = Antenna Factor (dB/m) + Cable Factor (dB).
  3. The other emission levels were very low against the limit.
  4. Margin value = Emission level – Limit value.
  5. “ \* “: Fundamental frequency.
  6. "#":The radiated frequency is out the restricted band.



A D T

EUT TEST CONDITION		MEASUREMENT DETAIL	
CHANNEL	Channel 23	FREQUENCY RANGE	1 ~ 40GHz
INPUT POWER	120Vac, 60 Hz	DETECTOR FUNCTION	Peak (PK) Average (AV)
ENVIRONMENTAL CONDITIONS	27deg. C, %RH 965hPa	TESTED BY	Frank Liu

**ANTENNA POLARITY & TEST DISTANCE: HORIZONTAL AT 3 M**

NO.	FREQ. (MHz)	EMISSION LEVEL (dBuV/m)	LIMIT (dBuV/m)	MARGIN (dB)	ANTENNA HEIGHT (m)	TABLE ANGLE (Degree)	RAW VALUE (dBuV)	CORRECTION FACTOR (dB/m)
1	*5805.000	105.84 PK			1.65 H	25	73.14	32.70
2	*5805.000	94.60 AV			1.65 H	25	61.90	32.70
3	#5825.000	68.10 PK	78.30	-10.20	1.02 H	24	35.40	32.70
4	#5835.000	56.36 PK	68.30	-12.00	1.33 H	36	23.60	32.70
5	11610.000	59.24 PK	74.00	-14.76	1.24 H	2	26.54	32.70
6	11610.000	43.23 AV	54.00	-10.77	1.24 H	2	10.53	32.70

**ANTENNA POLARITY & TEST DISTANCE: VERTICAL AT 3 M**

NO.	FREQ. (MHz)	EMISSION LEVEL (dBuV/m)	LIMIT (dBuV/m)	MARGIN (dB)	ANTENNA HEIGHT (m)	TABLE ANGLE (Degree)	RAW VALUE (dBuV)	CORRECTION FACTOR (dB/m)
1	*5805.000	112.24 PK			1.20 V	20	79.54	32.70
2	*5805.000	102.20 AV			1.20 V	20	69.50	32.70
3	#5825.000	73.20 PK	78.30	-5.10	1.60 V	25	40.50	32.70
4	#5835.000	61.10 PK	68.30	-7.20	1.20 V	22	28.40	32.70
5	11610.000	59.24 PK	74.00	-14.76	1.35 V	6	26.54	32.70
6	11610.000	42.36 AV	54.00	-11.64	1.35 V	6	9.66	32.70

- REMARKS:**
1. Emission level (dBuV/m) = Raw Value (dBuV) + Correction Factor (dB/m).
  2. Correction Factor (dB/m) = Antenna Factor (dB/m) + Cable Factor (dB).
  3. The other emission levels were very low against the limit.
  4. Margin value = Emission level – Limit value.
  5. “ \* “: Fundamental frequency.
  6. “#”:The radiated frequency is out the restricted band.





A D T

### RESTRICTED BANDEDGE (DRAFT 802.11n (20MHz) MODE,CH1, VERTICAL )

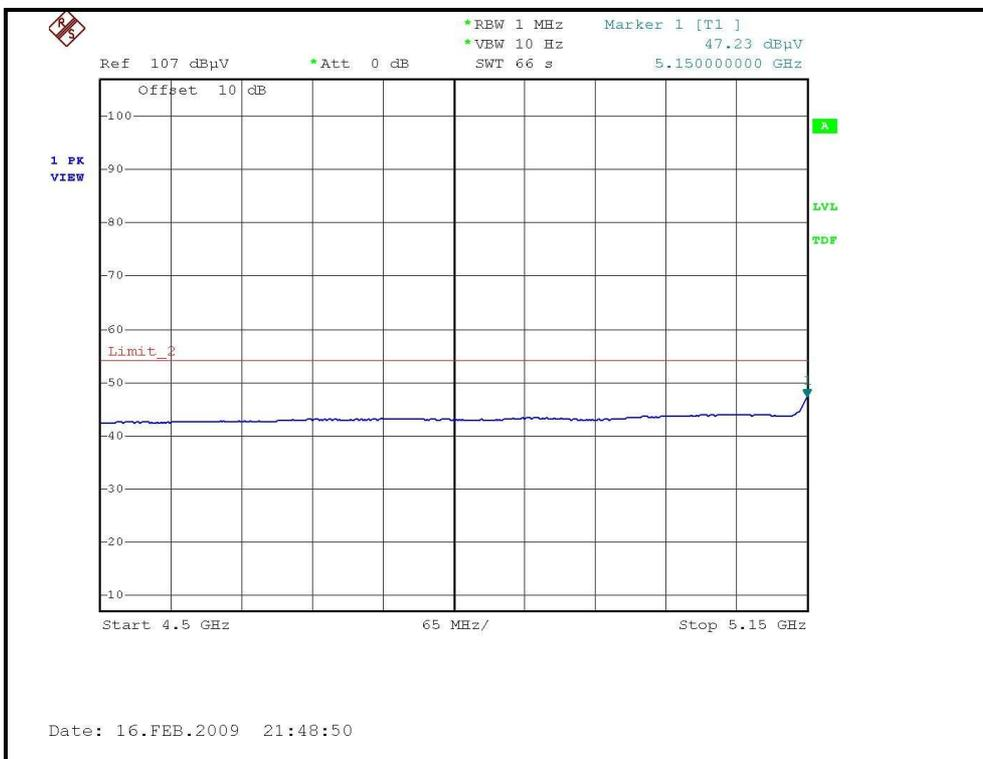
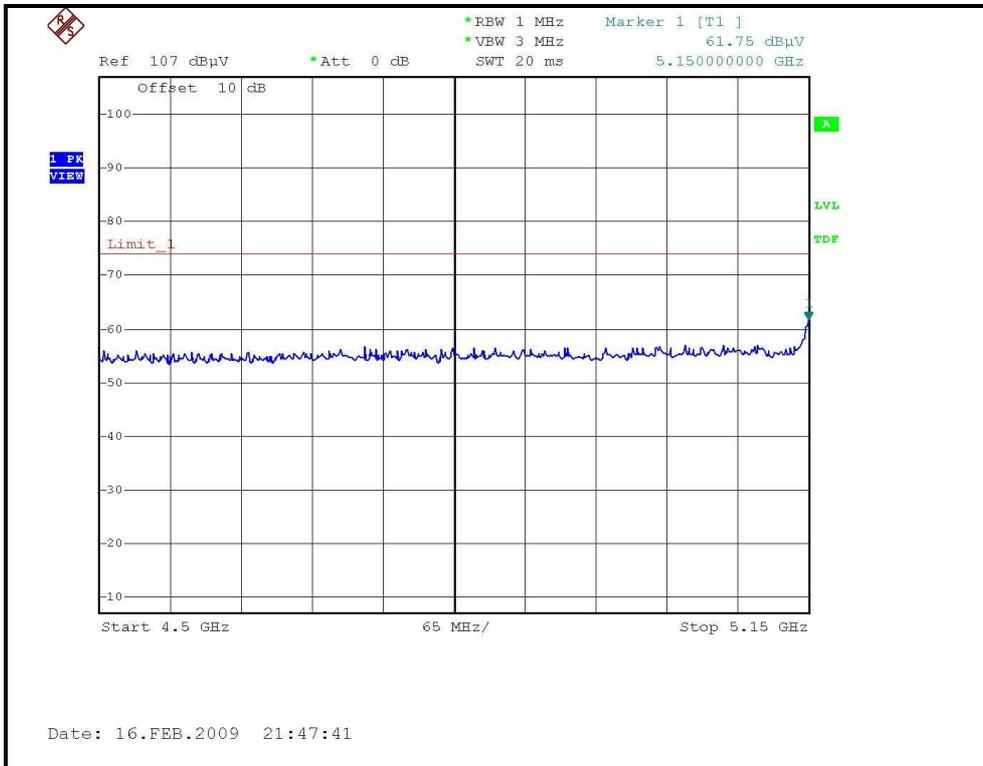



A D T

### RESTRICTED BANDEDGE (DRAFT 802.11n (20MHz) MODE, CH8, HORIZONTAL )

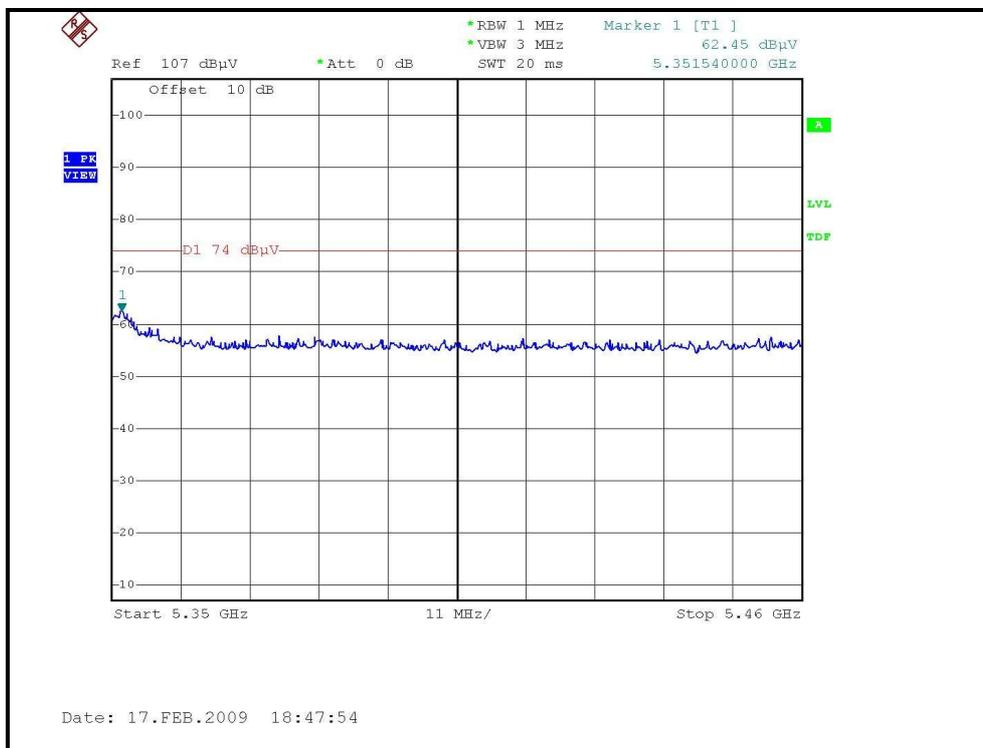



A D T

### RESTRICTED BANDEDGE (DRAFT 802.11n (20MHz) MODE,CH8, VERTICAL )

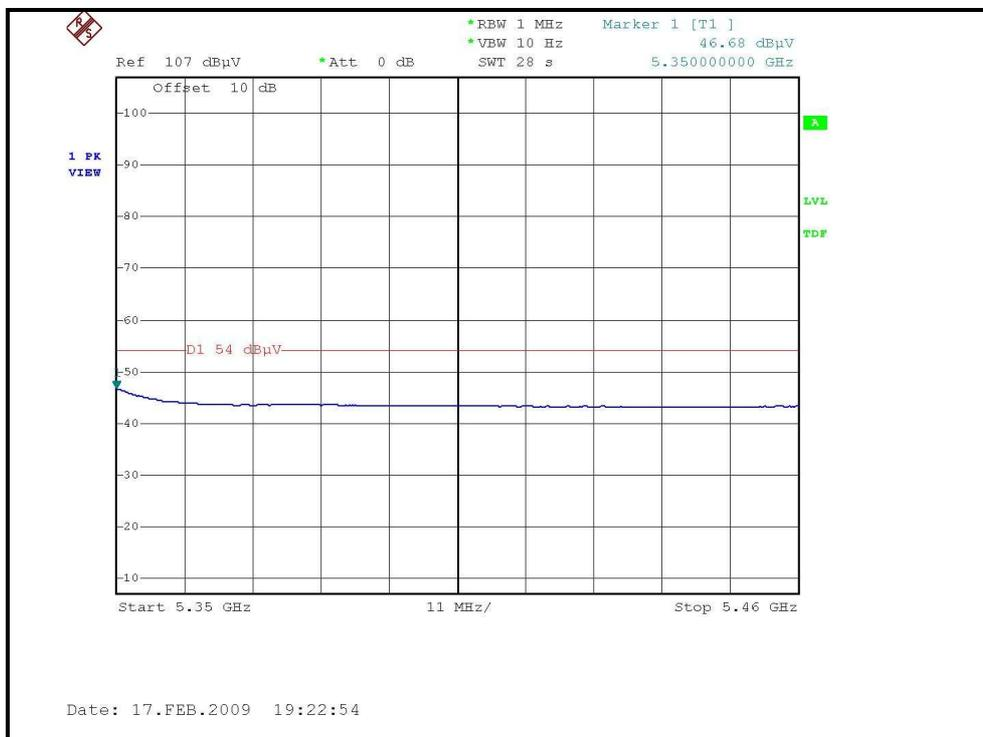
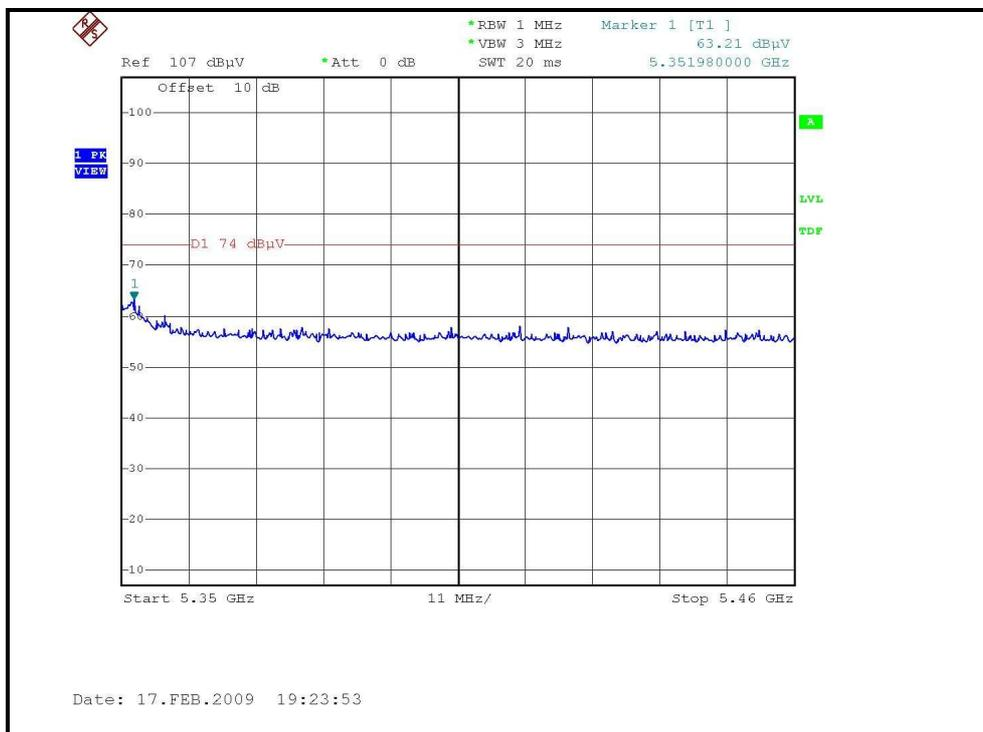



A D T

### RESTRICTED BANDEDGE (DRAFT 802.11n (20MHz) MODE, CH9, HORIZONTAL )

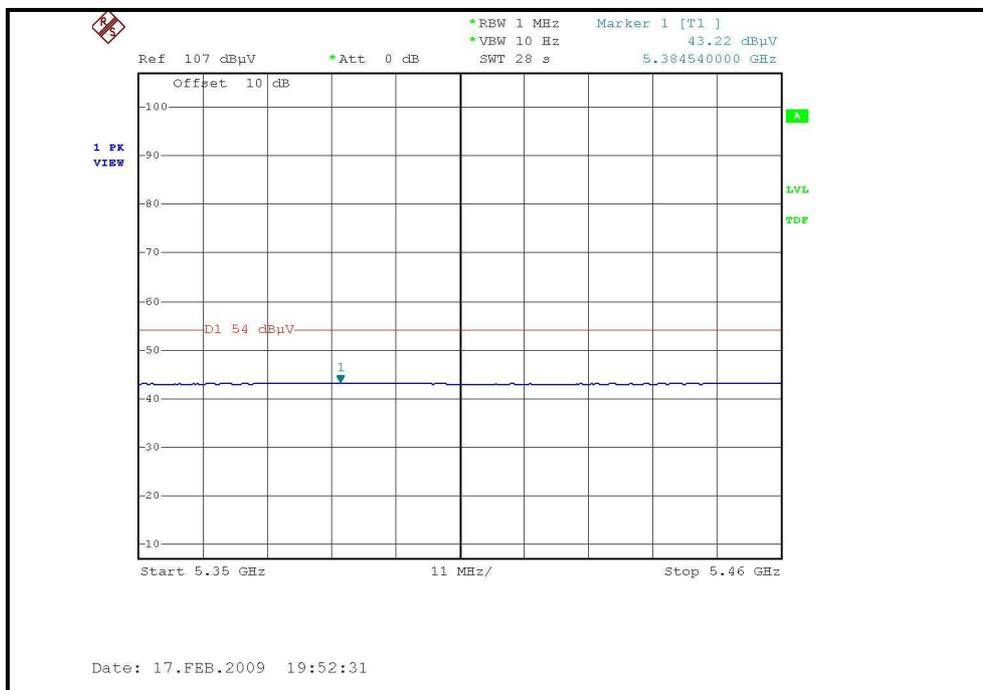
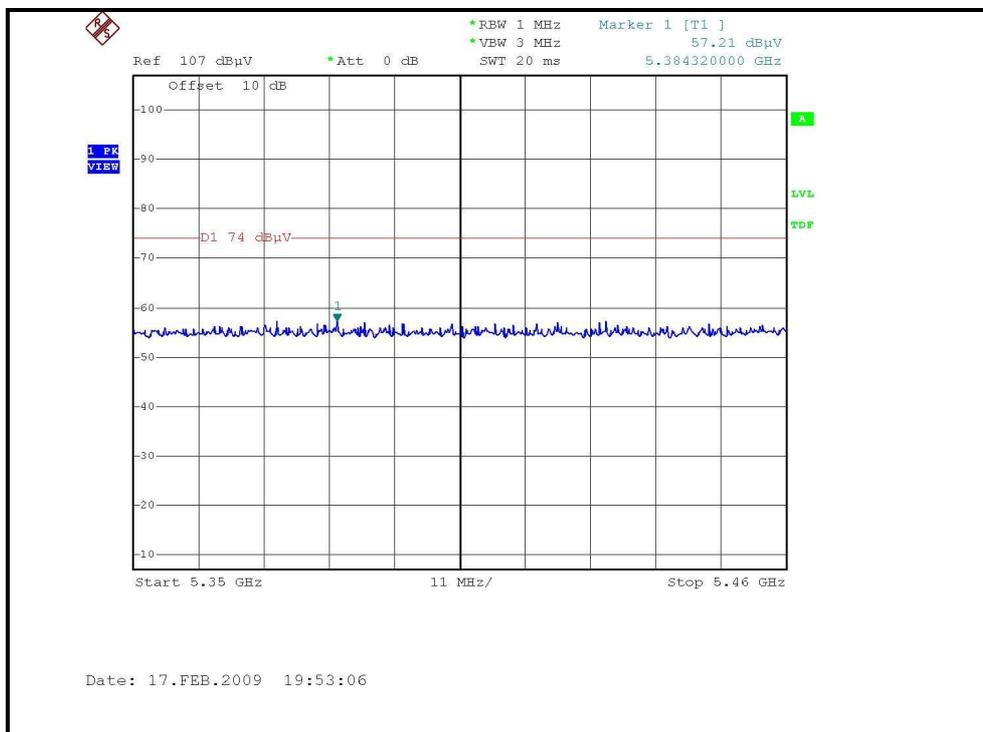





A D T

### RESTRICTED BANDEDGE (DRAFT 802.11n (20MHz) MODE,CH9, VERTICAL )

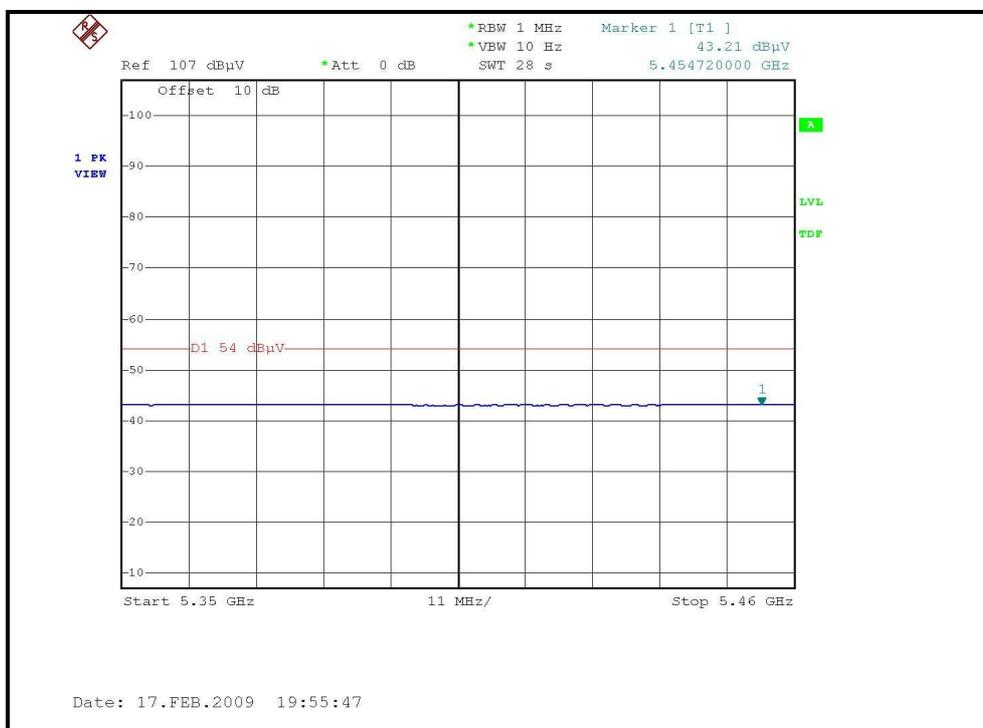
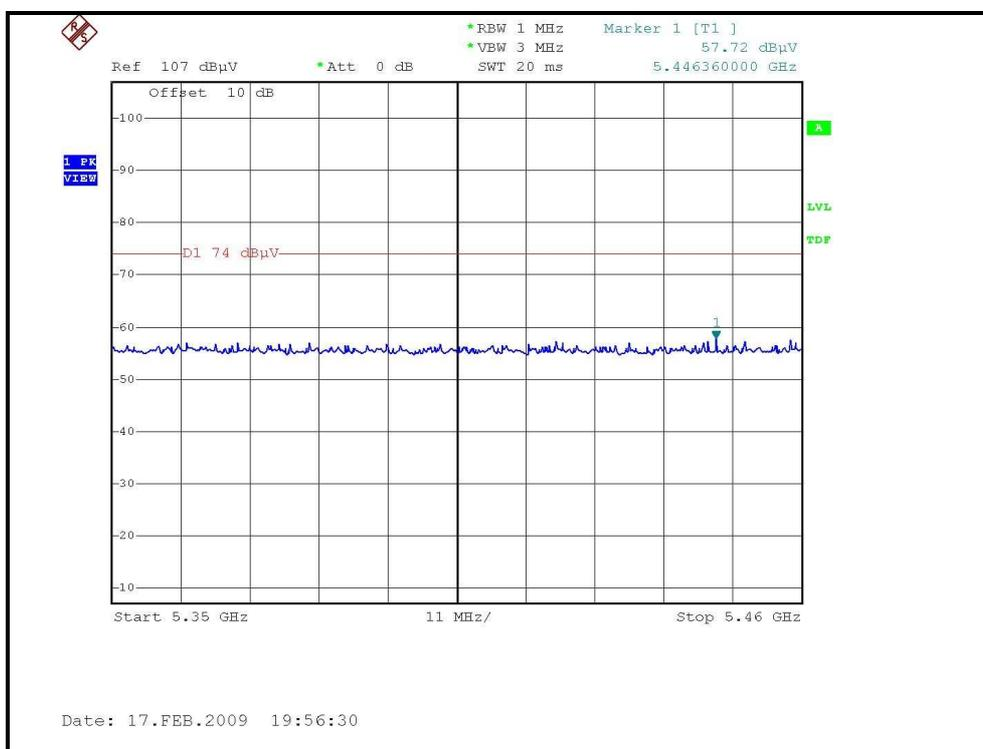



DRAFT 802.11n (40MHz) OFDM MODULATION

EUT TEST CONDITION		MEASUREMENT DETAIL	
CHANNEL	Channel 1	FREQUENCY RANGE	1 ~ 40GHz
INPUT POWER (SYSTEM)	120Vac, 60 Hz	DETECTOR FUNCTION	Peak (PK) Average (AV)
ENVIRONMENTAL CONDITIONS	18deg. C, 73%RH 965hPa	TESTED BY	Eric Lee

ANTENNA POLARITY & TEST DISTANCE: HORIZONTAL AT 3 M								
NO.	FREQ. (MHz)	EMISSION LEVEL (dBuV/m)	LIMIT (dBuV/m)	MARGIN (dB)	ANTENNA HEIGHT (m)	TABLE ANGLE (Degree)	RAW VALUE (dBuV)	CORRECTION FACTOR (dB/m)
1	5150.00	64.51 PK	74.00	-9.49	1.43 H	329	27.25	37.26
2	5150.00	51.43 AV	54.00	-2.57	1.43 H	329	14.17	37.26
3	*5190.00	103.21 PK			1.19 H	35	65.95	37.26
4	*5190.00	90.78 AV			1.19 H	35	53.52	37.26
5	#10380.00	58.24 PK	68.30	-10.06	1.11 H	200	11.59	46.65

ANTENNA POLARITY & TEST DISTANCE: VERTICAL AT 3 M								
NO.	FREQ. (MHz)	EMISSION LEVEL (dBuV/m)	LIMIT (dBuV/m)	MARGIN (dB)	ANTENNA HEIGHT (m)	TABLE ANGLE (Degree)	RAW VALUE (dBuV)	CORRECTION FACTOR (dB/m)
1	5150.00	63.50 PK	74.00	-10.50	1.24 V	21	26.24	37.26
2	5150.00	51.82 AV	54.00	-2.18	1.24 V	21	14.56	37.26
3	*5190.00	109.24 PK			1.20 V	73	71.98	37.26
4	*5190.00	96.10 AV			1.20 V	73	58.84	37.26
5	#10380.00	58.21 PK	68.30	-10.09	1.46 V	61	11.56	46.65

- REMARKS:**
1. Emission level (dBuV/m) = Raw Value (dBuV) + Correction Factor (dB/m).
  2. Correction Factor (dB/m) = Antenna Factor (dB/m) + Cable Factor (dB).
  3. The other emission levels were very low against the limit.
  4. Margin value = Emission level – Limit value.
  5. “ \* “: Fundamental frequency.
  6. "#":The radiated frequency is out the restricted band.



A D T

EUT TEST CONDITION		MEASUREMENT DETAIL	
CHANNEL	Channel 2	FREQUENCY RANGE	1 ~ 40GHz
INPUT POWER (SYSTEM)	120Vac, 60 Hz	DETECTOR FUNCTION	Peak (PK) Average (AV)
ENVIRONMENTAL CONDITIONS	18deg. C, 73%RH 965hPa	TESTED BY	Eric Lee

ANTENNA POLARITY & TEST DISTANCE: HORIZONTAL AT 3 M								
NO.	FREQ. (MHz)	EMISSION LEVEL (dBuV/m)	LIMIT (dBuV/m)	MARGIN (dB)	ANTENNA HEIGHT (m)	TABLE ANGLE (Degree)	RAW VALUE (dBuV)	CORRECTION FACTOR (dB/m)
1	*5230.00	104.90 PK			1.20 H	202	67.64	37.26
2	*5230.00	91.89 AV			1.20 H	202	54.63	37.26
3	#10460.00	58.98 PK	68.30	-9.32	1.54 H	236	12.26	46.72
ANTENNA POLARITY & TEST DISTANCE: VERTICAL AT 3 M								
NO.	FREQ. (MHz)	EMISSION LEVEL (dBuV/m)	LIMIT (dBuV/m)	MARGIN (dB)	ANTENNA HEIGHT (m)	TABLE ANGLE (Degree)	RAW VALUE (dBuV)	CORRECTION FACTOR (dB/m)
1	*5230.00	110.21 PK			1.20 V	61	72.95	37.26
2	*5230.00	97.10 AV			1.20 V	61	59.84	37.26
3	#10460.00	57.56 PK	68.30	-10.74	1.45 V	248	10.84	46.72

- REMARKS:**
1. Emission level (dBuV/m) = Raw Value (dBuV) + Correction Factor (dB/m).
  2. Correction Factor (dB/m) = Antenna Factor (dB/m) + Cable Factor (dB).
  3. The other emission levels were very low against the limit.
  4. Margin value = Emission level – Limit value.
  5. “ \* “: Fundamental frequency.
  6. "#":The radiated frequency is out the restricted band.



A D T

EUT TEST CONDITION		MEASUREMENT DETAIL	
CHANNEL	Channel 3	FREQUENCY RANGE	1 ~ 40GHz
INPUT POWER (SYSTEM)	120Vac, 60 Hz	DETECTOR FUNCTION	Peak (PK) Average (AV)
ENVIRONMENTAL CONDITIONS	18deg. C, 73%RH 965hPa	TESTED BY	Eric Lee

ANTENNA POLARITY & TEST DISTANCE: HORIZONTAL AT 3 M								
NO.	FREQ. (MHz)	EMISSION LEVEL (dBuV/m)	LIMIT (dBuV/m)	MARGIN (dB)	ANTENNA HEIGHT (m)	TABLE ANGLE (Degree)	RAW VALUE (dBuV)	CORRECTION FACTOR (dB/m)
1	*5270.00	105.45 PK			1.15 H	190	68.19	37.26
2	*5270.00	91.49 AV			1.15 H	190	54.23	37.26
3	#10540.00	58.90 PK	68.30	-9.40	1.50 H	2	12.12	46.78
ANTENNA POLARITY & TEST DISTANCE: VERTICAL AT 3 M								
NO.	FREQ. (MHz)	EMISSION LEVEL (dBuV/m)	LIMIT (dBuV/m)	MARGIN (dB)	ANTENNA HEIGHT (m)	TABLE ANGLE (Degree)	RAW VALUE (dBuV)	CORRECTION FACTOR (dB/m)
1	*5270.00	110.24 PK			1.20 V	48	72.98	37.26
2	*5270.00	97.53 AV			1.20 V	48	60.27	37.26
3	#10540.00	58.45 PK	68.30	-9.85	1.20 V	48	11.67	46.78

- REMARKS:**
1. Emission level (dBuV/m) = Raw Value (dBuV) + Correction Factor (dB/m).
  2. Correction Factor (dB/m) = Antenna Factor (dB/m) + Cable Factor (dB).
  3. The other emission levels were very low against the limit.
  4. Margin value = Emission level – Limit value.
  5. “ \* “: Fundamental frequency.
  6. “#”:The radiated frequency is out the restricted band.



A D T

EUT TEST CONDITION		MEASUREMENT DETAIL	
CHANNEL	Channel 4	FREQUENCY RANGE	1 ~ 40GHz
INPUT POWER (SYSTEM)	120Vac, 60 Hz	DETECTOR FUNCTION	Peak (PK) Average (AV)
ENVIRONMENTAL CONDITIONS	18deg. C, 73%RH 965hPa	TESTED BY	Eric Lee

ANTENNA POLARITY & TEST DISTANCE: HORIZONTAL AT 3 M								
NO.	FREQ. (MHz)	EMISSION LEVEL (dBuV/m)	LIMIT (dBuV/m)	MARGIN (dB)	ANTENNA HEIGHT (m)	TABLE ANGLE (Degree)	RAW VALUE (dBuV)	CORRECTION FACTOR (dB/m)
1	*5310.00	108.24 PK			1.20 H	231	70.98	37.26
2	*5310.00	94.23 AV			1.20 H	231	56.97	37.26
3	5350.00	66.63 PK	74.00	-7.37	1.47 H	44	29.37	37.26
4	5350.00	51.35 AV	54.00	-2.65	1.47 H	44	14.09	37.26
5	10620.00	58.65 PK	74.00	-15.35	1.02 H	78	11.80	46.85
6	10620.00	44.58 AV	54.00	-9.42	1.02 H	78	-2.27	46.85
ANTENNA POLARITY & TEST DISTANCE: VERTICAL AT 3 M								
NO.	FREQ. (MHz)	EMISSION LEVEL (dBuV/m)	LIMIT (dBuV/m)	MARGIN (dB)	ANTENNA HEIGHT (m)	TABLE ANGLE (Degree)	RAW VALUE (dBuV)	CORRECTION FACTOR (dB/m)
1	*5310.00	112.24 PK			1.20 V	32	74.98	37.26
2	*5310.00	98.74 AV			1.20 V	32	61.48	37.26
3	5350.00	65.59 PK	74.00	-8.41	1.24 V	54	28.33	37.26
4	<b>5350.00</b>	<b>52.56 AV</b>	<b>54.00</b>	<b>-1.44</b>	<b>1.24 V</b>	<b>54</b>	<b>15.30</b>	<b>37.26</b>
5	10620.00	57.54 PK	74.00	-16.46	1.67 V	247	10.69	46.85
6	10620.00	43.56 AV	54.00	-10.44	1.67 V	247	-3.29	46.85

- REMARKS:**
1. Emission level (dBuV/m) = Raw Value (dBuV) + Correction Factor (dB/m).
  2. Correction Factor (dB/m) = Antenna Factor (dB/m) + Cable Factor (dB).
  3. The other emission levels were very low against the limit.
  4. Margin value = Emission level – Limit value.
  5. “ \* “: Fundamental frequency.



A D T

EUT TEST CONDITION		MEASUREMENT DETAIL	
CHANNEL	Channel 5	FREQUENCY RANGE	1 ~ 40GHz
INPUT POWER (SYSTEM)	120Vac, 60 Hz	DETECTOR FUNCTION	Peak (PK) Average (AV)
ENVIRONMENTAL CONDITIONS	18deg. C, 73%RH 965hPa	TESTED BY	Eric Lee

ANTENNA POLARITY & TEST DISTANCE: HORIZONTAL AT 3 M								
NO.	FREQ. (MHz)	EMISSION LEVEL (dBuV/m)	LIMIT (dBuV/m)	MARGIN (dB)	ANTENNA HEIGHT (m)	TABLE ANGLE (Degree)	RAW VALUE (dBuV)	CORRECTION FACTOR (dB/m)
1	5460.00	59.92 PK	74.00	-14.08	1.59 H	47	22.66	37.26
2	5460.00	47.33 AV	54.00	-6.67	1.59 H	47	10.07	37.26
3	#5470.00	58.99 PK	68.30	-9.31	1.89 H	2	21.73	37.26
4	*5510.00	105.24 PK			1.20 H	230	67.95	37.29
5	*5510.00	91.40 AV			1.20 H	230	54.11	37.29
6	11020.00	58.02 PK	74.00	-15.98	1.53 H	62	10.87	47.15
7	11020.00	46.32 AV	54.00	-7.68	1.53 H	62	-0.83	47.15

ANTENNA POLARITY & TEST DISTANCE: VERTICAL AT 3 M								
NO.	FREQ. (MHz)	EMISSION LEVEL (dBuV/m)	LIMIT (dBuV/m)	MARGIN (dB)	ANTENNA HEIGHT (m)	TABLE ANGLE (Degree)	RAW VALUE (dBuV)	CORRECTION FACTOR (dB/m)
1	5460.00	57.80 PK	74.00	-16.20	1.45 V	85	20.54	37.26
2	5460.00	44.86 AV	54.00	-9.14	1.45 V	85	7.60	37.26
3	#5470.00	62.24 PK	68.30	-6.06	1.42 V	354	24.98	37.26
4	*5510.00	109.54 PK			1.20 V	29	72.25	37.29
5	*5510.00	96.47 AV			1.20 V	29	59.18	37.29
6	11020.00	58.69 PK	74.00	-15.31	1.62 V	45	11.54	47.15
7	11020.00	45.14 AV	54.00	-8.86	1.62 V	45	-2.01	47.15

- REMARKS:**
1. Emission level (dBuV/m) = Raw Value (dBuV) + Correction Factor (dB/m).
  2. Correction Factor (dB/m) = Antenna Factor (dB/m) + Cable Factor (dB).
  3. The other emission levels were very low against the limit.
  4. Margin value = Emission level – Limit value.
  5. " \* ": Fundamental frequency.
  6. "#":The radiated frequency is out the restricted band.



A D T

EUT TEST CONDITION		MEASUREMENT DETAIL	
CHANNEL	Channel 7	FREQUENCY RANGE	1 ~ 40GHz
INPUT POWER (SYSTEM)	120Vac, 60 Hz	DETECTOR FUNCTION	Peak (PK) Average (AV)
ENVIRONMENTAL CONDITIONS	18deg. C, 73%RH 965hPa	TESTED BY	Eric Lee

ANTENNA POLARITY & TEST DISTANCE: HORIZONTAL AT 3 M								
NO.	FREQ. (MHz)	EMISSION LEVEL (dBuV/m)	LIMIT (dBuV/m)	MARGIN (dB)	ANTENNA HEIGHT (m)	TABLE ANGLE (Degree)	RAW VALUE (dBuV)	CORRECTION FACTOR (dB/m)
1	*5590.00	107.65 PK			1.20 H	200	70.13	37.52
2	*5590.00	93.98 AV			1.20 H	200	56.46	37.52
3	11180.00	59.78 PK	74.00	-14.22	1.68 H	203	12.60	47.18
4	11180.00	46.24 AV	54.00	-7.76	1.68 H	203	-0.94	47.18
ANTENNA POLARITY & TEST DISTANCE: VERTICAL AT 3 M								
NO.	FREQ. (MHz)	EMISSION LEVEL (dBuV/m)	LIMIT (dBuV/m)	MARGIN (dB)	ANTENNA HEIGHT (m)	TABLE ANGLE (Degree)	RAW VALUE (dBuV)	CORRECTION FACTOR (dB/m)
1	*5590.00	112.54 PK			1.54 V	24	75.02	37.52
2	*5590.00	98.69 AV			1.54 V	24	61.17	37.52
3	11180.00	57.84 PK	74.00	-16.16	1.36 V	62	10.66	47.18
4	11180.00	44.69 AV	54.00	-9.31	1.36 V	62	-2.49	47.18

- REMARKS:**
1. Emission level (dBuV/m) = Raw Value (dBuV) + Correction Factor (dB/m).
  2. Correction Factor (dB/m) = Antenna Factor (dB/m) + Cable Factor (dB).
  3. The other emission levels were very low against the limit.
  4. Margin value = Emission level – Limit value.
  5. “ \* “: Fundamental frequency.



A D T

EUT TEST CONDITION		MEASUREMENT DETAIL	
CHANNEL	Channel 9	FREQUENCY RANGE	1 ~ 40GHz
INPUT POWER (SYSTEM)	120Vac, 60 Hz	DETECTOR FUNCTION	Peak (PK) Average (AV)
ENVIRONMENTAL CONDITIONS	18deg. C, 73%RH 965hPa	TESTED BY	Eric Lee

ANTENNA POLARITY & TEST DISTANCE: HORIZONTAL AT 3 M								
NO.	FREQ. (MHz)	EMISSION LEVEL (dBuV/m)	LIMIT (dBuV/m)	MARGIN (dB)	ANTENNA HEIGHT (m)	TABLE ANGLE (Degree)	RAW VALUE (dBuV)	CORRECTION FACTOR (dB/m)
1	*5670.00	108.55 PK			1.16 H	190	70.81	37.74
2	*5670.00	94.00 AV			1.16 H	190	56.26	37.74
3	#5725.00	59.30 PK	68.30	-9.00	1.66 H	235	21.40	37.90
4	11340.00	60.24 PK	74.00	-13.76	1.58 H	7	13.04	47.20
5	11340.00	46.90 AV	54.00	-7.10	1.58 H	7	-0.30	47.20
ANTENNA POLARITY & TEST DISTANCE: VERTICAL AT 3 M								
NO.	FREQ. (MHz)	EMISSION LEVEL (dBuV/m)	LIMIT (dBuV/m)	MARGIN (dB)	ANTENNA HEIGHT (m)	TABLE ANGLE (Degree)	RAW VALUE (dBuV)	CORRECTION FACTOR (dB/m)
1	*5670.00	112.58 PK			1.20 V	91	74.84	37.74
2	*5670.00	98.30 AV			1.20 V	91	60.56	37.74
3	#5725.00	62.31 PK	68.30	-5.99	1.64 V	247	24.41	37.90
4	11340.00	58.64 PK	74.00	-15.36	1.11 V	93	11.44	47.20
5	11340.00	45.20 AV	54.00	-8.80	1.11 V	93	-2.00	47.20

- REMARKS:**
1. Emission level (dBuV/m) = Raw Value (dBuV) + Correction Factor (dB/m).
  2. Correction Factor (dB/m) = Antenna Factor (dB/m) + Cable Factor (dB).
  3. The other emission levels were very low against the limit.
  4. Margin value = Emission level – Limit value.
  5. “ \* “: Fundamental frequency.
  6. “#”:The radiated frequency is out the restricted band.





A D T

EUT TEST CONDITION		MEASUREMENT DETAIL	
CHANNEL	Channel 10	FREQUENCY RANGE	1 ~ 40GHz
INPUT POWER	120Vac, 60 Hz	DETECTOR FUNCTION	Peak (PK) Average (AV)
ENVIRONMENTAL CONDITIONS	18deg. C, 73%RH 965hPa	TESTED BY	Eric Lee

**ANTENNA POLARITY & TEST DISTANCE: HORIZONTAL AT 3 M**

NO.	FREQ. (MHz)	EMISSION LEVEL (dBuV/m)	LIMIT (dBuV/m)	MARGIN (dB)	ANTENNA HEIGHT (m)	TABLE ANGLE (Degree)	RAW VALUE (dBuV)	CORRECTION FACTOR (dB/m)
1	#5715.000	56.60 PK	68.30	-11.70	1.20 H	198	18.73	37.87
2	#5725.000	68.21 PK	78.30	-10.09	1.19 H	200	30.31	37.90
3	*5755.000	107.24 PK			1.19 H	201	69.26	37.98
4	*5755.000	93.45 AV			1.19 H	201	55.47	37.98
5	11510.000	61.25 PK	74.00	-12.75	1.23 H	326	14.02	47.23
6	11510.000	47.12 AV	54.00	-6.88	1.23 H	326	-0.11	47.23

**ANTENNA POLARITY & TEST DISTANCE: VERTICAL AT 3 M**

NO.	FREQ. (MHz)	EMISSION LEVEL (dBuV/m)	LIMIT (dBuV/m)	MARGIN (dB)	ANTENNA HEIGHT (m)	TABLE ANGLE (Degree)	RAW VALUE (dBuV)	CORRECTION FACTOR (dB/m)
1	#5715.000	63.46 PK	68.30	-4.84	1.21 V	59	25.59	37.87
2	#5725.000	75.90 PK	78.30	-2.40	1.20 V	61	38.00	37.90
3	*5755.000	111.01 PK			1.17 V	29	73.03	37.98
4	*5755.000	97.79 AV			1.17 V	29	59.81	37.98
5	11510.000	59.58 PK	74.00	-14.42	1.02 V	54	12.35	47.23
6	11510.000	45.23 AV	54.00	-8.77	1.02 V	54	-2.00	47.23

- REMARKS:**
1. Emission level (dBuV/m) = Raw Value (dBuV) + Correction Factor (dB/m).
  2. Correction Factor (dB/m) = Antenna Factor (dB/m) + Cable Factor (dB).
  3. The other emission levels were very low against the limit.
  4. Margin value = Emission level – Limit value.
  5. “ \* “: Fundamental frequency.
  6. "#":The radiated frequency is out the restricted band.



A D T

EUT TEST CONDITION		MEASUREMENT DETAIL	
CHANNEL	Channel 11	FREQUENCY RANGE	1 ~ 40GHz
INPUT POWER	120Vac, 60 Hz	DETECTOR FUNCTION	Peak (PK) Average (AV)
ENVIRONMENTAL CONDITIONS	18deg. C, 73%RH 965hPa	TESTED BY	Eric Lee

**ANTENNA POLARITY & TEST DISTANCE: HORIZONTAL AT 3 M**

NO.	FREQ. (MHz)	EMISSION LEVEL (dBuV/m)	LIMIT (dBuV/m)	MARGIN (dB)	ANTENNA HEIGHT (m)	TABLE ANGLE (Degree)	RAW VALUE (dBuV)	CORRECTION FACTOR (dB/m)
1	*5795.000	106.24 PK			1.24 H	201	68.14	38.10
2	*5795.000	92.33 AV			1.24 H	201	54.23	38.10
3	#5825.000	67.21 PK	78.30	-11.09	1.22 H	203	29.03	38.18
4	#5835.000	56.45 PK	68.30	-11.85	1.20 H	200	18.24	38.21
5	11590.000	60.24 PK	74.00	-13.76	2.00 H	21	13.02	47.22
6	11590.000	45.36 AV	54.00	-8.64	2.00 H	21	-1.86	47.22

**ANTENNA POLARITY & TEST DISTANCE: VERTICAL AT 3 M**

NO.	FREQ. (MHz)	EMISSION LEVEL (dBuV/m)	LIMIT (dBuV/m)	MARGIN (dB)	ANTENNA HEIGHT (m)	TABLE ANGLE (Degree)	RAW VALUE (dBuV)	CORRECTION FACTOR (dB/m)
1	*5795.000	112.24 PK			1.23 V	76	74.14	38.10
2	*5795.000	98.10 AV			1.23 V	76	60.00	38.10
3	#5825.000	76.40 PK	78.30	-1.90	1.22 V	45	38.22	38.18
4	#5835.000	65.30 PK	68.30	-3.00	1.20 V	66	27.09	38.21
5	11590.000	58.56 PK	74.00	-15.44	1.68 V	63	11.34	47.22
6	11590.000	43.39 AV	54.00	-10.61	1.68 V	63	-3.83	47.22

- REMARKS:**
1. Emission level (dBuV/m) = Raw Value (dBuV) + Correction Factor (dB/m).
  2. Correction Factor (dB/m) = Antenna Factor (dB/m) + Cable Factor (dB).
  3. The other emission levels were very low against the limit.
  4. Margin value = Emission level – Limit value.
  5. “ \* “: Fundamental frequency.
  6. "#":The radiated frequency is out the restricted band.



A D T

### RESTRICTED BANDEDGE (DRAFT 802.11n (40MHz) MODE, CH1, HORIZONTAL)

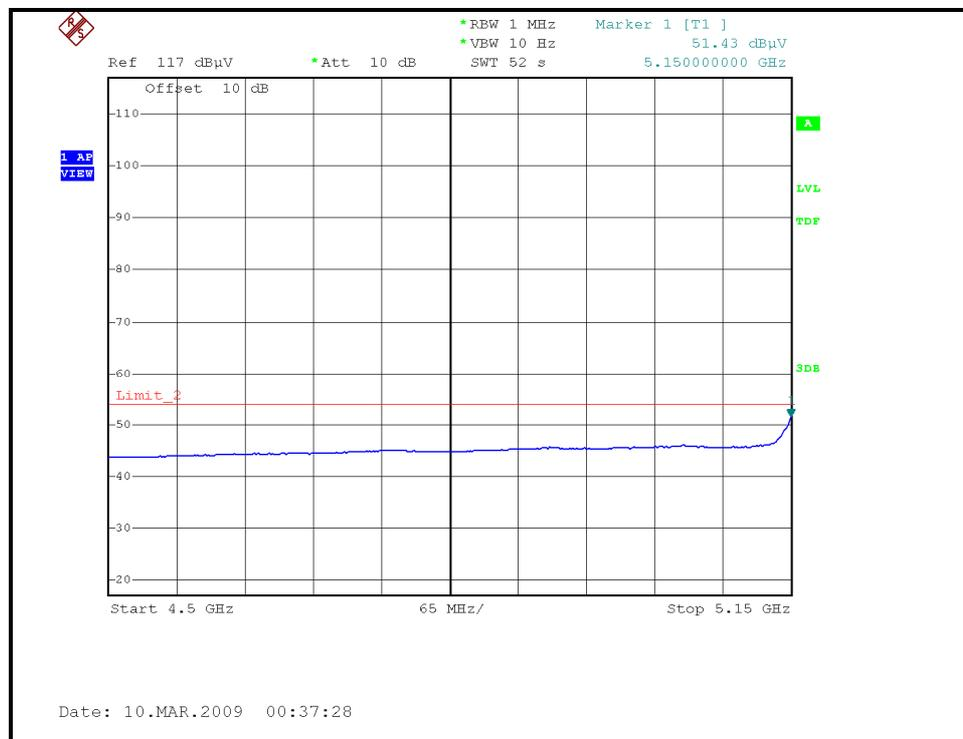
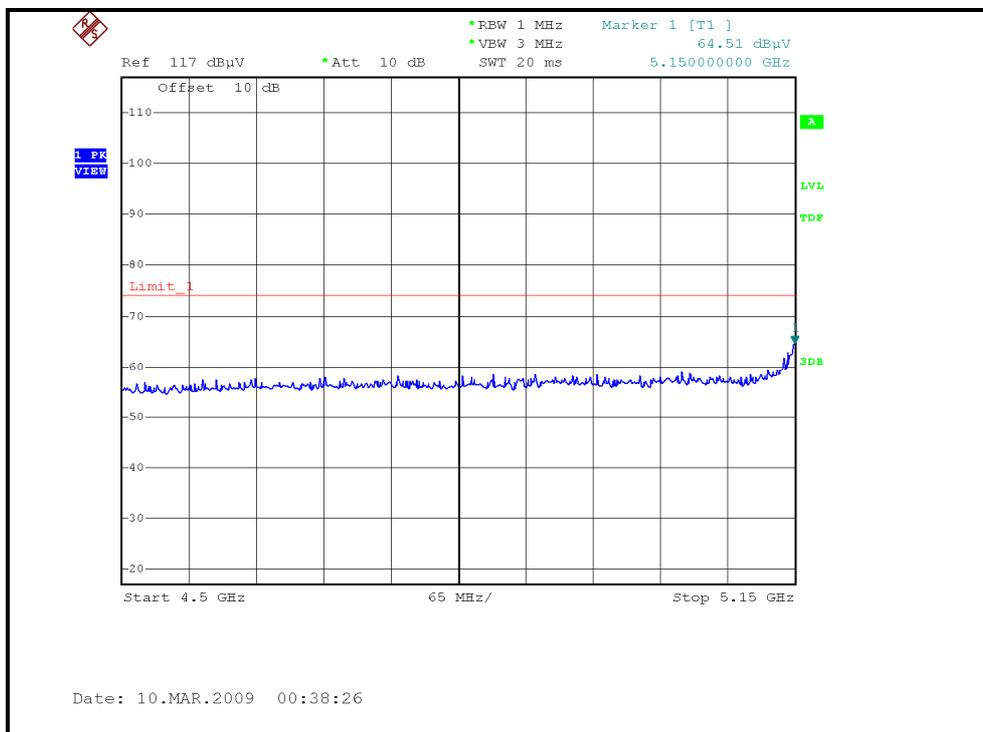



A D T

### RESTRICTED BANDEDGE (DRAFT 802.11n (40MHz) MODE,CH1, VERTICAL )

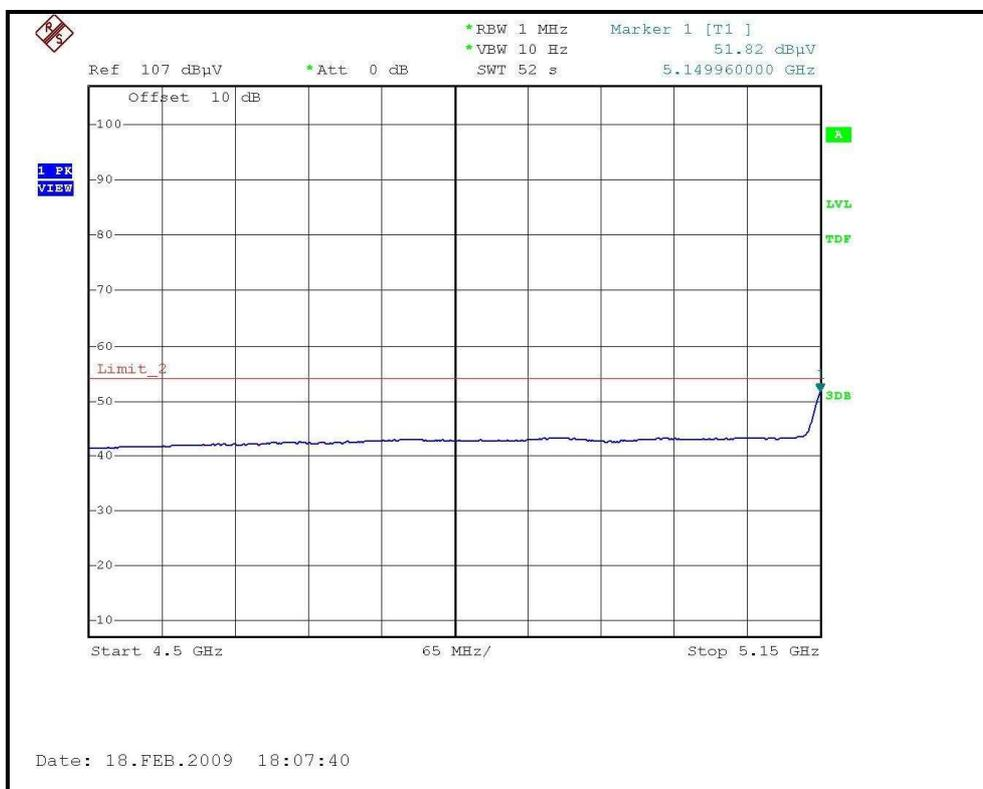
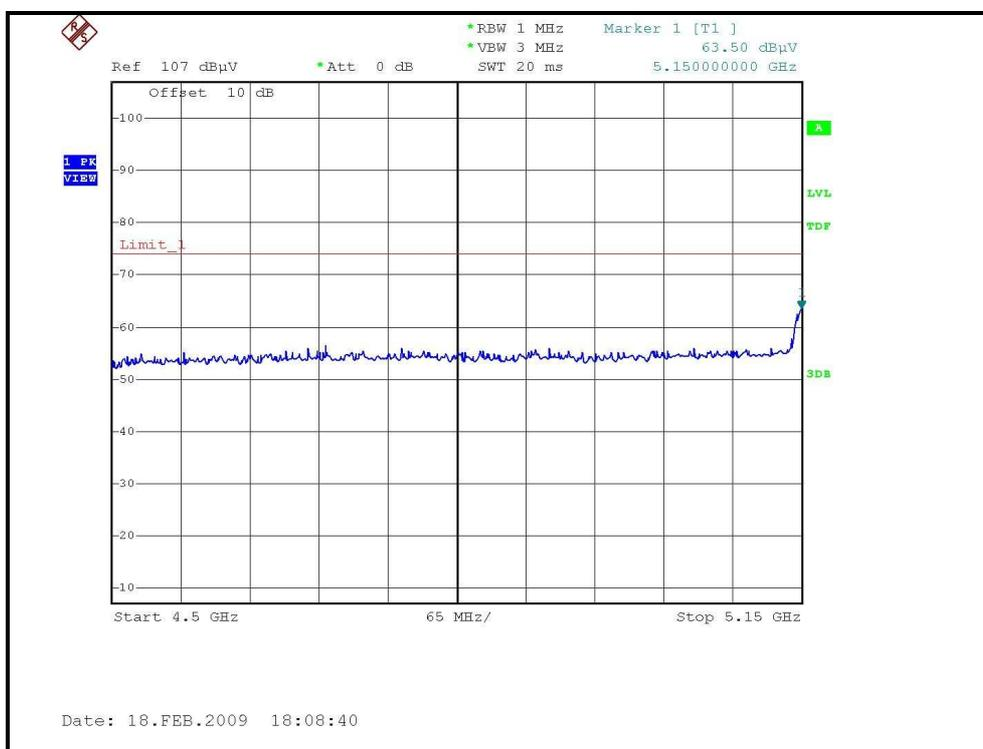



A D T

### RESTRICTED BANDEDGE (DRAFT 802.11n (40MHz) MODE, CH4, HORIZONTAL)

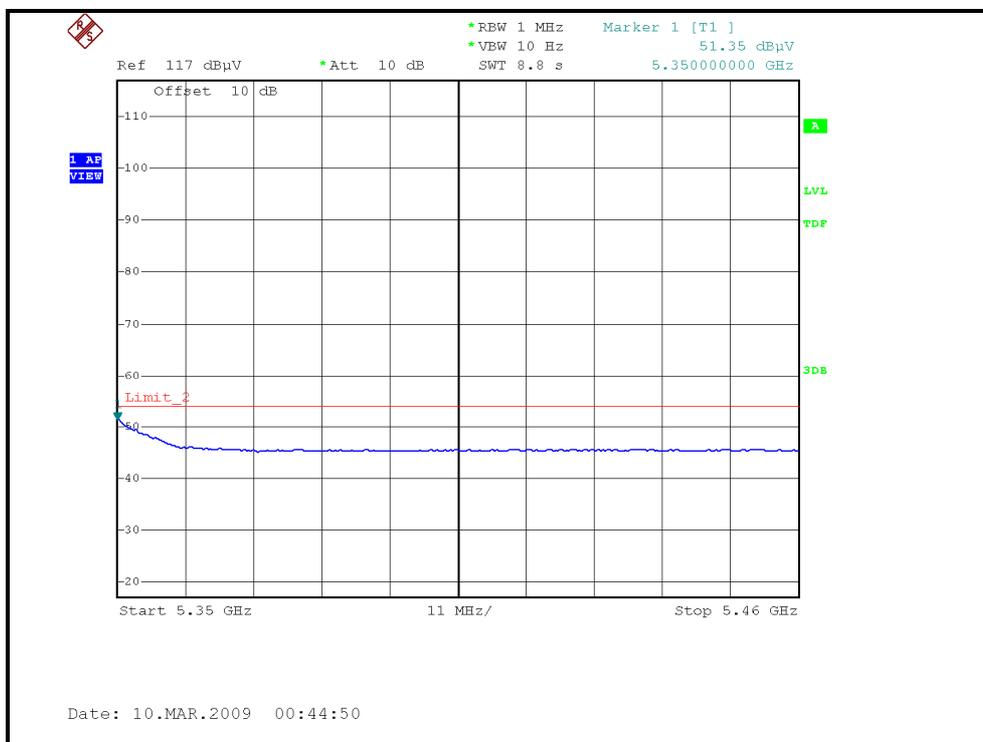
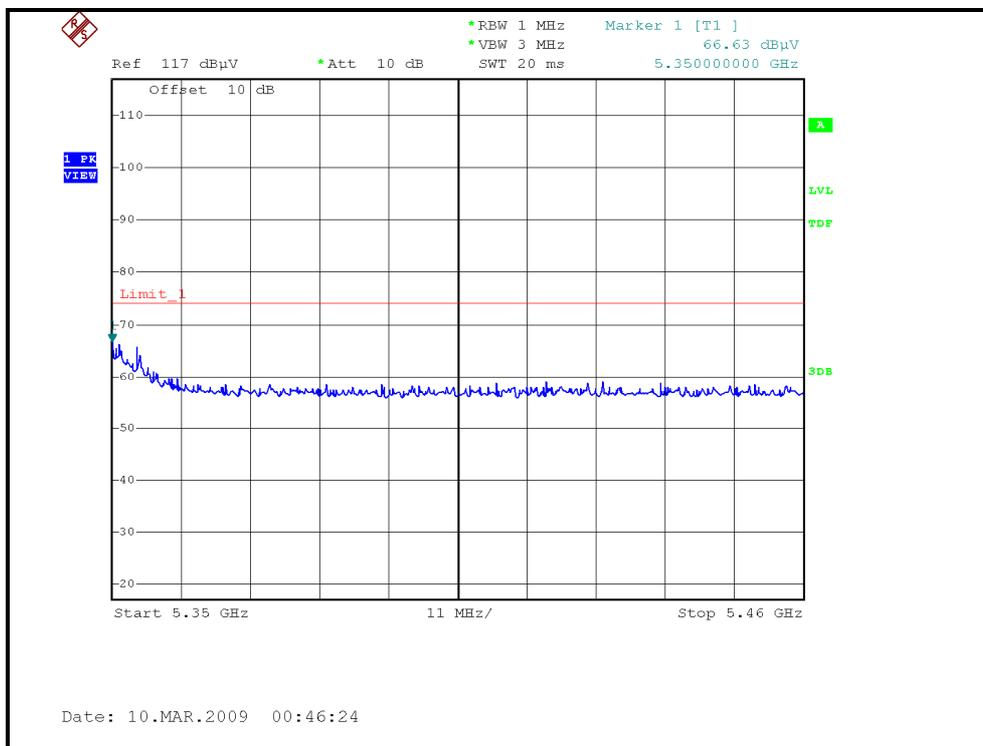



A D T

### RESTRICTED BANDEDGE (DRAFT 802.11n (40MHz) MODE, CH4, VERTICAL)

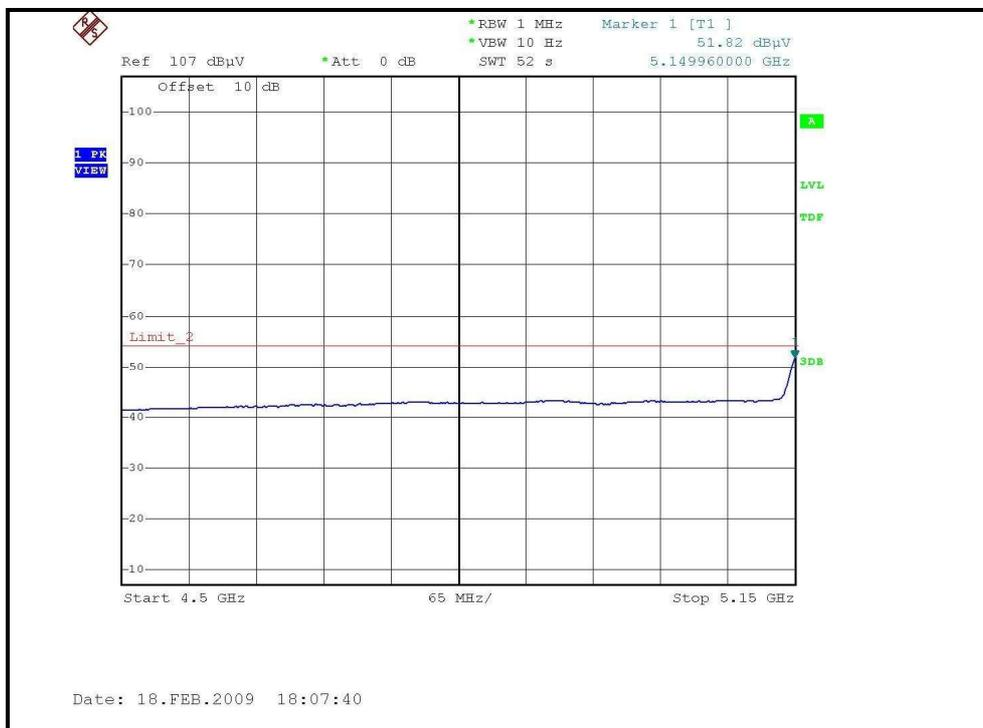
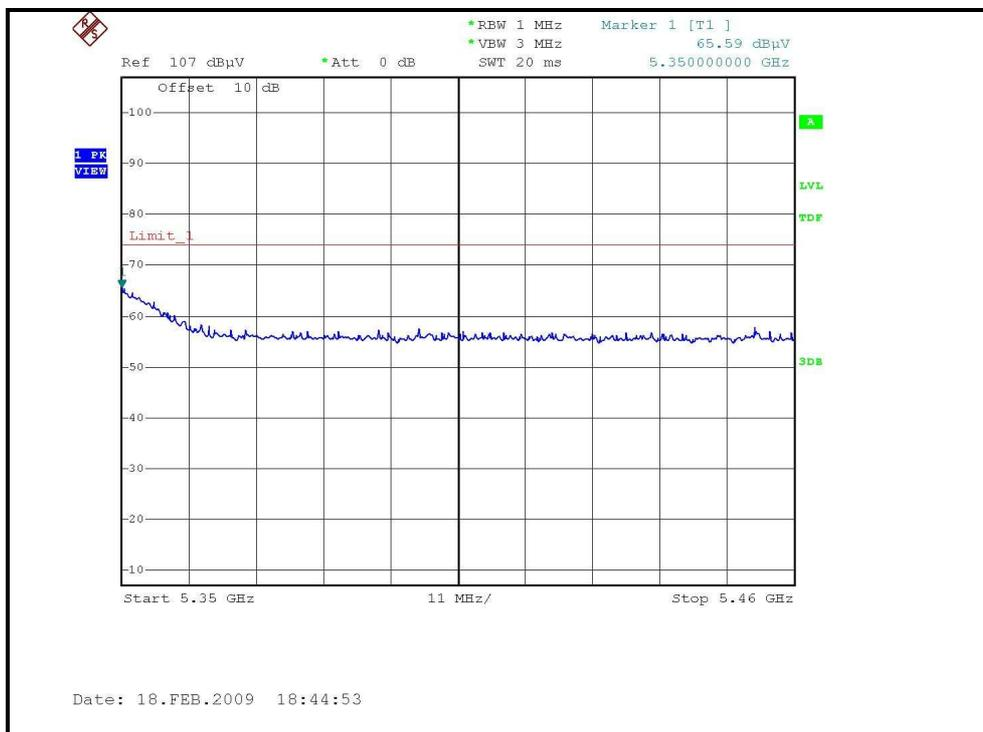



A D T

### RESTRICTED BANDEDGE (DRAFT 802.11n (40MHz) MODE, CH5, HORIZONTAL)

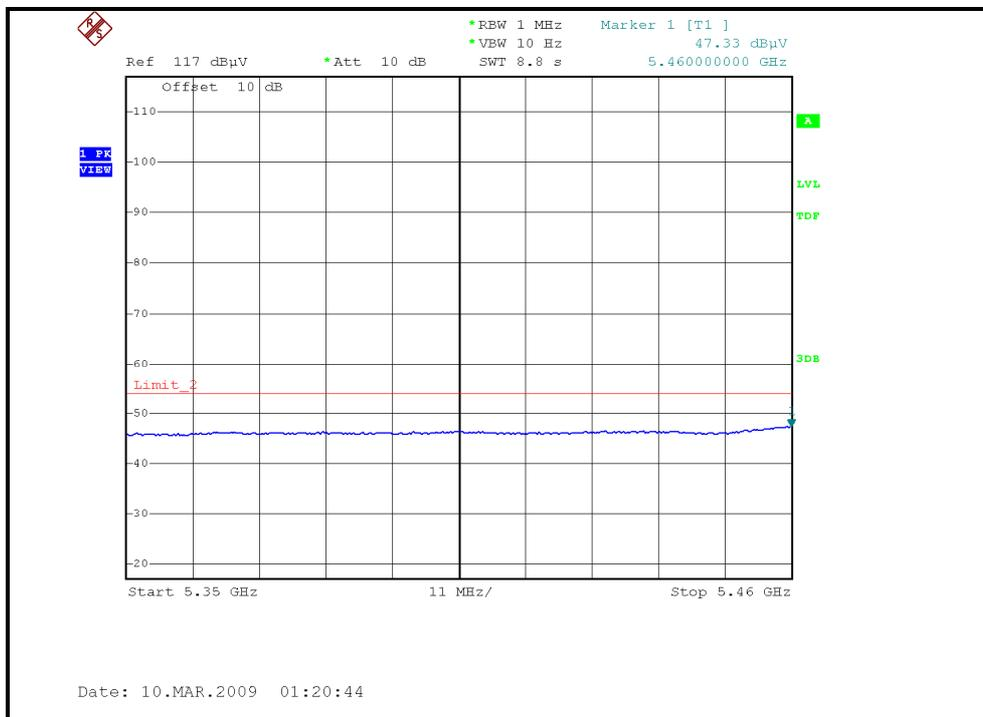
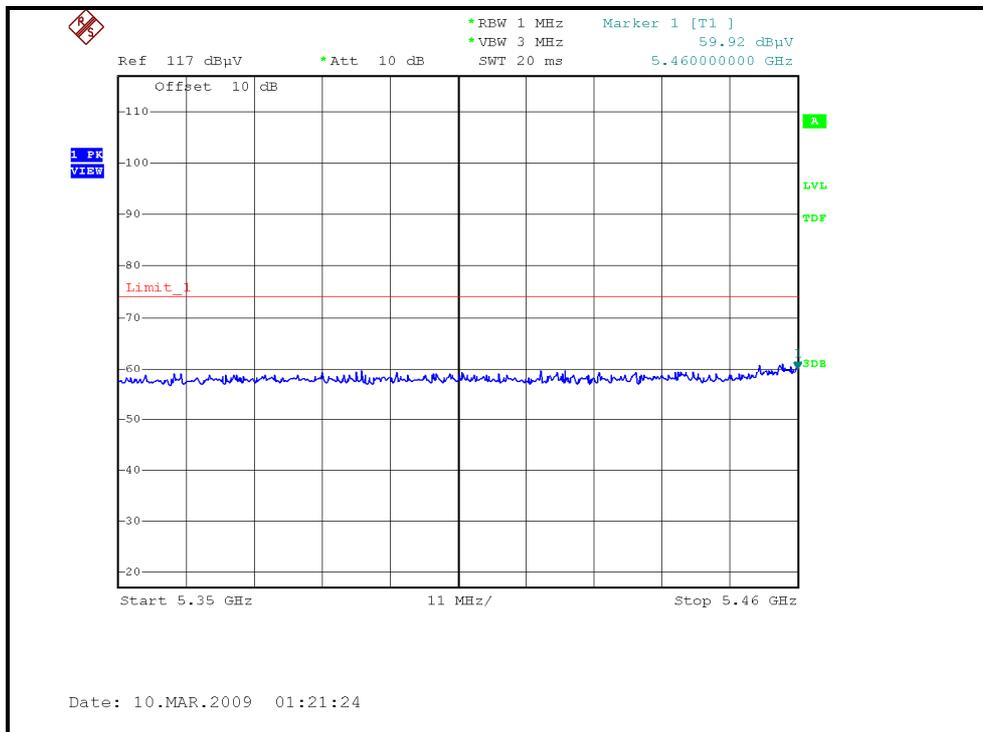



A D T

### RESTRICTED BANDEDGE (DRAFT 802.11n (40MHz) MODE, CH5, VERTICAL)

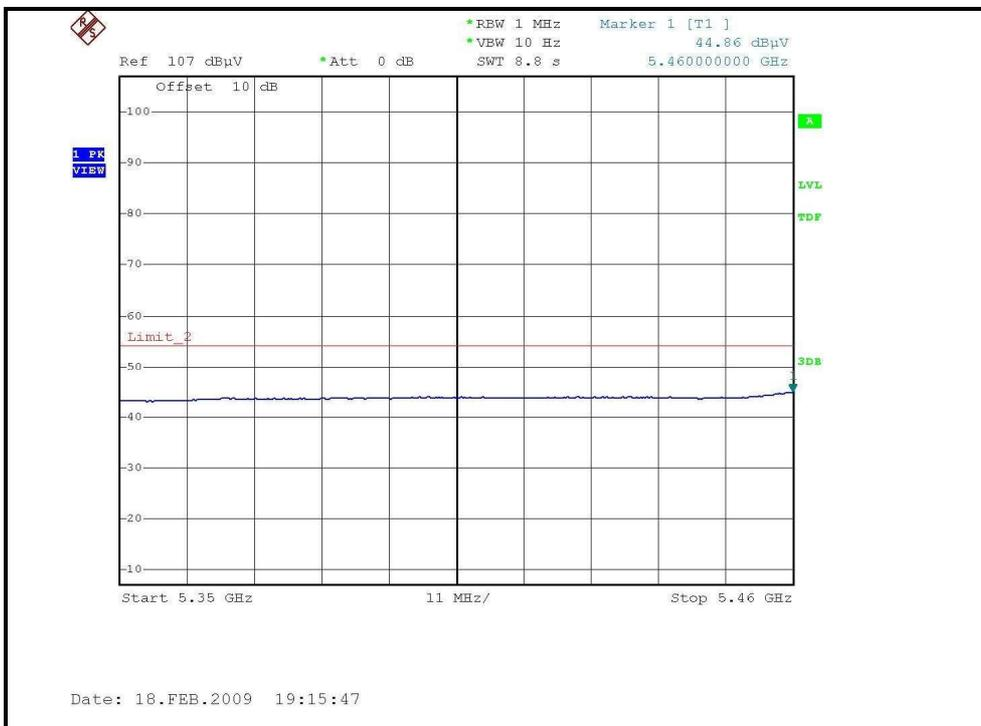
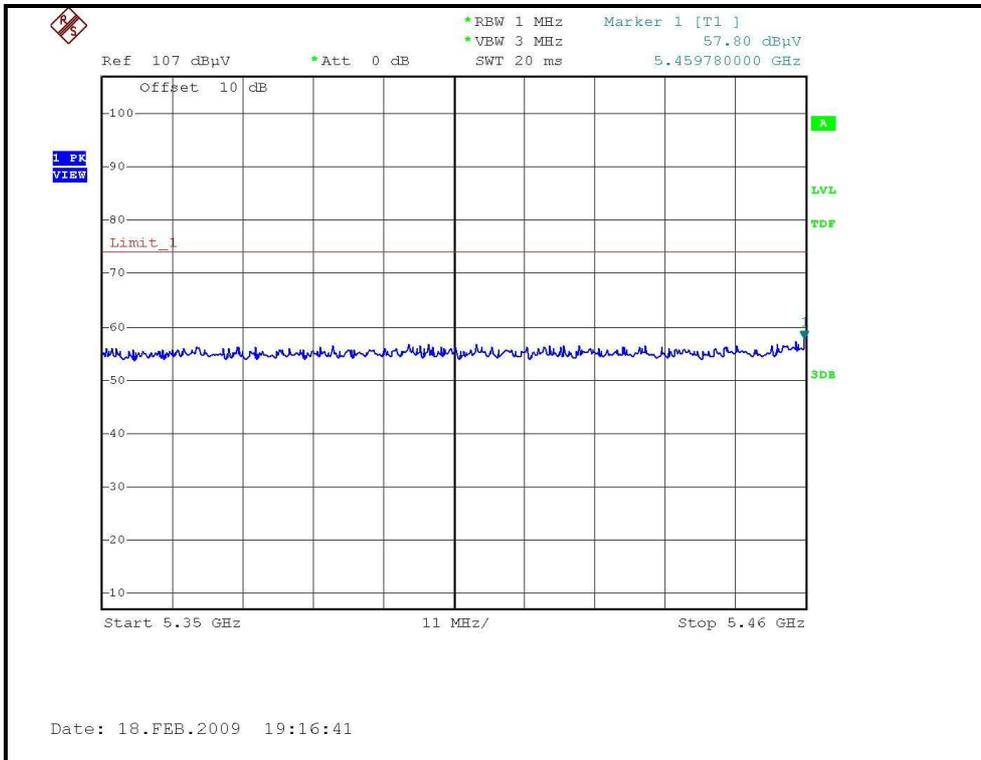





A D T

### 4.3 PEAK TRANSMIT POWER MEASUREMENT

#### 4.3.1 LIMITS OF PEAK TRANSMIT POWER MEASUREMENT

Frequency Band	Limit
5.15 – 5.25GHz	The lesser of 50mW (17dBm) or 4dBm + 10logB
5.25 – 5.35GHz	The lesser of 250mW (24dBm) or 11dBm + 10logB
5.47 – 5.725GHz	The lesser of 250mW (24dBm) or 11dBm + 10logB
5.725 – 5.825GHz	The lesser of 1W (30dBm) or 17dBm + 10logB

**NOTE:** Where B is the 26dB emission bandwidth in MHz.

#### 4.3.2 TEST INSTRUMENTS

DESCRIPTION & MANUFACTURER	MODEL NO.	SERIAL NO.	CALIBRATED DATE	CALIBRATED UNTIL
ADVANTEST SPECTRUM ANALYZER	U3772	160100280	July 26, 2008	July 25, 2009

**NOTE:**

The calibration interval of the above test instruments is 12 months and the calibrations are traceable to NML/ROC and NIST/USA.

### 4.3.3 TEST PROCEDURE

1. The transmitter output was connected to the spectrum analyzer.
2. Set span to encompass the entire emission bandwidth of the signal.
3. Set RBW to 1MHz, VBW to 300kHz.
4. Using the spectrum analyzer's channel power measurement function to measure the output power.

**NOTE:**

The test is performed in accordance with FCC Public Notice: APPENDIX A Guidelines for Assessing Unlicensed National Information Infrastructure (U-NII) Devices – Part 15, Subpart E, August 2002.

The transmitter output operates continuously therefore Method # 1 is used.

### 4.3.4 DEVIATION FROM TEST STANDARD

No deviation

### 4.3.5 TEST SETUP

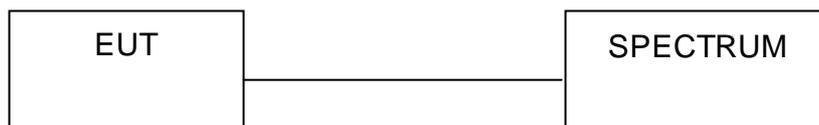

### 4.3.6 EUT OPERATING CONDITIONS

The software provided by client to enable the EUT under transmission condition continuously at specific channel frequencies individually.



A D T

### 4.3.7 TEST RESULTS

#### 802.11a OFDM MODULATION:

<b>MODULATION TYPE</b>	BPSK	<b>TRANSFER RATE</b>	6Mbps
<b>INPUT POWER</b>	120Vac, 60 Hz	<b>ENVIRONMENTAL CONDITIONS</b>	25deg.C, 60%RH, 965hPa
<b>TESTED BY</b>	Wen Yu		

CHANNEL	CHANNEL FREQUENCY (MHz)	PEAK POWER OUTPUT (dBm)	PEAK POWER OUTPUT (mW)	PEAK POWER LIMIT (dBm)	26dBc Occupied Bandwidth (MHz)	PASS/FAIL
1	5180	14.22	26.424	17	23.07	PASS
2	5200	14.02	25.235	17	23.17	PASS
4	5240	14.27	26.730	17	23.10	PASS
5	5260	15.92	39.084	24	23.00	PASS
7	5300	15.52	35.645	24	23.03	PASS
8	5320	15.76	37.670	24	23.38	PASS
9	5500	15.81	38.107	24	22.82	PASS
14	5600	15.71	37.239	24	23.34	PASS
19	5700	16.15	41.210	24	24.36	PASS
20	5745	15.56	35.975	30	23.41	PASS
22	5785	15.87	38.637	30	23.59	PASS
23	5805	15.91	38.994	30	23.34	PASS

**NOTE:** The 26dBc Occupied Bandwidth plot, please refer to the following pages.



A D T

### Peak Power Output: CH1



### CH2

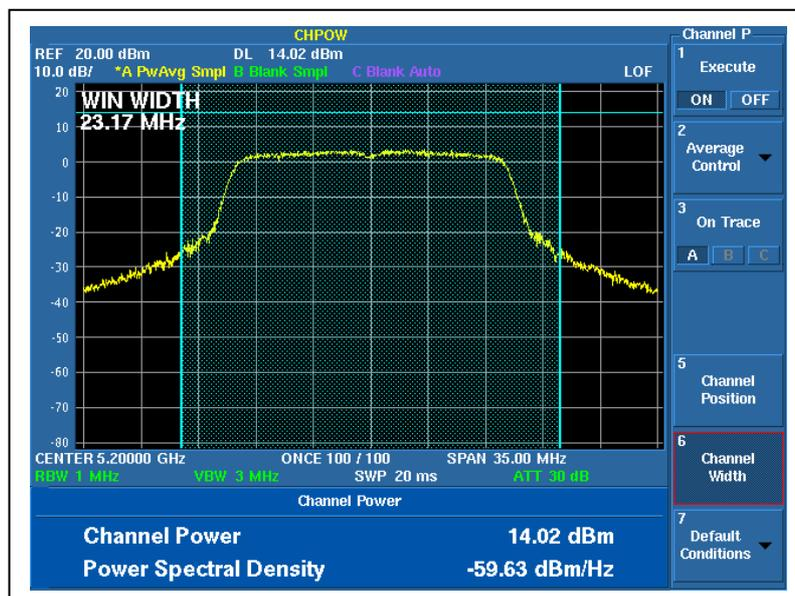



### CH4

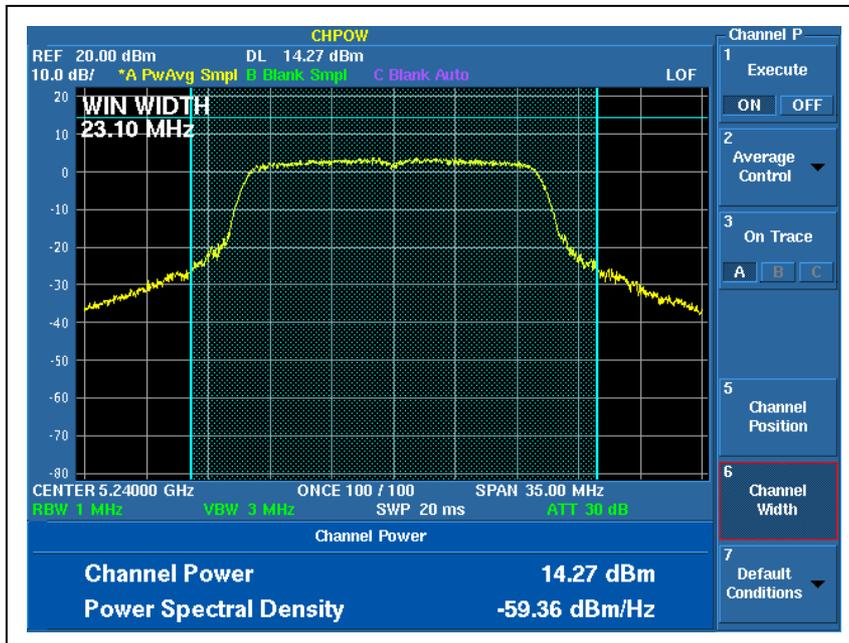

### CH5

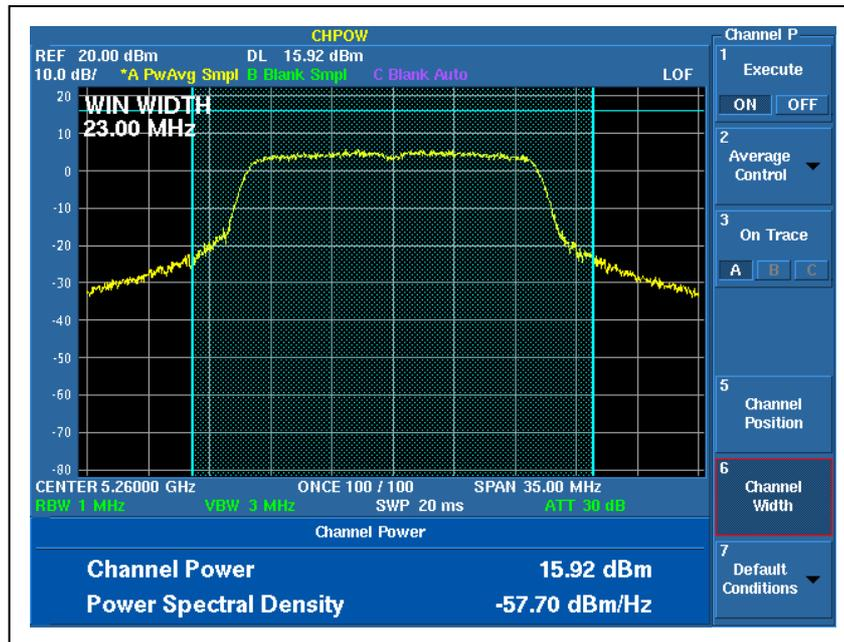



### CH7

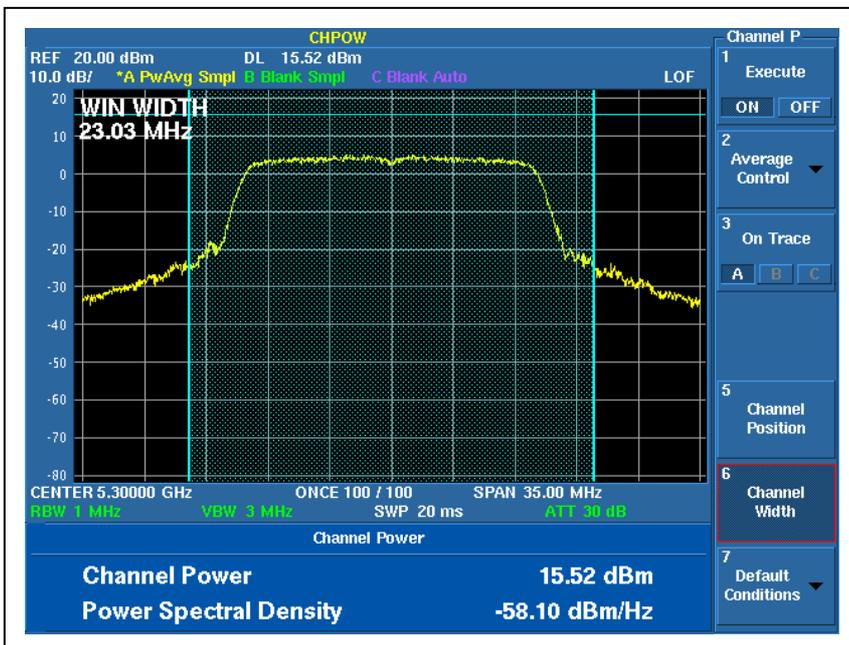

### CH8

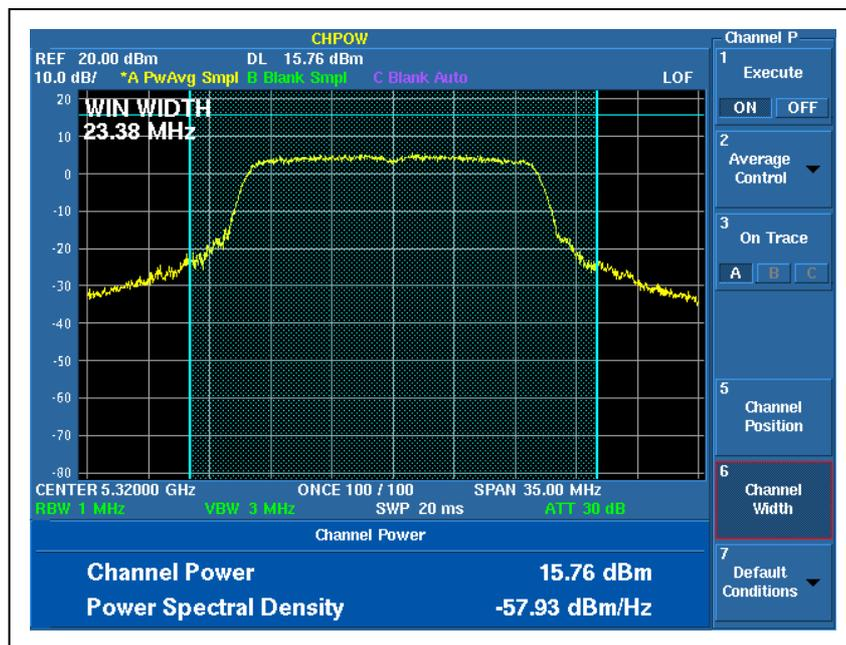



### CH9

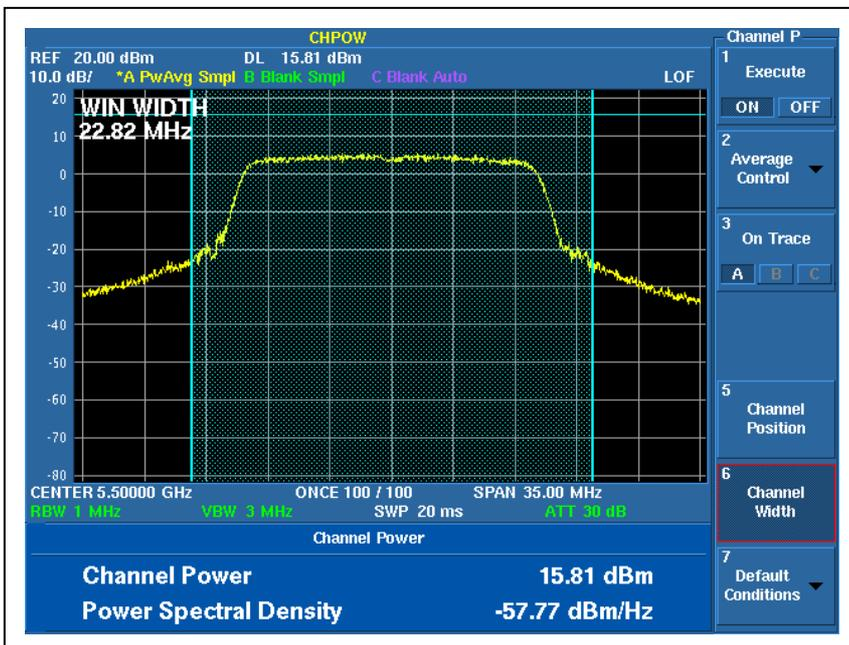

### CH14

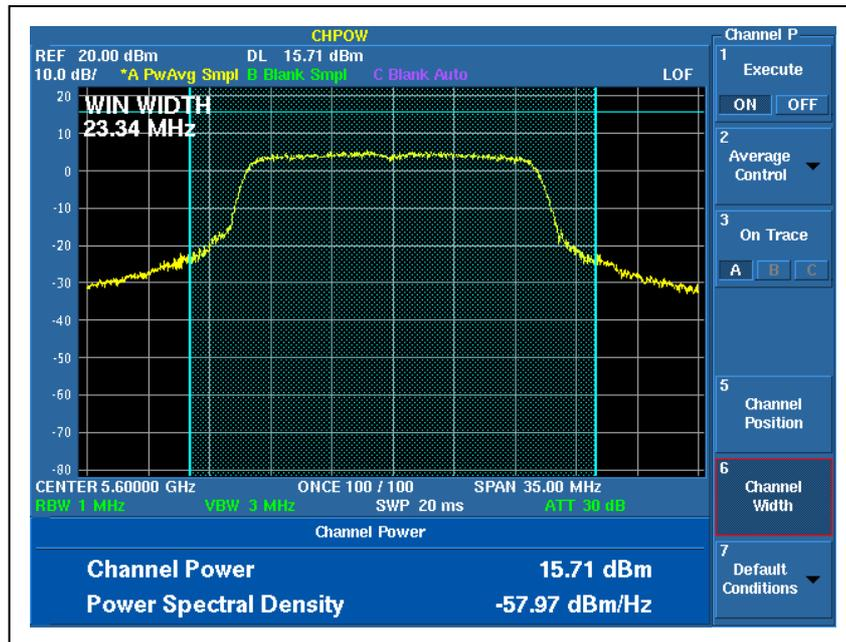



A D T

### CH19

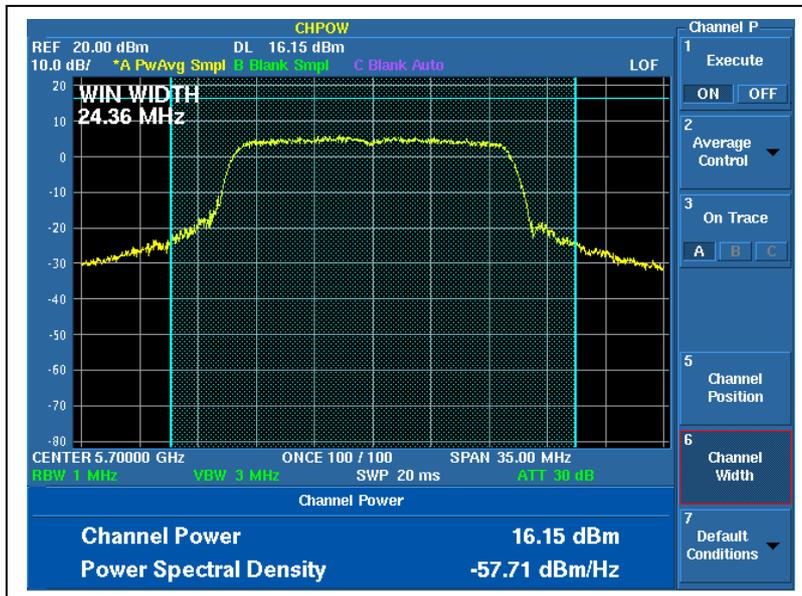

### CH20

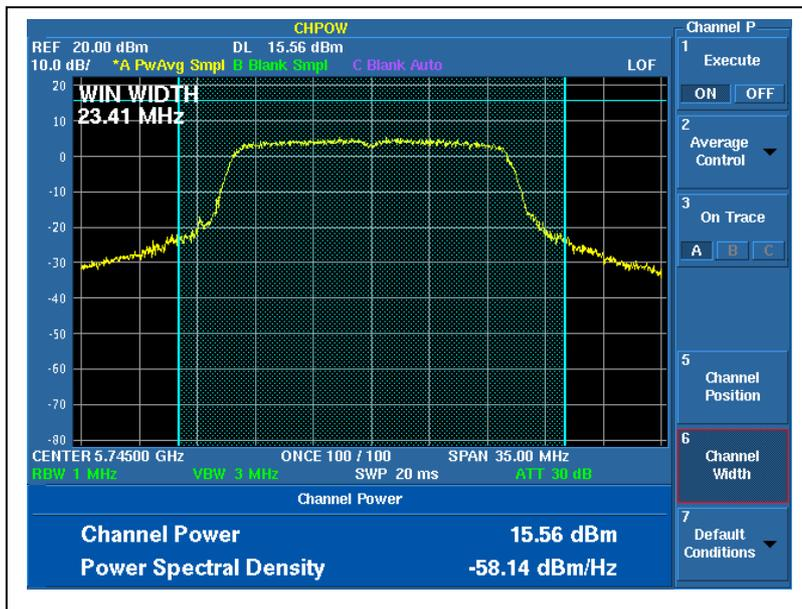





A D T

### CH22

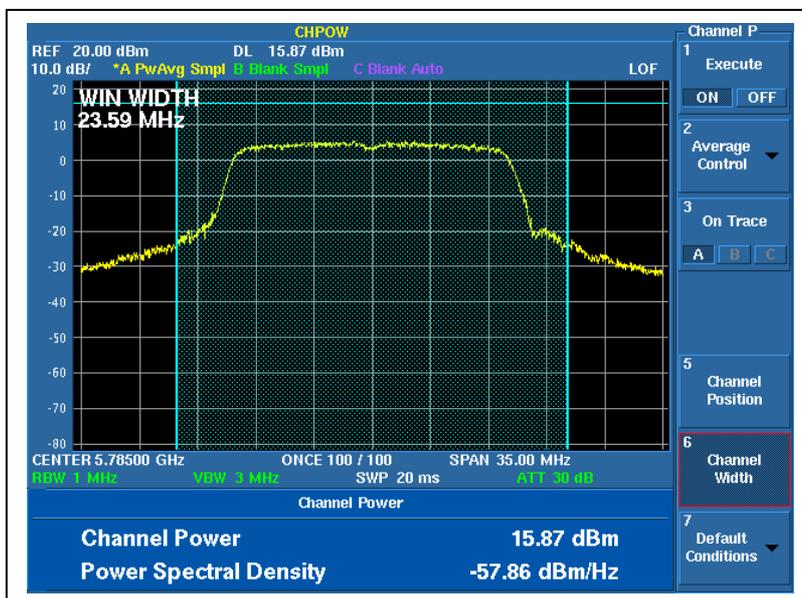

### CH23

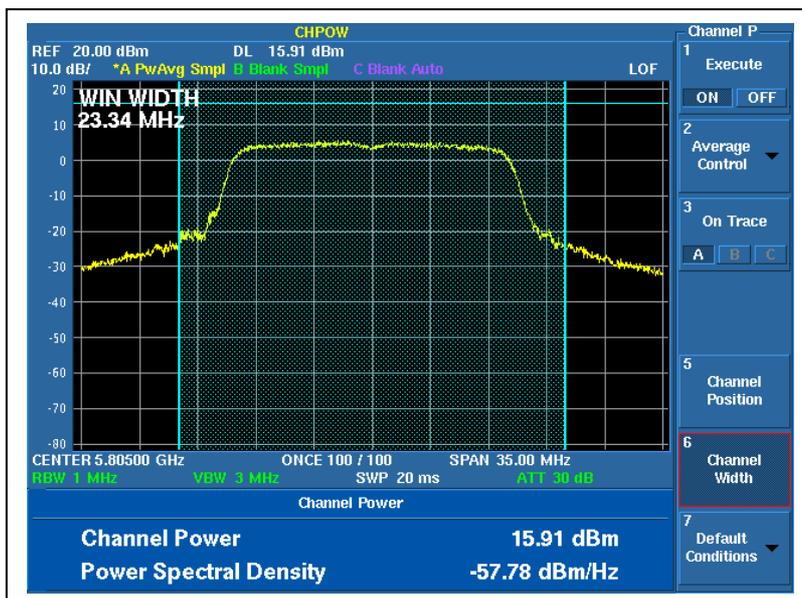



### 26dB Occupied Bandwidth: CH1

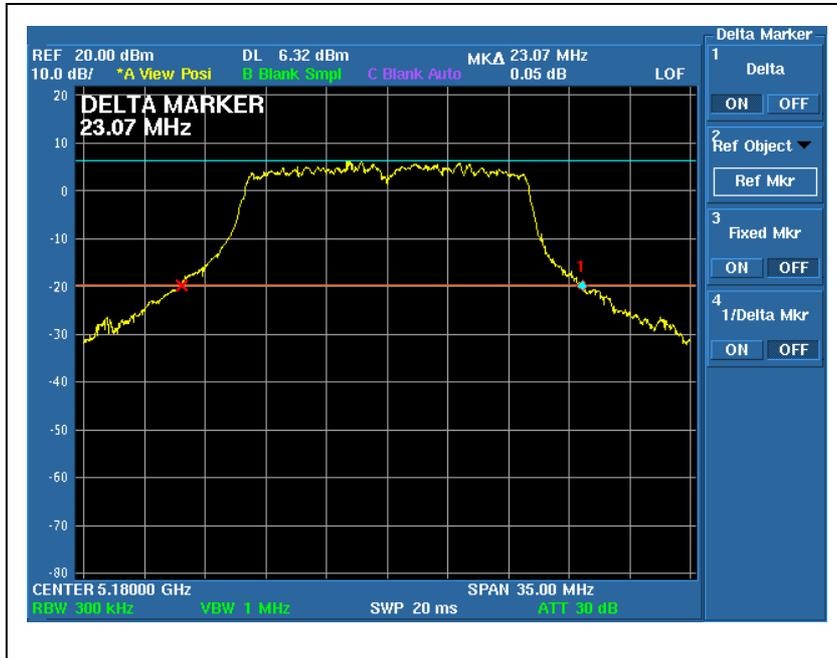

### CH2

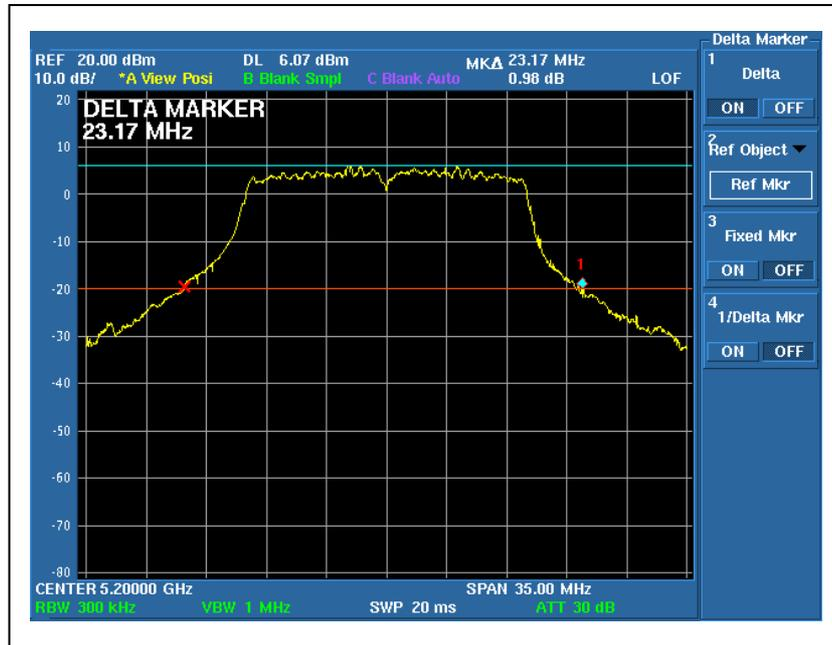



### CH4

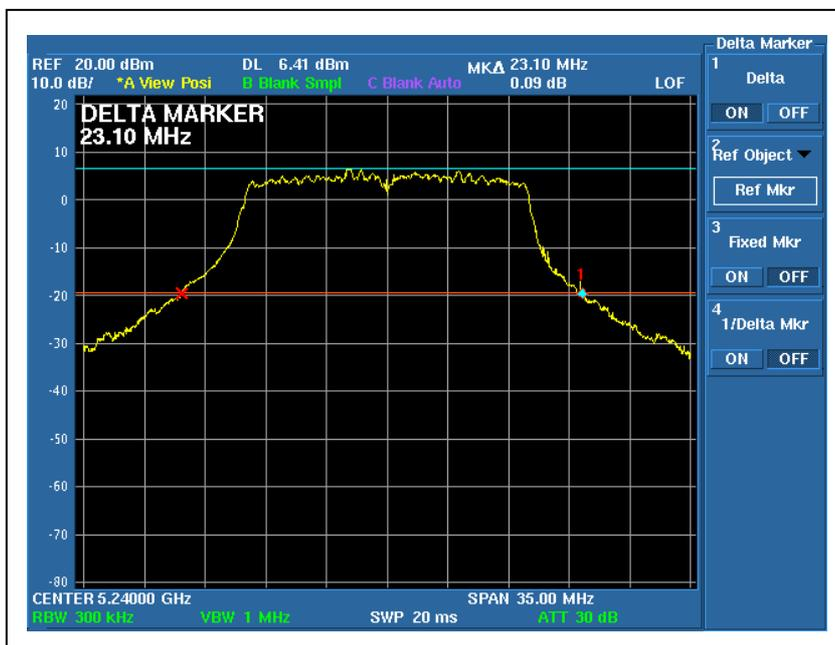

### CH5

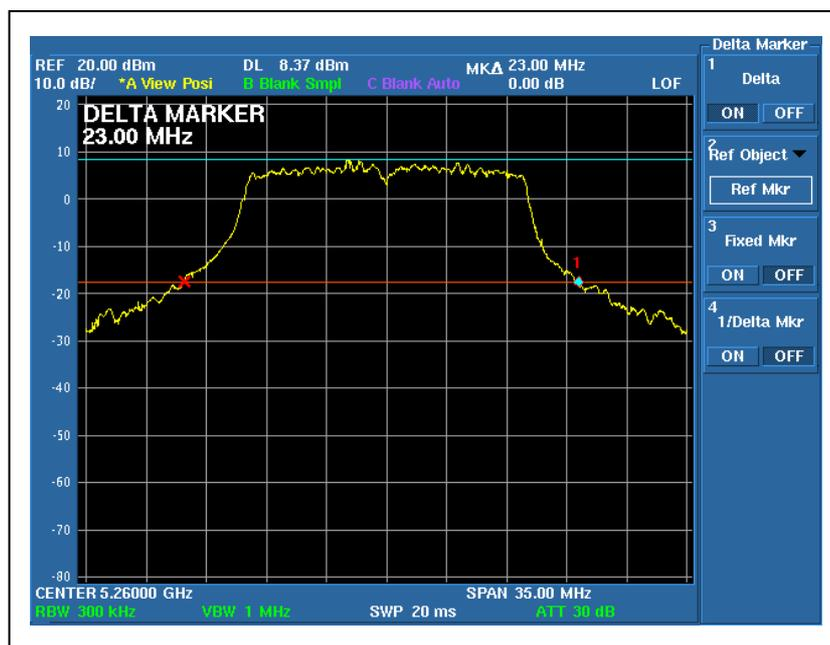



### CH7

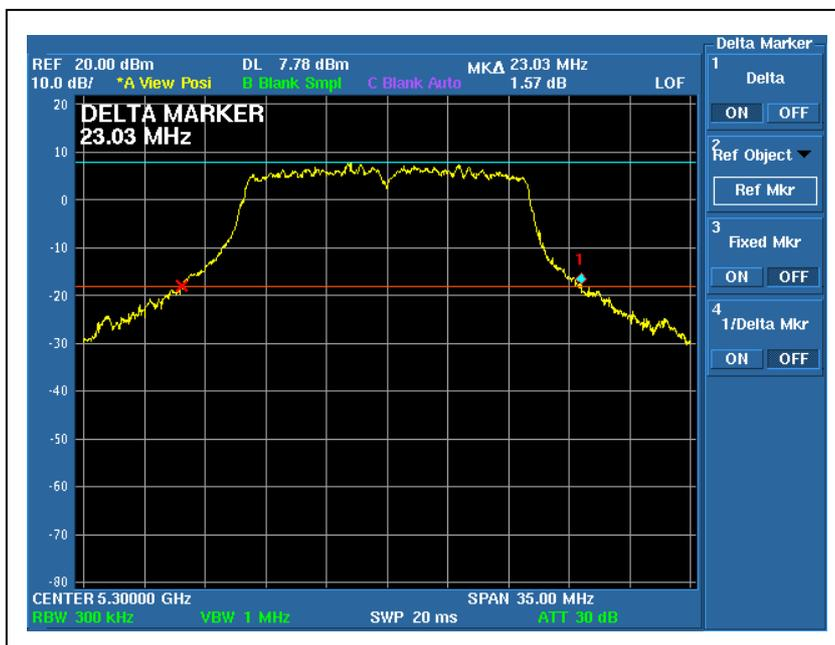

### CH8

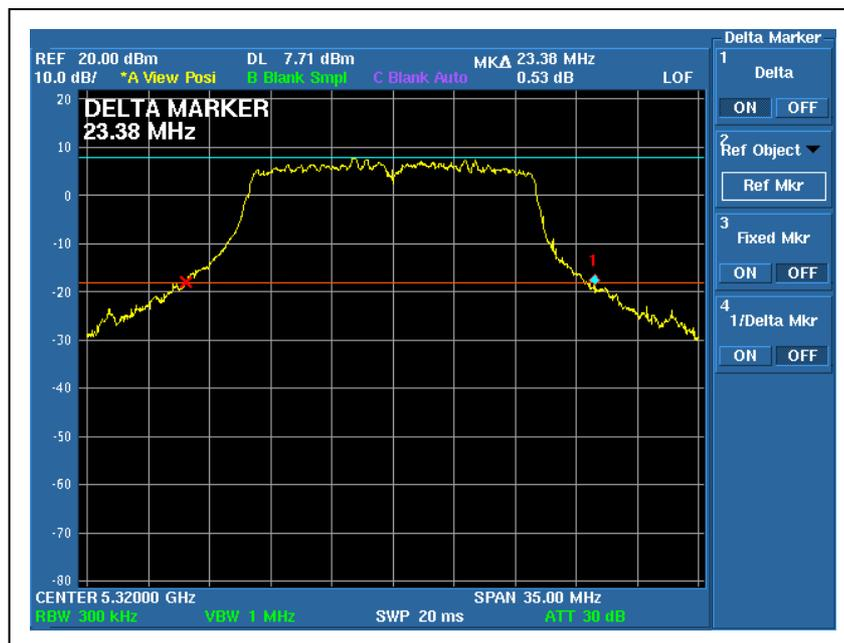



### CH9

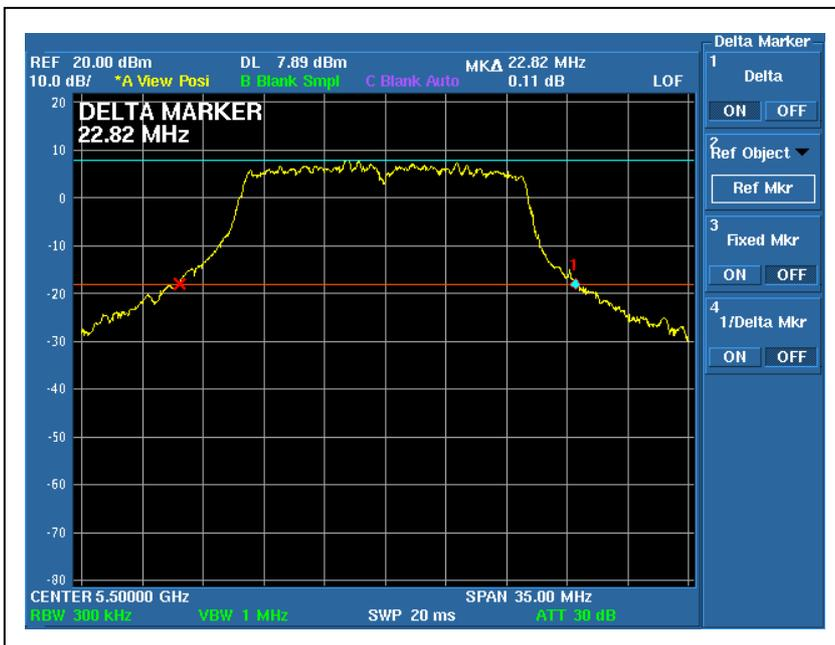

### CH14

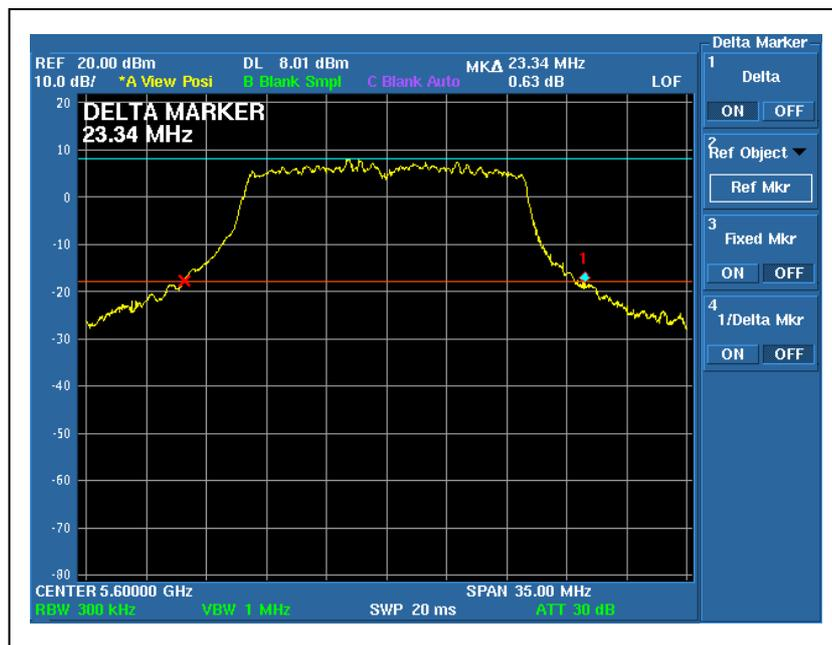



### CH19

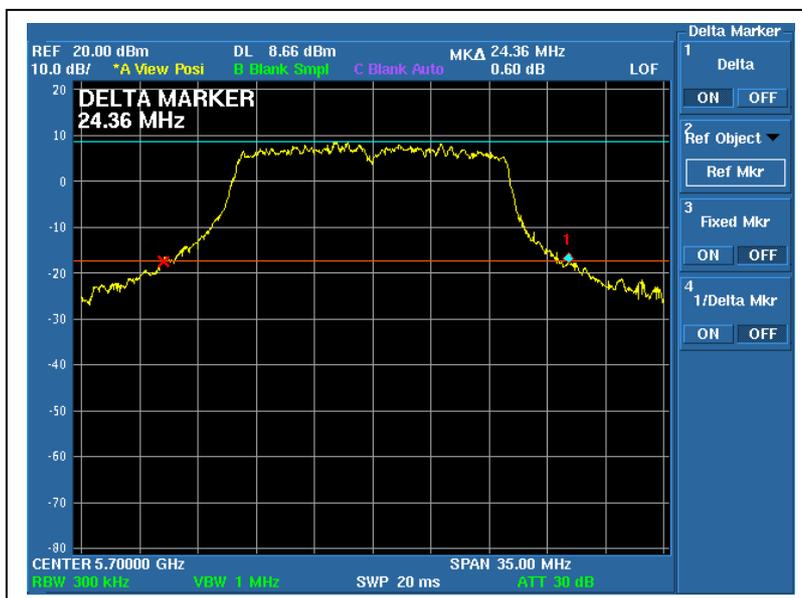

### CH20

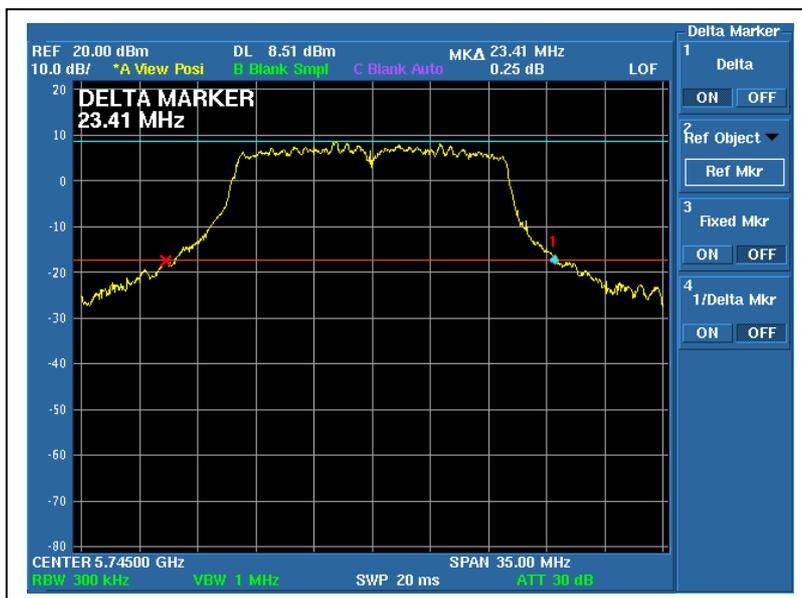



### CH22

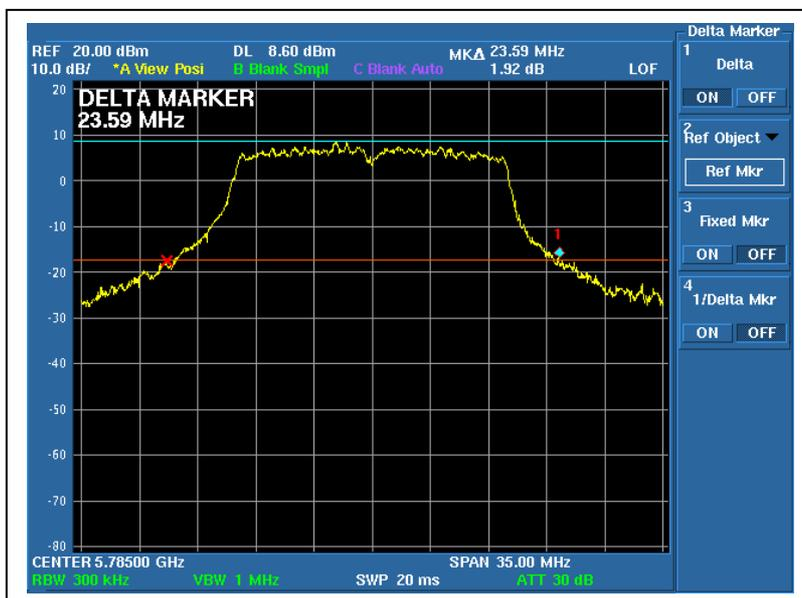

### CH23

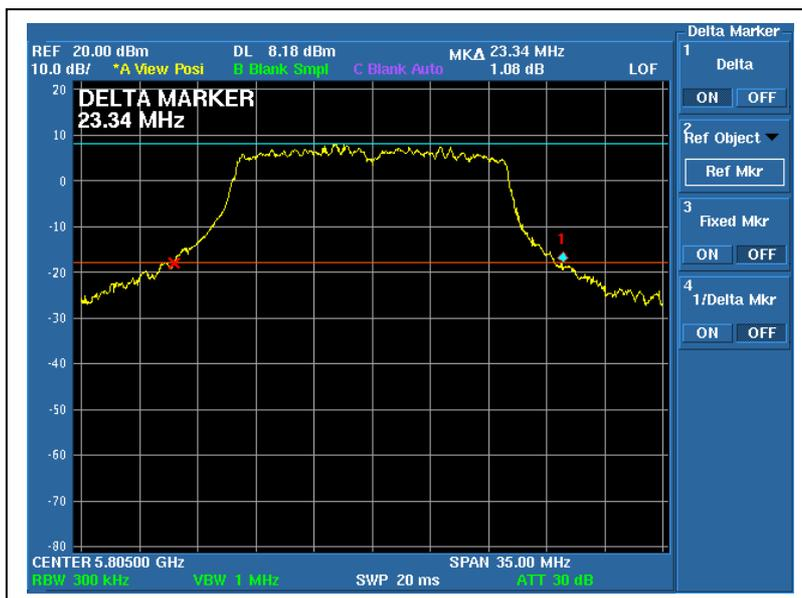



A D T

**DRAFT 802.11n (20MHz) OFDM modulation:**

<b>MODULATION TYPE</b>	BPSK	<b>TRANSFER RATE</b>	13Mbps
<b>INPUT POWER</b>	120Vac, 60 Hz	<b>ENVIRONMENTAL CONDITIONS</b>	25deg.C, 60%RH, 965hPa
<b>TESTED BY</b>	Wen Yu		

CHANNEL	CHANNEL FREQUENCY (MHz)	PEAK POWER OUTPUT (dBm)		PEAK POWER OUTPUT (mW)		TOTAL PEAK POWER (dBm)	TOTAL PEAK POWER (mW)	PEAK POWER LIMIT (dBm)	26dBc Occupied Bandwidth (MHz)		PASS/ FAIL
		Chain 0	Chain 1	Chain 0	Chain 1				Chain 0	Chain 1	
1	5180	10.52	12.11	11.272	16.255	14.40	27.527	17.00	22.30	23.87	PASS
2	5200	10.76	12.22	11.912	16.672	14.56	28.584	17.00	22.43	23.94	PASS
4	5240	10.44	12.13	11.066	16.331	14.38	27.397	17.00	22.23	24.08	PASS
5	5260	14.35	16.09	27.227	40.644	18.32	67.871	24.00	22.12	24.64	PASS
7	5300	14.23	16.13	26.485	41.020	18.29	67.505	24.00	22.36	24.85	PASS
8	5320	14.08	15.98	25.586	39.628	18.14	65.214	24.00	22.40	25.13	PASS
9	5500	15.64	14.69	36.644	29.444	18.20	66.088	24.00	23.03	24.50	PASS
14	5600	15.48	14.29	35.318	26.853	17.94	62.171	24.00	22.86	24.75	PASS
19	5700	14.10	13.55	25.704	22.646	16.84	48.350	24.00	22.05	23.94	PASS
20	5745	15.46	14.53	35.156	28.379	18.03	63.535	30.00	22.79	24.57	PASS
22	5785	15.34	14.29	34.198	26.853	17.86	61.051	30.00	22.68	24.64	PASS
23	5805	15.15	14.42	32.734	27.669	17.81	60.403	30.00	22.82	23.98	PASS

**NOTE:** The 26dBc Occupied Bandwidth plot, please refer to the following pages.





A D T

Peak Power Output:  
For Chain (0) :CH1

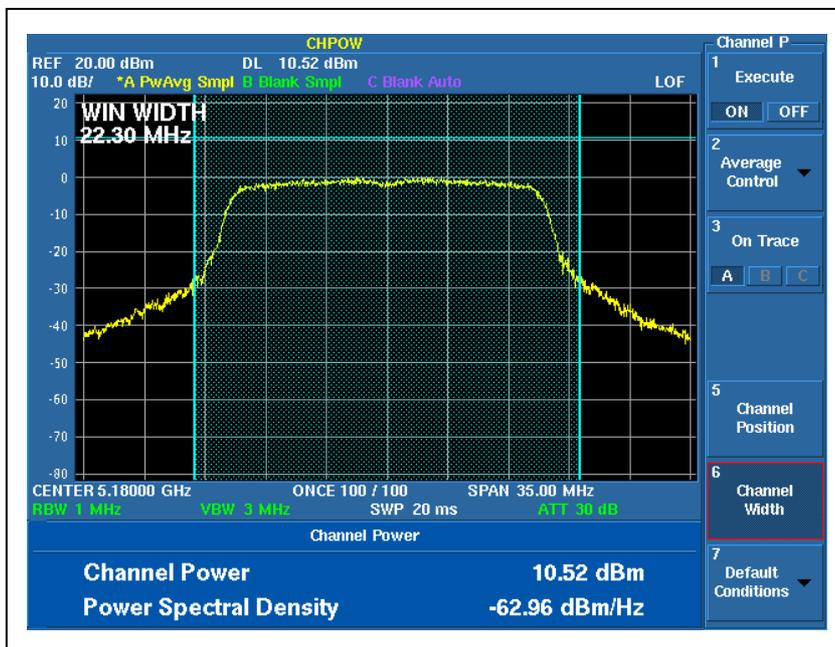

CH2

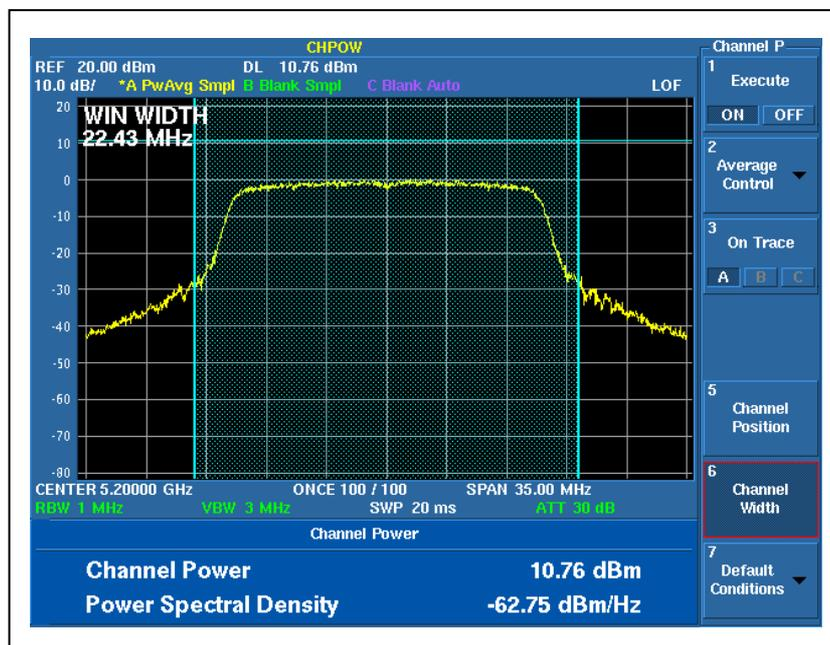



### CH4

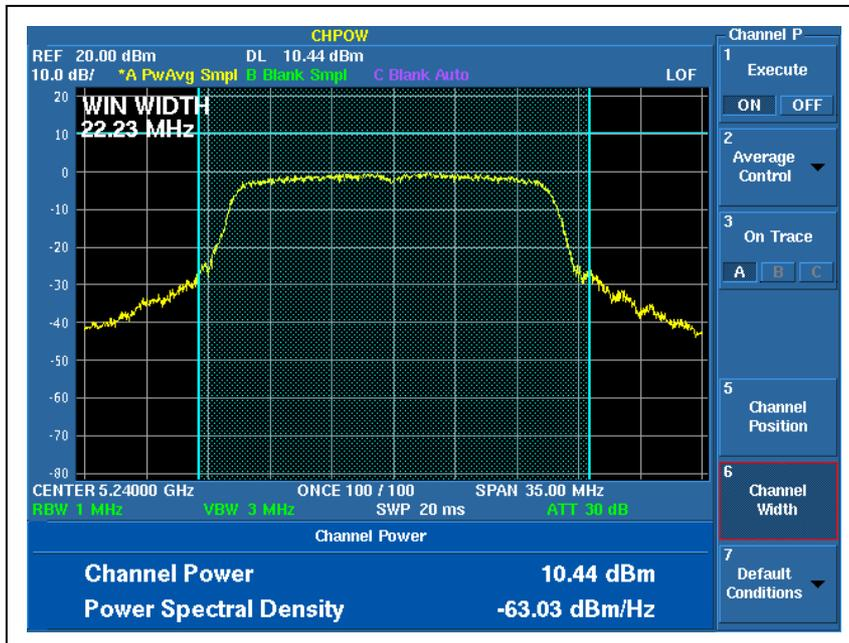

### CH5

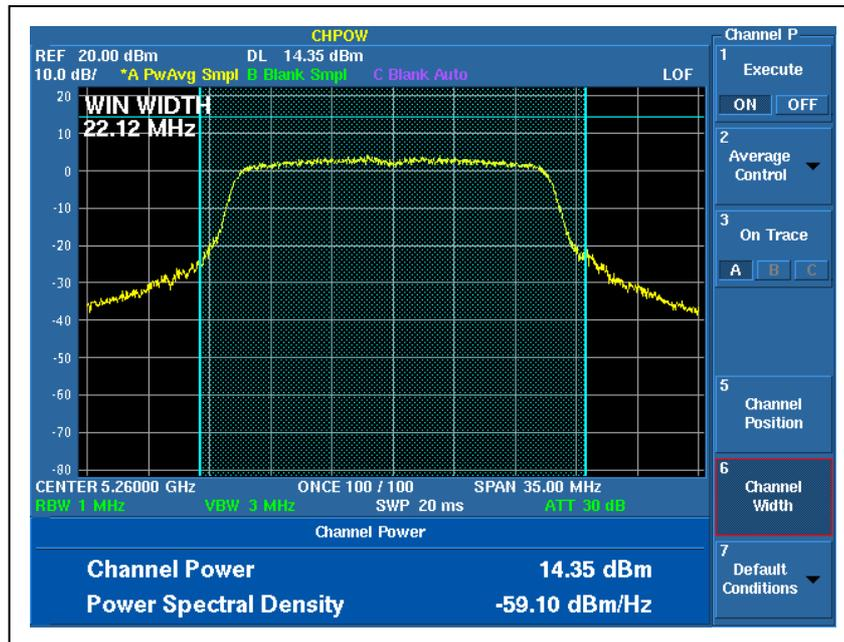



CH7

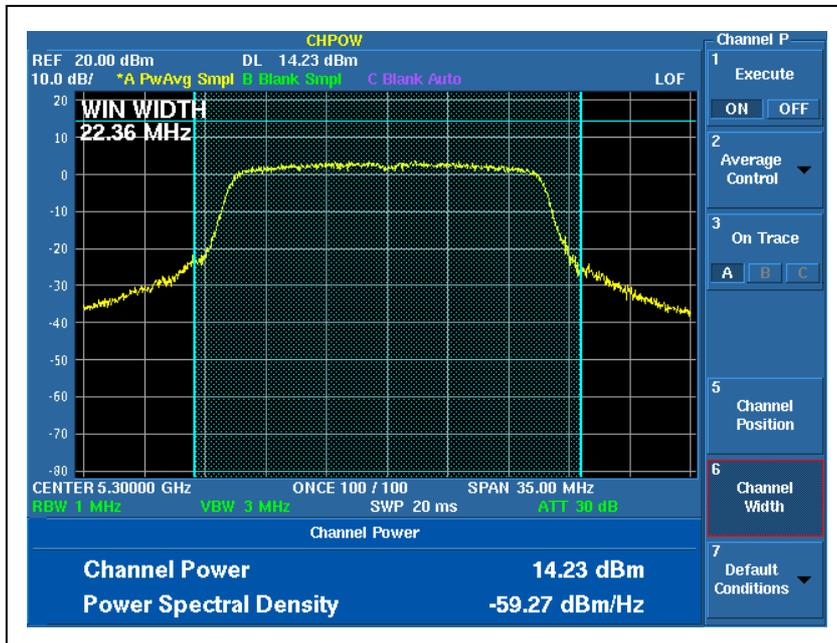

CH8

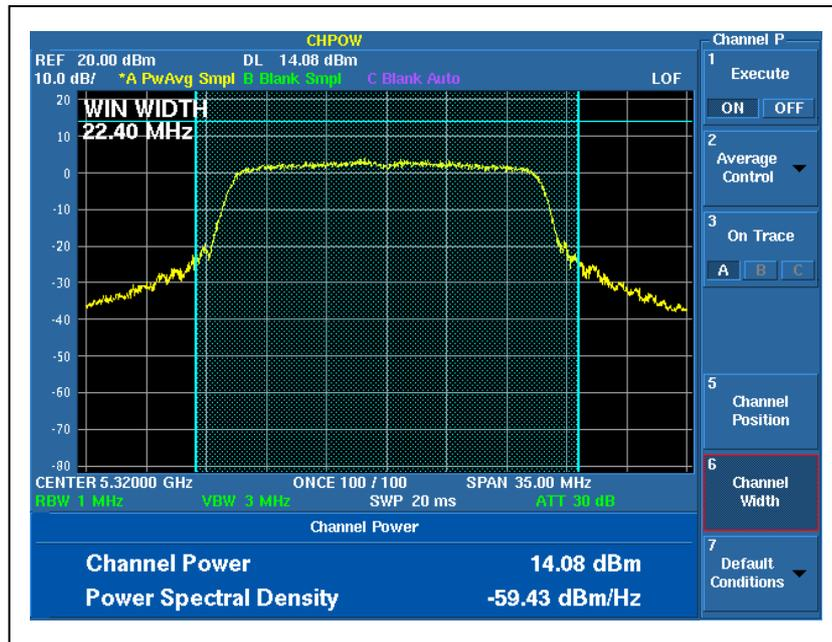



### CH9

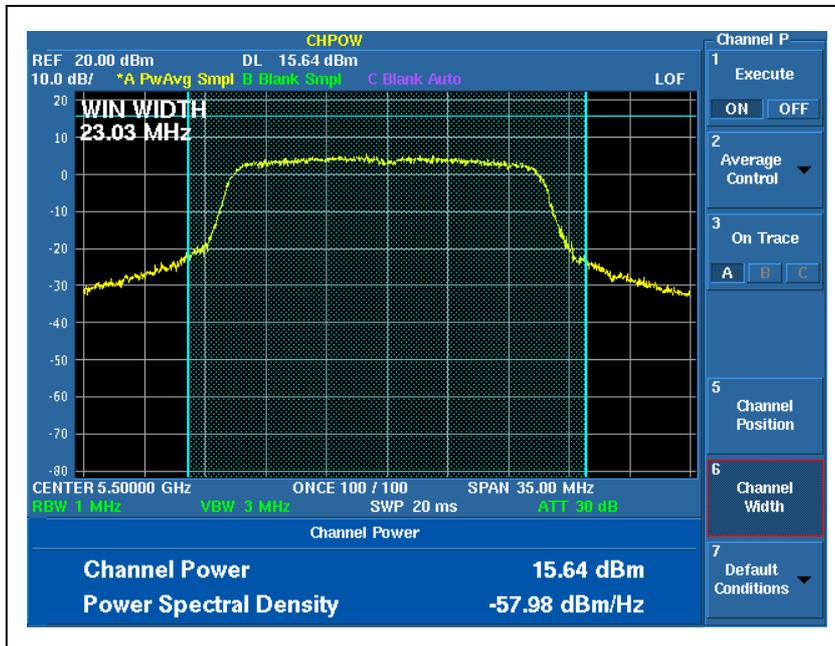

### CH14

