



# SPORTON International Inc.

No. 52, Hwa Ya 1st Rd., Kwei-Shan Hsiang, TaoYuan Hsien, Taiwan, R.O.C.  
Ph: 886-3-327-3456 / FAX: 886-3-327-0973 / www.sporton.com.tw

## FCC RADIO TEST REPORT

Applicant's company	D-link Corporation
Applicant Address	No.289, Sinhu 3rd Rd., Neihu District, Taipei City 114, Taiwan, R.O.C.
FCC ID	KA2WA142A1
Manufacturer's company	Cameo Communications, Inc.
Manufacturer Address	No.42 Sec. 6, Mincyuan E. Rd., Neihu District, Taipei City 114, Taiwan

Product Name	RangeBooster N™ USB Adapter
Brand Name	D-Link
Model Name	DWA-142
Test Rule	47 CFR FCC Part 15 Subpart C § 15.247
Test Freq. Range	2400 ~ 2483.5MHz
Receive Date	Aug. 2, 2006
Final Test Date	Sep. 3, 2006
Submission Type	Original Equipment



### Statement

**Test result included is only for the 802.11b/g part of the product.**

The test result in this report refers exclusively to the presented test model / sample.

Without written approval of SPORTON International Inc., the test report shall not be reproduced except in full.

The measurements and test results shown in this test report were made in accordance with the procedures

and found in compliance with the limit given in **ANSI C63.4-2003** and **47 CFR FCC Part 15 Subpart C**.

The test equipment used to perform the test is calibrated and traceable to NML/ROC.

NVLAQ®

Lab Code: 200079-0



## Table of Contents

<b>1. CERTIFICATE OF COMPLIANCE .....</b>	<b>1</b>
<b>2. SUMMARY OF THE TEST RESULT .....</b>	<b>2</b>
<b>3. GENERAL INFORMATION .....</b>	<b>3</b>
3.1. Product Details.....	3
3.2. Accessories.....	3
3.3. Table for Filed Antenna.....	4
3.4. Table for Carrier Frequencies .....	4
3.5. Table for Test Modes .....	4
3.6. Table for Testing Locations.....	5
3.7. Table for Supporting Units .....	5
3.8. Table for Parameters of Test Software Setting .....	6
3.9. Test Configurations .....	8
<b>4. TEST RESULT .....</b>	<b>11</b>
4.1. AC Power Line Conducted Emissions Measurement.....	11
4.2. Maximum Peak Output Power Measurement .....	15
4.3. Power Spectral Density Measurement .....	18
4.4. 6dB Spectrum Bandwidth Measurement .....	34
4.5. Radiated Emissions Measurement .....	50
4.6. Band Edge Emissions Measurement .....	110
4.7. Antenna Requirements .....	135
<b>5. LIST OF MEASURING EQUIPMENTS .....</b>	<b>136</b>
<b>6. SPORTON COMPANY PROFILE .....</b>	<b>138</b>
6.1. Test Location.....	138
<b>7. NVLAP CERTIFICATE OF ACCREDITATION .....</b>	<b>139</b>
<b>APPENDIX A. PHOTOGRAPHS OF EUT.....</b>	<b>A1 ~ A7</b>
<b>APPENDIX B. TEST PHOTOS.....</b>	<b>B1 ~ B6</b>
<b>APPENDIX C. MAXIMUM PERMISSIBLE EXPOSURE.....</b>	<b>C1 ~C4</b>



## History of This Test Report

Original Issue Date: Sep. 5 ,2006

Report No.: FR682815-01AB

No additional attachment.

Additional attachment were issued as following record:

Attachment No.	Issue Date	Description



## 1. CERTIFICATE OF COMPLIANCE

Product Name : RangeBooster N™ USB Adapter  
Brand Name : D-Link  
Model Name : DWA-142  
Applicant : D-link Corporation  
Test Rule Part(s) : 47 CFR FCC Part 15 Subpart C § 15.247

Sporton International as requested by the applicant to evaluate the EMC performance of the product sample received on Aug. 2, 2006 would like to declare that the tested sample has been evaluated and found to be in compliance with the tested rule parts. The data recorded as well as the test configuration specified is true and accurate for showing the sample's EMC nature.

Sharon Jang 5.9.06

Prepared By:

Sharon Jang / Specialist

Steven Lu 5.9.06

Tested By:

Steven Lu / Engineer

Wayne Hsu 5.9.06

Reviewed By:

Wayne Hsu

## 2. SUMMARY OF THE TEST RESULT

Applied Standard: 47 CFR FCC Part 15 Subpart C				
Part	Rule Section	Description of Test	Result	Under Limit
4.1	15.207	AC Power Line Conducted Emissions	Complies	17.46 dB
4.2	15.247(b)(3)	Maximum Peak Conducted Output Power	Complies	5.81 dB
4.3	15.247(e)	Power Spectral Density	Complies	0.8 dB
4.4	15.247(a)(2)	6dB Spectrum Bandwidth	Complies	-
4.5	15.247(d)	Radiated Emissions	Complies	0.35 dB
4.6	15.247(d)	Band Edge Emissions	Complies	0.14 dB
4.7	15.203	Antenna Requirements	Complies	-

Test Items	Uncertainty	Remark
AC Power Line Conducted Emissions	$\pm 2.26$ dB	Confidence levels of 95%
Maximum Peak Conducted Output Power	$\pm 0.5$ dB	Confidence levels of 95%
Power Spectral Density	$\pm 0.71$ dB	Confidence levels of 95%
6dB Spectrum Bandwidth	$\pm 6.25 \times 10^{-7}$	Confidence levels of 95%
Radiated Emissions/ Band Edge Emissions	$\pm 3.72$ dB	Confidence levels of 95%

### 3. GENERAL INFORMATION

#### 3.1. Product Details

Items	Description
Product Type	WLAN
Radio Type	Intentional Transceiver
Power Type	From Host system
Modulation	DSSS for IEEE 802.11b ; OFDM for IEEE 802.11g
Data Modulation	DSSS (BPSK / QPSK / CCK) ; OFDM (BPSK / QPSK / 16QAM / 64QAM)
Data Rate (Mbps)	DSSS (1/ 2/ 5.5/11) ; OFDM (6/9/12/18/24/36/48/54)
Frequency Range	2400 ~ 2483.5MHz
Channel Number	11 for 20MHz bandwidth ; 7 for 40MHz bandwidth
Channel Band Width (99%)	11b(20MHz) : 13.56 MHz 11b(40MHz- Lower Link) : 13.60 MHz 11g(20MHz) : 16.64 MHz 11g(40MHz) : 36.48 MHz
Conducted Output Power	11b(20MHz) : 19.58 dBm 11b(40MHz) : 17.70 dBm 11g(20MHz) : 24.19 dBm 11g(40MHz) : 17.95 dBm
Carrier Frequencies	Please refer to section 3.4
Antenna	Please refer to section 3.3

#### Antenna & Band width

Antenna	Single (TX)		Two (TX)	
	20 MHz	40 MHz	20 MHz	40 MHz
Band width Mode				
802.11b	V	V	V	V
802.11g	V	V	V	V

#### 3.2. Accessories

USB Cable	Cable Lenth
1	1.6m, shielded
2	0.5m, shielded

Due to USB Cable 1 is worst cases, so USB Cable 1 tested and recorded in this report.

### 3.3. Table for Filed Antenna

Ant.	Brand	Model Name	Antenna Type	Connector	Gain (dBi)
A	-	DWA-142	PIFA Antenna	NA	2.68
B	-	DWA-142	PIFA Antenna	NA	2.51

### 3.4. Table for Carrier Frequencies

There are two bandwidth systems for IEEE 802.11b & 802.11g.

For 20MHz bandwidth system, use Channel 1~ Channel 11

For 40MHz bandwidth system, use Channel 3~ Channel 9

Frequency Band	Channel No.	Frequency	Channel No.	Frequency
2400~2483.5MHz	1	2412 MHz	7	2442 MHz
	2	2417 MHz	8	2447 MHz
	3	2422 MHz	9	2452 MHz
	4	2427 MHz	10	2457 MHz
	5	2432 MHz	11	2462 MHz
	6	2437 MHz		

For IEEE 802.11b, the two TX Ant. A & Ant. B could transmit simultaneously.

For IEEE 802.11g, the two TX Ant. A & Ant. B could transmit simultaneously.

### 3.5. Table for Test Modes

Preliminary tests were performed in different data rate to find the worst radiated emission. The data rate shown in the table below is the worst-case rate with respect to the specific test item. Investigation has been done on all the possible configurations for searching the worst cases. The following table is a list of the test modes shown in this test report.

Test Items	Mode	Data Rate	Channel	Antenna
AC Power Line Conducted Emissions	Normal Link	11 Mbps	6	A+B
Maximum Peak Conducted Output Power Power Spectral Density 6dB Spectrum Bandwidth	11b/BPSK (20MHz)	1 Mbps	1/6/11	A / A+B
	11b/BPSK (40MHz)	1 Mbps	3/6/9	A / A+B
	11g/BPSK (20MHz)	6 Mbps	1/6/11	A / A+B
	11g/BPSK (40MHz)	6 Mbps	3/6/9	A / A+B
Radiated Emissions 9kHz~1GHz	11g/BPSK	6 Mbps	6	A / A+B
Radiated Emissions 1GHz~10 <sup>th</sup> Harmonic	11b/BPSK (20MHz)	1 Mbps	1/6/11	A / A+B
	11b/BPSK (40MHz)	1 Mbps	3/6/9	A / A+B
	11g/BPSK (20MHz)	6 Mbps	1/6/11	A / A+B
	11g/BPSK (40MHz)	6 Mbps	3/6/9	A / A+B
Band Edge Emissions	11b/BPSK (20MHz)	1 Mbps	1/11	A / A+B
	11b/BPSK (40MHz)	1 Mbps	3/9	A / A+B
	11g/BPSK (20MHz)	6 Mbps	1/11	A / A+B
	11g/BPSK (40MHz)	6 Mbps	3/9	A / A+B

### 3.6. Table for Testing Locations

Test Site No.	Site Category	Location	FCC Reg. No.	IC File No.	VCCI Reg. No
03CH03-HY	SAC	Hwa Ya	101377	IC 4088	-
CO04-HY	Conduction	Hwa Ya	101377	IC 4088	-
TH01-HY	OVEN Room	Hwa Ya	-	-	-

Open Area Test Site (OATS); Semi Anechoic Chamber (SAC); Fully Anechoic Chamber (FAC).

Please refer section 6 for Test Site Address.

### 3.7. Table for Supporting Units

Support Unit	Brand	Model	FCC ID
Notebook	DELL	D505	DoC
Printer	EPSON	LQ-300	DOC
Modem	ACEEX	DM-1414	IFAXDM1414
AP	3COM	AP2750	O9C-AP2750



### 3.8. Table for Parameters of Test Software Setting

During testing, Channel & Power Controlling Software provided by the customer was used to control the operating channel as well as the output power level. The RF output power selection is for the setting of RF output power expected by the customer and is going to be fixed on the firmware of the final end product.

#### Power Parameters of IEEE 802.11b 20MHz Ant. A Antenna Transmitter

Test Software Version	DutApiClient_Usb		
Frequency	2412 MHz	2437 MHz	2462 MHz
IEEE 802.11b Ant. A	53	55	55

#### Power Parameters of IEEE 802.11b 20MHz Ant. A + Ant. B Antenna Transmitter

Test Software Version	DutApiClient_Usb		
Frequency	2412 MHz	2437 MHz	2462 MHz
IEEE 802.11b Ant. A	50	4E	4E
IEEE 802.11b Ant. B	51	4F	4F

#### Power Parameters of IEEE 802.11b 40MHz Ant. A Antenna Transmitter

Test Software Version	DutApiClient_Usb					
Frequency	2422 MHz		2437 MHz		2452 MHz	
Link	Lower	Upper	Lower	Upper	Lower	Upper
IEEE 802.11b Ant. A	51	NA	51	51	NA	51

#### Power Parameters of IEEE 802.11b 40MHz Ant. A + Ant. B Antenna Transmitter

Test Software Version	DutApiClient_Usb					
Frequency	2422 MHz		2437 MHz		2452 MHz	
Link	Lower	Upper	Lower	Upper	Lower	Upper
IEEE 802.11b Ant. A	4F	NA	4F	4F	NA	4F
IEEE 802.11b Ant. B	50	NA	50	50	NA	50

#### Power Parameters of IEEE 802.11g 20MHz Ant. A Antenna Transmitter

Test Software Version	DutApiClient_Usb		
Frequency	2412 MHz	2437 MHz	2462 MHz
IEEE 802.11g Ant. A	57	57	55

#### Power Parameters of IEEE 802.11g 20MHz Ant. A + Ant. B Antenna Transmitter

Test Software Version	DutApiClient_Usb		
Frequency	2412 MHz	2437 MHz	2462 MHz
IEEE 802.11g Ant. A	56	56	55
IEEE 802.11g Ant. B	58	58	58

**Power Parameters of IEEE 802.11g 40MHz Ant. A Antenna Transmitter**

Test Software Version	DutApiClient_Usb		
Frequency	2422 MHz	2437 MHz	2452 MHz
IEEE 802.11g Ant. A	52	52	50

**Power Parameters of IEEE 802.11g 40MHz Ant. A + Ant. B Antenna Transmitter**

Test Software Version	DutApiClient_Usb		
Frequency	2422 MHz	2437 MHz	2452 MHz
IEEE 802.11g Ant. A	4F	4F	4E
IEEE 802.11g Ant. B	50	50	50

An executive program, EMCTEST.EXE under WIN XP, which generates a complete line of continuously repeating " H " pattern was used as the test software.

The program was executed as follows :

Turn on the power of all equipment.

The NB sends " H " messages to the panel, and the panel displays " H " patterns on the screen.

The NB sends " H " messages to the printer, then the printer prints them on the paper.

The NB sends " H " messages to the modem.

At the same time, the following programs were executed:

Executed "ping.exe" to link with the remote workstation to receive and transmit data by WLAN.

Executed " DutApiClient\_Usb " to control the EUT continuously transmit RF signal.

### 3.9. Test Configurations

#### 3.9.1. Radiation Emissions Test Configuration

##### USB Cable 1

Test Configuration: 9KHz~1GHz

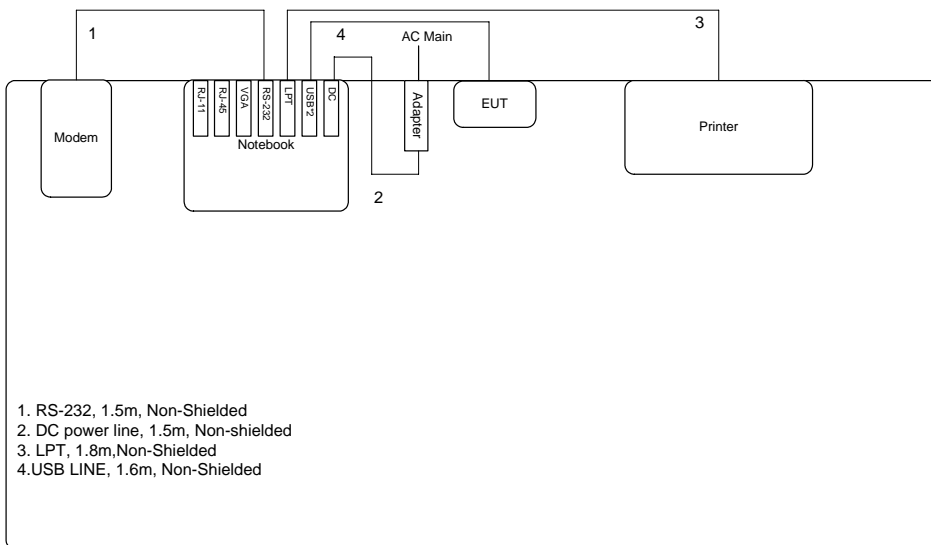

##### Test Configuration: above 1GHz

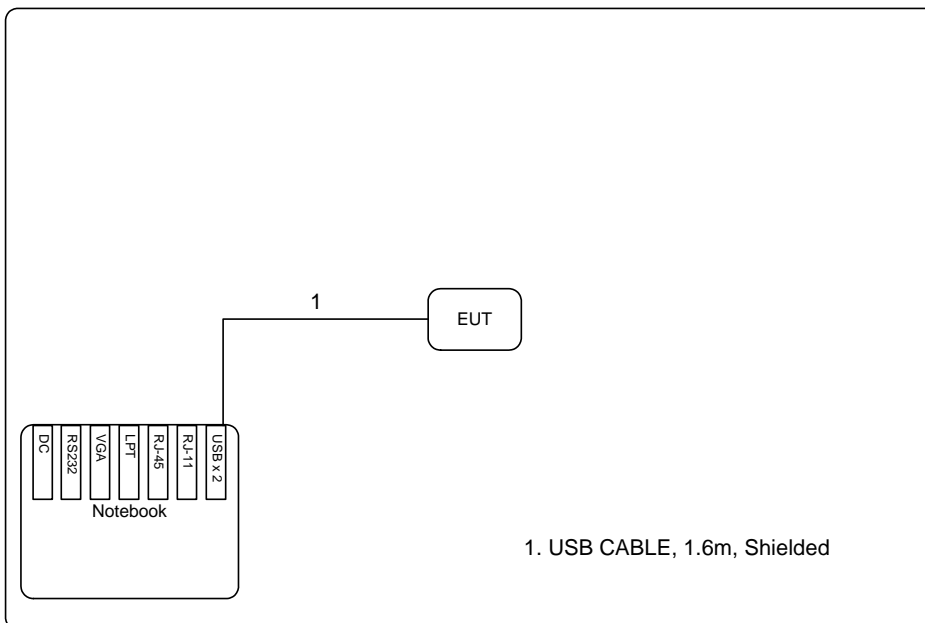

### USB Cable 2

#### Test Configuration: 9KHz~1GHz

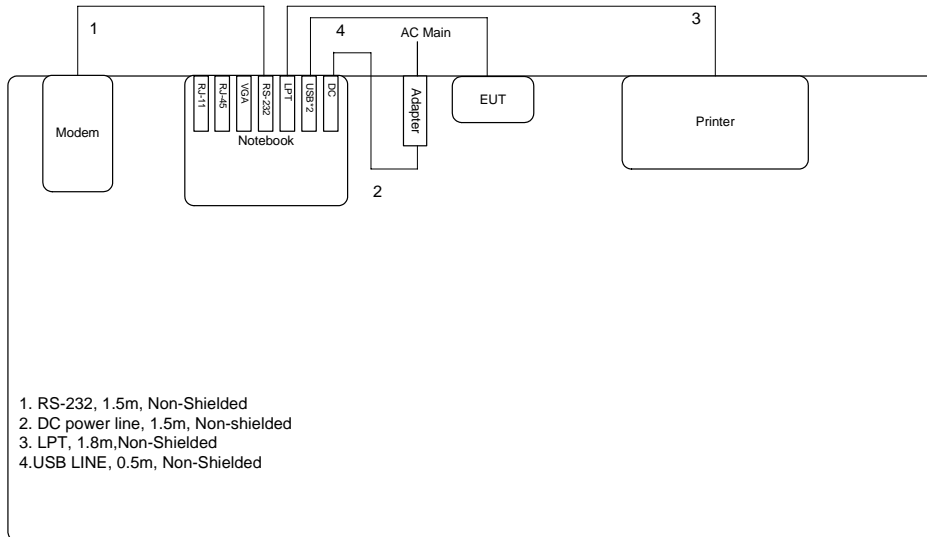

#### Test Configuration: above 1GHz

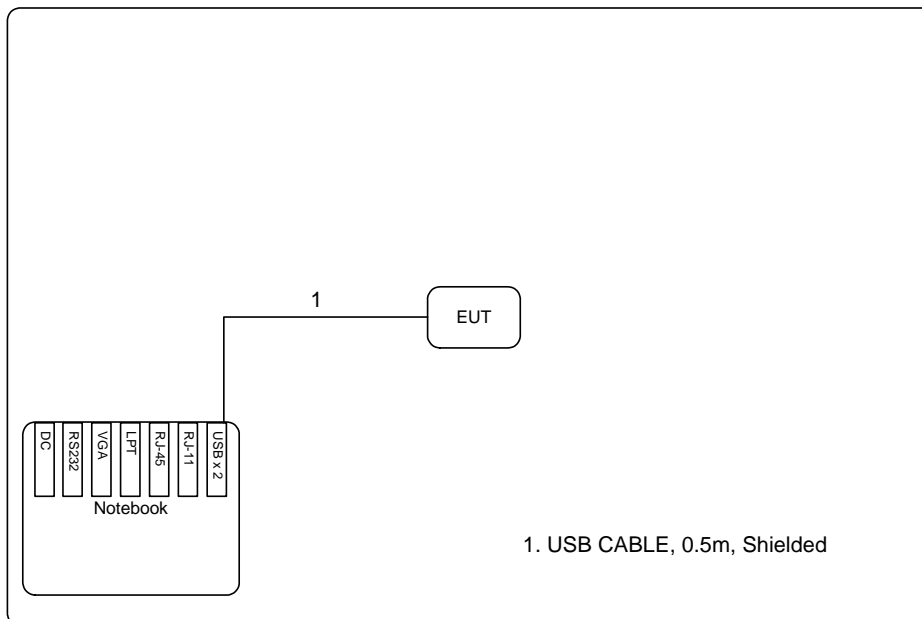

### 3.9.2. AC Power Line Conduction Emissions Test Configuration

USB Cable 1

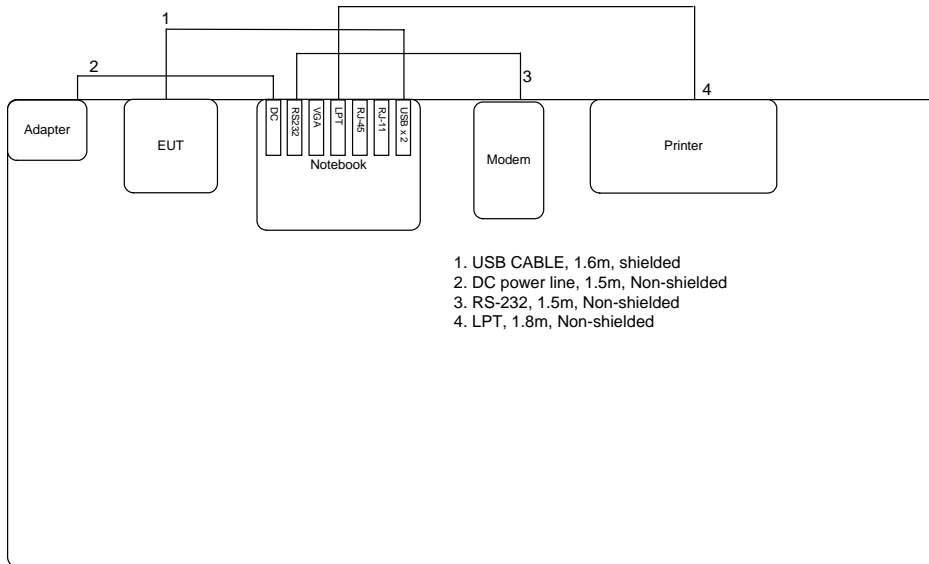

WLAN AP

USB Cable 2

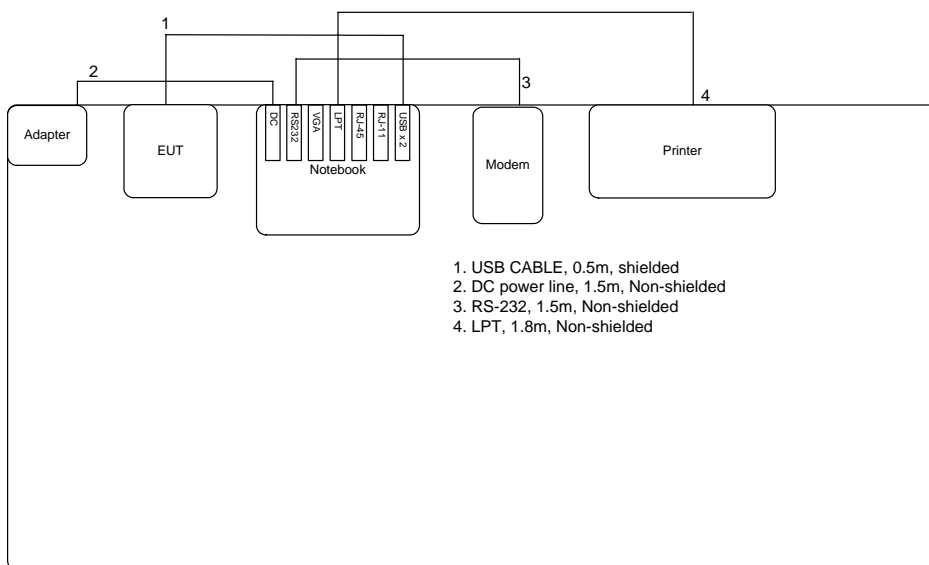

WLAN AP

## 4. TEST RESULT

### 4.1. AC Power Line Conducted Emissions Measurement

#### 4.1.1. Limit

For this product which is designed to be connected to the AC power line, the radio frequency voltage that is conducted back onto the AC power line on any frequency or frequencies within the band 150 kHz to 30 MHz shall not exceed below limits table.

Frequency (MHz)	QP Limit (dBuV)	AV Limit (dBuV)
0.15~0.5	66~56	56~46
0.5~5	56	46
5~30	60	50

#### 4.1.2. Measuring Instruments and Setting

Please refer to section 5 of equipments list in this report. The following table is the setting of the receiver.

Receiver Parameters	Setting
Attenuation	10 dB
Start Frequency	0.15 MHz
Stop Frequency	30 MHz
IF Bandwidth	9 KHz

#### 4.1.3. Test Procedures

1. Configure the EUT according to ANSI C63.4. The EUT or host of EUT has to be placed 0.4 meter far from the conducting wall of the shielding room and at least 80 centimeters from any other grounded conducting surface.
2. Connect EUT or host of EUT to the power mains through a line impedance stabilization network (LISN).
3. All the support units are connected to the other LISNs. The LISN should provide 50uH/50ohms coupling impedance.
4. The frequency range from 150 KHz to 30 MHz was searched.
5. Set the test-receiver system to Peak Detect Function and Specified Bandwidth with Maximum Hold Mode.
6. The measurement has to be done between each power line and ground at the power terminal.

#### 4.1.4. Test Setup Layout

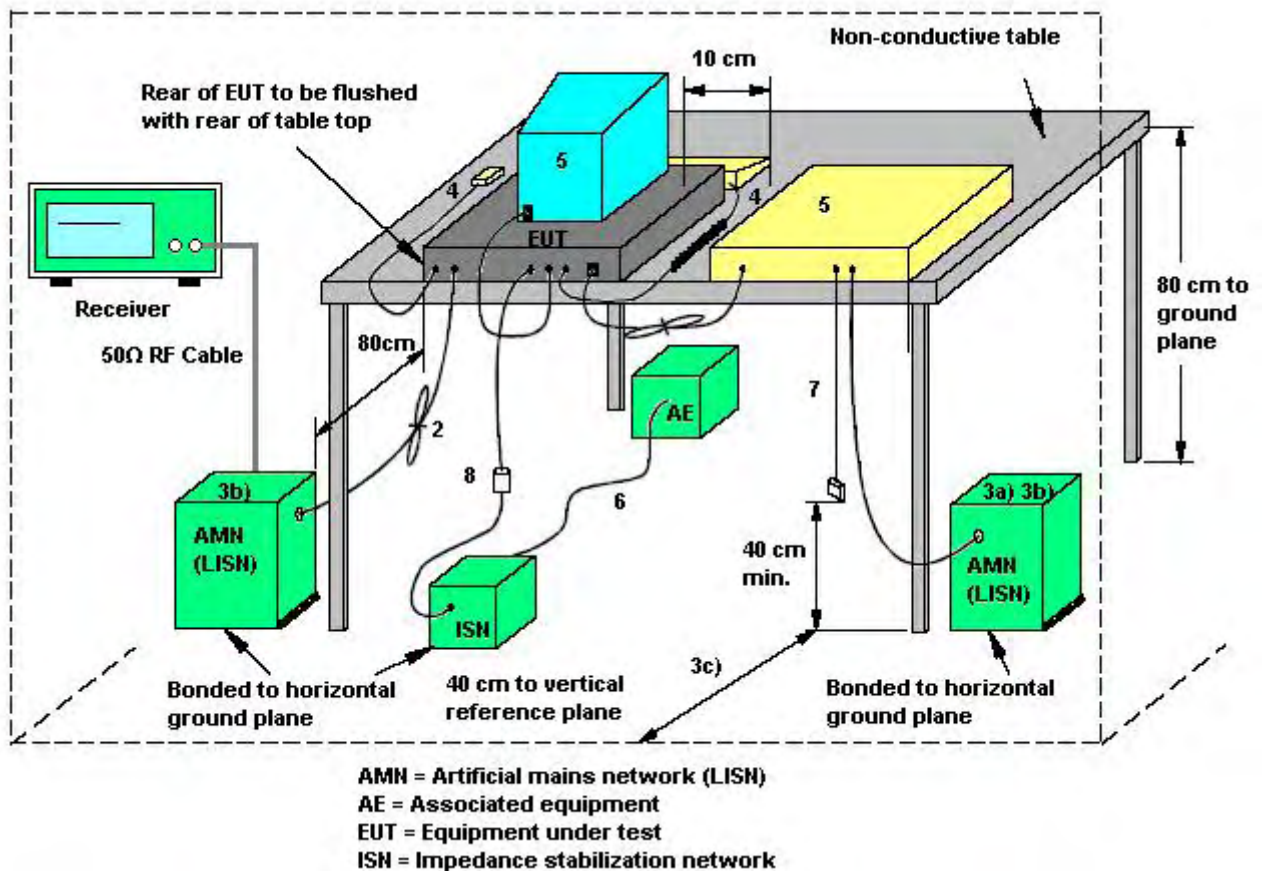

1. If cables, which hang closer than 40 cm to the horizontal metal groundplane, cannot be shortened to appropriate length, the excess shall be folded back and forth forming a bundle 30 cm to 40 cm long.
2. Excess mains cord shall be bundled in the centre or shortened to appropriate length.
3. EUT is connected to one artificial mains network (AMN). All AMNs and ISNs may alternatively be connected to a vertical reference plane or metal wall.
4. All other units of a system are powered from a second AMN. A multiple outlet strip can be used for multiple mains cords.
5. AMN and ISN are 80 cm from the EUT and at least 80 cm from other units and other metal planes.
6. Mains cords and signal cables shall be positioned for their entire lengths, as far as possible, at 40 cm from the vertical reference plane.
7. Cables of hand operated devices, such as keyboards, mice, etc. shall be placed as for normal usage.
8. Peripherals shall be placed at a distance of 10 cm from each other and from the controller, except for the monitor which, if this is an acceptable installation practice, shall be placed directly on the top of the controller.
9. I/O signal cable intended for external connection.
10. The end of the I/O signal cables which are not connected to an AE may be terminated, if required, using correct terminating impedance.
11. If used, the current probe shall be placed at 0,1 m from the ISN.

4.1.5. Test Deviation

There is no deviation with the original standard.

4.1.6. EUT Operation during Test

The EUT was placed on the test table and programmed in normal function.

4.1.7. Results of AC Power Line Conducted Emissions Measurement

Temperature	24°C	Humidity	64%
Test Engineer	Leo Hung	Phase	Line
Configuration	Normal Link		

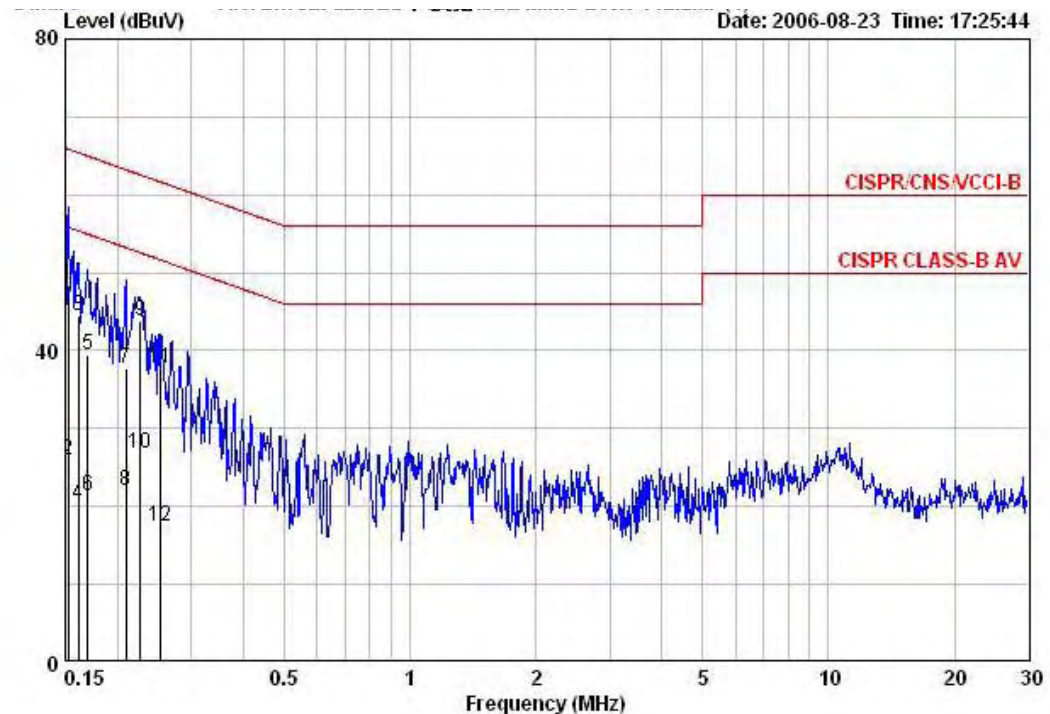

	Freq	Level	Over	Limit	Read	LISN	Cable	Remark
	MHz	dBuV	Limit	Line	Level	Factor	Loss	
			dB	dBuV	dBuV	dB	dB	
1	0.15240	48.41	-17.46	65.87	46.18	2.03	0.20	QP
2	0.15240	26.00	-29.87	55.87	23.77	2.03	0.20	AVERAGE
3	0.16155	44.54	-20.85	65.38	42.27	2.07	0.20	QP
4	0.16155	20.20	-35.19	55.38	17.93	2.07	0.20	AVERAGE
5	0.16944	39.53	-25.46	64.99	37.41	1.92	0.20	QP
6	0.16944	21.31	-33.68	54.99	19.19	1.92	0.20	AVERAGE
7	0.20944	37.73	-25.50	63.23	36.32	1.21	0.20	QP
8	0.20944	21.93	-31.30	53.23	20.52	1.21	0.20	Average
9	0.22676	43.87	-18.69	62.57	42.64	1.03	0.20	QP
10	0.22676	26.82	-25.74	52.57	25.59	1.03	0.20	AVERAGE
11	0.25345	37.63	-24.01	61.64	36.53	0.90	0.20	QP
12	0.25345	17.40	-34.24	51.64	16.30	0.90	0.20	AVERAGE



Temperature	24°C	Humidity	64%
Test Engineer	Leo Hung	Phase	Neutral
Configuration	Normal Link		

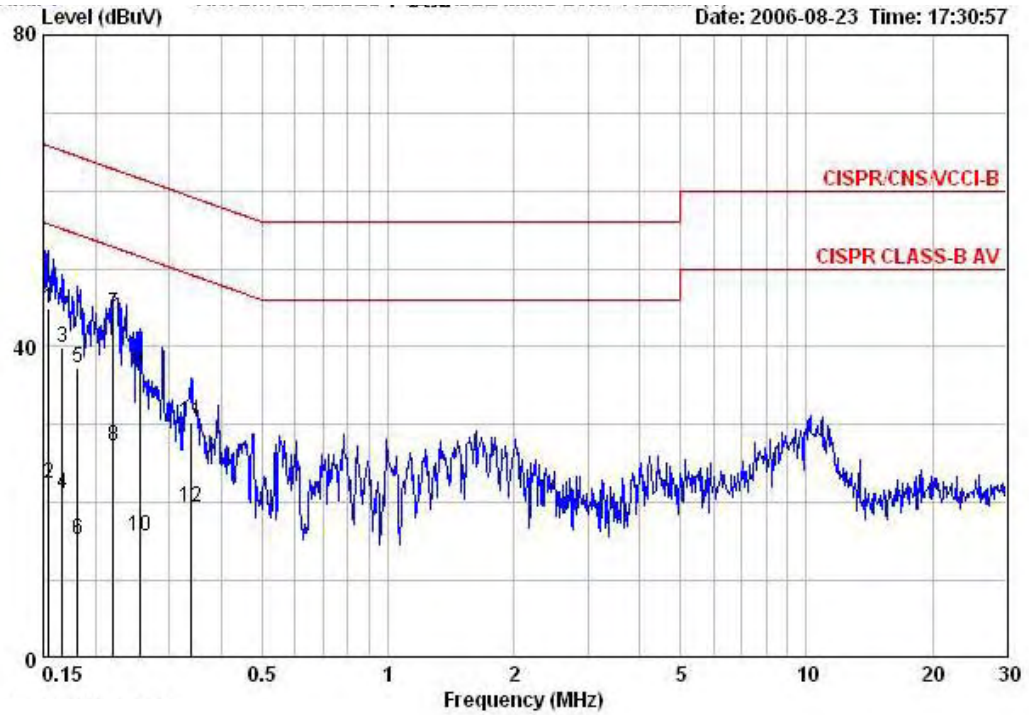

	Freq	Level	Over	Limit	Read	LISN	Cable	Remark
	MHz	dBuV	Limit	Line	Level	Factor	Loss	
			dB	dBuV	dBuV	dB	dB	
1	0.15485	44.96	-20.78	65.74	42.86	1.90	0.20	QP
2	0.15485	22.46	-33.28	55.74	20.36	1.90	0.20	AVERAGE
3	0.16677	39.81	-25.31	65.12	37.84	1.77	0.20	QP
4	0.16677	21.16	-33.96	55.12	19.19	1.77	0.20	AVERAGE
5	0.18152	37.22	-27.20	64.42	35.61	1.41	0.20	QP
6	0.18152	15.20	-39.22	54.42	13.59	1.41	0.20	AVERAGE
7	0.22083	44.21	-18.58	62.79	43.02	0.99	0.20	QP
8	0.22083	27.30	-25.49	52.79	26.11	0.99	0.20	AVERAGE
9	0.25480	36.84	-24.76	61.60	35.84	0.80	0.20	QP
10	0.25480	15.69	-35.91	51.60	14.69	0.80	0.20	AVERAGE
11	0.33740	30.30	-28.97	59.27	29.50	0.60	0.20	QP
12	0.33740	19.30	-29.97	49.27	18.50	0.60	0.20	AVERAGE

Note:

Level = Read Level + LISN Factor + Cable Loss.

## 4.2. Maximum Peak Output Power Measurement

### 4.2.1. Limit

For systems using digital modulation in the 2400-2483.5MHz, the limit for peak output power is 30dBm. The limited has to be reduced by the amount in dB that the gain of the antenna exceed 6dBi. In case of point-to-point operation, the limit has to be reduced by 1dB for every 3dB that the directional gain of the antenna exceeds 6dBi.

### 4.2.2. Measuring Instruments and Setting

Please refer to section 5 of equipments list in this report. The following table is the setting of the power meter.

Power Meter Parameter	Setting
Filter No.	Auto
Measurement time	0.135 s ~ 26 s
Used Peak Sensor	NRV-Z32 (model 04)

### 4.2.3. Test Procedures

1. The transmitter output (antenna port) was connected to the power meter.
2. Turn on the EUT and power meter and then record the peak power value.
3. Repeat above procedures on all channels needed to be tested.

### 4.2.4. Test Setup Layout

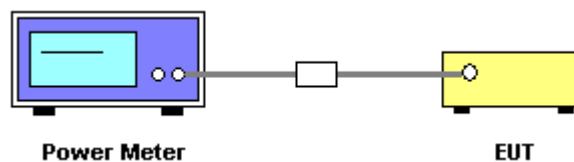

### 4.2.5. Test Deviation

There is no deviation with the original standard.

### 4.2.6. EUT Operation during Test

The EUT was programmed to be in continuously transmitting mode.

#### 4.2.7. Test Result of Maximum Peak Output Power

Temperature	24°C	Humidity	64%
Test Engineer	Leo Hung	Configurations	802.11b/g

##### Configuration IEEE 802.11b 20MHz Ant. A

Channel	Frequency	Conducted Power (dBm)	Max. Limit (dBm)	Result
1	2412 MHz	16.5	30.00	Complies
6	2437 MHz	19.3	30.00	Complies
11	2462 MHz	19.58	30.00	Complies

##### Configuration IEEE 802.11b 20MHz Ant. A + Ant. B

Channel	Frequency	Ant. A Port (dBm)	Ant. B Port (dBm)	Combination Conducted Power (dBm)	Max. Limit (dBm)	Result
1	2412 MHz	15.02	14.95	17.99	30.00	Complies
6	2437 MHz	15.44	15.23	18.34	30.00	Complies
11	2462 MHz	15.55	15.24	18.40	30.00	Complies

##### Configuration IEEE 802.11b 40MHz Ant. A - Lower

Channel	Frequency	Conducted Power (dBm)	Max. Limit (dBm)	Result
3	2422 MHz	15.27	30.00	Complies
6	2437 MHz	15.15	30.00	Complies
9	2452 MHz	NA	30.00	Complies

##### Configuration IEEE 802.11b 40MHz Ant. A + Ant. B - Lower

Channel	Frequency	Ant. A Port (dBm)	Ant. B Port (dBm)	Combination Conducted Power (dBm)	Max. Limit (dBm)	Result
3	2422 MHz	14.17	14.26	17.22	30.00	Complies
6	2437 MHz	14.26	14.52	17.40	30.00	Complies
9	2452 MHz	NA	NA	NA	30.00	Complies

##### Configuration IEEE 802.11b 40MHz Ant. A - Upper

Channel	Frequency	Conducted Power (dBm)	Max. Limit (dBm)	Result
3	2422 MHz	NA	30.00	Complies
6	2437 MHz	15.65	30.00	Complies
9	2452 MHz	15.12	30.00	Complies

**Configuration IEEE 802.11b 40MHz Ant. A + Ant. B - Upper**

Channel	Frequency	Ant. A Port (dBm)	Ant. B Port (dBm)	Combination Conducted Power (dBm)	Max. Limit (dBm)	Result
3	2422 MHz	NA	NA	NA	30.00	Complies
6	2437 MHz	14.62	14.77	17.70	30.00	Complies
9	2452 MHz	14.54	14.6	17.58	30.00	Complies

**Configuration IEEE 802.11g 20MHz Ant. A**

Channel	Frequency	Conducted Power (dBm)	Max. Limit (dBm)	Result
1	2412 MHz	20.22	30.00	Complies
6	2437 MHz	20.74	30.00	Complies
11	2462 MHz	20.1	30.00	Complies

**Configuration IEEE 802.11g 20MHz Ant. A + Ant. B**

Channel	Frequency	Ant. A Port (dBm)	Ant. B Port (dBm)	Combination Conducted Power (dBm)	Max. Limit (dBm)	Result
1	2412 MHz	18.92	19.71	22.34	30.00	Complies
6	2437 MHz	20.36	21.88	24.19	30.00	Complies
11	2462 MHz	20.14	21.92	24.13	30.00	Complies

**Configuration IEEE 802.11g 40MHz Ant. A**

Channel	Frequency	Conducted Power (dBm)	Max. Limit (dBm)	Result
3	2422 MHz	16.12	30.00	Complies
6	2437 MHz	16.32	30.00	Complies
9	2452 MHz	16.4	30.00	Complies

**Configuration IEEE 802.11g 40MHz Ant. A + Ant. B**

Channel	Frequency	Ant. A Port (dBm)	Ant. B Port (dBm)	Combination Conducted Power (dBm)	Max. Limit (dBm)	Result
3	2422 MHz	14.24	14.75	17.51	30.00	Complies
6	2437 MHz	14.11	14.23	17.18	30.00	Complies
9	2452 MHz	14.54	15.32	17.95	30.00	Complies

### 4.3. Power Spectral Density Measurement

#### 4.3.1. Limit

For digitally modulated systems, the power spectral density conducted from the intentional radiator to the antenna shall not be greater than 8 dBm in any 3 kHz band during any time interval of continuous transmission.

#### 4.3.2. Measuring Instruments and Setting

Please refer to section 5 of equipments list in this report. The following table is the setting of Spectrum Analyzer.

Spectrum Parameter	Setting
Attenuation	Auto
Span Frequency	1.5MHz
RB	3 kHz
VB	30 kHz
Detector	Peak
Trace	Max Hold
Sweep Time	500s

#### 4.3.3. Test Procedures

1. The transmitter output (antenna port) was connected to the spectrum analyser.
2. Set RBW of spectrum analyzer to 3kHz and VBW to 30kHz. Set Detector to Peak, Trace to Max Hold.
3. Mark the frequency with maximum peak power as the center of the display of the spectrum.
4. Set the span to 1.5MHz and the sweep time to 500s and record the maximum peak value.

#### 4.3.4. Test Setup Layout

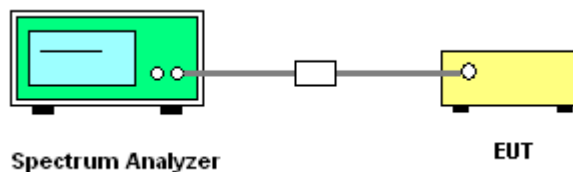

#### 4.3.5. Test Deviation

There is no deviation with the original standard.

#### 4.3.6. EUT Operation during Test

The EUT was programmed to be in continuously transmitting mode.

#### 4.3.7. Test Result of Power Spectral Density

<b>Temperature</b>	24°C	<b>Humidity</b>	64%
<b>Test Engineer</b>	Leo Hung	<b>Configurations</b>	802.11b/g

##### Configuration IEEE 802.11b 20MHz Ant. A

Channel	Frequency	Power Density (dBm)	Max. Limit (dBm)	Result
1	2412 MHz	-14.59	8.00	Complies
6	2437 MHz	-12.28	8.00	Complies
11	2462 MHz	-11.93	8.00	Complies

##### Configuration IEEE 802.11b 20MHz Ant. A + Ant. B

Channel	Frequency	Power Density (dBm)	Max. Limit (dBm)	Result
1	2412 MHz	-9.32	8.00	Complies
6	2437 MHz	-9.32	8.00	Complies
11	2462 MHz	-9.34	8.00	Complies

##### Configuration IEEE 802.11b 40MHz Ant. A - Lower

Channel	Frequency	Power Density (dBm)	Max. Limit (dBm)	Result
3	2422 MHz	-15.81	8.00	Complies
6	2437 MHz	-16.03	8.00	Complies
9	2452 MHz	NA	8.00	Complies

##### Configuration IEEE 802.11b 40MHz Ant. A + Ant. B - Lower

Channel	Frequency	Power Density (dBm)	Max. Limit (dBm)	Result
3	2422 MHz	-8.89	8.00	Complies
6	2437 MHz	-9.4	8.00	Complies
9	2452 MHz	NA	8.00	Complies

**Configuration IEEE 802.11b 40MHz Ant. A - Upper**

Channel	Frequency	Power Density (dBm)	Max. Limit (dBm)	Result
3	2422 MHz	NA	8.00	Complies
6	2437 MHz	-15.06	8.00	Complies
9	2452 MHz	-15.35	8.00	Complies

**Configuration IEEE 802.11b 40MHz Ant. A + Ant. B - Upper**

Channel	Frequency	Power Density (dBm)	Max. Limit (dBm)	Result
3	2422 MHz	NA	8.00	Complies
6	2437 MHz	-8.44	8.00	Complies
9	2452 MHz	-8.63	8.00	Complies

**Configuration IEEE 802.11g 20MHz Ant. A**

Channel	Frequency	Power Density (dBm)	Max. Limit (dBm)	Result
1	2412 MHz	-15.12	8.00	Complies
6	2437 MHz	-14.84	8.00	Complies
11	2462 MHz	-15.27	8.00	Complies

**Configuration IEEE 802.11g 20MHz Ant. A + Ant. B**

Channel	Frequency	Power Density (dBm)	Max. Limit (dBm)	Result
1	2412 MHz	-9.84	8.00	Complies
6	2437 MHz	-7.2	8.00	Complies
11	2462 MHz	-8.03	8.00	Complies

**Configuration IEEE 802.11g 40MHz Ant. A**

Channel	Frequency	Power Density (dBm)	Max. Limit (dBm)	Result
3	2422 MHz	-22.03	8.00	Complies
6	2437 MHz	-21.25	8.00	Complies
9	2452 MHz	-20.96	8.00	Complies

**Configuration IEEE 802.11g 40MHz Ant. A + Ant. B**

Channel	Frequency	Power Density (dBm)	Max. Limit (dBm)	Result
3	2422 MHz	-16.29	8.00	Complies
6	2437 MHz	-15.41	8.00	Complies
9	2452 MHz	-15.98	8.00	Complies

### Power Density Plot on Configuration IEEE 802.11b 20MHz Ant. A / 2412 MHz

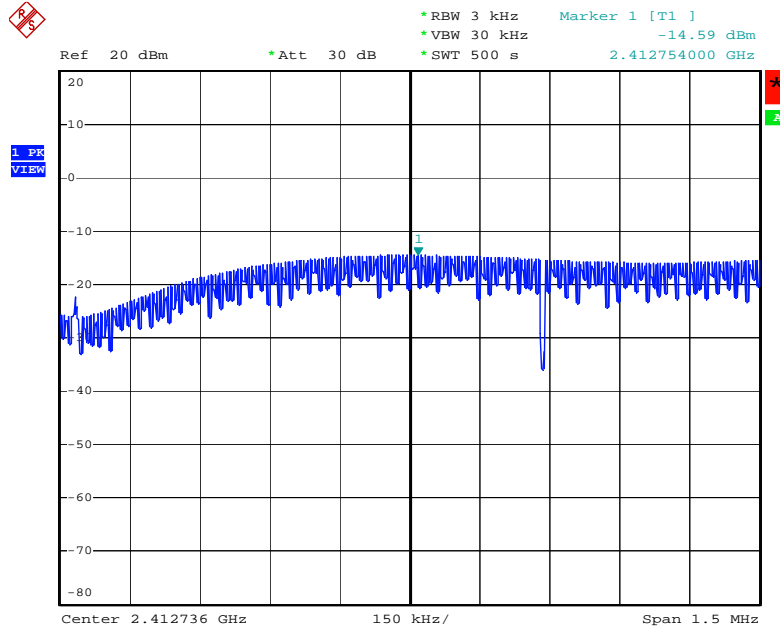

Date: 17.AUG.2006 08:43:57

### Power Density Plot on Configuration IEEE 802.11b 20MHz Ant. A / 2437 MHz

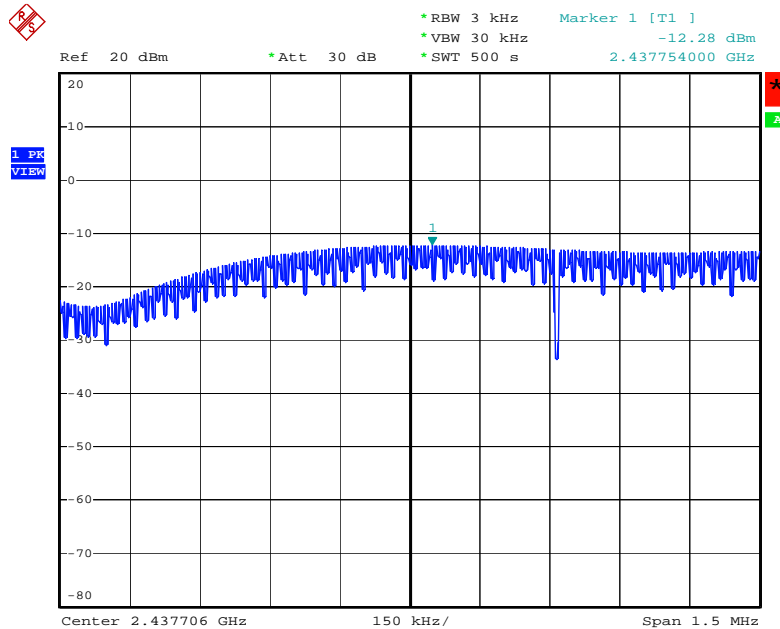

Date: 17.AUG.2006 08:36:25



**Power Density Plot on Configuration IEEE 802.11b 20MHz Ant. A / 2462 MHz**

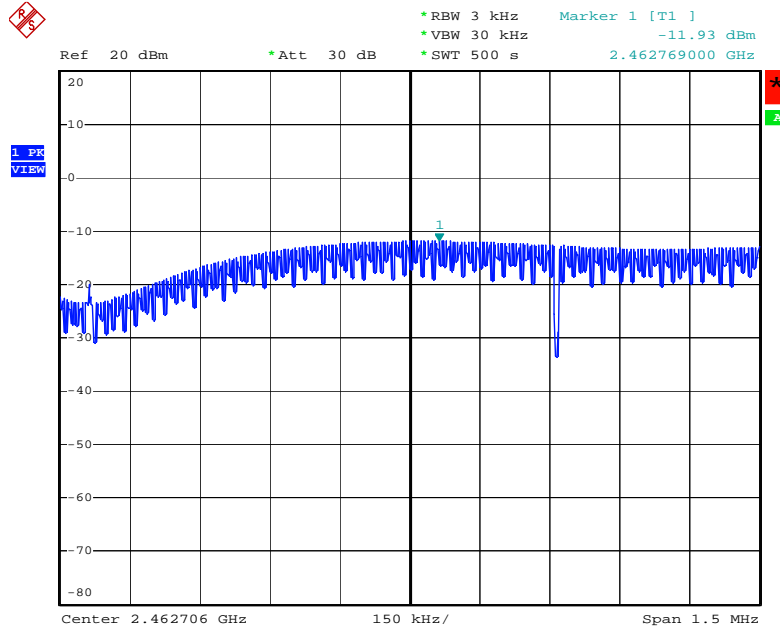

Date: 17.AUG.2006 08:31:16

**Power Density Plot on Configuration IEEE 802.11b 20MHz Ant. A + Ant. B / 2412 MHz**

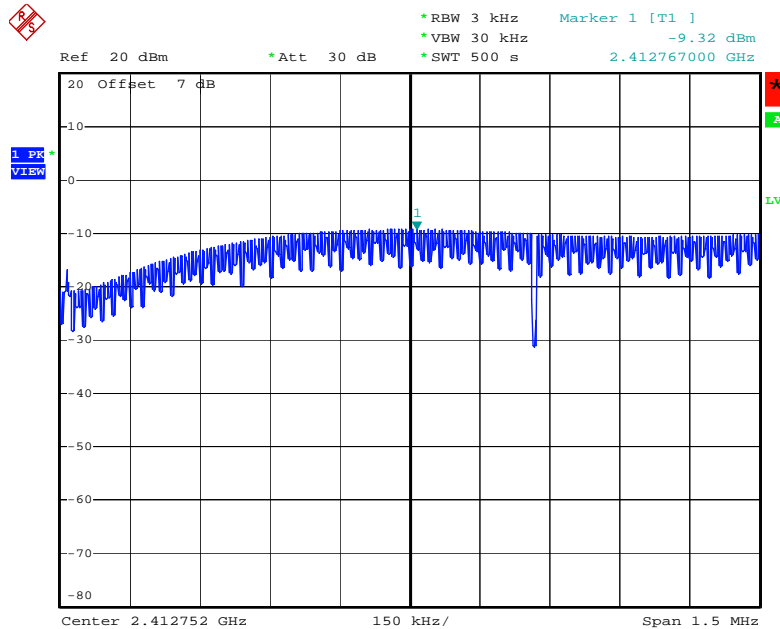

Date: 17.AUG.2006 04:42:57

### Power Density Plot on Configuration IEEE 802.11b 20MHz Ant. A + Ant. B / 2437 MHz

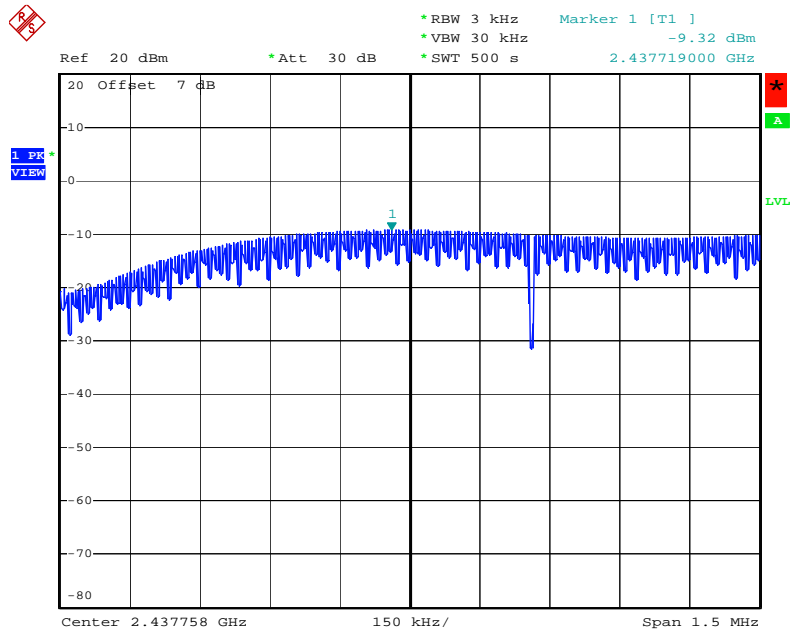

Date: 17.AUG.2006 04:46:05

### Power Density Plot on Configuration IEEE 802.11b 20MHz Ant. A + Ant. B / 2462 MHz

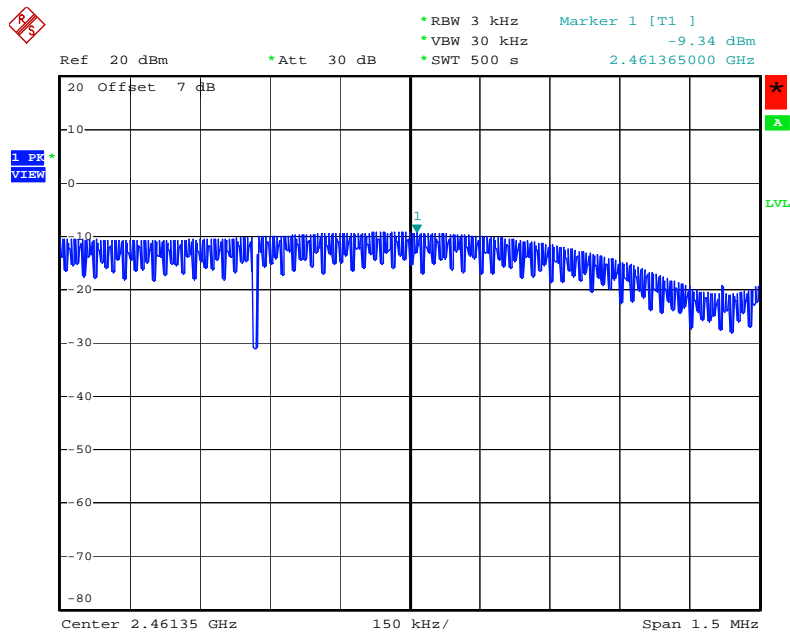

Date: 17.AUG.2006 04:53:03

**Power Density Plot on Configuration IEEE 802.11b 40MHz Ant. A / 2422 MHz**

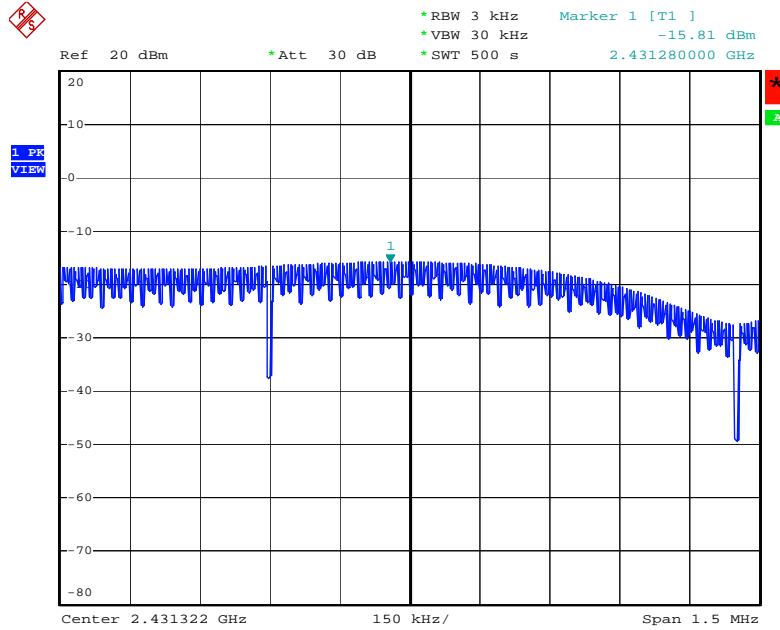

Date: 17.AUG.2006 08:50:14

**Power Density Plot on Configuration IEEE 802.11b 40MHz Ant. A / 2437 MHz (Lower)**

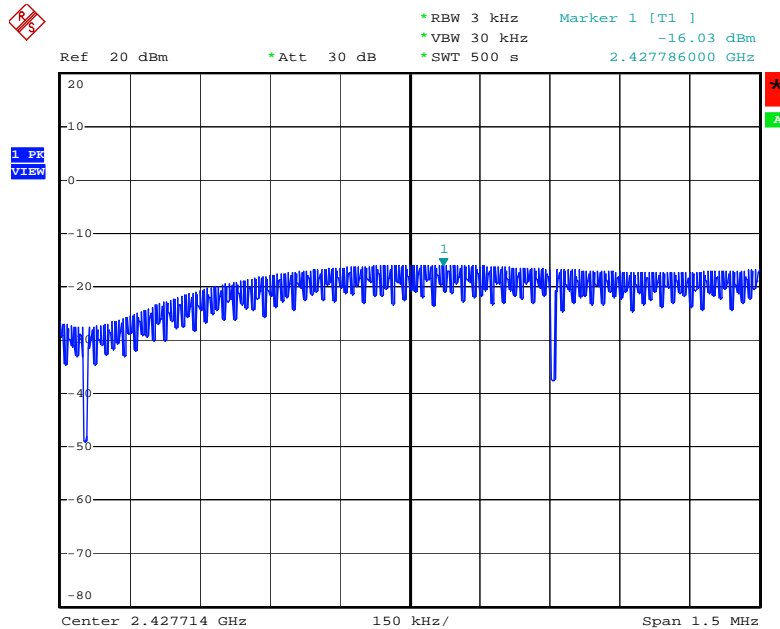

Date: 17.AUG.2006 08:54:07

### Power Density Plot on Configuration IEEE 802.11b 40MHz Ant. A / 2437 MHz (Upper)

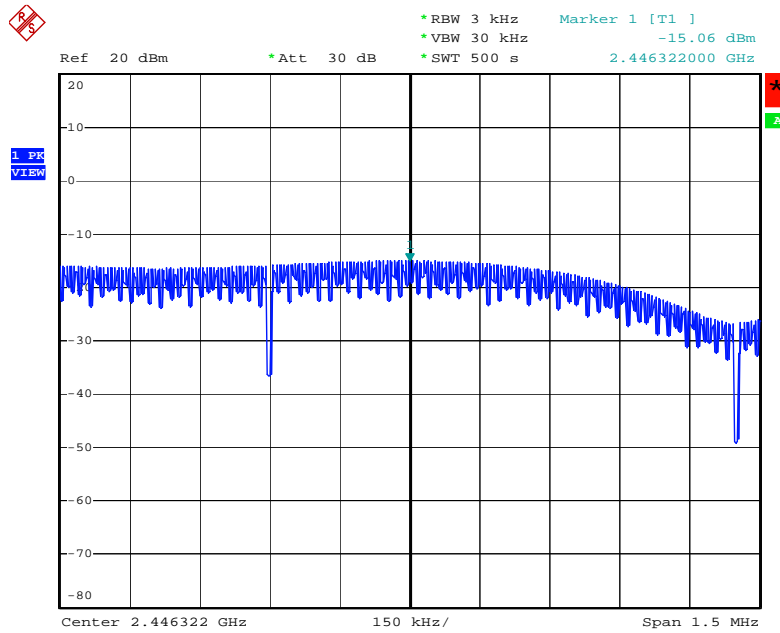

Date: 17.AUG.2006 08:51:20

### Power Density Plot on Configuration IEEE 802.11b 40MHz Ant. A / 2452 MHz

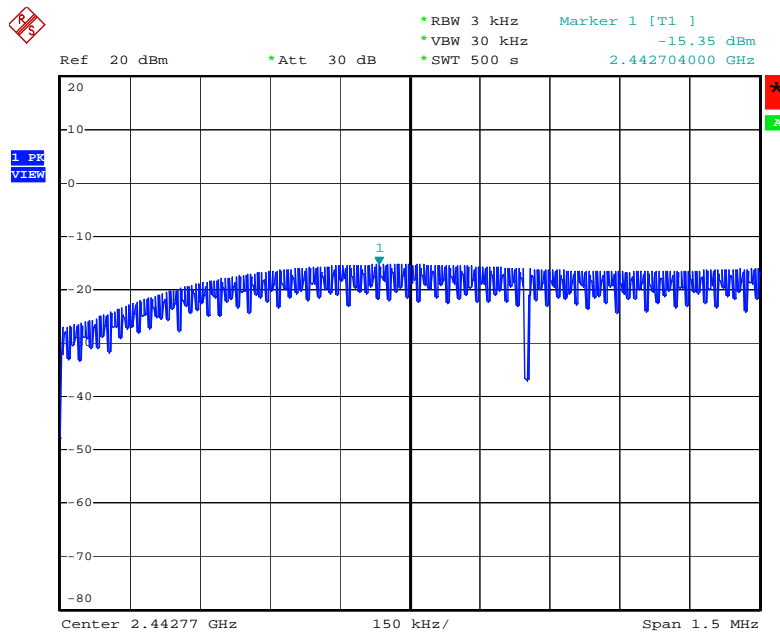

Date: 17.AUG.2006 08:55:02

**Power Density Plot on Configuration IEEE 802.11b 40MHz Ant. A + Ant. B / 2422 MHz**

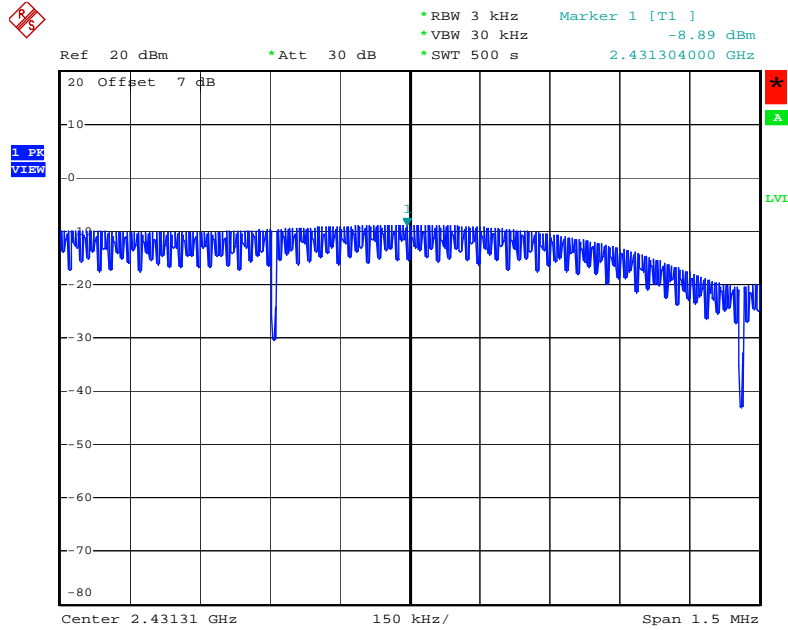

Date: 17.AUG.2006 04:57:21

**Power Density Plot on Configuration IEEE 802.11b 40MHz Ant. A + Ant. B / 2437 MHz (Lower)**

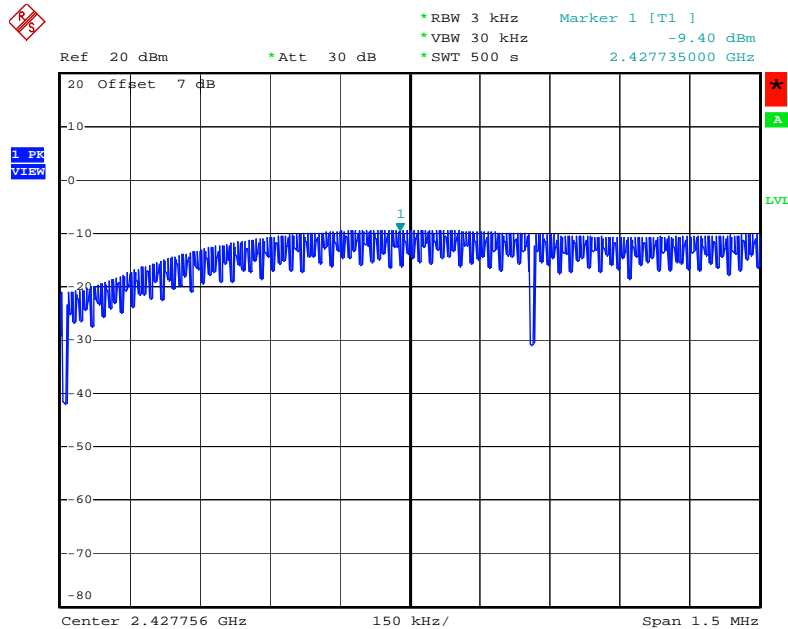

Date: 17.AUG.2006 05:18:42

Power Density Plot on Configuration IEEE 802.11b 40MHz Ant. A + Ant. B / 2437 MHz (Upper)

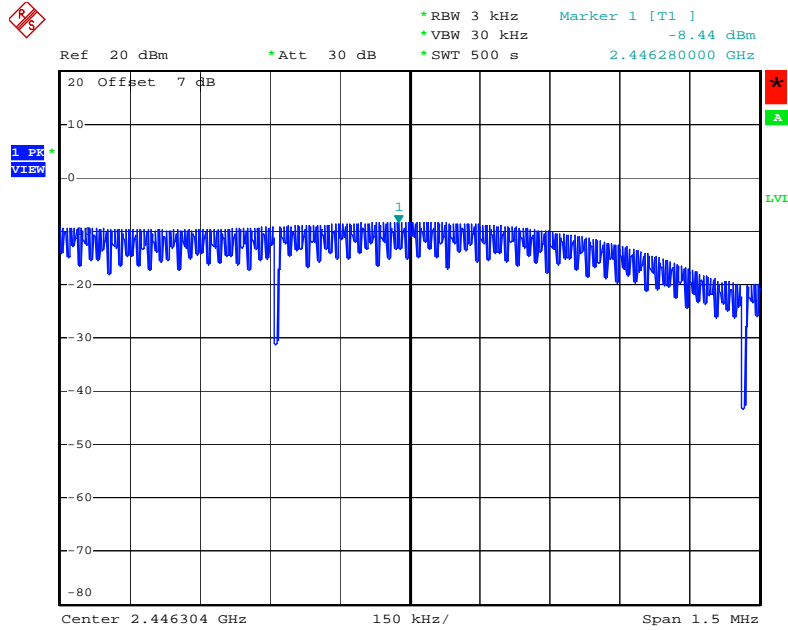

Date: 17.AUG.2006 05:11:32

Power Density Plot on Configuration IEEE 802.11b 40MHz Ant. A + Ant. B / 2452 MHz

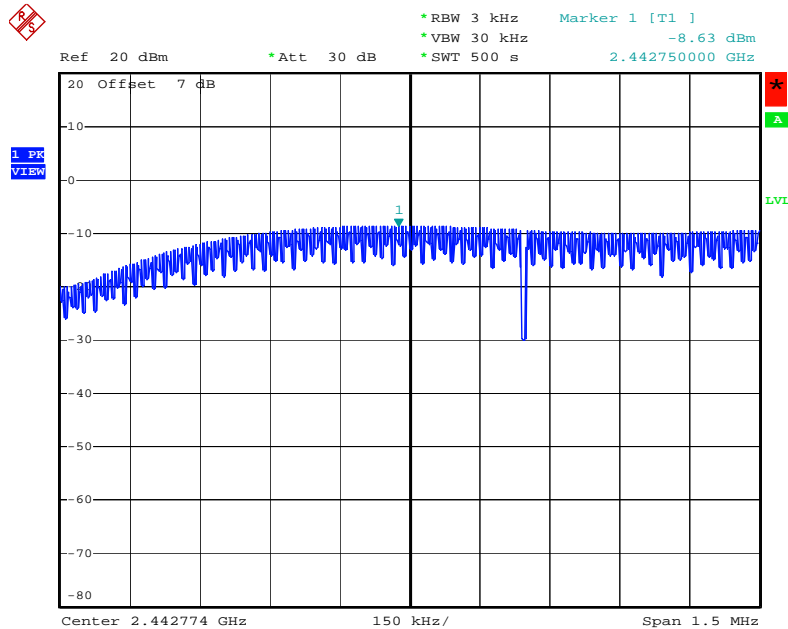

Date: 17.AUG.2006 05:09:35

### Power Density Plot on Configuration IEEE 802.11g 20MHz Ant. A / 2412 MHz

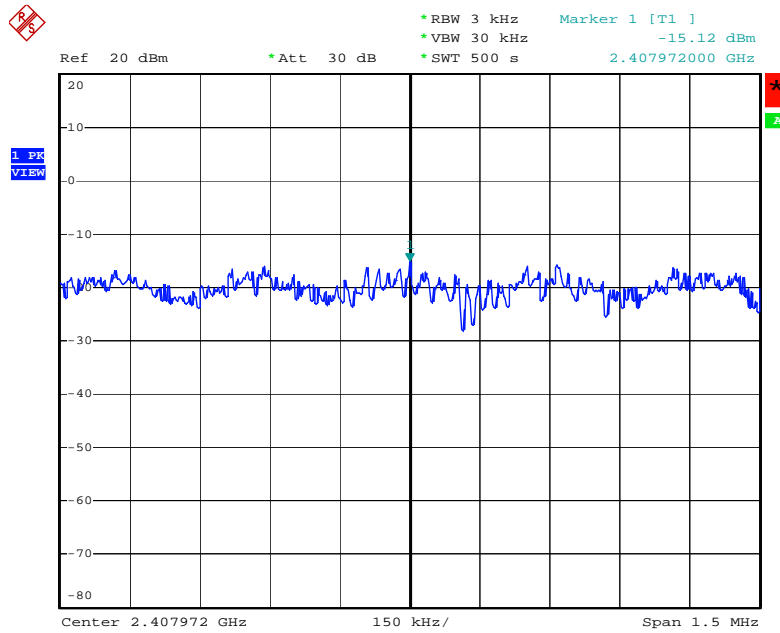

Date: 17.AUG.2006 09:25:27

### Power Density Plot on Configuration IEEE 802.11g 20MHz Ant. A / 2437 MHz

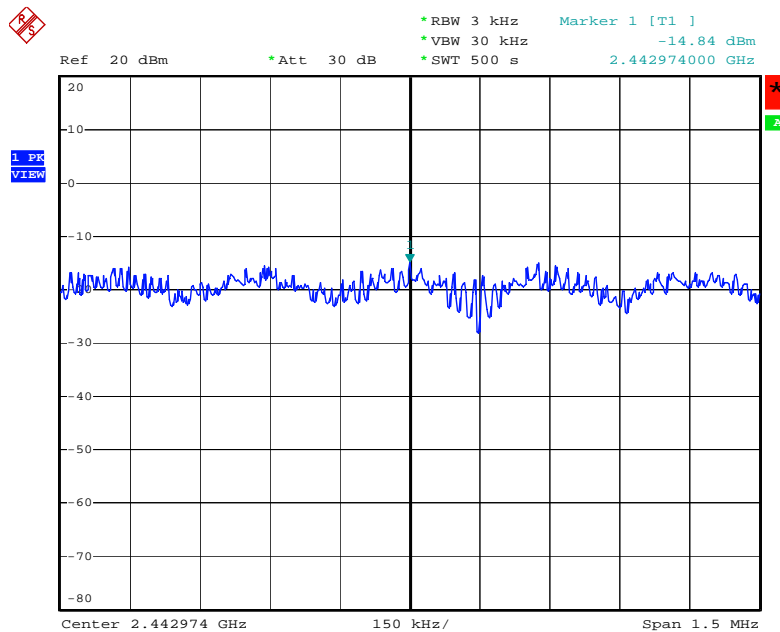

Date: 17.AUG.2006 09:34:29

**Power Density Plot on Configuration IEEE 802.11g 20MHz Ant. A / 2462 MHz**

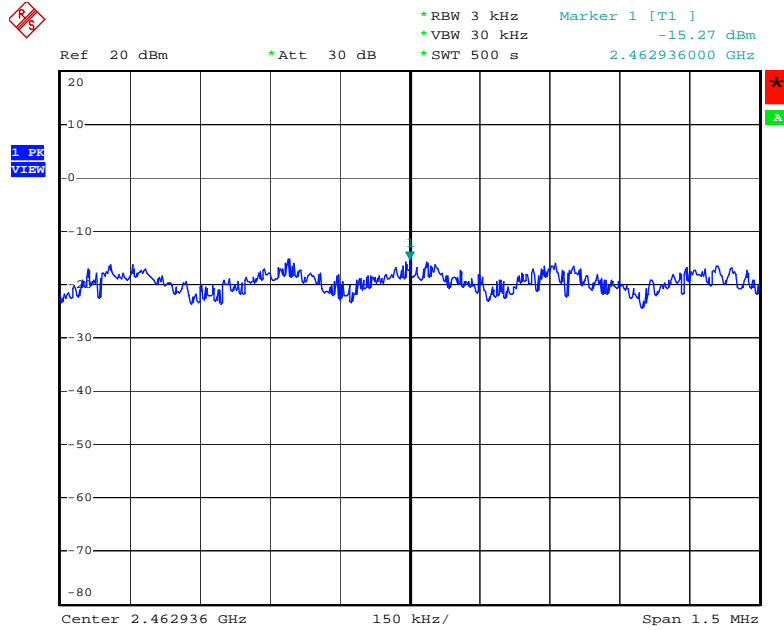

Date: 17.AUG.2006 09:37:36

**Power Density Plot on Configuration IEEE 802.11g 20MHz Ant. A + Ant. B / 2412 MHz**

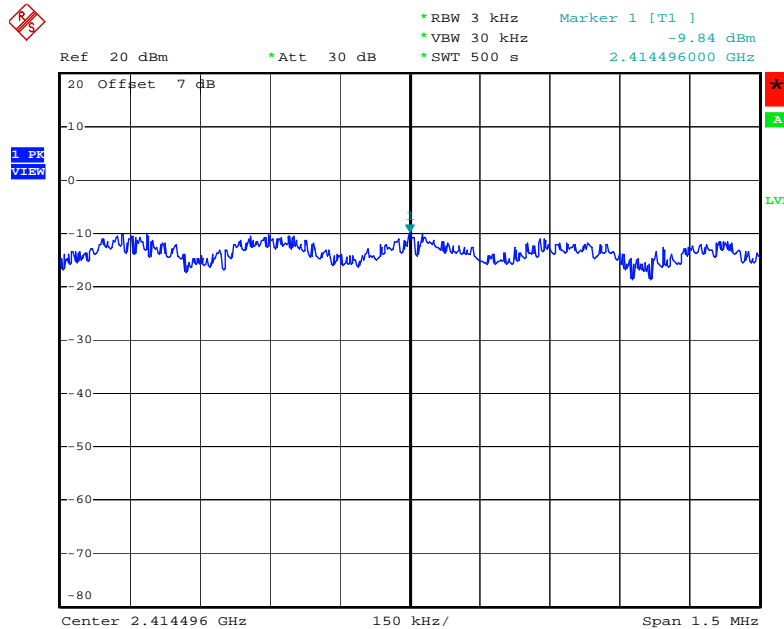

Date: 17.AUG.2006 05:44:17





### Power Density Plot on Configuration IEEE 802.11g 20MHz Ant. A + Ant. B / 2437 MHz

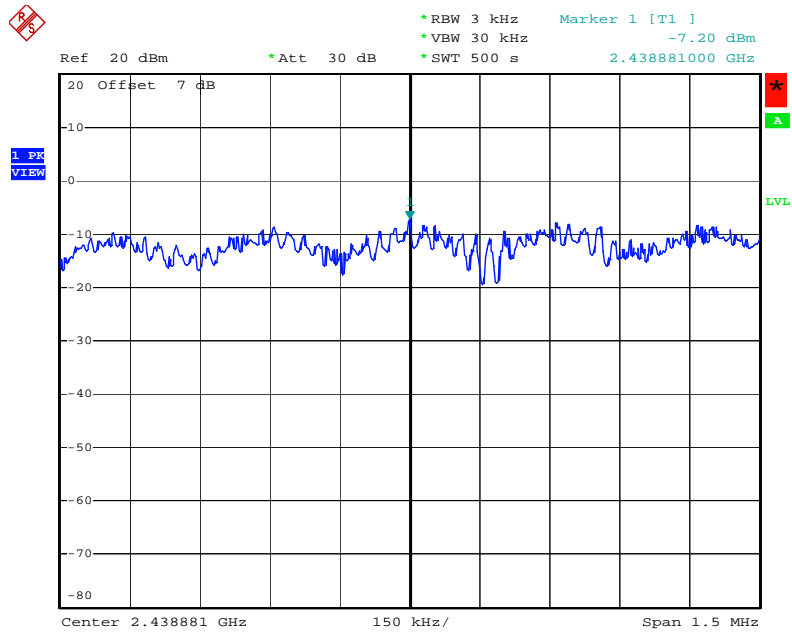

Date: 17.AUG.2006 05:46:24

### Power Density Plot on Configuration IEEE 802.11g 20MHz Ant. A + Ant. B / 2462 MHz

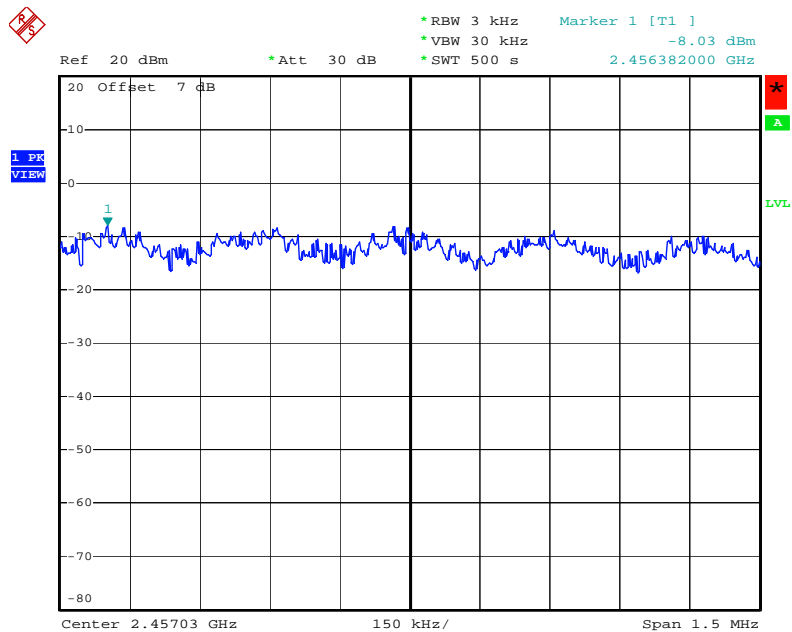

Date: 17.AUG.2006 05:52:27

### Power Density Plot on Configuration IEEE 802.11g 40MHz Ant. A / 2422 MHz

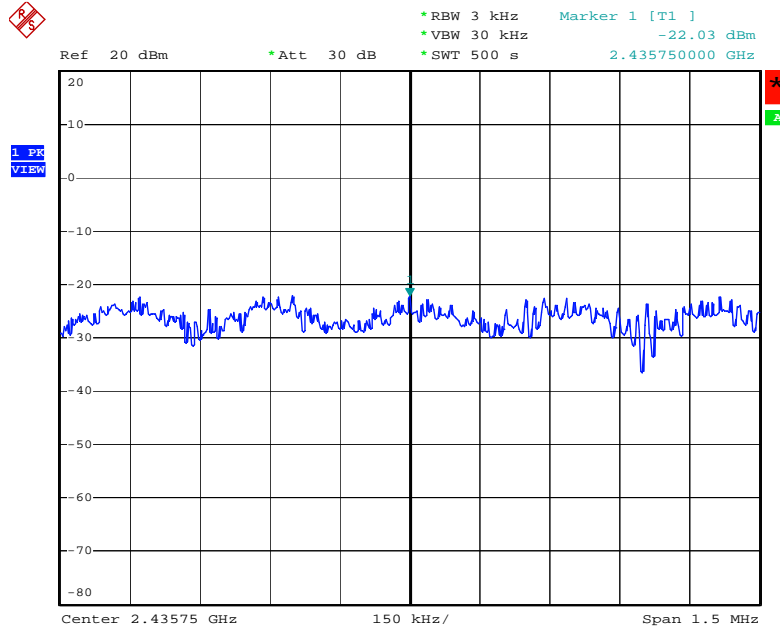

Date: 17.AUG.2006 09:06:42

### Power Density Plot on Configuration IEEE 802.11g 40MHz Ant. A / 2437 MHz

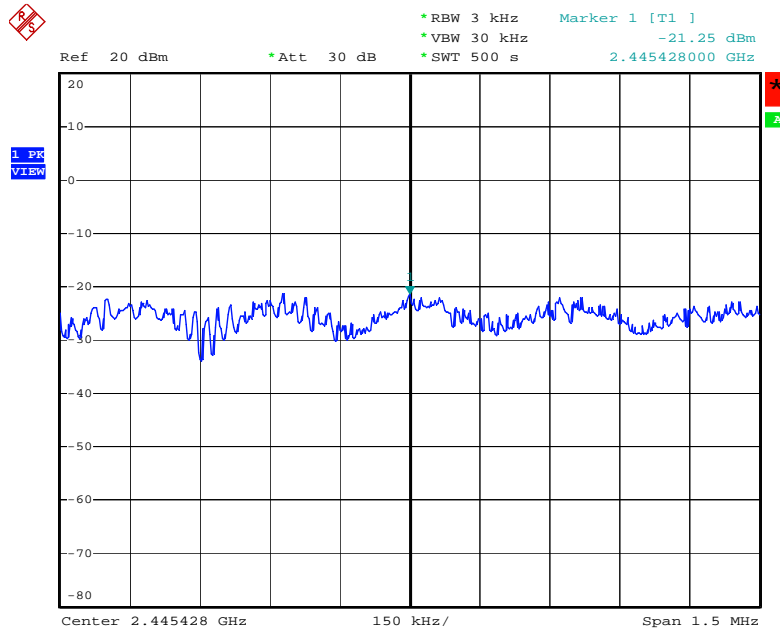

Date: 17.AUG.2006 09:08:06

**Power Density Plot on Configuration IEEE 802.11g 40MHz Ant. A / 2452 MHz**

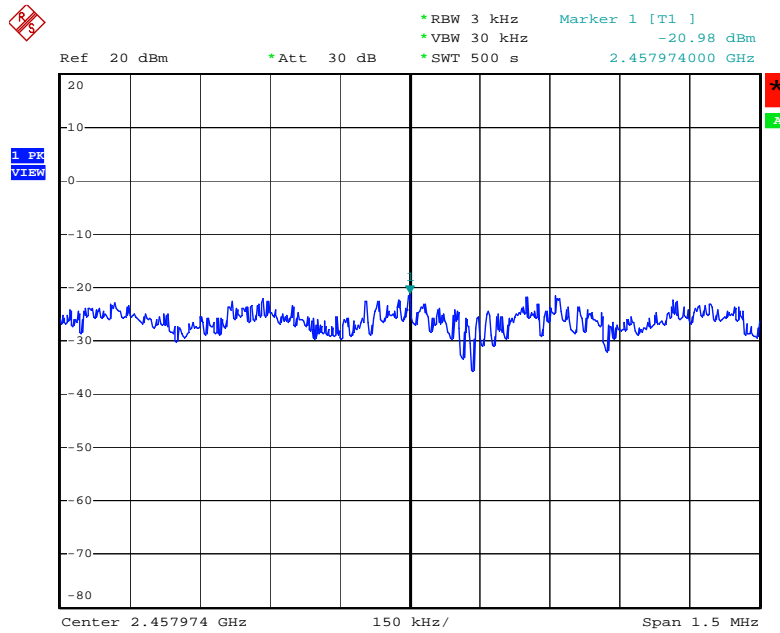

Date: 17.AUG.2006 09:11:28

**Power Density Plot on Configuration IEEE 802.11g 40MHz Ant. A + Ant. B / 2422 MHz**

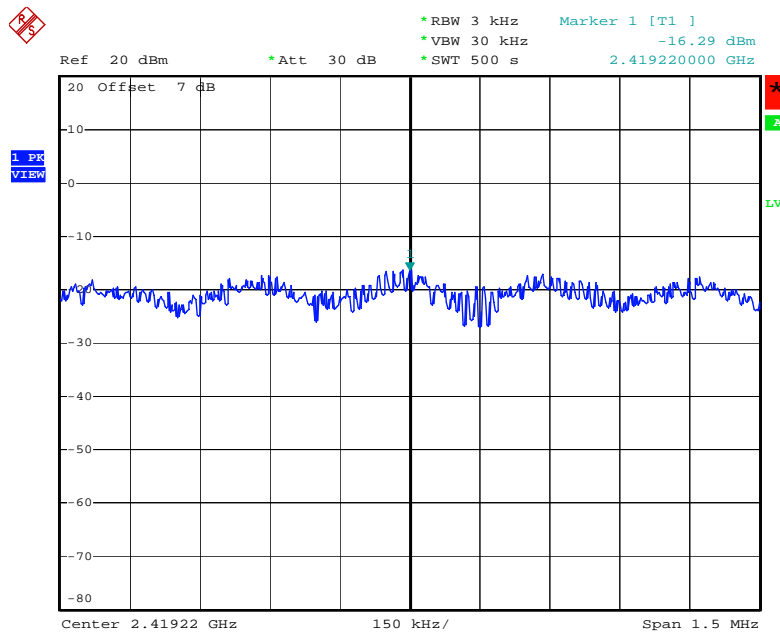

Date: 17.AUG.2006 05:26:25

### Power Density Plot on Configuration IEEE 802.11g 40MHz Ant. A + Ant. B / 2437 MHz

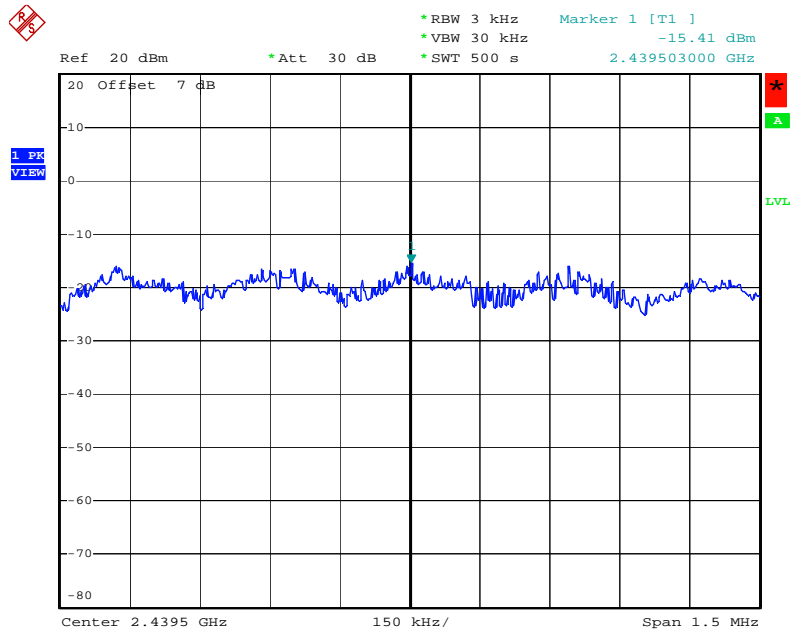

Date: 17.AUG.2006 05:38:05

### Power Density Plot on Configuration IEEE 802.11g 40MHz Ant. A + Ant. B / 2452 MHz

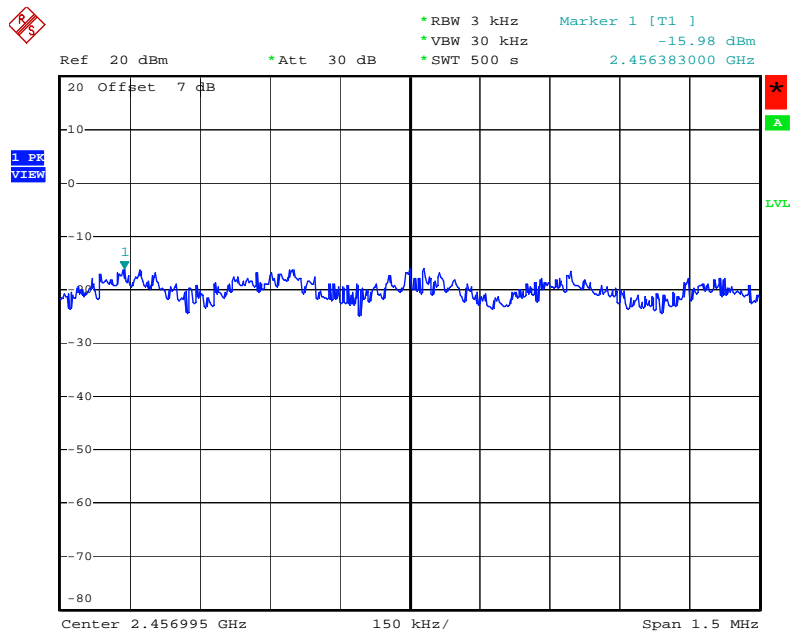

Date: 17.AUG.2006 05:27:54

#### 4.4. 6dB Spectrum Bandwidth Measurement

##### 4.4.1. Limit

For digital modulation systems, the minimum 6 dB bandwidth shall be at least 500 kHz.

##### 4.4.2. Measuring Instruments and Setting

Please refer to section 5 of equipments list in this report. The following table is the setting of the Spectrum Analyzer.

Spectrum Parameters	Setting
Attenuation	Auto
Span Frequency	> 6dB Bandwidth
RB	100 kHz
VB	100 kHz
Detector	Peak
Trace	Max Hold
Sweep Time	Auto

##### 4.4.3. Test Procedures

1. The transmitter output (antenna port) was connected to the spectrum analyser in peak hold mode.
2. The resolution bandwidth of 100 kHz and the video bandwidth of 100 kHz were used.
3. Measured the spectrum width with power higher than 6dB below carrier.

##### 4.4.4. Test Setup Layout

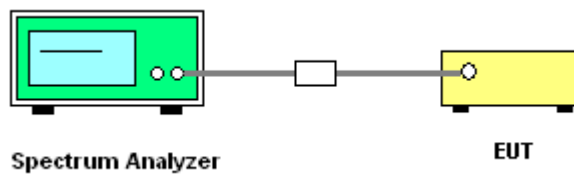

#### 4.4.5. Test Deviation

There is no deviation with the original standard.

#### 4.4.6. EUT Operation during Test

The EUT was programmed to be in continuously transmitting mode.

#### 4.4.7. Test Result of 6dB Spectrum Bandwidth

<b>Temperature</b>	24°C	<b>Humidity</b>	64%
<b>Test Engineer</b>	Leo Hung	<b>Configurations</b>	802.11b/g

##### Configuration IEEE 802.11b 20MHz Ant. A

Channel	Frequency	6dB Bandwidth (MHz)	99% Occupied Bandwidth (MHz)	Min. Limit (kHz)	Test Result
1	2412 MHz	10.08	13.52	500	Complies
6	2437 MHz	10.04	13.56	500	Complies
11	2462 MHz	10.04	13.4	500	Complies

##### Configuration IEEE 802.11b 20MHz Ant. A + Ant. B

Channel	Frequency	6dB Bandwidth (MHz)	99% Occupied Bandwidth (MHz)	Min. Limit (kHz)	Test Result
1	2412 MHz	10.04	13.4	500	Complies
6	2437 MHz	9.92	13.28	500	Complies
11	2462 MHz	10.04	13.32	500	Complies

##### Configuration IEEE 802.11b 40MHz Ant. A - Lower

Channel	Frequency	6dB Bandwidth (MHz)	99% Occupied Bandwidth (MHz)	Min. Limit (kHz)	Test Result
3	2422 MHz	10.08	13.6	500	Complies
6	2437 MHz	10	13.52	500	Complies
9	2452 MHz	NA	NA	500	Complies

##### Configuration IEEE 802.11b 40MHz Ant. A + Ant. B - Lower

Channel	Frequency	6dB Bandwidth (MHz)	99% Occupied Bandwidth (MHz)	Min. Limit (kHz)	Test Result
3	2422 MHz	10	13.36	500	Complies
6	2437 MHz	10	13.44	500	Complies
9	2452 MHz	NA	NA	500	Complies

**Configuration IEEE 802.11b 40MHz Ant. A - Upper**

Channel	Frequency	6dB Bandwidth (MHz)	99% Occupied Bandwidth (MHz)	Min. Limit (kHz)	Test Result
3	2422 MHz	NA	NA	500	Complies
6	2437 MHz	10	13.52	500	Complies
9	2452 MHz	9.84	13.52	500	Complies

**Configuration IEEE 802.11b 40MHz Ant. A + Ant. B - Upper**

Channel	Frequency	6dB Bandwidth (MHz)	99% Occupied Bandwidth (MHz)	Min. Limit (kHz)	Test Result
3	2422 MHz	NA	NA	500	Complies
6	2437 MHz	9.6	13.28	500	Complies
9	2452 MHz	10	13.36	500	Complies

**Configuration IEEE 802.11g 20MHz Ant. A**

Channel	Frequency	6dB Bandwidth (MHz)	99% Occupied Bandwidth (MHz)	Min. Limit (kHz)	Test Result
1	2412 MHz	16.6	16.52	500	Complies
6	2437 MHz	16.56	16.52	500	Complies
11	2462 MHz	16.6	16.52	500	Complies

**Configuration IEEE 802.11g 20MHz Ant. A + Ant. B**

Channel	Frequency	6dB Bandwidth (MHz)	99% Occupied Bandwidth (MHz)	Min. Limit (kHz)	Test Result
1	2412 MHz	16.6	16.6	500	Complies
6	2437 MHz	16.64	16.64	500	Complies
11	2462 MHz	13.2	15.88	500	Complies

**Configuration IEEE 802.11g 40MHz Ant. A**

Channel	Frequency	6dB Bandwidth (MHz)	99% Occupied Bandwidth (MHz)	Min. Limit (kHz)	Test Result
3	2422 MHz	36.64	36.32	500	Complies
6	2437 MHz	36.56	36.32	500	Complies
9	2452 MHz	36.48	36.32	500	Complies

**Configuration IEEE 802.11g 40MHz Ant. A + Ant. B**

Channel	Frequency	6dB Bandwidth (MHz)	99% Occupied Bandwidth (MHz)	Min. Limit (kHz)	Test Result
3	2422 MHz	36.64	36.48	500	Complies
6	2437 MHz	36.48	36.48	500	Complies
9	2452 MHz	33.2	35.36	500	Complies

6 dB Bandwidth Plot on Configuration IEEE 802.11b 20MHz Ant. A / 2412 MHz

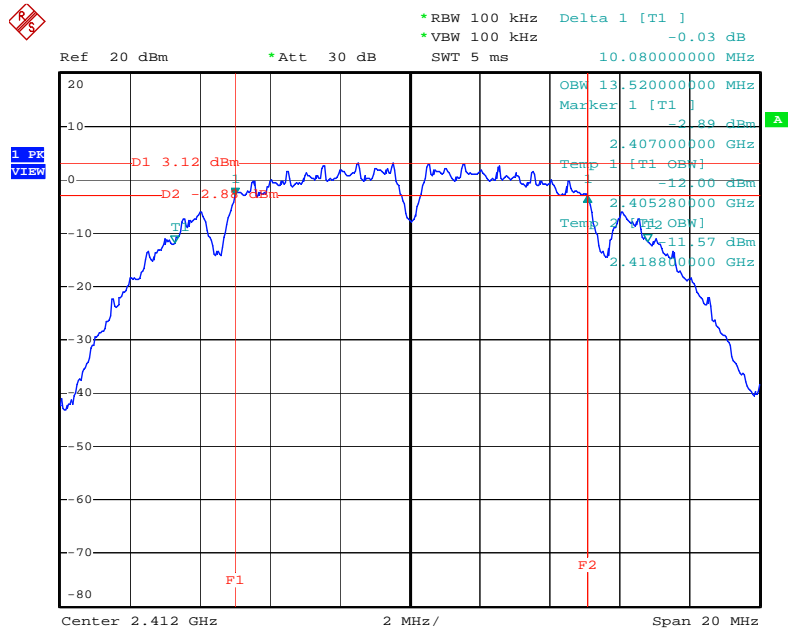

Date: 17.AUG.2006 08:28:11

6 dB Bandwidth Plot on Configuration IEEE 802.11b 20MHz Ant. A / 2437 MHz

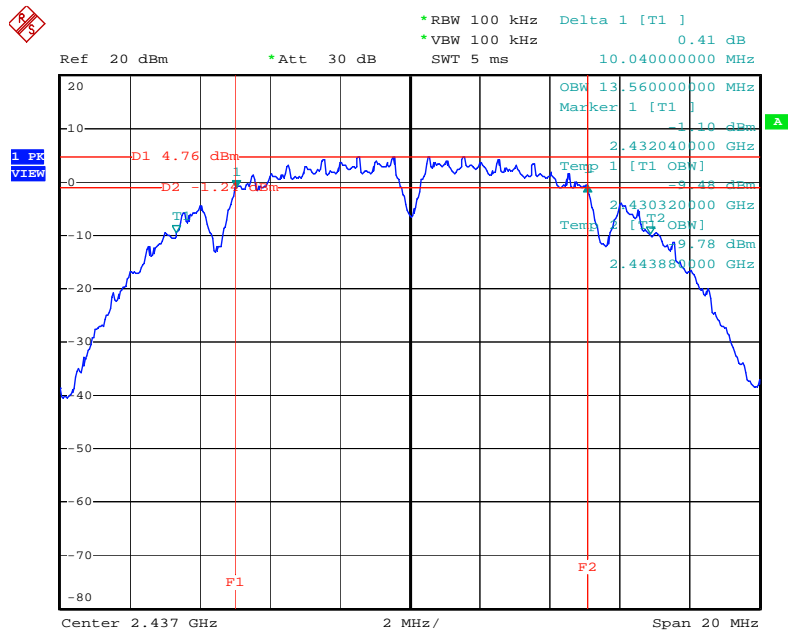

Date: 17.AUG.2006 08:34:20



6 dB Bandwidth Plot on Configuration IEEE 802.11b 20MHz Ant. A / 2462 MHz

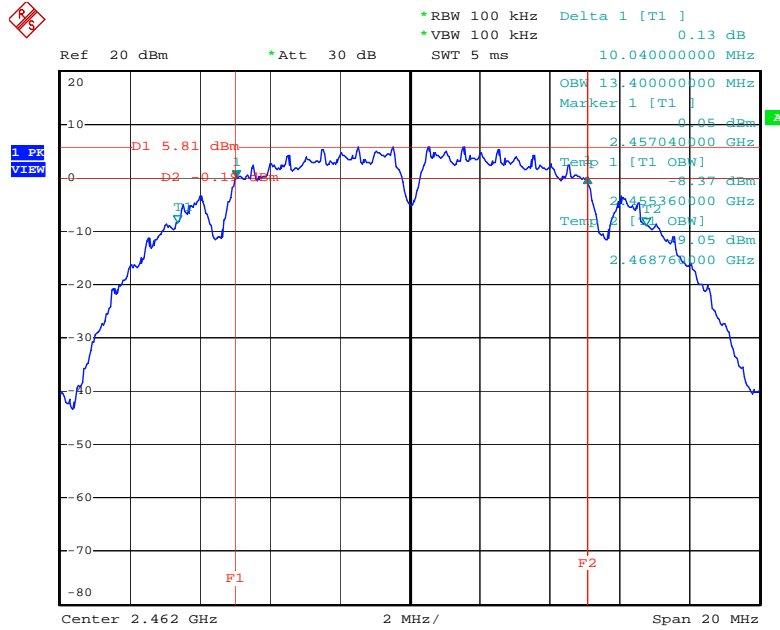

Date: 17.AUG.2006 08:32:03

6 dB Bandwidth Plot on Configuration IEEE 802.11b 20MHz Ant. A + Ant. B / 2412 MHz

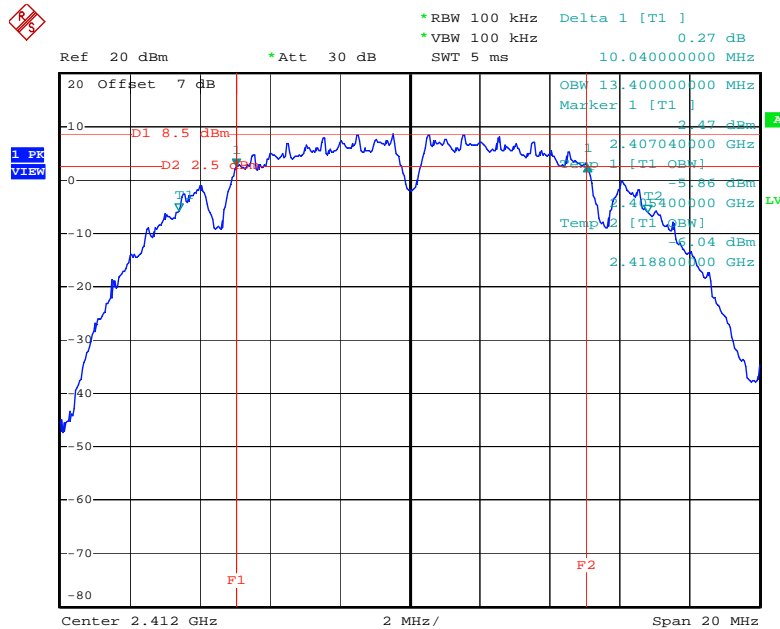

Date: 17.AUG.2006 04:41:15

6 dB Bandwidth Plot on Configuration IEEE 802.11b 20MHz Ant. A + Ant. B / 2437 MHz

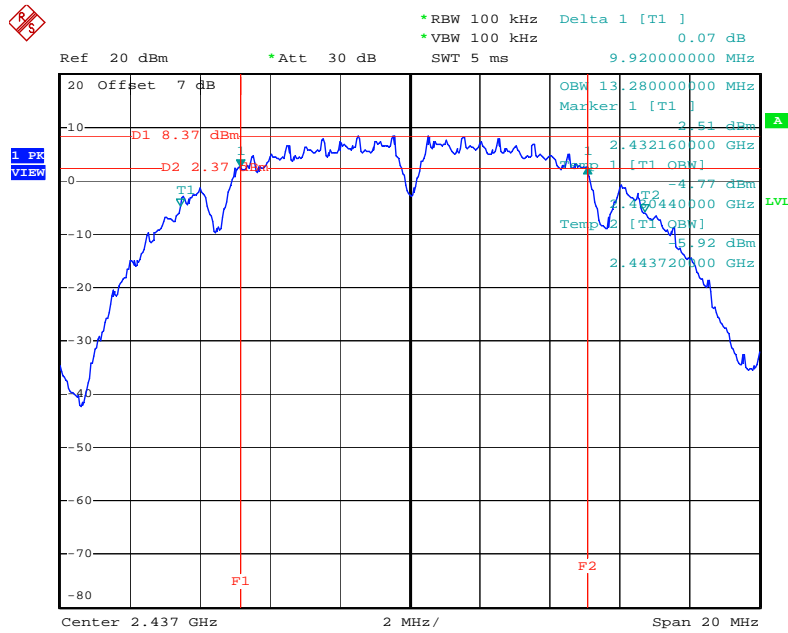

Date: 17.AUG.2006 04:46:46

6 dB Bandwidth Plot on Configuration IEEE 802.11b 20MHz Ant. A + Ant. B / 2462 MHz

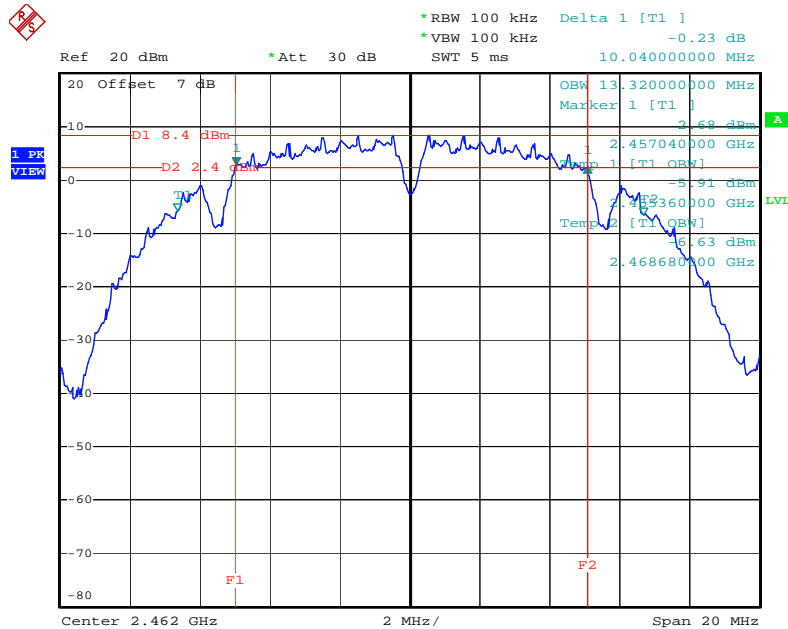

Date: 17.AUG.2006 04:51:42

6 dB Bandwidth Plot on Configuration IEEE 802.11b 40MHz Ant. A / 2422 MHz

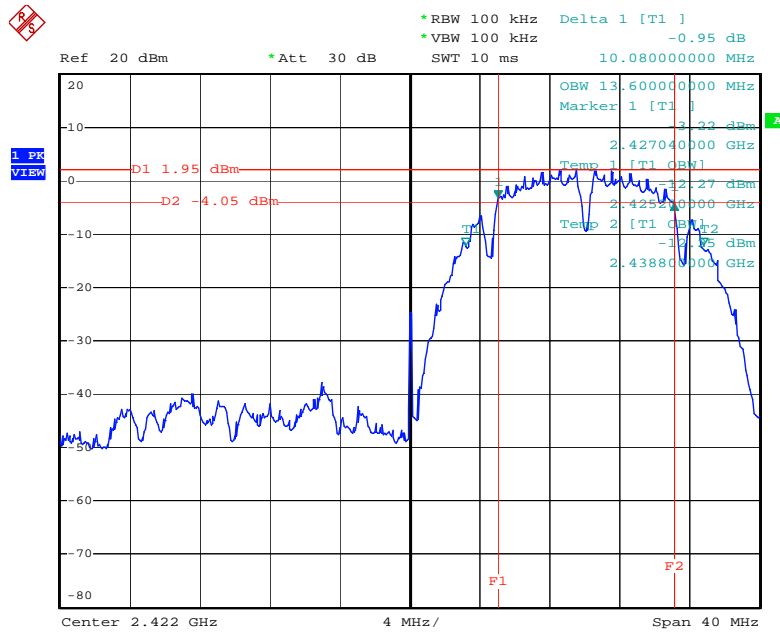

Date: 17.AUG.2006 08:48:13

6 dB Bandwidth Plot on Configuration IEEE 802.11b 40MHz Ant. A / 2437 MHz (Lower)

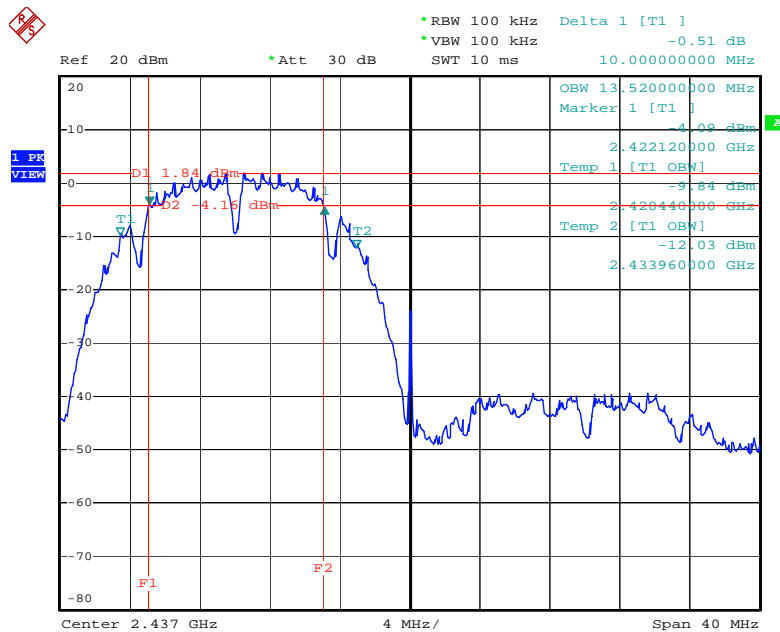

Date: 17.AUG.2006 08:53:17

6 dB Bandwidth Plot on Configuration IEEE 802.11b 40MHz Ant. A / 2437 MHz (Upper)

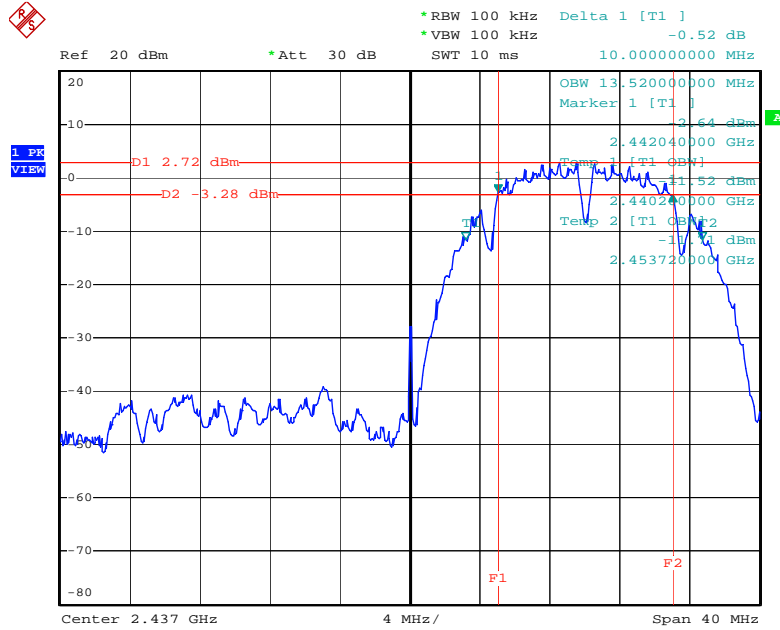

Date: 17.AUG.2006 08:52:10

6 dB Bandwidth Plot on Configuration IEEE 802.11b 40MHz Ant. A / 2452 MHz

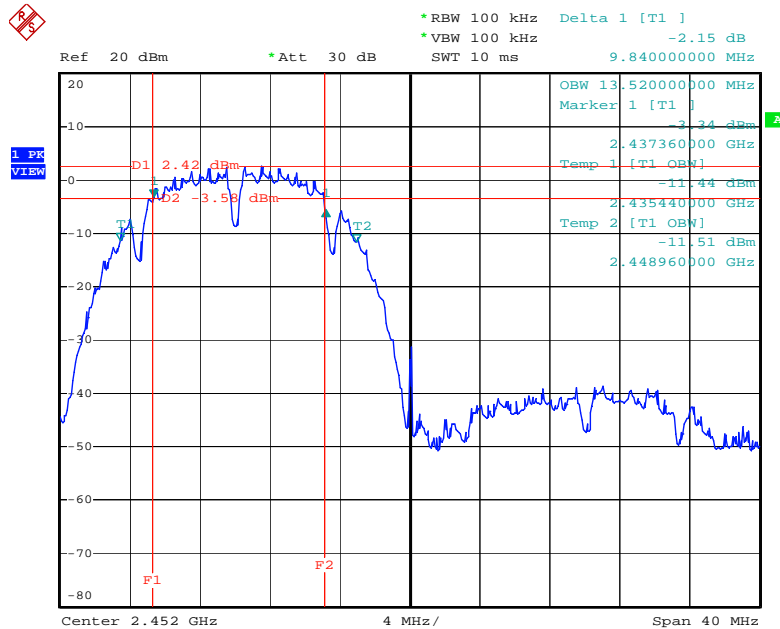

Date: 17.AUG.2006 08:55:46

6 dB Bandwidth Plot on Configuration IEEE 802.11b 40MHz Ant. A + Ant. B / 2422 MHz

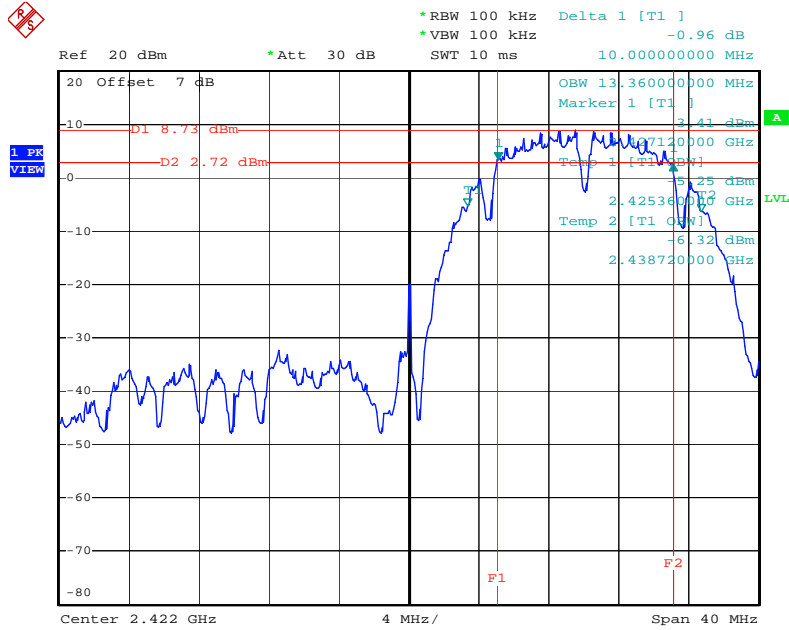

Date: 17.AUG.2006 04:58:20

6 dB Bandwidth Plot on Configuration IEEE 802.11b 40MHz Ant. A + Ant. B / 2437 MHz (Lower)

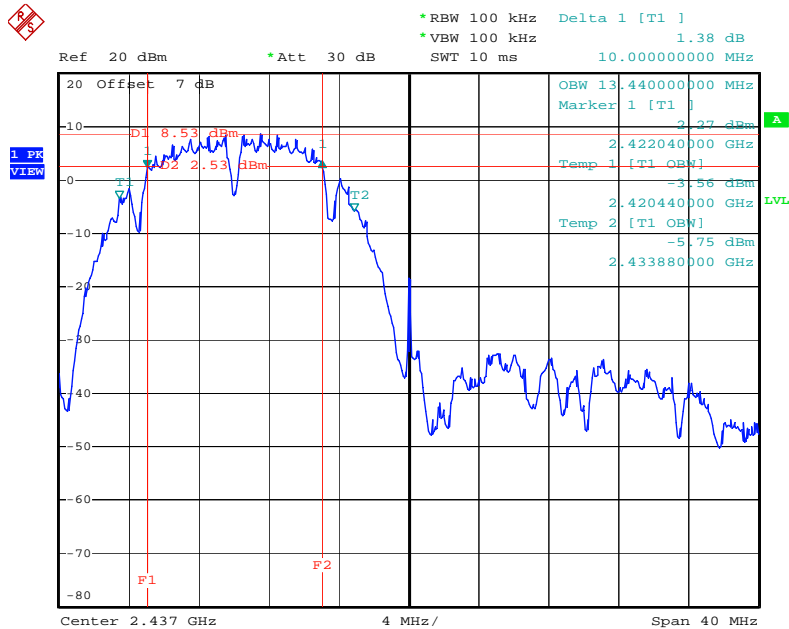

Date: 17.AUG.2006 05:18:03

6 dB Bandwidth Plot on Configuration IEEE 802.11b 40MHz Ant. A + Ant. B / 2437 MHz (Upper)

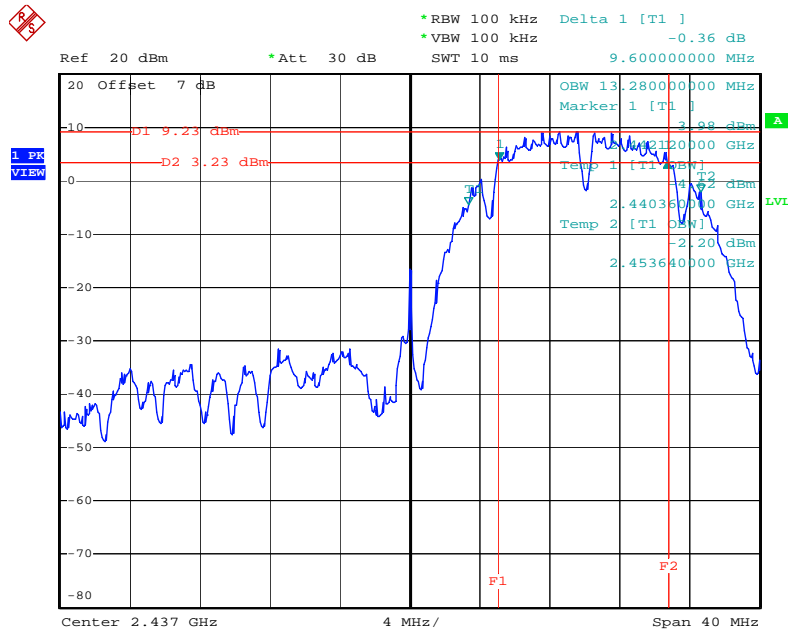

Date: 17.AUG.2006 05:16:13

6 dB Bandwidth Plot on Configuration IEEE 802.11b 40MHz Ant. A + Ant. B / 2452 MHz

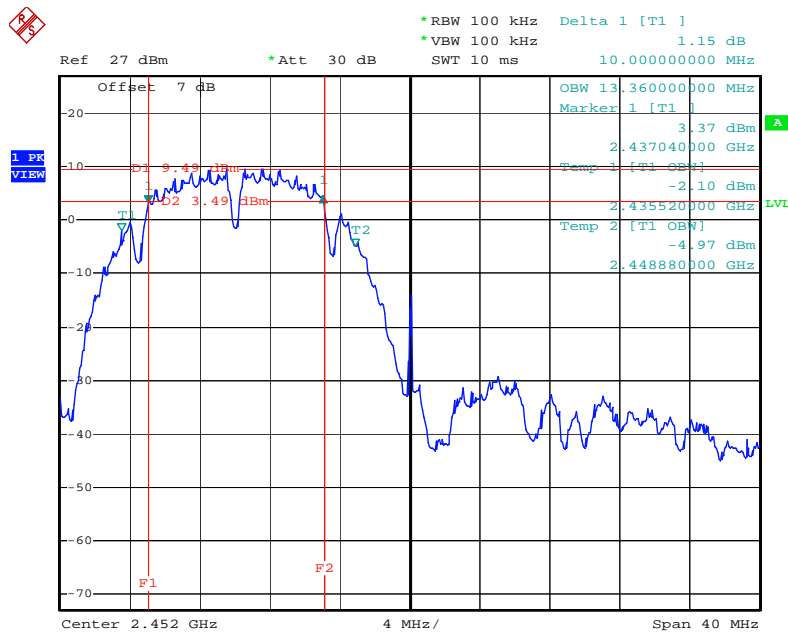

Date: 17.AUG.2006 10:38:05

6 dB Bandwidth Plot on Configuration IEEE 802.11g 20MHz Ant. A / 2412 MHz

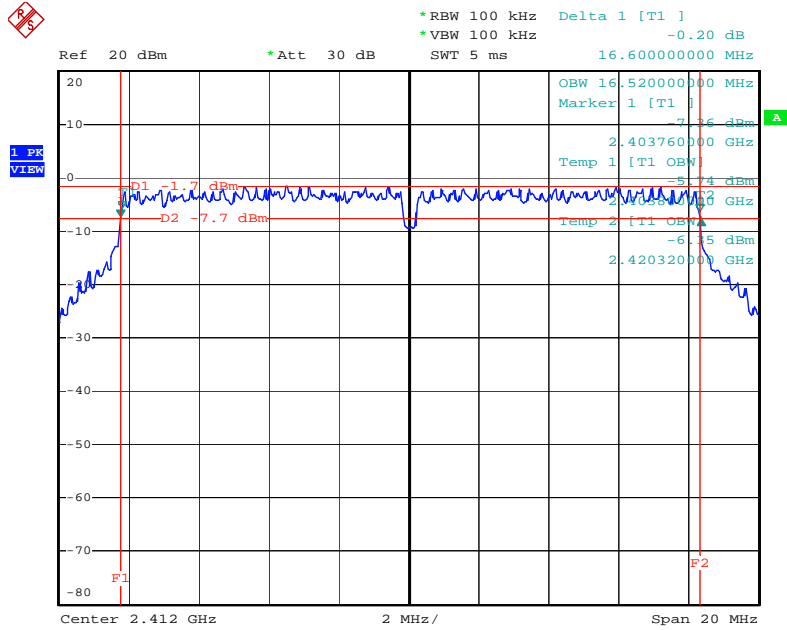

Date: 17.AUG.2006 09:18:21

6 dB Bandwidth Plot on Configuration IEEE 802.11g 20MHz Ant. A / 2437 MHz

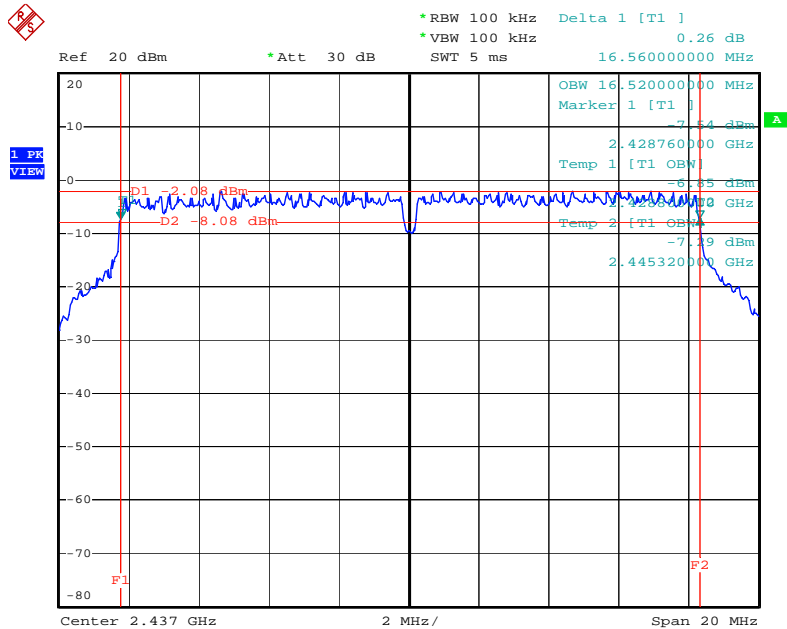

Date: 17.AUG.2006 09:43:15

6 dB Bandwidth Plot on Configuration IEEE 802.11g 20MHz Ant. A / 2462 MHz

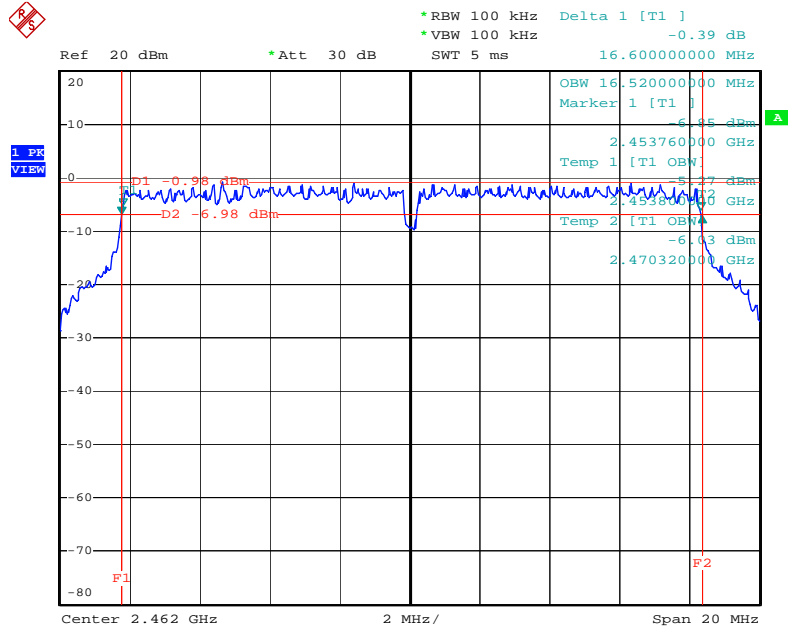

Date: 17.AUG.2006 09:36:07

6 dB Bandwidth Plot on Configuration IEEE 802.11g 20MHz Ant. A + Ant. B / 2412 MHz

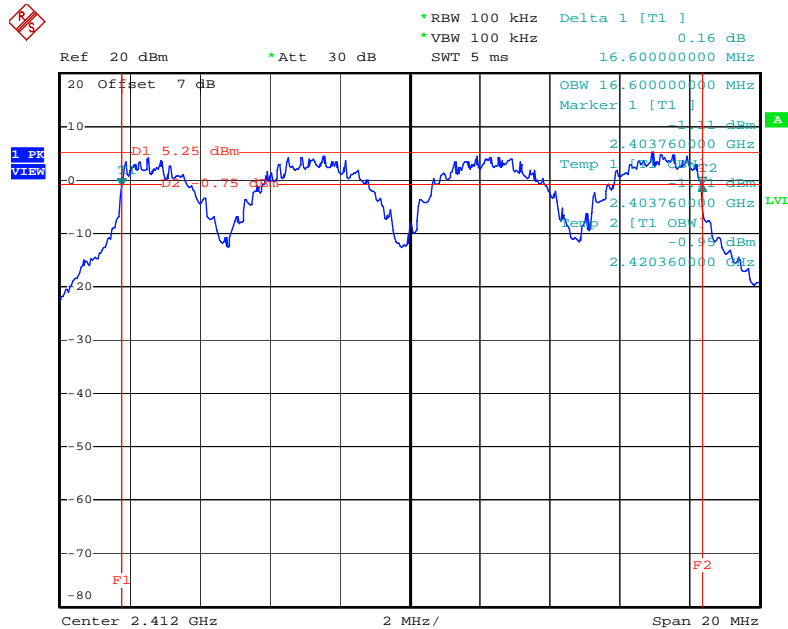

Date: 17.AUG.2006 05:42:33



6 dB Bandwidth Plot on Configuration IEEE 802.11g 20MHz Ant. A + Ant. B / 2437 MHz

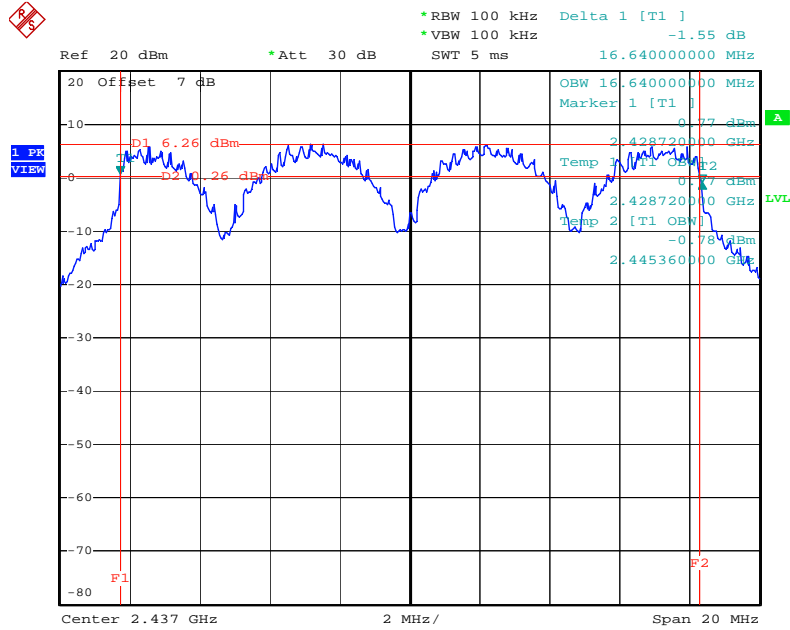

Date: 17.AUG.2006 05:47:17

6 dB Bandwidth Plot on Configuration IEEE 802.11g 20MHz Ant. A + Ant. B / 2462 MHz

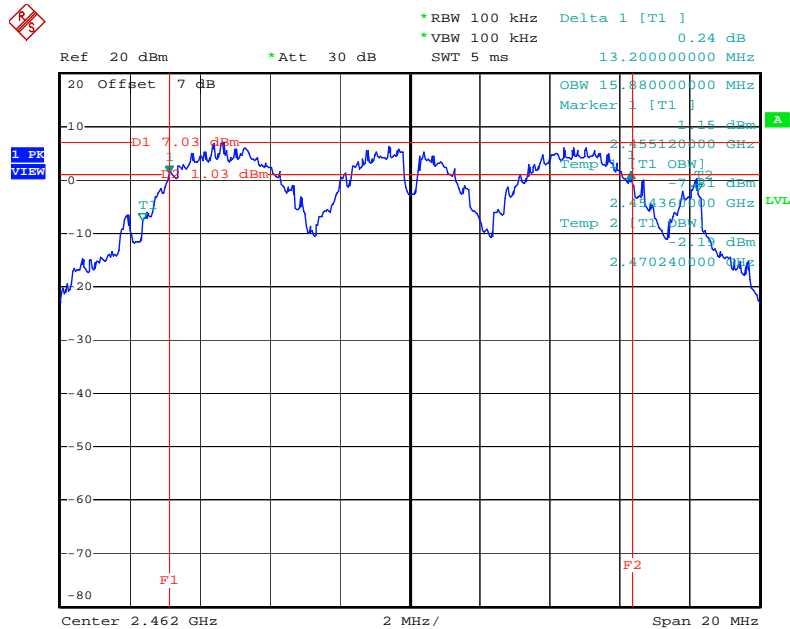

Date: 17.AUG.2006 05:49:14

6 dB Bandwidth Plot on Configuration IEEE 802.11g 40MHz Ant. A / 2422 MHz

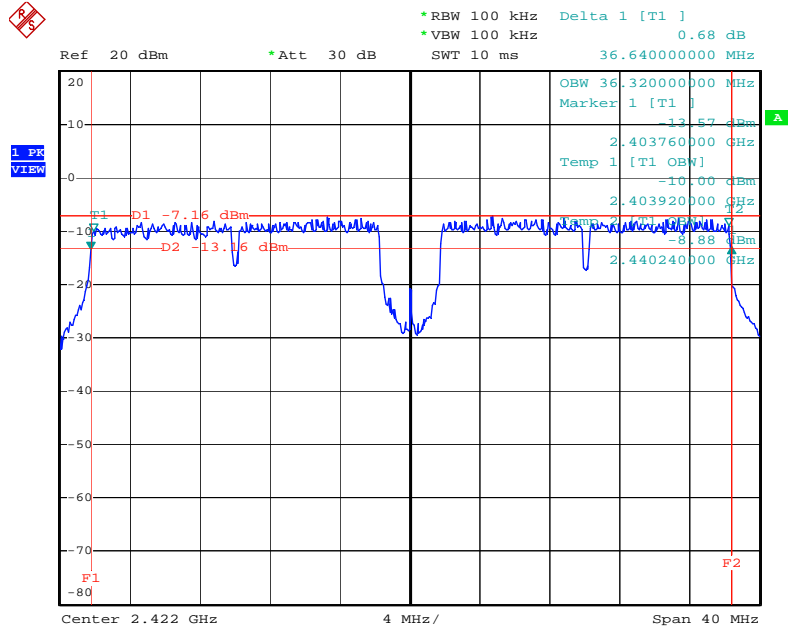

Date: 17.AUG.2006 09:04:57

6 dB Bandwidth Plot on Configuration IEEE 802.11g 40MHz Ant. A / 2437 MHz

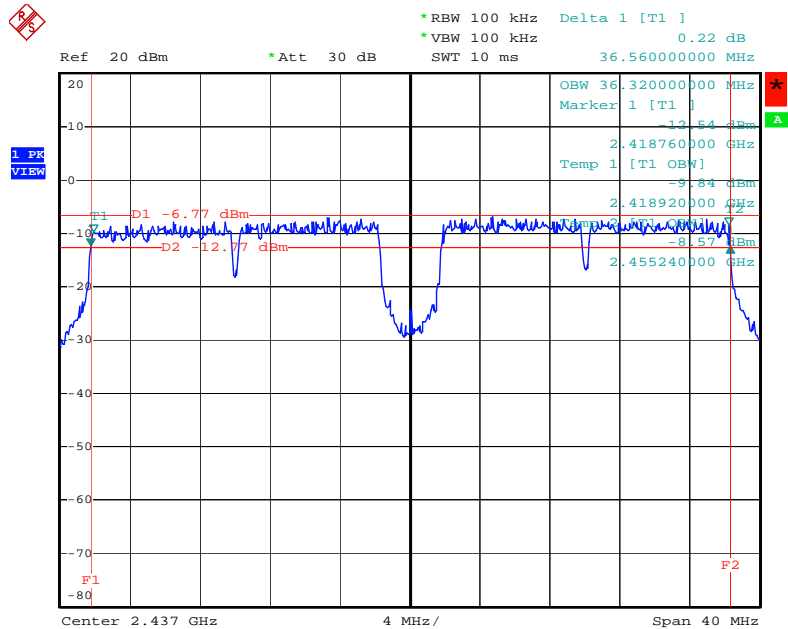

Date: 17.AUG.2006 09:08:56

6 dB Bandwidth Plot on Configuration IEEE 802.11g 40MHz Ant. A / 2452 MHz

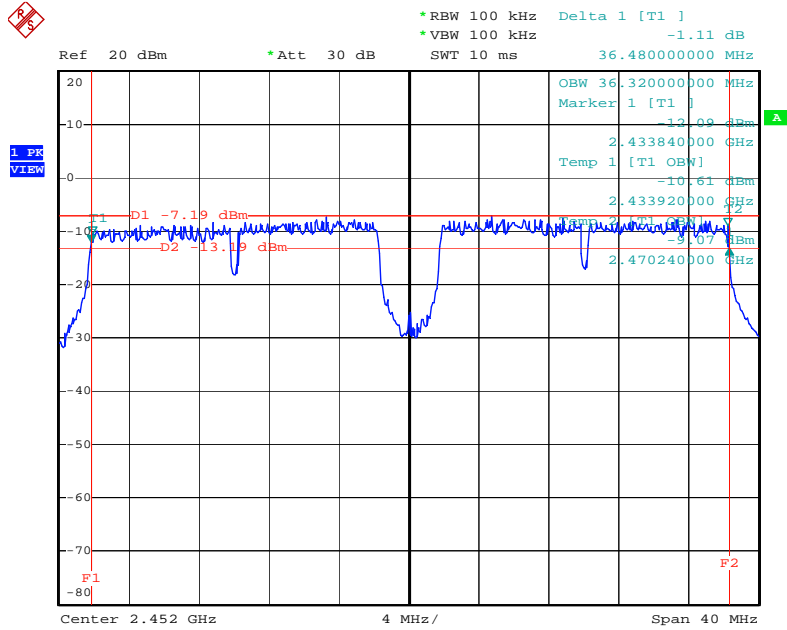

Date: 17.AUG.2006 09:09:54

6 dB Bandwidth Plot on Configuration IEEE 802.11g 40MHz Ant. A + Ant. B / 2422 MHz

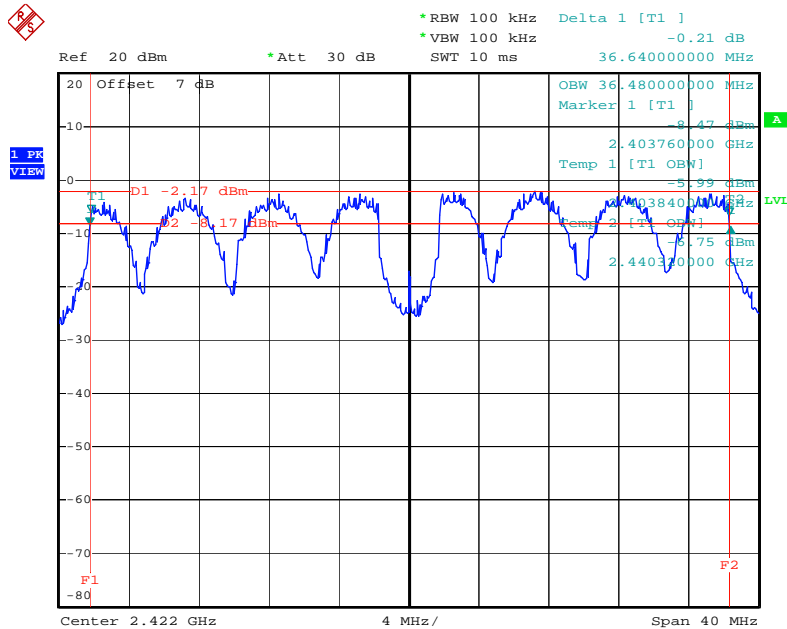

Date: 17.AUG.2006 05:24:16

6 dB Bandwidth Plot on Configuration IEEE 802.11g 40MHz Ant. A + Ant. B / 2437 MHz

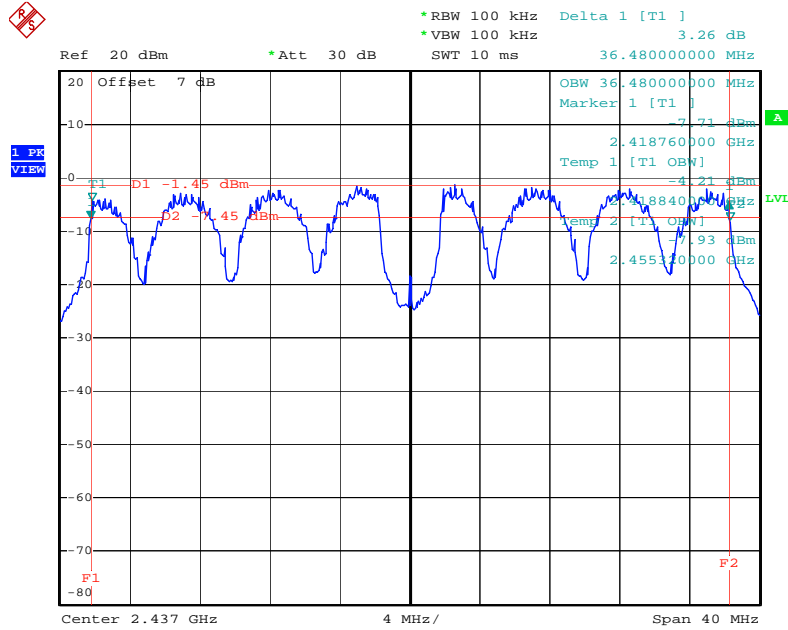

Date: 17.AUG.2006 05:37:15

6 dB Bandwidth Plot on Configuration IEEE 802.11g 40MHz Ant. A + Ant. B / 2452 MHz

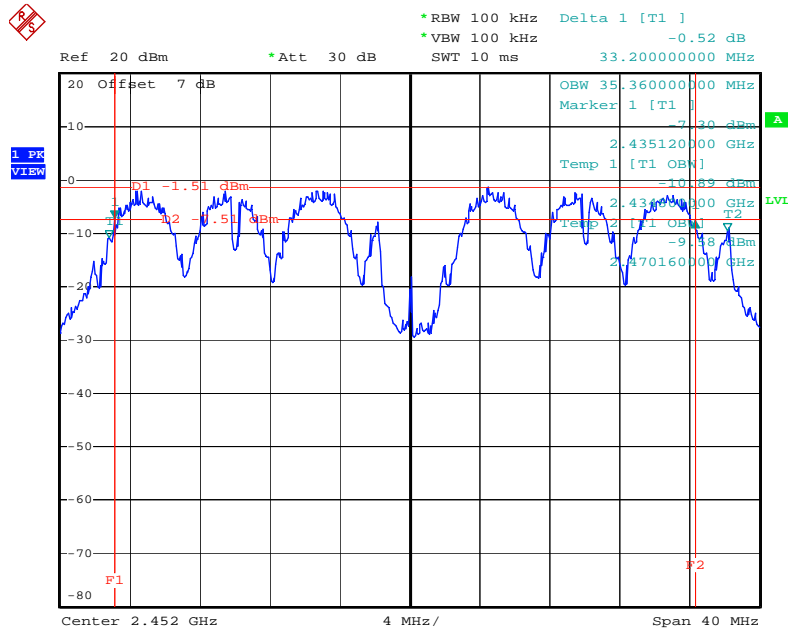

Date: 17.AUG.2006 05:28:50

## 4.5. Radiated Emissions Measurement

### 4.5.1. Limit

20dBc in any 100 kHz bandwidth outside the operating frequency band. In case the emission fall within the restricted band specified on 15.205(a), then the 15.209(a) limit in the table below has to be followed.

Frequencies (MHz)	Field Strength (micorvolts/meter)	Measurement Distance (meters)
0.009~0.490	2400/F(KHz)	300
0.490~1.705	24000/F(KHz)	30
1.705~30.0	30	30
30~88	100	3
88~216	150	3
216~960	200	3
Above 960	500	3

### 4.5.2. Measuring Instruments and Setting

Please refer to section 5 of equipments list in this report. The following table is the setting of spectrum analyzer and receiver.

Spectrum Parameter	Setting
Attenuation	Auto
Start Frequency	1000 MHz
Stop Frequency	10th carrier harmonic
RB / VB (Emission in restricted band)	1MHz / 1MHz for Peak, 1 MHz / 10Hz for Average
RB / VB (Emission in non-restricted band)	100KHz / 100KHz for peak

Receiver Parameter	Setting
Attenuation	Auto
Start ~ Stop Frequency	9kHz~150kHz / RB 200Hz for QP
Start ~ Stop Frequency	150kHz~30MHz / RB 9kHz for QP
Start ~ Stop Frequency	30MHz~1000MHz / RB 120kHz for QP

#### 4.5.3. Test Procedures

1. Configure the EUT according to ANSI C63.4. The EUT was placed on the top of the turntable 0.8 meter above ground. The phase center of the receiving antenna mounted on the top of a height-variable antenna tower was placed 3 meters far away from the turntable.
2. Power on the EUT and all the supporting units. The turntable was rotated by 360 degrees to determine the position of the highest radiation.
3. The height of the broadband receiving antenna was varied between one meter and four meters above ground to find the maximum emissions field strength of both horizontal and vertical polarization.
4. For each suspected emissions, the antenna tower was scan (from 1 M to 4 M) and then the turntable was rotated (from 0 degree to 360 degrees) to find the maximum reading.
5. Set the test-receiver system to Peak or CISPR quasi-peak Detect Function with specified bandwidth under Maximum Hold Mode.
6. For emissions above 1GHz, use 1MHz VBW and RBW for peak reading. Then 1MHz RBW and 10Hz VBW for average reading in spectrum analyzer.
7. When the radiated emissions limits are expressed in terms of the average value of the emissions, and pulsed operation is employed, the measurement field strength shall be determined by averaging over one complete pulse train, including blanking intervals, as long as the pulse train does not exceed 0.1 seconds. As an alternative (provided the transmitter operates for longer than 0.1 seconds) or in cases where the pulse train exceeds 0.1 seconds, the measured field strength shall be determined from the average absolute voltage during a 0.1 second interval during which the field strength is at its maximum value.
8. If the emissions level of the EUT in peak mode was 3 dB lower than the average limit specified, then testing will be stopped and peak values of EUT will be reported, otherwise, the emissions which do not have 3 dB margin will be repeated one by one using the quasi-peak method for below 1GHz.
9. For testing above 1GHz, the emissions level of the EUT in peak mode was lower than average limit (that means the emissions level in peak mode also complies with the limit in average mode), then testing will be stopped and peak values of EUT will be reported, otherwise, the emissions will be measured in average mode again and reported.
10. In case the emission is lower than 30MHz, loop antenna has to be used for measurement and the recorded data should be QP measured by receiver. High – Low scan is not required in this case.

#### 4.5.4. Test Setup Layout

For radiated emissions below 30MHz

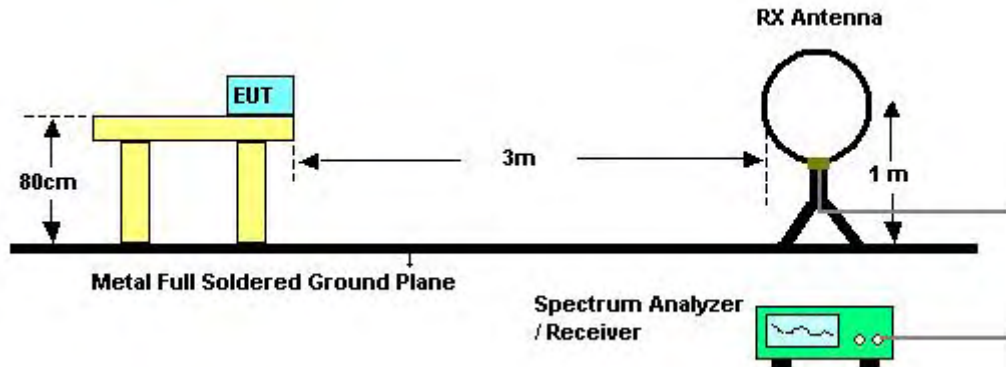

For radiated emissions above 30MHz

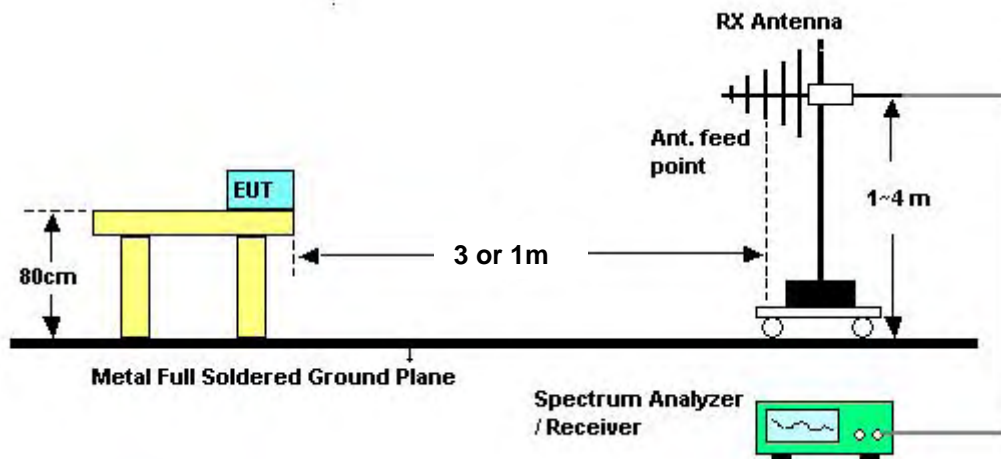

Above 10 GHz shall be extrapolated to the specified distance using an extrapolation factor of 20 dB/decade from 3m to 1m.

Distance extrapolation factor =  $20 \log (\text{specific distance [3m]} / \text{test distance [1m]})$  (dB);

Limit line = specific limits (dBuV) + distance extrapolation factor [9.54 dB].

#### 4.5.5. Test Deviation

There is no deviation with the original standard.

#### 4.5.6. EUT Operation during Test

The EUT was programmed to be in continuously transmitting mode.

#### 4.5.7. Results of Radiated Emissions (9kHz~30MHz)

<b>Temperature</b>	24°C	<b>Humidity</b>	64%
<b>Test Engineer</b>	Leo Hung	<b>Configurations</b>	802.11g 40MHz Channel 6

Freq. (MHz)	Level (dBuV)	Over Limit (dB)	Limit Line (dBuV)	Remark
-	-	-	-	See Note

Note:

The amplitude of spurious emissions which are attenuated by more than 20 dB below the permissible value has no need to be reported.

Distance extrapolation factor =  $40 \log(\text{specific distance} / \text{test distance})$  (dB);

Limit line = specific limits (dBuV) + distance extrapolation factor.



4.5.8. Results of Radiated Emissions (30MHz~1GHz)

Temperature	24°C	Humidity	64%
Test Engineer	Leo Hung	Configurations	802.11g 40MHz Channel 6 Ant. A

Vertical

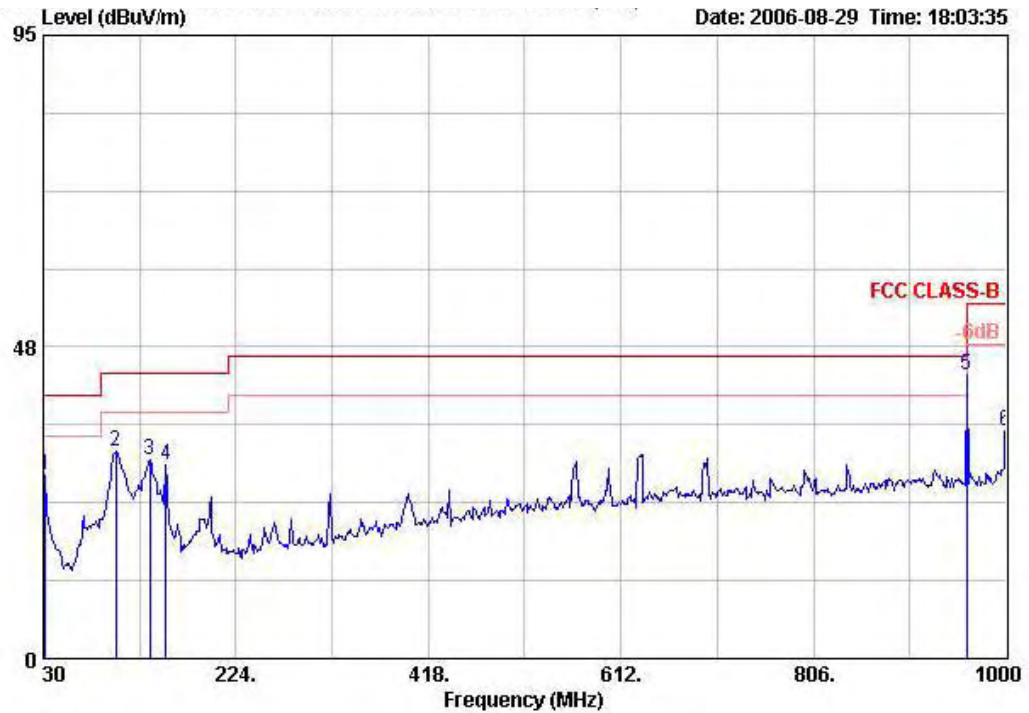

	Freq	Level	Over	Limit	Read	Cable	Preamp	Remark	Ant	TableAntenna
	MHz	dBuV/m	Limit	Line	Level	Loss	Factor		Pos	Pos Factor
			dB	dBuV/m	dBuV	dB	dB		cm	deg dB/m
1	31.940	28.06	-11.94	40.00	40.15	0.93	31.67	Peak	---	18.66
2	102.750	31.54	-11.96	43.50	50.08	1.50	31.72	Peak	---	11.68
3	137.670	30.22	-13.28	43.50	48.17	1.70	31.59	Peak	---	11.94
4	153.190	29.48	-14.02	43.50	48.09	1.90	31.53	Peak	---	11.02
5 !	959.966	43.27	-2.73	46.00	46.90	3.92	29.49	QP	---	21.94
6	1000.000	34.63	-19.37	54.00	37.90	4.00	29.37	Peak	---	22.10

Horizontal

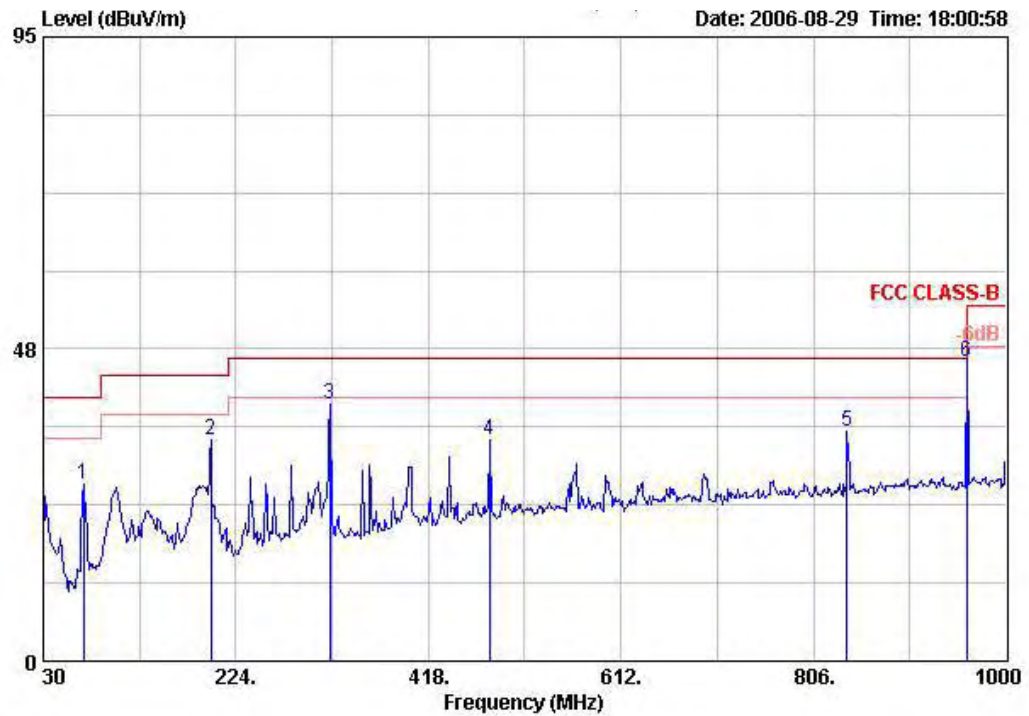

	Freq	Level	Over Limit	Limit Line	Read Level	Cable Loss	Preamp Factor	Remark	Ant Pos	Table Antenna Pos	Antenna Factor
	MHz	dBuV/m	dB	dBuV/m	dBuV	dB	dB		cm	deg	dB/m
1	70.740	26.95	-13.05	40.00	50.57	1.43	31.74	Peak	---	---	6.69
2	198.780	33.77	-9.73	43.50	53.08	2.00	31.45	Peak	---	---	10.14
3	319.060	39.10	-6.90	46.00	53.57	2.28	31.29	Peak	---	---	14.54
4	479.110	33.58	-12.42	46.00	43.78	3.13	30.93	Peak	---	---	17.60
5	839.950	34.82	-11.18	46.00	39.81	3.96	30.13	Peak	---	---	21.18
6	959.966	45.65	-0.35	46.00	49.28	3.92	29.49	QP	---	---	21.94

Note:

The amplitude of spurious emissions which are attenuated by more than 20 dB below the permissible value has no need to be reported.

Emission level (dBUV/m) = 20 log Emission level (uV/m).

Corrected Reading: Antenna Factor + Cable Loss + Read Level - Preamp Factor = Level.

Temperature	24°C	Humidity	64%
Test Engineer	Leo Hung	Configurations	802.11g Channel 6 Ant. A + Ant. B

Vertical

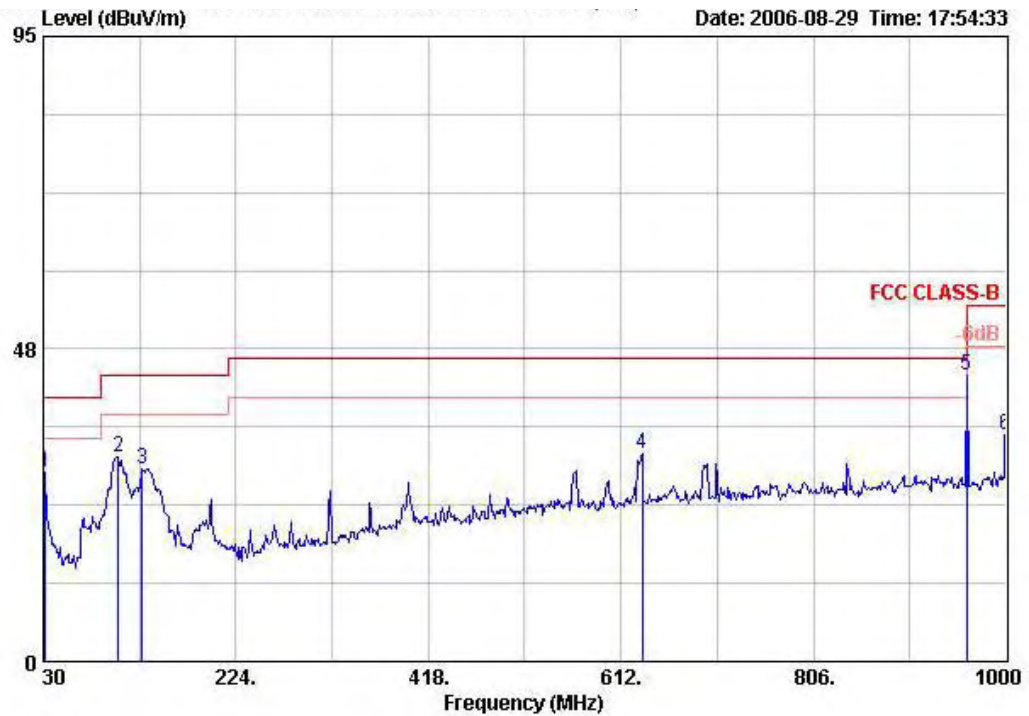

	Freq	Level	Over Limit	Limit Line	Read Level	Cable Loss	Preamp Factor	Remark	Ant Pos	Table Antenna Pos	Antenna Factor
	MHz	dBuV/m	dB	dBuV/m	dBuV	dB	dB		cm	deg	dB/m
1	31.940	28.65	-11.35	40.00	40.74	0.93	31.67	Peak	---	---	18.66
2	105.660	31.17	-12.33	43.50	49.23	1.50	31.72	Peak	---	---	12.16
3	129.910	29.31	-14.19	43.50	46.78	1.70	31.67	Peak	---	---	12.50
4	633.340	31.64	-14.36	46.00	39.30	3.36	30.45	Peak	---	---	19.43
5 !	959.966	43.57	-2.43	46.00	47.20	3.92	29.49	QP	---	---	21.94
6	1000.000	34.34	-19.66	54.00	37.61	4.00	29.37	Peak	---	---	22.10

Horizontal

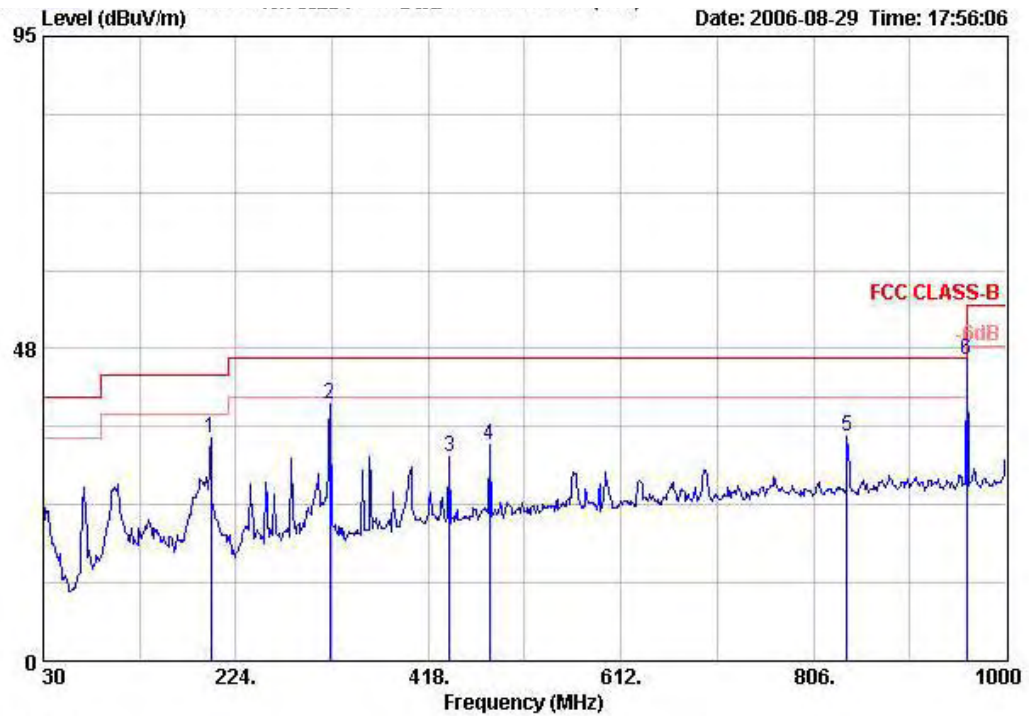

	Freq	Level	Over Limit	Limit Line	Read Level	Cable Loss	Preamp Factor	Remark	Ant Pos	Table Antenna Pos	Antenna Factor
	MHz	dBuV/m	dB	dBuV/m	dBuV	dB	dB		cm	deg	dB/m
1	198.780	33.97	-9.53	43.50	53.28	2.00	31.45	Peak	---	---	10.14
2	319.060	39.18	-6.82	46.00	53.65	2.28	31.29	Peak	---	---	14.54
3	439.340	31.19	-14.81	46.00	42.20	2.86	30.94	Peak	---	---	17.07
4	479.110	32.93	-13.07	46.00	43.12	3.13	30.93	Peak	---	---	17.60
5	839.950	34.28	-11.72	46.00	39.27	3.96	30.13	Peak	---	---	21.18
6	960.230	45.72	-8.28	54.00	49.35	3.92	29.49	Peak	---	---	21.94

Note:

The amplitude of spurious emissions which are attenuated by more than 20 dB below the permissible value has no need to be reported.

Emission level (dBUV/m) = 20 log Emission level (uV/m).

Corrected Reading: Antenna Factor + Cable Loss + Read Level - Preamp Factor = Level.