



FCC Radio Test Report

FCC ID: KA2SL6740BC2

This report concerns (check one) : Original Grant Class II Change

Issued Date : Jun. 07, 2013
Project No. : 1303C007
Equipment : Wireless VDSL2 4-port Ethernet Router
Model Name : DSL-6740B
Applicant : D-link Corporation
Address : 17595 Mt. Herrmann Fountain Valley California
United States
Manufacturer : D-link Corporation
Address : No.289, Sinhu 3rd Rd., Neihu District Taipei City
114, Taiwan, R.O.C

Tested by:
Neutron Engineering Inc. EMC Laboratory
Date of Receipt: Mar. 11, 2013
Date of Test:
Mar. 11, 2013~ Jun. 06, 2013

Testing Engineer : David Mao
(David Mao)
Technical Manager : Leo Hung
(Leo Hung)
Authorized Signatory : Steven Lu
(Steven Lu)

Neutron Engineering Inc.

**No.3, Jinshagang 1st Road, ShiXia, Dalang
Town, Dong Guan, China.
TEL : (0769) 8318-3000 FAX : (0769) 8319-6000**



Declaration

Neutron represents to the client that testing is done in accordance with standard procedures as applicable and that test instruments used has been calibrated with the standards traceable to National Measurement Laboratory (**NML**) of **R.O.C.**, or National Institute of Standards and Technology (**NIST**) of **U.S.A.**

Neutron's reports apply only to the specific samples tested under conditions. It is manufacture's responsibility to ensure that additional production units of this model are manufactured with the identical electrical and mechanical components. **Neutron** shall have no liability for any declarations, inferences or generalizations drawn by the client or others from **Neutron** issued reports.

Neutron's reports must not be used by the client to claim product endorsement by the authorities or any agency of the Government.

This report is the confidential property of the client. As a mutual protection to the clients, the public and **Neutron-self**, extracts from the test report shall not be reproduced except in full with **Neutron's** authorized written approval.

Neutron's laboratory quality assurance procedures are in compliance with the **ISO Guide 17025** requirements, and accredited by the conformity assessment authorities listed in this test report.

Limitation

For the use of the authority's logo is limited unless the Test Standard(s)/Scope(s)/Item(s) mentioned in this test report is (are) included in the conformity assessment authorities acceptance respective.



Table of Contents	Page
1 . CERTIFICATION	5
2 . SUMMARY OF TEST RESULTS	6
2.1 TEST FACILITY	7
2.2 MEASUREMENT UNCERTAINTY	7
3 . GENERAL INFORMATION	8
3.1 GENERAL DESCRIPTION OF EUT	8
3.2 DESCRIPTION OF TEST MODES	10
3.3 TABLE OF PARAMETERS OF TEXT SOFTWARE SETTING	11
3.4 BLOCK DIAGRAM SHOWING THE CONFIGURATION OF SYSTEM TESTED	12
3.5 DESCRIPTION OF SUPPORT UNITS	13
4 . EMC EMISSION TEST	14
4.1 CONDUCTED EMISSION MEASUREMENT	14
4.1.1 POWER LINE CONDUCTED EMISSION LIMITS	14
4.1.2 MEASUREMENT INSTRUMENTS LIST AND SETTING	14
4.1.3 TEST PROCEDURE	15
4.1.4 DEVIATION FROM TEST STANDARD	15
4.1.5 TEST SETUP	15
4.1.6 EUT OPERATING CONDITIONS	15
4.1.7 TEST RESULTS	16
4.2 RADIATED EMISSION MEASUREMENT	23
4.2.1 RADIATED EMISSION LIMITS	23
4.2.2 MEASUREMENT INSTRUMENTS LIST AND SETTING	24
4.2.3 TEST PROCEDURE	25
4.2.4 DEVIATION FROM TEST STANDARD	25
4.2.5 TEST SETUP	26
4.2.6 EUT OPERATING CONDITIONS	27
4.2.7 TEST RESULTS (9K~ 30MHZ)	28
4.2.8 TEST RESULTS (BETWEEN 30 – 1000 MHZ)	29
4.2.9 TEST RESULTS (ABOVE 1000 MHZ)	48
5 . BANDWIDTH TEST	96
5.1 APPLIED PROCEDURES / LIMIT	96
5.1.1 MEASUREMENT INSTRUMENTS LIST	96
5.1.2 TEST PROCEDURE	96
5.1.3 DEVIATION FROM STANDARD	96
5.1.4 TEST SETUP	96
5.1.5 EUT OPERATION CONDITIONS	96
5.1.6 TEST RESULTS	97



Table of Contents	Page
6 . MAXIMUM OUTPUT POWER TEST	109
6.1 APPLIED PROCEDURES / LIMIT	109
6.1.1 MEASUREMENT INSTRUMENTS LIST	109
6.1.2 TEST PROCEDURE	109
6.1.3 DEVIATION FROM STANDARD	109
6.1.4 TEST SETUP	109
6.1.5 EUT OPERATION CONDITIONS	109
6.1.6 TEST RESULTS	110
7 . ANTENNA CONDUCTED SPURIOUS EMISSION	113
7.1 APPLIED PROCEDURES / LIMIT	113
7.1.1 MEASUREMENT INSTRUMENTS LIST	113
7.1.2 TEST PROCEDURE	113
7.1.3 DEVIATION FROM STANDARD	113
7.1.4 TEST SETUP	113
7.1.5 EUT OPERATION CONDITIONS	113
7.1.6 TEST RESULTS	114
8 . POWER SPECTRAL DENSITY TEST	144
8.1 APPLIED PROCEDURES / LIMIT	144
8.1.1 MEASUREMENT INSTRUMENTS LIST	144
8.1.2 TEST PROCEDURE	144
8.1.3 DEVIATION FROM STANDARD	144
8.1.4 TEST SETUP	144
8.1.5 EUT OPERATION CONDITIONS	144
8.1.6 TEST RESULTS	145
9 . EUT TEST PHOTO	159



1. CERTIFICATION

Equipment : Wireless VDSL2 4-port Ethernet Router
Brand Name : D-Link
Model Name : DSL-6740B
Applicant : D-link Corporation
Factory : SHANGHAI CHONGZHENG ELECTRONICS TECHNOLOGY CO.,LTD
Address : NO.178 Renqing Road,Pudong,Shanghai.
Date of Test : Mar. 11, 2013~ Jun. 06, 2013
Test Item : ENGINEERING SAMPLE
Standards : FCC Part15, Subpart C(15.247) / ANSI C63.4-2009

The above equipment has been tested and found compliance with the requirement of the relative standards by Neutron Engineering Inc. EMC Laboratory.

The test data, data evaluation, and equipment configuration contained in our test report (Ref No. NEI-FCCP-1-1303C007) were obtained utilizing the test procedures, test instruments, test sites that has been accredited by the Authority of TAF according to the ISO-17025 quality assessment standard and technical standard(s).



2. SUMMARY OF TEST RESULTS

Test procedures according to the technical standards:

FCC Part15 (15.247) , Subpart C				
Standard	Section	Test Item	Judgment	Remark
	15.207	Conducted Emission	PASS	
	15.247(d)	Antenna conducted Spurious Emission	PASS	
	15.247(a)(2)	6dB Bandwidth	PASS	
	15.247(b)(3)	Peak Output Power	PASS	
	15.209/15.205	Radiated Spurious Emission	PASS	
	15.247(e)	Power Spectral Density	PASS	
	15.203	Antenna Requirement	PASS	

NOTE:

- (1) " N/A " denotes test is not applicable in this test report
- (2) The test follows FCC KDB Publication No. 558074 D01 DTS Meas Guidance v03r01 (Measurement Guidelines of DTS)



2.1 TEST FACILITY

The test facilities used to collect the test data in this report is **DG-C02/DG-CB03** at the location of No.3,Jinshagang 1st Road, ShiXia, Dalang Town, Dong Guan, China.523792
 Neutron's test firm number is 319330

2.2 MEASUREMENT UNCERTAINTY

Where relevant, the following measurement uncertainty levels have been estimated for tests performed on the EUT as specified in CISPR 16-4-2:

The reported uncertainty of measurement $y \pm U$ where expanded uncertainty U is based on a standard uncertainty multiplied by a coverage factor of $k=2$, providing a level of confidence of approximately 95 %.

A. Conducted Measurement :

Test Site	Method	Measurement Frequency Range	U , (dB)	NOTE
DG-C02	CISPR	150 KHz ~ 30MHz	1.94	

B. Radiated Measurement :

Test Site	Method	Measurement Frequency Range	Ant. H / V	U , (dB)	NOTE
DG-CB03	CISPR	30MHz ~ 200MHz	V	3.82	
		30MHz ~ 200MHz	H	3.60	
		200MHz ~ 1,000MHz	V	3.86	
		200MHz ~ 1,000MHz	H	3.94	
		1GHz~18GHz	V	3.12	
		1GHz~18GHz	H	3.68	
		18GHz~40GHz	V	4.15	
		18GHz~40GHz	H	4.14	



3. GENERAL INFORMATION

3.1 GENERAL DESCRIPTION OF EUT

Equipment	Wireless VDSL2 4-port Ethernet Router	
Brand Name	D-Link	
Model Name	DSL-6740B	
Model Difference	N/A	
Product Description	The EUT is a Wireless VDSL2 4-port Ethernet Router.	
	Operation Frequency:	2412~2462 MHz
	Modulation Technology:	802.11b:DSSS 802.11g:OFDM 802.11n:OFDM
	Bit Rate of Transmitter:	802.11b:11/5.5/2/1 Mbps 802.11g:54/48/36/24/18/12/9/6 Mbps Draft 802.11n:up to 300Mbps
	Number of Channel:	11 CH, Please see note 2. (Page 9)
	Antenna Designation:	Please see note 3.(Page 9)
	Antenna Gain(Peak):	
	Output Power:	802.11b: 21.58dBm 802.11g: 18.95dBm 802.11n(20MHz): 20.24 dBm 802.11n(40MHz): 17.21dBm
Power Source	DC Voltage supplied from AC/DC adapter. 1# Brand/Model: MOSO / MSP-C1500IC12.0-18W-US 2# Brand/Model: FRECOM/F18W-120150SPAU 3# Brand/Model: RUIDE/RD1201500-C38-1MG	
Power Rating	1# I/P:100-240V~50/60Hz 0.7A max O/P:12V/1.5A 2# I/P:100-240V~50/60Hz 0.6A O/P:12V/1.5A 3# I/P: 100-240V~50/60Hz 0.6A MAX O/P:12V/1.5A	

Note:

1. For a more detailed features description, please refer to the manufacturer's specifications or the User's Manual.



2. CH 01 – CH 11 for 802.11b, 802.11g, 802.11n(20MHz)
CH 03 – CH 09 for 802.11n(40MHz)

Channel List

Channel	Frequency (MHz)	Channel	Frequency (MHz)	Channel	Frequency (MHz)	Channel	Frequency (MHz)
01	2412	04	2427	07	2442	10	2457
02	2417	05	2432	08	2447	11	2462
03	2422	06	2437	09	2452		

3. Table for Filed Antenna

Ant.	Manufacturer	Model Name	Antenna Type	Connector	Gain (dBi)	Note
1	MAG.LAYERS	MSA-2715-2G4C1-A3	Integral Antenna	N/A	3.12	TX/RX
2	MAG.LAYERS	MSA-2715-2G4C1-A3	Integral Antenna	N/A	3.12	TX/RX

Note:

The EUT incorporates a MIMO function. Physically, the EUT provides two completed transmitters and two receivers (2T2R).

- 4.

Operating Mode / TX Mode	1TX	2TX
802.11b	V (ANT 1 or ANT 2)	-
802.11g	V (ANT 1 or ANT 2)	-
802.11n(20MHz)	-	V (ANT 1 & ANT 2)
802.11n(40MHz)	-	V (ANT 1 & ANT 2)



3.2 DESCRIPTION OF TEST MODES

To investigate the maximum EMI emission characteristics generates from EUT, the test system was pre-scanning tested base on the consideration of following EUT operation mode or test configuration mode which possible have effect on EMI emission level. Each of these EUT operation mode(s) or test configuration mode(s) mentioned above was evaluated respectively.

Pretest Mode	Description
Mode 1	TX B MODE CHANNEL 01/06/11
Mode 2	TX G MODE CHANNEL 01/06/11
Mode 3	TX N-20MHZ MODE CHANNEL 01/06/11
Mode 4	TX N-40MHZ MODE CHANNEL 03/06/09
Mode 5	TX Mode

The EUT system operated these modes were found to be the worst case during the pre-scanning test as following:

For Conducted Test	
Final Test Mode	Description
Mode 5	TX Mode

For Radiated Test	
Final Test Mode	Description
Mode 1	TX B MODE CHANNEL 01/06/11
Mode 2	TX G MODE CHANNEL 01/06/11
Mode 3	TX N-20MHZ MODE CHANNEL 01/06/11
Mode 4	TX N-40MHZ MODE CHANNEL 03/06/09

Note:

- (1) The measurements are performed at the high, middle, low available channels.
- (2) 802.11b mode: DBPSK (1Mbps)
 802.11g mode: OFDM (6Mbps)
 802.11n HT20 mode : BPSK (6.5Mbps)
 802.11n HT40 mode : BPSK (13.5Mbps)
 For radiated emission tests, the highest output powers were set for final test.



3.3 TABLE OF PARAMETERS OF TEXT SOFTWARE SETTING

During testing channel & power controlling software provided by the customer was used to control the operating channel as well as the output power level. The RF output power selection is for the setting of RF output power expected by the customer and is going to be fixed on the firmware of the final end product power parameters of WLAN

Test software Version	n/a		
Frequency	2412 MHz	2437 MHz	2462 MHz
IEEE 802.11b DSSS	54	54	54
IEEE 802.11g OFDM	30	30	30

Test software Version	n/a		
Frequency (MHz)	2412 MHz	2437 MHz	2462 MHz
IEEE 802.11n (20MHz)	38	38	38
Frequency (MHz)	2422 MHz	2437 MHz	2452 MHz
IEEE 802.11n (40MHz)	30	30	30



3.4 BLOCK DIAGRAM SHOWING THE CONFIGURATION OF SYSTEM TESTED

Conducted Mode:

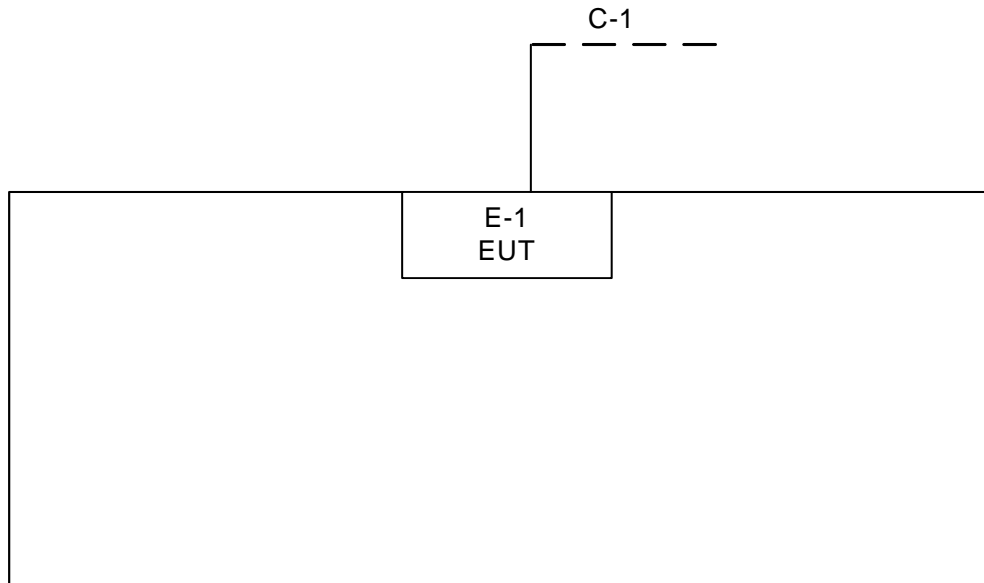

Radiated TX Mode:

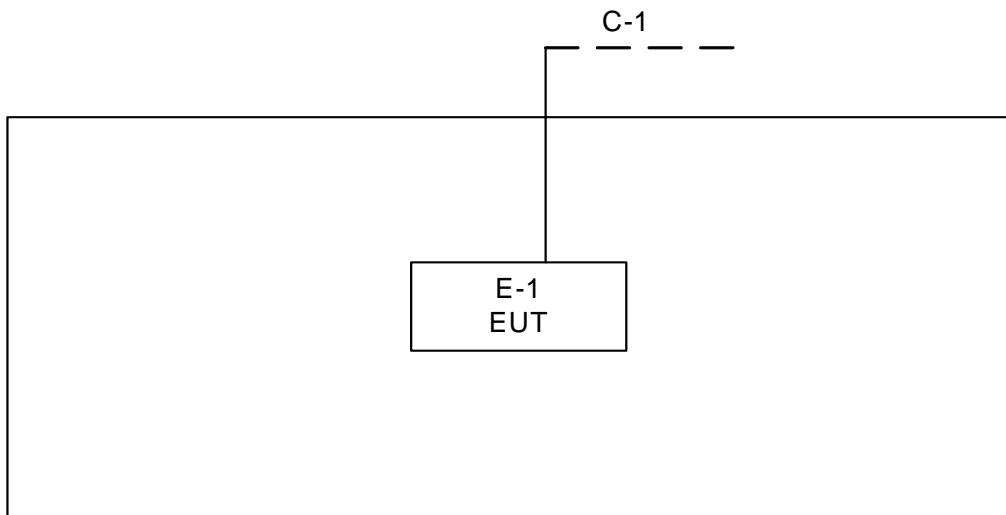

Control Room

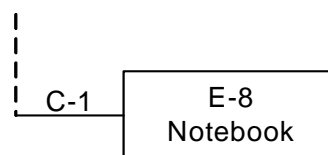



3.5 DESCRIPTION OF SUPPORT UNITS

The EUT has been tested as an independent unit together with other necessary accessories or support units. The following support units or accessories were used to form a representative test configuration during the tests.

Item	Equipment	Mfr/Brand	Model/Type No.	FCC ID	Series No.	Note
E-1	Wireless VDSL2 4-port Ethernet Router	D-Link	DSL-6740B	KA2SL6740BC2	N/A	EUT
E-2	NOTEBOOK	DELL	INSPIRON 1420	DOC	JX193A01SDC2	

Item	Shielded Type	Ferrite Core	Length	Note
C-1	NO	NO	10m	

Note:

- (1) The support equipment was authorized by Declaration of Confirmation.
- (2) For detachable type I/O cable should be specified the length in m in 『Length』 column.



4. EMC EMISSION TEST

4.1 CONDUCTED EMISSION MEASUREMENT

4.1.1 POWER LINE CONDUCTED EMISSION Limits (Frequency Range 150KHz-30MHz)

FREQUENCY (MHz)	Class A (dBuV)		Class B (dBuV)		Standard
	Quasi-peak	Average	Quasi-peak	Average	
0.15 -0.5	79.00	66.00	66 - 56 *	56 - 46 *	CISPR
0.50 -5.0	73.00	60.00	56.00	46.00	CISPR
5.0 -30.0	73.00	60.00	60.00	50.00	CISPR

0.15 -0.5	79.00	66.00	66 - 56 *	56 - 46 *	FCC
0.50 -5.0	73.00	60.00	56.00	46.00	FCC
5.0 -30.0	73.00	60.00	60.00	50.00	FCC

Note:

- (1) The tighter limit applies at the band edges.
- (2) The limit of " * " marked band means the limitation decreases linearly with the logarithm of the frequency in the range.

4.1.2 MEASUREMENT INSTRUMENTS LIST AND SETTING

Item	Kind of Equipment	Manufacturer	Type No.	Serial No.	Last Calibration	Next Calibration
1	LISN	EMCO	3816/2	00052765	May.04.2013	Apr. 25, 2014
2	LISN	R&S	ENV216	100087	May.04.2012	Nov.16.2013
3	Test Cable	N/A	C_17	N/A	Mar.28.2013	Mar.15.2014
4	EMI TEST RECEIVER	R&S	ESCS30	826547/022	May.04.2013	Apr. 25, 2014
5	50Ω Terminator	SHX	TF2-3G-A	08122902	May.04.2013	Apr. 25, 2014

Remark: "N/A" denotes no model name, serial no. or calibration specified.

The following table is the setting of the receiver

Receiver Parameters	Setting
Attenuation	10 dB
Start Frequency	0.15 MHz
Stop Frequency	30 MHz
IF Bandwidth	9 kHz

4.1.3 TEST PROCEDURE

- The EUT was placed 0.8 meters from the horizontal ground plane with EUT being connected to the power mains through a line impedance stabilization network (LISN). All other support equipments powered from additional LISN(s). The LISN provide 50 Ohm/ 50uH of coupling impedance for the measuring instrument.
- Interconnecting cables that hang closer than 40 cm to the ground plane shall be folded back and forth in the center forming a bundle 30 to 40 cm long.
- I/O cables that are not connected to a peripheral shall be bundled in the center. The end of the cable may be terminated, if required, using the correct terminating impedance. The overall length shall not exceed 1 m.
- LISN at least 80 cm from nearest part of EUT chassis.
- For the actual test configuration, please refer to the related Item –EUT Test Photos.

4.1.4 DEVIATION FROM TEST STANDARD

No deviation

4.1.5 TEST SETUP

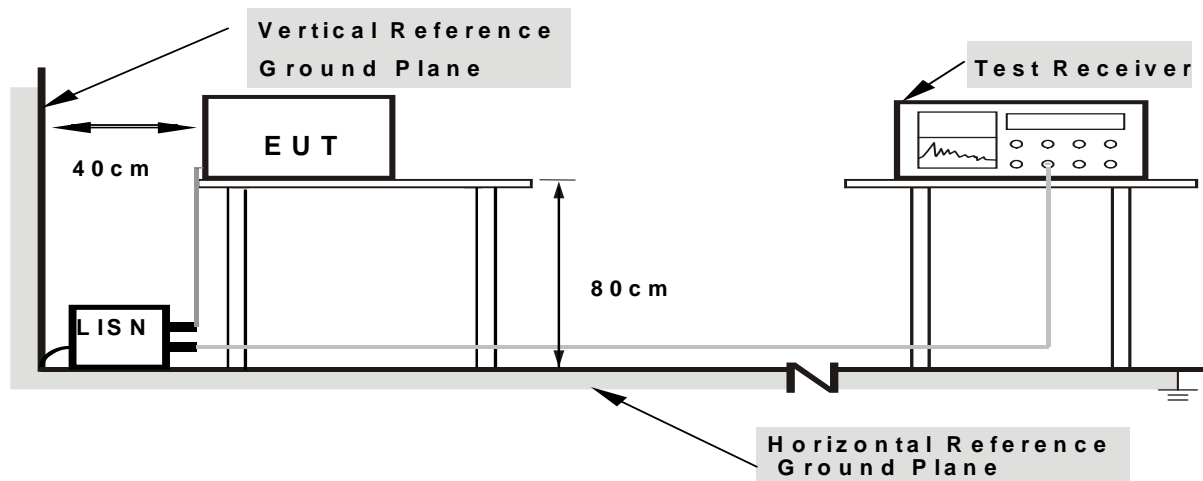

Note: 1. Support units were connected to second LISN.

2. Both of LISNs (AMN) are 80 cm from EUT and at least 80 cm from other units and other metal planes

4.1.6 EUT OPERATING CONDITIONS

The EUT was configured for testing in a typical fashion (as a customer would normally use it). The EUT has been programmed to continuously transmit during test. This operating condition was tested and used to collect the included data.

The EUT was programmed to be in continuously transmitting mode.



4.1.7 TEST RESULTS

Remark

- (1) Reading in which marked as QP means measurements by using are Quasi-Peak Mode with Detector BW=9KHz;SPA setting in RBW=10KHz,VBW =10KHz, Swp. Time = 0.3 sec./MHz. Reading in which marked as AV means measurements by using are Average Mode with instrument setting in RBW=10KHz,VBW=10KHz, Swp. Time =0.3 sec./MHz.
- (2) All readings are QP Mode value unless otherwise stated AVG in column of 'Note'. If the QP Mode Measured value compliance with the QP Limits and lower than AVG Limits, the EUT shall be deemed to meet both QP & AVG Limits and then only QP Mode was measured, but AVG Mode didn't perform. In this case, a "*"Marked in AVG Mode column of Interference Voltage Measured.
- (3) Measuring frequency range from 150KHz to 30MHz.



EUT :	Wireless VDSL2 4-port Ethernet Router	Model Name. :	DSL-6740B
Temperature :	25 °C	Relative Humidity :	58 %
Pressure :	1009 hPa	Test Voltage :	AC 120V/60Hz
Test Mode :	TX Mode	Phase:	Line
Adapter Model:	MSP-C1500IC12.0-18W-US		

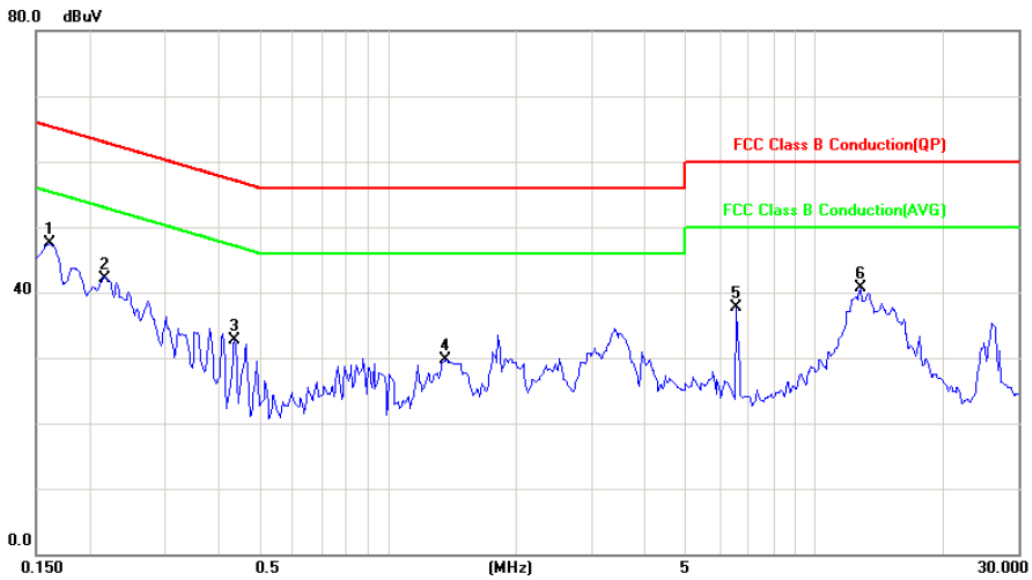

No.	Mk.	Freq. MHz	Reading Level dBuV	Correct Factor dB	Measure- ment dBuV	Limit dBuV	Over dB	Detector	Comment
1	*	0.1617	37.86	9.56	47.42	65.38	-17.96	peak	
2		0.2185	32.56	9.59	42.15	62.88	-20.73	peak	
3		0.4391	23.06	9.64	32.70	57.08	-24.38	peak	
4		1.3727	20.04	9.75	29.79	56.00	-26.21	peak	
5		6.5508	27.76	10.02	37.78	60.00	-22.22	peak	
6		12.8086	30.44	10.29	40.73	60.00	-19.27	peak	



Neutron Engineering Inc.

E.U.T :	Wireless VDSL2 4-port Ethernet Router	Model Name. :	DSL-6740B
Temperature :	25 °C	Relative Humidity :	58 %
Pressure :	1009 hPa	Test Voltage :	AC 120V/60Hz
Test Mode :	TX Mode	Phase:	Neutral
Adapter Model:	MSP-C1500IC12.0-18W-US		

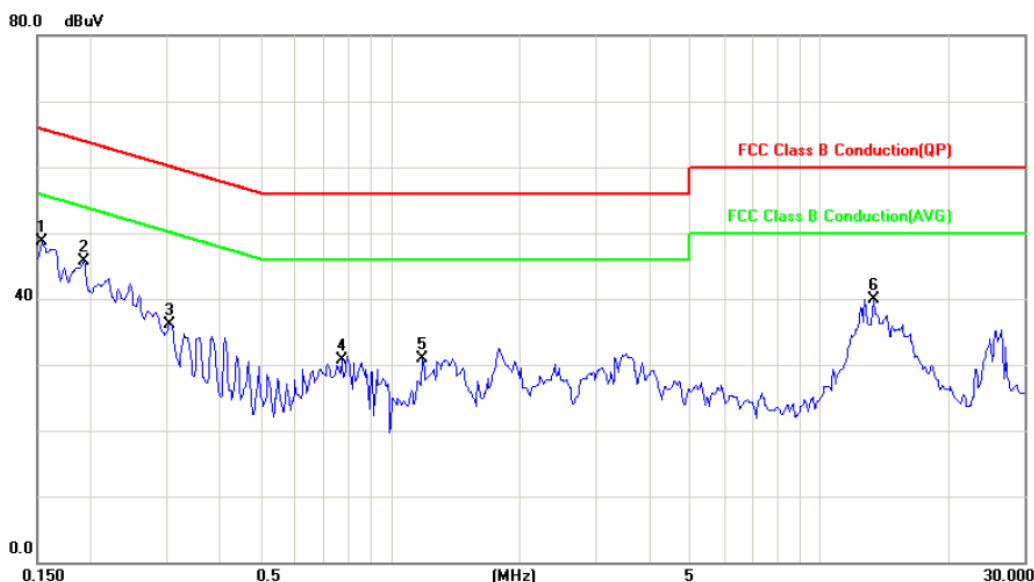

No. Mk.	Freq.	Reading Level	Correct Factor	Measurement	Limit	Over	Detector	Comment
	MHz	dBuV	dB	dBuV	dBuV	dB		
1 *	0.1540	39.20	9.52	48.72	65.78	-17.06	peak	
2	0.1930	36.20	9.57	45.77	63.91	-18.14	peak	
3	0.3063	26.40	9.63	36.03	60.07	-24.04	peak	
4	0.7672	20.98	9.73	30.71	56.00	-25.29	peak	
5	1.1891	21.12	9.78	30.90	56.00	-25.10	peak	
6	13.3594	29.62	10.34	39.96	60.00	-20.04	peak	



EUT :	Wireless VDSL2 4-port Ethernet Router	Model Name. :	DSL-6740B
Temperature :	25 °C	Relative Humidity :	58 %
Pressure :	1009 hPa	Test Voltage :	AC 120V/60Hz
Test Mode :	TX Mode	Phase:	Line
Adapter Model:	F18W-120150SPAU		

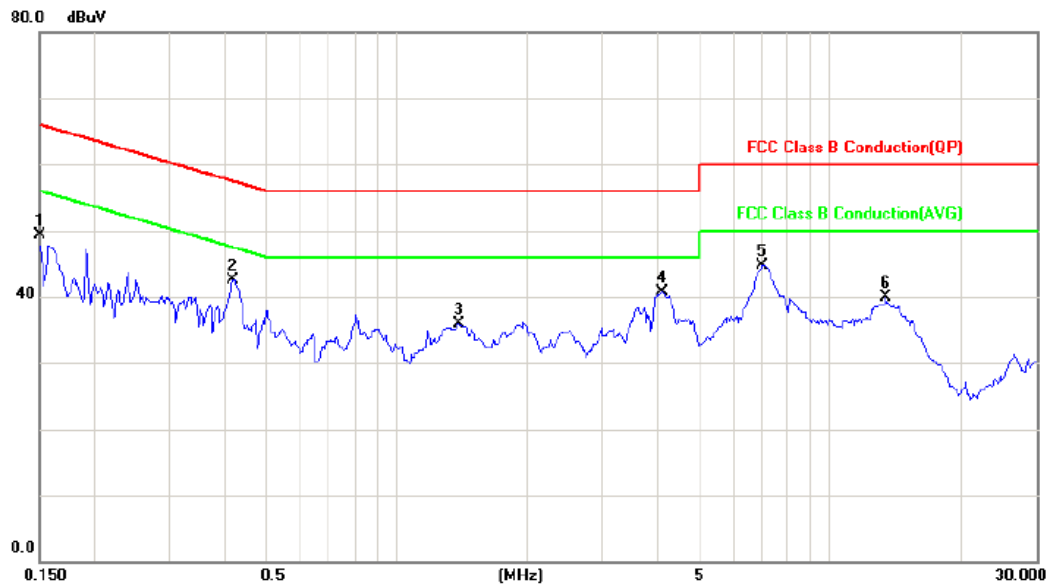

No. Mk.	Freq. MHz	Reading Level dBuV	Correct Factor dB	Measurement dBuV	Limit dBuV	Over dB	Detector	Comment
1	0.1500	39.68	9.56	49.24	66.00	-16.76	peak	
2 *	0.4193	32.84	9.63	42.47	57.46	-14.99	peak	
3	1.3920	26.18	9.75	35.93	56.00	-20.07	peak	
4	4.1093	30.86	9.90	40.76	56.00	-15.24	peak	
5	6.9881	34.76	10.04	44.80	60.00	-15.20	peak	
6	13.4180	29.56	10.31	39.87	60.00	-20.13	peak	



E.U.T :	Wireless VDSL2 4-port Ethernet Router	Model Name. :	DSL-6740B
Temperature :	25 °C	Relative Humidity :	58 %
Pressure :	1009 hPa	Test Voltage :	AC 120V/60Hz
Test Mode :	TX Mode	Phase:	Neutral
Adapter Model:	F18W-120150SPAU		

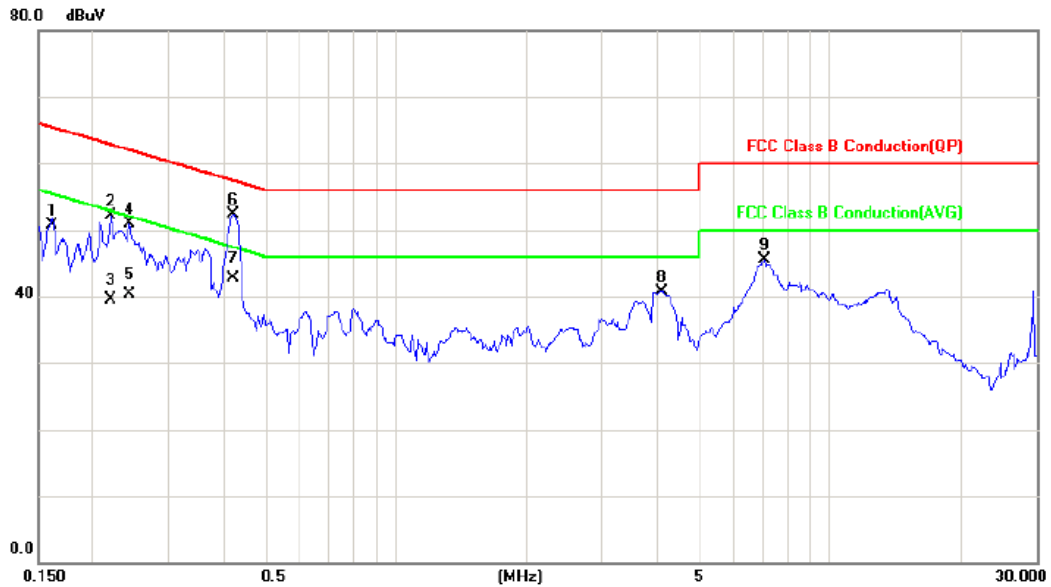

No. Mk.	Freq. MHz	Reading Level dBuV	Correct Factor dB	Measurement dBuV	Limit dBuV	Over dB	Detector	Comment
1	0.1624	41.27	9.53	50.80	65.34	-14.54	peak	
2	0.2203	42.51	9.59	52.10	62.81	-10.71	peak	
3	0.2203	29.98	9.59	39.57	52.81	-13.24	AVG	
4	0.2437	41.21	9.60	50.81	61.97	-11.16	peak	
5	0.2437	30.78	9.60	40.38	51.97	-11.59	AVG	
6	0.4234	42.69	9.66	52.35	57.38	-5.03	peak	
7 *	0.4234	33.03	9.66	42.69	47.38	-4.69	AVG	
8	4.1288	30.73	10.01	40.74	56.00	-15.26	peak	
9	7.0664	35.35	10.13	45.48	60.00	-14.52	peak	



EUT :	Wireless VDSL2 4-port Ethernet Router	Model Name. :	DSL-6740B
Temperature :	25 °C	Relative Humidity :	58 %
Pressure :	1009 hPa	Test Voltage :	AC 120V/60Hz
Test Mode :	TX Mode	Phase:	Line
Adapter Model:	RD1201500-C38-1MG		

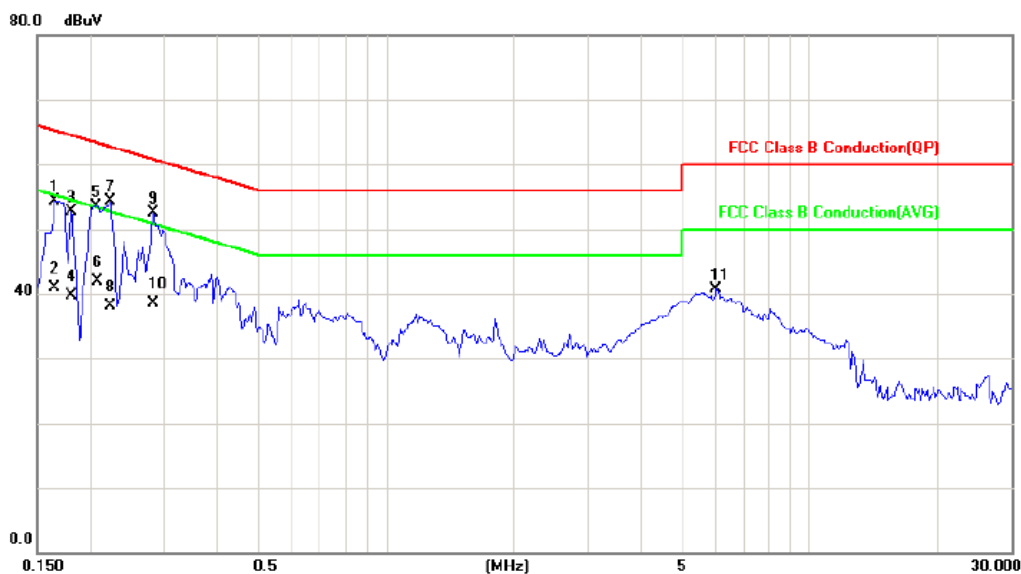

No.	Mk.	Freq. MHz	Reading Level dBuV	Correct Factor dB	Measure- ment dBuV	Limit dBuV	Over dB	Detector	Comment
1		0.1655	44.68	9.56	54.24	65.18	-10.94	peak	
2		0.1655	31.28	9.56	40.84	55.18	-14.34	AVG	
3		0.1812	43.12	9.58	52.70	64.43	-11.73	peak	
4		0.1812	30.12	9.58	39.70	54.43	-14.73	AVG	
5		0.2072	43.96	9.58	53.54	63.32	-9.78	peak	
6		0.2072	32.38	9.58	41.96	53.32	-11.36	AVG	
7		0.2242	44.78	9.59	54.37	62.66	-8.29	peak	
8		0.2242	28.48	9.59	38.07	52.66	-14.59	AVG	
9	*	0.2828	42.88	9.60	52.48	60.73	-8.25	peak	
10		0.2828	28.86	9.60	38.46	50.73	-12.27	AVG	
11		6.0508	30.70	10.00	40.70	60.00	-19.30	peak	



E.U.T :	Wireless VDSL2 4-port Ethernet Router	Model Name. :	DSL-6740B
Temperature :	25 °C	Relative Humidity :	58 %
Pressure :	1009 hPa	Test Voltage :	AC 120V/60Hz
Test Mode :	TX Mode	Phase:	Neutral
Adapter Model:	RD1201500-C38-1MG		

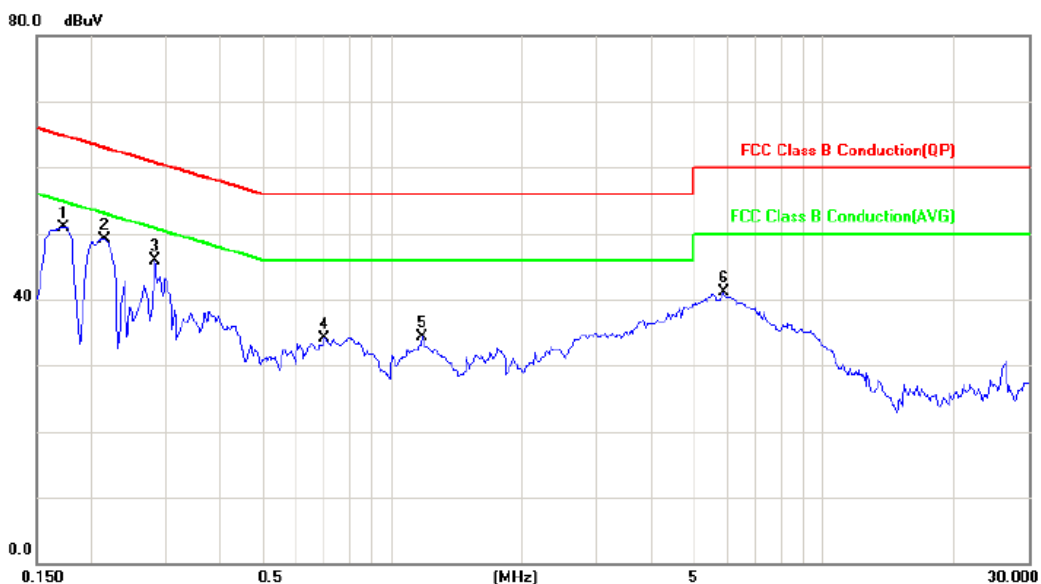

No.	Mk.	Freq. MHz	Reading Level dBuV	Correct Factor dB	Measure- ment dBuV	Limit dBuV	Over dB	Detector	Comment
1	*	0.1734	41.43	9.54	50.97	64.80	-13.83	peak	
2		0.2164	39.47	9.58	49.05	62.96	-13.91	peak	
3		0.2828	36.21	9.61	45.82	60.73	-14.91	peak	
4		0.7007	24.39	9.72	34.11	56.00	-21.89	peak	
5		1.1773	24.43	9.78	34.21	56.00	-21.79	peak	
6		5.8711	31.03	10.08	41.11	60.00	-18.89	peak	



4.2 RADIATED EMISSION MEASUREMENT

4.2.1 RADIATED EMISSION LIMITS (Frequency Range 9KHz-1000MHz)

20dBc in any 100 kHz bandwidth outside the operating frequency band. In case the emission fall within the restricted band specified on 15.205(a), then the 15.209(a) limit in the table below has to be followed.

Frequencies (MHz)	Field Strength (micorvolts/meter)	Measurement Distance (meters)
0.009~0.490	2400/F(KHz)	300
0.490~1.705	24000/F(KHz)	30
1.705~30.0	30	30
30~88	100	3
88~216	150	3
216~960	200	3
960~1000	500	3

LIMITS OF RADIATED EMISSION MEASUREMENT (Above 1000MHz)

FREQUENCY (MHz)	(dBuV/m) (at 3m)	
	PEAK	AVERAGE
Above 1000	74	54

Notes:

- (1) The limit for radiated test was performed according to FCC PART 15C.
- (2) The tighter limit applies at the band edges.
- (3) Emission level (dBuV/m)=20log Emission level (uV/m).

FREQUENCY RANGE OF RADIATED MEASUREMENT (For unintentional radiators)

Highest frequency generated or Upper frequency of measurement used in the device or on which the device operates or tunes (MHz)	Range (MHz)
Below 1.705	30
1.705 – 108	1000
108 – 500	2000
500 – 1000	5000
Above 1000	5 th harmonic of the highest frequency or 40 GHz, whichever is lower



4.2.2 MEASUREMENT INSTRUMENTS LIST AND SETTING

Item	Kind of Equipment	Manufacturer	Type No.	Serial No.	Last Calibration	Next Calibration
1	Antenna	Schwarzbeck	VULB9160	9160-3232	May.25.2013	Apr. 25, 2014
2	Amplifier	HP	8447D	2944A09673	May.04.2013	Apr. 25, 2014
3	Test Receiver	R&S	ESCI	100382	May.04.2013	Apr. 25, 2014
4	Test Cable	N/A	C-01_CB03	N/A	Jul.01.2012	Jun.30.2013
5	Antenna	ETS	3115	00075789	May.25.2013	Apr. 25, 2014
6	Amplifier	Agilent	8449B	3008A02274	May.04.2013	Apr. 25, 2014
7	Spectrum	Agilent	E4408B	US39240143	Nov.24.2012	Nov. 16.2013
8	Test Cable	HUBER+SUHNER	C-45	N/A	May.02.2013	Apr. 30, 2014
9	Controller	CT	SC100	N/A	N/A	N/A
10	Horn Antenna	EMCO	3115	9605-4803	May.26.2012	May.25.2013
11	Active Loop Antenna	R&S	HFH2-Z2	830749/020	May.04.2013	Apr. 25, 2014
12	Broad-Band Horn Antenna	Schwarzbeck	BBHA 9170	9170319	Oct.13.2012	Oct.12.2013

Remark: "N/A" denotes no model name, serial no. or calibration specified.

Spectrum Parameter	Setting
Attenuation	Auto
Start Frequency	1000 MHz
Stop Frequency	10th carrier harmonic
RB / VB (Emission in restricted band)	1MHz / 1MHz for Peak, 1 MHz / 10Hz for Average

Receiver Parameter	Setting
Attenuation	Auto
Start ~ Stop Frequency	9kHz~90kHz for PK/AVG detector
Start ~ Stop Frequency	90kHz~110kHz for QP detector
Start ~ Stop Frequency	110kHz~490kHz for PK/AVG detector
Start ~ Stop Frequency	490kHz~30MHz for QP detector
Start ~ Stop Frequency	30MHz~1000MHz for QP detector



4.2.3 TEST PROCEDURE

- a. The EUT was placed on the top of a rotating table 0.8 meters above the ground at a 3 meter semi-anechoic chamber. The table was rotated 360 degrees to determine the position of the highest radiation.(below 1GHz)
- b. The EUT was placed on the top of a rotating table 0.8 meters above the ground at a 3 meter fully-anechoic chamber. The table was rotated 360 degrees to determine the position of the highest radiation.(above 1GHz)
- c. The height of the equipment or of the substitution antenna shall be 0.8 m; the height of the test antenna shall vary between 1 m to 4 m. Both horizontal and vertical polarizations of the antenna are set to make the measurement.
- d. The initial step in collecting conducted emission data is a spectrum analyzer peak detector mode pre-scanning the measurement frequency range. Significant peaks are then marked and then Quasi Peak detector mode re-measured.
- e. If the Peak Mode measured value compliance with and lower than Quasi Peak Mode Limit, the EUT shall be deemed to meet QP Limits and then no additional QP Mode measurement performed.
- f. For the actual test configuration, please refer to the related Item –EUT Test Photos.

4.2.4 DEVIATION FROM TEST STANDARD

No deviation

4.2.5 TEST SETUP

(A) Radiated Emission Test Set-Up Frequency Below 1 GHz

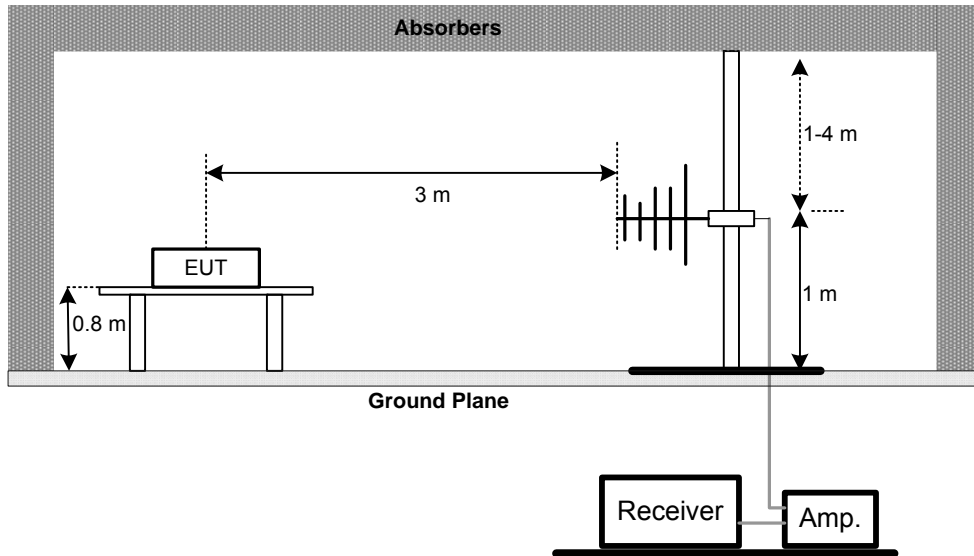

(B) Radiated Emission Test Set-Up Frequency Above 1 GHz

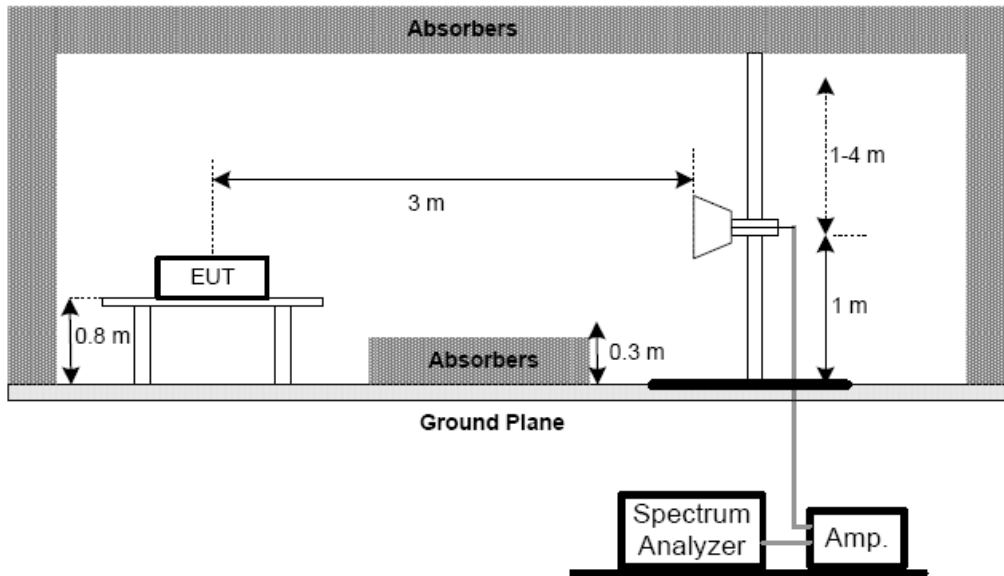

(C) For radiated emissions below 30MHz

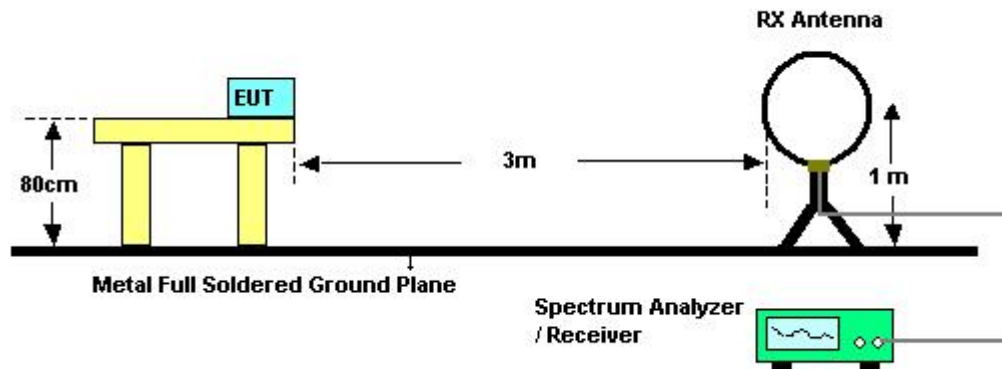

4.2.6 EUT OPERATING CONDITIONS

The EUT tested system was configured as the statements of 4.1.6 Unless otherwise a special operating condition is specified in the follows during the testing.



4.2.7 TEST RESULTS (9K~ 30MHZ)

EUT :	Wireless VDSL2 4-port Ethernet Router	Model Name. :	DSL-6740B
Temperature :	25 °C	Relative Humidity :	58 %
Test Voltage :	AC 120V/60Hz		
Test Mode :	TX Mode		

Freq. (MHz)	Ant. 0°/90°	Reading(RA) (dBuV)	Corr.Factor(CF) (dB)	Measured(FS) (dBuV/m)	Limits(QP) (dBuV/m)	Margin (dB)	Note
0.010	0°	20.15	24.30	44.45	128.03	-83.58	AV
0.010	0°	22.74	24.30	47.04	148.03	-100.99	PK
0.024	0°	18.24	24.07	42.31	120.15	-77.84	AV
0.024	0°	21.05	24.07	45.12	140.15	-95.03	PK
0.037	0°	18.55	23.19	41.74	116.13	-74.39	AV
0.037	0°	22.52	23.19	45.71	136.13	-90.42	PK
0.067	0°	19.37	22.06	41.43	111.06	-69.63	AV
0.067	0°	24.18	22.06	46.24	131.06	-84.82	PK
0.256	0°	21.40	20.39	41.79	99.44	-57.66	AV
0.256	0°	23.69	20.39	44.08	119.44	-75.37	PK
1.257	0°	24.53	19.57	44.10	65.62	-21.51	QP

Freq. (MHz)	Ant. 0°/90°	Reading(RA) (dBuV)	Corr.Factor(CF) (dB)	Measured(FS) (dBuV/m)	Limits(QP) (dBuV/m)	Margin (dB)	Note
0.010	90°	17.25	24.30	41.55	127.84	-86.29	AV
0.010	90°	21.61	24.30	45.91	147.84	-101.93	PK
0.026	90°	15.37	23.94	39.31	119.39	-80.08	AV
0.026	90°	19.58	23.94	43.52	139.39	-95.87	PK
0.035	90°	18.49	23.36	41.85	116.74	-74.90	AV
0.035	90°	22.54	23.36	45.90	136.74	-90.85	PK
0.065	90°	20.68	22.11	42.79	111.38	-68.60	AV
0.065	90°	24.52	22.11	46.63	131.38	-84.76	PK
0.236	90°	21.31	20.43	41.74	100.15	-58.41	AV
0.236	90°	23.68	20.43	44.11	120.15	-76.04	PK
1.254	90°	23.76	19.57	43.33	65.64	-22.31	QP

Remark :

- (1) The amplitude of spurious emissions which are attenuated by more than 20 dB below the permissible value has no need to be reported.
- (2) Distance extrapolation factor = 40 log (specific distance / test distance) (dB);.
- (3) Limit line = specific limits (dBuV) + distance extrapolation factor..



4.2.8 TEST RESULTS (BETWEEN 30 – 1000 MHZ)

Remark :

- (1) Reading in which marked as QP or Peak means measurements by using are Quasi-Peak Mode or Peak Mode with Detector BW=120KHz;SPA setting in RBW=120KHz, VBW =120KHz, Swp. Time = 0.3 sec./MHz.
- (2) All readings are Peak unless otherwise stated QP in column of 『Note』 .
Peak denotes that the Peak reading compliance with the QP Limits and then QP Mode measurement didn't perform.
- (3) Measuring frequency range from 30MHz to 1000MHz.
- (4) If the peak scan value lower limit more than 20dB, then this signal data does not show in table.



EUT :	Wireless VDSL2 4-port Ethernet Router	Model Name. :	DSL-6740B
Temperature :	25 °C	Relative Humidity :	58 %
Pressure :	1010 hPa	Test Power :	AC 120V/60Hz
Test Mode :	TX B MODE CHANNEL 01	Phase:	Vertical
Adapter Model:	MSP-C1500IC12.0-18W-US		

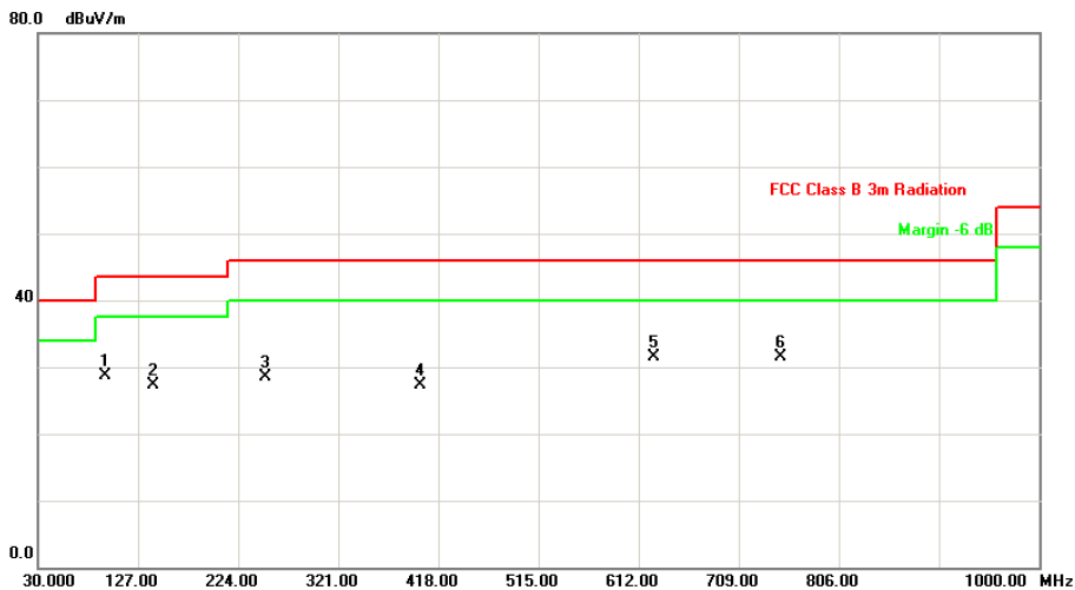

No.	Mk.	Freq. MHz	Reading Level dBuV	Correct Factor dB	Measure- ment dBuV/m	Limit dBuV/m	Over dB	Detector	Comment
1		95.4750	47.38	-18.70	28.68	43.50	-14.82	peak	
2		141.5500	45.32	-17.97	27.35	43.50	-16.15	peak	
3		250.6750	43.51	-14.99	28.52	46.00	-17.48	peak	
4		401.0250	37.08	-9.80	27.28	46.00	-18.72	peak	
5	*	626.5500	36.49	-5.05	31.44	46.00	-14.56	peak	
6		750.2250	35.67	-4.24	31.43	46.00	-14.57	peak	



EUT :	Wireless VDSL2 4-port Ethernet Router	Model Name. :	DSL-6740B
Temperature :	25 °C	Relative Humidity :	58 %
Pressure :	1010 hPa	Test Power :	AC 120V/60Hz
Test Mode :	TX B MODE CHANNEL 01	Phase:	Horizontal
Adapter Model:	MSP-C1500IC12.0-18W-US		

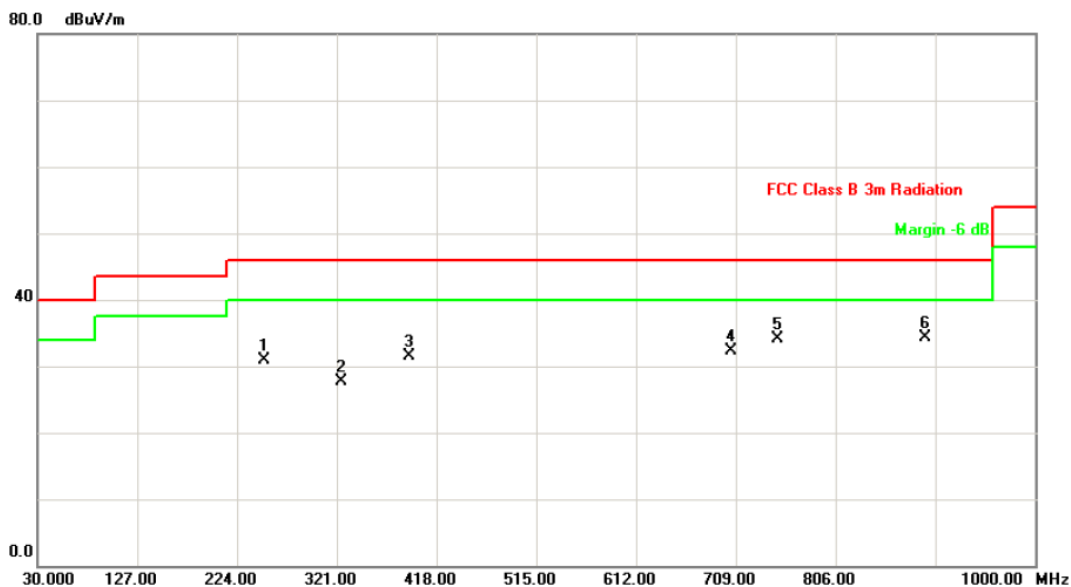

No.	Mk.	Freq. MHz	Reading Level dBuV	Correct Factor dB	Measure- ment dBuV/m	Limit dBuV/m	Over dB	Detector	Comment
1		250.6750	45.81	-14.99	30.82	46.00	-15.18	peak	
2		325.8500	39.80	-12.06	27.74	46.00	-18.26	peak	
3		391.3250	41.67	-10.11	31.56	46.00	-14.44	peak	
4		704.1500	37.02	-4.62	32.40	46.00	-13.60	peak	
5		750.2250	38.34	-4.24	34.10	46.00	-11.90	peak	
6	*	893.3000	36.28	-2.03	34.25	46.00	-11.75	peak	



EUT :	Wireless VDSL2 4-port Ethernet Router	Model Name. :	DSL-6740B
Temperature :	25 °C	Relative Humidity :	58 %
Pressure :	1010 hPa	Test Power :	AC 120V/60Hz
Test Mode :	TX B MODE CHANNEL 06	Phase:	Vertical
Adapter Model:	MSP-C1500IC12.0-18W-US		

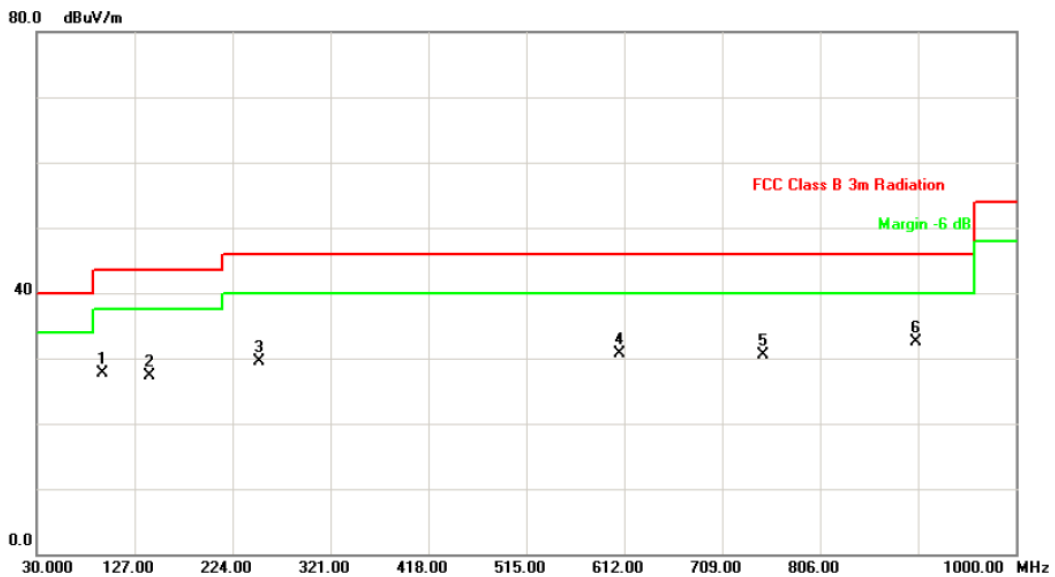

No. Mk.	Freq. MHz	Reading Level dBuV	Correct Factor dB	Measurement dBuV/m	Limit dBuV/m	Over dB	Detector	Comment
1	95.4750	46.38	-18.70	27.68	43.50	-15.82	peak	
2	141.5500	45.32	-17.97	27.35	43.50	-16.15	peak	
3	250.6750	44.51	-14.99	29.52	46.00	-16.48	peak	
4	607.1500	36.12	-5.36	30.76	46.00	-15.24	peak	
5	750.2250	34.67	-4.24	30.43	46.00	-15.57	peak	
6 *	900.5750	34.37	-1.91	32.46	46.00	-13.54	peak	



EUT :	Wireless VDSL2 4-port Ethernet Router	Model Name. :	DSL-6740B
Temperature :	25 °C	Relative Humidity :	58 %
Pressure :	1010 hPa	Test Power :	AC 120V/60Hz
Test Mode :	TX B MODE CHANNEL 06	Phase:	Horizontal
Adapter Model:	MSP-C1500IC12.0-18W-US		

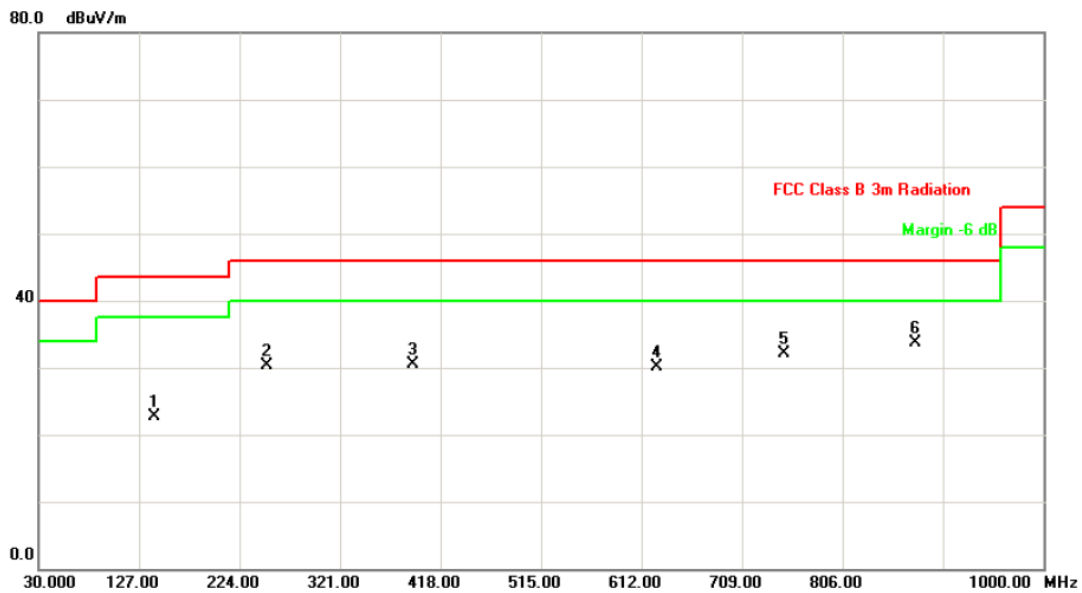

No. Mk.	Freq. MHz	Reading Level dBuV	Correct Factor dB	Measurement dBuV/m	Limit dBuV/m	Over dB	Detector	Comment
1	141.5500	40.65	-17.97	22.68	43.50	-20.82	peak	
2	250.6750	45.31	-14.99	30.32	46.00	-15.68	peak	
3	391.3250	40.67	-10.11	30.56	46.00	-15.44	peak	
4	626.5500	35.24	-5.05	30.19	46.00	-15.81	peak	
5	750.2250	36.34	-4.24	32.10	46.00	-13.90	peak	
6 *	876.3250	36.00	-2.28	33.72	46.00	-12.28	peak	



EUT :	Wireless VDSL2 4-port Ethernet Router	Model Name. :	DSL-6740B
Temperature :	25 °C	Relative Humidity :	58 %
Pressure :	1010 hPa	Test Power :	AC 120V/60Hz
Test Mode :	TX B MODE CHANNEL 11	Phase:	Vertical
Adapter Model:	MSP-C1500IC12.0-18W-US		

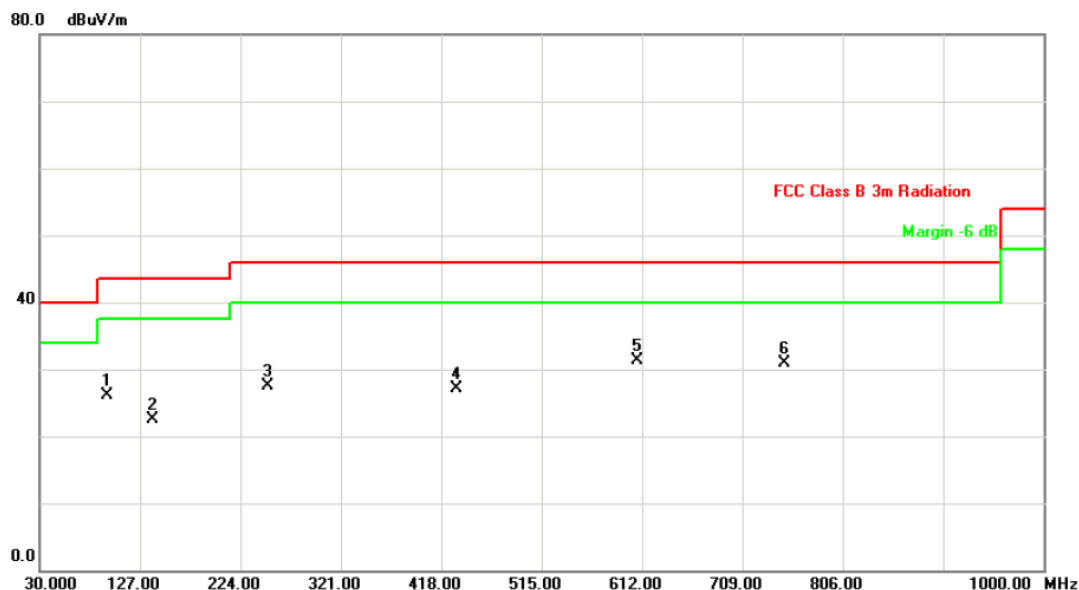

No. Mk.	Freq. MHz	Reading Level dBuV	Correct Factor dB	Measurement dBuV/m	Limit dBuV/m	Over dB	Detector	Comment
1	95.4750	44.88	-18.70	26.18	43.50	-17.32	peak	
2	139.1250	40.49	-18.03	22.46	43.50	-21.04	peak	
3	250.6750	42.51	-14.99	27.52	46.00	-18.48	peak	
4	432.5500	36.32	-9.28	27.04	46.00	-18.96	peak	
5 *	607.1500	36.62	-5.36	31.26	46.00	-14.74	peak	
6	750.2250	35.17	-4.24	30.93	46.00	-15.07	peak	



EUT :	Wireless VDSL2 4-port Ethernet Router	Model Name. :	DSL-6740B
Temperature :	25 °C	Relative Humidity :	58 %
Pressure :	1010 hPa	Test Power :	AC 120V/60Hz
Test Mode :	TX B MODE CHANNEL 11	Phase:	Horizontal
Adapter Model:	MSP-C1500IC12.0-18W-US		

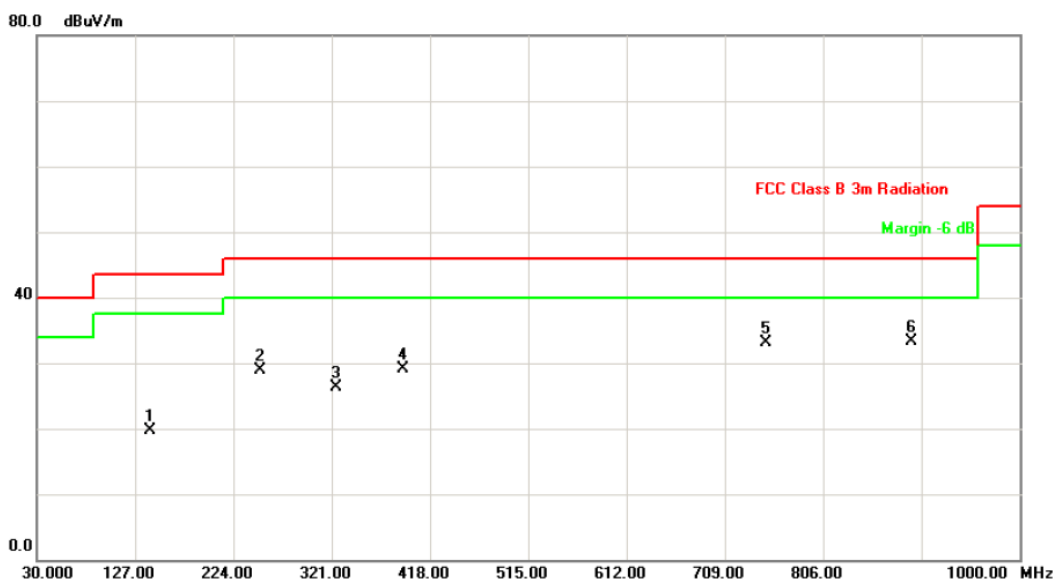

No.	Mk.	Freq. MHz	Reading Level dBuV	Correct Factor dB	Measure- ment dBuV/m	Limit dBuV/m	Over dB	Detector	Comment
1		141.5500	37.65	-17.97	19.68	43.50	-23.82	peak	
2		250.6750	43.81	-14.99	28.82	46.00	-17.18	peak	
3		325.8500	38.30	-12.06	26.24	46.00	-19.76	peak	
4		391.3250	39.17	-10.11	29.06	46.00	-16.94	peak	
5		750.2250	37.34	-4.24	33.10	46.00	-12.90	peak	
6	*	893.3000	35.28	-2.03	33.25	46.00	-12.75	peak	



EUT :	Wireless VDSL2 4-port Ethernet Router	Model Name. :	DSL-6740B
Temperature :	25 °C	Relative Humidity :	58 %
Pressure :	1010 hPa	Test Power :	AC 120V/60Hz
Test Mode :	TX B MODE CHANNEL 01	Phase:	Vertical
Adapter Model:	F18W-120150SPAU		

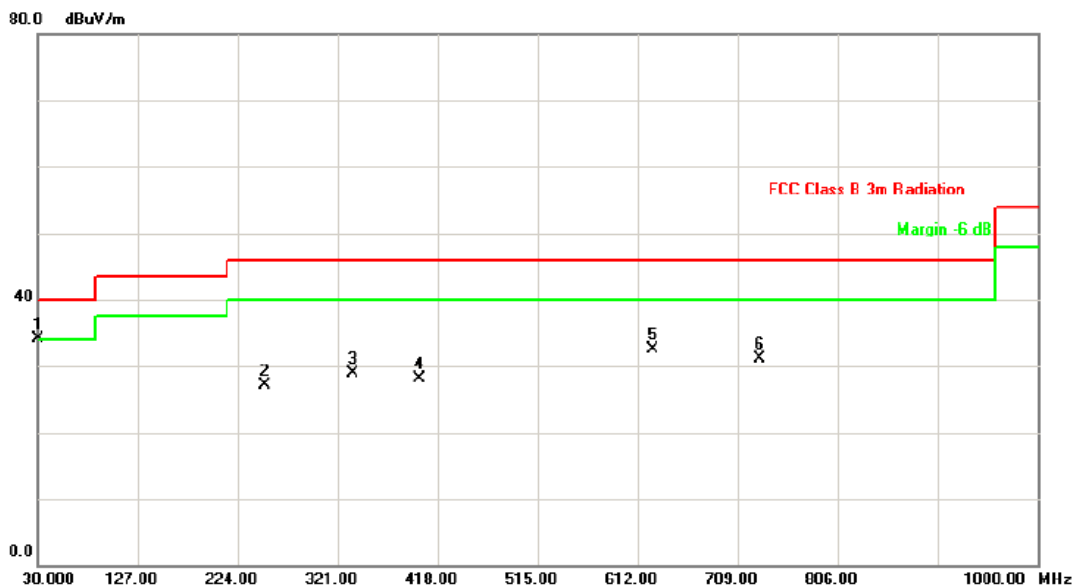

No.	Mk.	Freq. MHz	Reading Level dBuV	Correct Factor dB	Measure- ment dBuV/m	Limit dBuV/m	Over dB	Detector	Comment
1	*	30.0000	50.18	-16.05	34.13	40.00	-5.87	peak	
2		250.6750	42.17	-14.99	27.18	46.00	-18.82	peak	
3		335.5500	40.82	-11.86	28.96	46.00	-17.04	peak	
4		401.0250	37.93	-9.80	28.13	46.00	-17.87	peak	
5		626.5500	37.65	-5.05	32.60	46.00	-13.40	peak	
6		730.8250	35.43	-4.41	31.02	46.00	-14.98	peak	



EUT :	Wireless VDSL2 4-port Ethernet Router	Model Name. :	DSL-6740B
Temperature :	25 °C	Relative Humidity :	58 %
Pressure :	1010 hPa	Test Power :	AC 120V/60Hz
Test Mode :	TX B MODE CHANNEL 01	Phase:	Horizontal
Adapter Model:	F18W-120150SPAU		

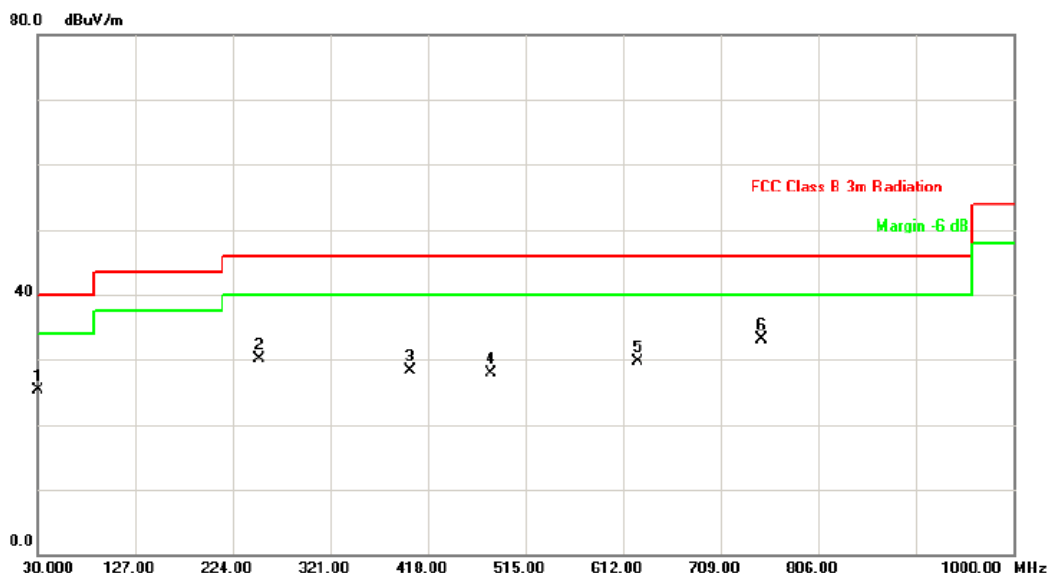

No.	Mk.	Freq. MHz	Reading Level dBuV	Correct Factor dB	Measurement dBuV/m	Limit dBuV/m	Over dB	Detector	Comment
1		30.0000	41.36	-16.05	25.31	40.00	-14.69	peak	
2		250.6750	45.08	-14.99	30.09	46.00	-15.91	peak	
3		401.0250	38.04	-9.80	28.24	46.00	-17.76	peak	
4		481.0500	36.54	-8.63	27.91	46.00	-18.09	peak	
5		626.5500	34.80	-5.05	29.75	46.00	-16.25	peak	
6	*	750.2250	37.27	-4.24	33.03	46.00	-12.97	peak	



EUT :	Wireless VDSL2 4-port Ethernet Router	Model Name. :	DSL-6740B
Temperature :	25 °C	Relative Humidity :	58 %
Pressure :	1010 hPa	Test Power :	AC 120V/60Hz
Test Mode :	TX B MODE CHANNEL 06	Phase:	Vertical
Adapter Model:	F18W-120150SPAU		

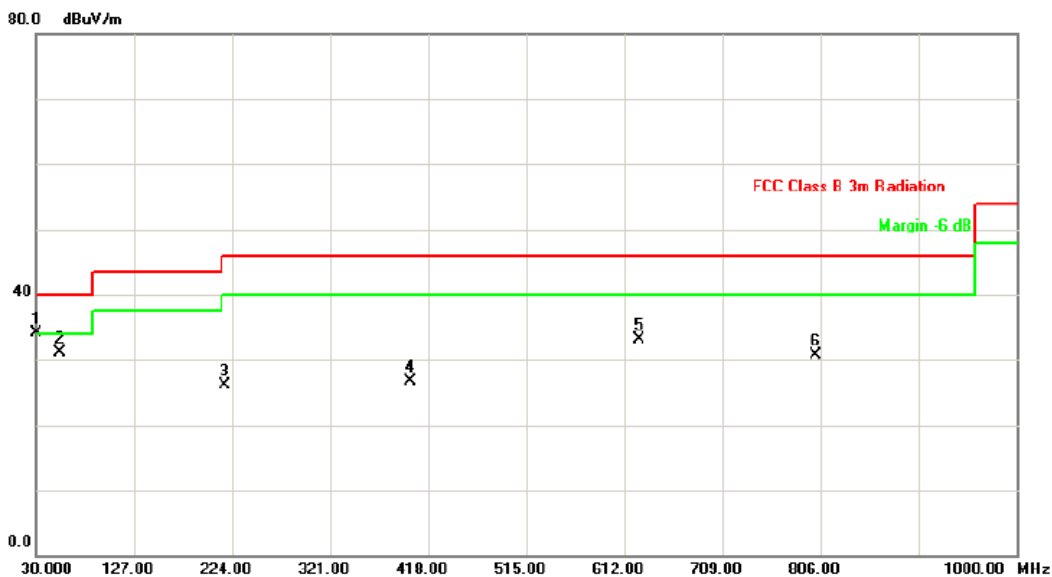

No.	Mk.	Freq. MHz	Reading Level dBuV	Correct Factor dB	Measure- ment dBuV/m	Limit dBuV/m	Over dB	Detector	Comment
1	*	30.0000	50.18	-16.05	34.13	40.00	-5.87	peak	
2		54.2500	48.67	-17.63	31.04	40.00	-8.96	peak	
3		216.7250	42.50	-16.46	26.04	46.00	-19.96	peak	
4		401.0250	36.43	-9.80	26.63	46.00	-19.37	peak	
5		626.5500	38.15	-5.05	33.10	46.00	-12.90	peak	
6		801.1500	34.31	-3.60	30.71	46.00	-15.29	peak	



Neutron Engineering Inc.

EUT :	Wireless VDSL2 4-port Ethernet Router	Model Name. :	DSL-6740B
Temperature :	25 °C	Relative Humidity :	58 %
Pressure :	1010 hPa	Test Power :	AC 120V/60Hz
Test Mode :	TX B MODE CHANNEL 06	Phase:	Horizontal
Adapter Model:	F18W-120150SPAU		

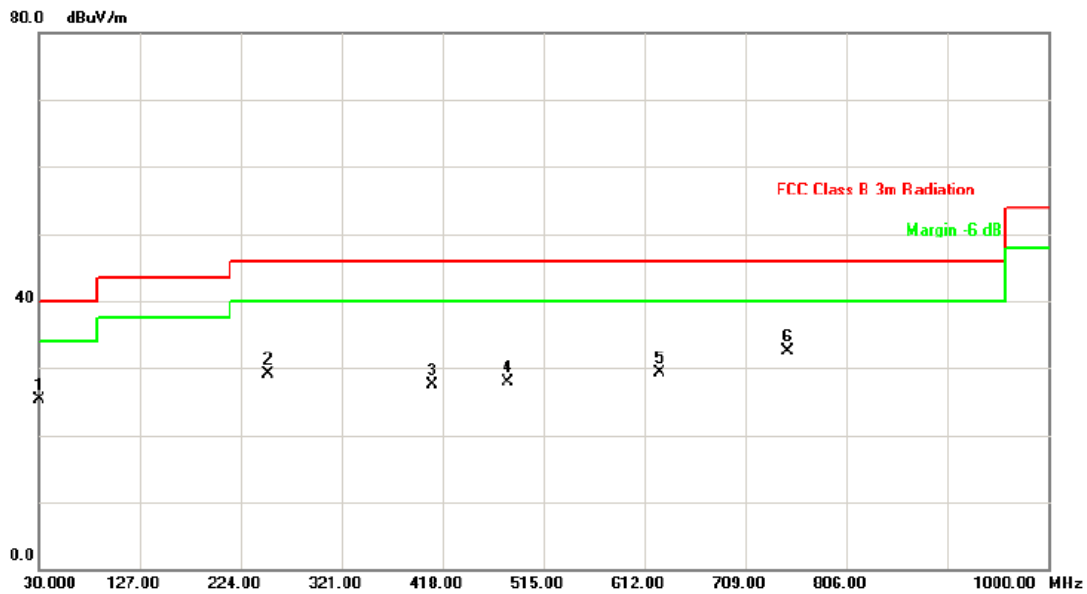

No.	Mk.	Freq. MHz	Reading Level dBuV	Correct Factor dB	Measure- ment dBuV/m	Limit dBuV/m	Over dB	Detector	Comment
1		30.0000	41.36	-16.05	25.31	40.00	-14.69	peak	
2		250.6750	44.08	-14.99	29.09	46.00	-16.91	peak	
3		408.3000	37.19	-9.67	27.52	46.00	-18.48	peak	
4		481.0500	36.54	-8.63	27.91	46.00	-18.09	peak	
5		626.5500	34.30	-5.05	29.25	46.00	-16.75	peak	
6	*	750.2250	36.77	-4.24	32.53	46.00	-13.47	peak	



EUT :	Wireless VDSL2 4-port Ethernet Router	Model Name. :	DSL-6740B
Temperature :	25 °C	Relative Humidity :	58 %
Pressure :	1010 hPa	Test Power :	AC 120V/60Hz
Test Mode :	TX B MODE CHANNEL 11	Phase:	Vertical
Adapter Model:	F18W-120150SPAU		

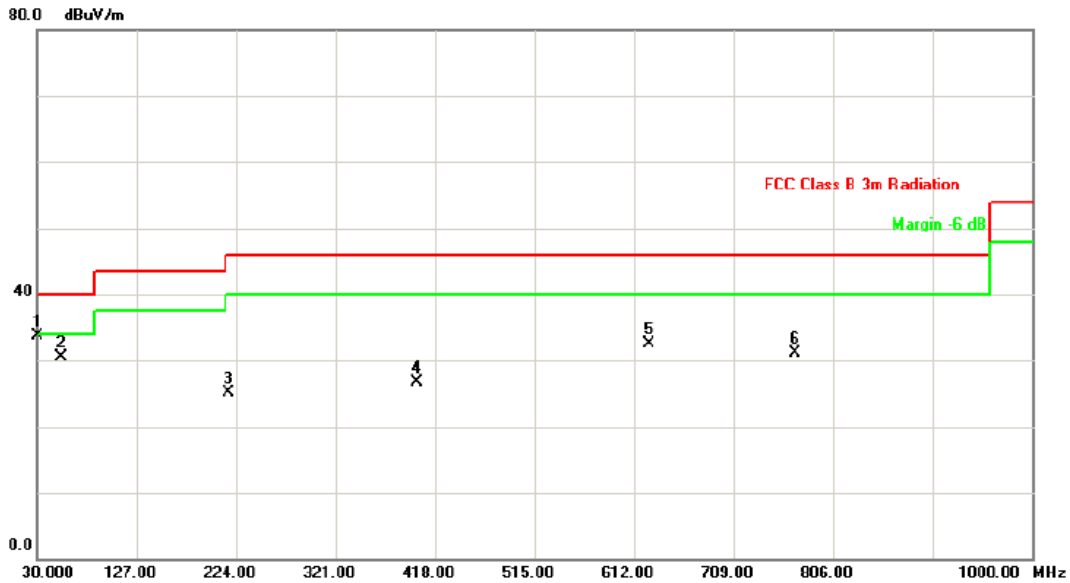

No.	Mk.	Freq. MHz	Reading Level dBuV	Correct Factor dB	Measurement dBuV/m	Limit dBuV/m	Over dB	Detector	Comment
1	*	30.0000	49.68	-16.05	33.63	40.00	-6.37	peak	
2		54.2500	48.17	-17.63	30.54	40.00	-9.46	peak	
3		216.7250	41.50	-16.46	25.04	46.00	-20.96	peak	
4		401.0250	36.43	-9.80	26.63	46.00	-19.37	peak	
5		626.5500	37.65	-5.05	32.60	46.00	-13.40	peak	
6		769.6250	35.20	-4.01	31.19	46.00	-14.81	peak	



EUT :	Wireless VDSL2 4-port Ethernet Router	Model Name. :	DSL-6740B
Temperature :	25 °C	Relative Humidity :	58 %
Pressure :	1010 hPa	Test Power :	AC 120V/60Hz
Test Mode :	TX B MODE CHANNEL 11	Phase:	Horizontal
Adapter Model:	F18W-120150SPAU		

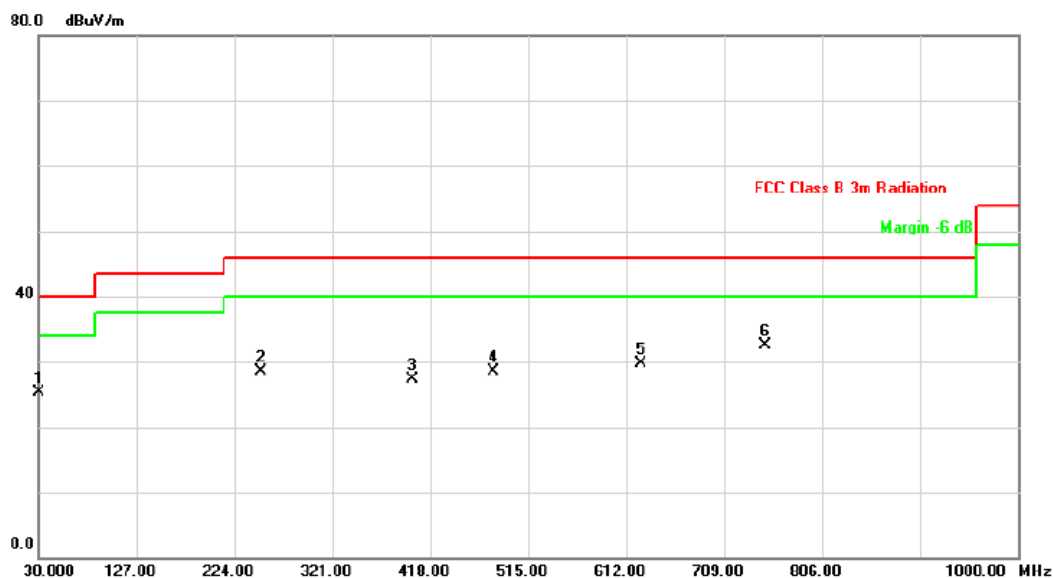

No.	Mk.	Freq. MHz	Reading Level dBuV	Correct Factor dB	Measure- ment dBuV/m	Limit dBuV/m	Over dB	Detector	Comment
1		30.0000	41.36	-16.05	25.31	40.00	-14.69	peak	
2		250.6750	43.58	-14.99	28.59	46.00	-17.41	peak	
3		401.0250	37.04	-9.80	27.24	46.00	-18.76	peak	
4		481.0500	37.04	-8.63	28.41	46.00	-17.59	peak	
5		626.5500	34.80	-5.05	29.75	46.00	-16.25	peak	
6	*	750.2250	36.77	-4.24	32.53	46.00	-13.47	peak	



EUT :	Wireless VDSL2 4-port Ethernet Router	Model Name. :	DSL-6740B
Temperature :	25 °C	Relative Humidity :	58 %
Pressure :	1010 hPa	Test Power :	AC 120V/60Hz
Test Mode :	TX B MODE CHANNEL 01	Phase:	Vertical
Adapter Model:	RD1201500-C38-1MG		

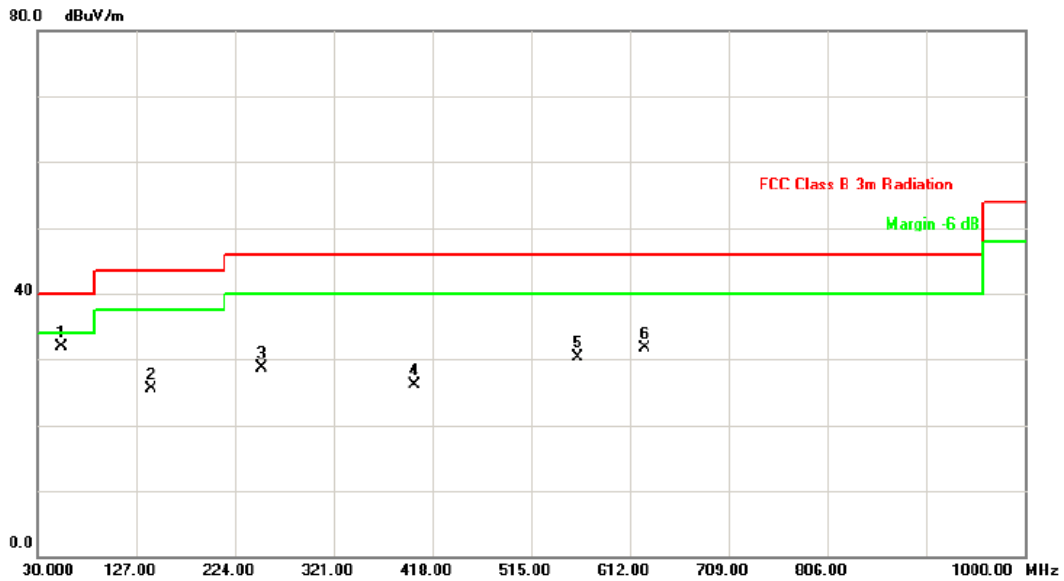

No.	Mk.	Freq. MHz	Reading Level dBuV	Correct Factor dB	Measure- ment dBuV/m	Limit dBuV/m	Over dB	Detector	Comment
1	*	54.2500	49.53	-17.63	31.90	40.00	-8.10	peak	
2		141.5500	43.44	-17.97	25.47	43.50	-18.03	peak	
3		250.6750	43.64	-14.99	28.65	46.00	-17.35	peak	
4		401.0250	35.88	-9.80	26.08	46.00	-19.92	peak	
5		561.0750	36.72	-6.36	30.36	46.00	-15.64	peak	
6		626.5500	36.67	-5.05	31.62	46.00	-14.38	peak	



EUT :	Wireless VDSL2 4-port Ethernet Router	Model Name. :	DSL-6740B
Temperature :	25 °C	Relative Humidity :	58 %
Pressure :	1010 hPa	Test Power :	AC 120V/60Hz
Test Mode :	TX B MODE CHANNEL 01	Phase:	Horizontal
Adapter Model:	RD1201500-C38-1MG		

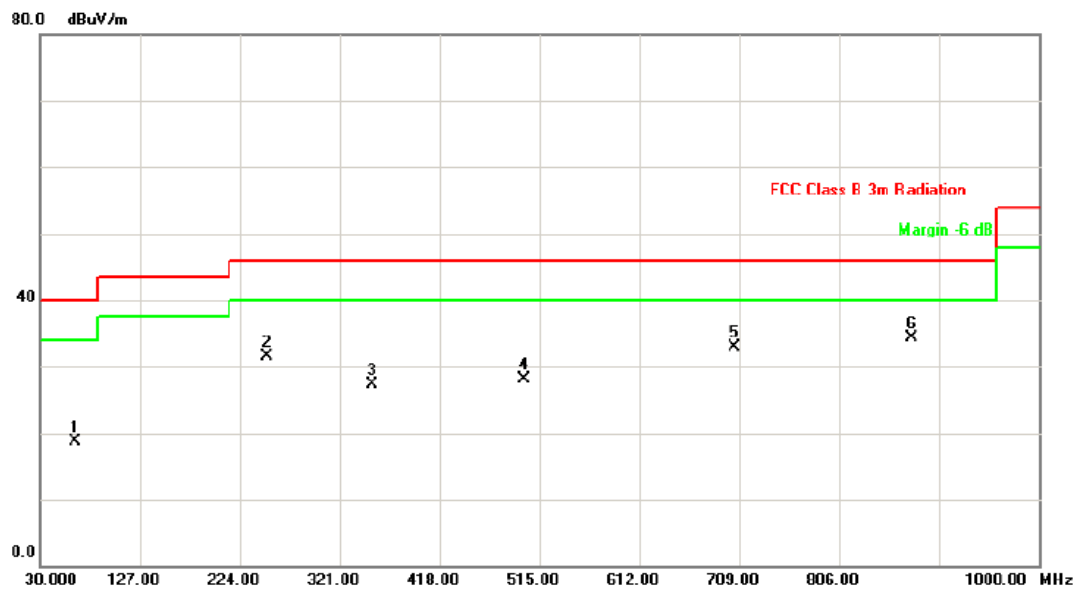

No.	Mk.	Freq. MHz	Reading Level dBuV	Correct Factor dB	Measurement dBuV/m	Limit dBuV/m	Over dB	Detector	Comment
1		63.9500	36.33	-17.71	18.62	40.00	-21.38	peak	
2		250.6750	46.54	-14.99	31.55	46.00	-14.45	peak	
3		352.5250	38.70	-11.44	27.26	46.00	-18.74	peak	
4		500.4500	36.52	-8.37	28.15	46.00	-17.85	peak	
5		704.1500	37.56	-4.62	32.94	46.00	-13.06	peak	
6	*	876.3250	36.67	-2.28	34.39	46.00	-11.61	peak	



EUT :	Wireless VDSL2 4-port Ethernet Router	Model Name. :	DSL-6740B
Temperature :	25 °C	Relative Humidity :	58 %
Pressure :	1010 hPa	Test Power :	AC 120V/60Hz
Test Mode :	TX B MODE CHANNEL 06	Phase:	Vertical
Adapter Model:	RD1201500-C38-1MG		

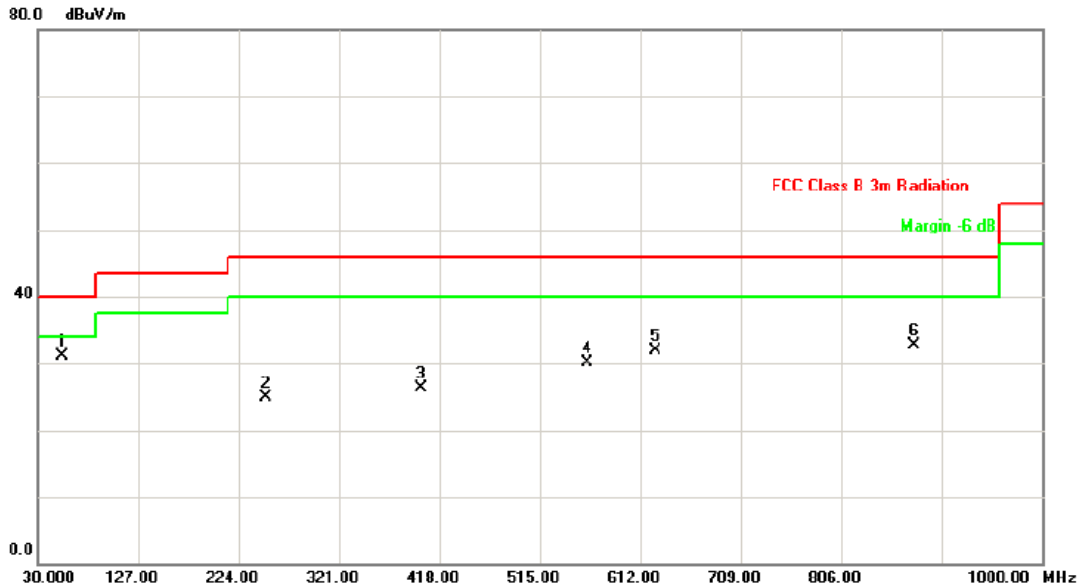

No.	Mk.	Freq. MHz	Reading Level dBuV	Correct Factor dB	Measure- ment dBuV/m	Limit dBuV/m	Over dB	Detector	Comment
1	*	54.2500	48.77	-17.63	31.14	40.00	-8.86	peak	
2		250.6750	39.88	-14.99	24.89	46.00	-21.11	peak	
3		401.0250	36.12	-9.80	26.32	46.00	-19.68	peak	
4		561.0750	36.46	-6.36	30.10	46.00	-15.90	peak	
5		626.5500	36.91	-5.05	31.86	46.00	-14.14	peak	
6		876.3250	34.91	-2.28	32.63	46.00	-13.37	peak	



EUT :	Wireless VDSL2 4-port Ethernet Router	Model Name. :	DSL-6740B
Temperature :	25 °C	Relative Humidity :	58 %
Pressure :	1010 hPa	Test Power :	AC 120V/60Hz
Test Mode :	TX B MODE CHANNEL 06	Phase:	Horizontal
Adapter Model:	RD1201500-C38-1MG		

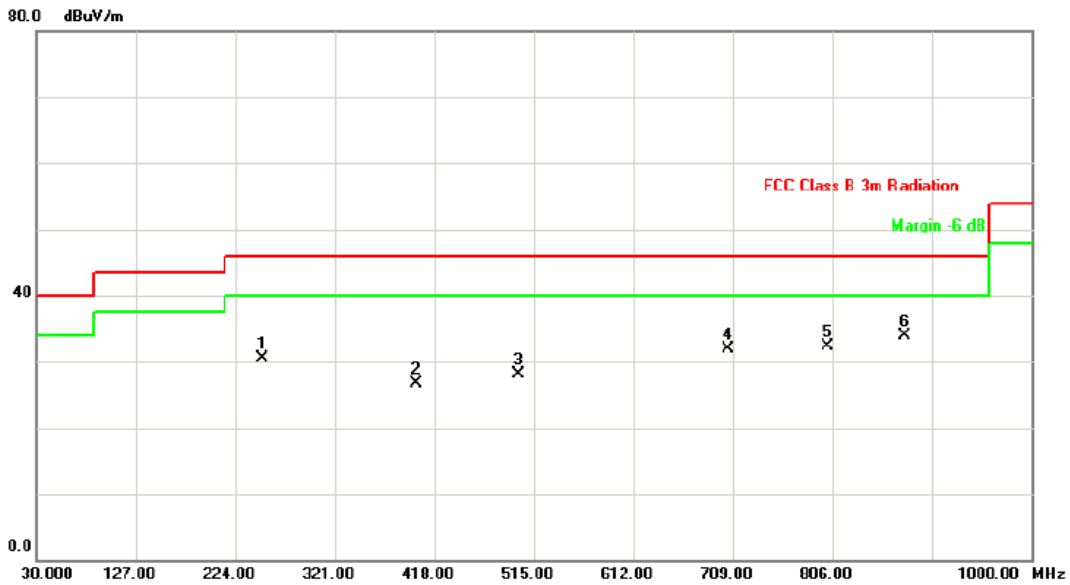

No. Mk.	Freq. MHz	Reading Level dBuV	Correct Factor dB	Measurement dBuV/m	Limit dBuV/m	Over dB	Detector	Comment
1	250.6750	45.54	-14.99	30.55	46.00	-15.45	peak	
2	401.0250	36.44	-9.80	26.64	46.00	-19.36	peak	
3	500.4500	36.52	-8.37	28.15	46.00	-17.85	peak	
4	704.1500	36.56	-4.62	31.94	46.00	-14.06	peak	
5	801.1500	35.84	-3.60	32.24	46.00	-13.76	peak	
6 *	876.3250	36.17	-2.28	33.89	46.00	-12.11	peak	



EUT :	Wireless VDSL2 4-port Ethernet Router	Model Name. :	DSL-6740B
Temperature :	25 °C	Relative Humidity :	58 %
Pressure :	1010 hPa	Test Power :	AC 120V/60Hz
Test Mode :	TX B MODE CHANNEL 11	Phase:	Vertical
Adapter Model:	RD1201500-C38-1MG		

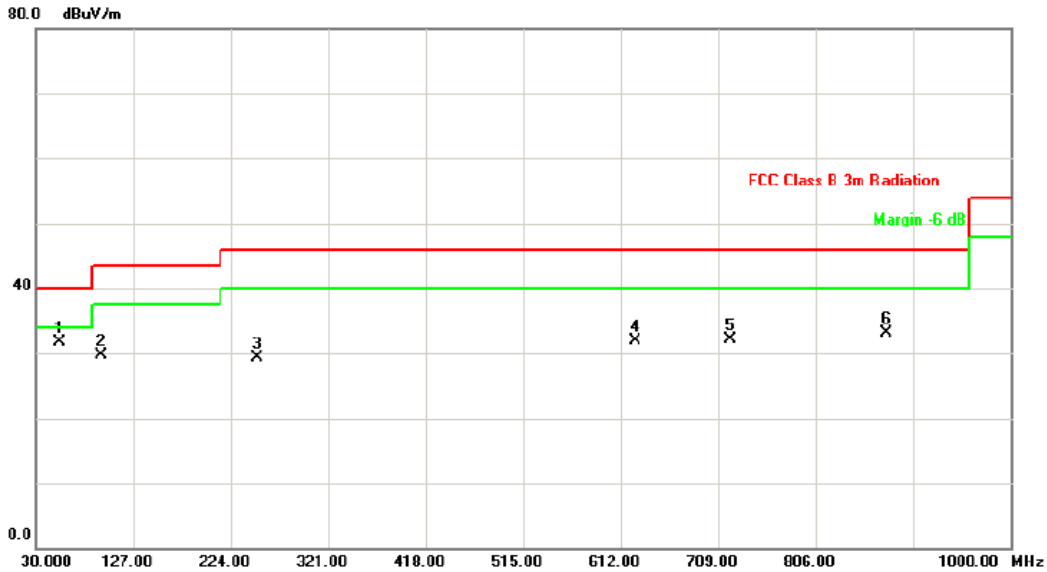

No.	Mk.	Freq. MHz	Reading Level dBuV	Correct Factor dB	Measurement dBuV/m	Limit dBuV/m	Over dB	Detector	Comment
1	*	54.2500	49.27	-17.63	31.64	40.00	-8.36	peak	
2		95.4750	48.40	-18.70	29.70	43.50	-13.80	peak	
3		250.6750	44.38	-14.99	29.39	46.00	-16.61	peak	
4		626.5500	36.91	-5.05	31.86	46.00	-14.14	peak	
5		721.1250	36.63	-4.49	32.14	46.00	-13.86	peak	
6		876.3250	35.41	-2.28	33.13	46.00	-12.87	peak	



EUT :	Wireless VDSL2 4-port Ethernet Router	Model Name. :	DSL-6740B
Temperature :	25 °C	Relative Humidity :	58 %
Pressure :	1010 hPa	Test Power :	AC 120V/60Hz
Test Mode :	TX B MODE CHANNEL 11	Phase:	Horizontal
Adapter Model:	RD1201500-C38-1MG		

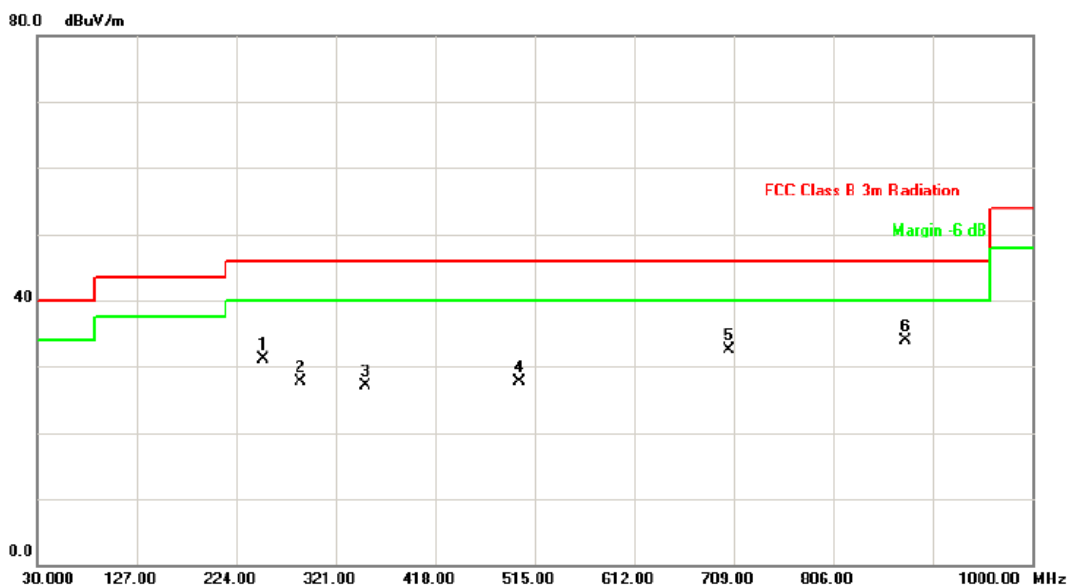

No.	Mk.	Freq. MHz	Reading Level dBuV	Correct Factor dB	Measure- ment dBuV/m	Limit dBuV/m	Over dB	Detector	Comment
1		250.6750	46.04	-14.99	31.05	46.00	-14.95	peak	
2		287.0500	40.43	-12.77	27.66	46.00	-18.34	peak	
3		350.1000	38.70	-11.52	27.18	46.00	-18.82	peak	
4		500.4500	36.02	-8.37	27.65	46.00	-18.35	peak	
5		704.1500	37.06	-4.62	32.44	46.00	-13.56	peak	
6	*	876.3250	36.17	-2.28	33.89	46.00	-12.11	peak	



4.2.9 TEST RESULTS (ABOVE 1000 MHZ)

EUT :	Wireless VDSL2 4-port Ethernet Router	Model Name :	DSL-6740B
Temperature :	25 °C	Relative Humidity :	51 %
Pressure :	1010 hPa	Test Voltage :	AC 120V/60Hz
Test Mode :	TX B MODE 2412MHz-		

Freq. (MHz)	Ant.Pol. H/V	Reading		Ant./CF CF(dB)	Act.		Limit		Note
		Peak (dBuV)	AV (dBuV)		Peak (dBuV/m)	AV (dBuV/m)	Peak (dBuV/m)	AV (dBuV/m)	
2390.00	V	22.88	12.64	32.28	55.16	44.92	74.00	54.00	X/E
2412.75	V	73.15	68.86	32.25	105.40	101.11			X/F
4823.95	V	48.31	40.41	6.19	54.50	46.60	74.00	54.00	X/H

Remark :

- (1) All readings are Peak unless otherwise stated QP in column of 『Note』 . Peak denotes that the Peak reading compliance with the QP Limits and then QP Mode measurement didn't perform ◦
- (2) Measuring frequency range from 30MHz to 1000MHz or the 10th harmonic of highest fundamental frequency ◦ "F" denotes fundamental frequency; "H" denotes spurious frequency. "E" denotes band edge frequency. (This judgment method includes the Band Edge Requirement.)
- (3) Radiated emissions measured in frequency range above 1000MHz were made with an instrument using Peak detector mode and AV detector mode of the emission ◦
- (4) Data of measurement within this frequency range shown " * " in the table above means the reading of emissions are attenuated more than 20dB below the permissible limits or the field strength is too small to be measured.
- (5) A preamp and high pass filter were used for this test in order to provide sufficient measurement sensitivity.
- (6) EUT Orthogonal Axis :
"X" - denotes Laid on Table ; "Y" - denotes Vertical Stand ; "Z" - denotes Side Stand
- (7) During the measurements above 1 GHz it is taken care of that the EUT is always within the 3 dB cone of radiation BW of the used antenna



TX CH01 (Above 1000 MHz, Vertical)

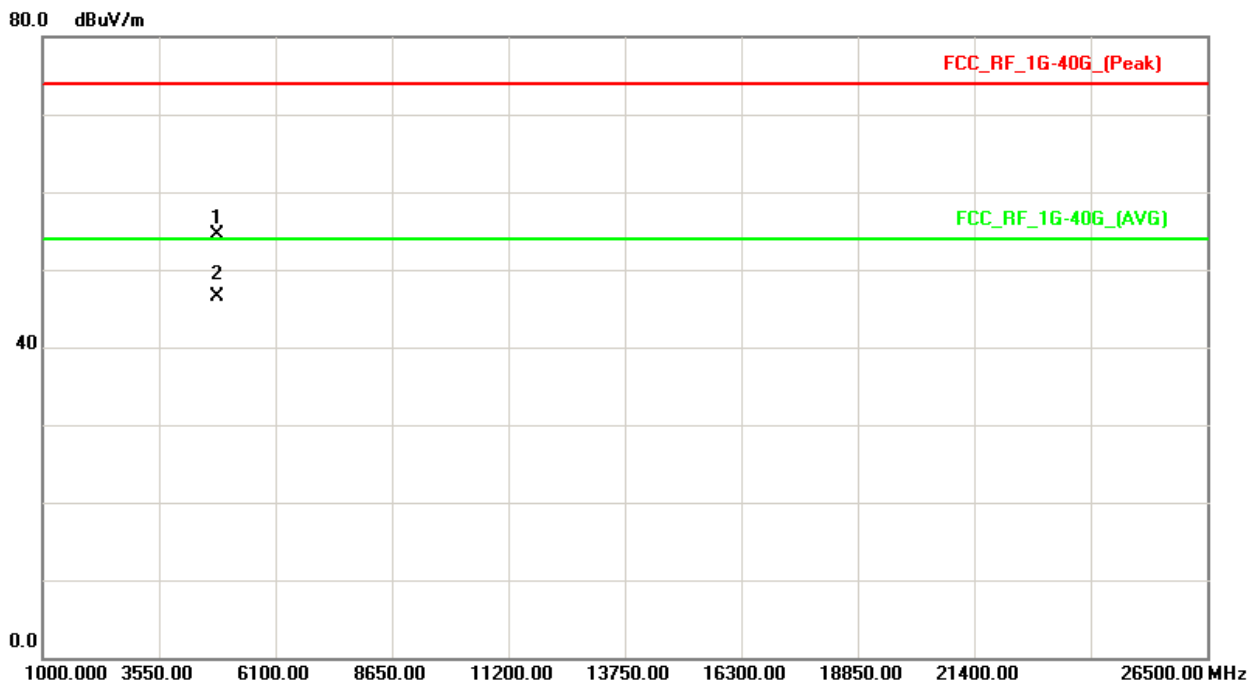
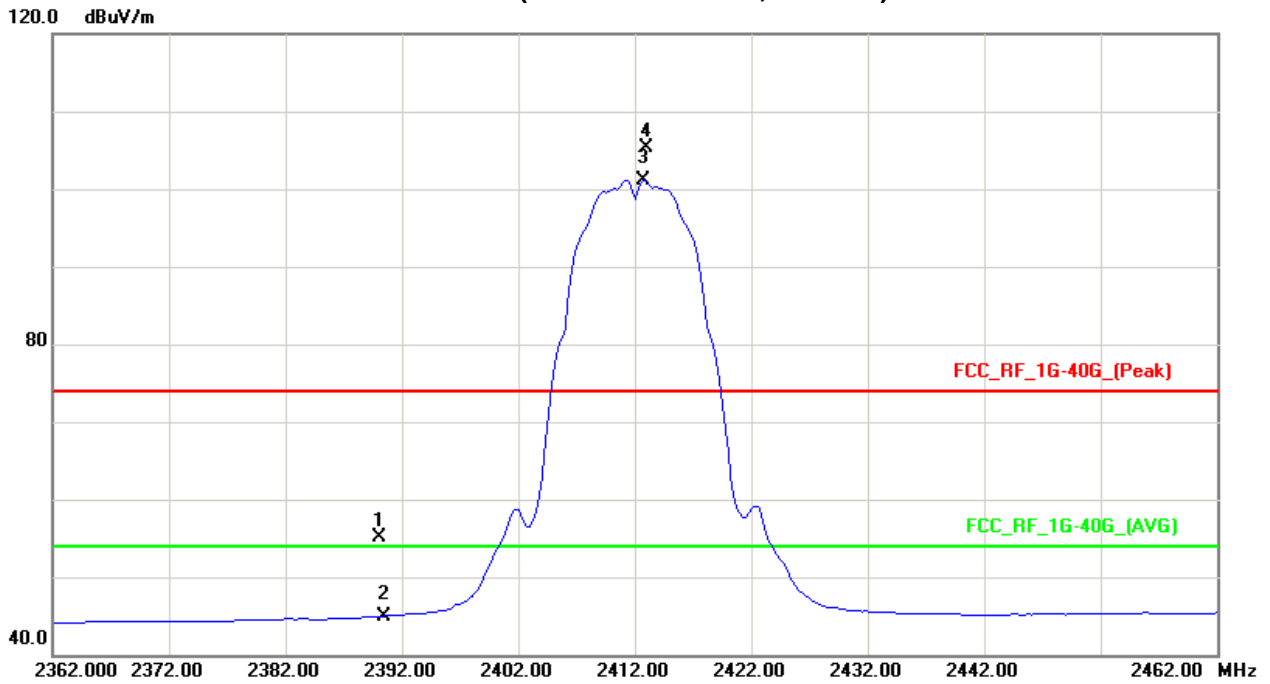



EUT :	Wireless VDSL2 4-port Ethernet Router	Model Name :	DSL-6740B
Temperature :	25 °C	Relative Humidity :	51 %
Pressure :	1010 hPa	Test Voltage :	AC 120V/60Hz
Test Mode :	TX B MODE 2412MHz		

Freq.	Ant.Pol.	Reading		Ant./CF	Act.		Limit		Note
		Peak	AV		Peak	AV	Peak	AV	
(MHz)	H/V	(dBuV)	(dBuV)	CF(dB)	(dBuV/m)	(dBuV/m)	(dBuV/m)	(dBuV/m)	
2390.00	H	24.45	13.40	32.28	56.73	45.68	74.00	54.00	X/E
2413.00	H	75.63	71.02	32.26	107.89	103.28			X/F
4824.03	H	47.63	38.24	6.19	53.82	44.43	74.00	54.00	X/H

Remark :

- (1) All readings are Peak unless otherwise stated QP in column of 『Note』 . Peak denotes that the Peak reading compliance with the QP Limits and then QP Mode measurement didn't perform ◦
- (2) Measuring frequency range from 30MHz to 1000MHz or the 10th harmonic of highest fundamental frequency ◦ "F" denotes fundamental frequency; "H" denotes spurious frequency. "E" denotes band edge frequency. (This judgment method includes the Band Edge Requirement.)
- (3) Radiated emissions measured in frequency range above 1000MHz were made with an instrument using Peak detector mode and AV detector mode of the emission ◦
- (4) Data of measurement within this frequency range shown " * " in the table above means the reading of emissions are attenuated more than 20dB below the permissible limits or the field strength is too small to be measured.
- (5) A preamp and high pass filter were used for this test in order to provide sufficient measurement sensitivity.
- (6) EUT Orthogonal Axis :
"X" - denotes Laid on Table ; "Y" - denotes Vertical Stand ; "Z" - denotes Side Stand
- (7) During the measurements above 1 GHz it is taken care of that the EUT is always within the 3 dB cone of radiation BW of the used antenna



TX CH01 (Above 1000 MHz, Horizontal)

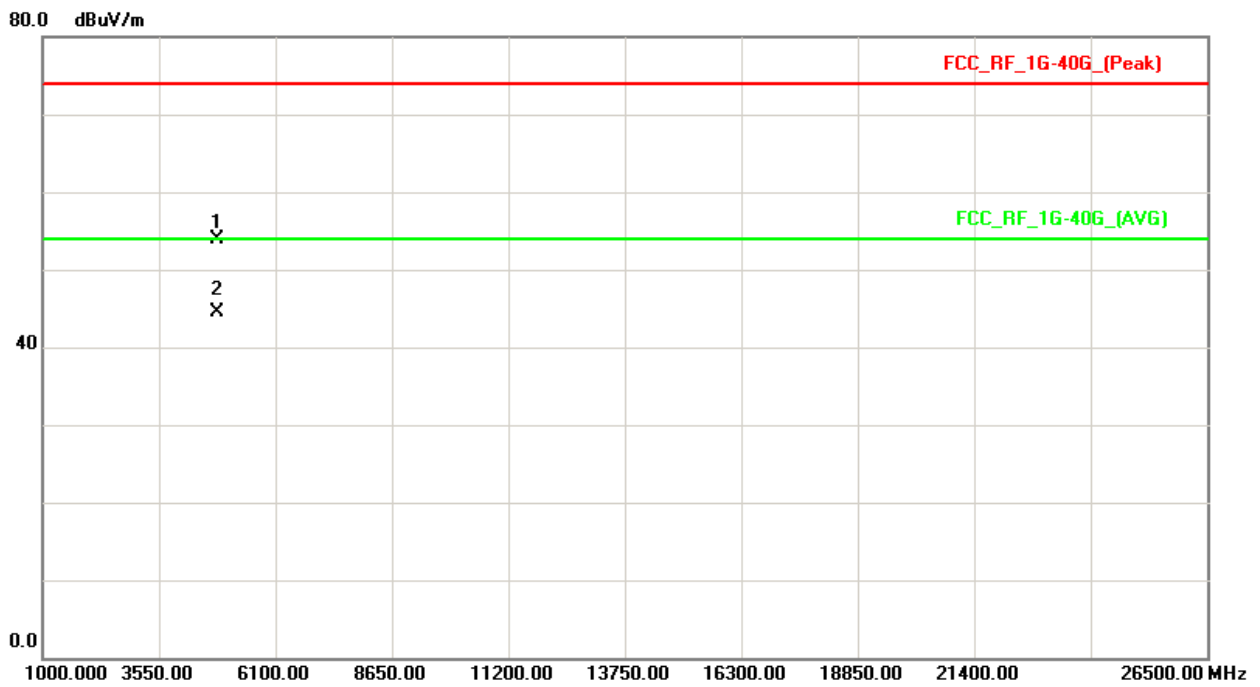
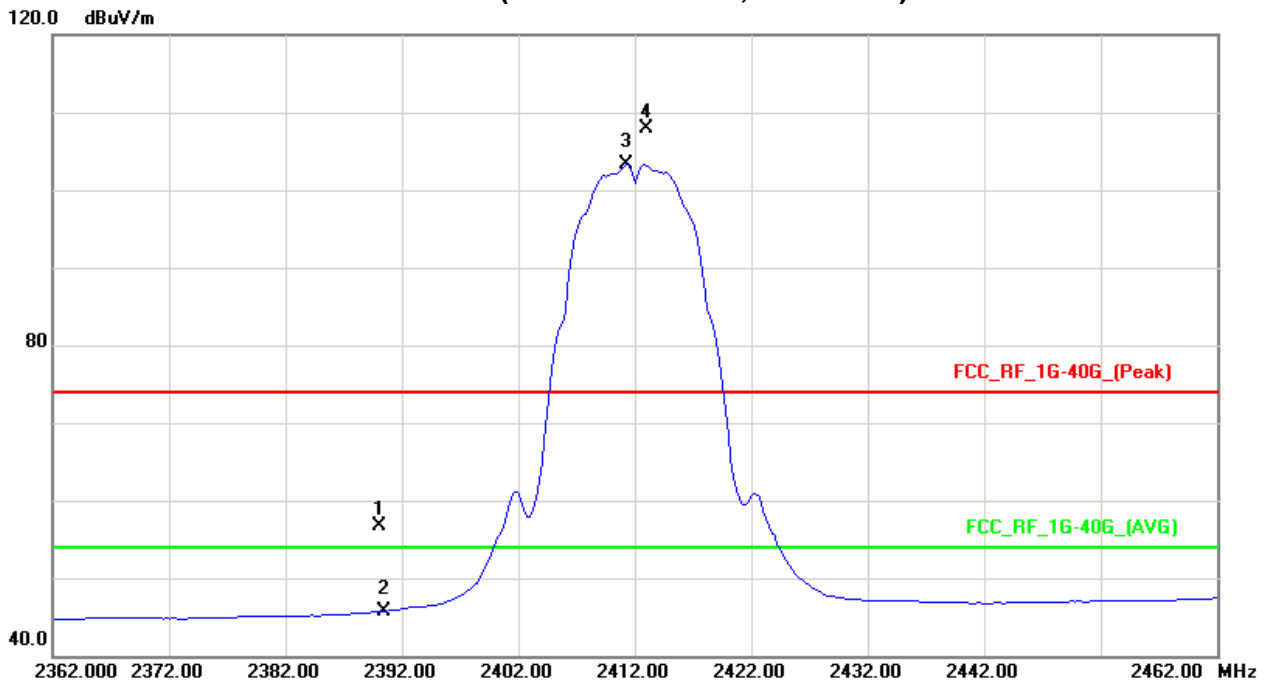



EUT :	Wireless VDSL2 4-port Ethernet Router	Model Name :	DSL-6740B
Temperature :	25 °C	Relative Humidity :	51 %
Pressure :	1010 hPa	Test Voltage :	AC 120V/60Hz
Test Mode :	TX B MODE 2437MHz		

Freq.	Ant.Pol.	Reading		Ant./CF	Act.		Limit		Note
		Peak	AV		Peak	AV	Peak	AV	
(MHz)	H/V	(dBuV)	(dBuV)	CF(dB)	(dBuV/m)	(dBuV/m)	(dBuV/m)	(dBuV/m)	
2438.00	V	72.29	67.98	32.22	104.51	100.20			X/F
4874.55	V	49.36	40.01	6.39	55.75	46.40	74.00	54.00	X/H

Remark :

- (1) All readings are Peak unless otherwise stated QP in column of 『Note』 . Peak denotes that the Peak reading compliance with the QP Limits and then QP Mode measurement didn't perform ◦
- (2) Measuring frequency range from 30MHz to 1000MHz or the 10th harmonic of highest fundamental frequency ◦ "F" denotes fundamental frequency; "H" denotes spurious frequency. "E" denotes band edge frequency. (This judgment method includes the Band Edge Requirement.)
- (3) Radiated emissions measured in frequency range above 1000MHz were made with an instrument using Peak detector mode and AV detector mode of the emission ◦
- (4) Data of measurement within this frequency range shown " * " in the table above means the reading of emissions are attenuated more than 20dB below the permissible limits or the field strength is too small to be measured.
- (5) A preamp and high pass filter were used for this test in order to provide sufficient measurement sensitivity.
- (6) EUT Orthogonal Axis :
 "X" - denotes Laid on Table ; "Y" - denotes Vertical Stand ; "Z" - denotes Side Stand
- (7) During the measurements above 1 GHz it is taken care of that the EUT is always within the 3 dB cone of radiation BW of the used antenna



TX CH06 (Above 1000 MHz, Vertical)

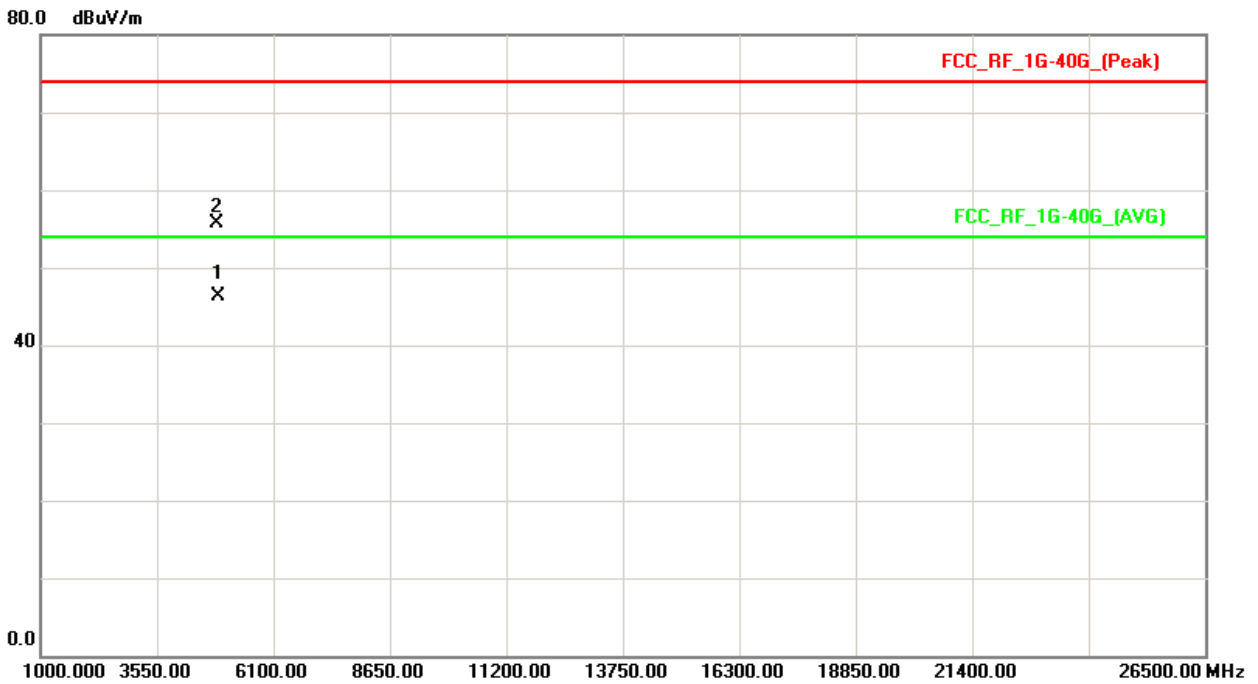
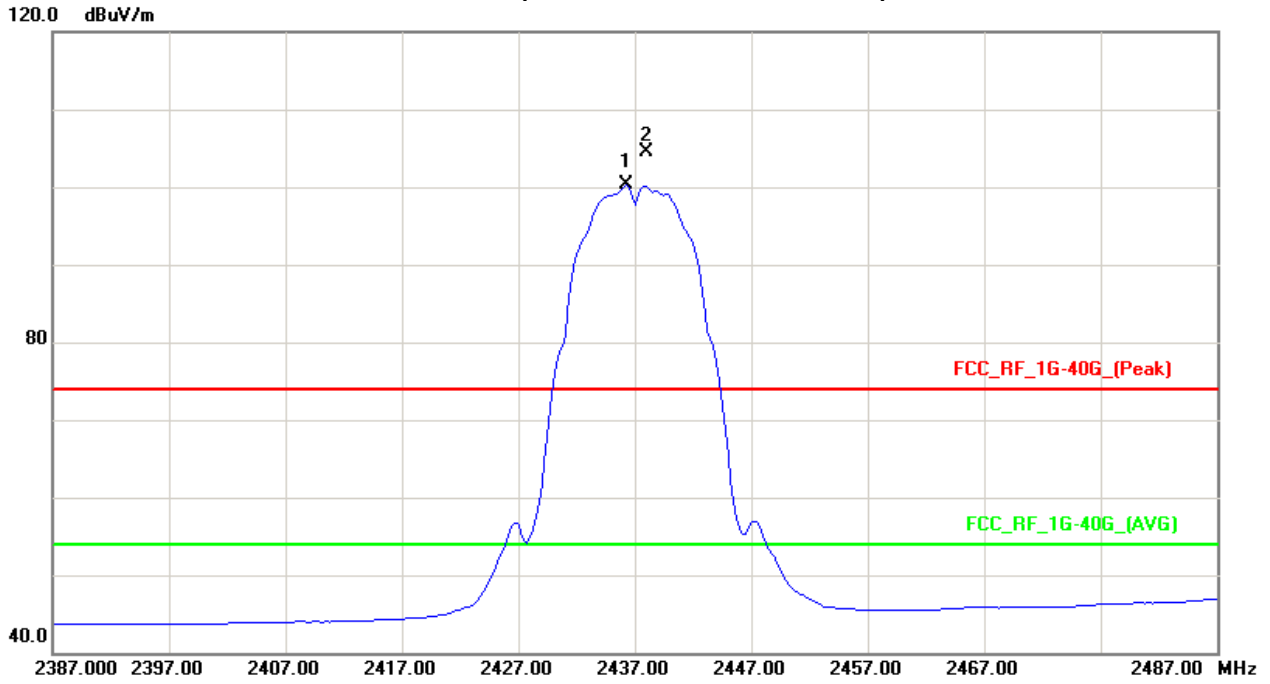



EUT :	Wireless VDSL2 4-port Ethernet Router	Model Name :	DSL-6740B
Temperature :	25 °C	Relative Humidity :	51 %
Pressure :	1010 hPa	Test Voltage :	AC 120V/60Hz
Test Mode :	TX B MODE 2437MHz		

Freq.	Ant.Pol.	Reading		Ant./CF	Act.		Limit		Note
		Peak	AV		Peak	AV	Peak	AV	
(MHz)	H/V	(dBuV)	(dBuV)	CF(dB)	(dBuV/m)	(dBuV/m)	(dBuV/m)	(dBuV/m)	
2436.00	H	70.82	75.13	32.23	103.05	107.36			X/F
4874.36	H	46.85	38.24	6.39	53.24	44.63	74.00	54.00	X/H

Remark :

- (1) All readings are Peak unless otherwise stated QP in column of 『Note』 . Peak denotes that the Peak reading compliance with the QP Limits and then QP Mode measurement didn't perform ◦
- (2) Measuring frequency range from 30MHz to 1000MHz or the 10th harmonic of highest fundamental frequency ◦ "F" denotes fundamental frequency; "H" denotes spurious frequency. "E" denotes band edge frequency. (This judgment method includes the Band Edge Requirement.)
- (3) Radiated emissions measured in frequency range above 1000MHz were made with an instrument using Peak detector mode and AV detector mode of the emission ◦
- (4) Data of measurement within this frequency range shown " * " in the table above means the reading of emissions are attenuated more than 20dB below the permissible limits or the field strength is too small to be measured.
- (5) A preamp and high pass filter were used for this test in order to provide sufficient measurement sensitivity.
- (6) EUT Orthogonal Axis :
"X" - denotes Laid on Table ; "Y" - denotes Vertical Stand ; "Z" - denotes Side Stand
- (7) During the measurements above 1 GHz it is taken care of that the EUT is always within the 3 dB cone of radiation BW of the used antenna



TX CH06 (Above 1000 MHz, Horizontal)

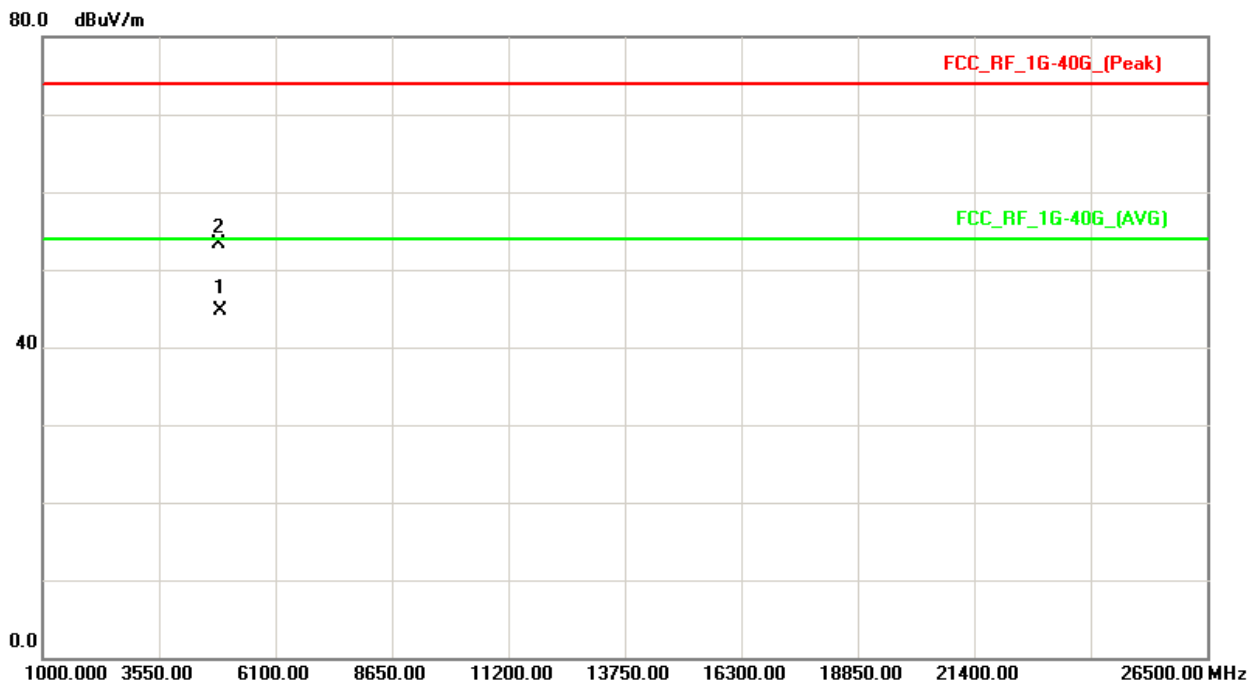
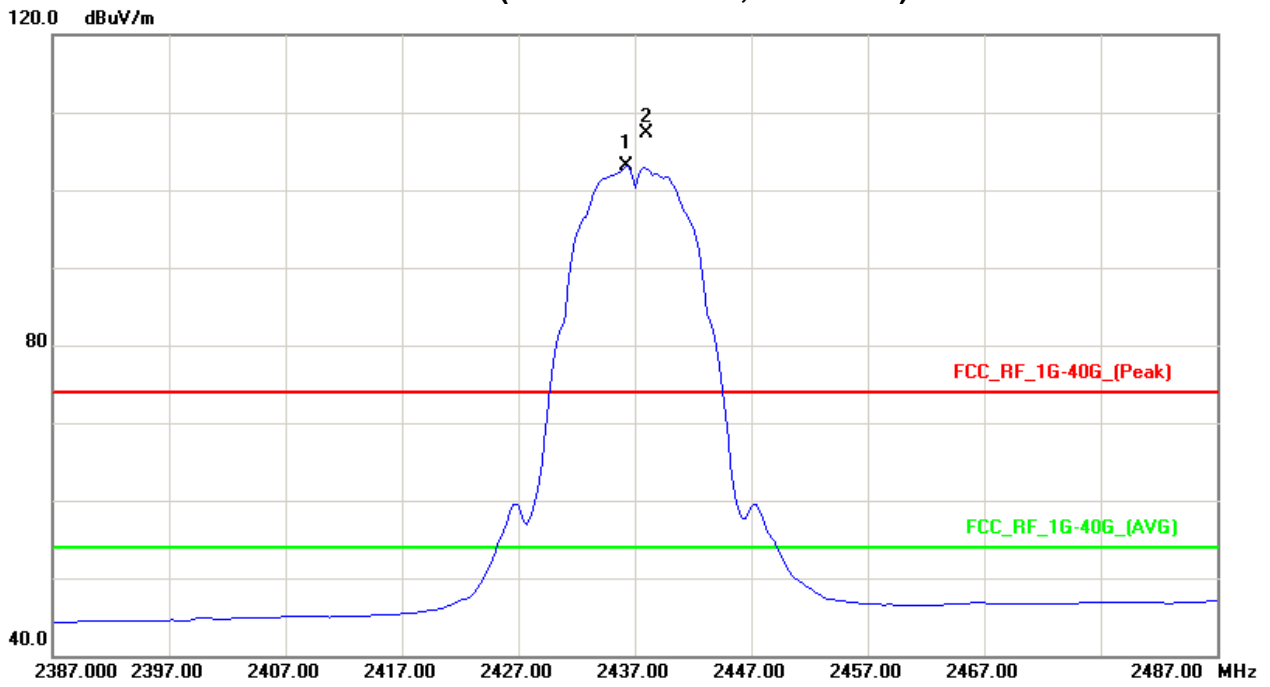



EUT :	Wireless VDSL2 4-port Ethernet Router	Model Name :	DSL-6740B
Temperature :	25 °C	Relative Humidity :	51 %
Pressure :	1010 hPa	Test Voltage :	AC 120V/60Hz
Test Mode :	TX B MODE 2462MHz		

Freq.	Ant.Pol.	Reading		Ant./CF	Act.		Limit		Note
		Peak	AV		Peak	AV	Peak	AV	
(MHz)	H/V	(dBuV)	(dBuV)	CF(dB)	(dBuV/m)	(dBuV/m)	(dBuV/m)	(dBuV/m)	
2463.00	V	71.22	66.79	32.20	103.42	98.99			X/F
2483.50	V	24.89	14.10	32.17	57.06	46.27	74.00	54.00	X/E
4924.75	V	48.14	39.74	6.59	54.73	46.33	74.00	54.00	X/H

Remark :

- (1) All readings are Peak unless otherwise stated QP in column of 『Note』 . Peak denotes that the Peak reading compliance with the QP Limits and then QP Mode measurement didn't perform ◦
- (2) Measuring frequency range from 30MHz to 1000MHz or the 10th harmonic of highest fundamental frequency ◦ "F" denotes fundamental frequency; "H" denotes spurious frequency. "E" denotes band edge frequency. (This judgment method includes the Band Edge Requirement.)
- (3) Radiated emissions measured in frequency range above 1000MHz were made with an instrument using Peak detector mode and AV detector mode of the emission ◦
- (4) Data of measurement within this frequency range shown " * " in the table above means the reading of emissions are attenuated more than 20dB below the permissible limits or the field strength is too small to be measured.
- (5) A preamp and high pass filter were used for this test in order to provide sufficient measurement sensitivity.
- (6) EUT Orthogonal Axis :
"X" - denotes Laid on Table ; "Y" - denotes Vertical Stand ; "Z" - denotes Side Stand
- (7) During the measurements above 1 GHz it is taken care of that the EUT is always within the 3 dB cone of radiation BW of the used antenna



TX CH11 (Above 1000 MHz, Vertical)

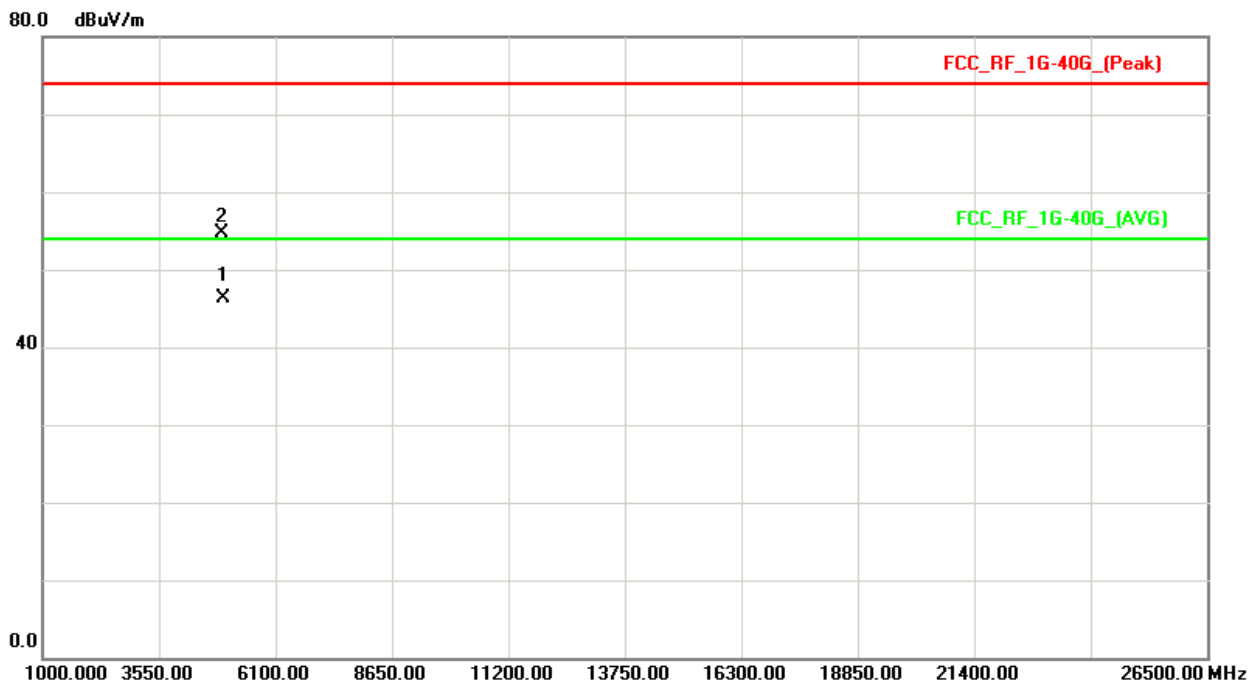
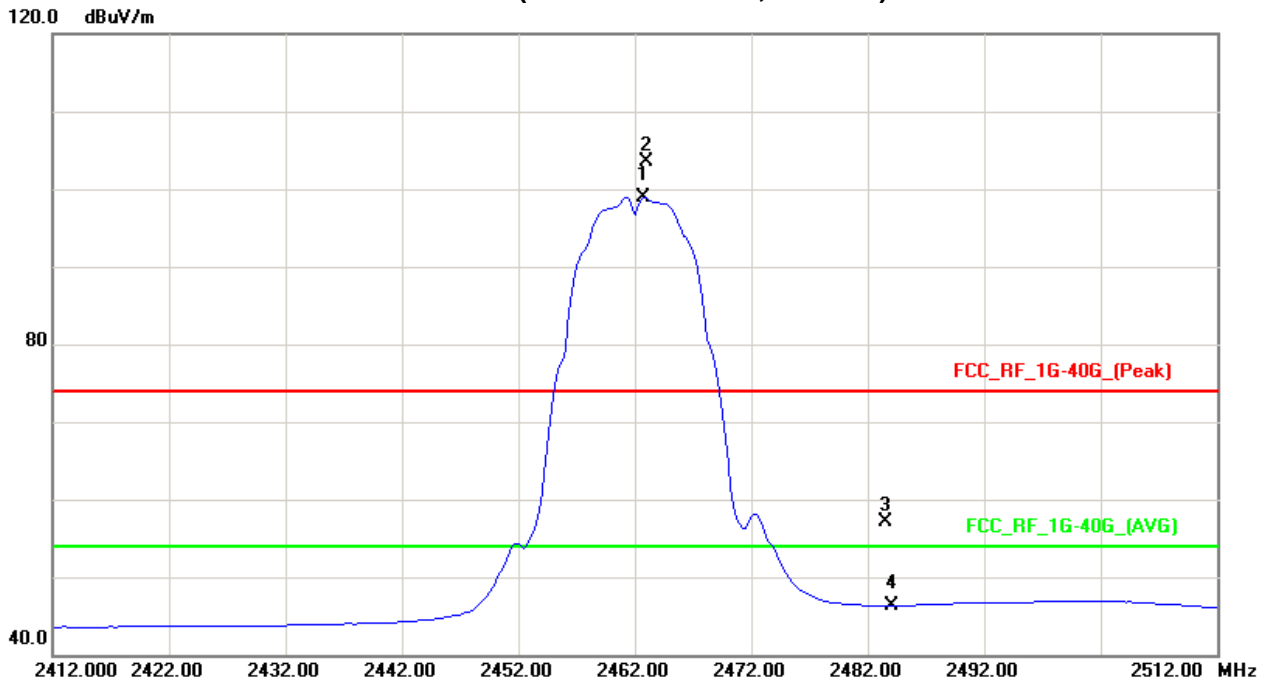



EUT :	Wireless VDSL2 4-port Ethernet Router	Model Name :	DSL-6740B
Temperature :	25 °C	Relative Humidity :	51 %
Pressure :	1010 hPa	Test Voltage :	AC 120V/60Hz
Test Mode :	TX B MODE 2462MHz		

Freq.	Ant.Pol.	Reading		Ant./CF	Act.		Limit		Note
		Peak	AV		Peak	AV	Peak	AV	
(MHz)	H/V	(dBuV)	(dBuV)	CF(dB)	(dBuV/m)	(dBuV/m)	(dBuV/m)	(dBuV/m)	
2463.00	H	74.14	69.58	32.20	106.34	101.78			X/F
2483.50	H	25.05	15.22	32.17	57.22	47.39	74.00	54.00	X/E
4924.15	H	46.75	36.58	6.59	53.34	43.17	74.00	54.00	X/H

Remark :

- (1) All readings are Peak unless otherwise stated QP in column of 『Note』 . Peak denotes that the Peak reading compliance with the QP Limits and then QP Mode measurement didn't perform ◦
- (2) Measuring frequency range from 30MHz to 1000MHz or the 10th harmonic of highest fundamental frequency ◦ "F" denotes fundamental frequency; "H" denotes spurious frequency. "E" denotes band edge frequency. (This judgment method includes the Band Edge Requirement.)
- (3) Radiated emissions measured in frequency range above 1000MHz were made with an instrument using Peak detector mode and AV detector mode of the emission ◦
- (4) Data of measurement within this frequency range shown " * " in the table above means the reading of emissions are attenuated more than 20dB below the permissible limits or the field strength is too small to be measured.
- (5) A preamp and high pass filter were used for this test in order to provide sufficient measurement sensitivity.
- (6) EUT Orthogonal Axis :
"X" - denotes Laid on Table ; "Y" - denotes Vertical Stand ; "Z" - denotes Side Stand
- (7) During the measurements above 1 GHz it is taken care of that the EUT is always within the 3 dB cone of radiation BW of the used antenna



TX CH11 (Above 1000 MHz, Horizontal)

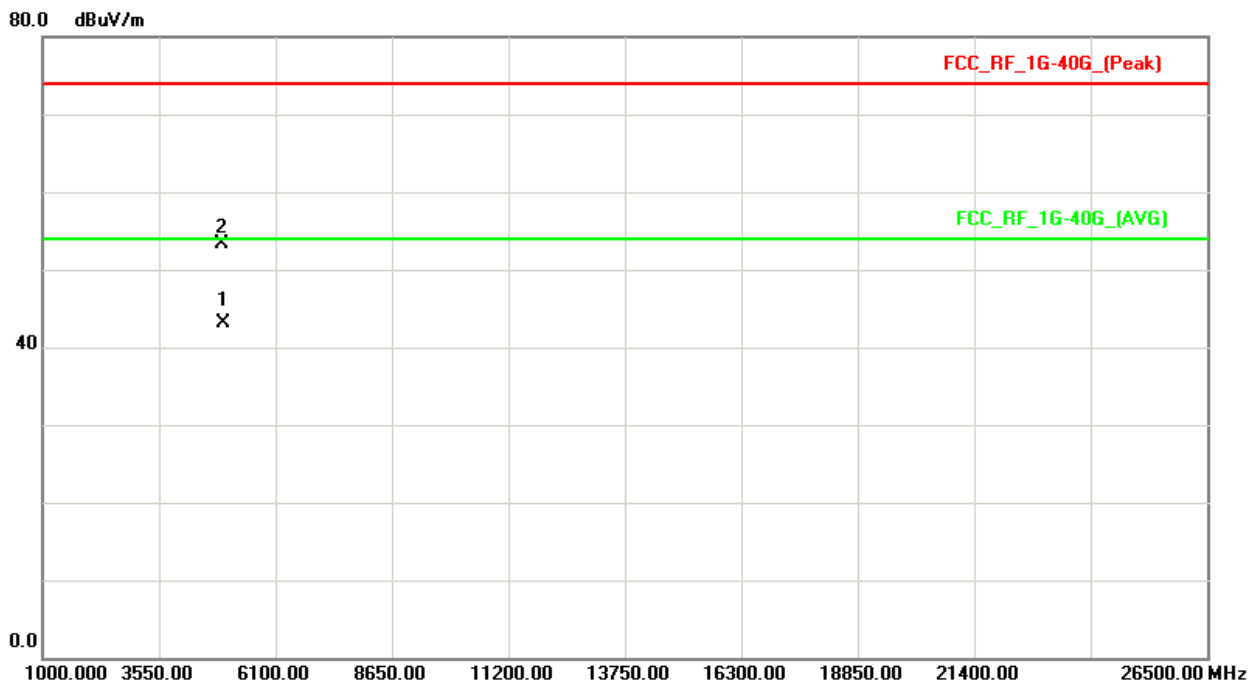
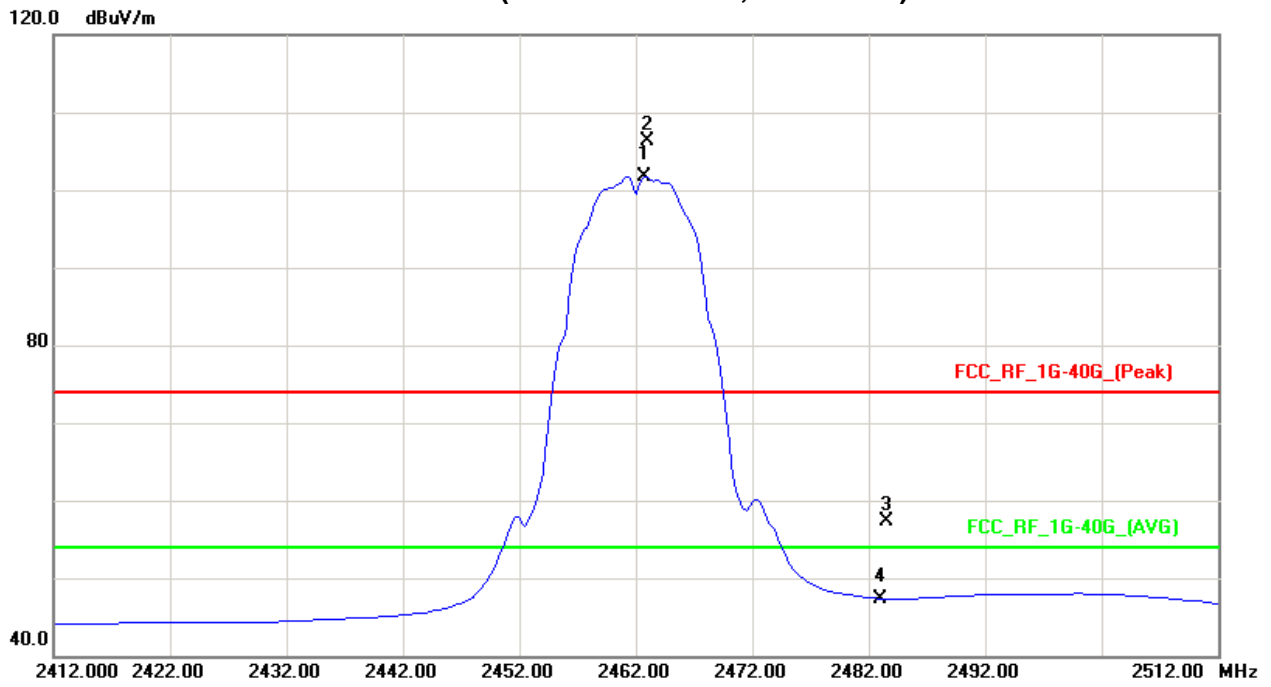



EUT :	Wireless VDSL2 4-port Ethernet Router	Model Name :	DSL-6740B
Temperature :	25 °C	Relative Humidity :	51 %
Pressure :	1010 hPa	Test Voltage :	AC 120V/60Hz
Test Mode :	TX G MODE 2412MHz		

Freq. (MHz)	Ant.Pol. H/V	Reading		Ant./CF CF(dB)	Act.		Limit		Note
		Peak (dBuV)	AV (dBuV)		Peak (dBuV/m)	AV (dBuV/m)	Peak (dBuV/m)	AV (dBuV/m)	
2380.50	V	27.11	16.36	32.29	59.40	48.65	74.00	54.00	X/E
2390.00	V	26.71	15.85	32.28	58.99	48.13	74.00	54.00	X/E
2411.25	V	71.94	59.32	32.26	104.20	91.58			X/F
4824.35	V	44.24	35.30	6.19	50.43	41.49	74.00	54.00	X/H

Remark :

- (1) All readings are Peak unless otherwise stated QP in column of 『Note』 . Peak denotes that the Peak reading compliance with the QP Limits and then QP Mode measurement didn't perform ◦
- (2) Measuring frequency range from 30MHz to 1000MHz or the 10th harmonic of highest fundamental frequency ◦ "F" denotes fundamental frequency; "H" denotes spurious frequency. "E" denotes band edge frequency. (This judgment method includes the Band Edge Requirement.)
- (3) Radiated emissions measured in frequency range above 1000MHz were made with an instrument using Peak detector mode and AV detector mode of the emission ◦
- (4) Data of measurement within this frequency range shown " * " in the table above means the reading of emissions are attenuated more than 20dB below the permissible limits or the field strength is too small to be measured.
- (5) A preamp and high pass filter were used for this test in order to provide sufficient measurement sensitivity.
- (6) EUT Orthogonal Axis :
"X" - denotes Laid on Table ; "Y" - denotes Vertical Stand ; "Z" - denotes Side Stand
- (7) During the measurements above 1 GHz it is taken care of that the EUT is always within the 3 dB cone of radiation BW of the used antenna



TX CH01 (Above 1000 MHz, Vertical)

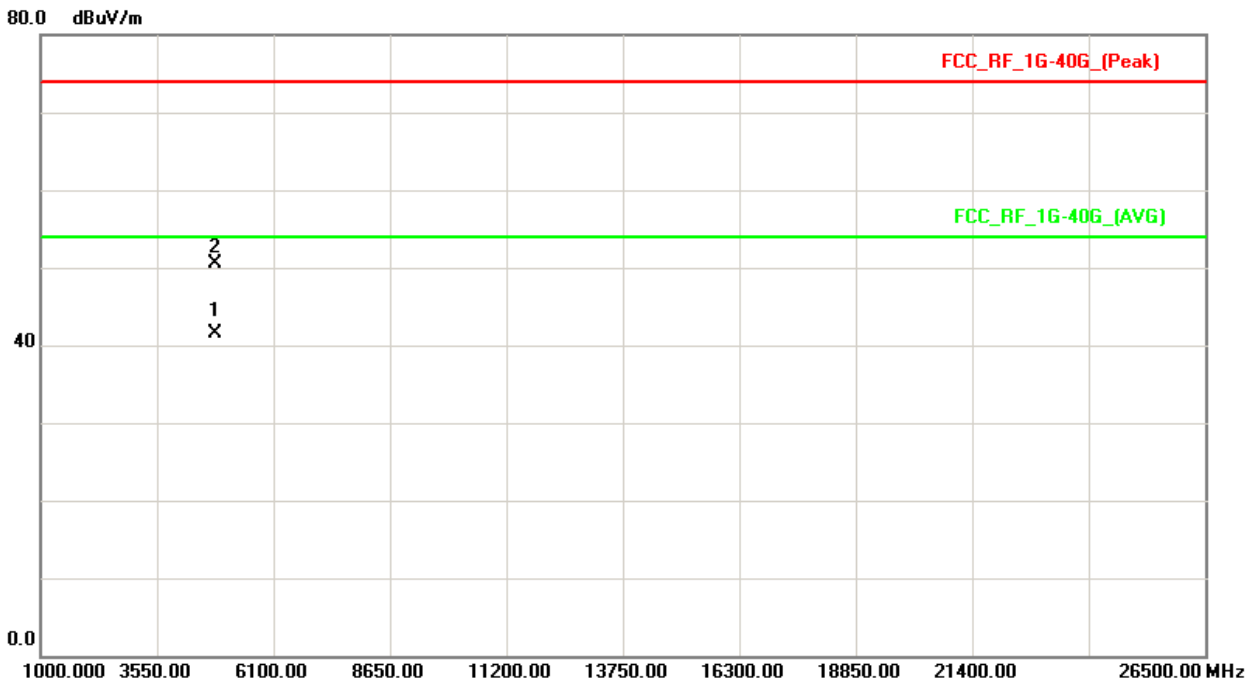
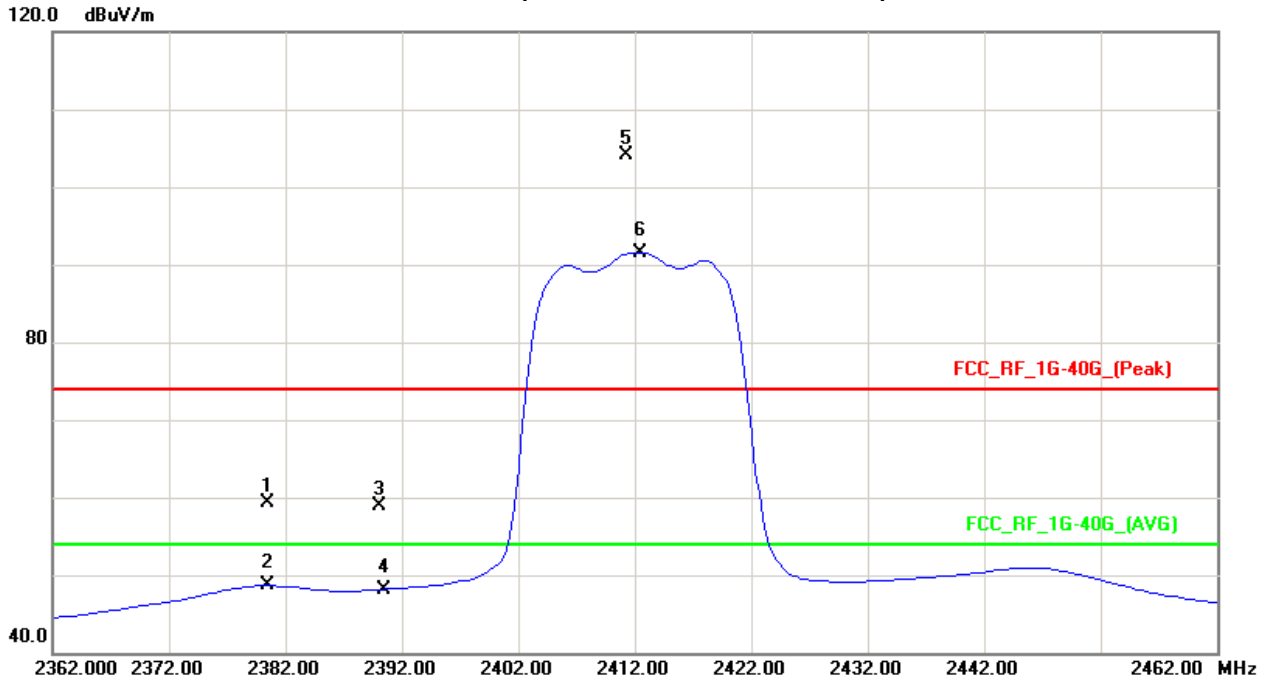



EUT :	Wireless VDSL2 4-port Ethernet Router	Model Name :	DSL-6740B
Temperature :	25 °C	Relative Humidity :	51 %
Pressure :	1010 hPa	Test Voltage :	AC 120V/60Hz
Test Mode :	TX G MODE 2412MHz		

Freq. (MHz)	Ant.Pol. H/V	Reading		Ant./CF CF(dB)	Act.		Limit		Note
		Peak (dBuV)	AV (dBuV)		Peak (dBuV/m)	AV (dBuV/m)	Peak (dBuV/m)	AV (dBuV/m)	
2380.50	H	29.56	18.59	32.29	61.85	50.88	74.00	54.00	X/E
2390.00	H	27.49	17.79	32.28	59.77	50.07	74.00	54.00	X/E
2412.50	H	74.36	61.67	32.26	106.62	93.93			X/F
4924.14	H	41.24	28.35	6.19	47.43	34.54	74.00	54.00	X/H

Remark :

- (1) All readings are Peak unless otherwise stated QP in column of 『Note』 . Peak denotes that the Peak reading compliance with the QP Limits and then QP Mode measurement didn't perform ◦
- (2) Measuring frequency range from 30MHz to 1000MHz or the 10th harmonic of highest fundamental frequency ◦ "F" denotes fundamental frequency; "H" denotes spurious frequency. "E" denotes band edge frequency. (This judgment method includes the Band Edge Requirement.)
- (3) Radiated emissions measured in frequency range above 1000MHz were made with an instrument using Peak detector mode and AV detector mode of the emission ◦
- (4) Data of measurement within this frequency range shown " * " in the table above means the reading of emissions are attenuated more than 20dB below the permissible limits or the field strength is too small to be measured.
- (5) A preamp and high pass filter were used for this test in order to provide sufficient measurement sensitivity.
- (6) EUT Orthogonal Axis :
"X" - denotes Laid on Table ; "Y" - denotes Vertical Stand ; "Z" - denotes Side Stand
- (7) During the measurements above 1 GHz it is taken care of that the EUT is always within the 3 dB cone of radiation BW of the used antenna



TX CH01 (Above 1000 MHz, Horizontal)

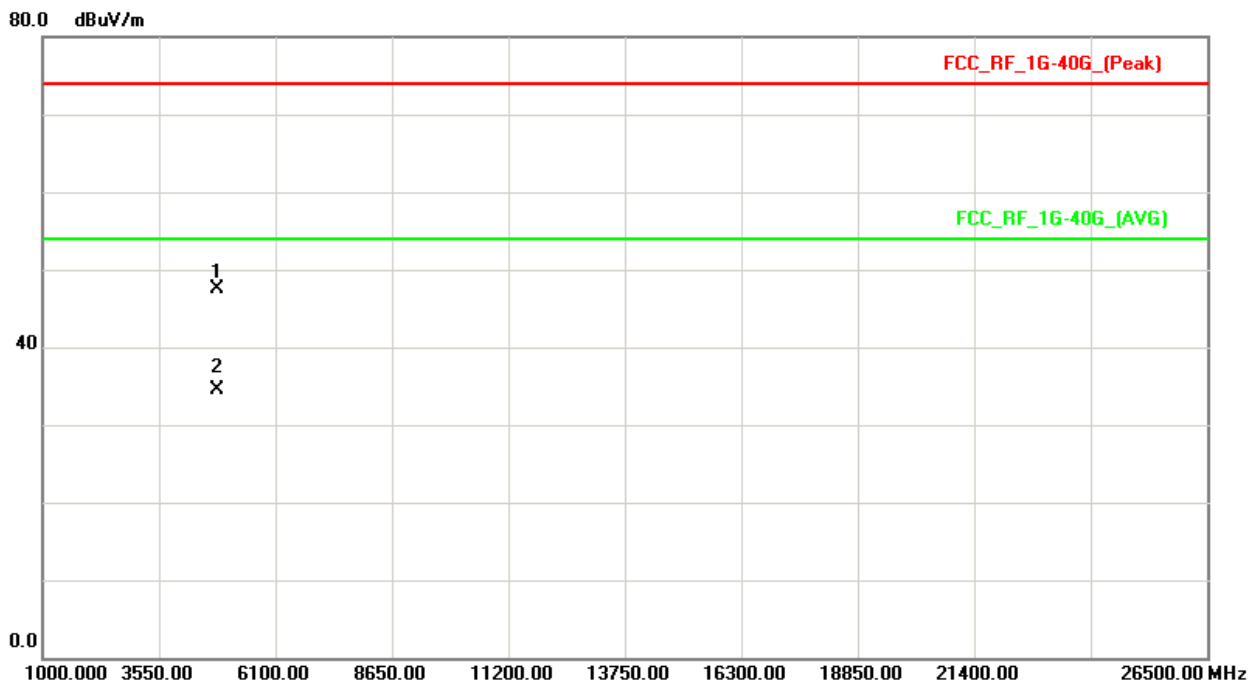
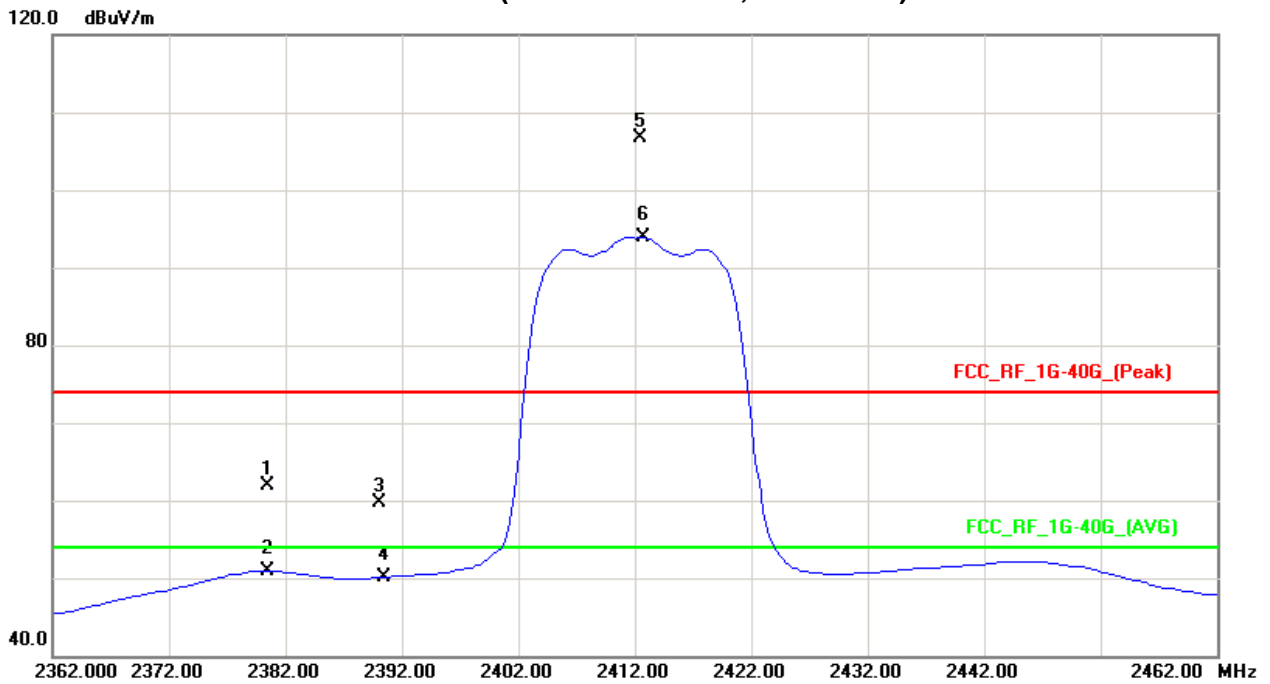



EUT :	Wireless VDSL2 4-port Ethernet Router	Model Name :	DSL-6740B
Temperature :	25 °C	Relative Humidity :	51 %
Pressure :	1010 hPa	Test Voltage :	AC 120V/60Hz
Test Mode :	TX G MODE 2437MHz-		

Freq. (MHz)	Ant.Pol. H/V	Reading		Ant./CF CF(dB)	Act.		Limit		Note
		Peak (dBuV)	AV (dBuV)		Peak (dBuV/m)	AV (dBuV/m)	Peak (dBuV/m)	AV (dBuV/m)	
2437.00	V	71.12	58.28	32.23	103.35	90.51			X/F
4874.22	V	43.47	36.36	6.39	49.86	42.75	74.00	54.00	X/H

Remark :

- (1) All readings are Peak unless otherwise stated QP in column of 『Note』 . Peak denotes that the Peak reading compliance with the QP Limits and then QP Mode measurement didn't perform ◦
- (2) Measuring frequency range from 30MHz to 1000MHz or the 10th harmonic of highest fundamental frequency ◦ "F" denotes fundamental frequency; "H" denotes spurious frequency. "E" denotes band edge frequency. (This judgment method includes the Band Edge Requirement.)
- (3) Radiated emissions measured in frequency range above 1000MHz were made with an instrument using Peak detector mode and AV detector mode of the emission ◦
- (4) Data of measurement within this frequency range shown " * " in the table above means the reading of emissions are attenuated more than 20dB below the permissible limits or the field strength is too small to be measured.
- (5) A preamp and high pass filter were used for this test in order to provide sufficient measurement sensitivity.
- (6) EUT Orthogonal Axis :
"X" - denotes Laid on Table ; "Y" - denotes Vertical Stand ; "Z" - denotes Side Stand
- (7) During the measurements above 1 GHz it is taken care of that the EUT is always within the 3 dB cone of radiation BW of the used antenna



TX CH06 (Above 1000 MHz, Vertical)

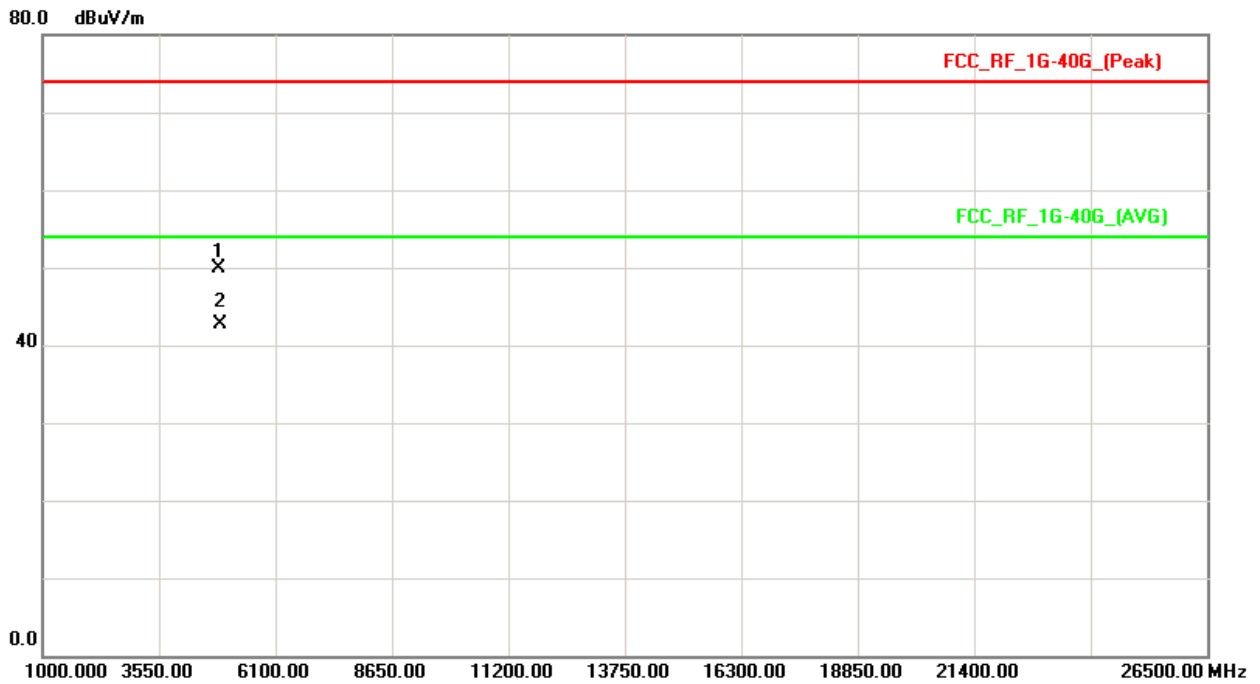
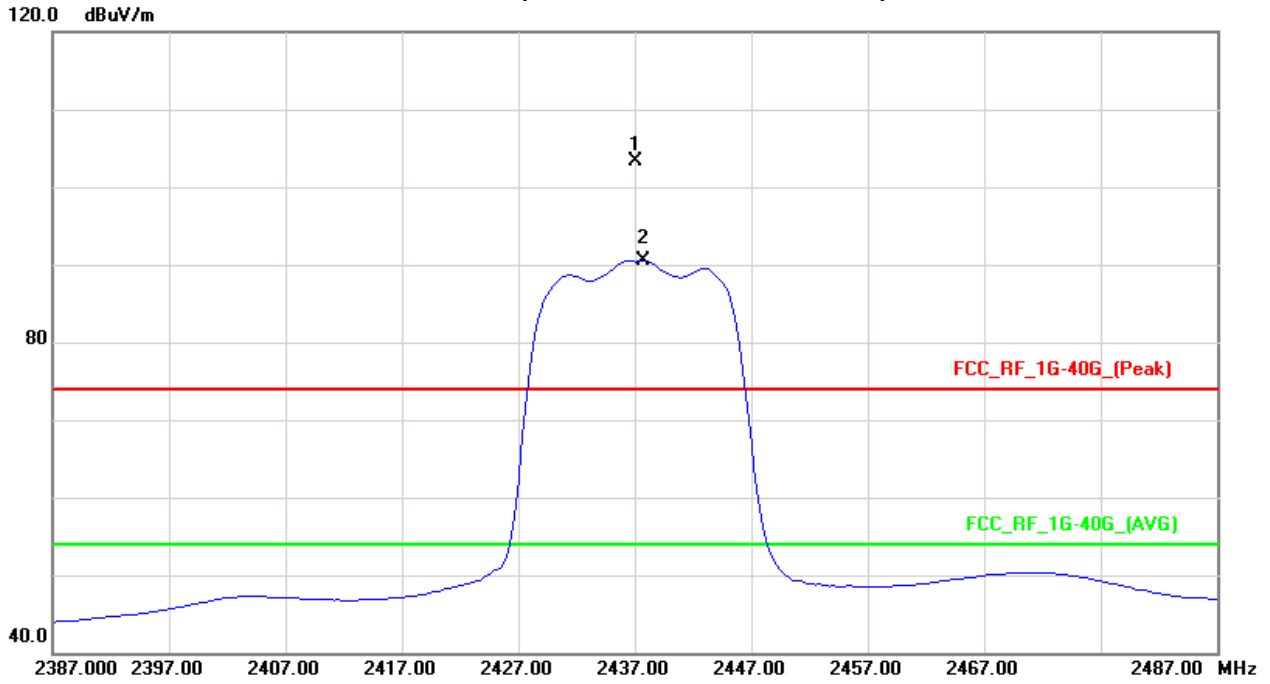



EUT :	Wireless VDSL2 4-port Ethernet Router	Model Name :	DSL-6740B
Temperature :	25 °C	Relative Humidity :	51 %
Pressure :	1010 hPa	Test Voltage :	AC 120V/60Hz
Test Mode :	TX G MODE 2437MHz		

Freq. (MHz)	Ant.Pol. H/V	Reading		Ant./CF CF(dB)	Act.		Limit		Note
		Peak (dBuV)	AV (dBuV)		Peak (dBuV/m)	AV (dBuV/m)	Peak (dBuV/m)	AV (dBuV/m)	
2438.25	H	74.07	60.98	32.23	106.30	93.21			X/F
4874.75	H	41.05	30.14	6.39	47.44	36.53	74.00	54.00	X/H

Remark :

- (1) All readings are Peak unless otherwise stated QP in column of 『Note』 . Peak denotes that the Peak reading compliance with the QP Limits and then QP Mode measurement didn't perform ◦
- (2) Measuring frequency range from 30MHz to 1000MHz or the 10th harmonic of highest fundamental frequency ◦ "F" denotes fundamental frequency; "H" denotes spurious frequency. "E" denotes band edge frequency. (This judgment method includes the Band Edge Requirement.)
- (3) Radiated emissions measured in frequency range above 1000MHz were made with an instrument using Peak detector mode and AV detector mode of the emission ◦
- (4) Data of measurement within this frequency range shown " * " in the table above means the reading of emissions are attenuated more than 20dB below the permissible limits or the field strength is too small to be measured.
- (5) A preamp and high pass filter were used for this test in order to provide sufficient measurement sensitivity.
- (6) EUT Orthogonal Axis :
"X" - denotes Laid on Table ; "Y" - denotes Vertical Stand ; "Z" - denotes Side Stand
- (7) During the measurements above 1 GHz it is taken care of that the EUT is always within the 3 dB cone of radiation BW of the used antenna



TX CH06 (Above 1000 MHz, Horizontal)

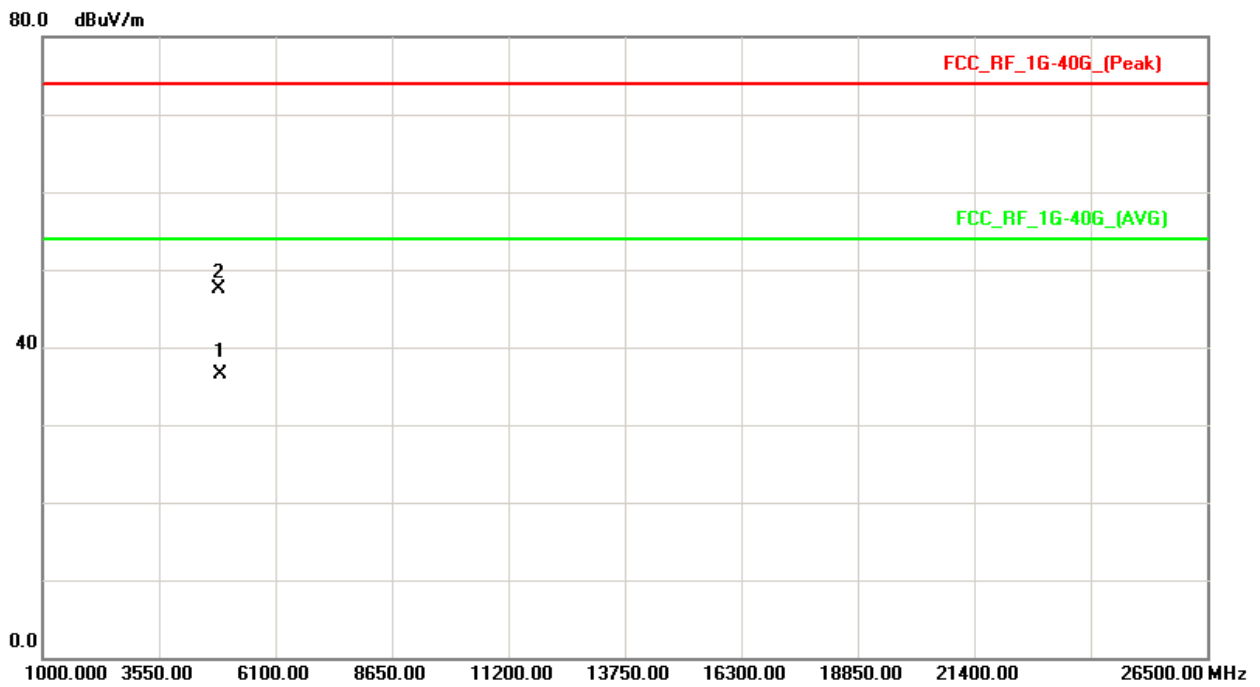
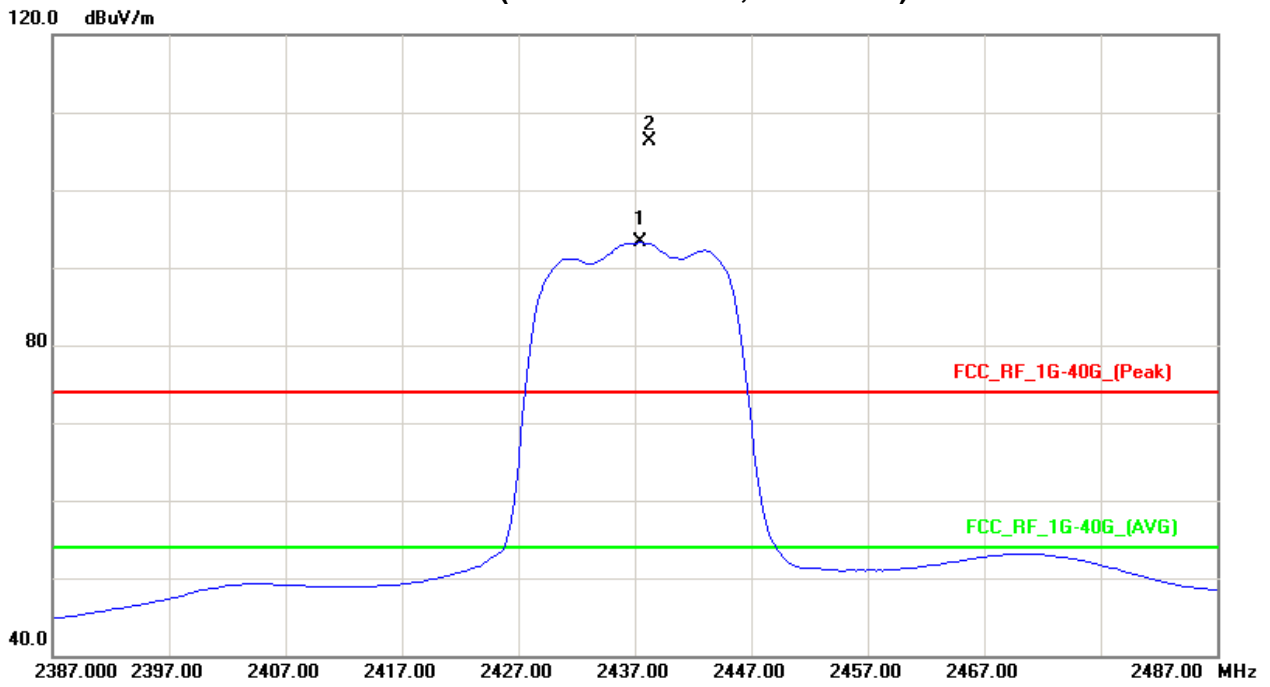



EUT :	Wireless VDSL2 4-port Ethernet Router	Model Name :	DSL-6740B
Temperature :	25 °C	Relative Humidity :	51 %
Pressure :	1010 hPa	Test Voltage :	AC 120V/60Hz
Test Mode :	TX G MODE 2462MHz		

Freq. (MHz)	Ant.Pol. H/V	Reading		Ant./CF CF(dB)	Act.		Limit		Note
		Peak (dBuV)	AV (dBuV)		Peak (dBuV/m)	AV (dBuV/m)	Peak (dBuV/m)	AV (dBuV/m)	
2462.75	V	69.70	56.31	32.20	101.90	88.51			X/F
2483.50	V	27.67	16.05	32.17	59.84	48.22	74.00	54.00	X/E
2494.75	V	30.07	18.49	32.17	62.24	50.66	74.00	54.00	X/E
4924.35	V	43.54	36.24	6.59	50.13	42.83	74.00	54.00	X/H

Remark :

- (1) All readings are Peak unless otherwise stated QP in column of 『Note』 . Peak denotes that the Peak reading compliance with the QP Limits and then QP Mode measurement didn't perform ◦
- (2) Measuring frequency range from 30MHz to 1000MHz or the 10th harmonic of highest fundamental frequency ◦ "F" denotes fundamental frequency; "H" denotes spurious frequency. "E" denotes band edge frequency. (This judgment method includes the Band Edge Requirement.)
- (3) Radiated emissions measured in frequency range above 1000MHz were made with an instrument using Peak detector mode and AV detector mode of the emission ◦
- (4) Data of measurement within this frequency range shown " * " in the table above means the reading of emissions are attenuated more than 20dB below the permissible limits or the field strength is too small to be measured.
- (5) A preamp and high pass filter were used for this test in order to provide sufficient measurement sensitivity.
- (6) EUT Orthogonal Axis :
"X" - denotes Laid on Table ; "Y" - denotes Vertical Stand ; "Z" - denotes Side Stand
- (7) During the measurements above 1 GHz it is taken care of that the EUT is always within the 3 dB cone of radiation BW of the used antenna



TX CH11 (Above 1000 MHz, Vertical)

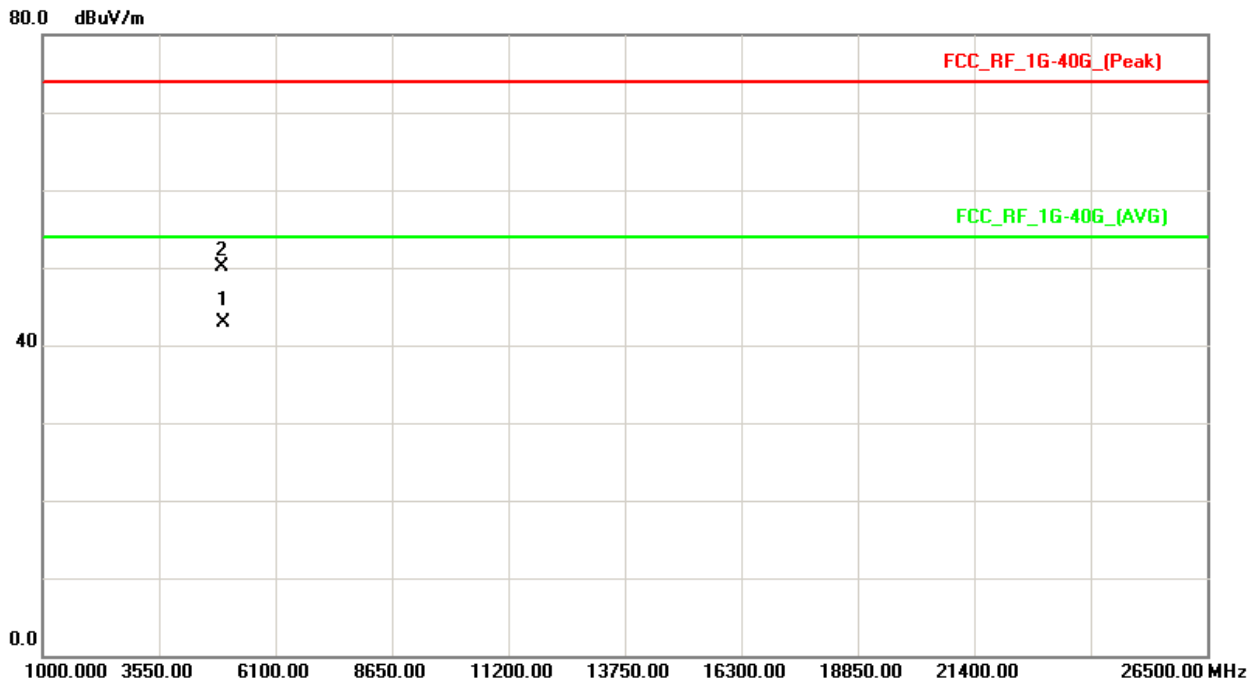
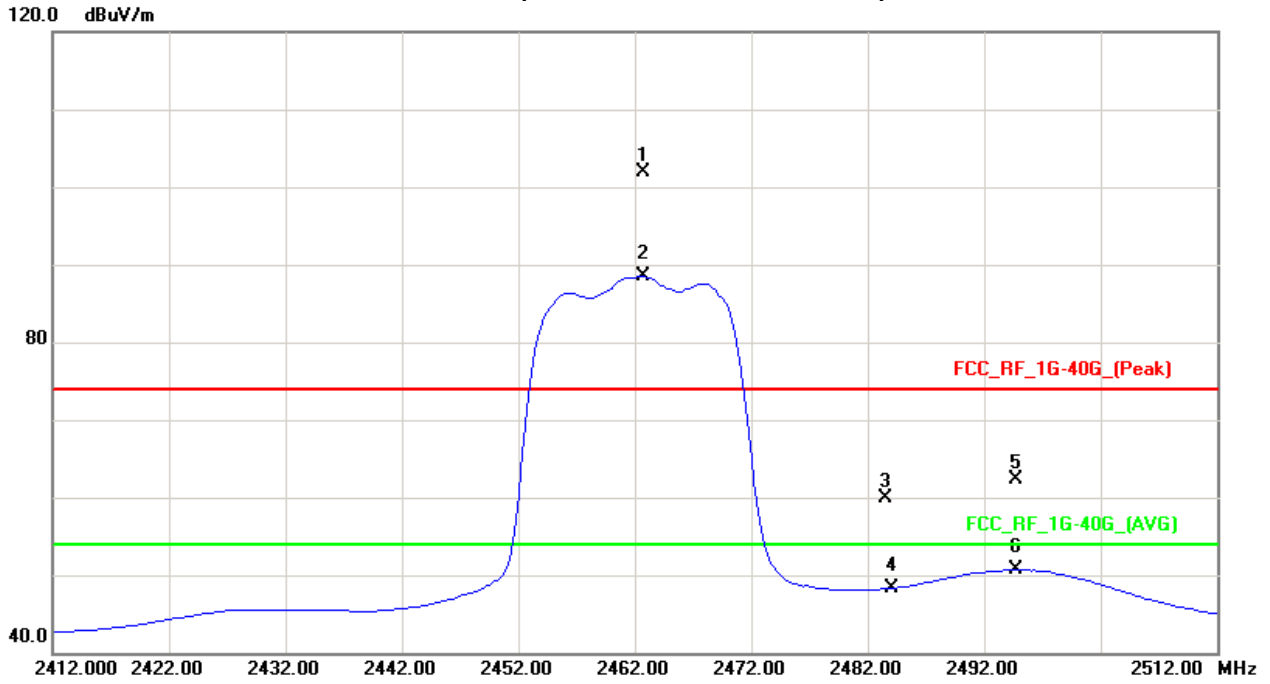



EUT :	Wireless VDSL2 4-port Ethernet Router	Model Name :	DSL-6740B
Temperature :	25 °C	Relative Humidity :	51 %
Pressure :	1010 hPa	Test Voltage :	AC 120V/60Hz
Test Mode :	TX G MODE 2462MHz		

Freq. (MHz)	Ant.Pol. H/V	Reading		Ant./CF CF(dB)	Act.		Limit		Note
		Peak (dBuV)	AV (dBuV)		Peak (dBuV/m)	AV (dBuV/m)	Peak (dBuV/m)	AV (dBuV/m)	
2462.25	H	72.82	57.92	32.21	105.03	90.13			X/F
2483.50	H	29.59	16.54	32.17	61.76	48.71	74.00	54.00	X/E
2483.50	H	35.32	18.70	32.16	67.48	50.86	74.00	54.00	X/E
4924.55	H	39.35	28.94	6.59	45.94	35.53	74.00	54.00	X/H

Remark :

- (1) All readings are Peak unless otherwise stated QP in column of 『Note』 . Peak denotes that the Peak reading compliance with the QP Limits and then QP Mode measurement didn't perform ◦
- (2) Measuring frequency range from 30MHz to 1000MHz or the 10th harmonic of highest fundamental frequency ◦ "F" denotes fundamental frequency; "H" denotes spurious frequency. "E" denotes band edge frequency. (This judgment method includes the Band Edge Requirement.)
- (3) Radiated emissions measured in frequency range above 1000MHz were made with an instrument using Peak detector mode and AV detector mode of the emission ◦
- (4) Data of measurement within this frequency range shown " * " in the table above means the reading of emissions are attenuated more than 20dB below the permissible limits or the field strength is too small to be measured.
- (5) A preamp and high pass filter were used for this test in order to provide sufficient measurement sensitivity.
- (6) EUT Orthogonal Axis :
"X" - denotes Laid on Table ; "Y" - denotes Vertical Stand ; "Z" - denotes Side Stand
- (7) During the measurements above 1 GHz it is taken care of that the EUT is always within the 3 dB cone of radiation BW of the used antenna



TX CH11 (Above 1000 MHz, Horizontal)

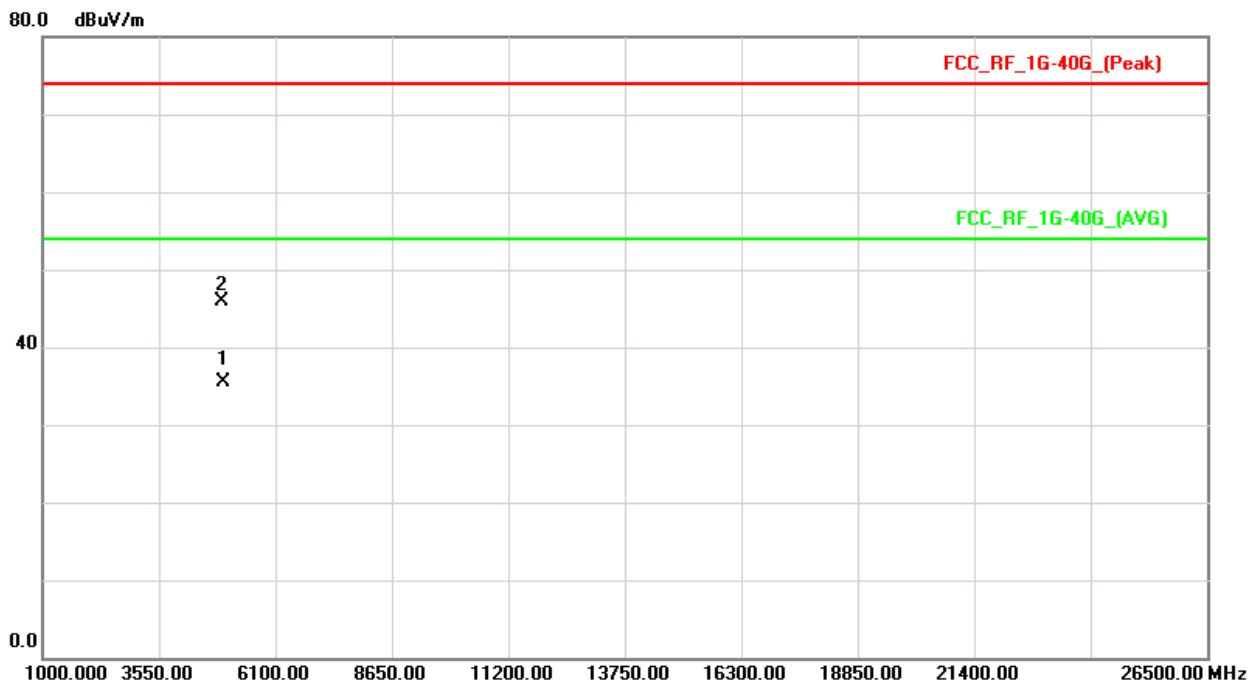
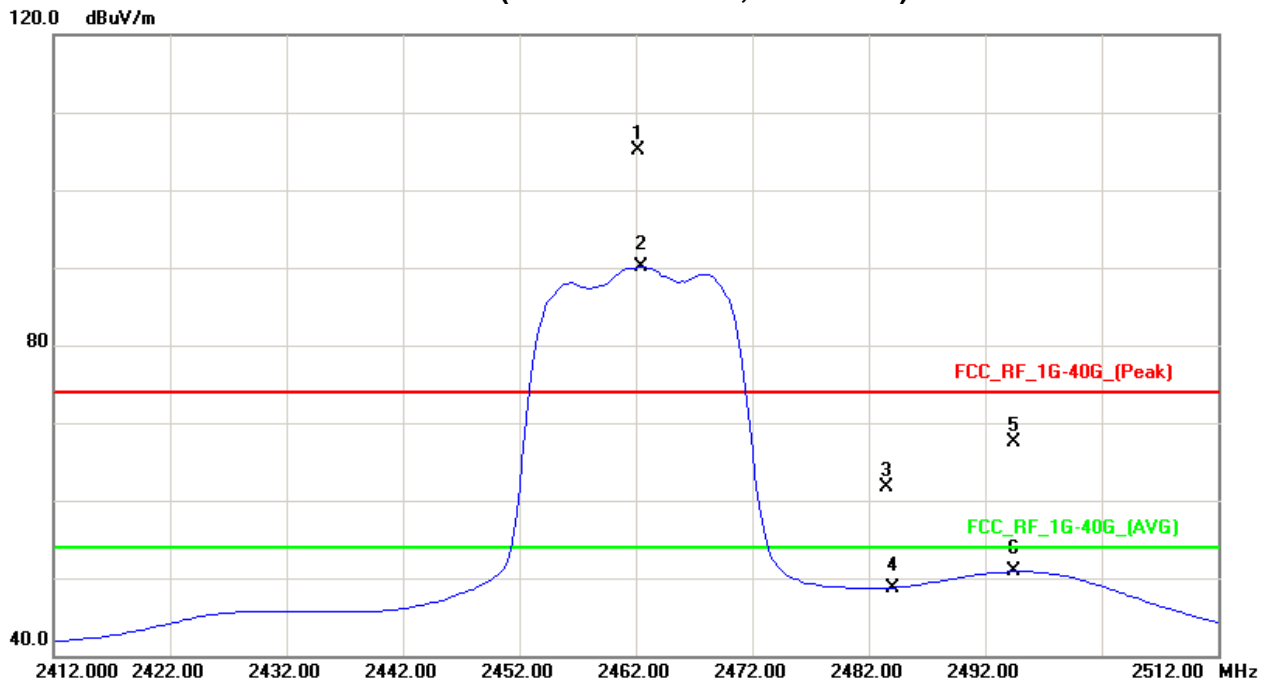



EUT :	Wireless VDSL2 4-port Ethernet Router	Model Name :	DSL-6740B
Temperature :	25 °C	Relative Humidity :	51 %
Pressure :	1010 hPa	Test Voltage :	AC 120V/60Hz
Test Mode :	TX N-20M MODE 2412MHz		

Freq. (MHz)	Ant.Pol. H/V	Reading		Ant./CF CF(dB)	Act.		Limit		Note
		Peak (dBuV)	AV (dBuV)		Peak (dBuV/m)	AV (dBuV/m)	Peak (dBuV/m)	AV (dBuV/m)	
2380.75	V	28.50	15.02	32.29	60.79	47.31	74.00	54.00	X/E
2390.00	V	29.77	14.89	32.28	62.05	47.17	74.00	54.00	X/E
2411.65	V	72.12	43.74	32.26	104.38	76.00			X/F
4824.35	V	43.24	36.57	6.19	49.43	42.76	74.00	54.00	X/H

Remark :

- (1) All readings are Peak unless otherwise stated QP in column of 『Note』 . Peak denotes that the Peak reading compliance with the QP Limits and then QP Mode measurement didn't perform ◦
- (2) Measuring frequency range from 30MHz to 1000MHz or the 10th harmonic of highest fundamental frequency ◦ "F" denotes fundamental frequency; "H" denotes spurious frequency. "E" denotes band edge frequency. (This judgment method includes the Band Edge Requirement.)
- (3) Radiated emissions measured in frequency range above 1000MHz were made with an instrument using Peak detector mode and AV detector mode of the emission ◦
- (4) Data of measurement within this frequency range shown " * " in the table above means the reading of emissions are attenuated more than 20dB below the permissible limits or the field strength is too small to be measured.
- (5) A preamp and high pass filter were used for this test in order to provide sufficient measurement sensitivity.
- (6) EUT Orthogonal Axis :
"X" - denotes Laid on Table ; "Y" - denotes Vertical Stand ; "Z" - denotes Side Stand
- (7) During the measurements above 1 GHz it is taken care of that the EUT is always within the 3 dB cone of radiation BW of the used antenna



TX CH01 (Above 1000 MHz, Vertical)

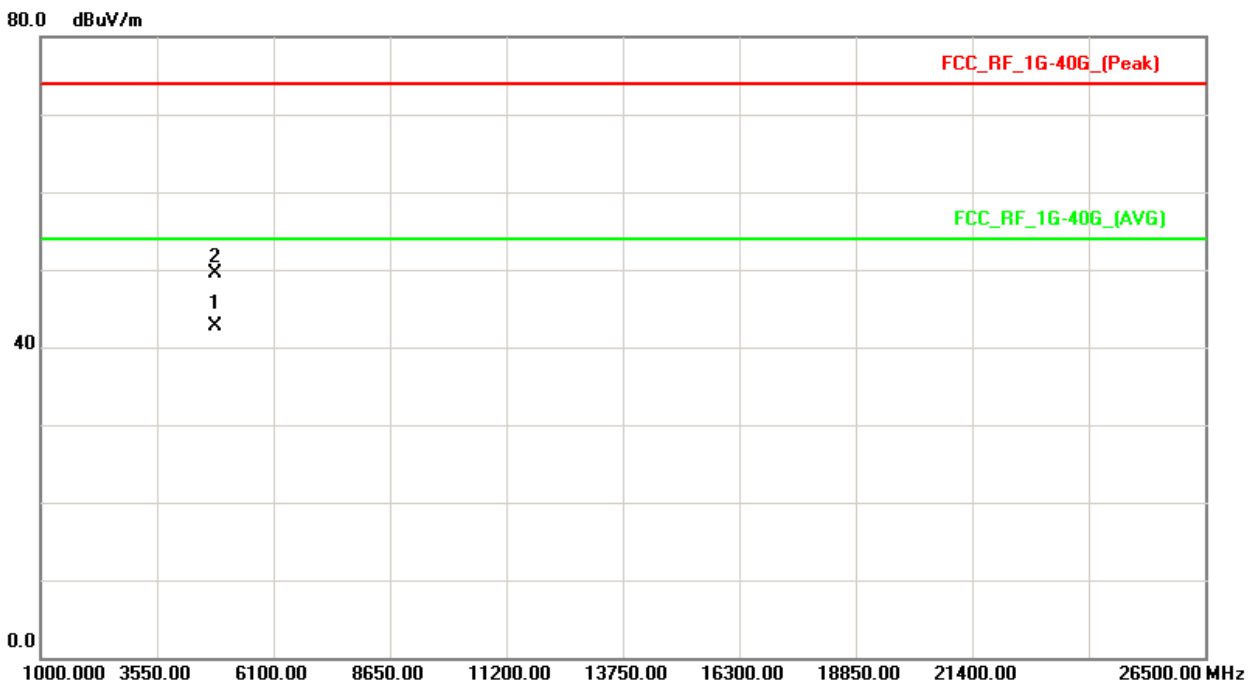
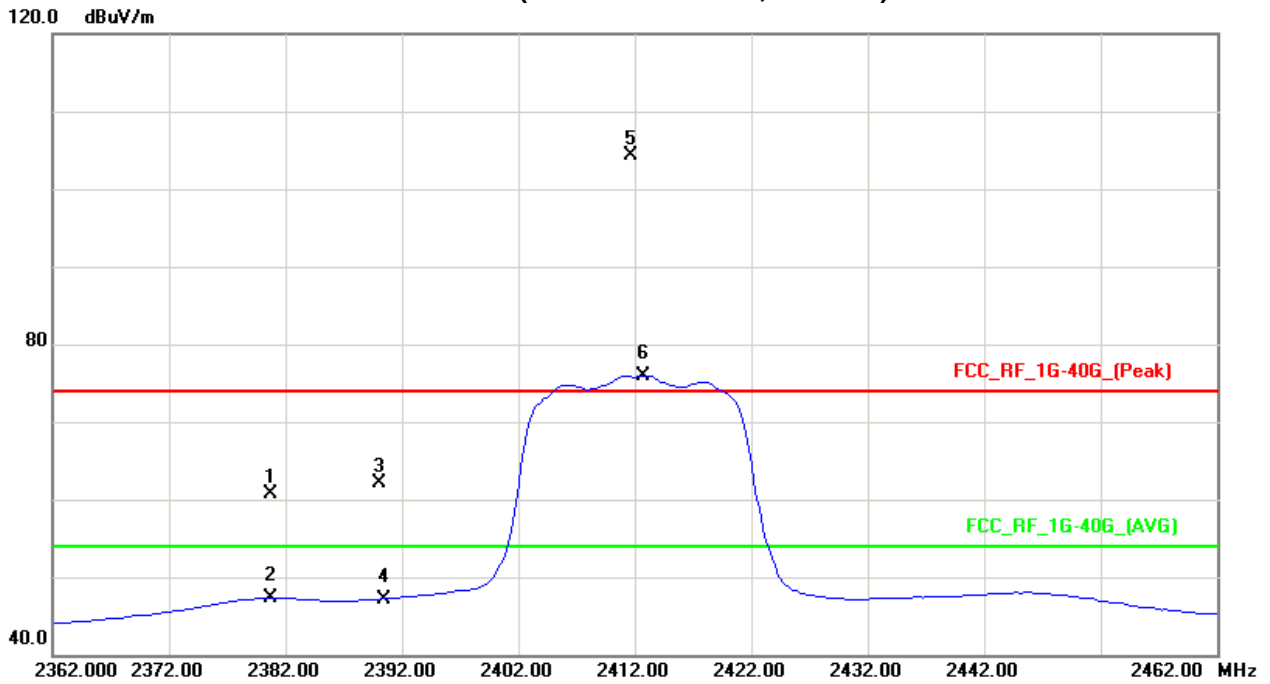



Neutron Engineering Inc.

EUT :	Wireless VDSL2 4-port Ethernet Router	Model Name :	DSL-6740B
Temperature :	25 °C	Relative Humidity :	51 %
Pressure :	1010 hPa	Test Voltage :	AC 120V/60Hz
Test Mode :	TX N-20M MODE 2412MHZ		

Freq. (MHz)	Ant.Pol. H/V	Reading		Ant./CF CF(dB)	Act.		Limit		Note
		Peak (dBuV)	AV (dBuV)		Peak (dBuV/m)	AV (dBuV/m)	Peak (dBuV/m)	AV (dBuV/m)	
2380.50	H	30.22	16.30	32.29	62.51	48.59	74.00	54.00	X/E
2390.00	H	29.55	16.23	32.28	61.83	48.51	74.00	54.00	X/E
2412.25	H	74.25	45.44	32.26	106.51	77.70			X/F
4824.37	H	39.35	28.24	6.19	45.54	34.43	74.00	54.00	X/H

Remark :

- (1) All readings are Peak unless otherwise stated QP in column of 『Note』 . Peak denotes that the Peak reading compliance with the QP Limits and then QP Mode measurement didn't perform ◦
- (2) Measuring frequency range from 30MHz to 1000MHz or the 10th harmonic of highest fundamental frequency ◦ "F" denotes fundamental frequency; "H" denotes spurious frequency. "E" denotes band edge frequency. (This judgment method includes the Band Edge Requirement.)
- (3) Radiated emissions measured in frequency range above 1000MHz were made with an instrument using Peak detector mode and AV detector mode of the emission ◦
- (4) Data of measurement within this frequency range shown " * " in the table above means the reading of emissions are attenuated more than 20dB below the permissible limits or the field strength is too small to be measured.
- (5) A preamp and high pass filter were used for this test in order to provide sufficient measurement sensitivity.
- (6) EUT Orthogonal Axis :
"X" - denotes Laid on Table ; "Y" - denotes Vertical Stand ; "Z" - denotes Side Stand
- (7) During the measurements above 1 GHz it is taken care of that the EUT is always within the 3 dB cone of radiation BW of the used antenna



TX CH01 (Above 1000 MHz, Horizontal)

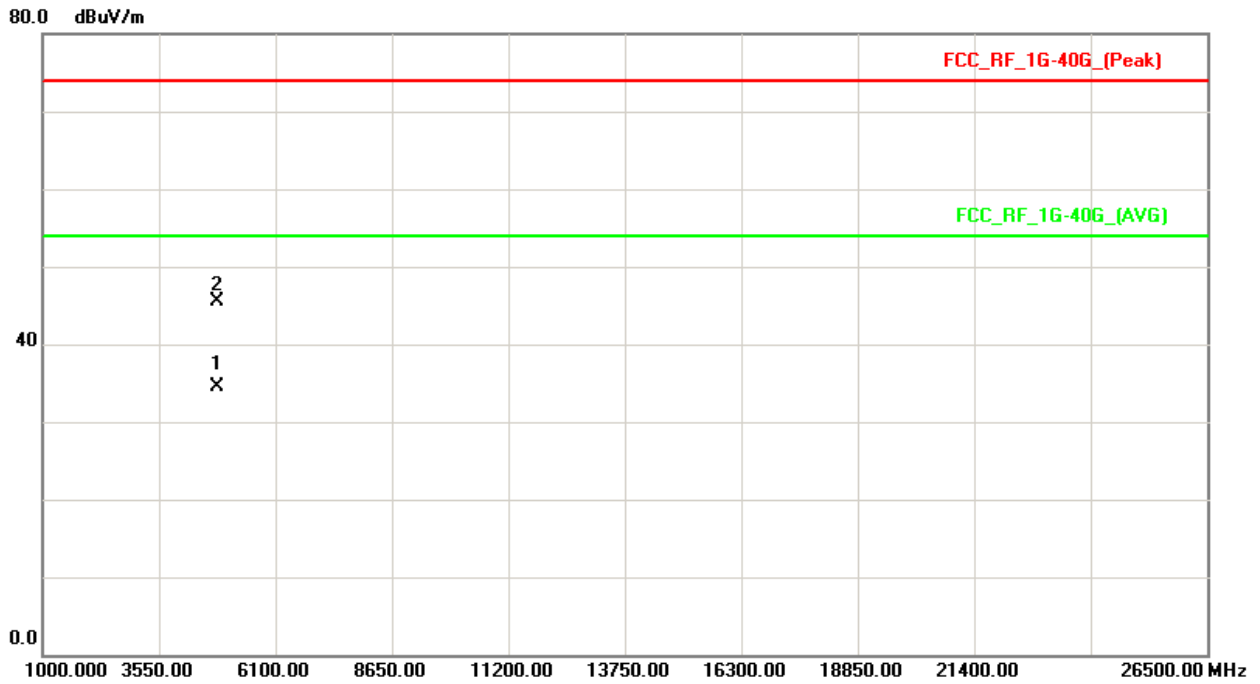
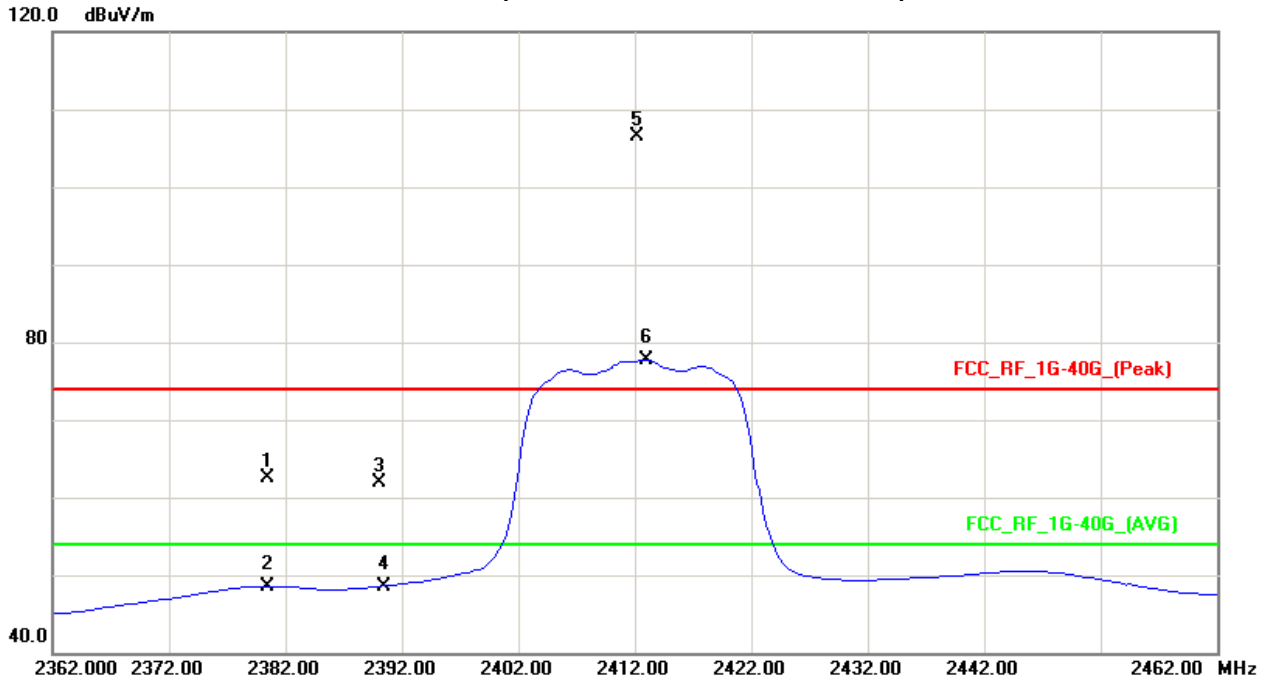



EUT :	Wireless VDSL2 4-port Ethernet Router	Model Name :	DSL-6740B
Temperature :	25 °C	Relative Humidity :	51 %
Pressure :	1010 hPa	Test Voltage :	AC 120V/60Hz
Test Mode :	TX N-20M MODE 2437MHZ-		

Freq. (MHz)	Ant.Pol. H/V	Reading		Ant./CF CF(dB)	Act.		Limit		Note
		Peak (dBuV)	AV (dBuV)		Peak (dBuV/m)	AV (dBuV/m)	Peak (dBuV/m)	AV (dBuV/m)	
2435.25	V	71.28	43.10	32.23	103.51	75.33			X/F
4874.15	V	41.84	35.54	6.39	48.23	41.93	74.00	54.00	X/H

Remark :

- (1) All readings are Peak unless otherwise stated QP in column of 『Note』 . Peak denotes that the Peak reading compliance with the QP Limits and then QP Mode measurement didn't perform ◦
- (2) Measuring frequency range from 30MHz to 1000MHz or the 10th harmonic of highest fundamental frequency ◦ "F" denotes fundamental frequency; "H" denotes spurious frequency. "E" denotes band edge frequency. (This judgment method includes the Band Edge Requirement.)
- (3) Radiated emissions measured in frequency range above 1000MHz were made with an instrument using Peak detector mode and AV detector mode of the emission ◦
- (4) Data of measurement within this frequency range shown " * " in the table above means the reading of emissions are attenuated more than 20dB below the permissible limits or the field strength is too small to be measured.
- (5) A preamp and high pass filter were used for this test in order to provide sufficient measurement sensitivity.
- (6) EUT Orthogonal Axis :
"X" - denotes Laid on Table ; "Y" - denotes Vertical Stand ; "Z" - denotes Side Stand
- (7) During the measurements above 1 GHz it is taken care of that the EUT is always within the 3 dB cone of radiation BW of the used antenna



TX CH06 (Above 1000 MHz, Vertical)

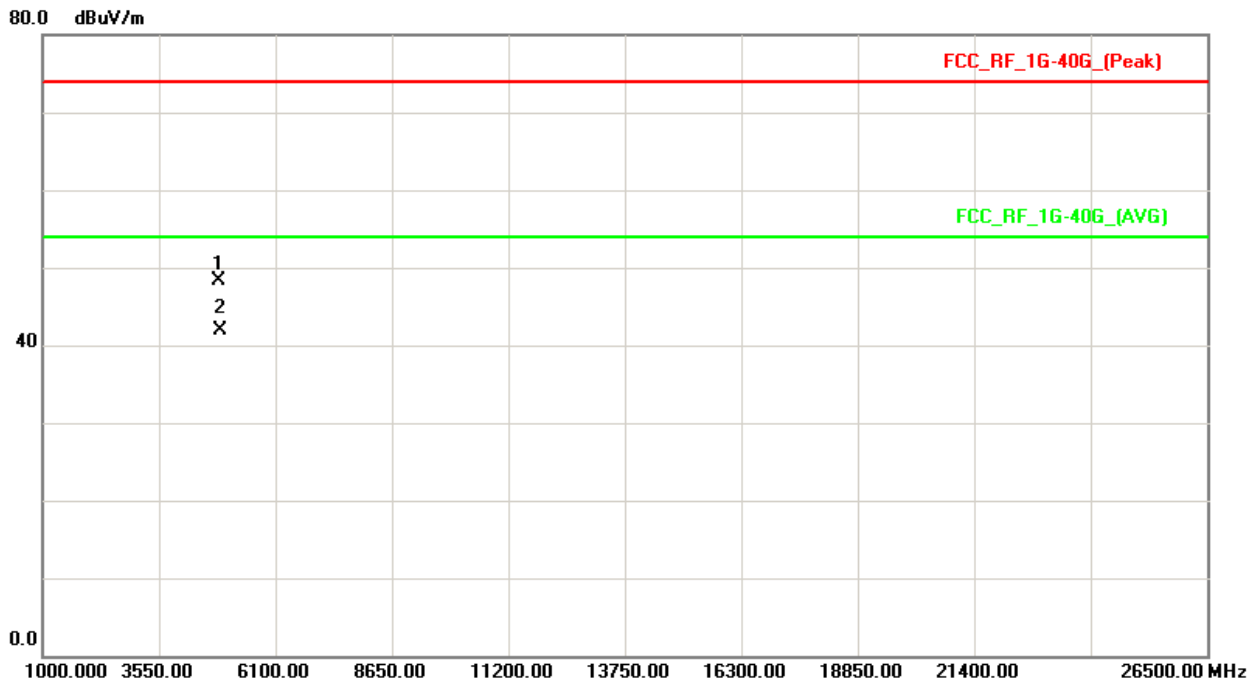
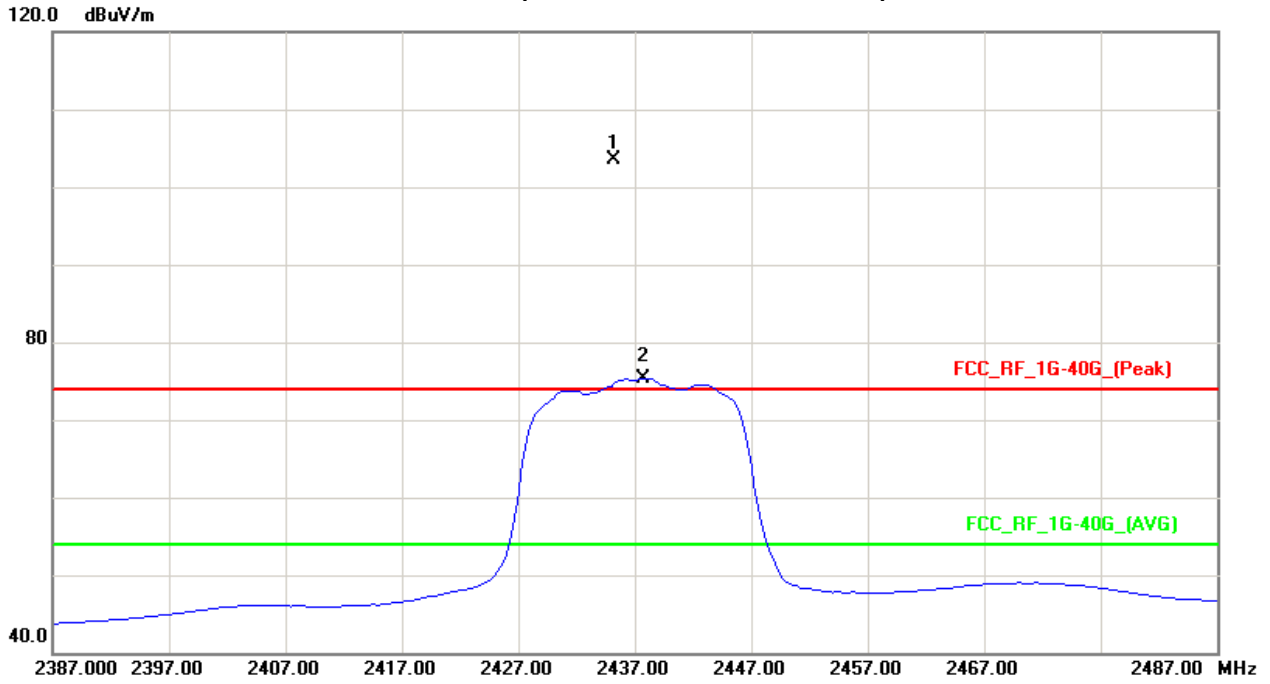



Neutron Engineering Inc.

EUT :	Wireless VDSL2 4-port Ethernet Router	Model Name :	DSL-6740B
Temperature :	25 °C	Relative Humidity :	51 %
Pressure :	1010 hPa	Test Voltage :	AC 120V/60Hz
Test Mode :	TX N-20M MODE 2437MHz		

Freq. (MHz)	Ant.Pol. H/V	Reading		Ant./CF CF(dB)	Act.		Limit		Note
		Peak (dBuV)	AV (dBuV)		Peak (dBuV/m)	AV (dBuV/m)	Peak (dBuV/m)	AV (dBuV/m)	
2436.85	H	73.14	44.99	32.23	105.37	77.22			X/F
4874.25	H	38.87	27.36	6.39	45.26	33.75	74.00	54.00	X/H

Remark :

- (1) All readings are Peak unless otherwise stated QP in column of 『Note』 . Peak denotes that the Peak reading compliance with the QP Limits and then QP Mode measurement didn't perform ◦
- (2) Measuring frequency range from 30MHz to 1000MHz or the 10th harmonic of highest fundamental frequency ◦ "F" denotes fundamental frequency; "H" denotes spurious frequency. "E" denotes band edge frequency. (This judgment method includes the Band Edge Requirement.)
- (3) Radiated emissions measured in frequency range above 1000MHz were made with an instrument using Peak detector mode and AV detector mode of the emission ◦
- (4) Data of measurement within this frequency range shown " * " in the table above means the reading of emissions are attenuated more than 20dB below the permissible limits or the field strength is too small to be measured.
- (5) A preamp and high pass filter were used for this test in order to provide sufficient measurement sensitivity.
- (6) EUT Orthogonal Axis :
"X" - denotes Laid on Table ; "Y" - denotes Vertical Stand ; "Z" - denotes Side Stand
- (7) During the measurements above 1 GHz it is taken care of that the EUT is always within the 3 dB cone of radiation BW of the used antenna



TX CH06 (Above 1000 MHz, Horizontal)

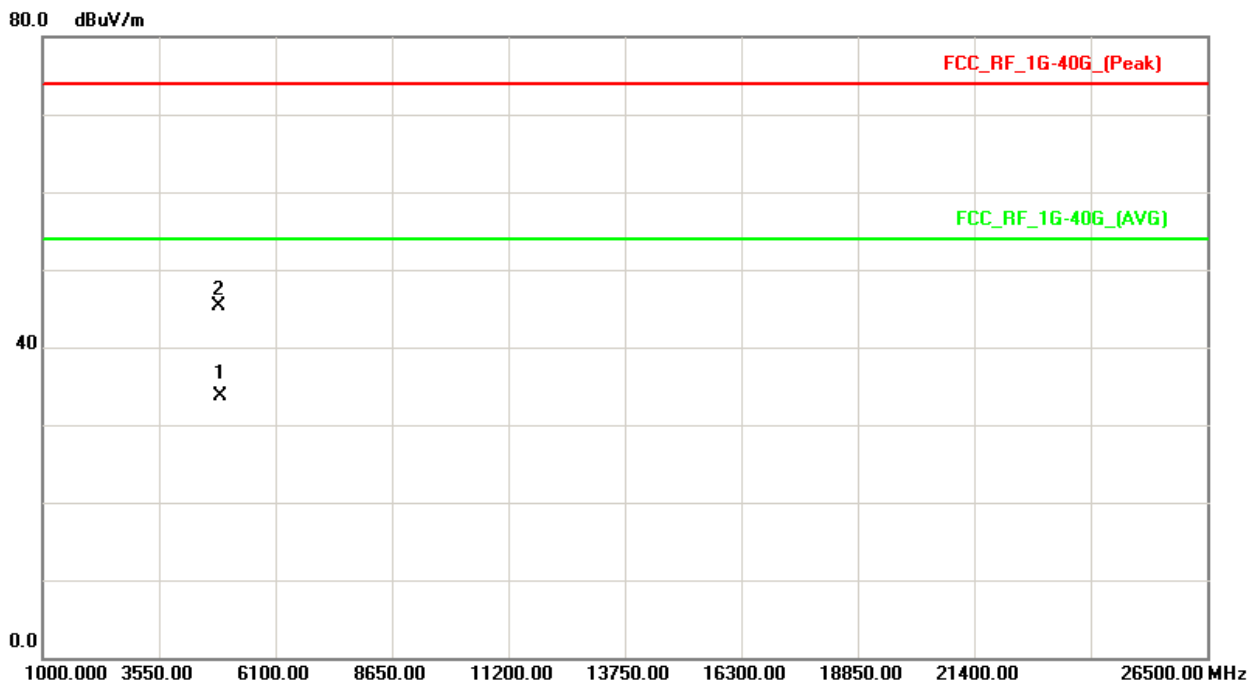
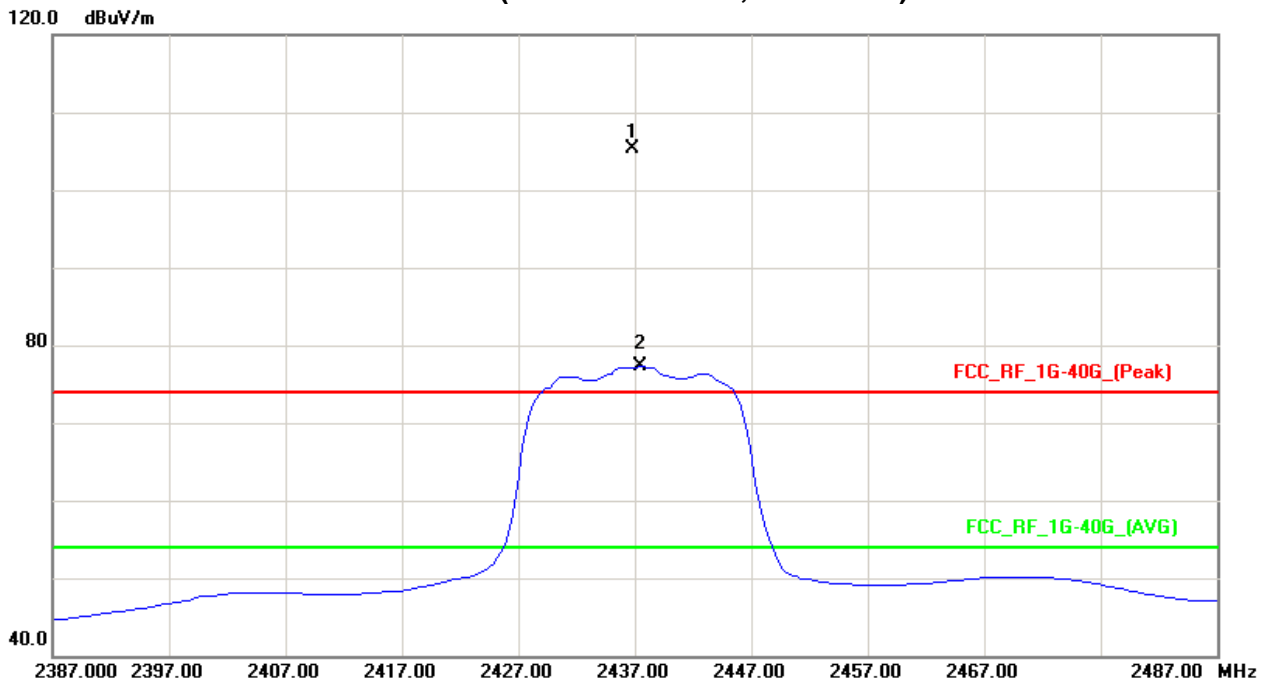



EUT :	Wireless VDSL2 4-port Ethernet Router	Model Name :	DSL-6740B
Temperature :	25 °C	Relative Humidity :	51 %
Pressure :	1010 hPa	Test Voltage :	AC 120V/60Hz
Test Mode :	TX N-20M MODE 2462MHZ-		

Freq.	Ant.Pol.	Reading		Ant./CF	Act.		Limit		Note
		Peak	AV		Peak	AV	Peak	AV	
(MHz)	H/V	(dBuV)	(dBuV)	CF(dB)	(dBuV/m)	(dBuV/m)	(dBuV/m)	(dBuV/m)	
2462.00	V	72.30	42.53	32.21	104.51	74.74			X/F
2483.50	V	37.42	15.52	32.17	69.59	47.69	74.00	54.00	X/E
2495.50	V	35.02	16.99	32.17	67.19	49.16	74.00	54.00	X/E
4924.55	V	42.65	35.22	6.59	49.24	41.81	74.00	54.00	X/H

Remark :

- (1) All readings are Peak unless otherwise stated QP in column of 『Note』 . Peak denotes that the Peak reading compliance with the QP Limits and then QP Mode measurement didn't perform ◦
- (2) Measuring frequency range from 30MHz to 1000MHz or the 10th harmonic of highest fundamental frequency ◦ "F" denotes fundamental frequency; "H" denotes spurious frequency. "E" denotes band edge frequency. (This judgment method includes the Band Edge Requirement.)
- (3) Radiated emissions measured in frequency range above 1000MHz were made with an instrument using Peak detector mode and AV detector mode of the emission ◦
- (4) Data of measurement within this frequency range shown " * " in the table above means the reading of emissions are attenuated more than 20dB below the permissible limits or the field strength is too small to be measured.
- (5) A preamp and high pass filter were used for this test in order to provide sufficient measurement sensitivity.
- (6) EUT Orthogonal Axis :
"X" - denotes Laid on Table ; "Y" - denotes Vertical Stand ; "Z" - denotes Side Stand
- (7) During the measurements above 1 GHz it is taken care of that the EUT is always within the 3 dB cone of radiation BW of the used antenna



TX CH11 (Above 1000 MHz, Vertical)

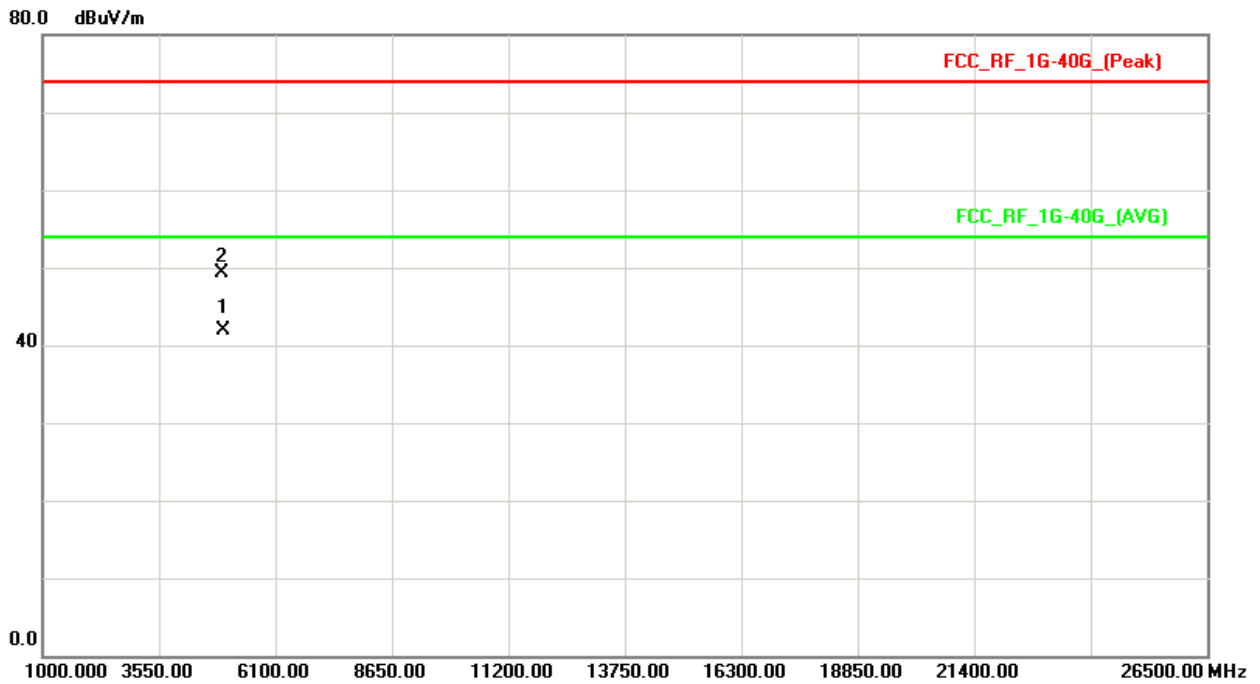
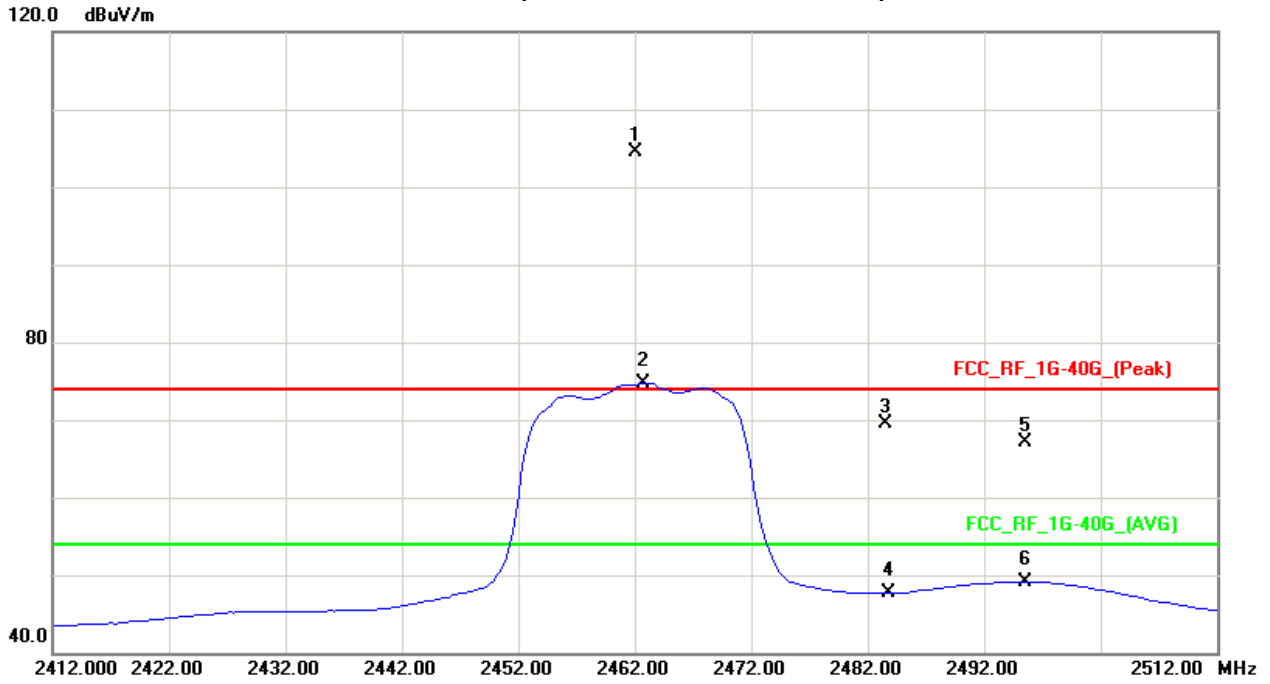



EUT :	Wireless VDSL2 4-port Ethernet Router	Model Name :	DSL-6740B
Temperature :	25 °C	Relative Humidity :	51 %
Pressure :	1010 hPa	Test Voltage :	AC 120V/60Hz
Test Mode :	TX N-20M MODE 2462MHz		

Freq. (MHz)	Ant.Pol. H/V	Reading		Ant./CF CF(dB)	Act.		Limit		Note
		Peak (dBuV)	AV (dBuV)		Peak (dBuV/m)	AV (dBuV/m)	Peak (dBuV/m)	AV (dBuV/m)	
2462.25	H	73.84	44.57	32.21	106.05	76.78			X/F
2483.50	H	34.70	16.75	32.17	66.87	48.92	74.00	54.00	X/E
2494.75	H	34.29	18.00	32.17	66.46	50.17	74.00	54.00	X/E
4924.33	H	39.00	30.33	6.59	45.59	36.92	74.00	54.00	X/H

Remark :

- (1) All readings are Peak unless otherwise stated QP in column of 『Note』 . Peak denotes that the Peak reading compliance with the QP Limits and then QP Mode measurement didn't perform ◦
- (2) Measuring frequency range from 30MHz to 1000MHz or the 10th harmonic of highest fundamental frequency ◦ "F" denotes fundamental frequency; "H" denotes spurious frequency. "E" denotes band edge frequency. (This judgment method includes the Band Edge Requirement.)
- (3) Radiated emissions measured in frequency range above 1000MHz were made with an instrument using Peak detector mode and AV detector mode of the emission ◦
- (4) Data of measurement within this frequency range shown " * " in the table above means the reading of emissions are attenuated more than 20dB below the permissible limits or the field strength is too small to be measured.
- (5) A preamp and high pass filter were used for this test in order to provide sufficient measurement sensitivity.
- (6) EUT Orthogonal Axis :
"X" - denotes Laid on Table ; "Y" - denotes Vertical Stand ; "Z" - denotes Side Stand
- (7) During the measurements above 1 GHz it is taken care of that the EUT is always within the 3 dB cone of radiation BW of the used antenna



TX CH11 (Above 1000 MHz, Horizontal)

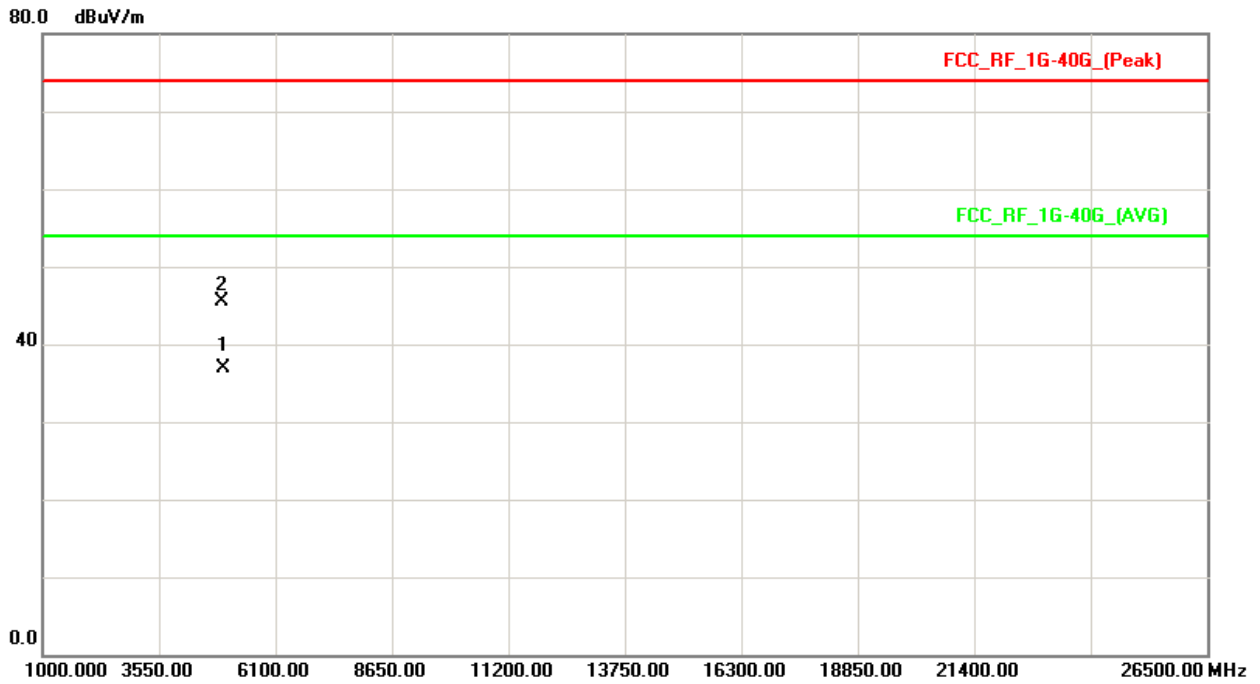
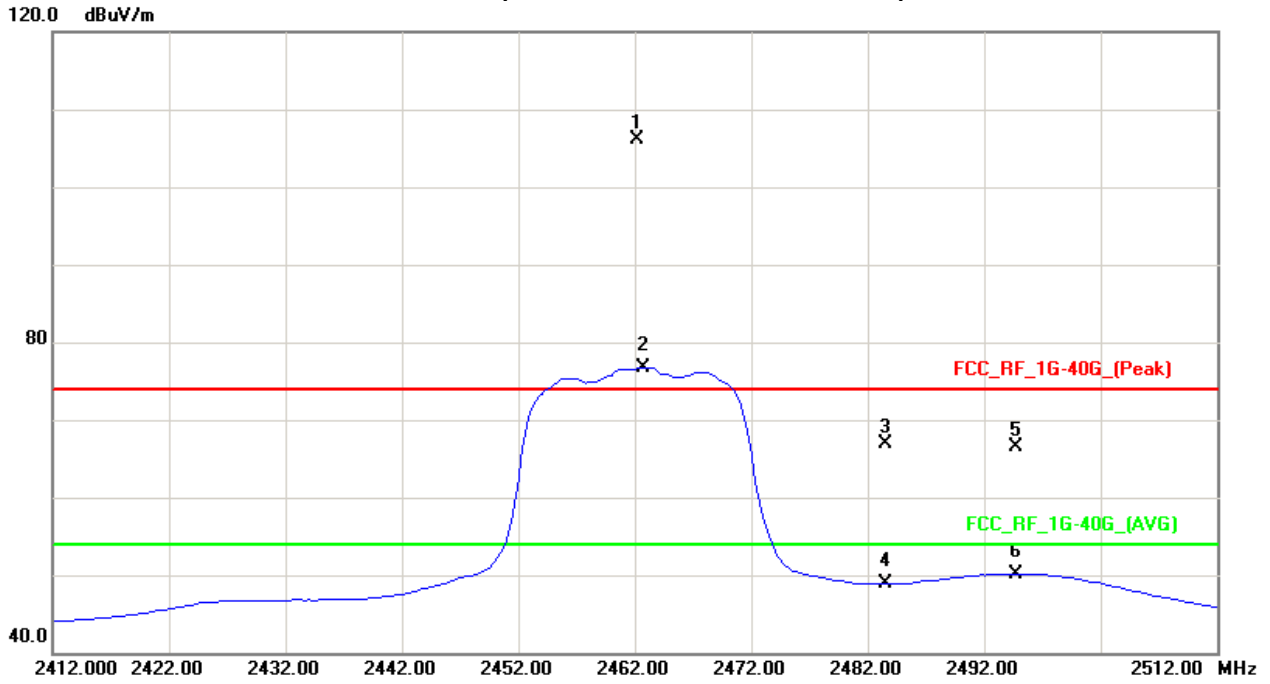



EUT :	Wireless VDSL2 4-port Ethernet Router	Model Name :	DSL-6740B
Temperature :	25 °C	Relative Humidity :	51 %
Pressure :	1010 hPa	Test Voltage :	AC 120V/60Hz
Test Mode :	TX N-40M MODE 2422MHZ		

Freq.	Ant.Pol.	Reading		Ant./CF	Act.		Limit		Note
		Peak	AV		Peak	AV	Peak	AV	
(MHz)	H/V	(dBuV)	(dBuV)	CF(dB)	(dBuV/m)	(dBuV/m)	(dBuV/m)	(dBuV/m)	
2390.00	V	29.06	14.60	32.28	61.34	46.88	74.00	54.00	X/E
2423.50	V	70.75	34.53	32.24	102.99	66.77			X/F
4845.68	V	40.35	31.22	6.28	46.63	37.50	74.00	54.00	X/H

Remark :

- (1) All readings are Peak unless otherwise stated QP in column of 『Note』 . Peak denotes that the Peak reading compliance with the QP Limits and then QP Mode measurement didn't perform ◦
- (2) Measuring frequency range from 30MHz to 1000MHz or the 10th harmonic of highest fundamental frequency ◦ "F" denotes fundamental frequency; "H" denotes spurious frequency. "E" denotes band edge frequency. (This judgment method includes the Band Edge Requirement.)
- (3) Radiated emissions measured in frequency range above 1000MHz were made with an instrument using Peak detector mode and AV detector mode of the emission ◦
- (4) Data of measurement within this frequency range shown " * " in the table above means the reading of emissions are attenuated more than 20dB below the permissible limits or the field strength is too small to be measured.
- (5) A preamp and high pass filter were used for this test in order to provide sufficient measurement sensitivity.
- (6) EUT Orthogonal Axis :
"X" - denotes Laid on Table ; "Y" - denotes Vertical Stand ; "Z" - denotes Side Stand
- (7) During the measurements above 1 GHz it is taken care of that the EUT is always within the 3 dB cone of radiation BW of the used antenna



TX CH03 (Above 1000 MHz, Vertical)

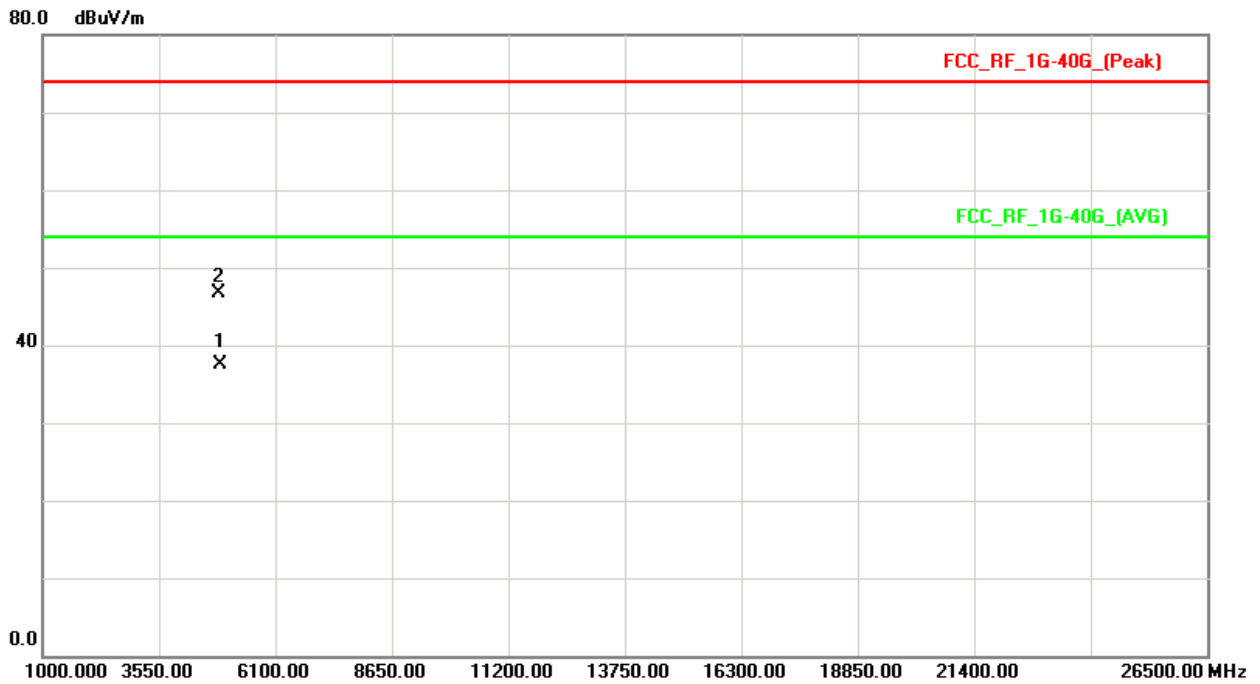
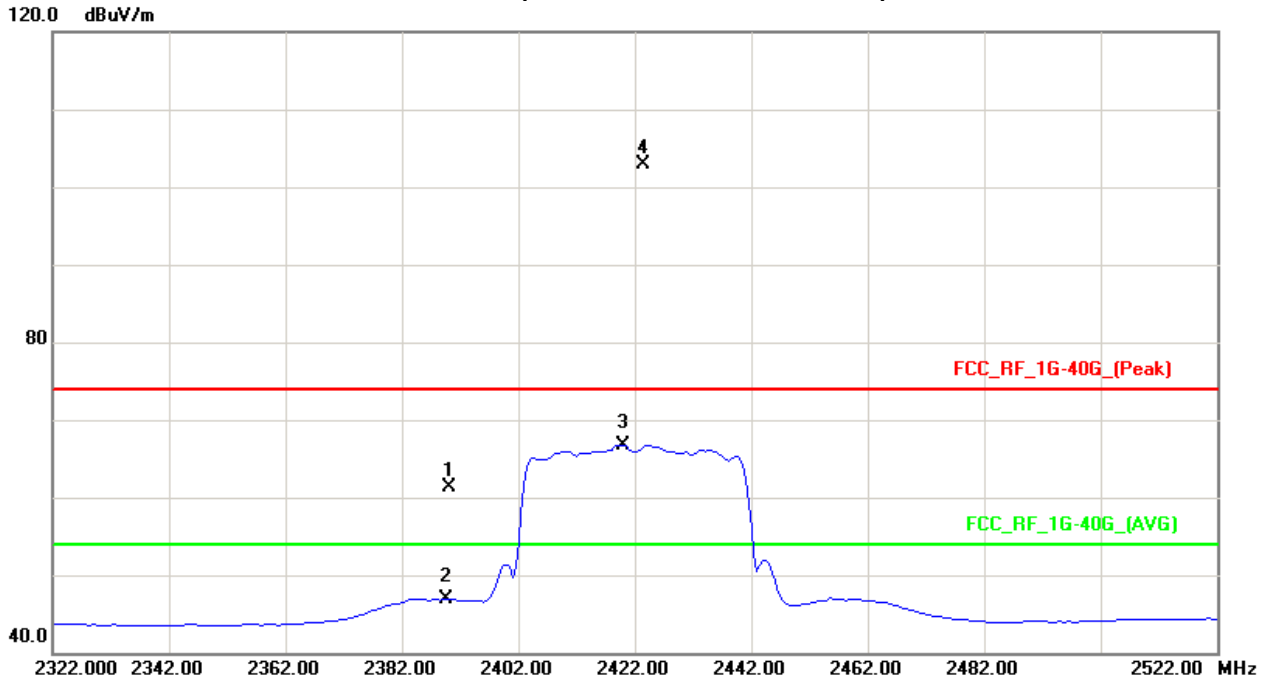



EUT :	Wireless VDSL2 4-port Ethernet Router	Model Name :	DSL-6740B
Temperature :	25 °C	Relative Humidity :	51 %
Pressure :	1010 hPa	Test Voltage :	AC 120V/60Hz
Test Mode :	TX N-40M MODE 2422MHZ		

Freq. (MHz)	Ant.Pol. H/V	Reading		Ant./CF CF(dB)	Act.		Limit		Note
		Peak (dBuV)	AV (dBuV)		Peak (dBuV/m)	AV (dBuV/m)	Peak (dBuV/m)	AV (dBuV/m)	
2390.00	H	34.72	15.92	32.28	67.00	48.20	74.00	54.00	X/E
2423.50	H	73.81	36.11	32.24	106.05	68.35			X/F
4846.20	H	37.67	29.58	6.28	43.95	35.86	74.00	54.00	X/H

Remark :

- (1) All readings are Peak unless otherwise stated QP in column of 『Note』 . Peak denotes that the Peak reading compliance with the QP Limits and then QP Mode measurement didn't perform ◦
- (2) Measuring frequency range from 30MHz to 1000MHz or the 10th harmonic of highest fundamental frequency ◦ "F" denotes fundamental frequency; "H" denotes spurious frequency. "E" denotes band edge frequency. (This judgment method includes the Band Edge Requirement.)
- (3) Radiated emissions measured in frequency range above 1000MHz were made with an instrument using Peak detector mode and AV detector mode of the emission ◦
- (4) Data of measurement within this frequency range shown " * " in the table above means the reading of emissions are attenuated more than 20dB below the permissible limits or the field strength is too small to be measured.
- (5) A preamp and high pass filter were used for this test in order to provide sufficient measurement sensitivity.
- (6) EUT Orthogonal Axis :
"X" - denotes Laid on Table ; "Y" - denotes Vertical Stand ; "Z" - denotes Side Stand
- (7) During the measurements above 1 GHz it is taken care of that the EUT is always within the 3 dB cone of radiation BW of the used antenna



TX CH03 (Above 1000 MHz, Horizontal)

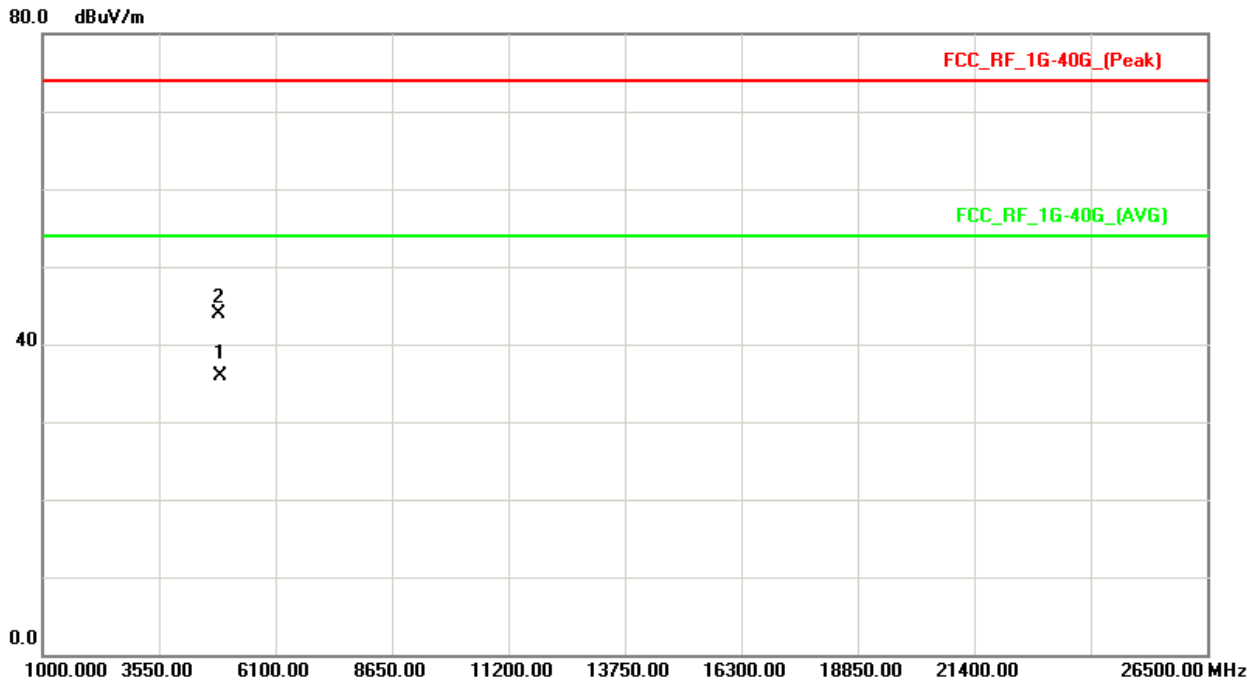
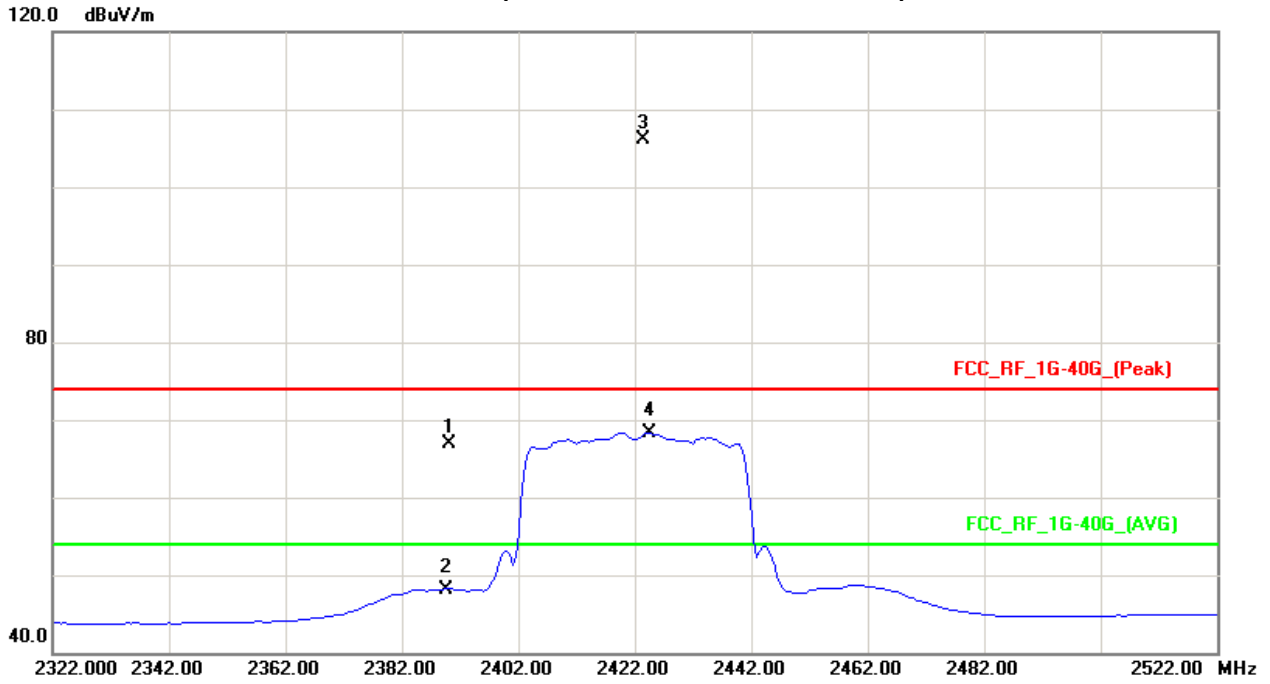



EUT :	Wireless VDSL2 4-port Ethernet Router	Model Name :	DSL-6740B
Temperature :	25 °C	Relative Humidity :	51 %
Pressure :	1010 hPa	Test Voltage :	AC 120V/60Hz
Test Mode :	TX N-40M MODE 2437MHZ-		

Freq. (MHz)	Ant.Pol. H/V	Reading		Ant./CF CF(dB)	Act.		Limit		Note
		Peak (dBuV)	AV (dBuV)		Peak (dBuV/m)	AV (dBuV/m)	Peak (dBuV/m)	AV (dBuV/m)	
2439.00	V	69.48	34.28	32.22	101.70	66.50			X/F
4875.82	V	41.39	32.85	6.40	47.79	39.25	74.00	54.00	X/H

Remark :

- (1) All readings are Peak unless otherwise stated QP in column of 『Note』 . Peak denotes that the Peak reading compliance with the QP Limits and then QP Mode measurement didn't perform ◦
- (2) Measuring frequency range from 30MHz to 1000MHz or the 10th harmonic of highest fundamental frequency ◦ "F" denotes fundamental frequency; "H" denotes spurious frequency. "E" denotes band edge frequency. (This judgment method includes the Band Edge Requirement.)
- (3) Radiated emissions measured in frequency range above 1000MHz were made with an instrument using Peak detector mode and AV detector mode of the emission ◦
- (4) Data of measurement within this frequency range shown " * " in the table above means the reading of emissions are attenuated more than 20dB below the permissible limits or the field strength is too small to be measured.
- (5) A preamp and high pass filter were used for this test in order to provide sufficient measurement sensitivity.
- (6) EUT Orthogonal Axis :
"X" - denotes Laid on Table ; "Y" - denotes Vertical Stand ; "Z" - denotes Side Stand
- (7) During the measurements above 1 GHz it is taken care of that the EUT is always within the 3 dB cone of radiation BW of the used antenna



TX CH06 (Above 1000 MHz, Vertical)

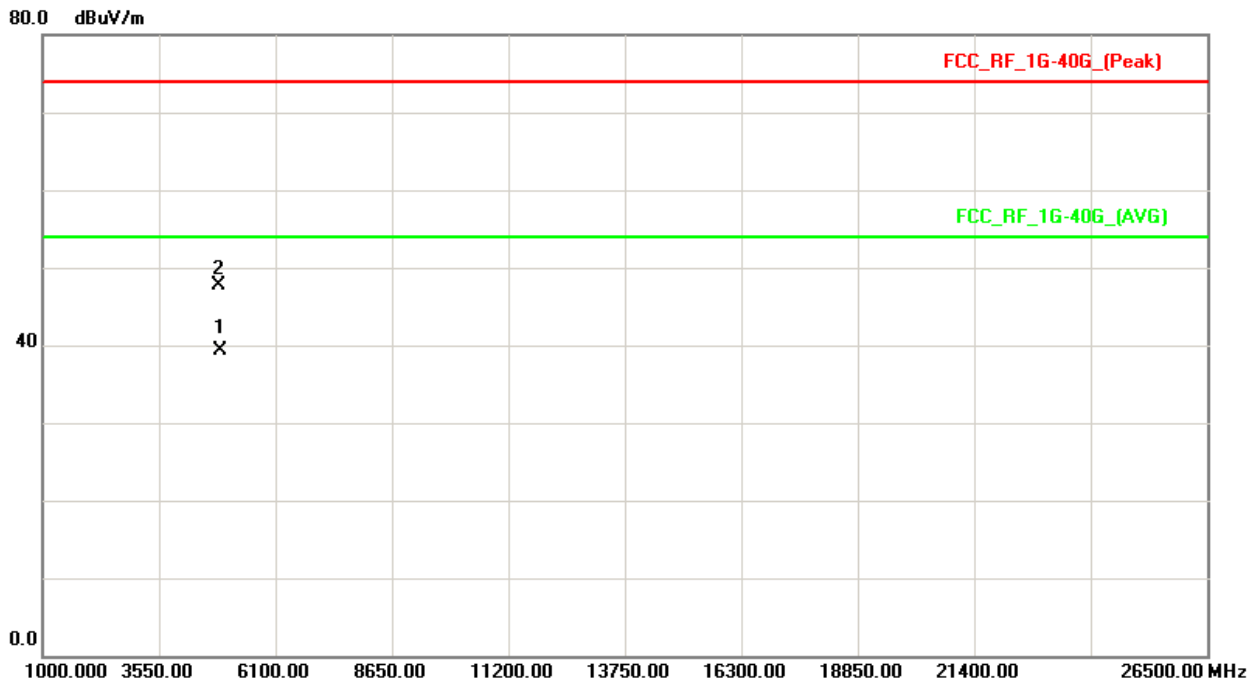
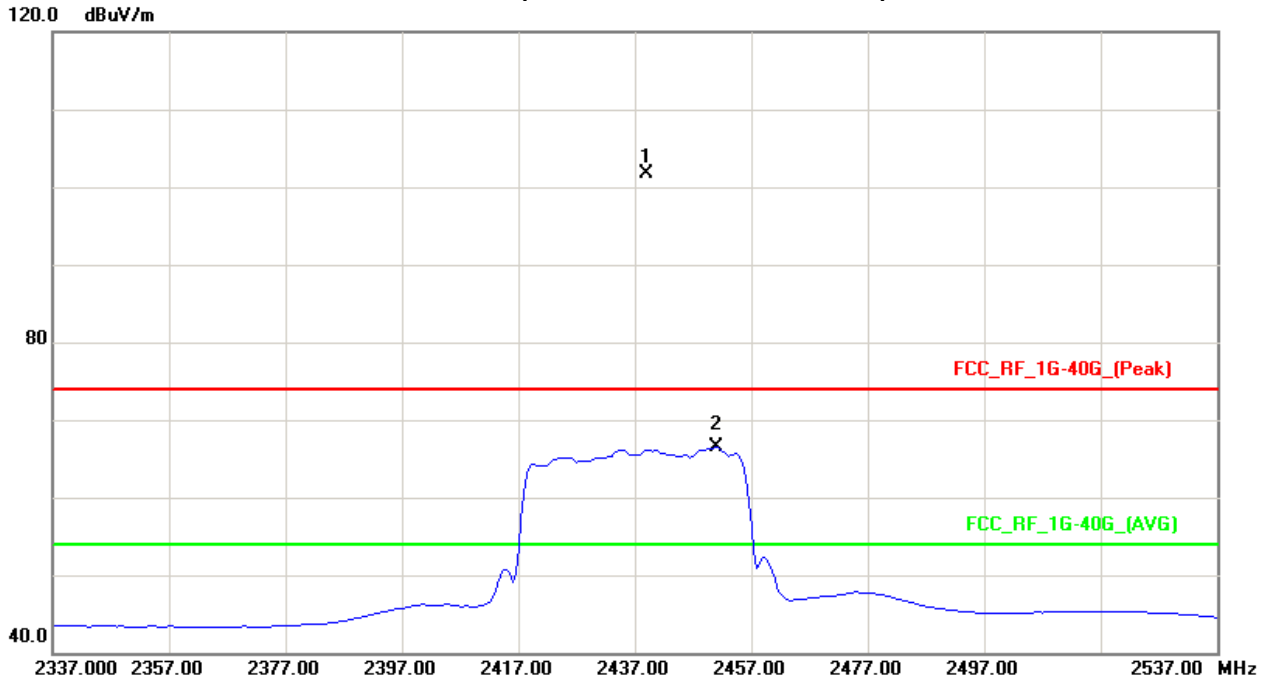



EUT :	Wireless VDSL2 4-port Ethernet Router	Model Name :	DSL-6740B
Temperature :	25 °C	Relative Humidity :	51 %
Pressure :	1010 hPa	Test Voltage :	AC 120V/60Hz
Test Mode :	TX N-40M MODE 2437MHz		

Freq. (MHz)	Ant.Pol. H/V	Reading		Ant./CF CF(dB)	Act.		Limit		Note
		Peak (dBuV)	AV (dBuV)		Peak (dBuV/m)	AV (dBuV/m)	Peak (dBuV/m)	AV (dBuV/m)	
2439.00	H	72.82	36.02	32.22	105.04	68.24			X/F
4874.63	H	36.98	28.54	6.39	43.37	34.93	74.00	54.00	X/H

Remark :

- (1) All readings are Peak unless otherwise stated QP in column of 『Note』 . Peak denotes that the Peak reading compliance with the QP Limits and then QP Mode measurement didn't perform ◦
- (2) Measuring frequency range from 30MHz to 1000MHz or the 10th harmonic of highest fundamental frequency ◦ "F" denotes fundamental frequency; "H" denotes spurious frequency. "E" denotes band edge frequency. (This judgment method includes the Band Edge Requirement.)
- (3) Radiated emissions measured in frequency range above 1000MHz were made with an instrument using Peak detector mode and AV detector mode of the emission ◦
- (4) Data of measurement within this frequency range shown " * " in the table above means the reading of emissions are attenuated more than 20dB below the permissible limits or the field strength is too small to be measured.
- (5) A preamp and high pass filter were used for this test in order to provide sufficient measurement sensitivity.
- (6) EUT Orthogonal Axis :
"X" - denotes Laid on Table ; "Y" - denotes Vertical Stand ; "Z" - denotes Side Stand
- (7) During the measurements above 1 GHz it is taken care of that the EUT is always within the 3 dB cone of radiation BW of the used antenna



TX CH06 (Above 1000 MHz, Horizontal)

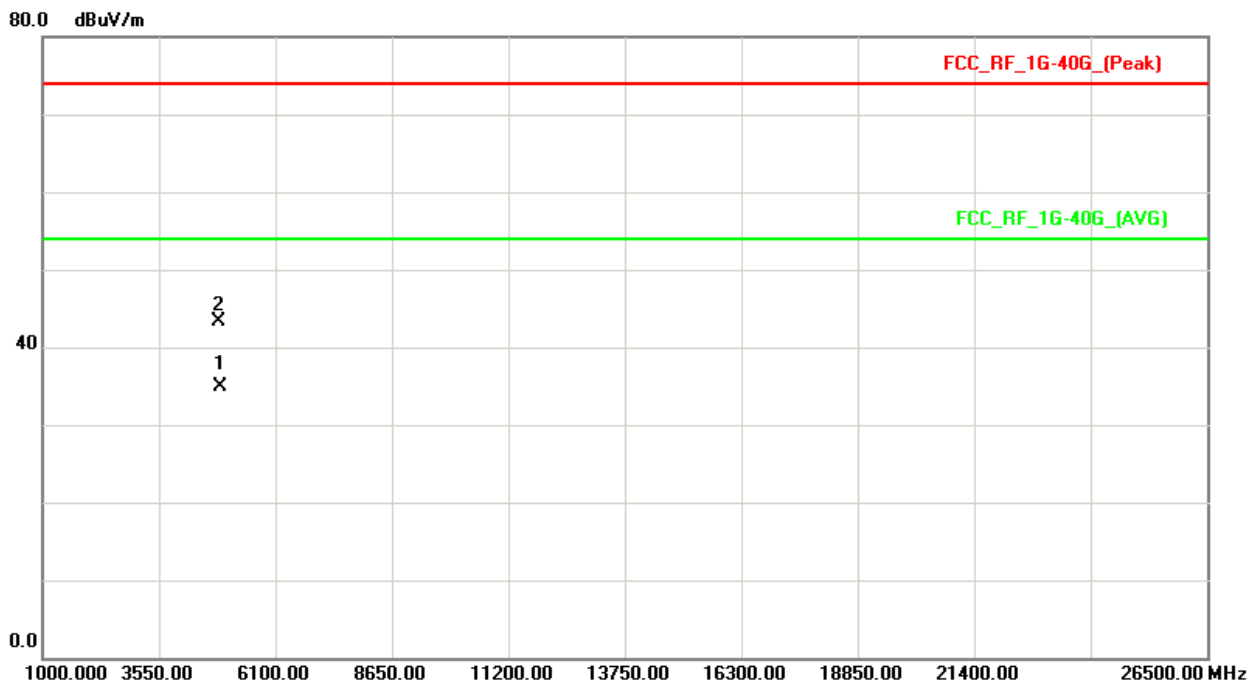
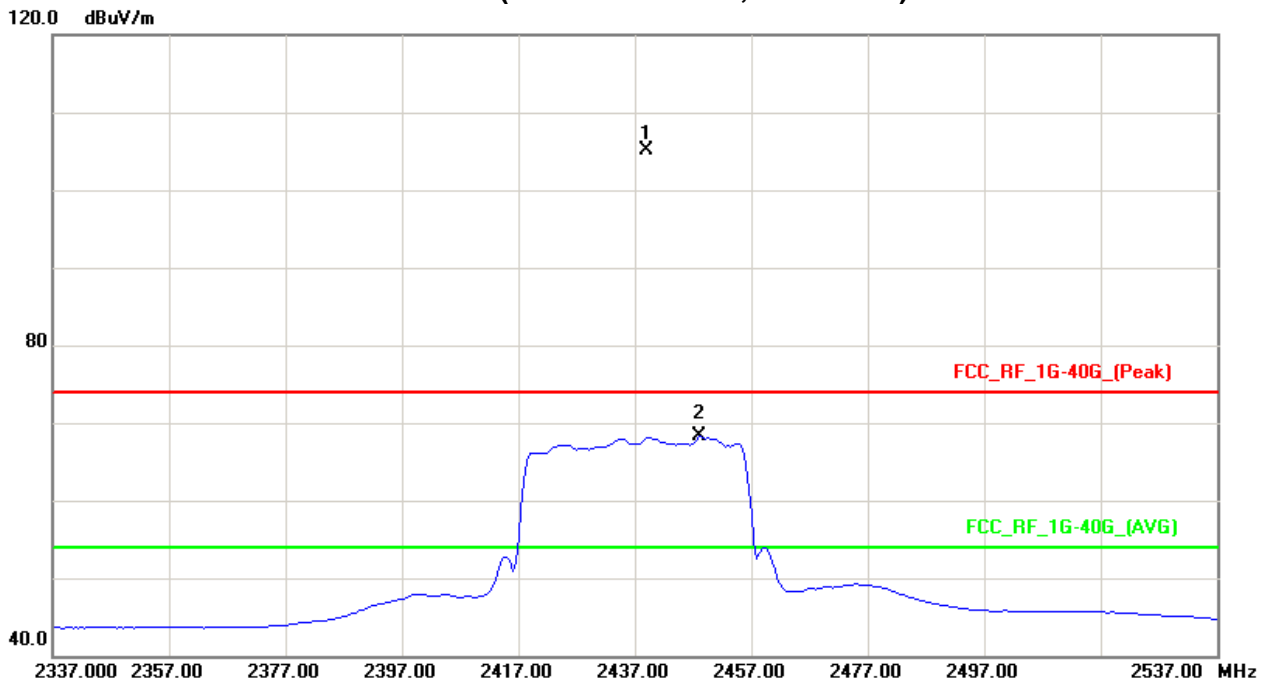



Neutron Engineering Inc.

EUT :	Wireless VDSL2 4-port Ethernet Router	Model Name :	DSL-6740B
Temperature :	25 °C	Relative Humidity :	51 %
Pressure :	1010 hPa	Test Voltage :	AC 120V/60Hz
Test Mode :	TX N-40M MODE 2452MHz		

Freq. (MHz)	Ant.Pol. H/V	Reading		Ant./CF CF(dB)	Act.		Limit		Note
		Peak (dBuV)	AV (dBuV)		Peak (dBuV/m)	AV (dBuV/m)	Peak (dBuV/m)	AV (dBuV/m)	
2454.50	V	68.67	34.04	32.20	100.87	66.24			X/F
2483.50	V	32.00	14.86	32.17	64.17	47.03	74.00	54.00	X/E
2490.00	V	32.26	15.91	32.17	64.43	48.08	74.00	54.00	X/E
4904.35	V	41.47	32.36	6.51	47.98	38.87	74.00	54.00	X/H

Remark :

- (1) All readings are Peak unless otherwise stated QP in column of 『Note』 . Peak denotes that the Peak reading compliance with the QP Limits and then QP Mode measurement didn't perform ◦
- (2) Measuring frequency range from 30MHz to 1000MHz or the 10th harmonic of highest fundamental frequency ◦ "F" denotes fundamental frequency; "H" denotes spurious frequency. "E" denotes band edge frequency. (This judgment method includes the Band Edge Requirement.)
- (3) Radiated emissions measured in frequency range above 1000MHz were made with an instrument using Peak detector mode and AV detector mode of the emission ◦
- (4) Data of measurement within this frequency range shown " * " in the table above means the reading of emissions are attenuated more than 20dB below the permissible limits or the field strength is too small to be measured.
- (5) A preamp and high pass filter were used for this test in order to provide sufficient measurement sensitivity.
- (6) EUT Orthogonal Axis :
"X" - denotes Laid on Table ; "Y" - denotes Vertical Stand ; "Z" - denotes Side Stand
- (7) During the measurements above 1 GHz it is taken care of that the EUT is always within the 3 dB cone of radiation BW of the used antenna



TX CH09 (Above 1000 MHz, Vertical)

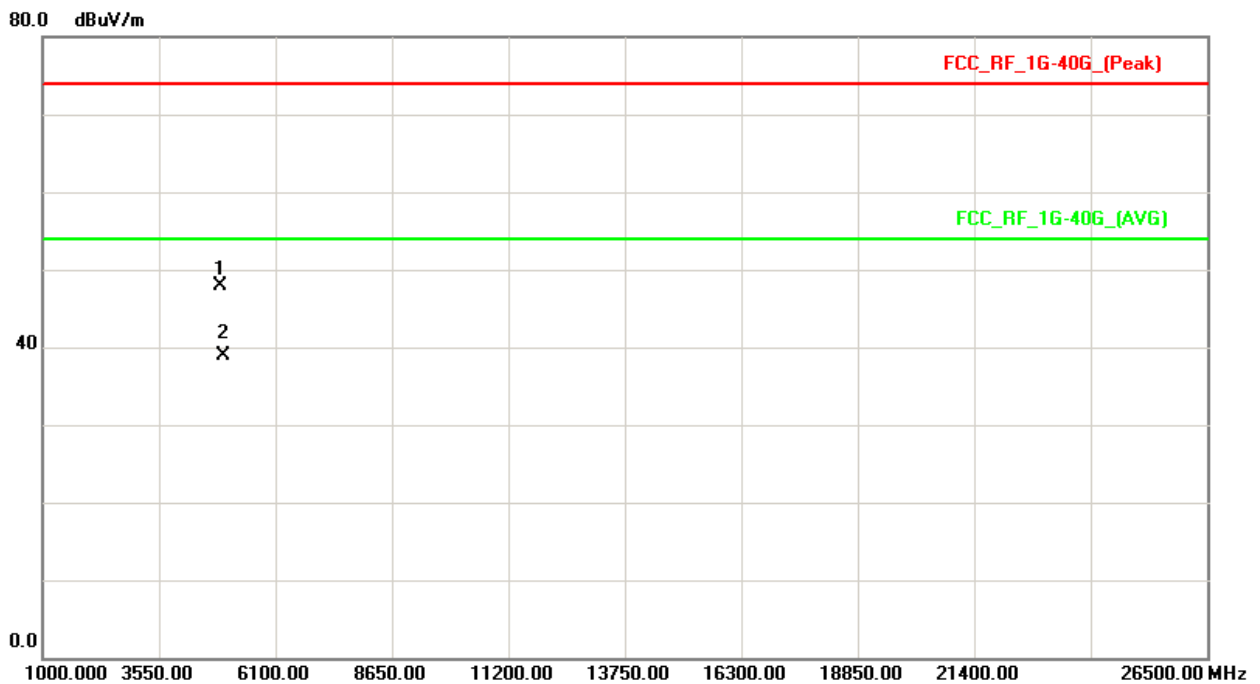
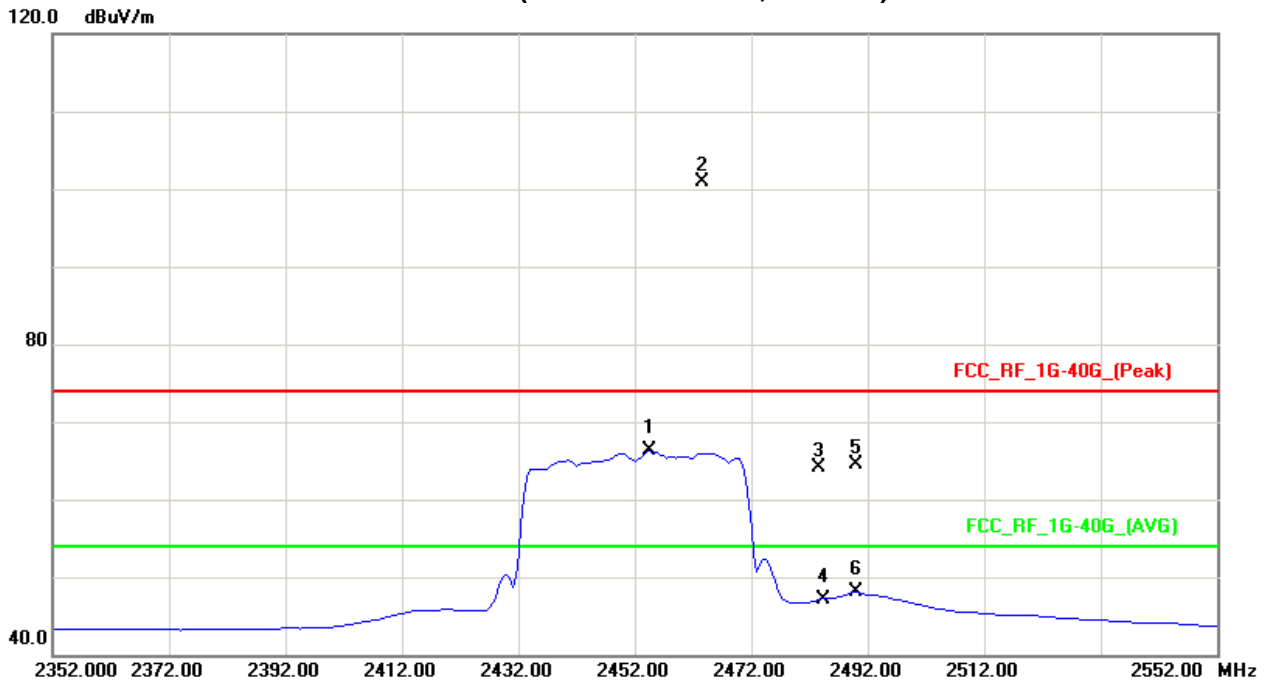



EUT :	Wireless VDSL2 4-port Ethernet Router	Model Name :	DSL-6740B
Temperature :	25 °C	Relative Humidity :	51 %
Pressure :	1010 hPa	Test Voltage :	AC 120V/60Hz
Test Mode :	TX N-40M MODE 2452MHz		

Freq. (MHz)	Ant.Pol. H/V	Reading		Ant./CF CF(dB)	Act.		Limit		Note
		Peak (dBuV)	AV (dBuV)		Peak (dBuV/m)	AV (dBuV/m)	Peak (dBuV/m)	AV (dBuV/m)	
2454.00	H	72.37	35.62	32.21	104.58	67.83			X/F
2483.50	H	34.88	15.91	32.17	67.05	48.08	74.00	54.00	X/E
2490.00	H	34.24	16.90	32.17	66.41	49.07	74.00	54.00	X/E
4905.60	H	36.65	26.47	6.52	43.17	32.99	74.00	54.00	X/H

Remark :

- (1) All readings are Peak unless otherwise stated QP in column of 『Note』 . Peak denotes that the Peak reading compliance with the QP Limits and then QP Mode measurement didn't perform ◦
- (2) Measuring frequency range from 30MHz to 1000MHz or the 10th harmonic of highest fundamental frequency ◦ "F" denotes fundamental frequency; "H" denotes spurious frequency. "E" denotes band edge frequency. (This judgment method includes the Band Edge Requirement.)
- (3) Radiated emissions measured in frequency range above 1000MHz were made with an instrument using Peak detector mode and AV detector mode of the emission ◦
- (4) Data of measurement within this frequency range shown " * " in the table above means the reading of emissions are attenuated more than 20dB below the permissible limits or the field strength is too small to be measured.
- (5) A preamp and high pass filter were used for this test in order to provide sufficient measurement sensitivity.
- (6) EUT Orthogonal Axis :
"X" - denotes Laid on Table ; "Y" - denotes Vertical Stand ; "Z" - denotes Side Stand
- (7) During the measurements above 1 GHz it is taken care of that the EUT is always within the 3 dB cone of radiation BW of the used antenna



TX CH09 (Above 1000 MHz, Horizontal)

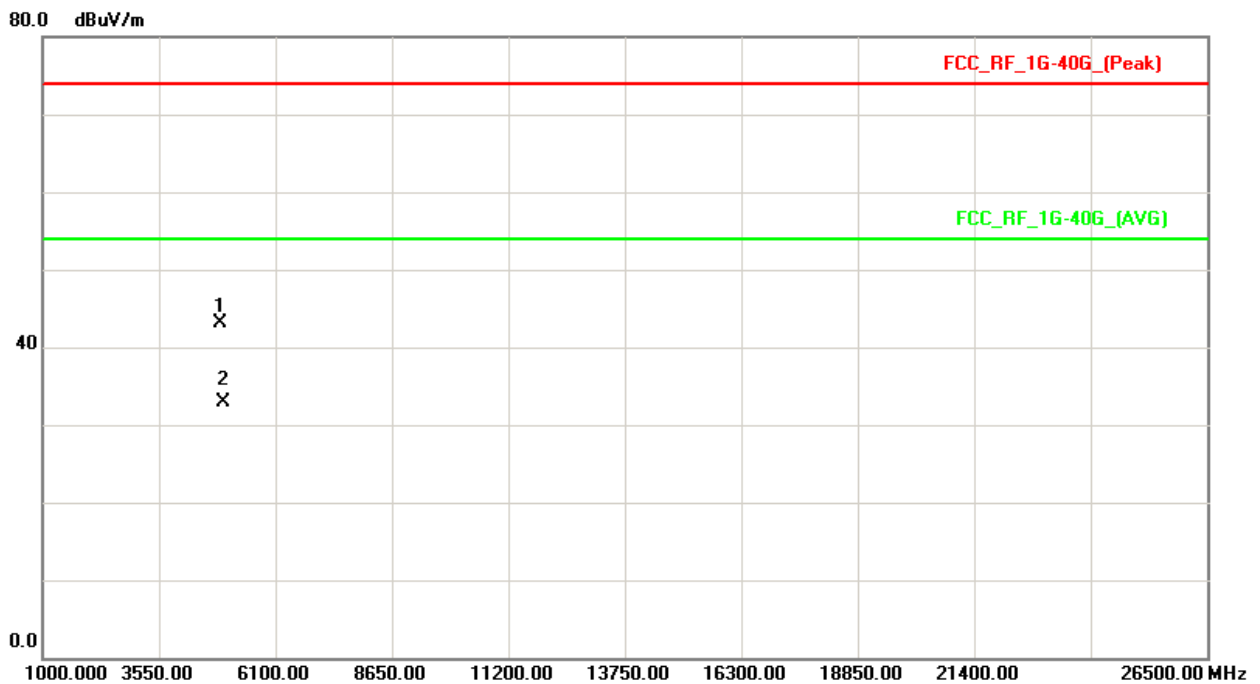
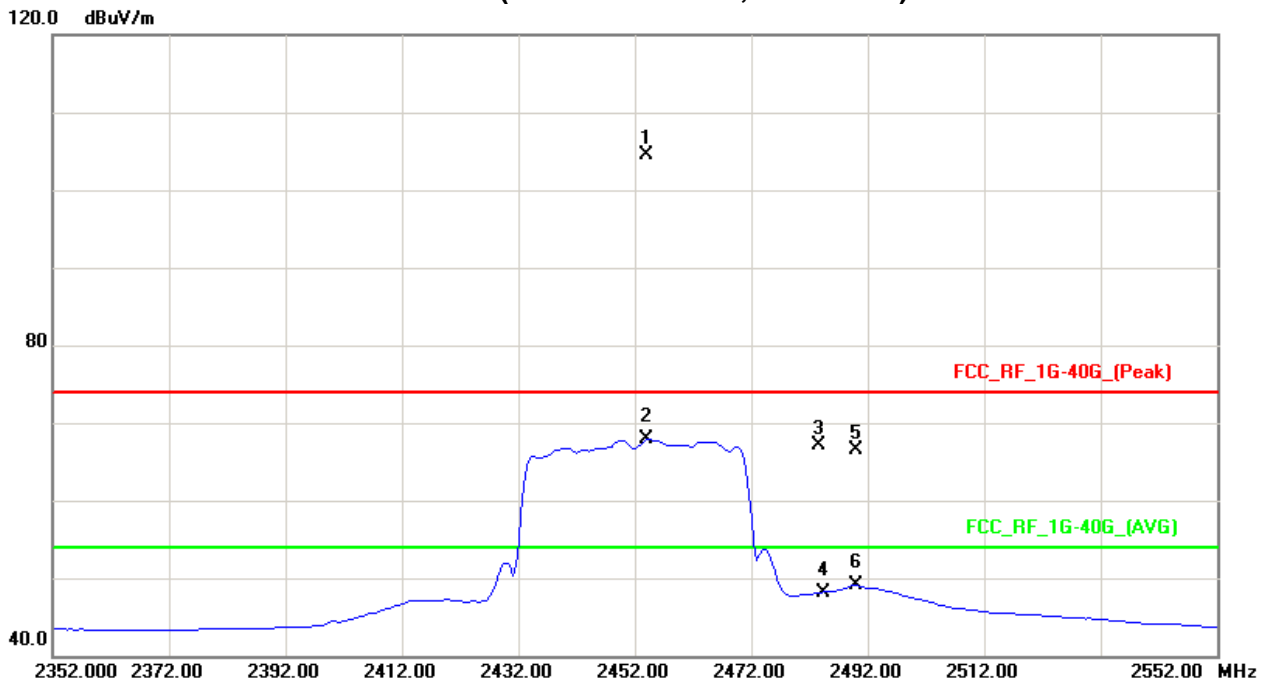



5. BANDWIDTH TEST

5.1 Applied procedures / limit

FCC Part15 (15.247) , Subpart C			
Section	Test Item	Frequency Range (MHz)	Result
15.247(a)(2)	Bandwidth	2400-2483.5	PASS

5.1.1 MEASUREMENT INSTRUMENTS LIST

Item	Kind of Equipment	Manufacturer	Type No.	Serial No.	Last Calibration	Next Calibration
1	Spectrum Analyzer	R&S	FSP_40	100185	Nov.25.2012	Nov.16.2013

Remark: "N/A" denotes no model name, serial no. or calibration specified.

5.1.2 TEST PROCEDURE

- a. The EUT was directly connected to the spectrum analyzer and antenna output port as show in the block diagram below,
- b. Spectrum Setting : RBW= 100KHz, VBW=300KHz, Sweep time = Auto.

5.1.3 DEVIATION FROM STANDARD

No deviation.

5.1.4 TEST SETUP

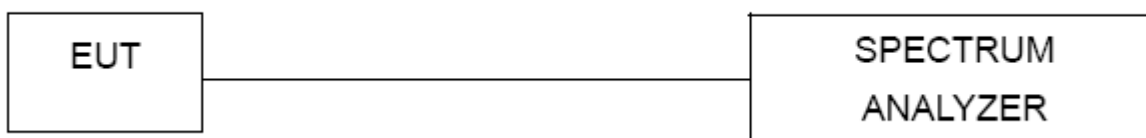

5.1.5 EUT OPERATION CONDITIONS

The EUT tested system was configured as the statements of 4.1.6 Unless otherwise a special operating condition is specified in the follows during the testing.



5.1.6 TEST RESULTS

EUT :	Wireless VDSL2 4-port Ethernet Router	Model Name. :	DSL-6740B
Temperature :	24 °C	Relative Humidity :	60 %
Pressure :	1016 hPa	Test Voltage :	AC 120V/60Hz
Test Mode :	TX B MODE /CH01, CH06, CH11		

Test Channel	Frequency (MHz)	Bandwidth (MHz)	Test Result
CH01	2412	8.04	PASS
CH06	2437	9.08	PASS
CH11	2462	8.08	PASS

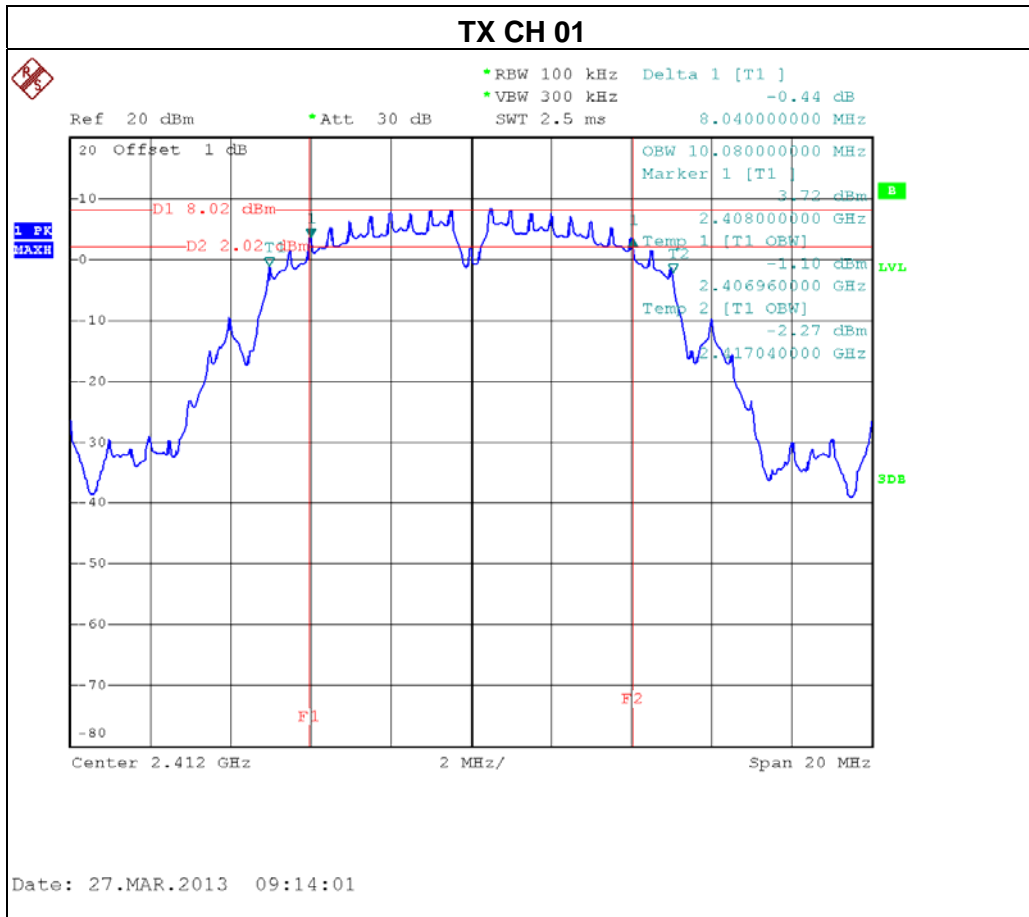

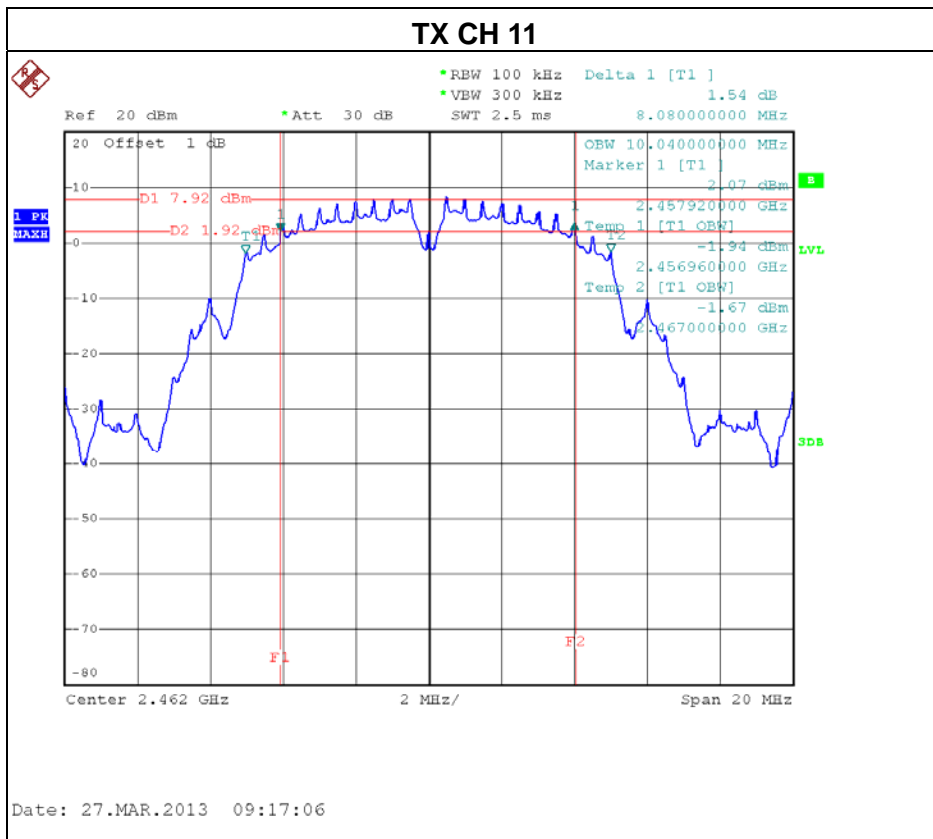
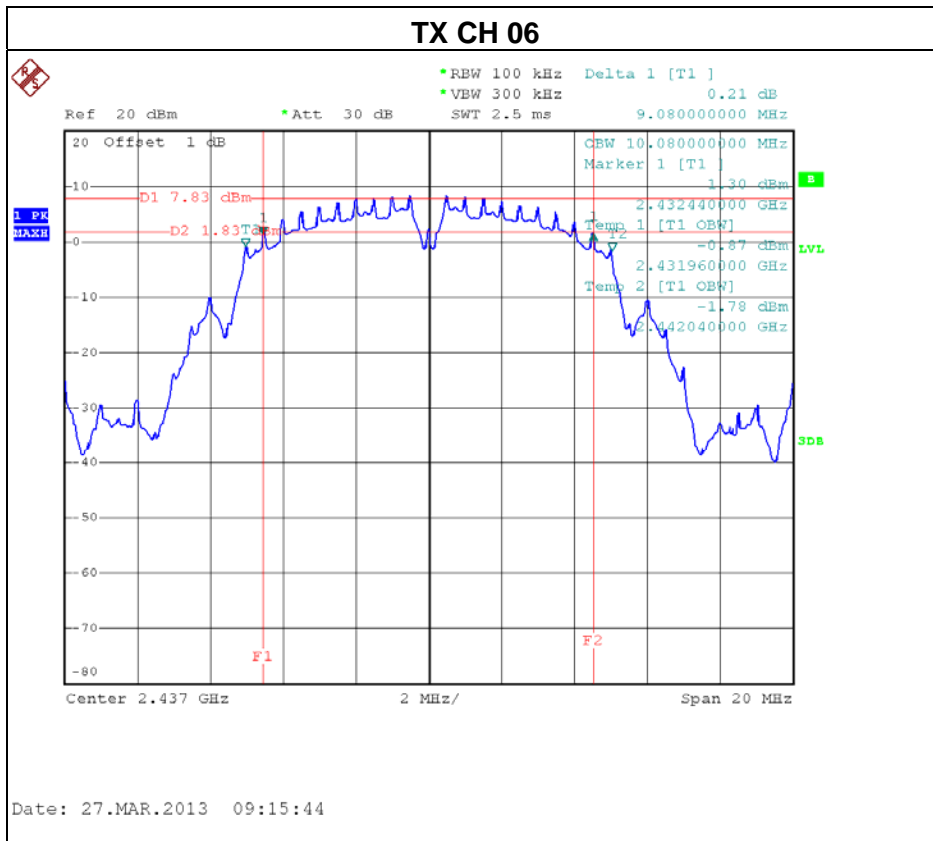



EUT :	Wireless VDSL2 4-port Ethernet Router	Model Name. :	DSL-6740B
Temperature :	24 °C	Relative Humidity :	60 %
Pressure :	1016 hPa	Test Voltage :	AC 120V/60Hz
Test Mode :	TX G MODE /CH01, CH06, CH11		

Test Channel	Frequency (MHz)	Bandwidth (MHz)	Test Result
CH01	2412	15.12	PASS
CH06	2437	15.16	PASS
CH11	2462	15.16	PASS

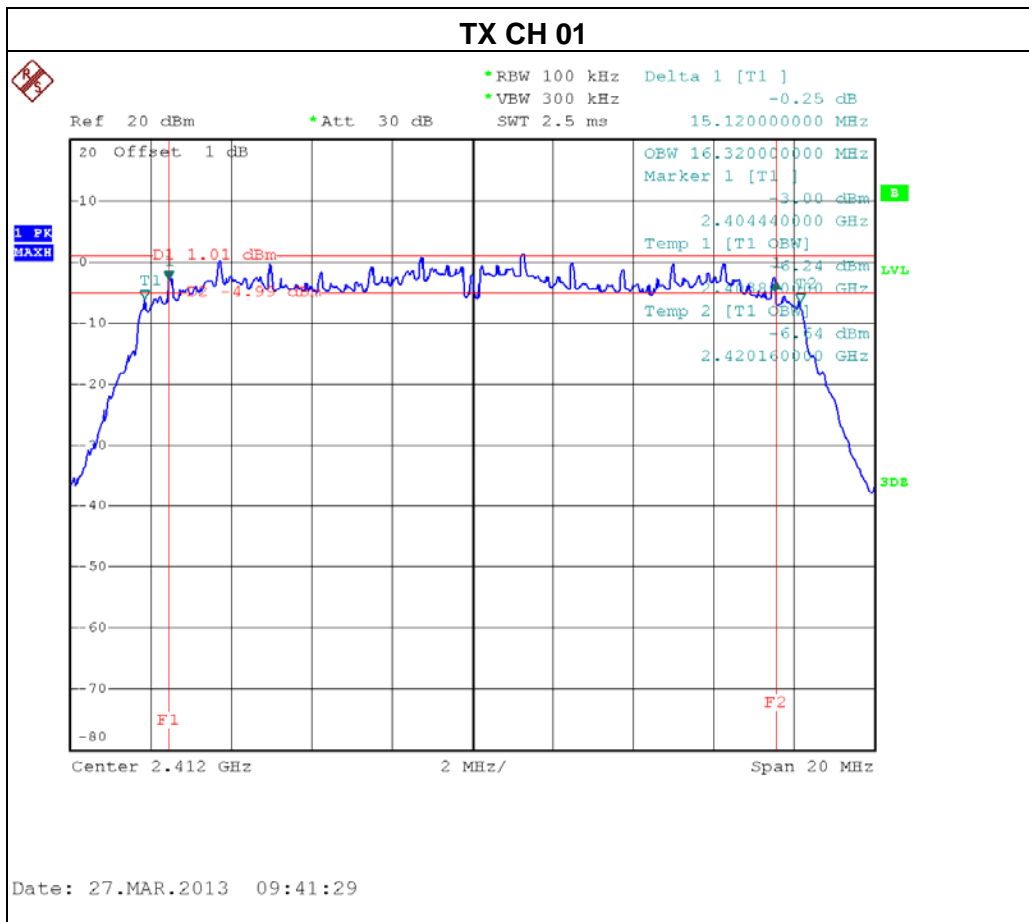

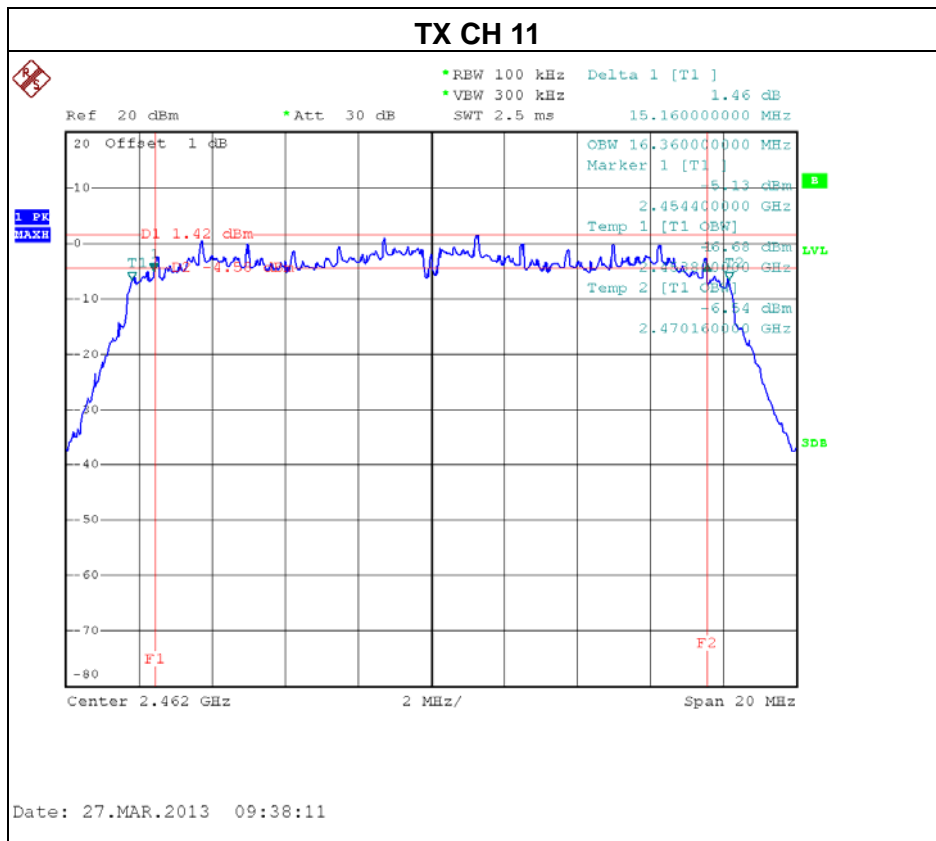
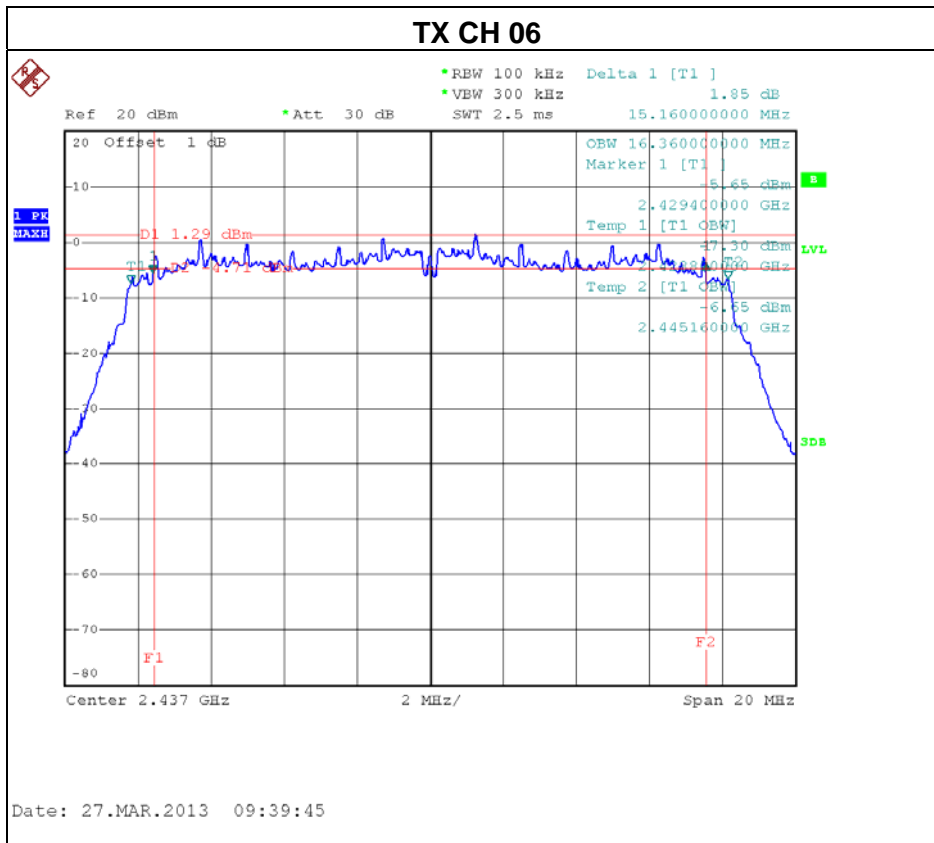



EUT :	Wireless VDSL2 4-port Ethernet Router	Model Name. :	DSL-6740B
Temperature :	24 °C	Relative Humidity :	60 %
Pressure :	1016 hPa	Test Voltage :	AC 120V/60Hz
Test Mode :	TX N MODE -20MHz/ CH01, CH06, CH11-ANT 1		

Test Channel	Frequency (MHz)	Bandwidth (MHz)	Test Result
CH01	2412	15.20	PASS
CH06	2437	15.10	PASS
CH11	2462	15.20	PASS

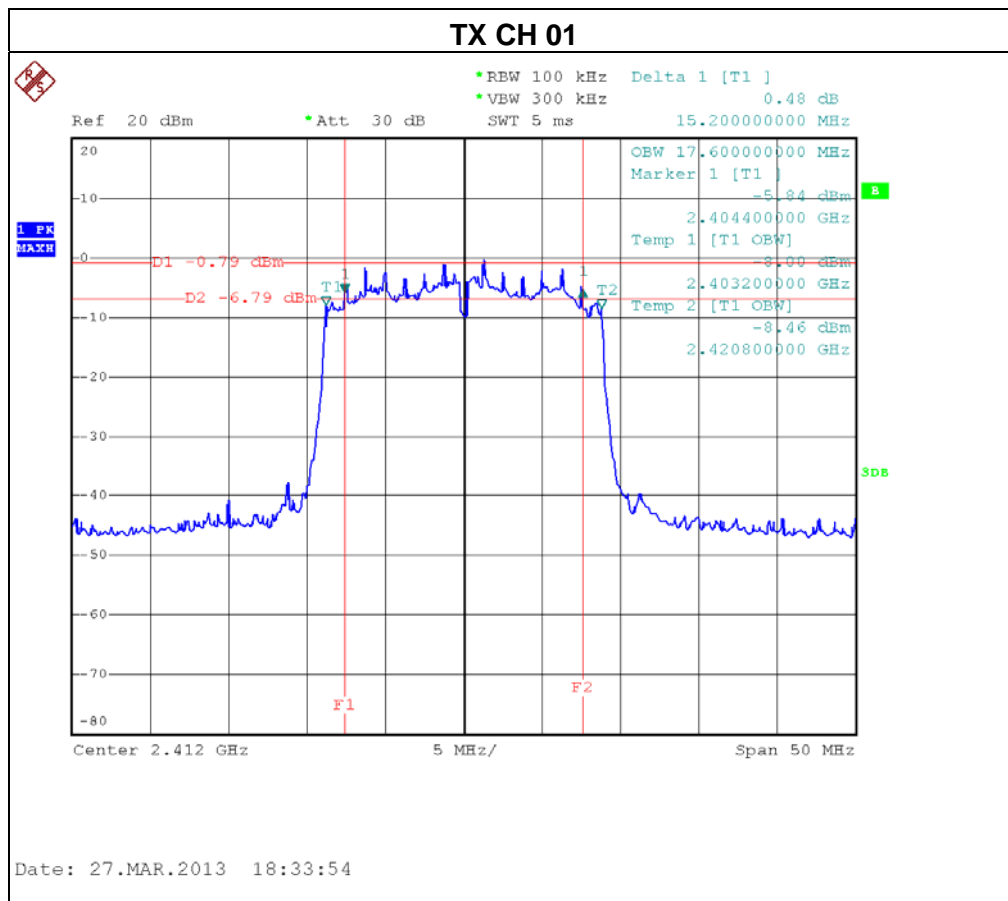

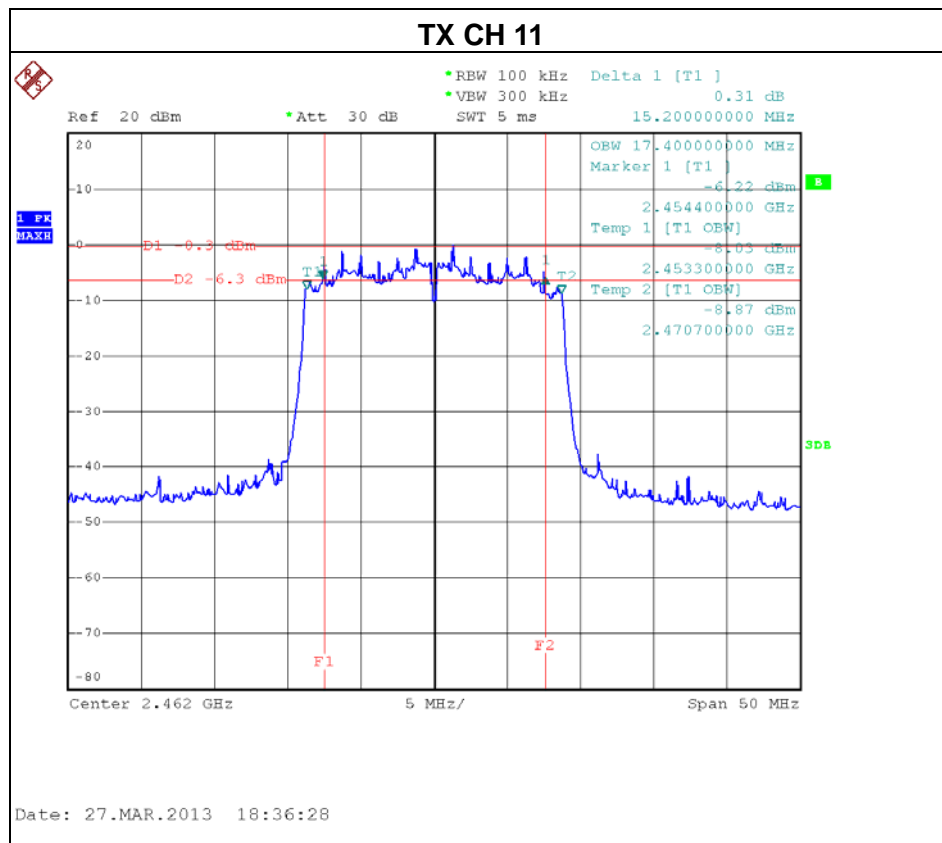
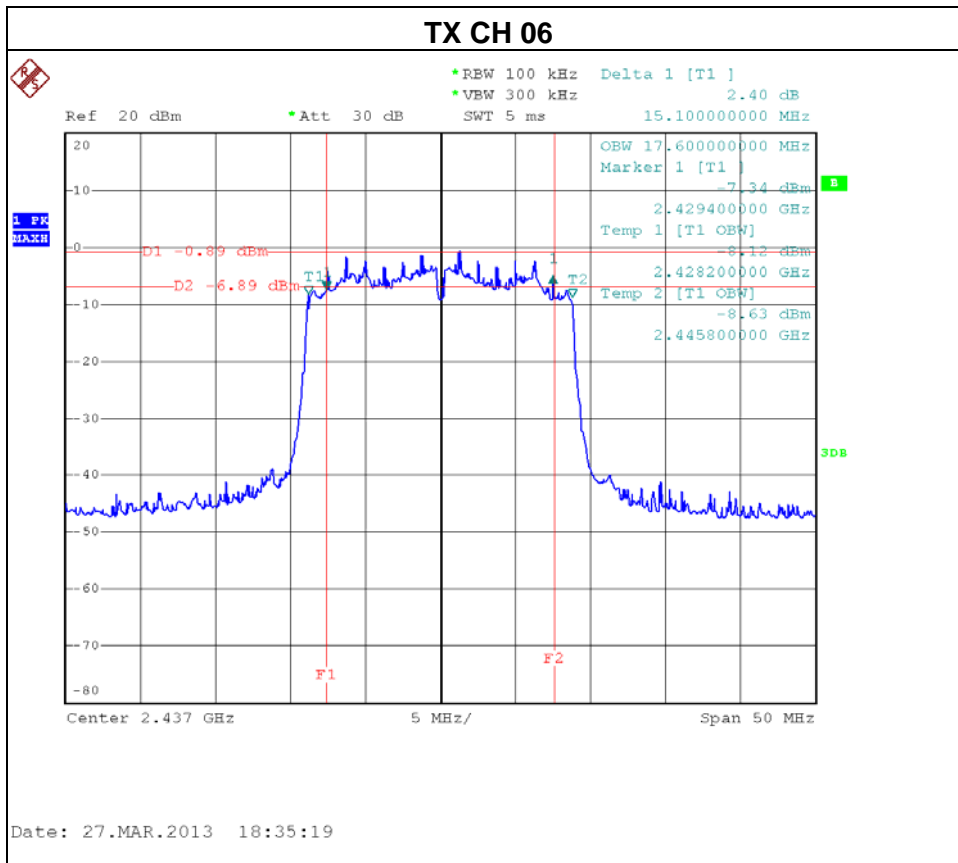



EUT :	Wireless VDSL2 4-port Ethernet Router	Model Name. :	DSL-6740B
Temperature :	24 °C	Relative Humidity :	60 %
Pressure :	1016 hPa	Test Voltage :	AC 120V/60Hz
Test Mode :	TX N MODE -20MHz/ CH01, CH06, CH11-ANT 2		

Test Channel	Frequency (MHz)	Bandwidth (MHz)	Test Result
CH01	2412	15.80	PASS
CH06	2437	15.70	PASS
CH11	2462	15.80	PASS

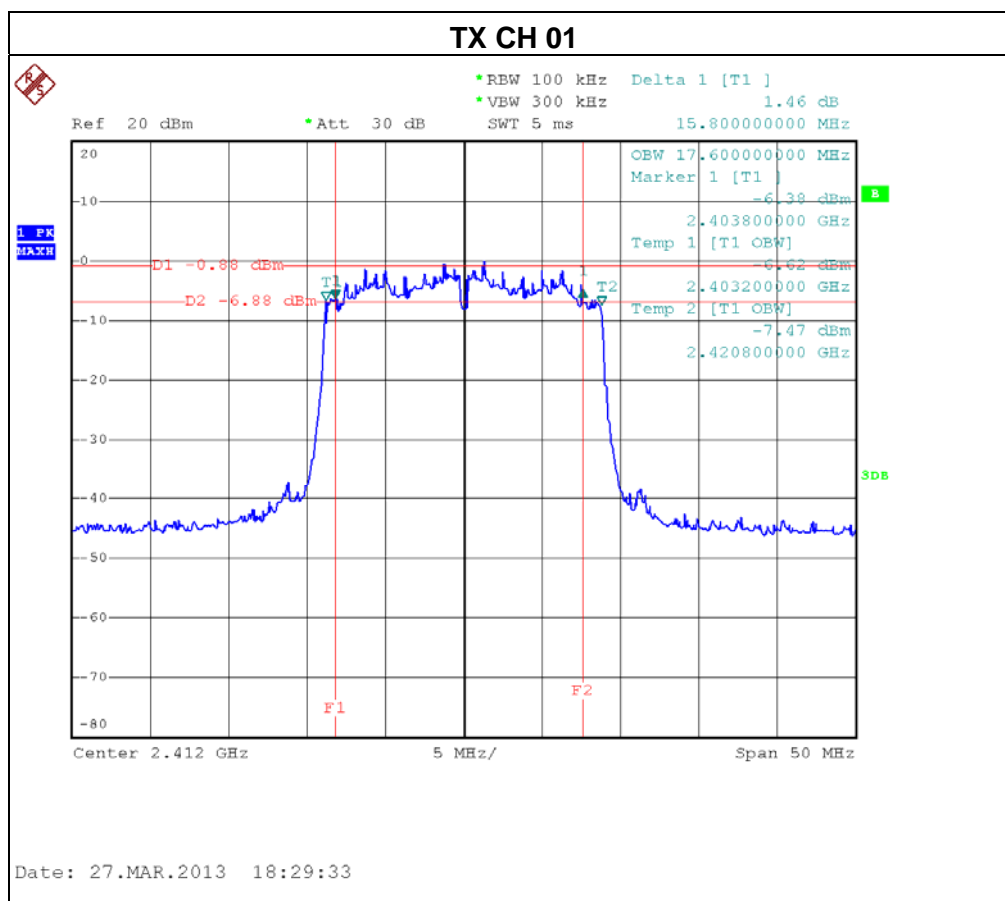

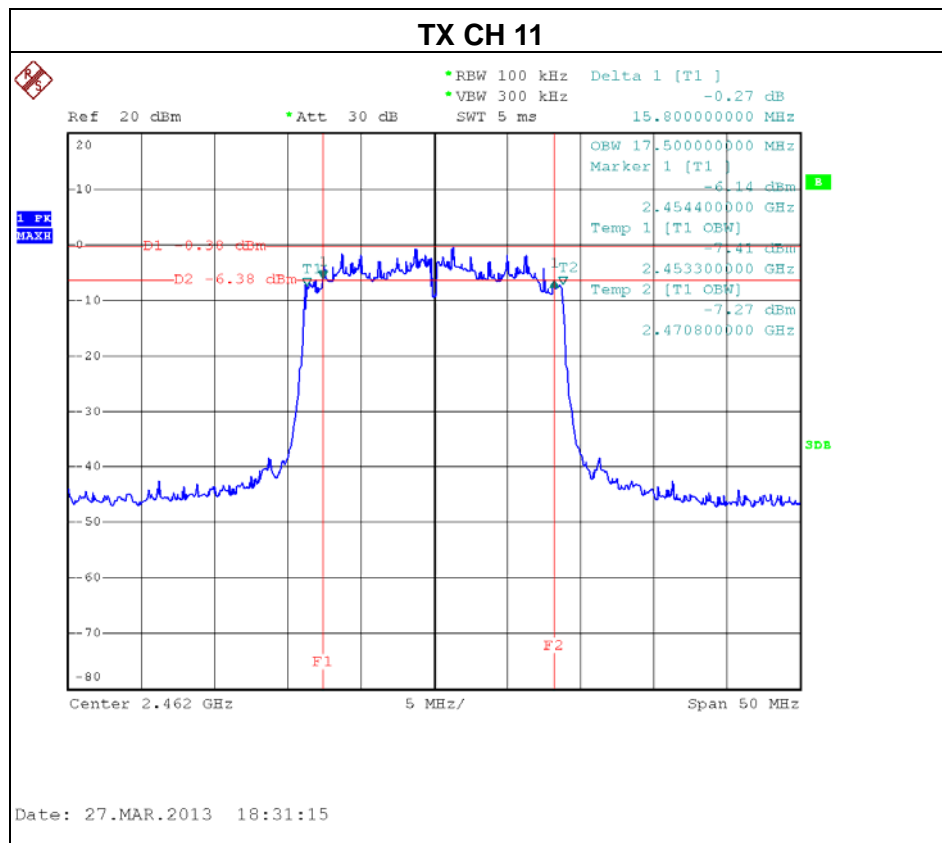
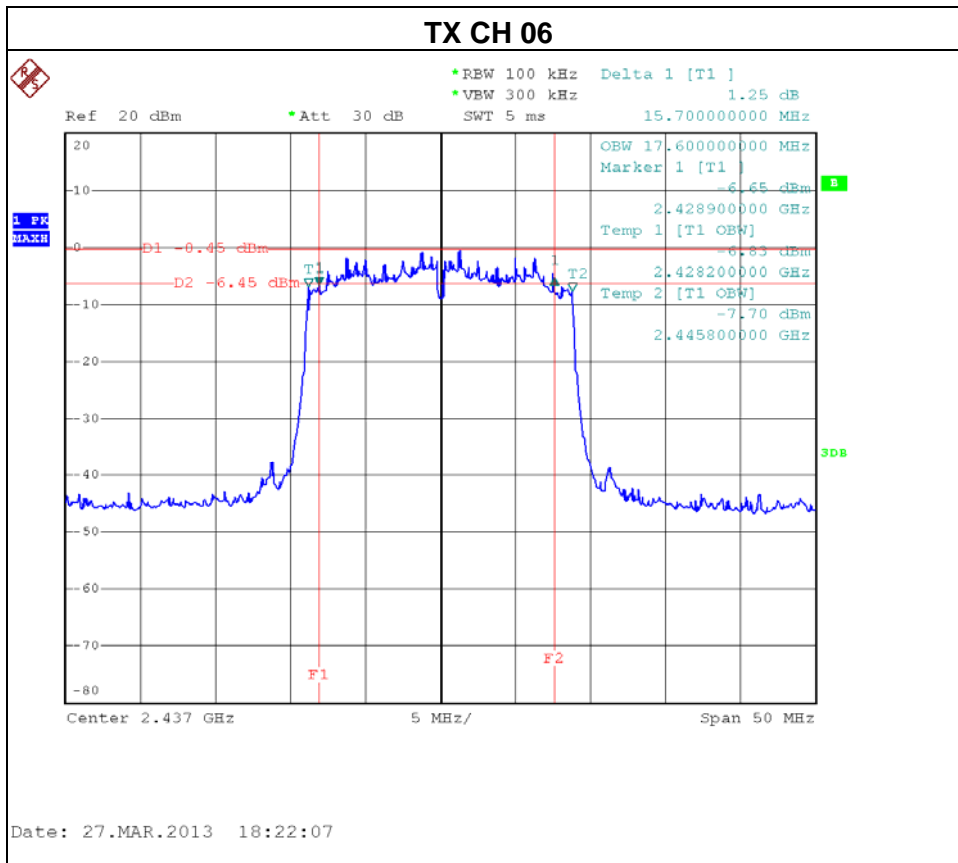



EUT :	Wireless VDSL2 4-port Ethernet Router	Model Name. :	DSL-6740B
Temperature :	24 °C	Relative Humidity :	60 %
Pressure :	1016 hPa	Test Voltage :	AC 120V/60Hz
Test Mode :	TX N MODE -40MHz/ CH03, CH06, CH09 -ANT 1		

Test Channel	Frequency (MHz)	Bandwidth (MHz)	Test Result
CH03	2422	36.40	PASS
CH06	2437	36.50	PASS
CH09	2452	35.10	PASS

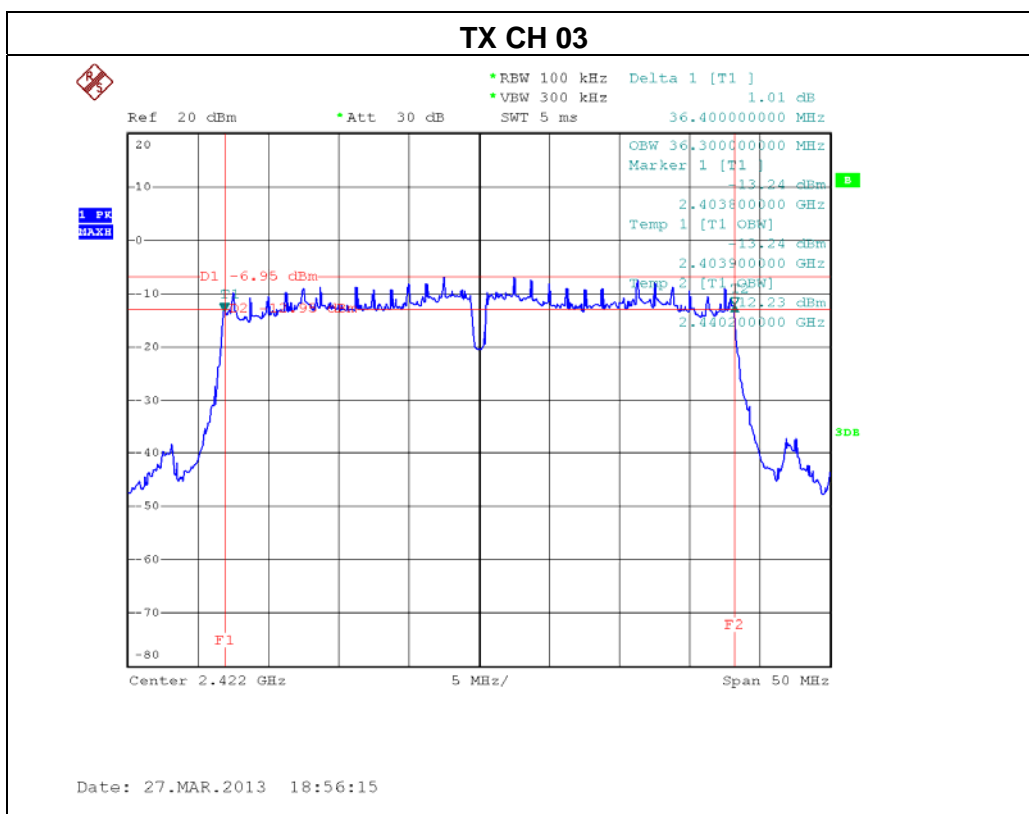

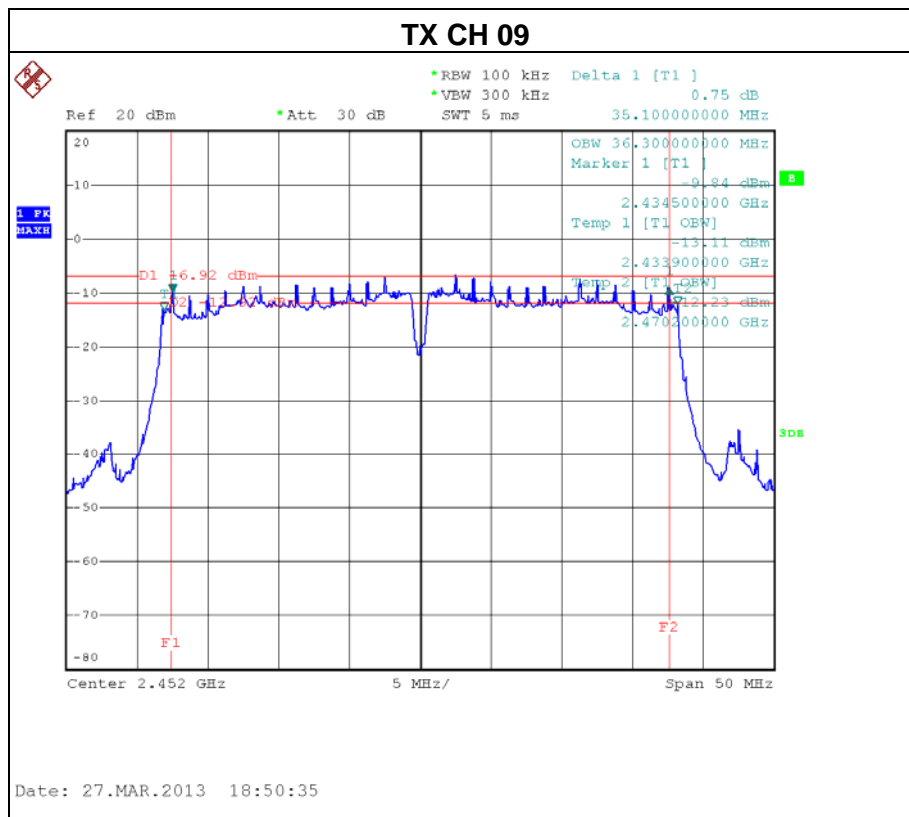
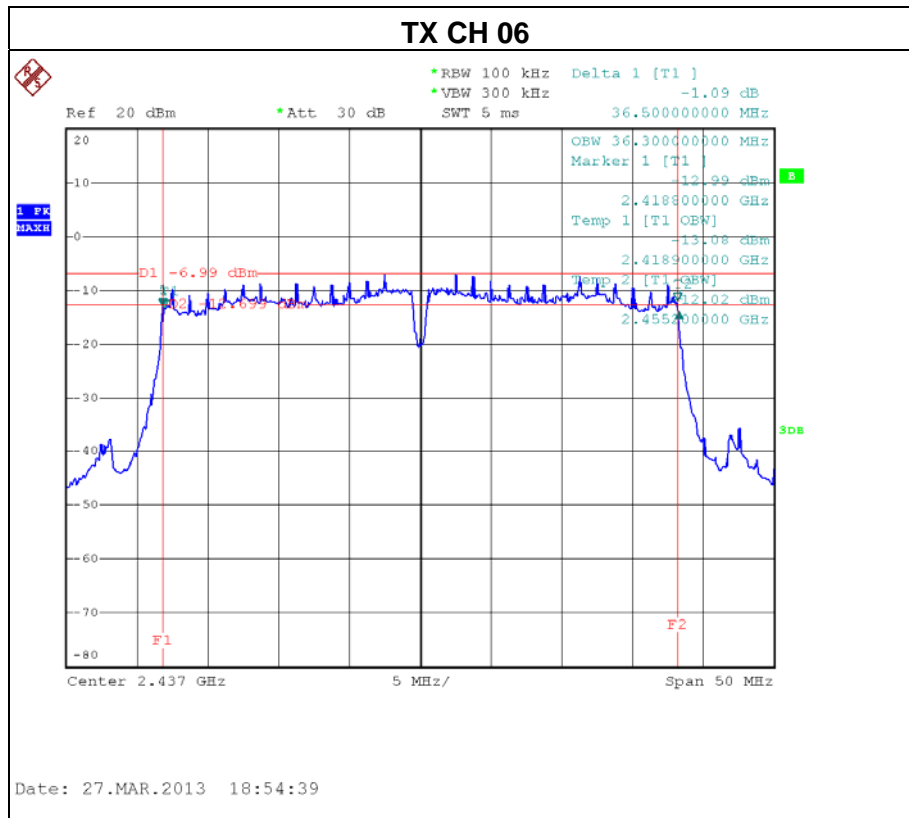



EUT :	Wireless VDSL2 4-port Ethernet Router	Model Name. :	DSL-6740B
Temperature :	24 °C	Relative Humidity :	60 %
Pressure :	1016 hPa	Test Voltage :	AC 120V/60Hz
Test Mode :	TX N MODE -40MHz/ CH03, CH06, CH09 -ANT 2		

Test Channel	Frequency (MHz)	Bandwidth (MHz)	Test Result
CH03	2422	36.00	PASS
CH06	2437	36.40	PASS
CH09	2452	35.30	PASS

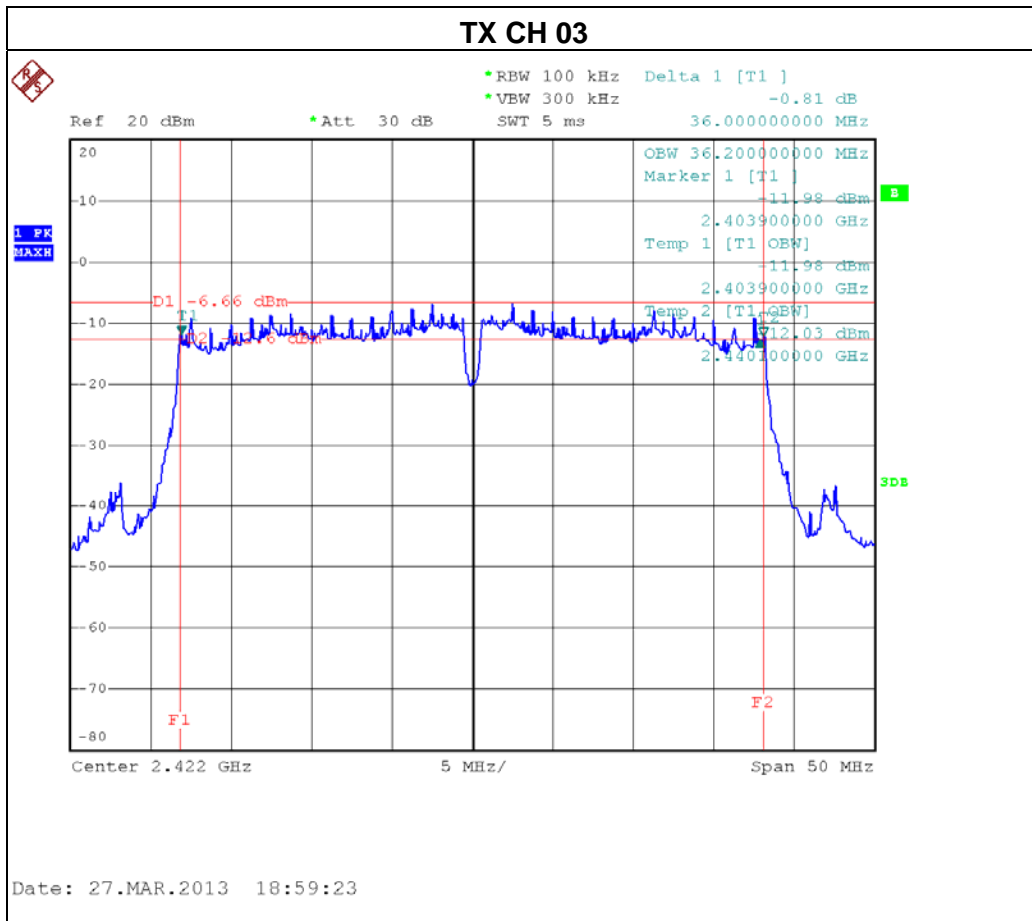

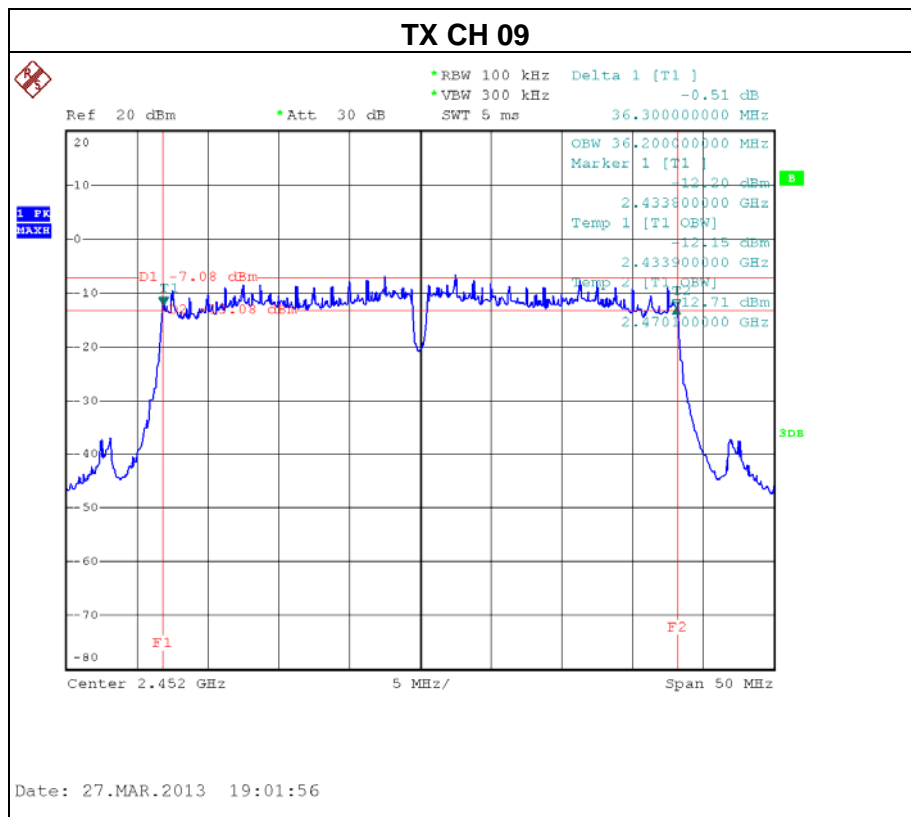
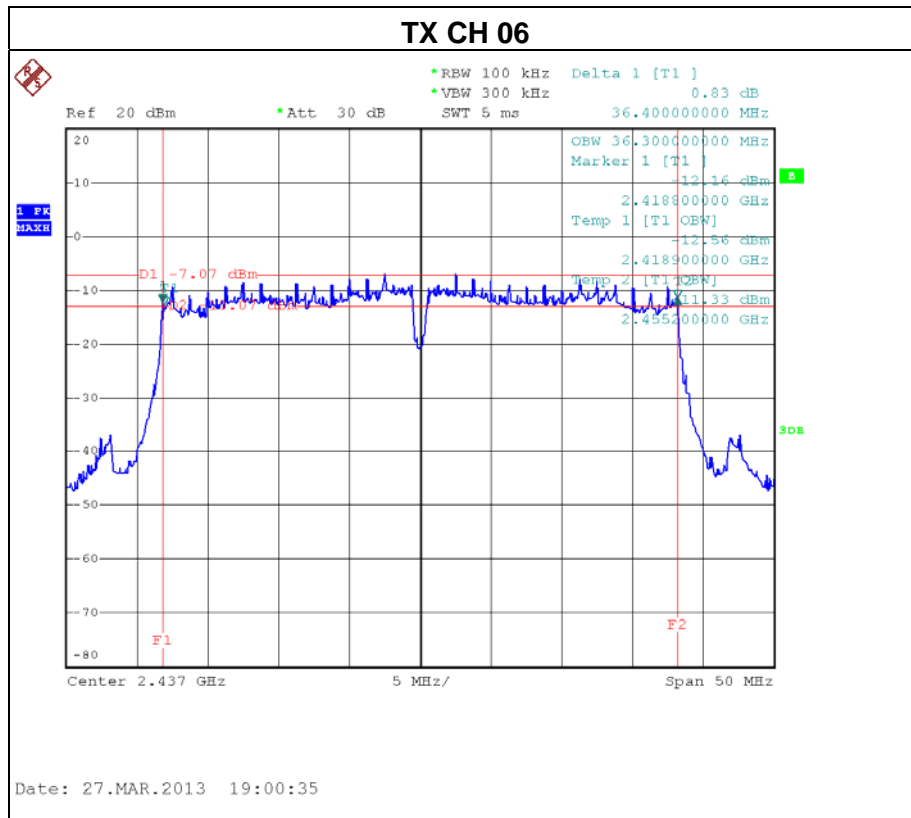



6. MAXIMUM OUTPUT POWER TEST

6.1 Applied procedures / limit

FCC Part15 (15.247) , Subpart C				
Section	Test Item	Limit	Frequency Range (MHz)	Result
15.247(b)(3)	Maximum Output Power	1 watt or 30dBm	2400-2483.5	PASS

6.1.1 MEASUREMENT INSTRUMENTS LIST

Item	Kind of Equipment	Manufacturer	Type No.	Serial No.	Last Calibration	Next Calibration
1	Power Meter	Anritsu	ML2495A	1128009	Nov.01.2012	Nov.01.2013
2	Pluse Power Sensor	Anritsu	MA2411B	1128009	Nov.01.2012	Nov.01.2013

Remark: "N/A" denotes no model name, serial no. or calibration specified.

6.1.2 TEST PROCEDURE

- a. The EUT was directly connected to the power meter and antenna output port as show in the block diagram below.
- b. The maximum peak conducted output power was performed in accordance with method 9.1.3 of FCC KDB 558074 D01 DTS Meas Guidance v03r01.

6.1.3 DEVIATION FROM STANDARD

No deviation.

6.1.4 TEST SETUP

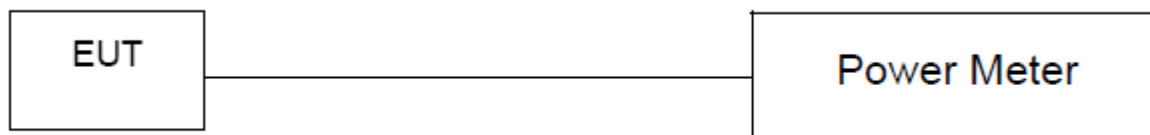

6.1.5 EUT OPERATION CONDITIONS

The EUT tested system was configured as the statements of 4.1.6 Unless otherwise a special operating condition is specified in the follows during the testing. Transmit output power was measured while the host equipment supply voltage was varied from 85 % to 115 % of the nominal rated supply voltage. No change in transmit output power was observed.



6.1.6 TEST RESULTS

EUT :	Wireless VDSL2 4-port Ethernet Router	Model Name :	DSL-6740B
Temperature :	24 °C	Relative Humidity :	60 %
Pressure :	1016 hPa	Test Voltage :	AC 120V/60Hz
Test Mode :	TX B MODE /CH01, CH06, CH11		

Maximum Output Power

Test Channel	Frequency (MHz)	Output Power (dBm)	LIMIT (dBm)	LIMIT (W)
CH01	2412 MHz	21.37	30	1
CH06	2437 MHz	21.58	30	1
CH11	2462 MHz	21.22	30	1

EUT :	Wireless VDSL2 4-port Ethernet Router	Model Name :	DSL-6740B
Temperature :	24 °C	Relative Humidity :	60 %
Pressure :	1016 hPa	Test Voltage :	AC 120V/60Hz
Test Mode :	TX G MODE /CH01, CH06, CH11		

Maximum Output Power

Test Channel	Frequency (MHz)	Output Power (dBm)	LIMIT (dBm)	LIMIT (W)
CH01	2412 MHz	18.87	30	1
CH06	2437 MHz	18.92	30	1
CH11	2462 MHz	18.95	30	1



EUT :	Wireless VDSL2 4-port Ethernet Router	Model Name :	DSL-6740B
Temperature :	24 °C	Relative Humidity :	60 %
Pressure :	1016 hPa	Test Voltage :	AC 120V/60Hz
Test Mode :	TX N-20M MODE /CH01, CH06, CH11-ANT 1		

Maximum Output Power

Test Channel	Frequency (MHz)	Output Power (dBm)	LIMIT (dBm)	LIMIT (W)
CH01	2412 MHz	17.10	30	1
CH06	2437 MHz	16.74	30	1
CH11	2462 MHz	16.97	30	1

EUT :	Wireless VDSL2 4-port Ethernet Router	Model Name :	DSL-6740B
Temperature :	24 °C	Relative Humidity :	60 %
Pressure :	1016 hPa	Test Voltage :	AC 120V/60Hz
Test Mode :	TX N-20M MODE /CH01, CH06, CH11-ANT 2		

Maximum Output Power

Test Channel	Frequency (MHz)	Output Power (dBm)	LIMIT (dBm)	LIMIT (W)
CH01	2412 MHz	17.01	30	1
CH06	2437 MHz	17.11	30	1
CH11	2462 MHz	17.47	30	1

EUT :	Wireless VDSL2 4-port Ethernet Router	Model Name :	DSL-6740B
Temperature :	24 °C	Relative Humidity :	60 %
Pressure :	1016 hPa	Test Voltage :	AC 120V/60Hz
Test Mode :	TX N-20M MODE /CH01, CH06, CH11-ANT 1+ANT 2		

Maximum Output Power

Test Channel	Frequency (MHz)	Output Power (dBm)	LIMIT (dBm)	LIMIT (W)
CH01	2412 MHz	20.07	30	1
CH06	2437 MHz	19.94	30	1
CH11	2462 MHz	20.24	30	1



EUT :	Wireless VDSL2 4-port Ethernet Router	Model Name :	DSL-6740B
Temperature :	24 °C	Relative Humidity :	60 %
Pressure :	1016 hPa	Test Voltage :	AC 120V/60Hz
Test Mode :	TX N-40M MODE /CH03, CH06, CH09-ANT 1		

Maximum Output Power

Test Channel	Frequency (MHz)	Output Power (dBm)	LIMIT (dBm)	LIMIT (W)
CH03	2422 MHz	14.35	30	1
CH06	2437 MHz	14.41	30	1
CH09	2452 MHz	14.37	30	1

EUT :	Wireless VDSL2 4-port Ethernet Router	Model Name :	DSL-6740B
Temperature :	24 °C	Relative Humidity :	60 %
Pressure :	1016 hPa	Test Voltage :	AC 120V/60Hz
Test Mode :	TX N-40M MODE /CH03, CH06, CH09-ANT 2		

Maximum Output Power

Test Channel	Frequency (MHz)	Output Power (dBm)	LIMIT (dBm)	LIMIT (W)
CH03	2422 MHz	13.87	30	1
CH06	2437 MHz	13.97	30	1
CH09	2452 MHz	14.02	30	1

EUT :	Wireless VDSL2 4-port Ethernet Router	Model Name :	DSL-6740B
Temperature :	24 °C	Relative Humidity :	60 %
Pressure :	1016 hPa	Test Voltage :	AC 120V/60Hz
Test Mode :	TX N-40M MODE /CH03, CH06, CH09-ANT 1+ANT 2		

Maximum Output Power

Test Channel	Frequency (MHz)	Output Power (dBm)	LIMIT (dBm)	LIMIT (W)
CH03	2422 MHz	17.13	30	1
CH06	2437 MHz	17.21	30	1
CH09	2452 MHz	17.21	30	1



7. ANTENNA CONDUCTED SPURIOUS EMISSION

7.1 Applied procedures / limit

30dBc in any 100 kHz bandwidth outside the operating frequency band. In case the emission fall within the restricted band specified on 15.205(a), then the 15.209(a) limit in the table below has to be followed.

Frequencies (MHz)	Field Strength (micorvolts/meter)	Measurement Distance (meters)
0.009~0.490	2400/F(KHz)	300
0.490~1.705	24000/F(KHz)	30
1.705~30.0	30	30
30~88	100	3
88~216	150	3
216~960	200	3
960~1000	500	3

7.1.1 MEASUREMENT INSTRUMENTS LIST

Item	Kind of Equipment	Manufacturer	Type No.	Serial No.	Last Calibration	Next Calibration
1	Spectrum Analyzer	R&S	FSP_40	100185	Nov.25.2012	Nov.16.2013

Remark: "N/A" denotes no model name, serial no. or calibration specified.

7.1.2 TEST PROCEDURE

- a. The EUT was directly connected to the spectrum analyzer and antenna output port as show in the block diagram below,
- b. Spectrum Setting : RBW= 100KHz, VBW=300KHz, Sweep time = 10 ms.

7.1.3 DEVIATION FROM STANDARD

No deviation.

7.1.4 TEST SETUP

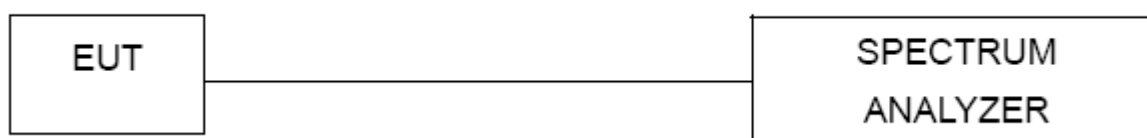

7.1.5 EUT OPERATION CONDITIONS

The EUT tested system was configured as the statements of 4.1.6 Unless otherwise a special operating condition is specified in the follows during the testing.



7.1.6 TEST RESULTS

EUT :	Wireless VDSL2 4-port Ethernet Router	Model Name :	DSL-6740B
Temperature :	24 °C	Relative Humidity :	60 %
Pressure :	1016 hPa	Test Voltage :	AC 120V/60Hz
Test Mode :	TX B MODE /CH01, CH06 , CH11		

Channel of Worst Data: CH01			
The max. radio frequency power in any 100kHz bandwidth outside the frequency band		The max. radio frequency power in any 100 kHz bandwidth within the frequency band.	
FREQUENCY(MHz)	POWER(dBm)	FREQUENCY(MHz)	POWER(dBm)
2400.00	-33.74	2489.60	-46.64

Result

In any 100kHz bandwidth outside the frequency band, the radio frequency power is at least 20dB below that in the 100kHz bandwidth within the band that contains the highest level of the desired power.

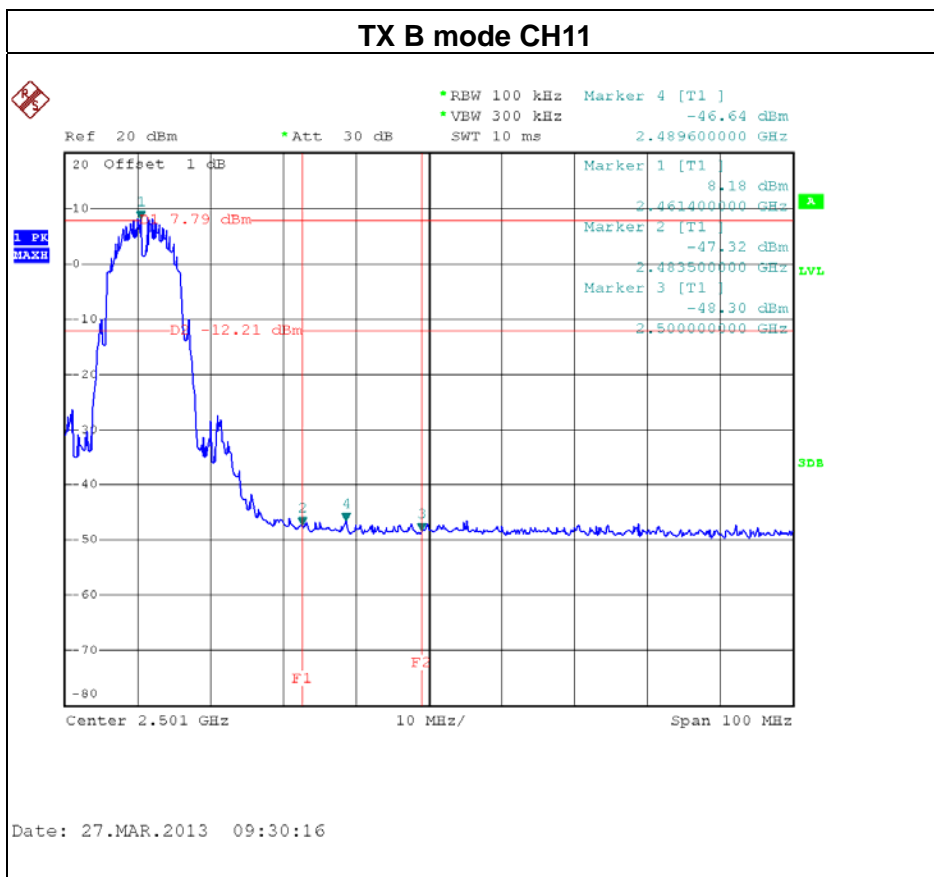
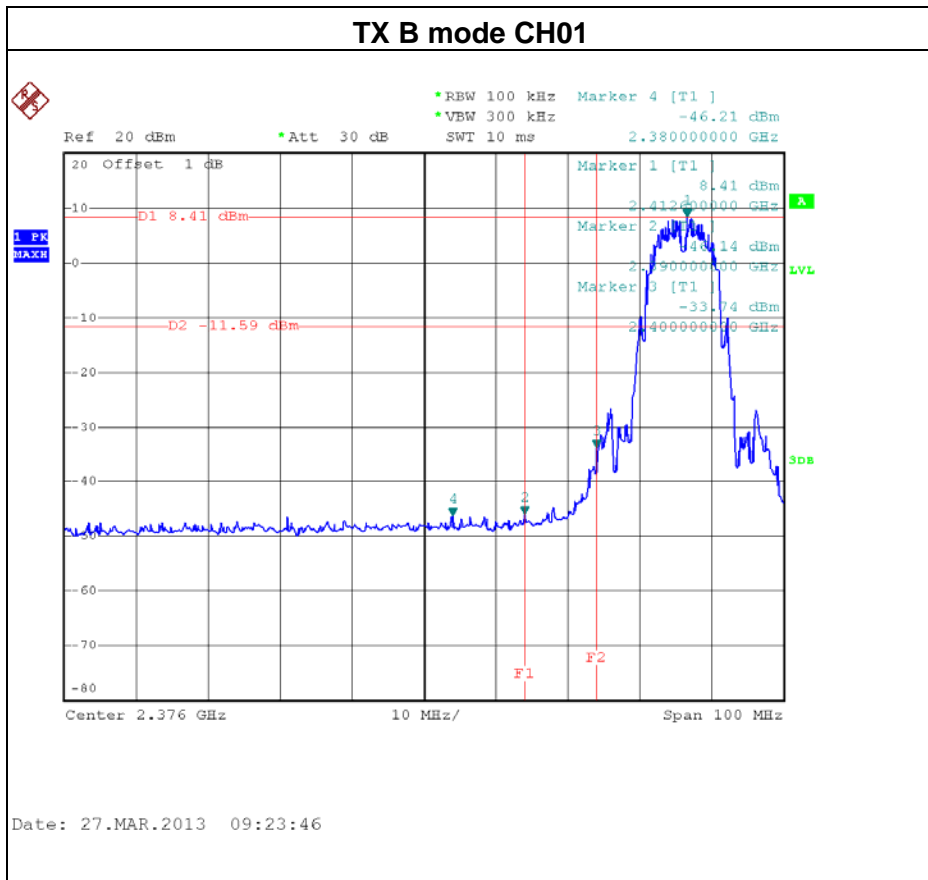

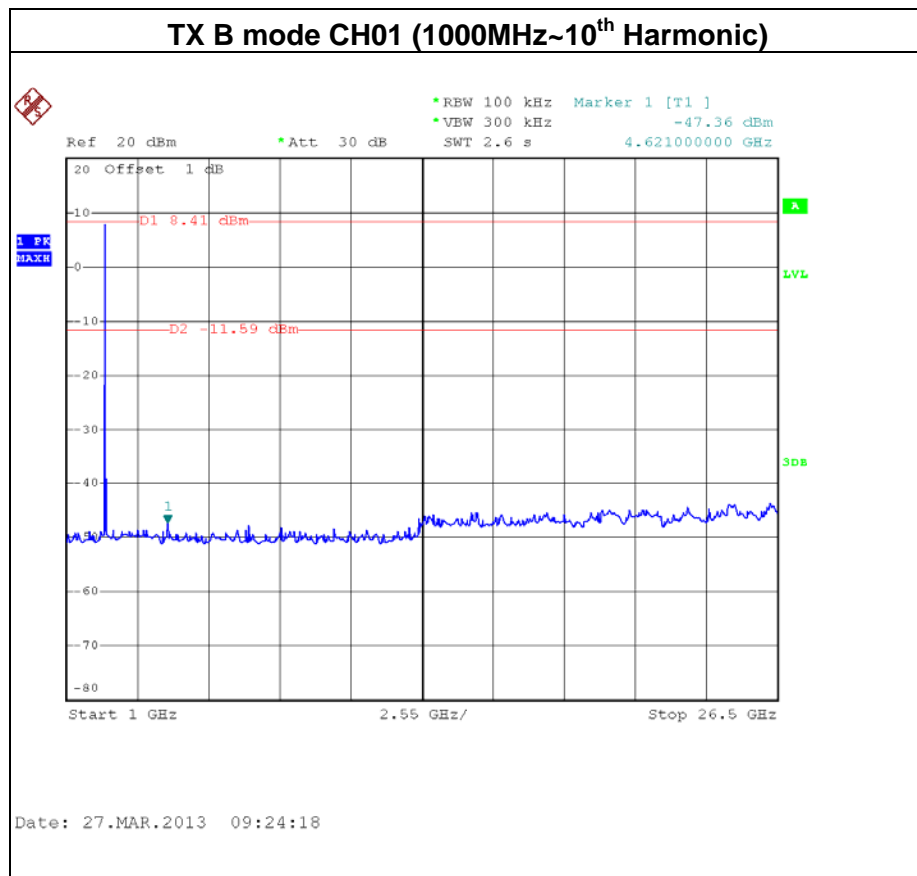
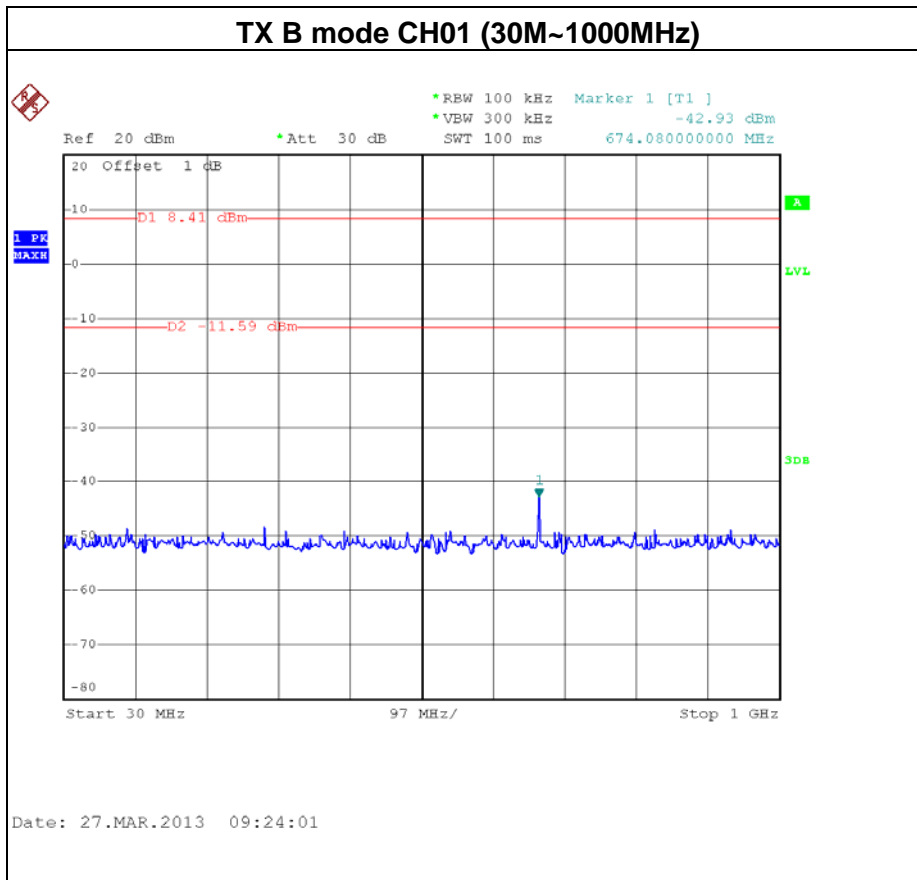

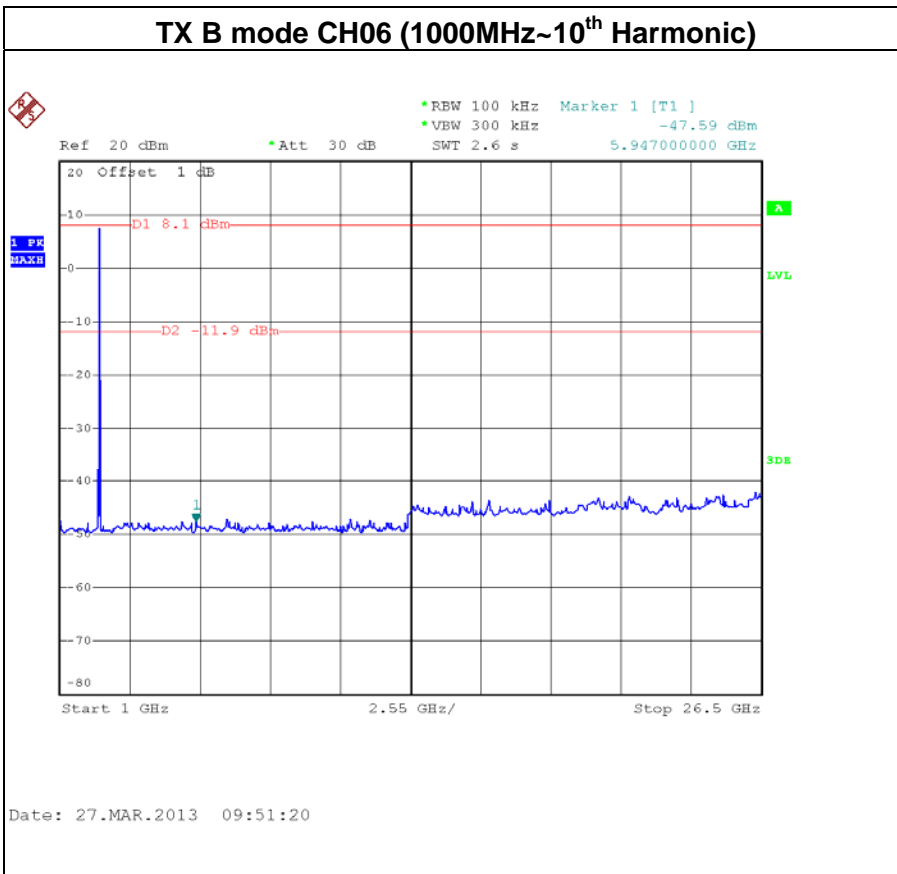
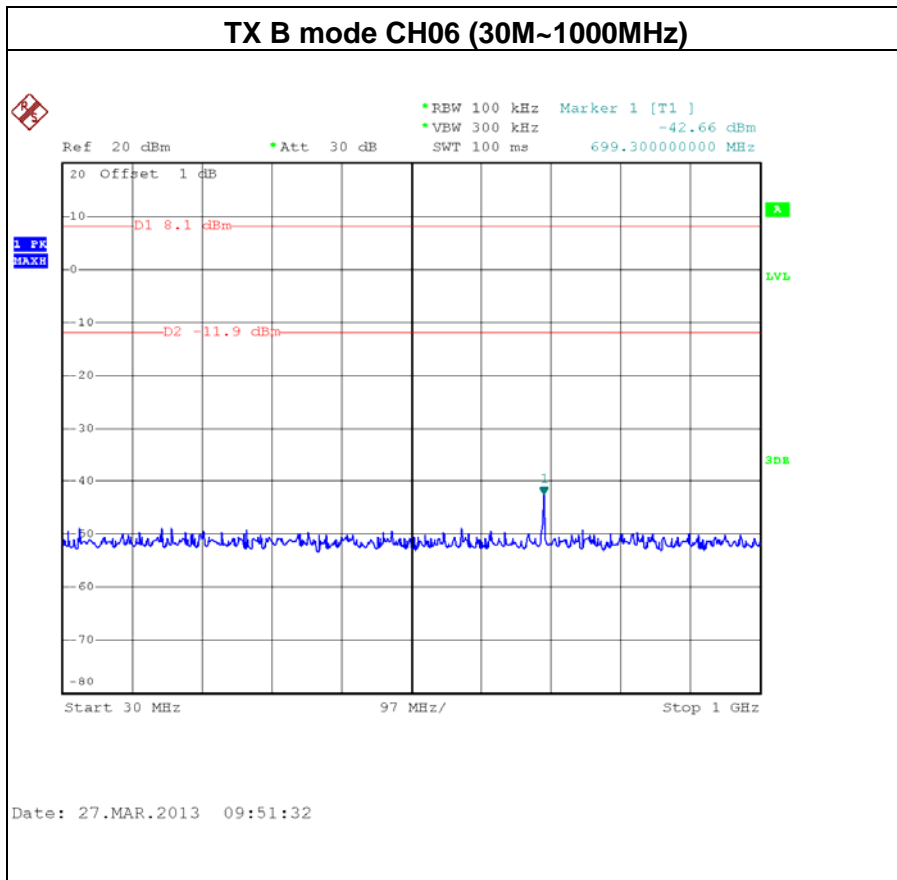

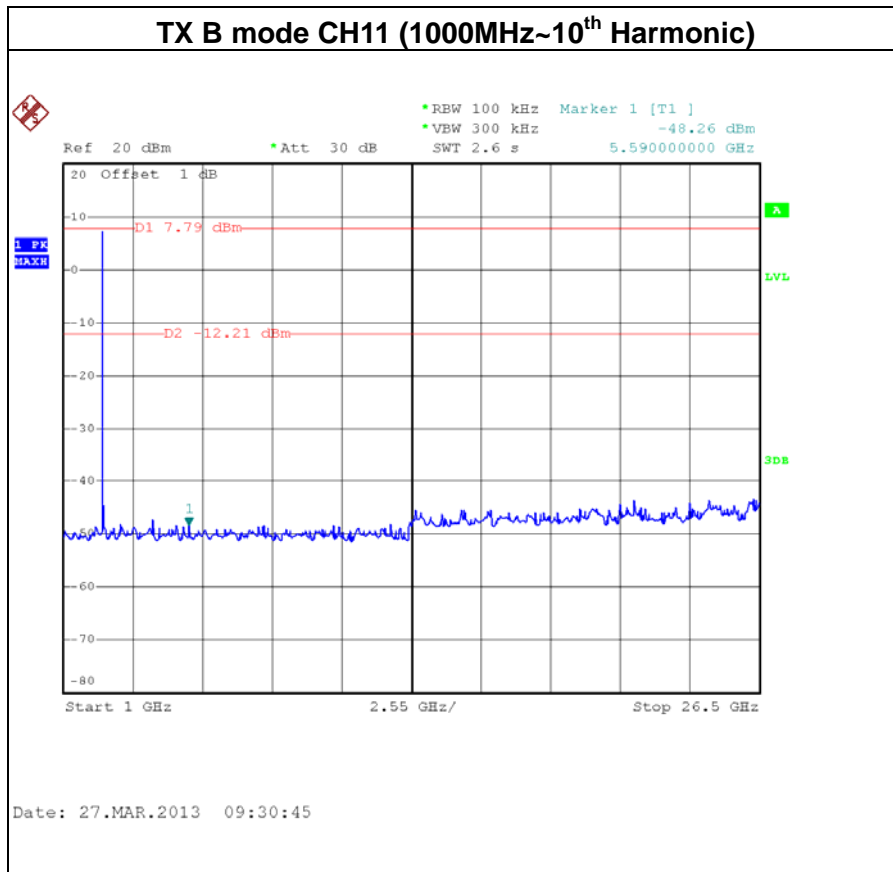
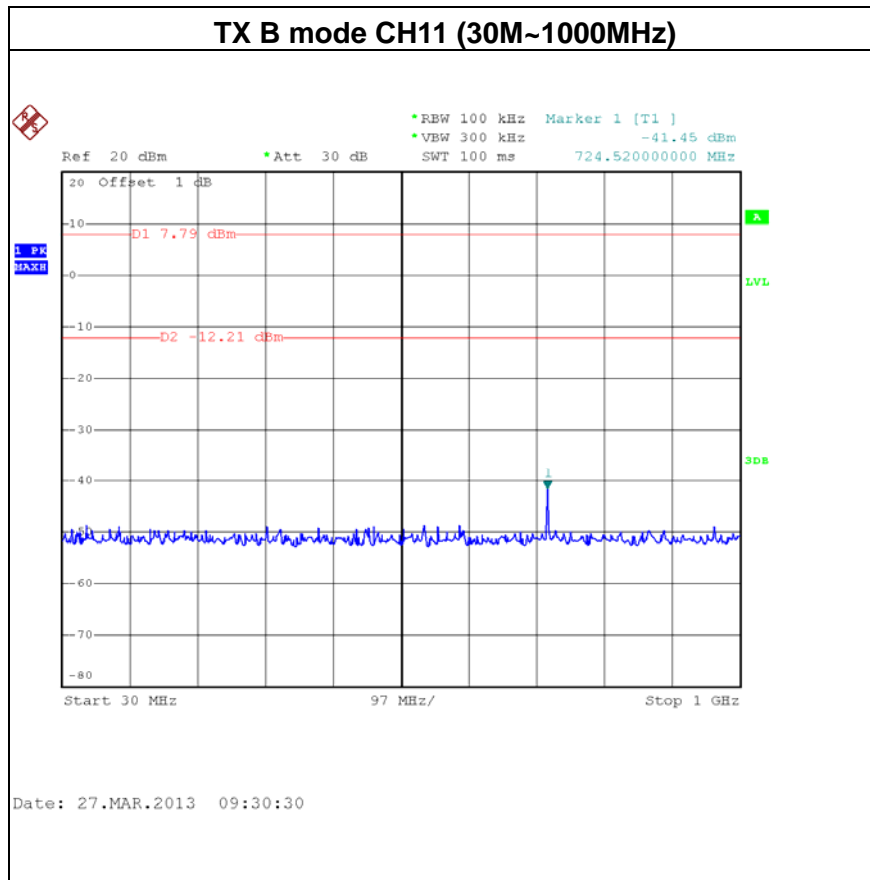



Neutron Engineering Inc.

EUT :	Wireless VDSL2 4-port Ethernet Router	Model Name :	DSL-6740B
Temperature :	24 °C	Relative Humidity :	60 %
Pressure :	1016 hPa	Test Voltage :	AC 120V/60Hz
Test Mode :	TX G MODE / CH01, CH06 , CH11		

Channel of Worst Data: CH01			
The max. radio frequency power in any 100kHz bandwidth outside the frequency band		The max. radio frequency power in any 100 kHz bandwidth within the frequency band.	
FREQUENCY(MHz)	POWER(dBm)	FREQUENCY(MHz)	POWER(dBm)
2400.00	-40.17	2485.60	-42.56
Result			
In any 100kHz bandwidth outside the frequency band, the radio frequency power is at least 20dB below that in the 100kHz bandwidth within the band that contains the highest level of the desired power.			

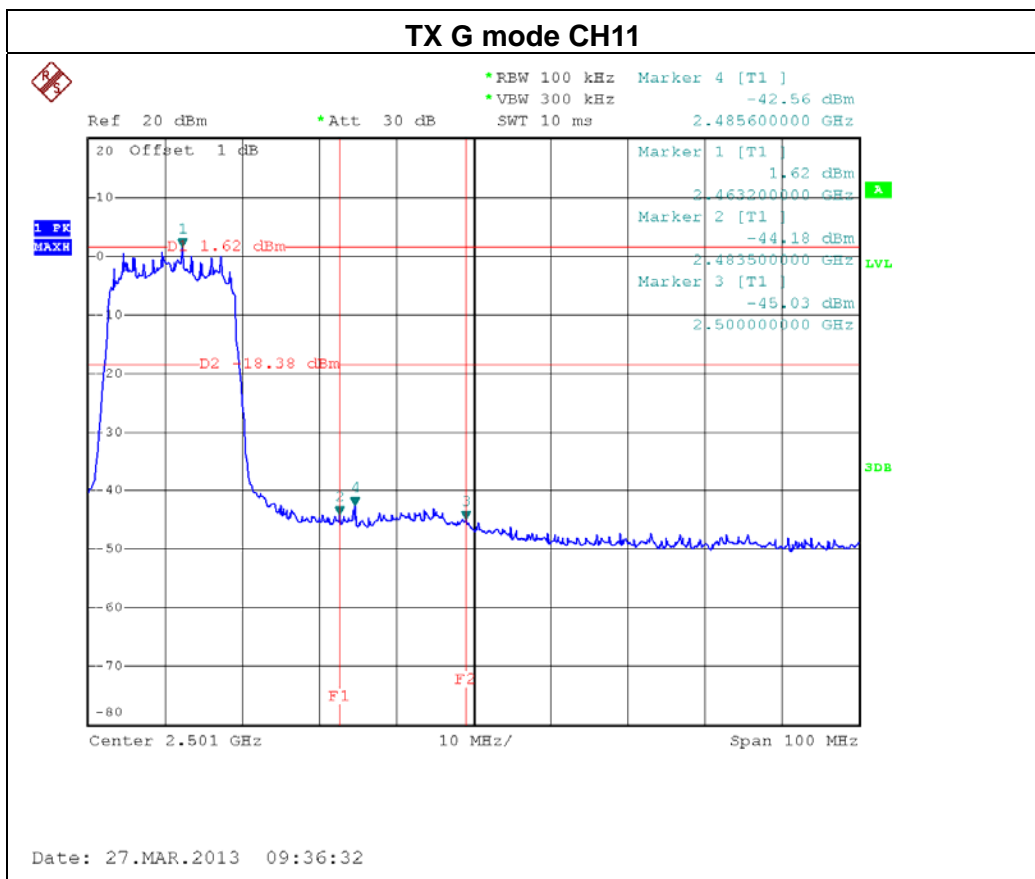
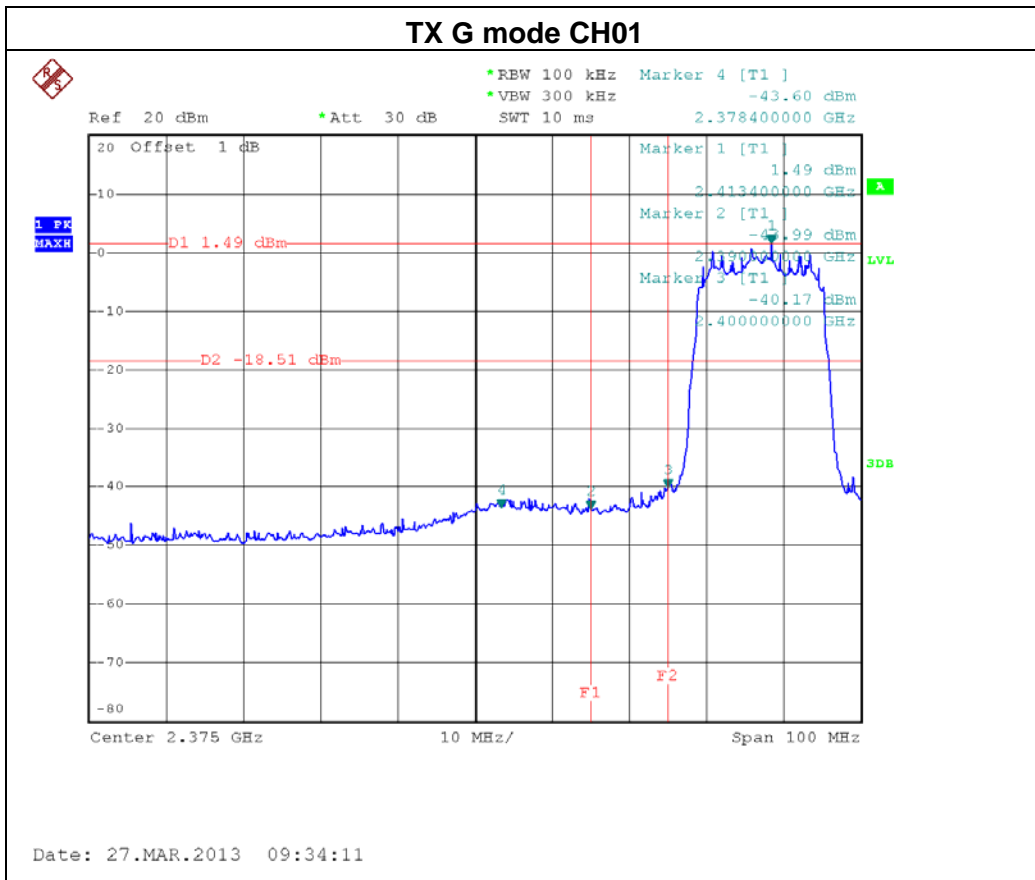

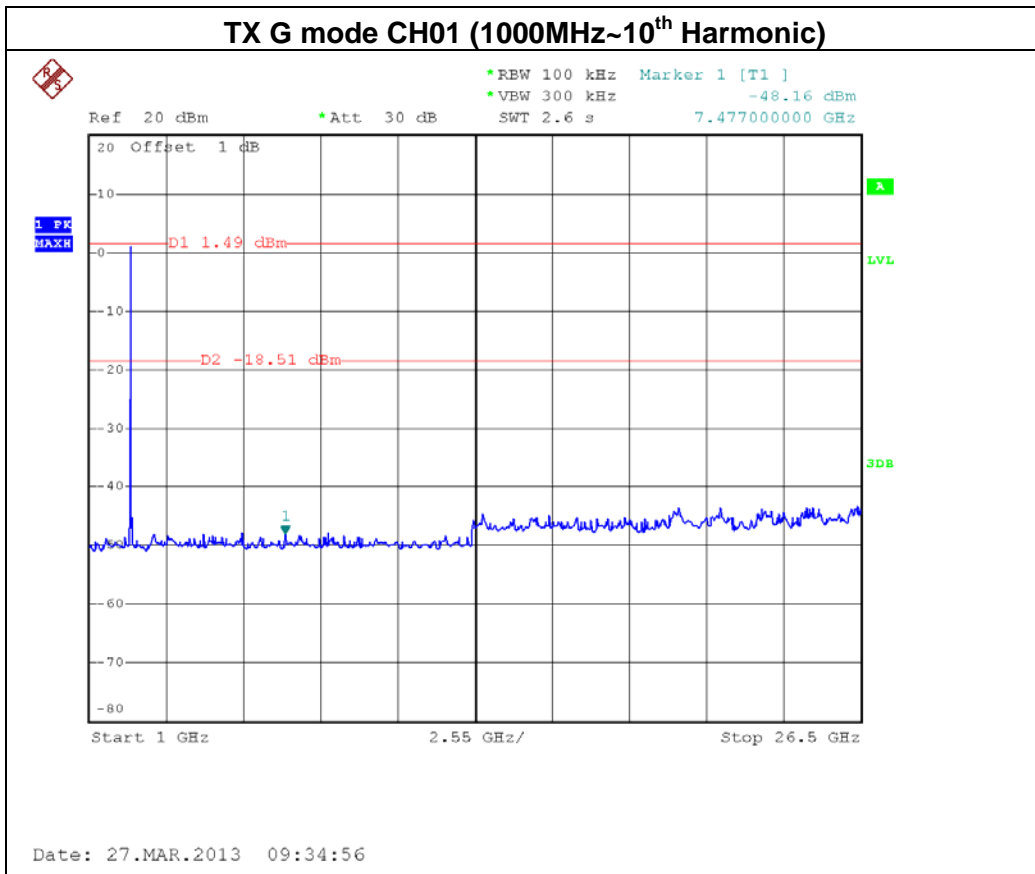
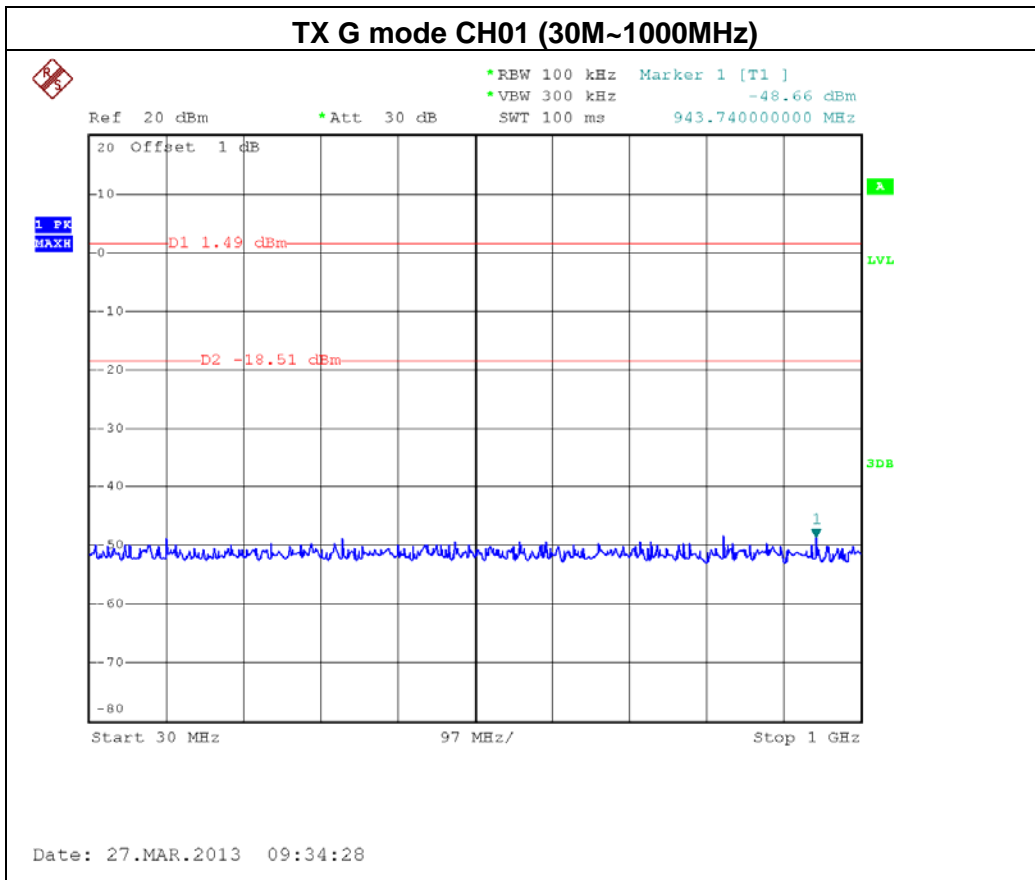

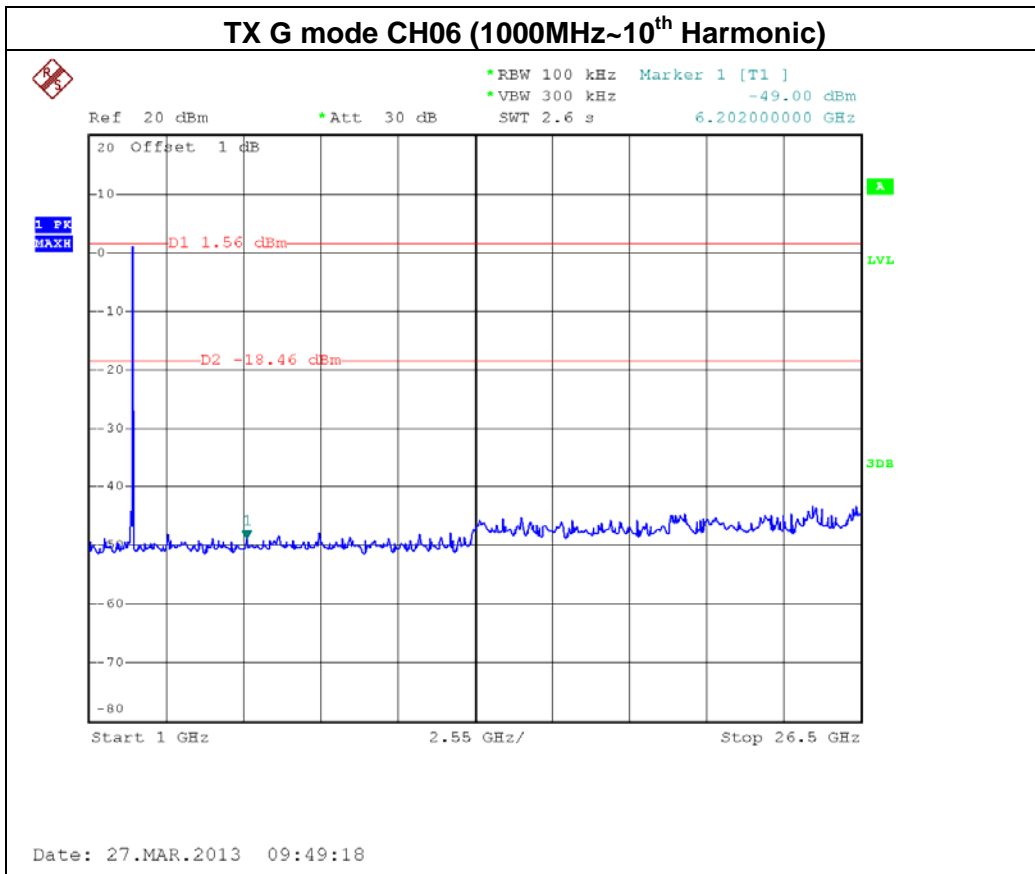
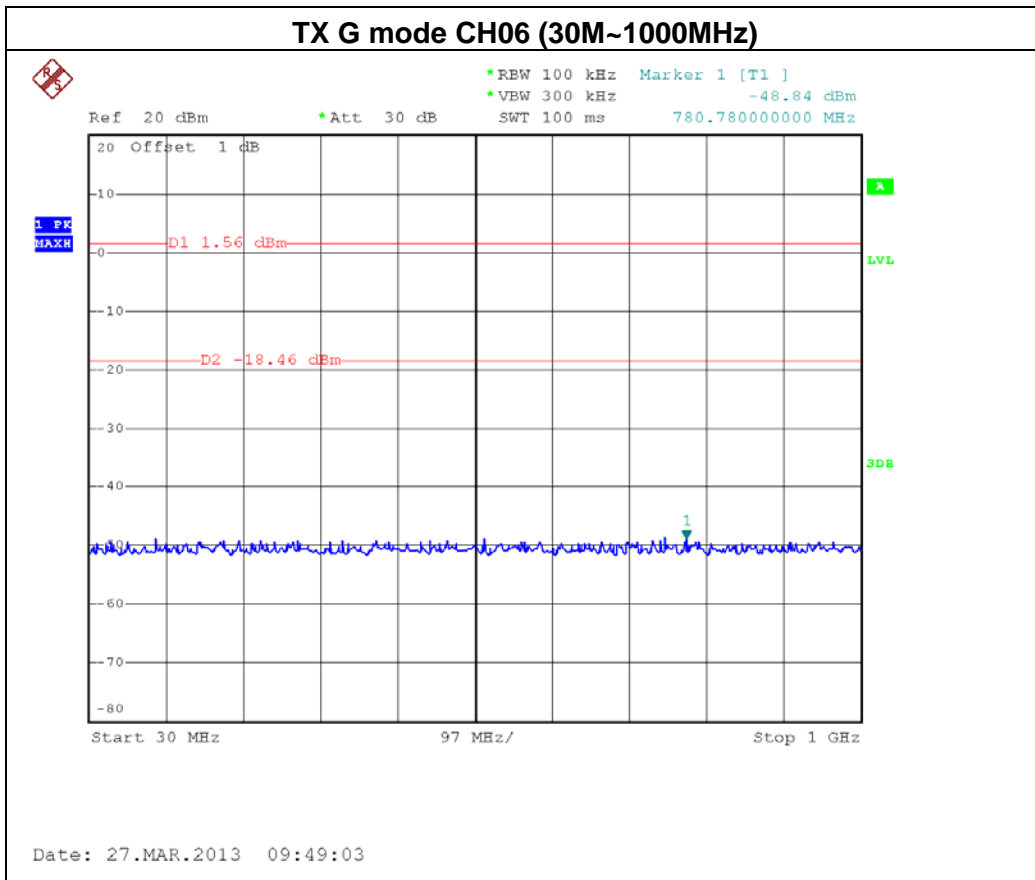

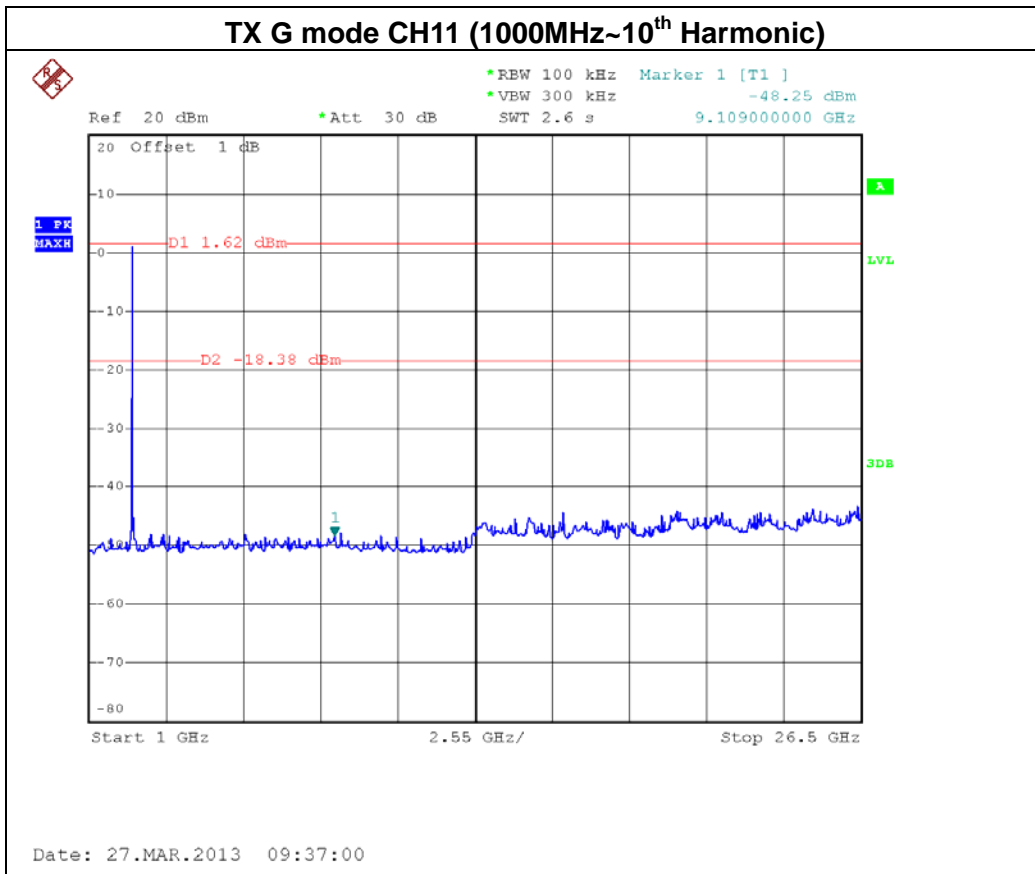
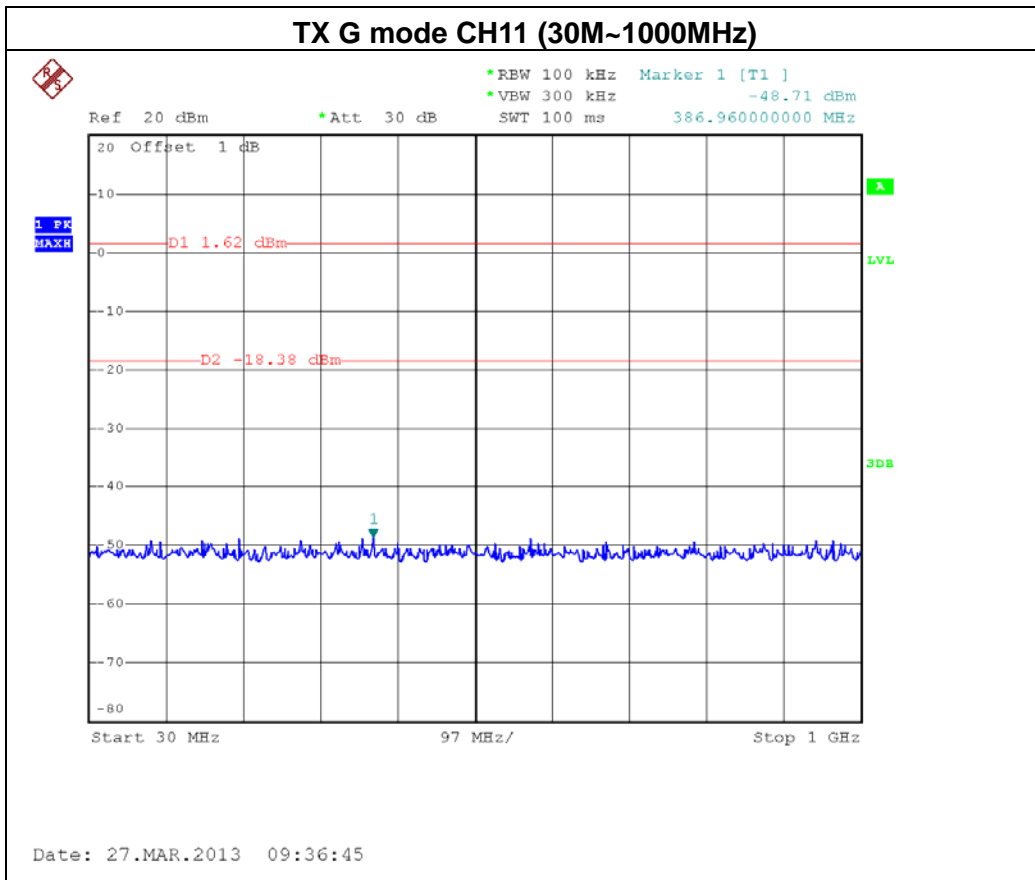



EUT :	Wireless VDSL2 4-port Ethernet Router	Model Name :	DSL-6740B
Temperature :	24 °C	Relative Humidity :	60 %
Pressure :	1016 hPa	Test Voltage :	AC 120V/60Hz
Test Mode :	TX N-20M MODE / CH01, CH06 , CH11-ANT 1		

Channel of Worst Data: CH01			
The max. radio frequency power in any 100kHz bandwidth outside the frequency band		The max. radio frequency power in any 100 kHz bandwidth within the frequency band.	
FREQUENCY(MHz)	POWER(dBm)	FREQUENCY(MHz)	POWER(dBm)
2400.00	-42.24	2485.20	-43.08
Result			
In any 100kHz bandwidth outside the frequency band, the radio frequency power is at least 20dB below that in the 100kHz bandwidth within the band that contains the highest level of the desired power.			

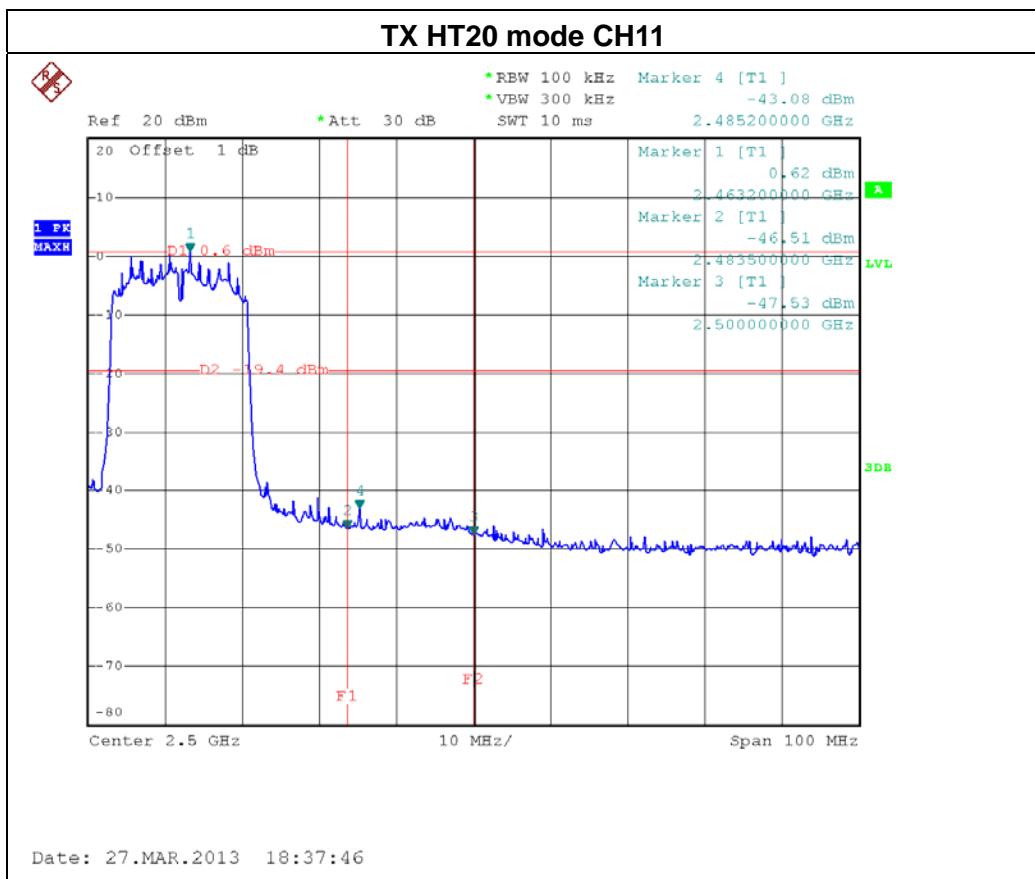
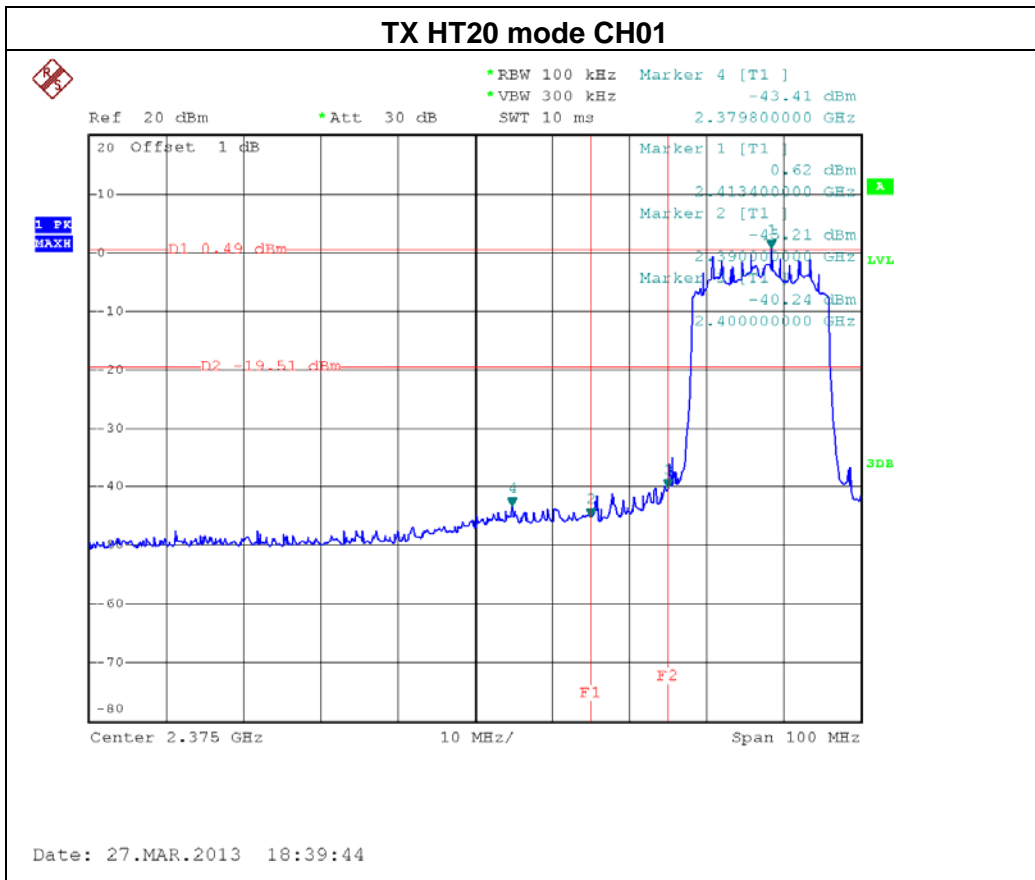

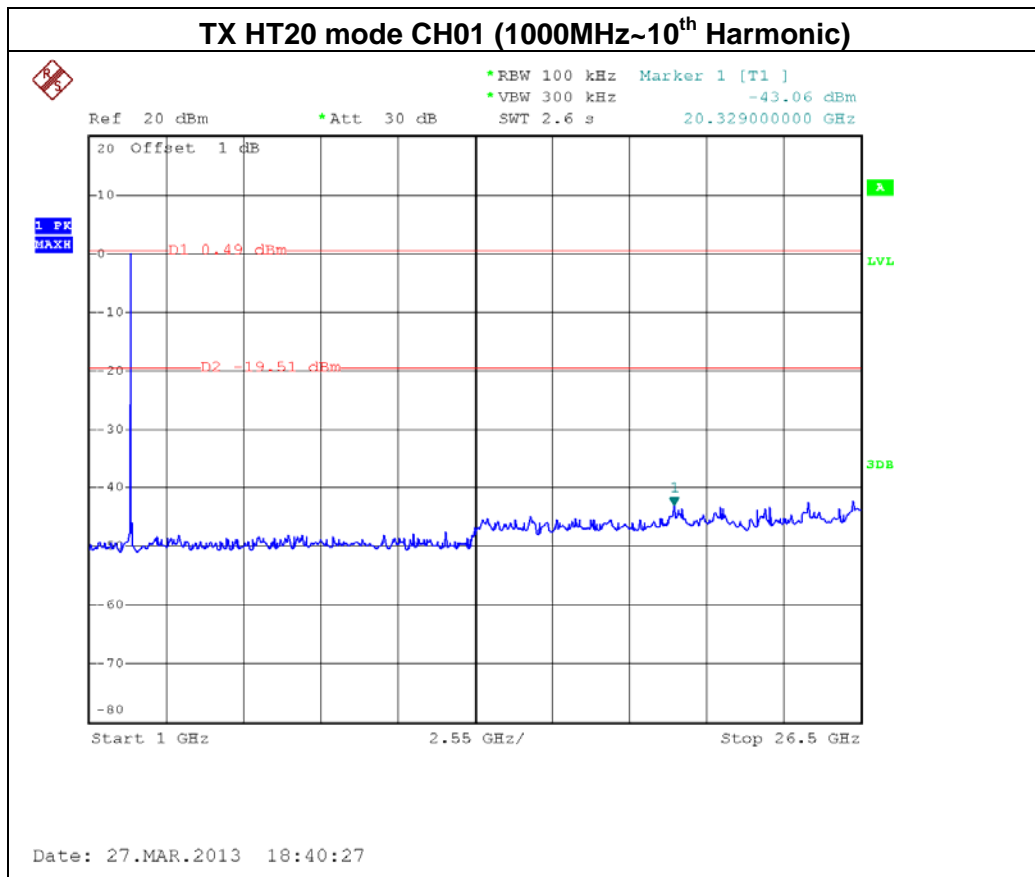
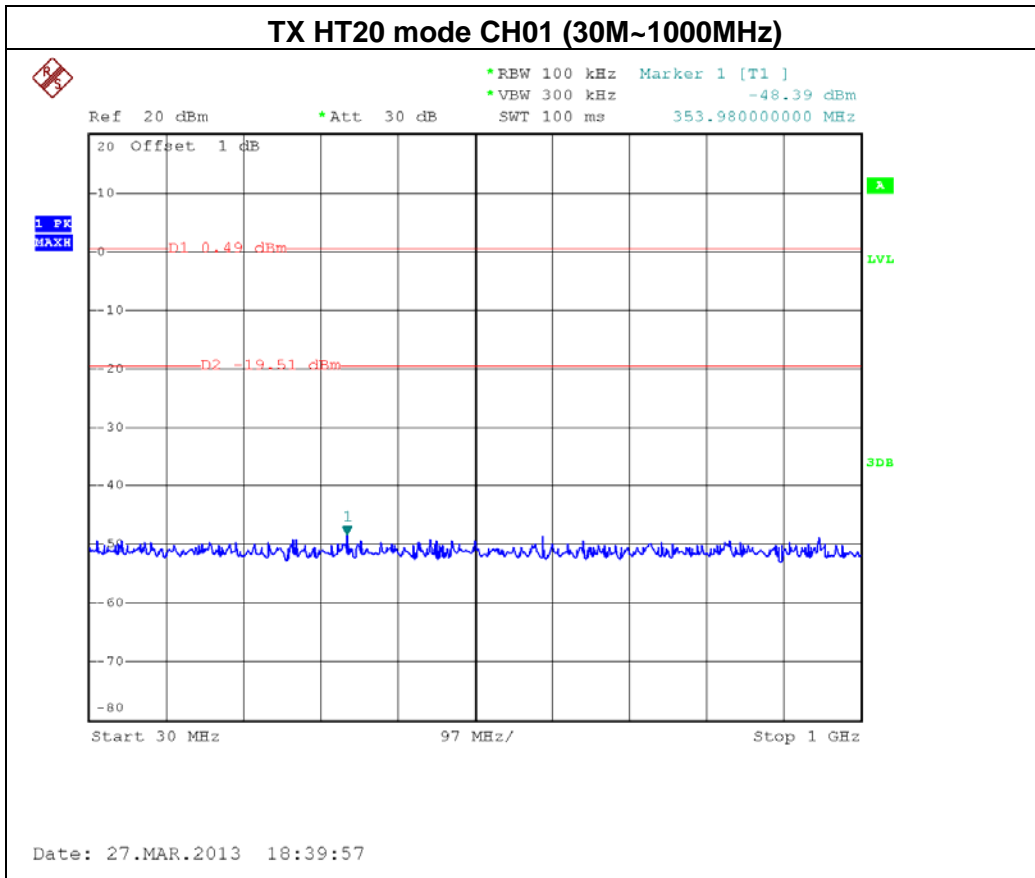

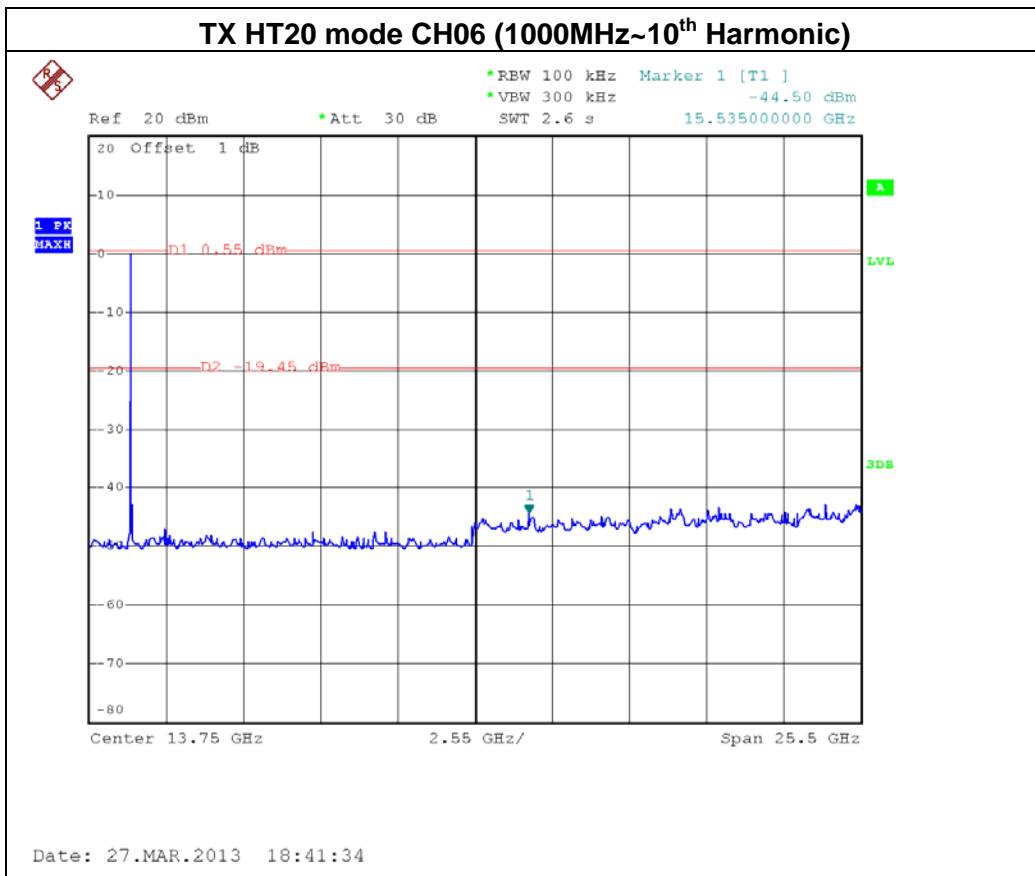
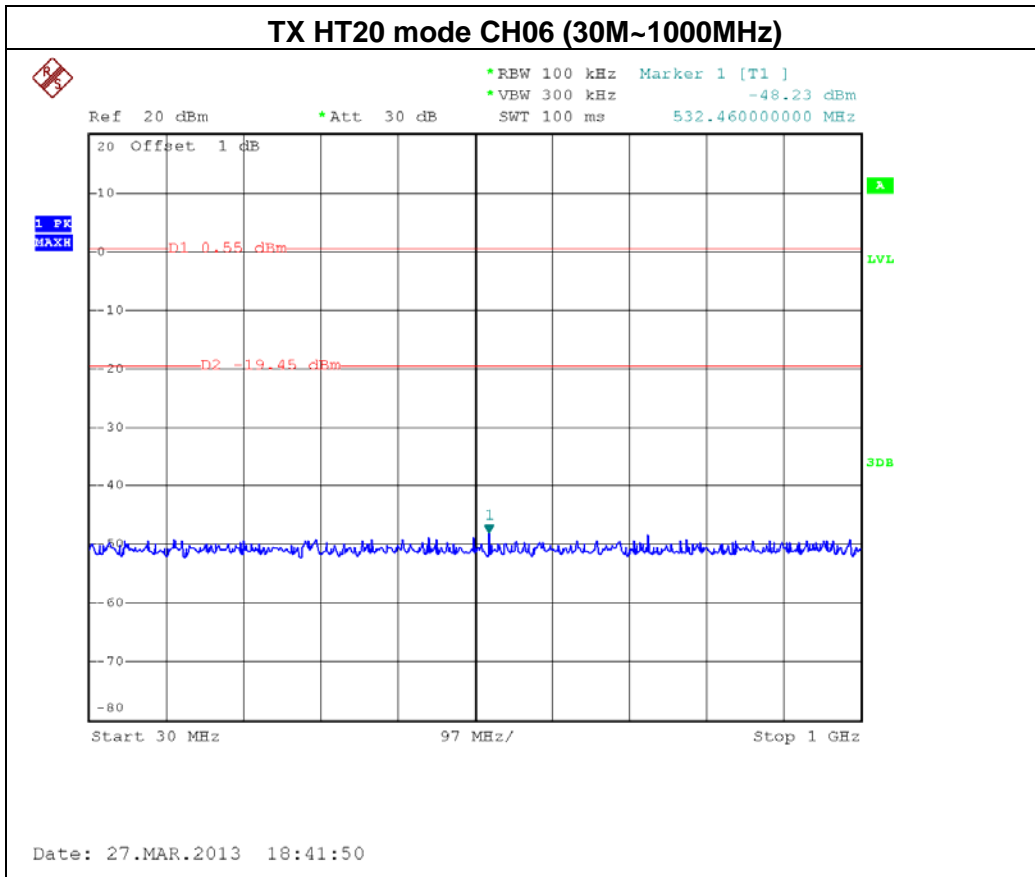

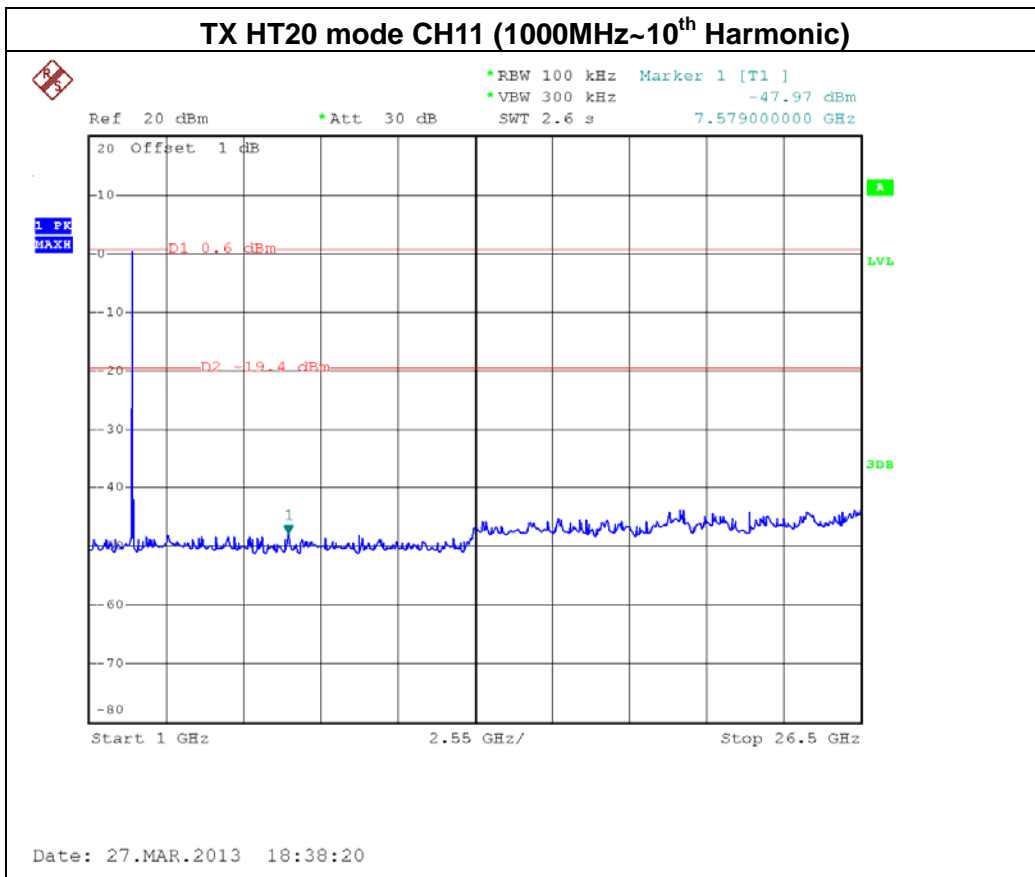
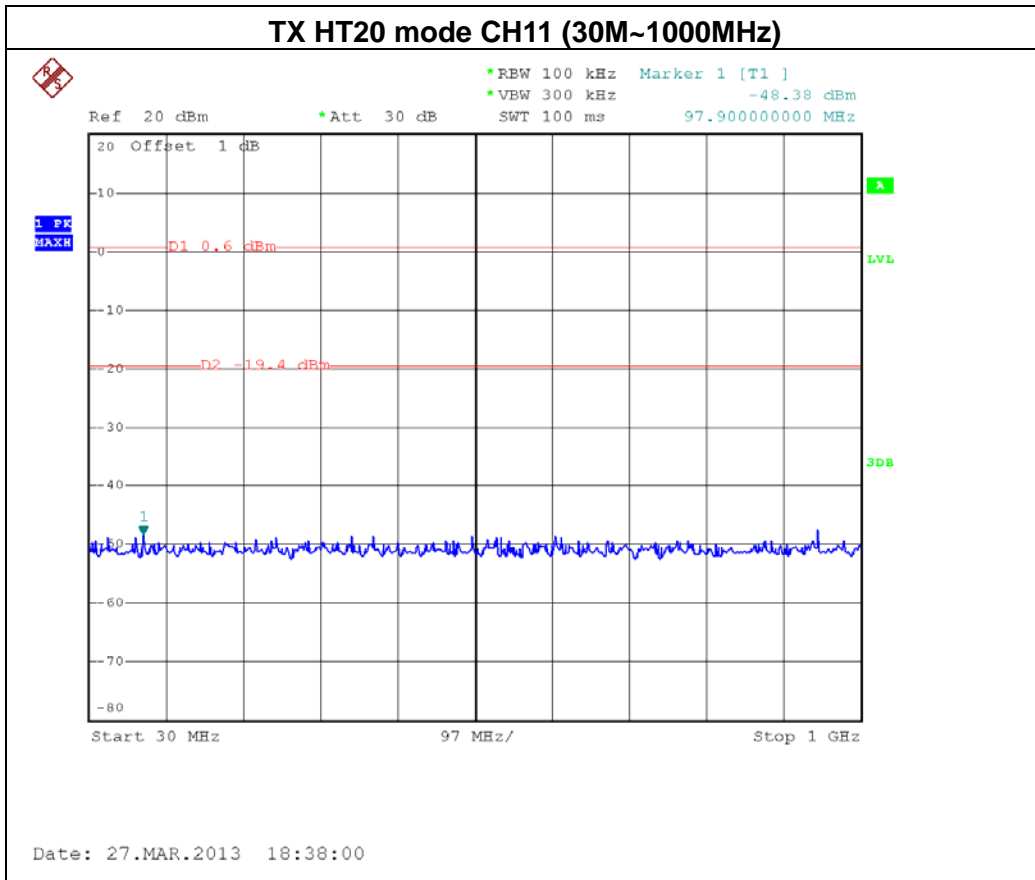



EUT :	Wireless VDSL2 4-port Ethernet Router	Model Name :	DSL-6740B
Temperature :	24 °C	Relative Humidity :	60 %
Pressure :	1016 hPa	Test Voltage :	AC 120V/60Hz
Test Mode :	TX N-20M MODE / CH01, CH06 , CH11-ANT 2		

Channel of Worst Data: CH01			
The max. radio frequency power in any 100kHz bandwidth outside the frequency band		The max. radio frequency power in any 100 kHz bandwidth within the frequency band.	
FREQUENCY(MHz)	POWER(dBm)	FREQUENCY(MHz)	POWER(dBm)
2400.00	-39.69	2483.5	-45.02
Result			
In any 100kHz bandwidth outside the frequency band, the radio frequency power is at least 20dB below that in the 100kHz bandwidth within the band that contains the highest level of the desired power.			

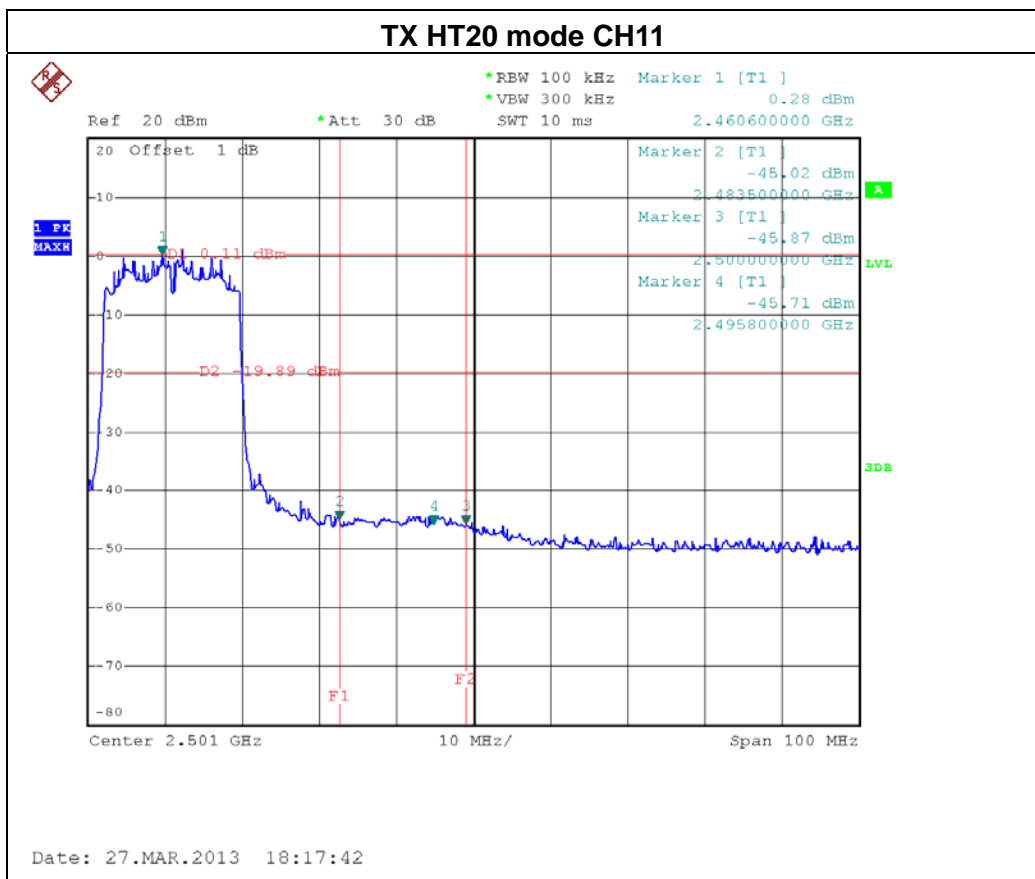
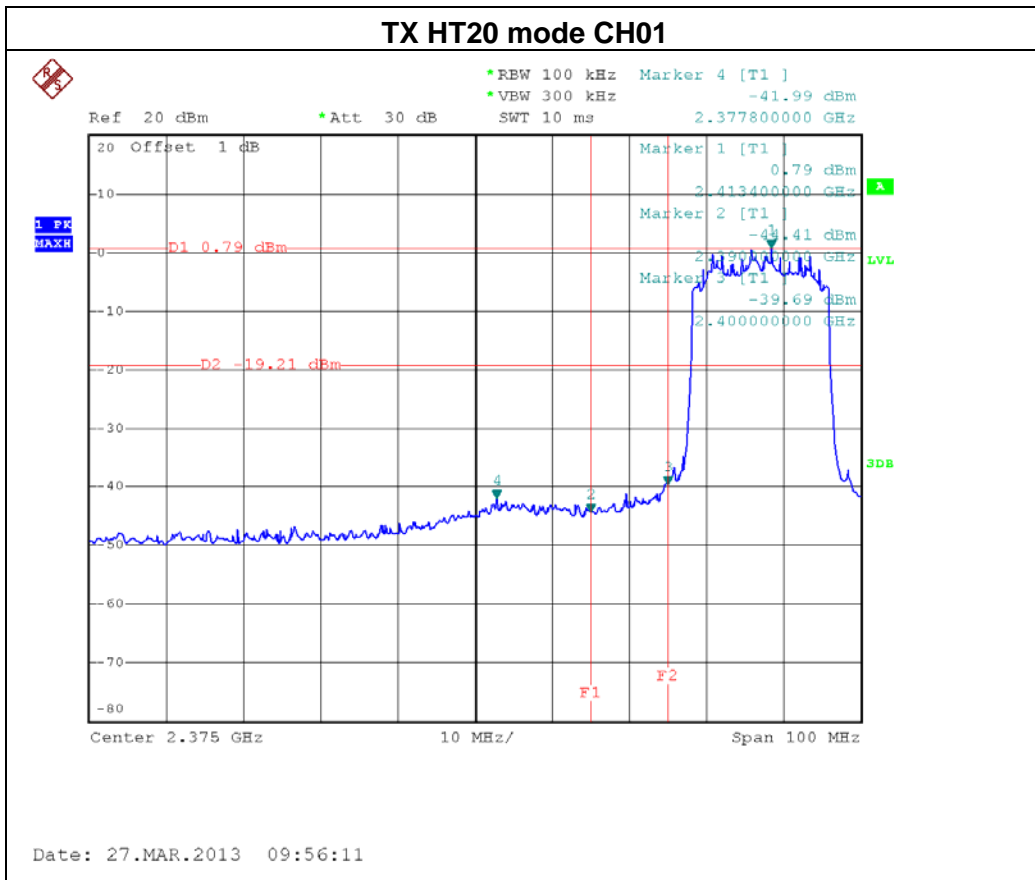

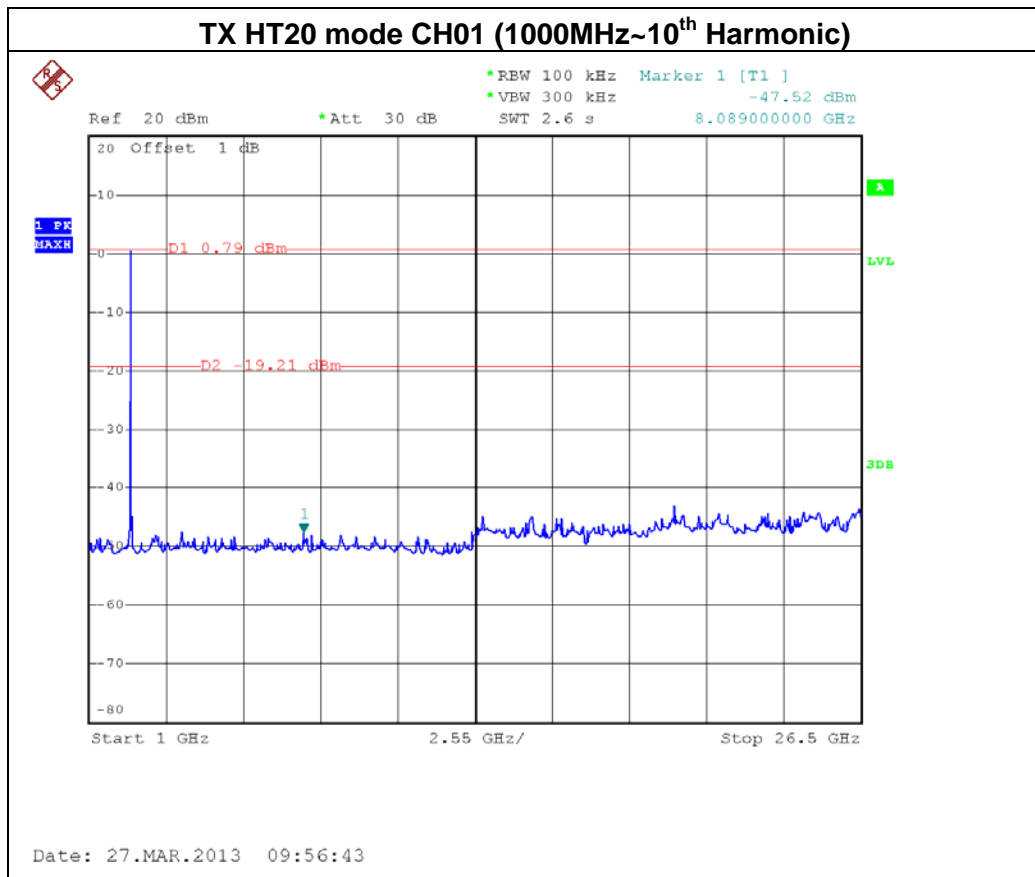
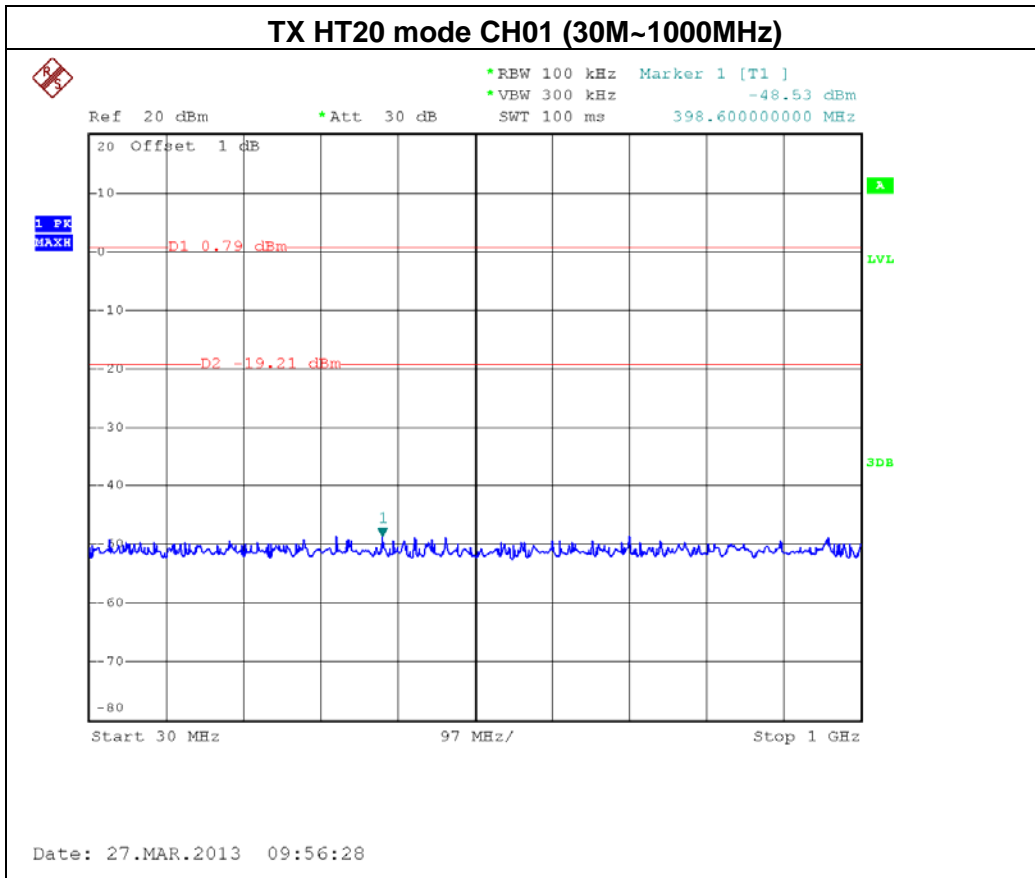

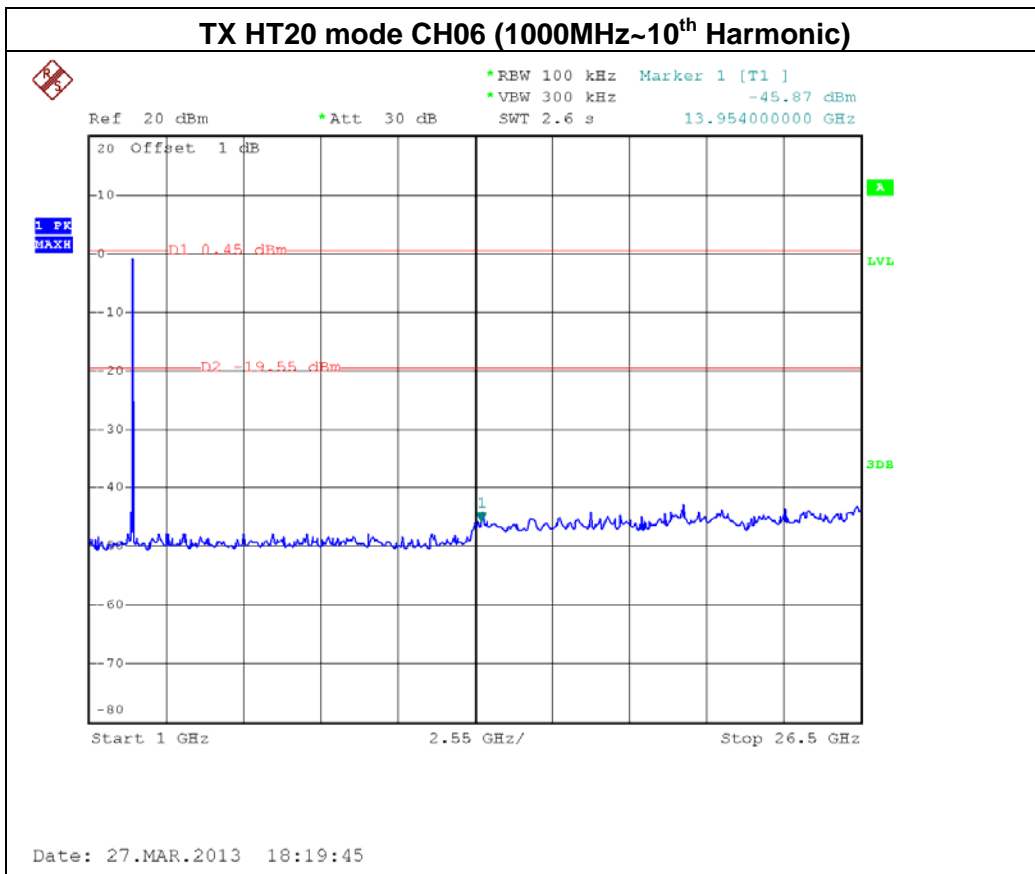
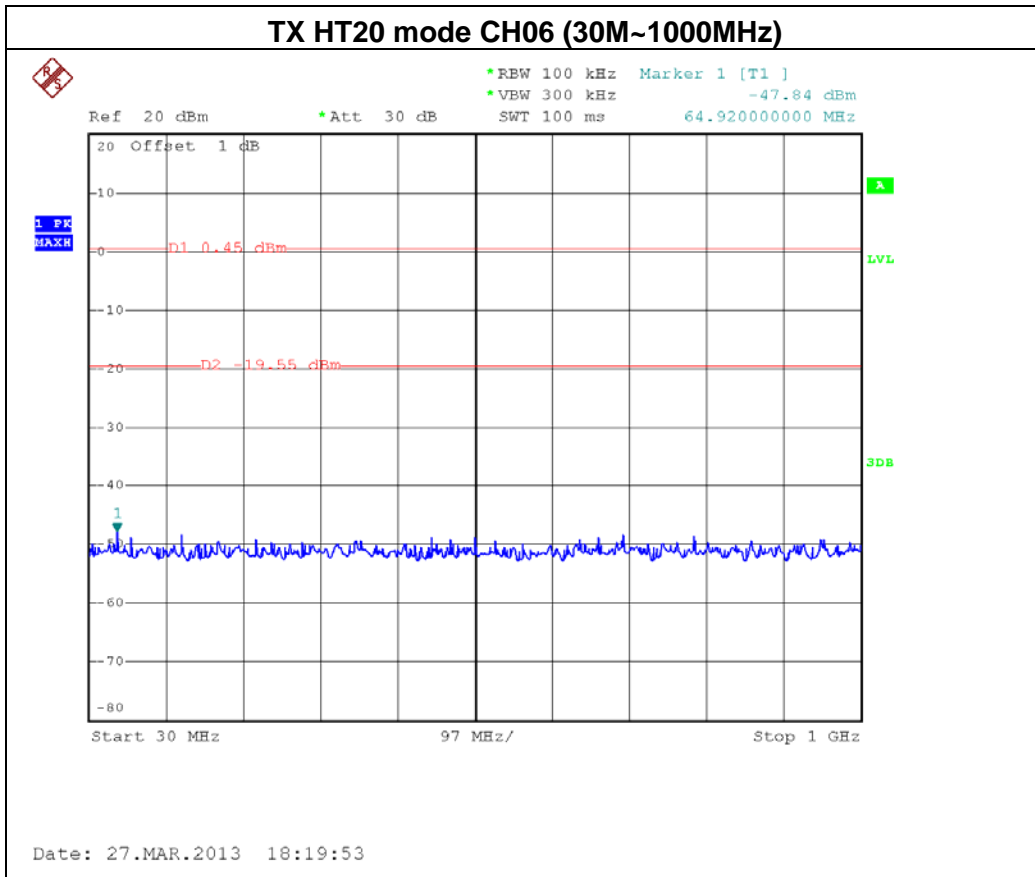

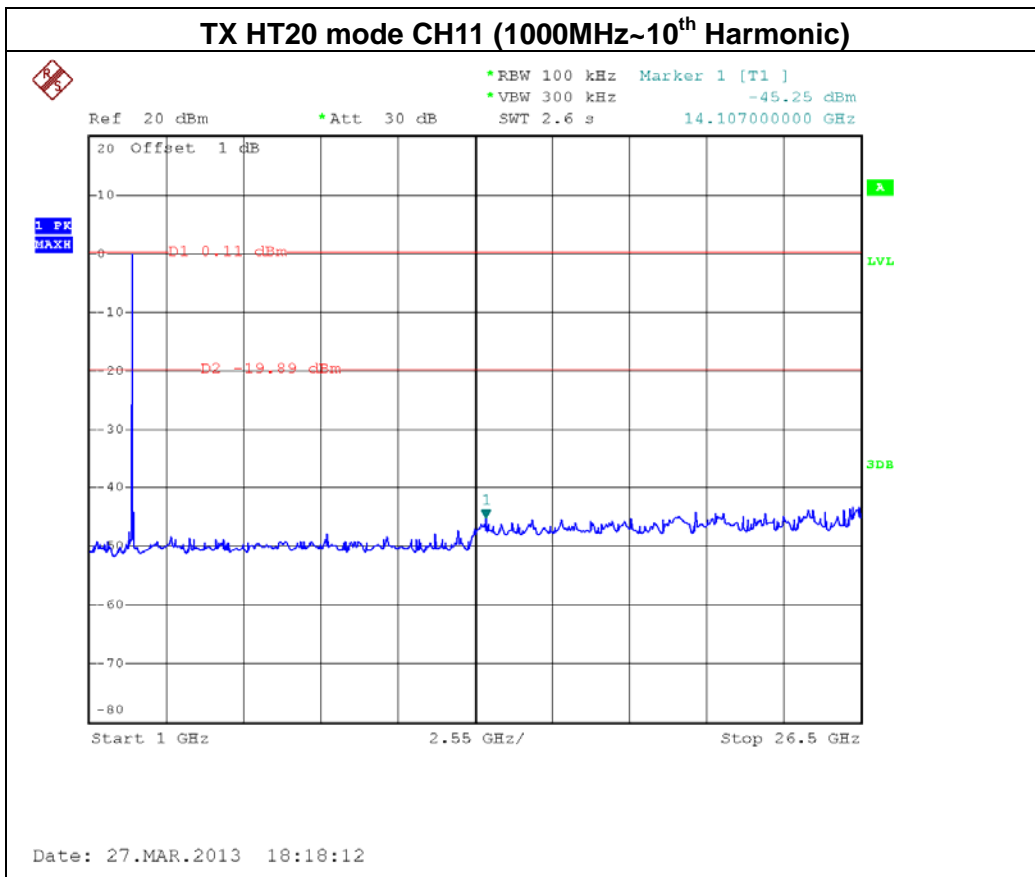
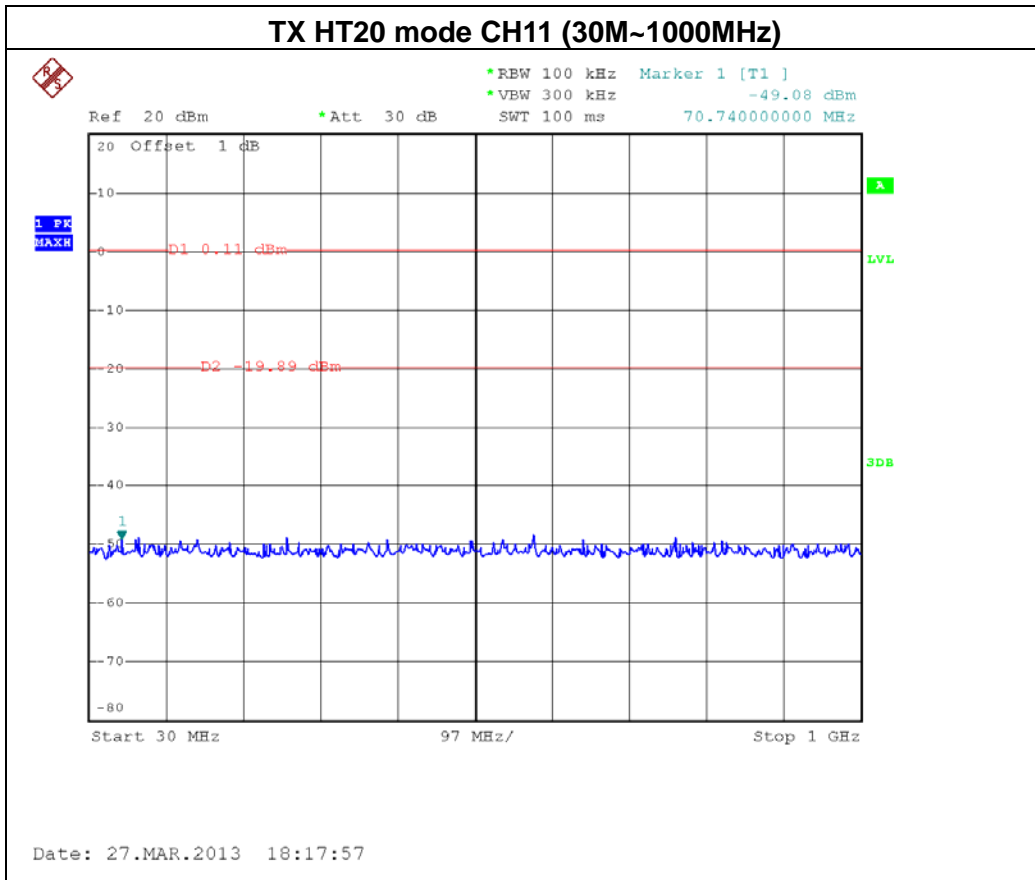



EUT :	Wireless VDSL2 4-port Ethernet Router	Model Name :	DSL-6740B
Temperature :	24 °C	Relative Humidity :	60 %
Pressure :	1016 hPa	Test Voltage :	AC 120V/60Hz
Test Mode :	TX N-40M MODE / CH03, CH06 , CH09-ANT 1		

Channel of Worst Data: CH03			
The max. radio frequency power in any 100kHz bandwidth outside the frequency band		The max. radio frequency power in any 100 kHz bandwidth within the frequency band.	
FREQUENCY(MHz)	POWER(dBm)	FREQUENCY(MHz)	POWER(dBm)
2400.00	-33.15	2483.50	-44.56
Result			
In any 100kHz bandwidth outside the frequency band, the radio frequency power is at least 20dB below that in the 100kHz bandwidth within the band that contains the highest level of the desired power.			

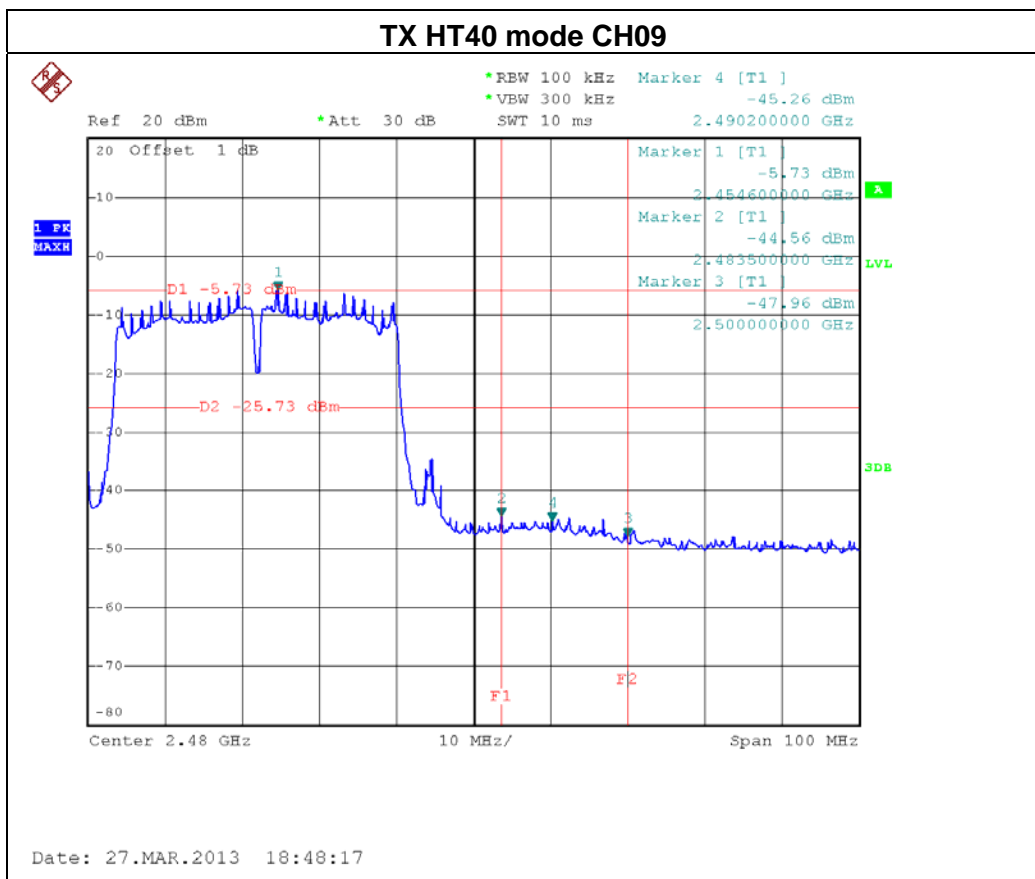
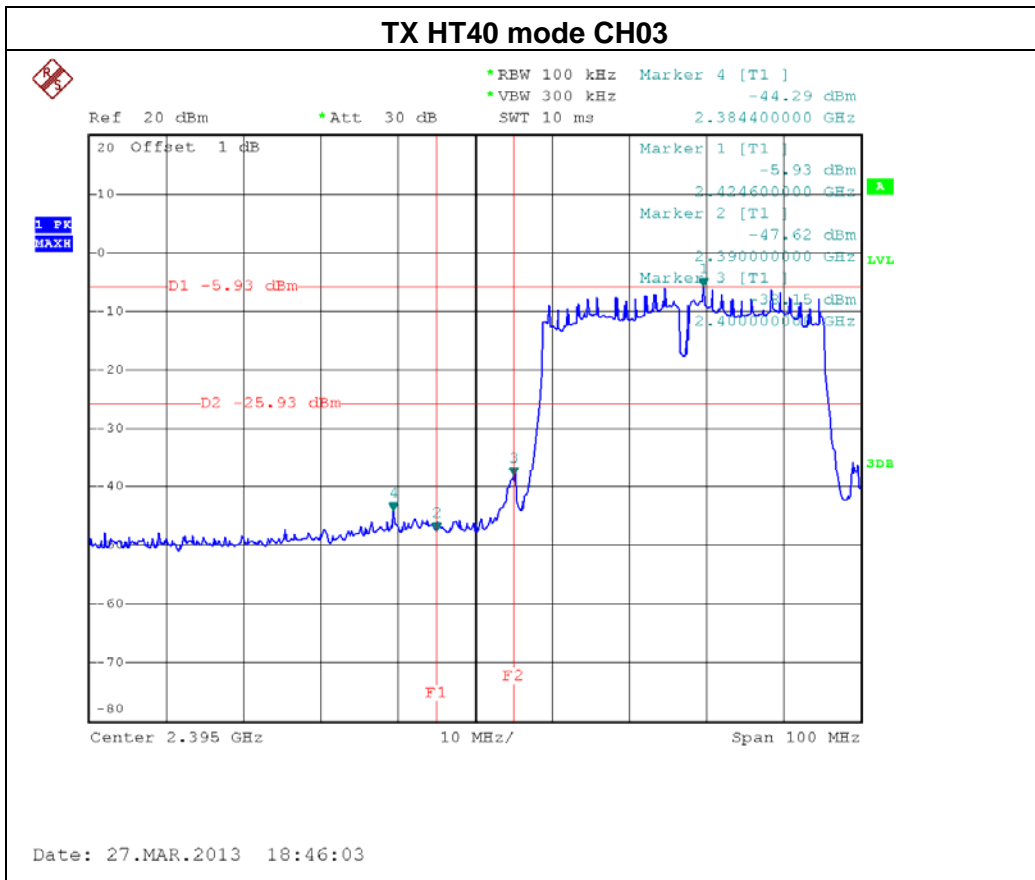

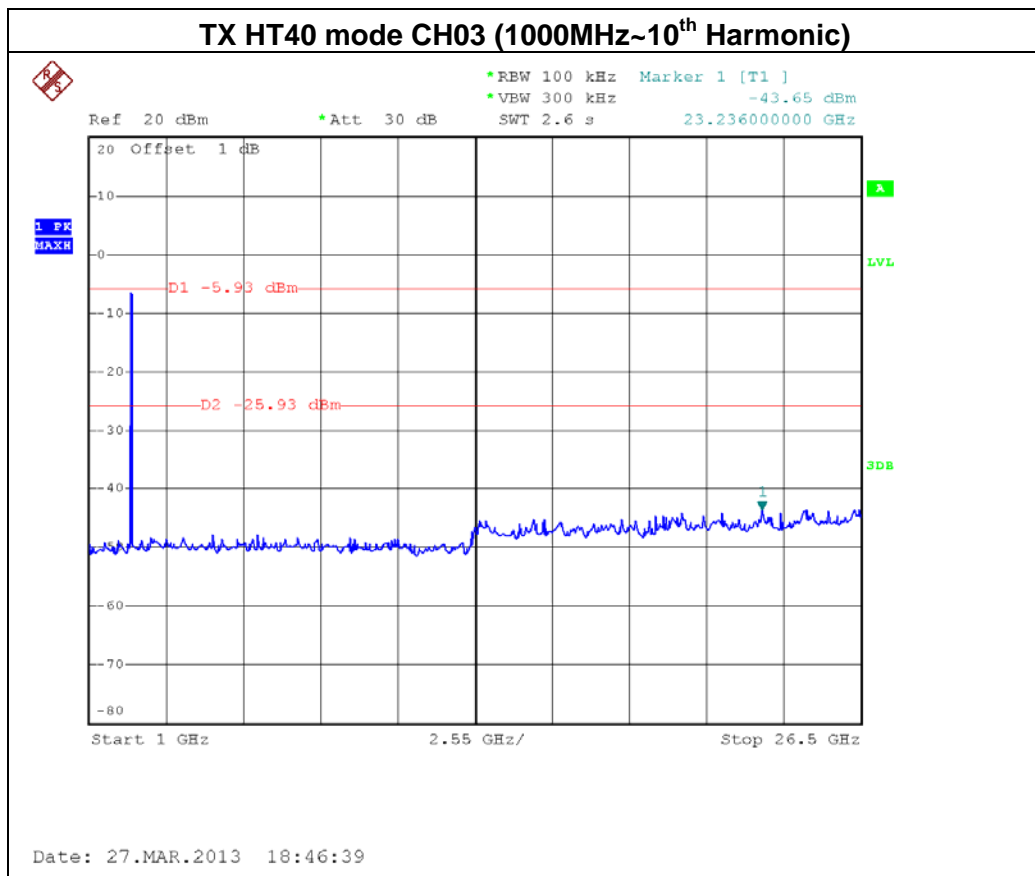
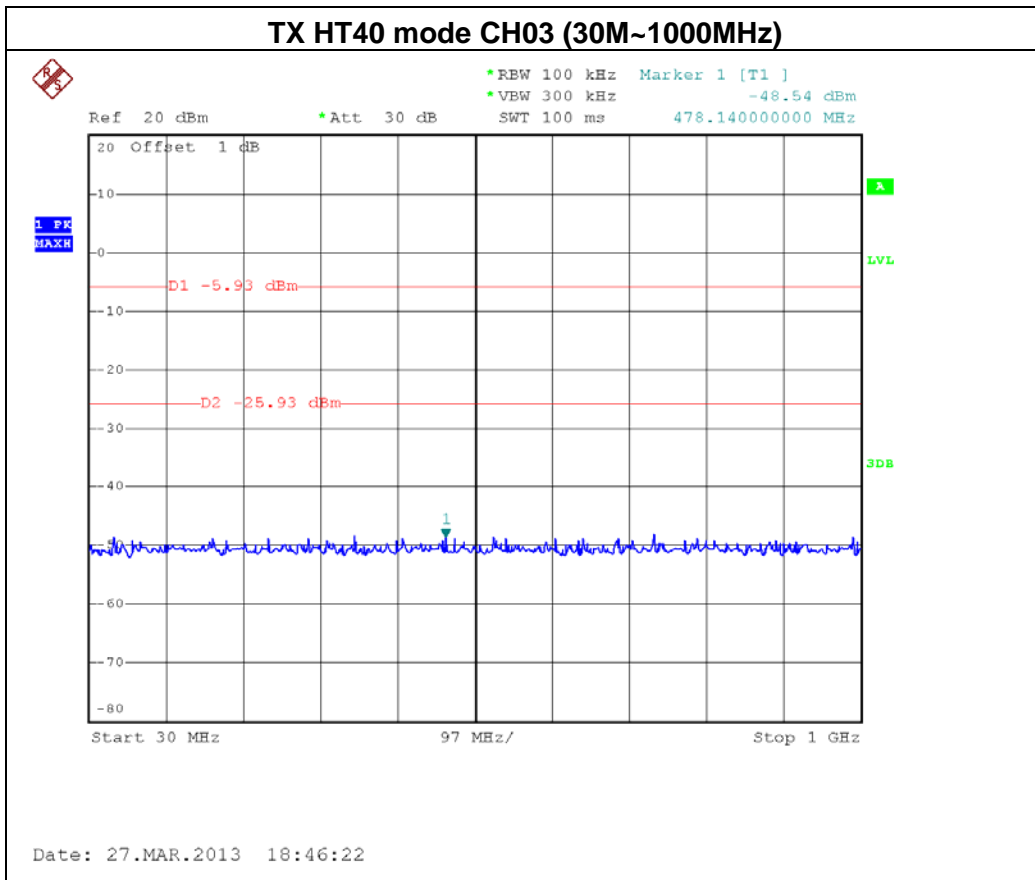

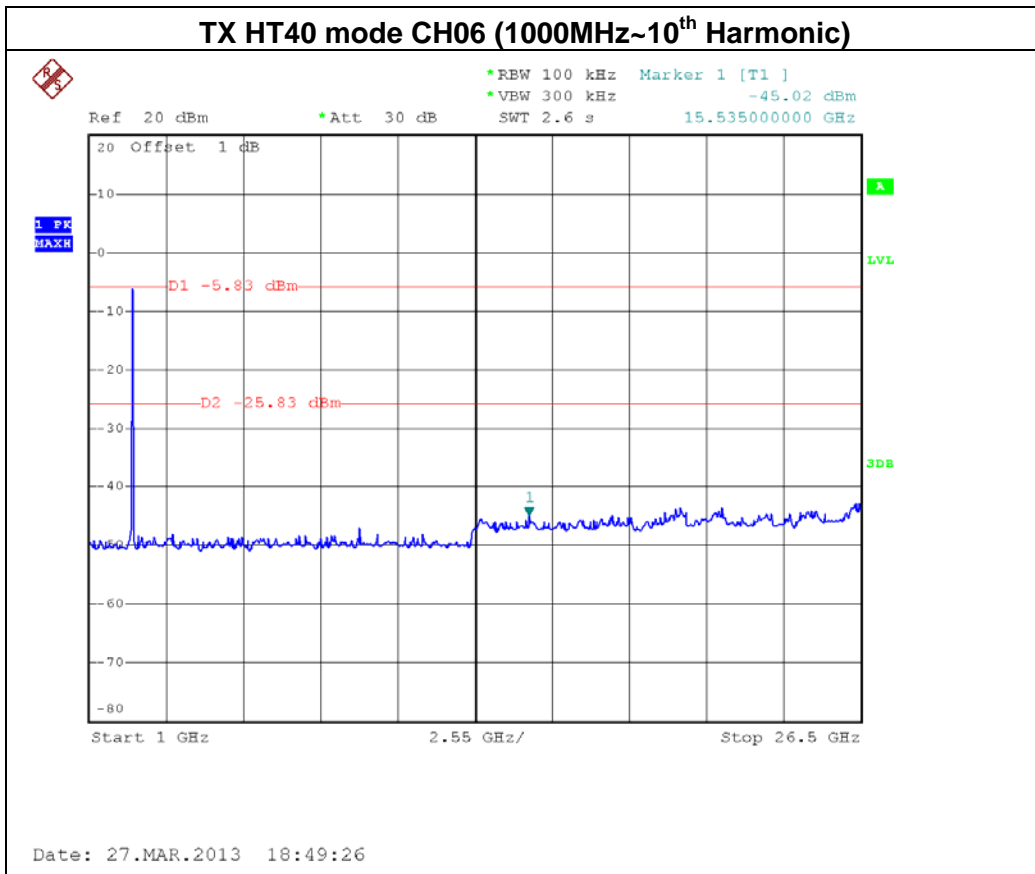
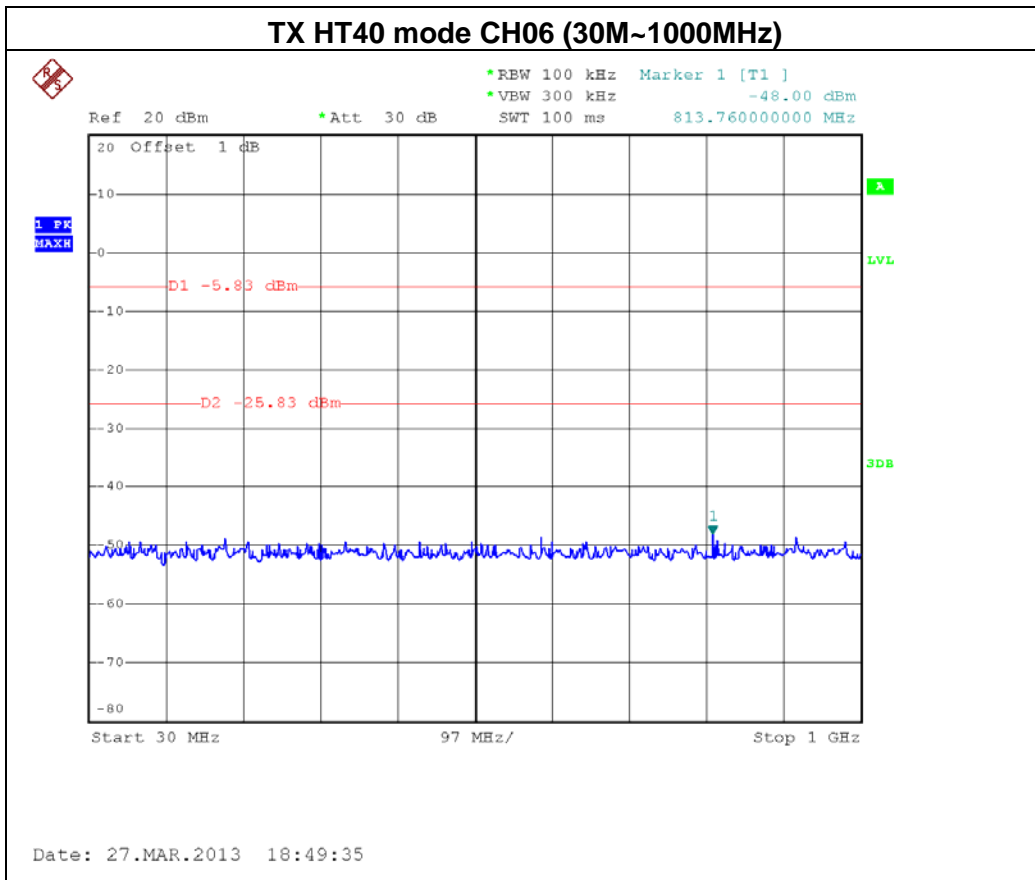

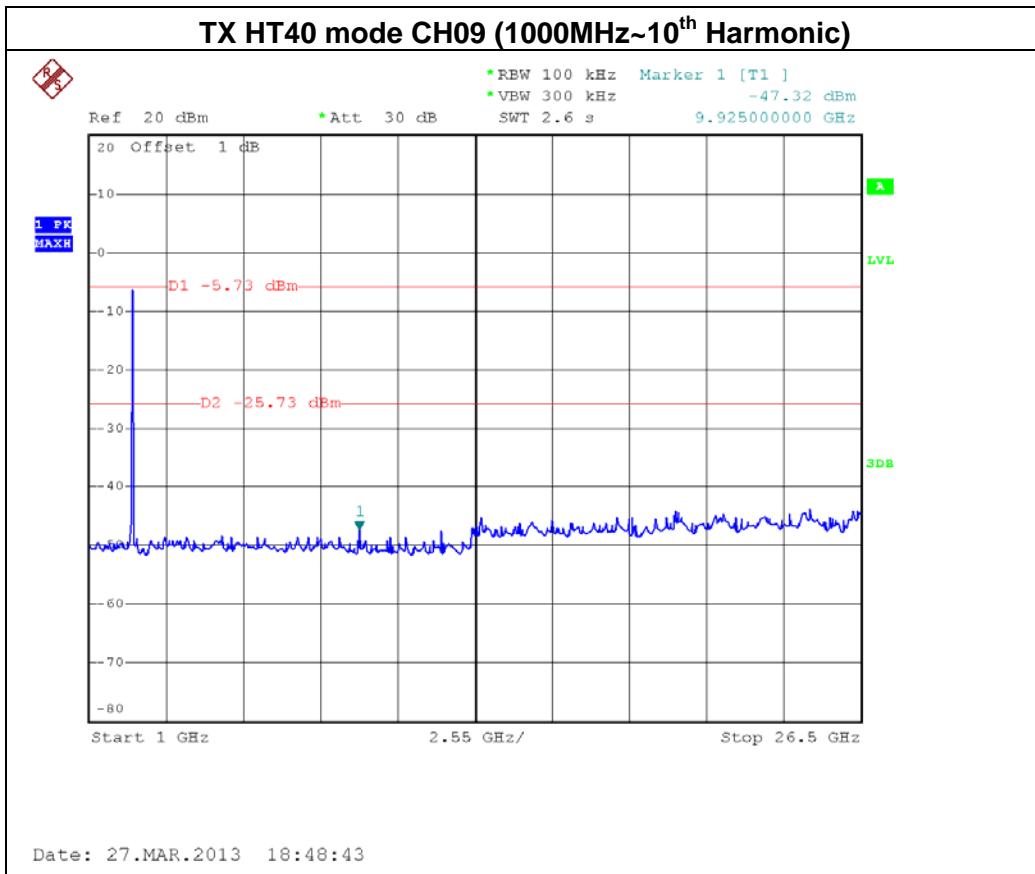
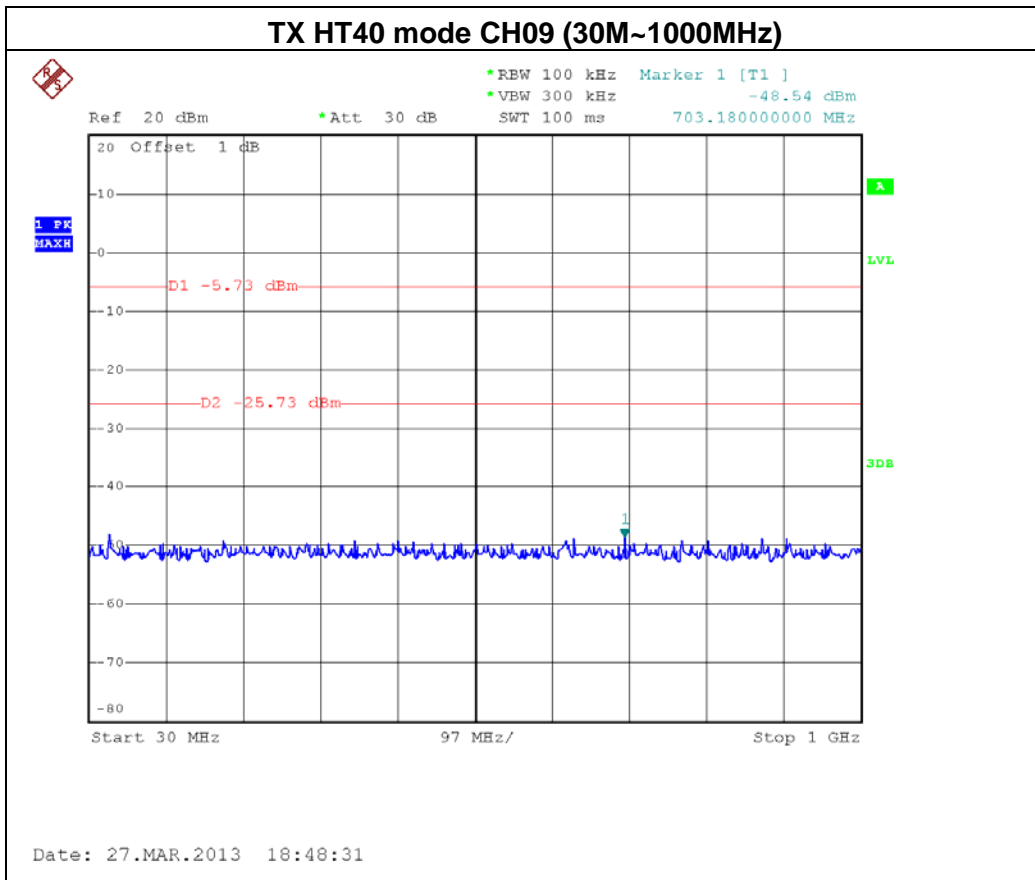



EUT :	Wireless VDSL2 4-port Ethernet Router	Model Name :	DSL-6740B
Temperature :	24 °C	Relative Humidity :	60 %
Pressure :	1016 hPa	Test Voltage :	AC 120V/60Hz
Test Mode :	TX N-40M MODE / CH03, CH06 , CH09-ANT 2		

Channel of Worst Data: CH03			
The max. radio frequency power in any 100kHz bandwidth outside the frequency band		The max. radio frequency power in any 100 kHz bandwidth within the frequency band.	
FREQUENCY(MHz)	POWER(dBm)	FREQUENCY(MHz)	POWER(dBm)
2400.00	-37.61	2491.00	-44.30
Result			
In any 100kHz bandwidth outside the frequency band, the radio frequency power is at least 20dB below that in the 100kHz bandwidth within the band that contains the highest level of the desired power.			

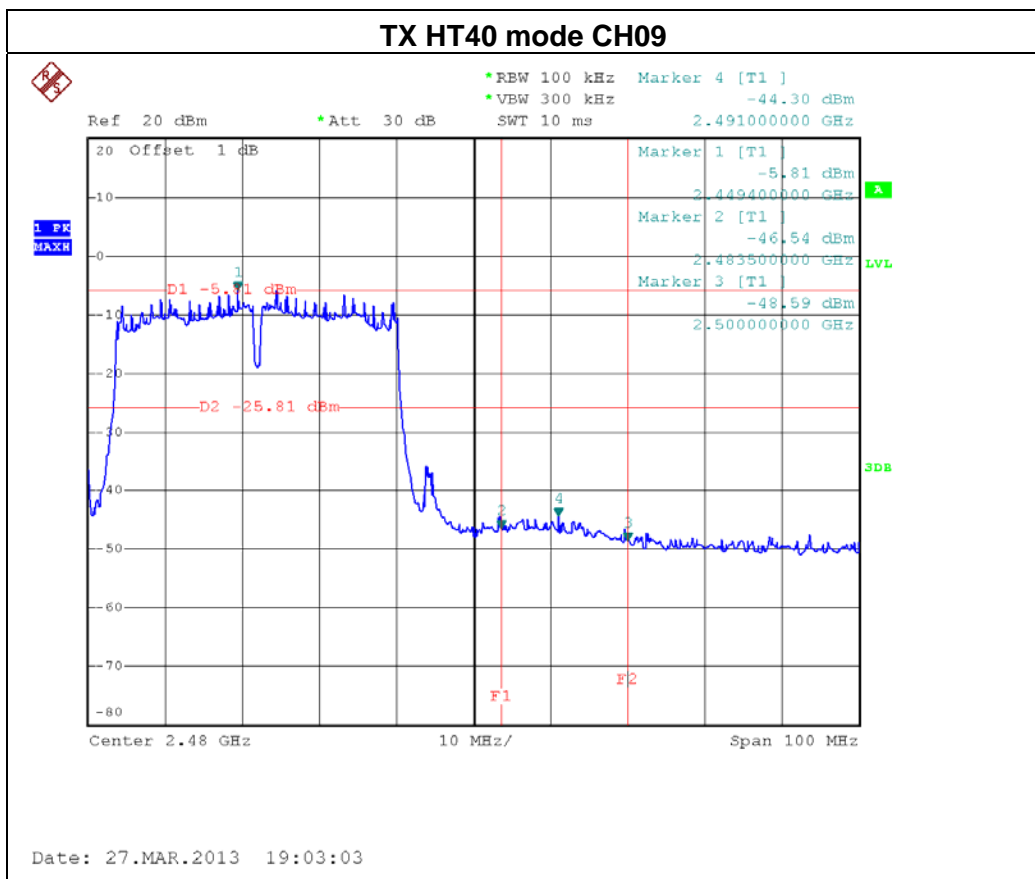
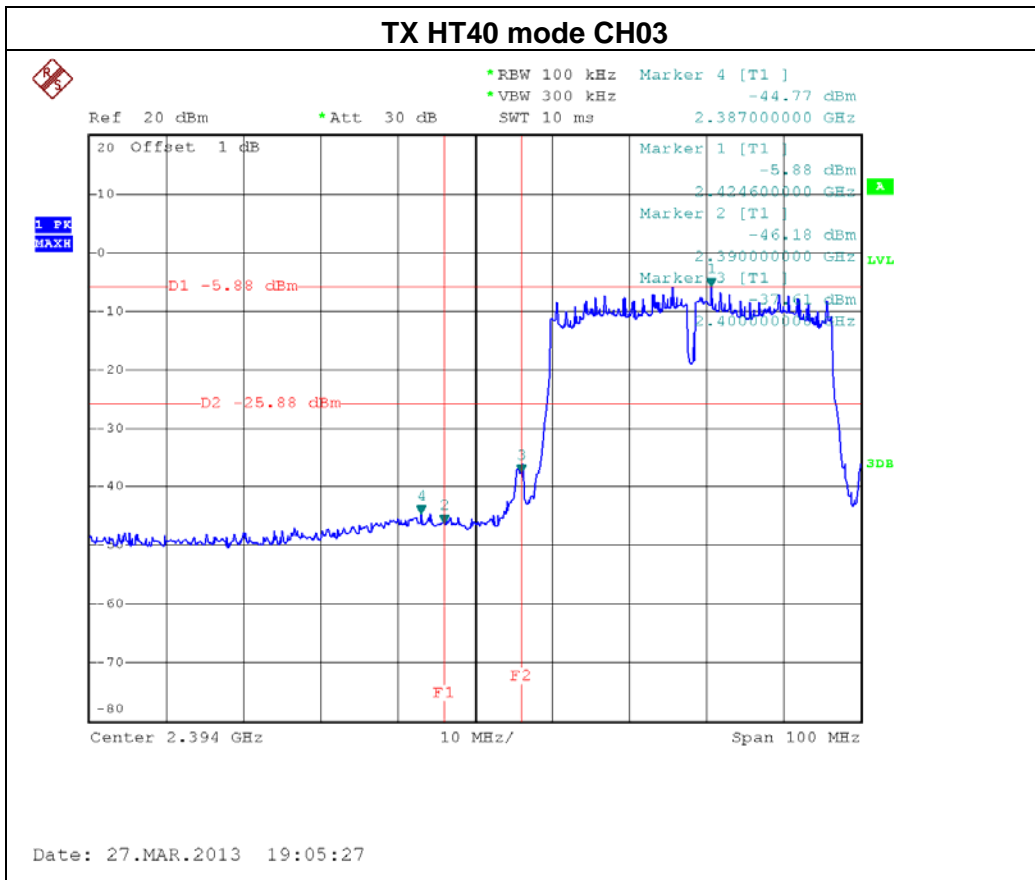

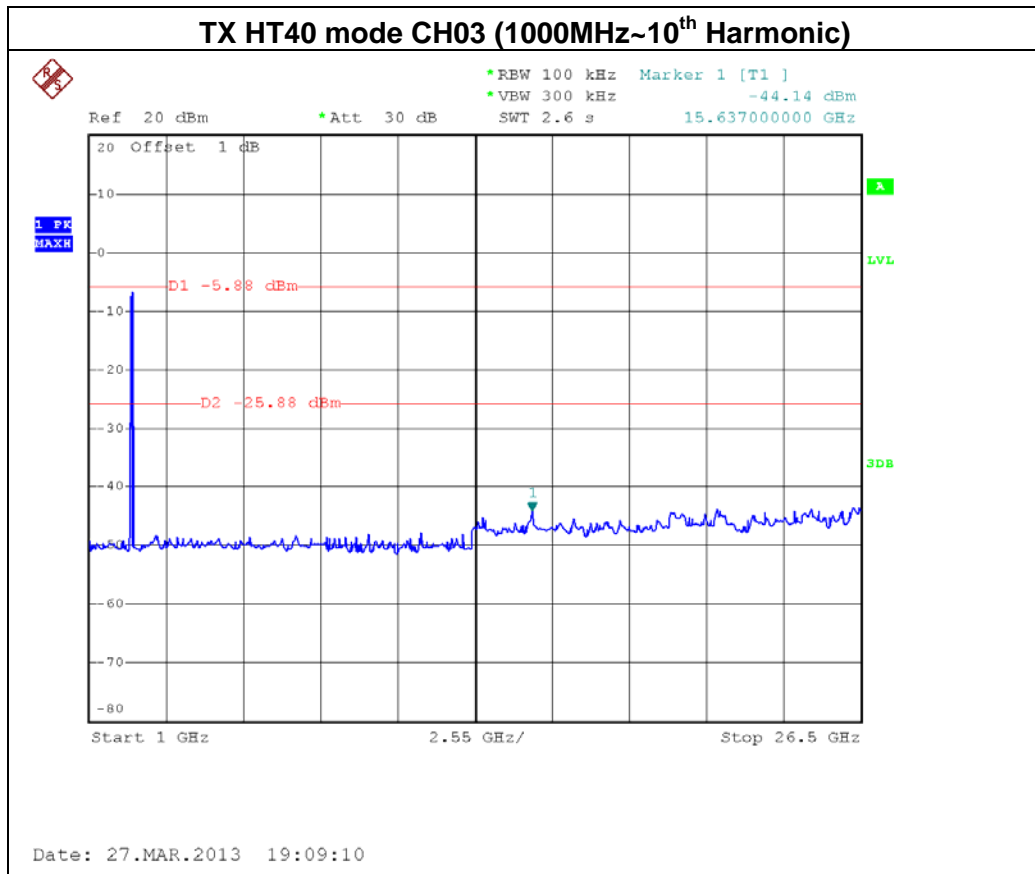
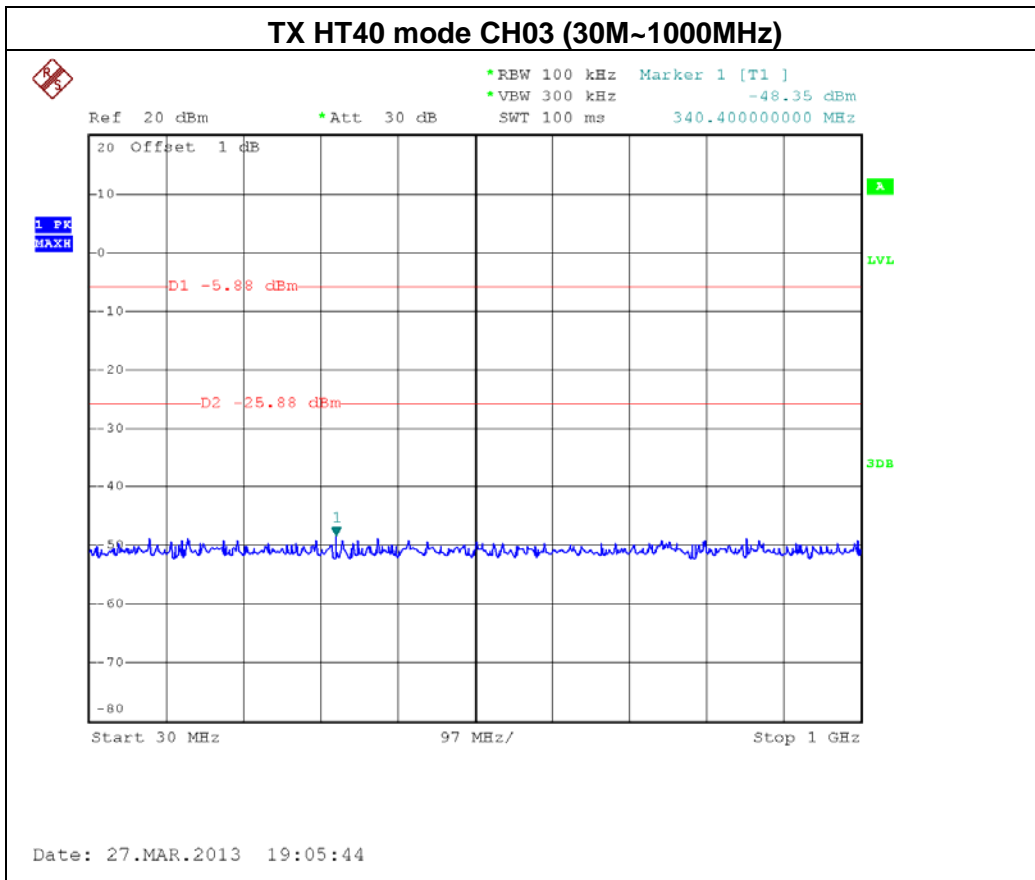

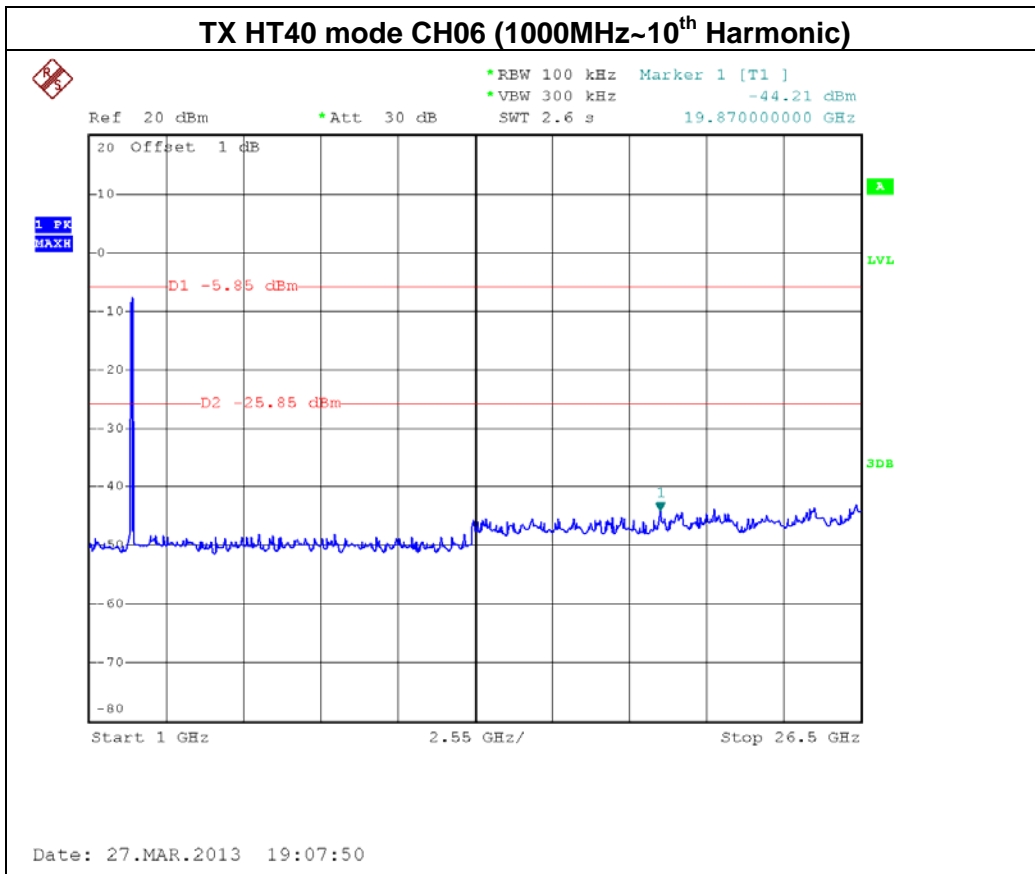
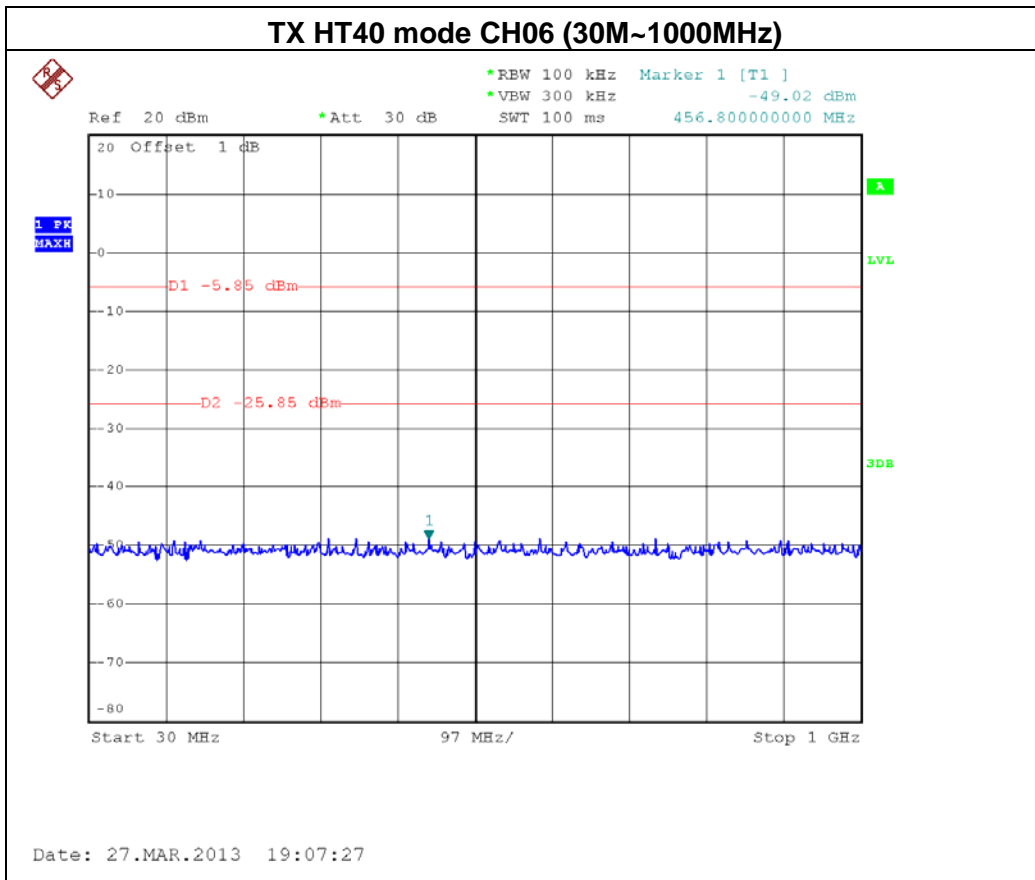

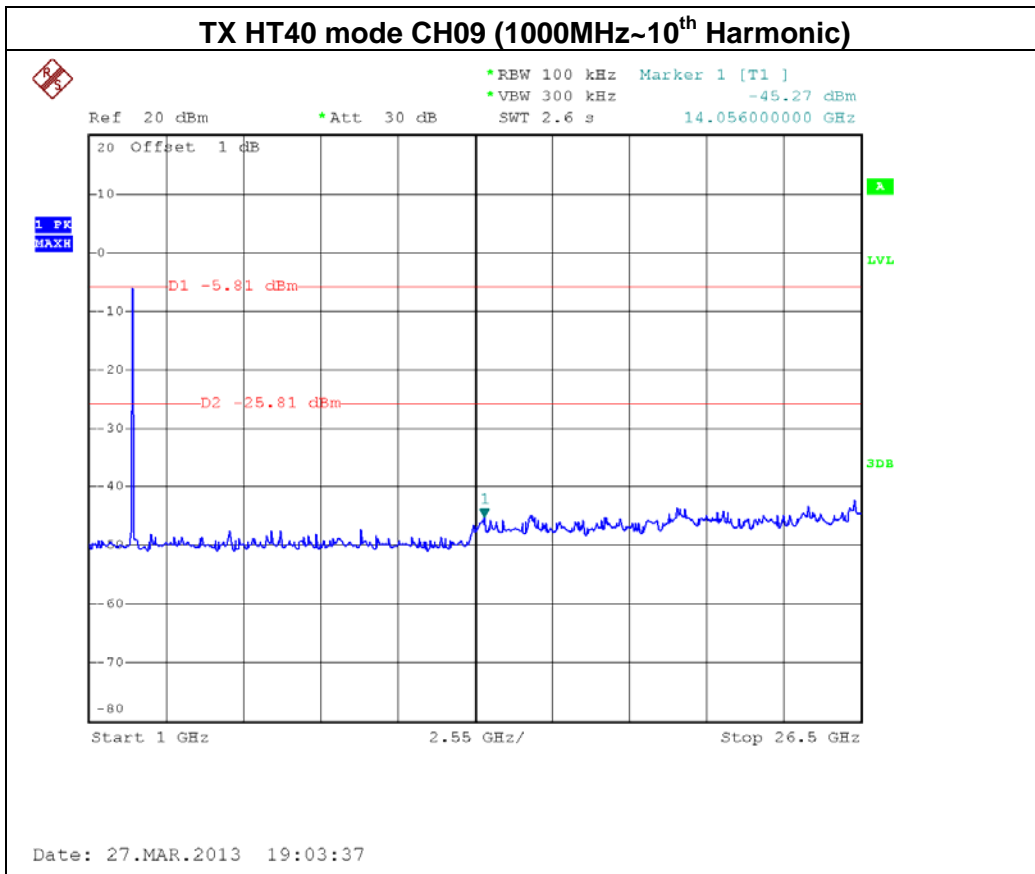
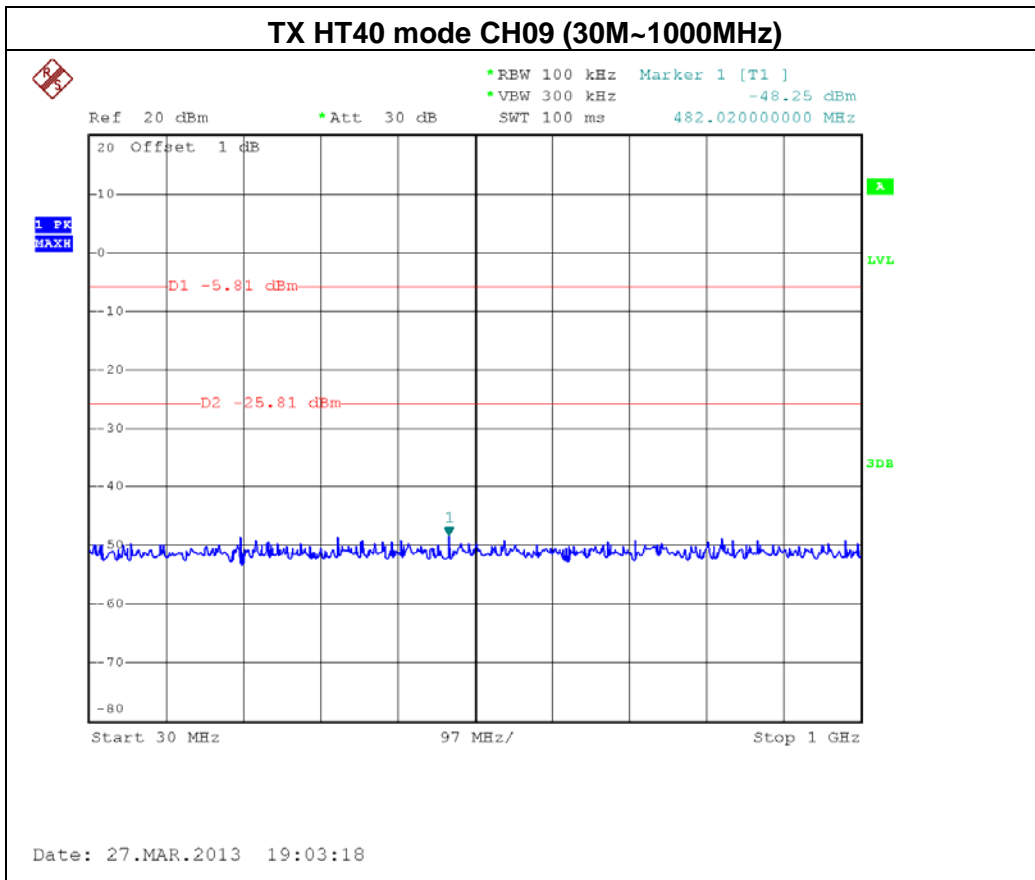



8. POWER SPECTRAL DENSITY TEST

8.1 Applied procedures / limit

FCC Part15 (15.247) , Subpart C				
Section	Test Item	Limit	Frequency Range (MHz)	Result
15.247(e)	Power Spectral Density	8 dBm (in any 3KHz)	2400-2483.5	PASS

8.1.1 MEASUREMENT INSTRUMENTS LIST

Item	Kind of Equipment	Manufacturer	Type No.	Serial No.	Last Calibration	Next Calibration
1	Spectrum Analyzer	R&S	FSP_40	100185	Nov.25.2012	Nov.16.2013

Remark: "N/A" denotes no model name, serial no. or calibration specified.

8.1.2 TEST PROCEDURE

- a. The EUT was directly connected to the spectrum analyzer and antenna output port as show in the block diagram below,
- b. Spectrum Setting : RBW=3KHz, VBW=10 KHz, Sweep time = 2.5ms.

8.1.3 DEVIATION FROM STANDARD

No deviation.

8.1.4 TEST SETUP

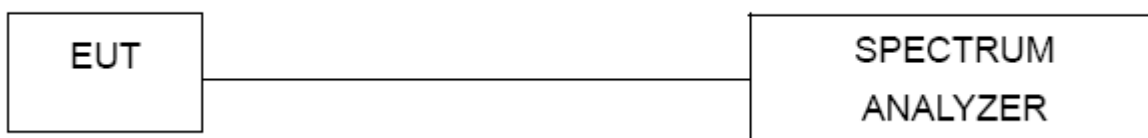

8.1.5 EUT OPERATION CONDITIONS

The EUT tested system was configured as the statements of 4.1.6 Unless otherwise a special operating condition is specified in the follows during the testing.



8.1.6 TEST RESULTS

EUT :	Wireless VDSL2 4-port Ethernet Router	Model Name :	DSL-6740B
Temperature :	24 °C	Relative Humidity :	60 %
Pressure :	1016 hPa	Test Voltage :	AC 120V/60Hz
Test Mode :	TX B MODE /CH01, CH06, CH11		

Test Channel	Frequency (MHz)	Power Density (dBm)	LIMIT (dBm)
CH01	2412 MHz	-4.24	8
CH06	2437 MHz	-3.98	8
CH11	2462 MHz	-3.34	8

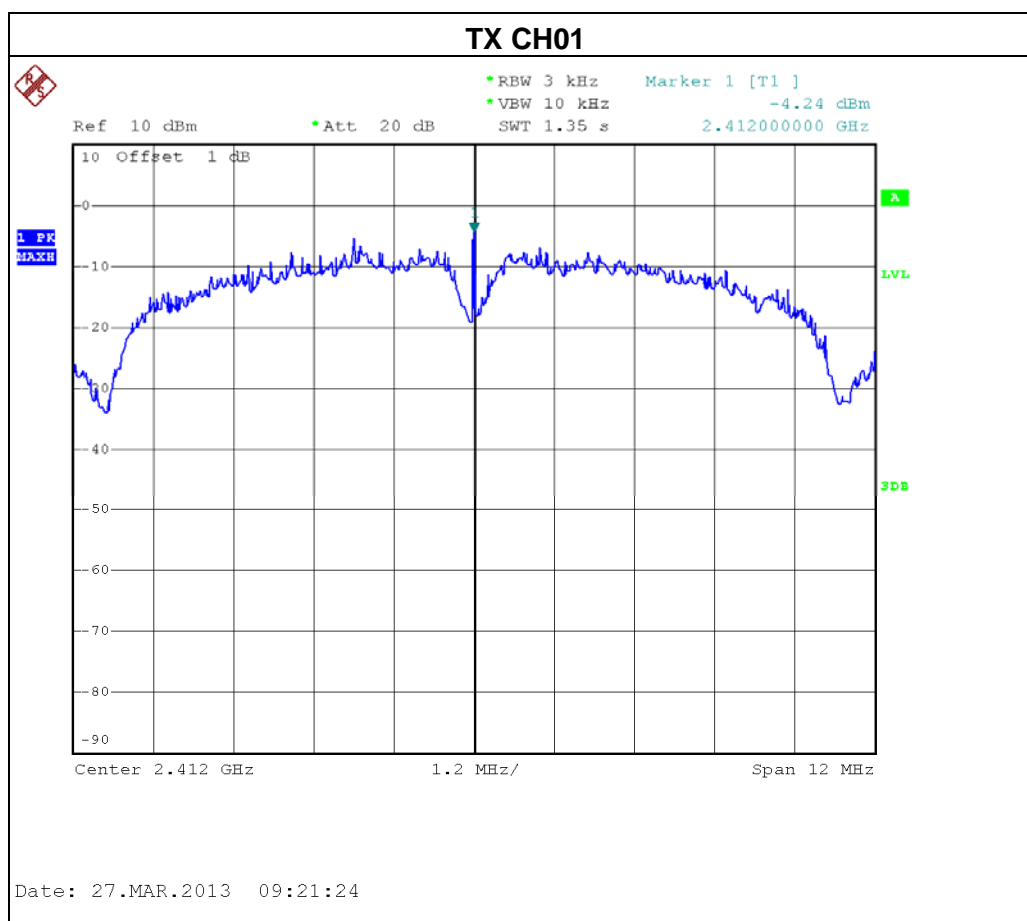

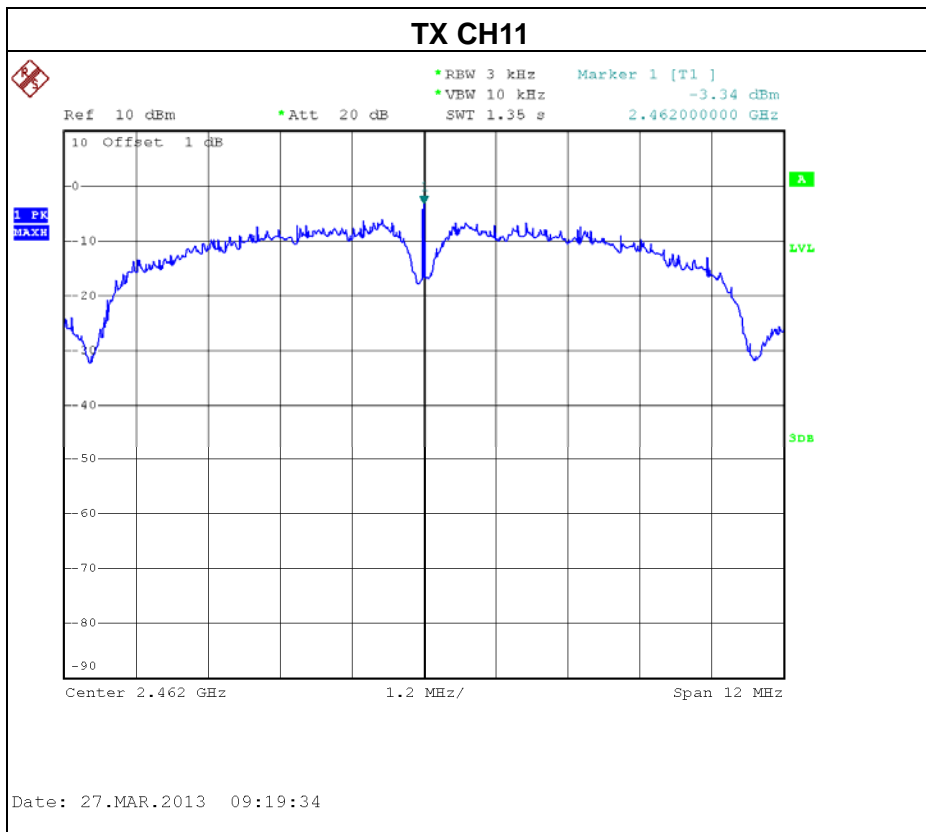
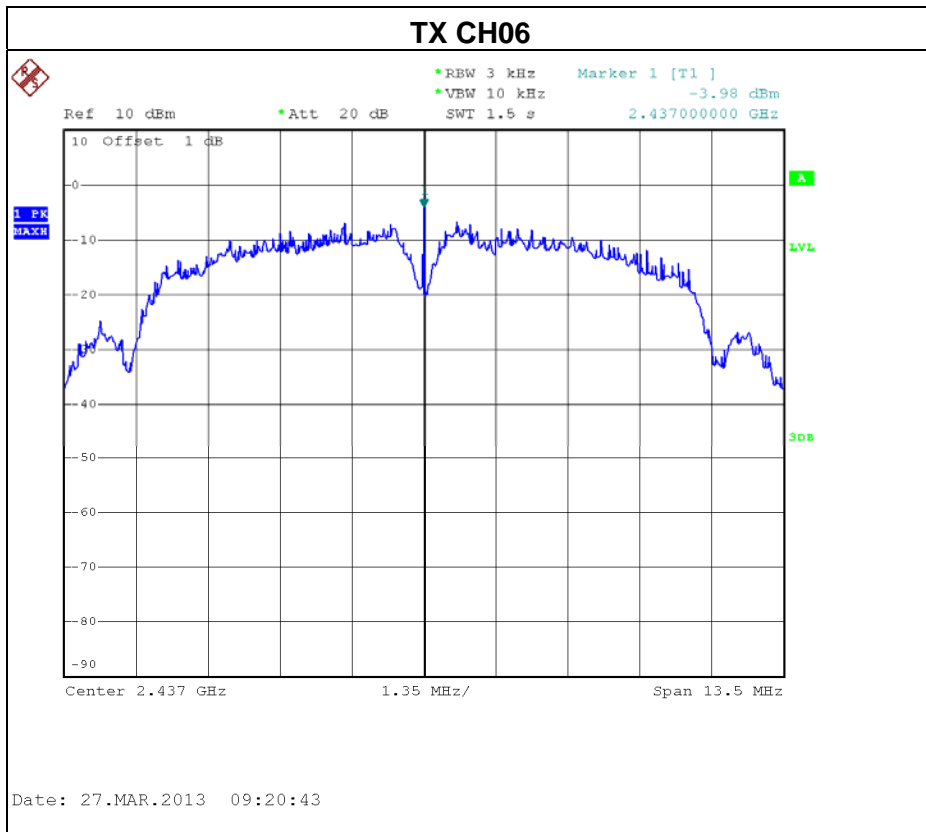



EUT :	Wireless VDSL2 4-port Ethernet Router	Model Name :	DSL-6740B
Temperature :	24 °C	Relative Humidity :	60 %
Pressure :	1016 hPa	Test Voltage :	AC 120V/60Hz
Test Mode :	TX G MODE /CH01, CH06, CH11		

Test Channel	Frequency (MHz)	Power Density (dBm)	LIMIT (dBm)
CH01	2412 MHz	-7.06	8
CH06	2437 MHz	-6.82	8
CH11	2462 MHz	-7.85	8

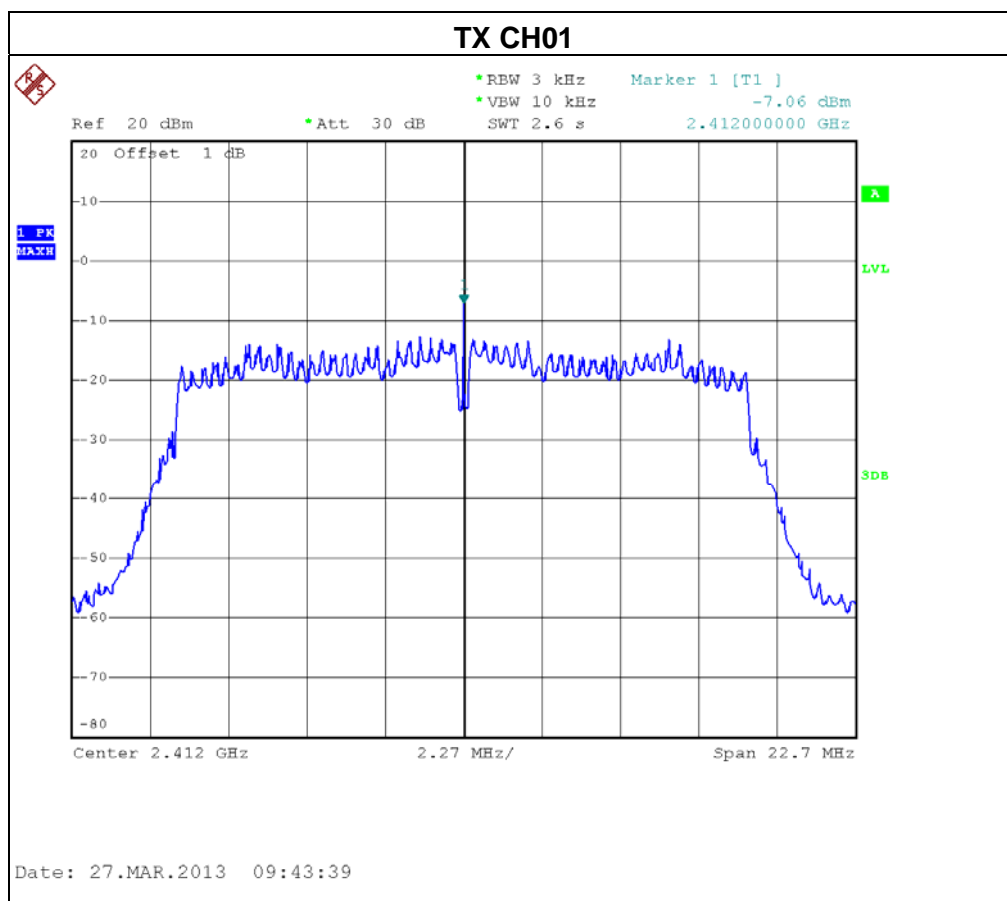

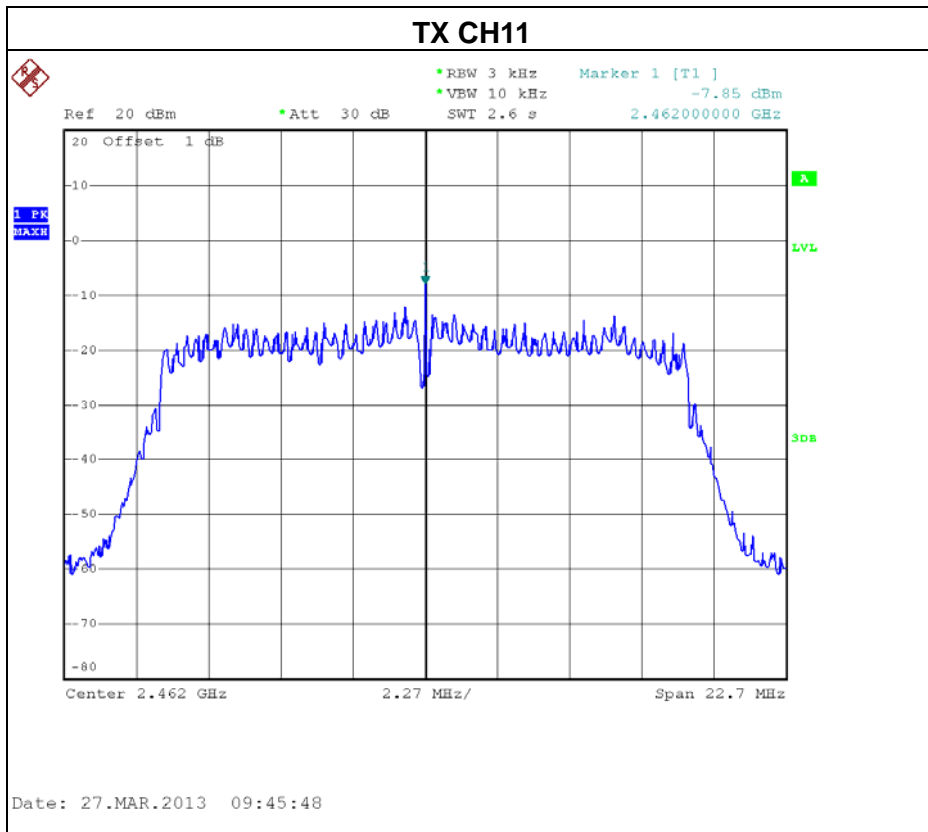
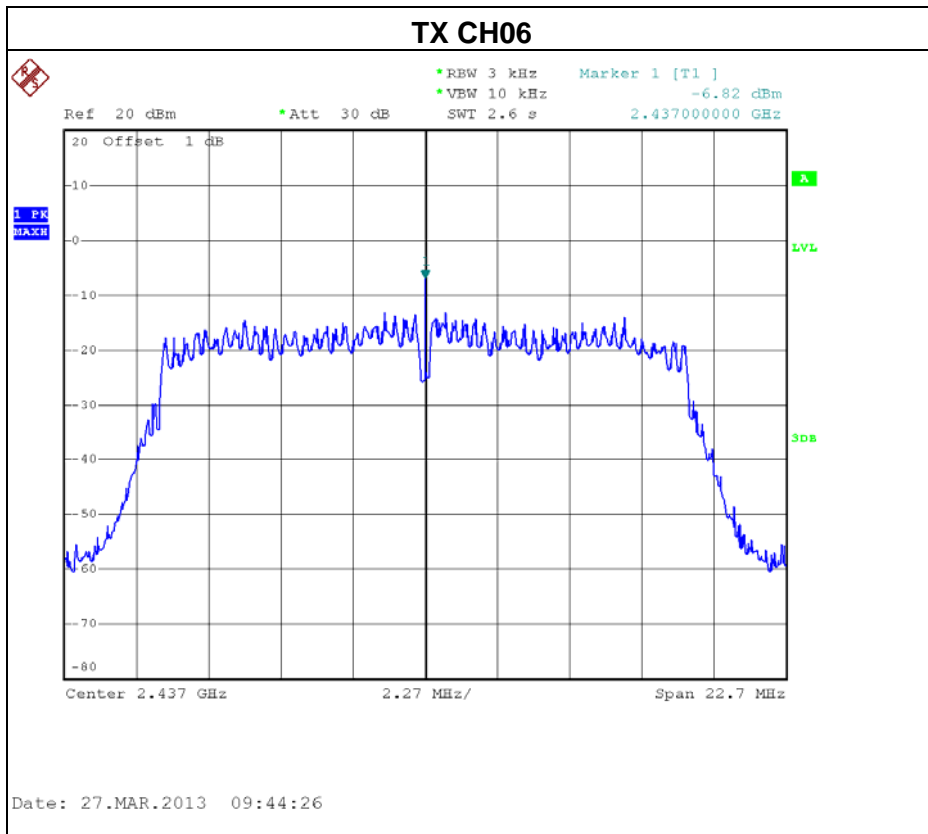



EUT :	Wireless VDSL2 4-port Ethernet Router	Model Name :	DSL-6740B
Temperature :	24 °C	Relative Humidity :	60 %
Pressure :	1016 hPa	Test Voltage :	AC 120V/60Hz
Test Mode :	TX N MODE-20MHz /CH01, CH06, CH11-ANT 1		

Test Channel	Frequency (MHz)	Power Density (dBm)	LIMIT (dBm)
CH01	2412 MHz	-14.82	8
CH06	2437 MHz	-15.09	8
CH11	2462 MHz	-14.16	8

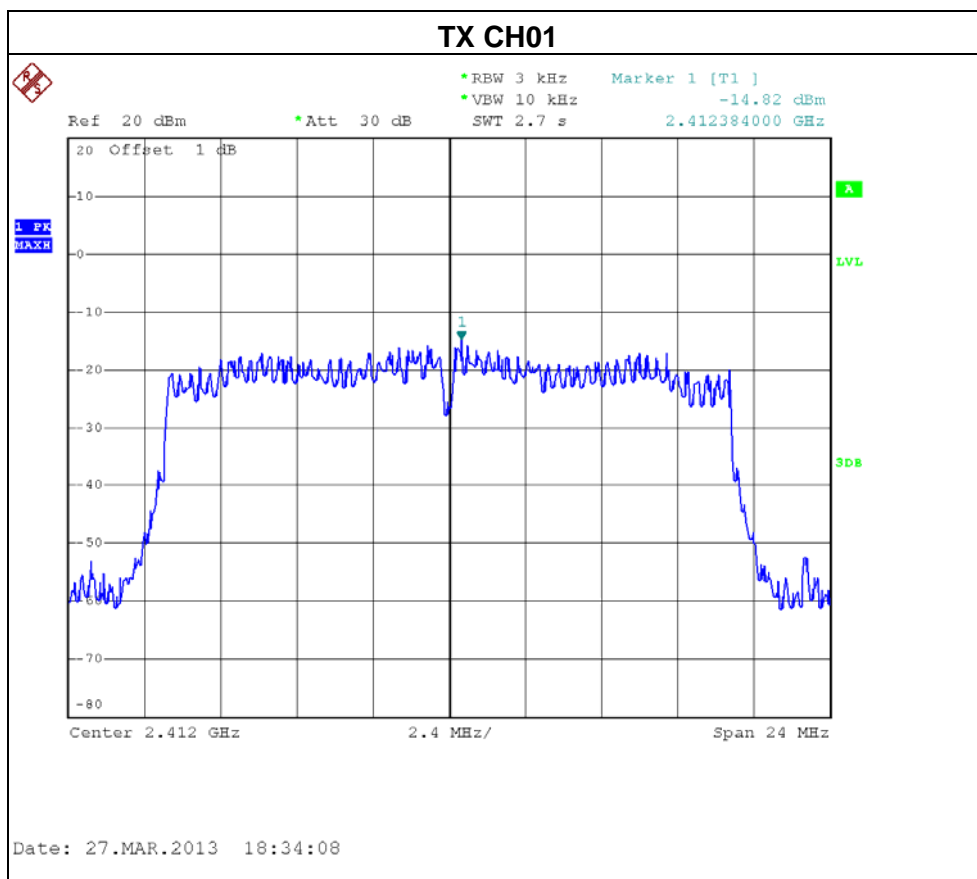

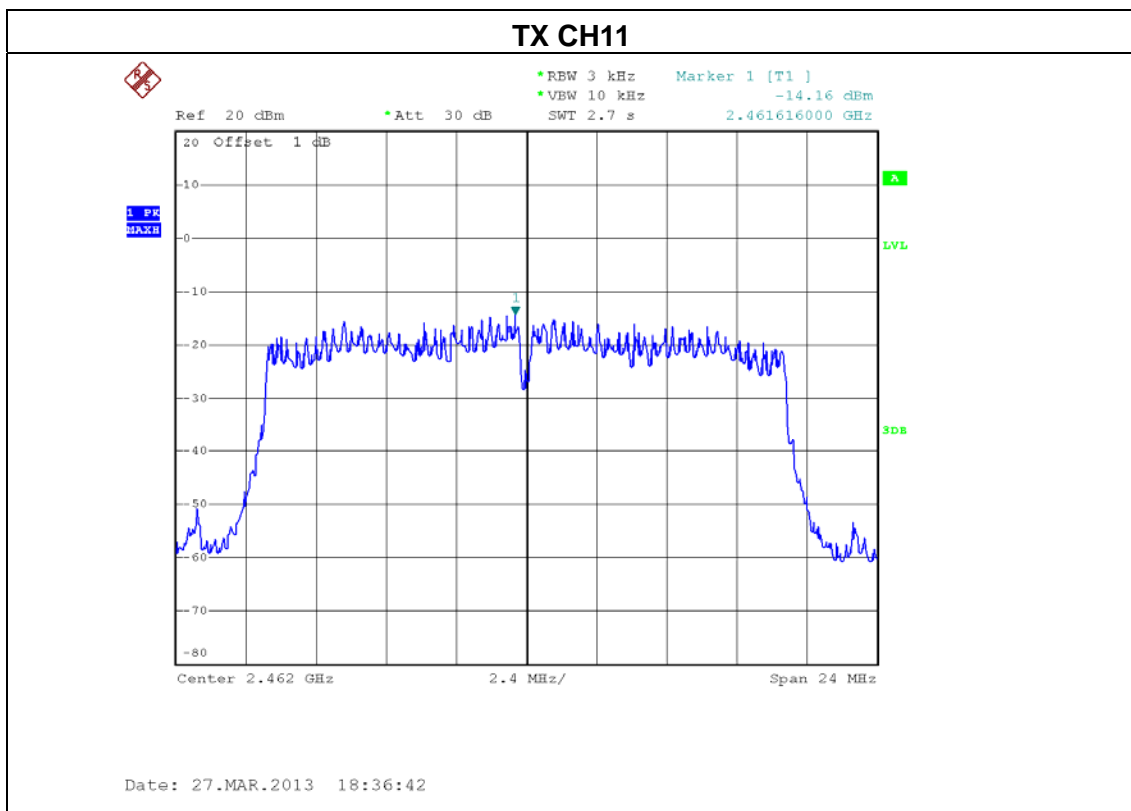
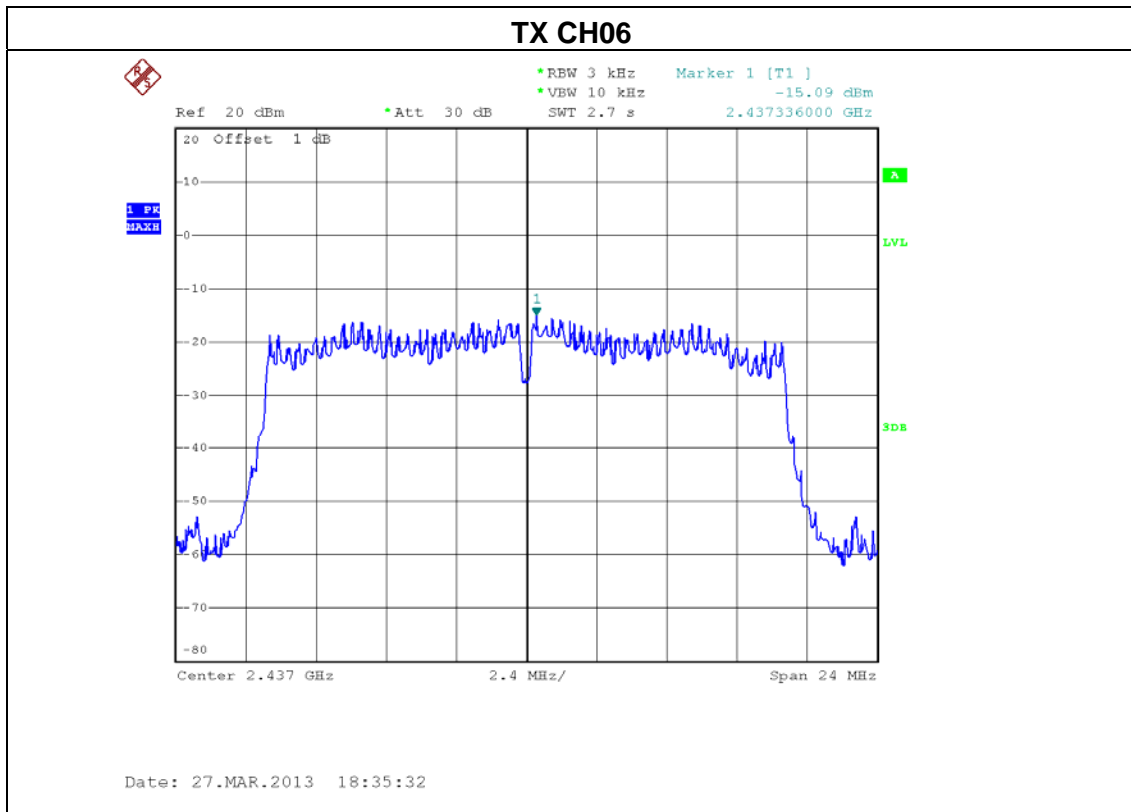



EUT :	Wireless VDSL2 4-port Ethernet Router	Model Name :	DSL-6740B
Temperature :	24 °C	Relative Humidity :	60 %
Pressure :	1016 hPa	Test Voltage :	AC 120V/60Hz
Test Mode :	TX N MODE-20MHz /CH01, CH06, CH11-ANT 2		

Test Channel	Frequency (MHz)	Power Density (dBm)	LIMIT (dBm)
CH01	2412 MHz	-13.35	8
CH06	2437 MHz	-14.93	8
CH11	2462 MHz	-15.24	8

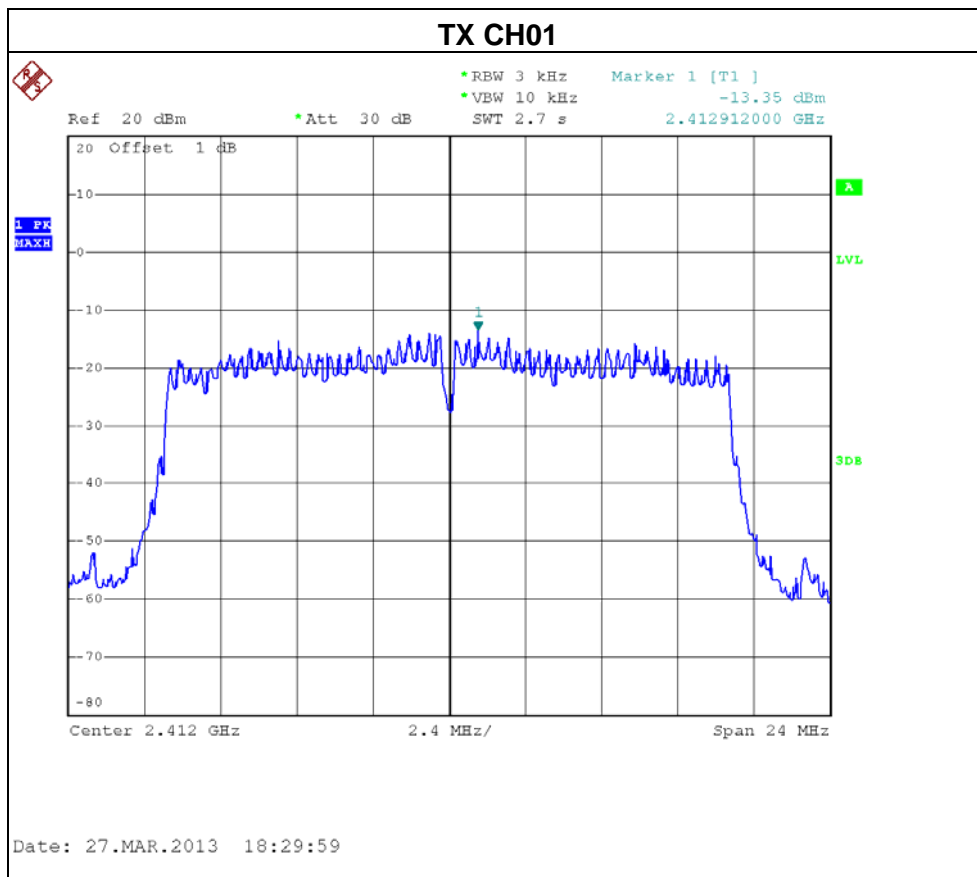

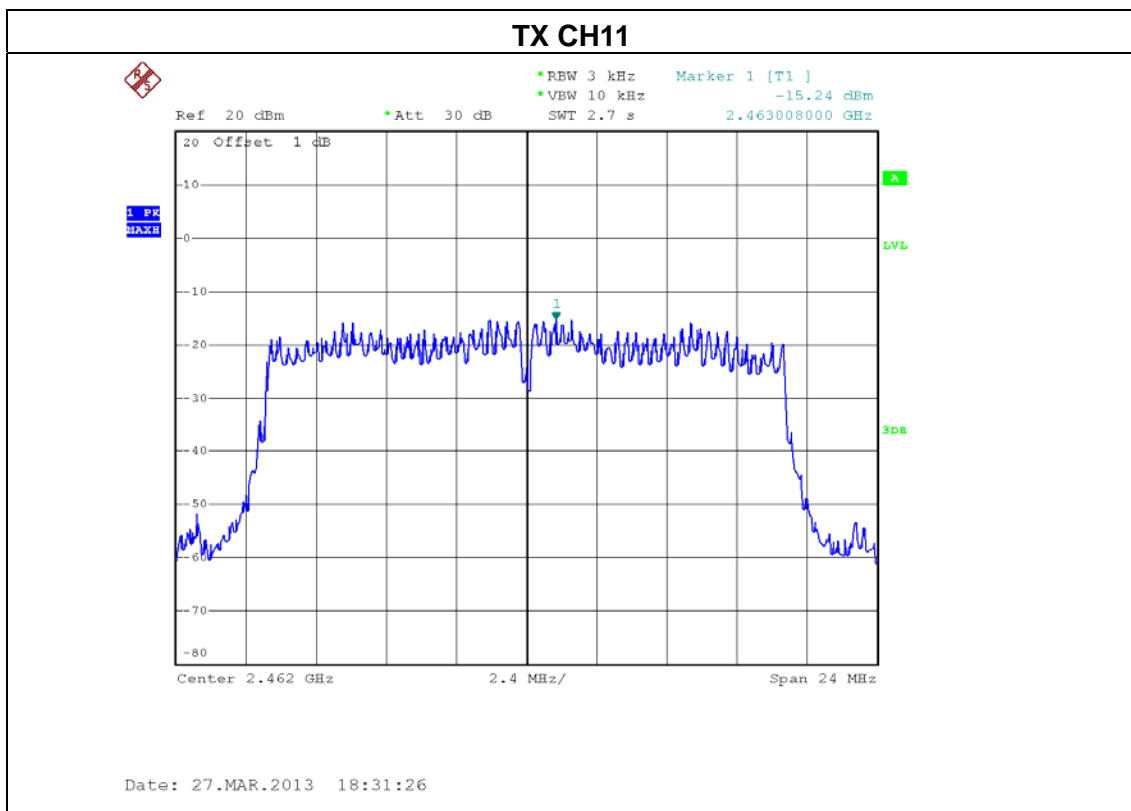
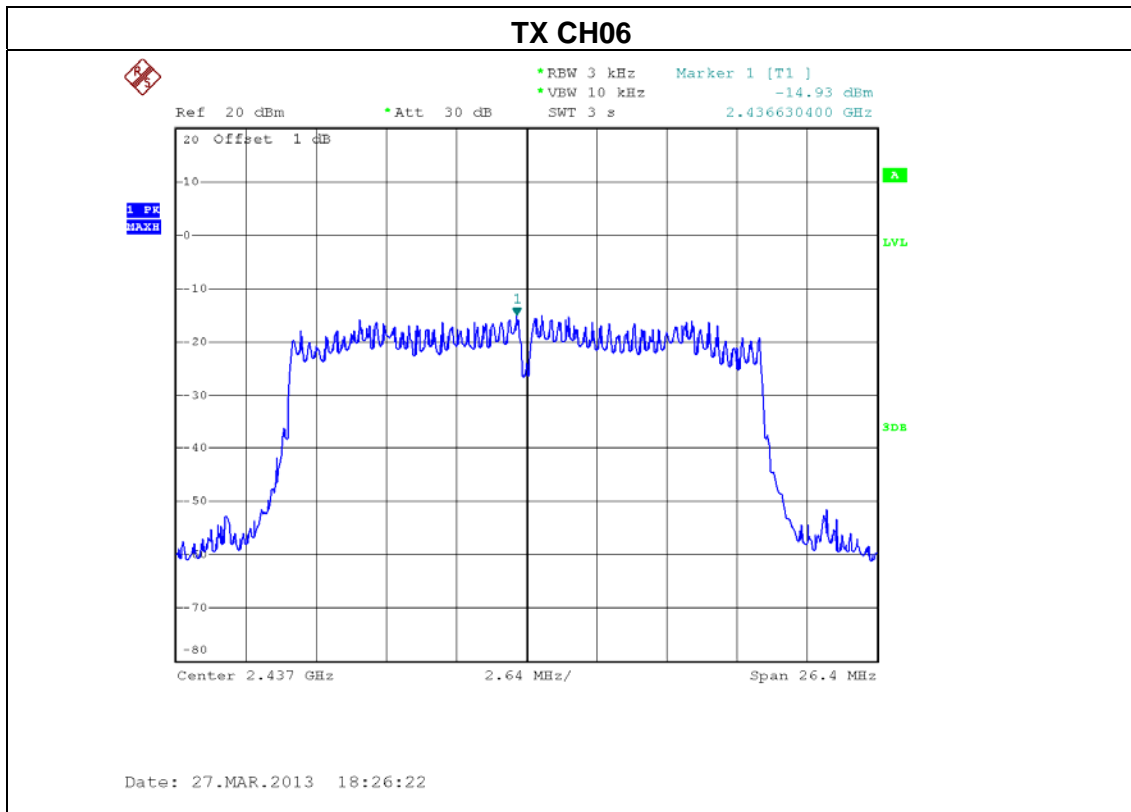



EUT :	Wireless VDSL2 4-port Ethernet Router	Model Name :	DSL-6740B
Temperature :	24 °C	Relative Humidity :	60 %
Pressure :	1016 hPa	Test Voltage :	AC 120V/60Hz
Test Mode :	TX N MODE-20MHz /CH01, CH06, CH11 –ANT 1+ANT 2		

Test Channel	Frequency (MHz)	Power density		LIMIT (dBm)	PASS/FAIL
		(dBm)	(mW)		
CH01	2412	-11.01	0.08	8	PASS
CH06	2437	-12.00	0.06	8	PASS
CH11	2462	-11.66	0.07	8	PASS



EUT :	Wireless VDSL2 4-port Ethernet Router	Model Name :	DSL-6740B
Temperature :	24 °C	Relative Humidity :	60 %
Pressure :	1016 hPa	Test Voltage :	AC 120V/60Hz
Test Mode :	TX N MODE-40MHz /CH03, CH06, CH09-ANT 1		

Test Channel	Frequency (MHz)	Power Density (dBm)	LIMIT (dBm)
CH03	2422 MHz	-21.52	8
CH06	2437 MHz	-21.35	8
CH09	2462 MHz	-21.49	8

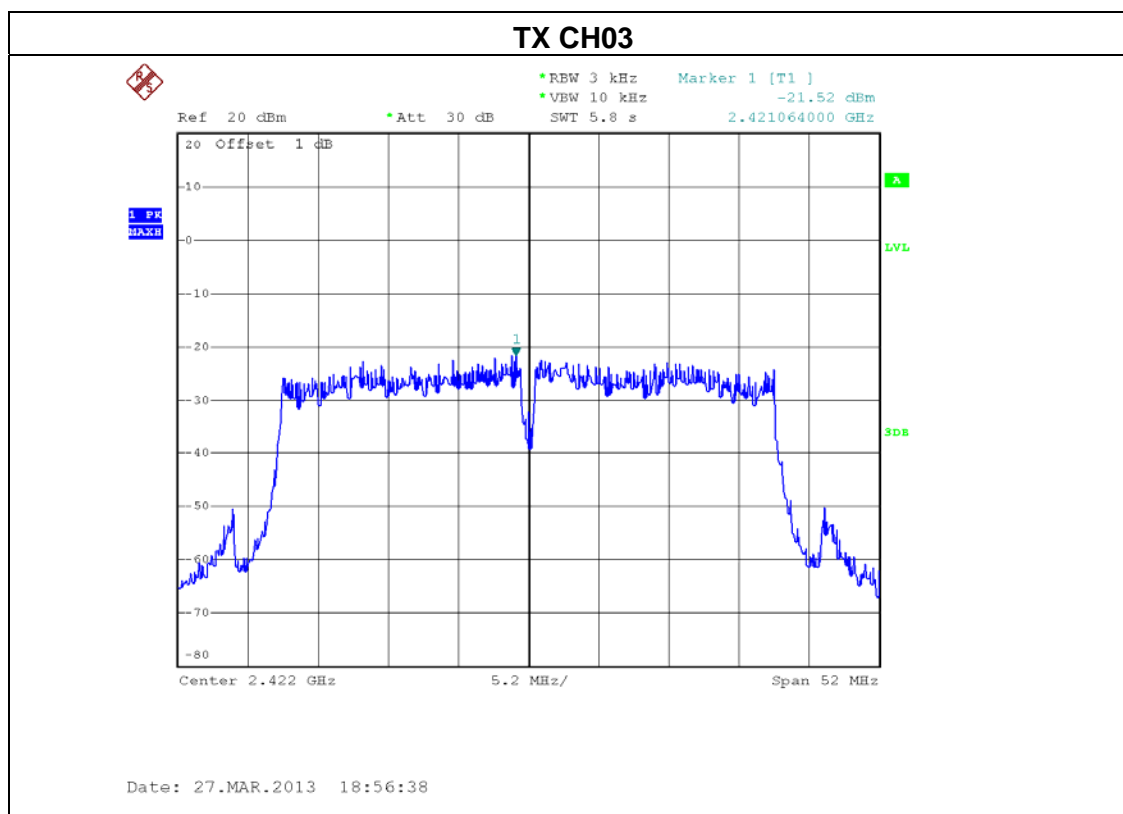

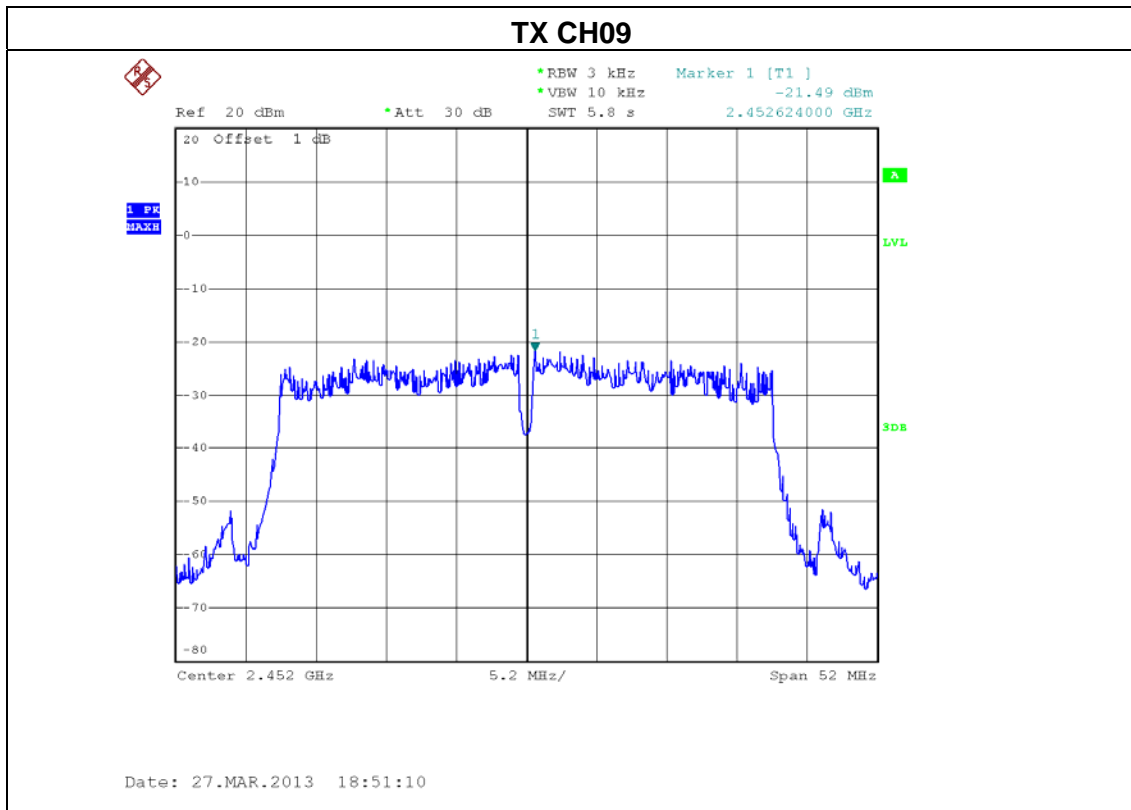
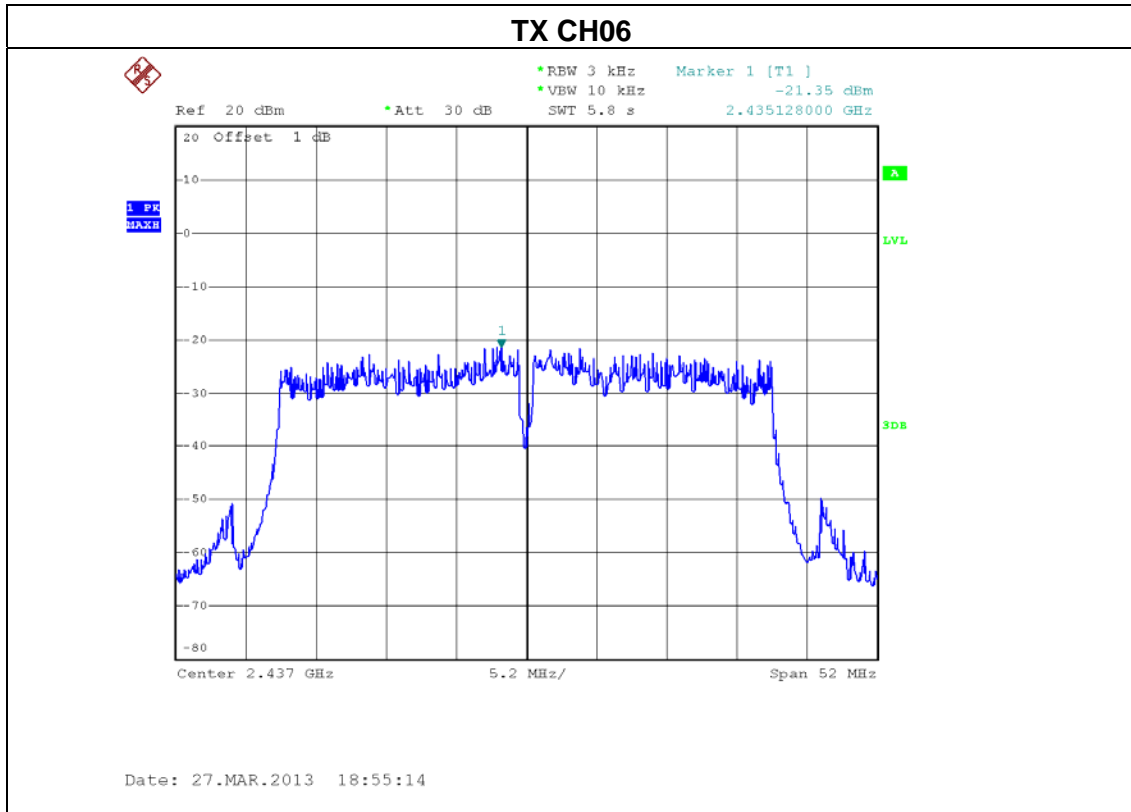



EUT :	Wireless VDSL2 4-port Ethernet Router	Model Name :	DSL-6740B
Temperature :	24 °C	Relative Humidity :	60 %
Pressure :	1016 hPa	Test Voltage :	AC 120V/60Hz
Test Mode :	TX N MODE-40MHz /CH03, CH06, CH09-ANT 2		

Test Channel	Frequency (MHz)	Power Density (dBm)	LIMIT (dBm)
CH03	2422 MHz	-21.77	8
CH06	2437 MHz	-20.31	8
CH09	2462 MHz	-20.54	8

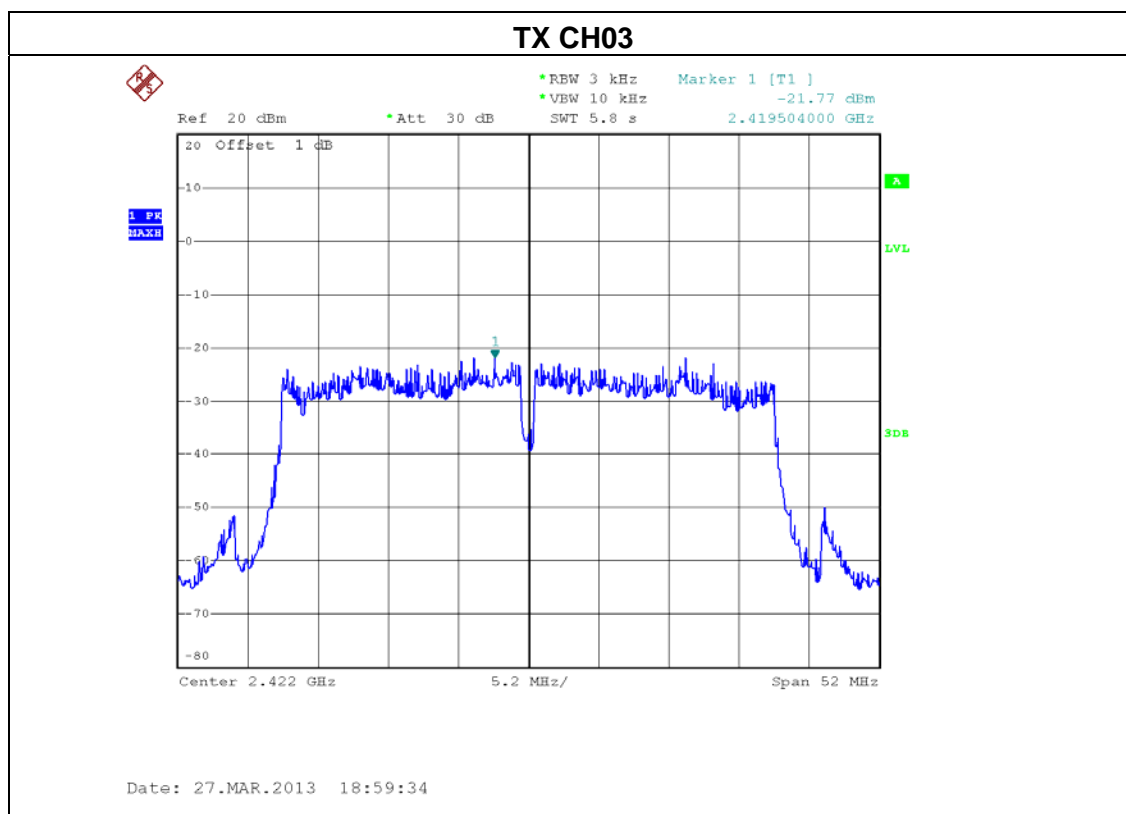

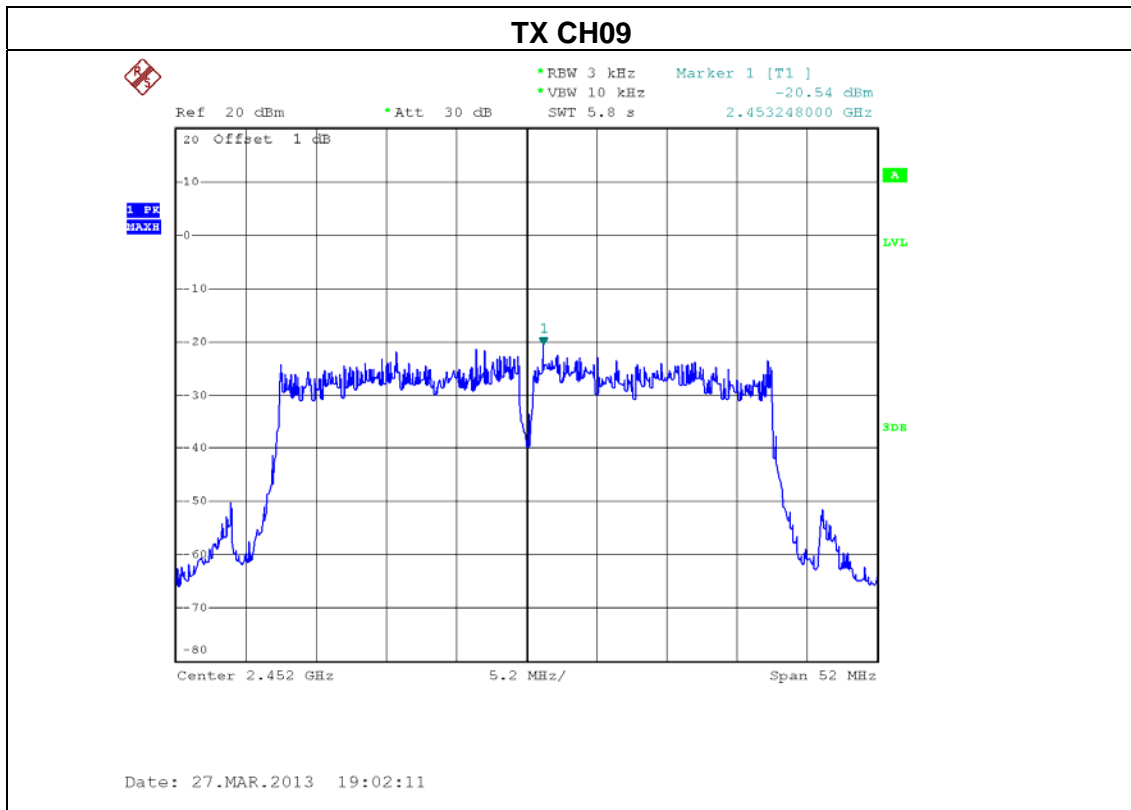
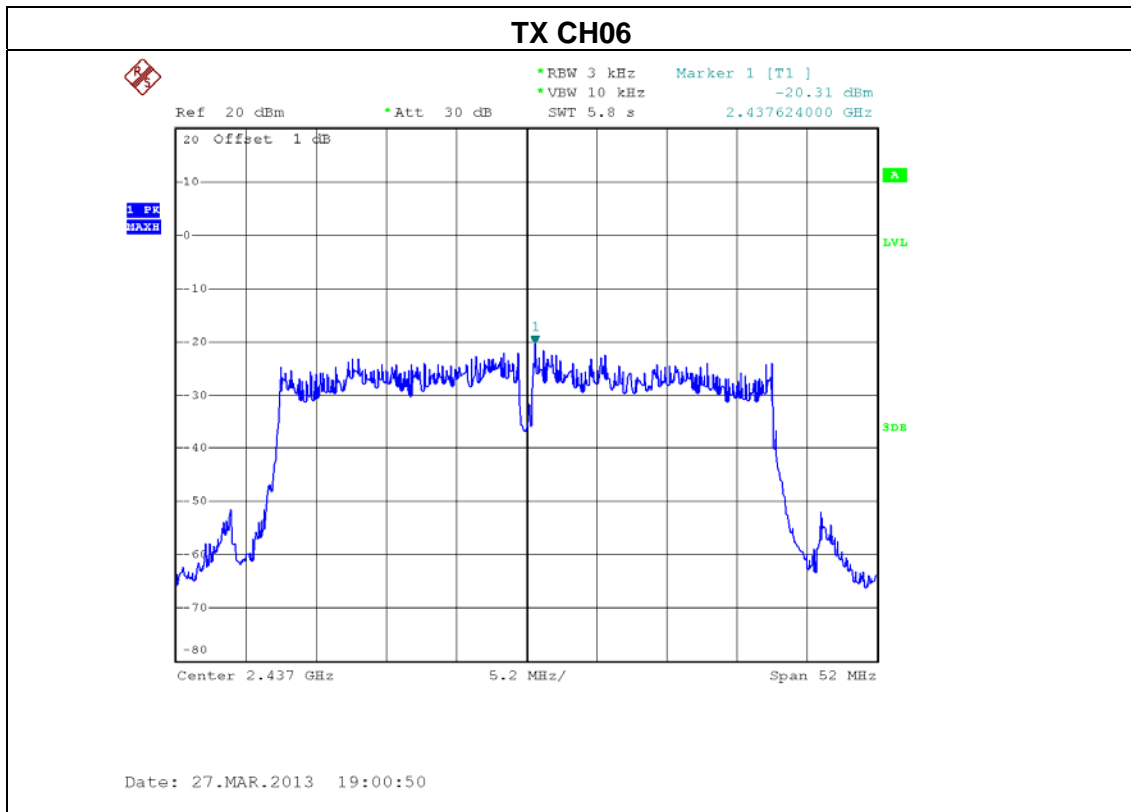



Neutron Engineering Inc.

EUT :	Wireless VDSL2 4-port Ethernet Router	Model Name :	DSL-6740B
Temperature :	24 °C	Relative Humidity :	60 %
Pressure :	1016 hPa	Test Voltage :	AC 120V/60Hz
Test Mode :	TX N MODE-40MHz /CH03, CH06, CH09 –ANT 1+ANT 2		

Test Channel	Frequency (MHz)	Power density		LIMIT (dBm)	PASS/FAIL
		(dBm)	(mW)		
CH01	2412	-18.63	0.01	8	PASS
CH06	2437	-17.79	0.02	8	PASS
CH11	2462	-17.98	0.02	8	PASS



9. EUT TEST PHOTO

**Conducted Measurement Photos
Adapter: MSP-C1500IC12.0-18W-US**





**Conducted Measurement Photos
Adapter: F18W-120150SPAU**





**Conducted Measurement Photos
Adapter: RD1201500-C38-1MG**





**Radiated Measurement Photos
9KHz~30MHz**

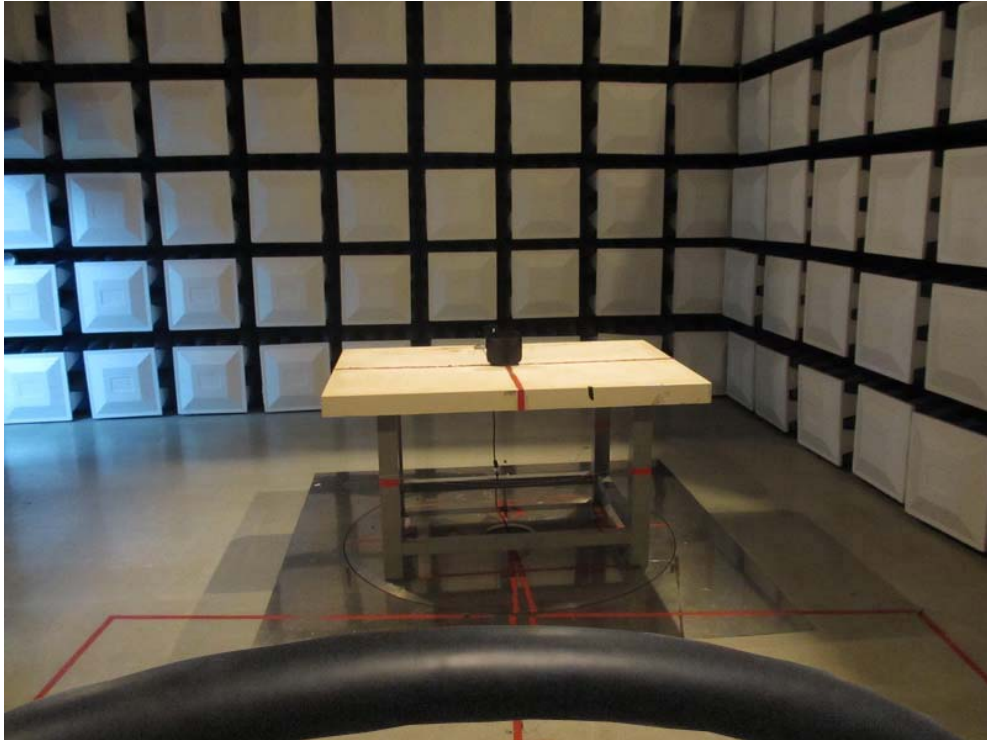



**Radiated Measurement Photos
30MHz~1G
Adapter: MSP-C1500IC12.0-18W-US**

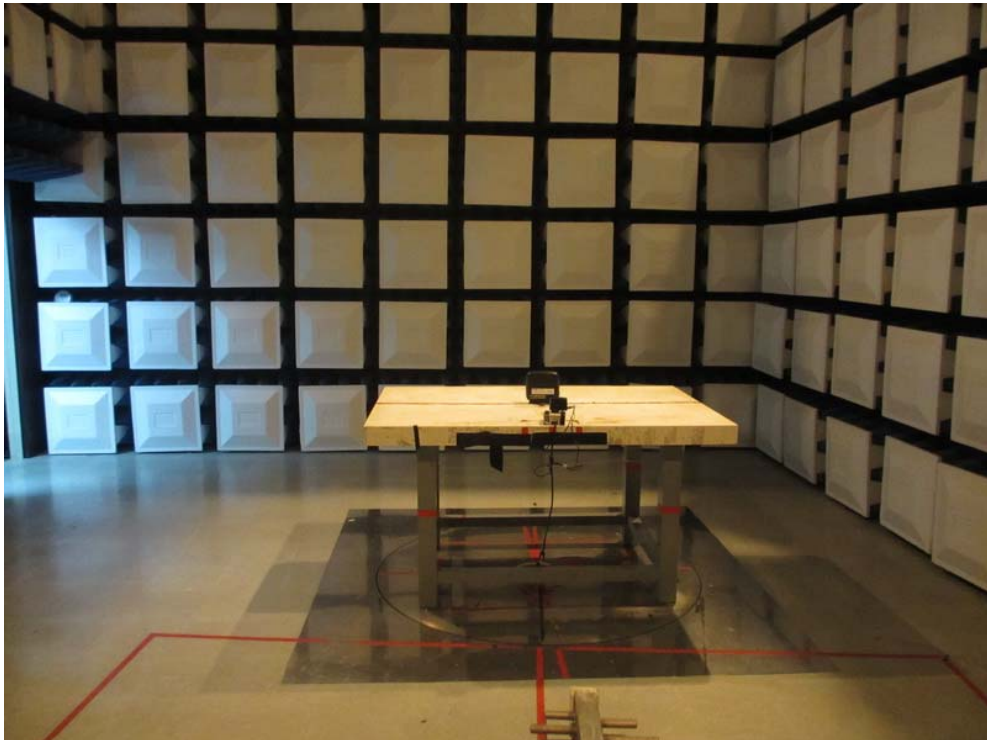



**Radiated Measurement Photos
30MHz~1G
Adapter: F18W-120150SPAU**

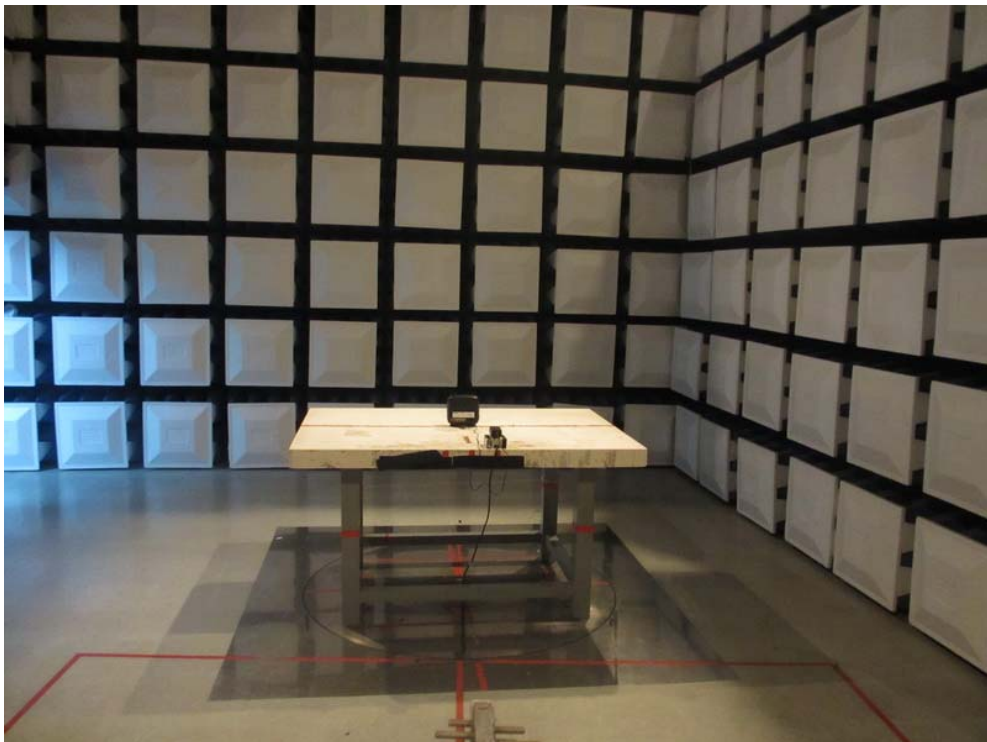
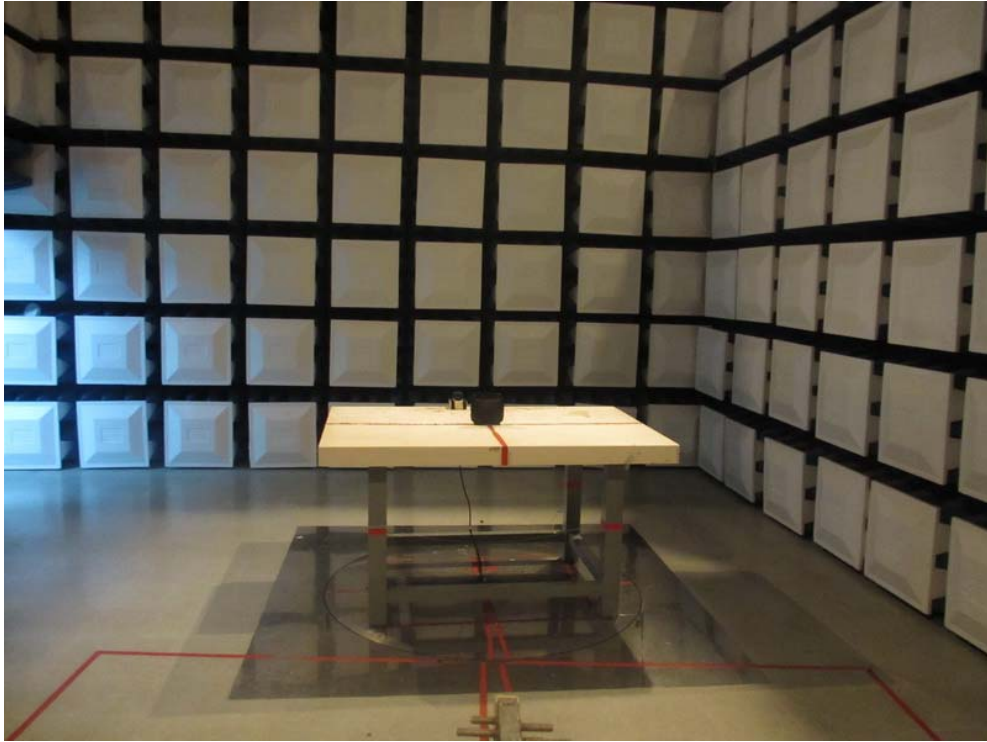



**Radiated Measurement Photos
30MHz~1G
Adapter: RD1201500-C38-1MG**

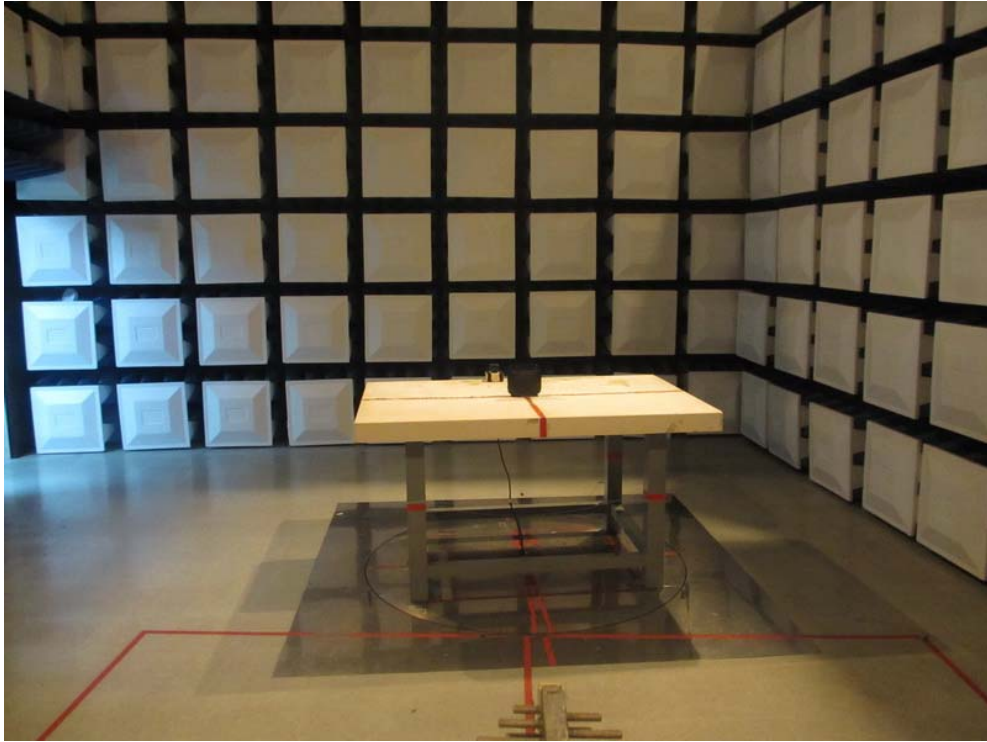



**Radiated Measurement Photos
Above 1G**

