

FCC Test Report (DFS Band)

Report No.: RF161018E04C-1

FCC ID: KA2SHC310A1

Test Model: DSH-C310

Received Date: Feb. 15, 2017

Test Date: Feb. 23 to Mar. 03, 2017

Issued Date: Mar. 15, 2017

Applicant: D-Link Corporation

Address: No.289, Sinhu 3rd Rd., Neihu District, Taipei City 114, Taiwan, R.O.C.

Issued By: Bureau Veritas Consumer Products Services (H.K.) Ltd., Taoyuan Branch
Hsin Chu Laboratory

Lab Address: E-2, No.1, Li Hsin 1st Road, Hsinchu Science Park, Hsinchu City 300,
Taiwan R.O.C.

Test Location (1): E-2, No.1, Li Hsin 1st Road, Hsinchu Science Park, Hsinchu City 300,
Taiwan R.O.C.

Test Location (2): No. 49, Ln. 206, Wende Rd., Shangshan Tsuen, Chiung Lin Hsiang, Hsin
Chu Hsien 307, Taiwan R.O.C.



This report is for your exclusive use. Any copying or replication of this report to or for any other person or entity, or use of our name or trademark, is permitted only with our prior written permission. This report sets forth our findings solely with respect to the test samples identified herein. The results set forth in this report are not indicative or representative of the quality or characteristics of the lot from which a test sample was taken or any similar or identical product unless specifically and expressly noted. Our report includes all of the tests requested by you and the results thereof based upon the information that you provided to us. You have 60 days from date of issuance of this report to notify us of any material error or omission caused by our negligence, provided, however, that such notice shall be in writing and shall specifically address the issue you wish to raise. A failure to raise such issue within the prescribed time shall constitute your unqualified acceptance of the completeness of this report, the tests conducted and the correctness of the report contents. Unless specific mention, the uncertainty of measurement has been explicitly taken into account to declare the compliance or non-compliance to the specification. The report must not be used by the client to claim product certification, approval, or endorsement by TAF or any government agencies.

Table of Contents

Report Issue History Record of EUT	4
Release Control Record	4
1 Certificate of Conformity	5
2 Summary of Test Results	6
2.1 Measurement Uncertainty	6
2.2 Modification Record	6
3 General Information	7
3.1 General Description of EUT (DFS Band)	7
3.2 Description of Test Modes	9
3.2.1 Test Mode Applicability and Tested Channel Detail	10
3.3 Duty Cycle of Test Signal	12
3.4 Description of Support Units	13
3.4.1 Configuration of System under Test	13
3.5 General Description of Applied Standard	14
4 Test Types and Results	15
4.1 Radiated Emission and Bandedge Measurement	15
4.1.1 Limits of Radiated Emission and Bandedge Measurement	15
4.1.2 Test Instruments	16
4.1.3 Test Procedure	18
4.1.4 Deviation from Test Standard	18
4.1.5 Test Setup	19
4.1.6 EUT Operating Condition	20
4.1.7 Test Results	21
4.2 Conducted Emission Measurement	42
4.2.1 Limits of Conducted Emission Measurement	42
4.2.2 Test Instruments	42
4.2.3 Test Procedure	43
4.2.4 Deviation from Test Standard	43
4.2.5 Test Setup	43
4.2.6 EUT Operating Condition	43
4.2.7 Test Results	44
4.3 Transmit Power Measurement	46
4.3.1 Limits of Transmit Power Measurement	46
4.3.2 Test Setup	46
4.3.3 Test Instruments	46
4.3.4 Test Procedure	47
4.3.5 Deviation from Test Standard	47
4.3.6 EUT Operating Condition	47
4.3.7 Test Result	48
4.4 Occupied Bandwidth Measurement	53
4.4.1 Test Setup	53
4.4.2 Test Instruments	53
4.4.3 Test Procedure	53
4.4.4 Test Results	54
4.5 Peak Power Spectral Density Measurement	56
4.5.1 Limits of Peak Power Spectral Density Measurement	56
4.5.2 Test Setup	56
4.5.3 Test Instruments	56
4.5.4 Test Procedure	56
4.5.5 Deviation from Test Standard	56
4.5.6 EUT Operating Condition	56
4.5.7 Test Results	57

4.6	Frequency Stability Measurement.....	59
4.6.1	Limits of Frequency Stability Measurement	59
4.6.2	Test Setup.....	59
4.6.3	Test Instruments	59
4.6.4	Test Procedure	59
4.6.5	Deviation from Test Standard	59
4.6.6	EUT Operating Condition	59
4.6.7	Test Results	60
5	Pictures of Test Arrangements.....	61
	Appendix – Information on the Testing Laboratories	62

Report Issue History Record of EUT

Attachment No.	Issue Date	Description
RF161018E04-1	Dec. 16, 2016	Original
RF161018E04C-1	Mar. 15, 2017	Add DFS band <5.26 ~ 5.32GHz, 5.50 ~ 5.70GHz>

Release Control Record

Issue No.	Description	Date Issued
RF161018E04C-1	Original release.	Mar. 15, 2017

1 Certificate of Conformity

Product: Omna 180Cam HD

Brand: D-Link

Test Model: DSH-C310

Sample Status: ENGINEERING SAMPLE

Applicant: D-Link Corporation

Test Date: Feb. 23 to Mar. 03, 2017

Standard: 47 CFR FCC Part 15, Subpart E (Section 15.407)
ANSI C63.10: 2013

The above equipment has been tested by **Bureau Veritas Consumer Products Services (H.K.) Ltd., Taoyuan Branch**, and found compliance with the requirement of the above standards. The test record, data evaluation & Equipment Under Test (EUT) configurations represented herein are true and accurate accounts of the measurements of the sample's EMC characteristics under the conditions specified in this report.

Prepared by : Wendy Wu, **Date:** Mar. 15, 2017
Wendy Wu / Specialist

Approved by : May Chen, **Date:** Mar. 15, 2017
May Chen / Manager

2 Summary of Test Results

47 CFR FCC Part 15, Subpart E (Section 15.407)			
FCC Clause	Test Item	Result	Remarks
15.407(b)(6)	AC Power Conducted Emissions	Pass	Meet the requirement of limit. Minimum passing margin is -22.75dB at 0.15000MHz.
15.407(b) (1/2/3/4(i/ii)/6)	Radiated Emissions & Band Edge Measurement*	Pass	Meet the requirement of limit. Minimum passing margin is -0.1dB at 5350.00MHz, 5470.00MHz.
15.407(a)(1/2/3)	Max Average Transmit Power	Pass	Meet the requirement of limit.
---	Occupied Bandwidth Measurement	-	Reference only.
15.407(a)(1/2/3)	Peak Power Spectral Density	Pass	Meet the requirement of limit.
15.407(g)	Frequency Stability	Pass	Meet the requirement of limit.
15.203	Antenna Requirement	Pass	Antenna connector is MHF not a standard connector.

2.1 Measurement Uncertainty

Where relevant, the following measurement uncertainty levels have been estimated for tests performed on the EUT as specified in CISPR 16-4-2:

Measurement	Frequency	Expanded Uncertainty (k=2) (±)
Conducted Emissions at mains ports	150kHz ~ 30MHz	1.83 dB
Radiated Emissions up to 1 GHz	30MHz ~ 1GHz	5.34 dB
Radiated Emissions above 1 GHz	1GHz ~ 6GHz	3.41 dB
	6GHz ~ 18GHz	3.49 dB
	18GHz ~ 40GHz	3.30 dB

2.2 Modification Record

There were no modifications required for compliance.

3 General Information

3.1 General Description of EUT (DFS Band)

Product	Omna 180Cam HD
Brand	D-Link
Test Model	DSH-C310
Status of EUT	ENGINEERING SAMPLE
Power Supply Rating	DC 5V from adapter
Modulation Type	64QAM, 16QAM, QPSK, BPSK for OFDM 256QAM for OFDM in 11ac mode only
Modulation Technology	OFDM
Transfer Rate	802.11a: up to 54Mbps 802.11n: up to 150Mbps 802.11ac: up to 433.3Mbps
Operating Frequency	5.26~ 5.32GHz, 5.50 ~ 5.70GHz
Number of Channel	802.11a, 802.11n (HT20), 802.11ac (VHT20): 15 802.11n (HT40), 802.11ac (VHT40): 7 802.11ac (VHT80): 3
Output Power	5.26GHz ~ 5.32GHz: 159.221mW 5.50GHz ~ 5.70GHz: 140.605mW
Antenna Type	Refer to Note
Antenna Connector	Refer to Note
Accessory Device	Adapter x 1
Data Cable Supplied	NA

Note:

- This report is prepared for FCC class II permissive change. The difference compared with the Report No.: RF161018E04-1 as the following:
 - ◆ Add DFS band <5.26GHz ~ 5.32GHz, 5.50GHz ~ 5.70GHz>
- 2.4GHz and 5GHz technology can not transmit at same time.
- The antenna provided to the EUT, please refer to the following table:

Brand	Model	Antenna Net Gain(dBi)	Frequency range (GHz ~ GHz)	Antenna Type	Connector Type	Cable Length (mm)
Mgear	C037-511444-A	2.4	2.4~2.4835	PCB	MHF	56.5
		4.8	5.15~5.85			

- The EUT must be supplied with a power adapter as following table:

Brand	Model No.	Spec.
D-Link	WB-10E05R	Input: 100-240V, 0.4A, 50-60Hz Output: 5V, 2A DC output cable (unshielded, 3m)

5. The EUT incorporates a SISO function.

2.4GHz Band			
MODULATION MODE	DATA RATE (MCS)	TX & RX CONFIGURATION	
802.11b	1 ~ 11Mbps	1TX	1RX
802.11g	6 ~ 54Mbps	1TX	1RX
802.11n (HT20)	MCS 0~7	1TX	1RX
5GHz Band			
MODULATION MODE	DATA RATE (MCS)	TX & RX CONFIGURATION	
802.11a	6 ~ 54Mbps	1TX	1RX
802.11n (HT20)	MCS 0~7	1TX	1RX
802.11n (HT40)	MCS 0~7	1TX	1RX
802.11ac (VHT20)	MCS 0~8, Nss=1	1TX	1RX
802.11ac (VHT40)	MCS 0~9, Nss=1	1TX	1RX
802.11ac (VHT80)	MCS 0~9, Nss=1	1TX	1RX

6. The above EUT information is declared by manufacturer and for more detailed features description, please refer to the manufacturer's specifications or user's manual.

3.2 Description of Test Modes

FOR 5260 ~ 5320MHz

4 channels are provided for 802.11a, 802.11n (HT20), 802.11ac (VHT20):

Channel	Frequency	Channel	Frequency
52	5260 MHz	60	5300 MHz
56	5280 MHz	64	5320 MHz

2 channels are provided for 802.11n (HT40), 802.11ac (VHT40):

Channel	Frequency	Channel	Frequency
54	5270 MHz	62	5310 MHz

1 channel is provided for 802.11ac (VHT80):

Channel	Frequency
58	5290 MHz

FOR 5500 ~ 5700MHz

11 channels are provided for 802.11a, 802.11n (HT20), 802.11ac (VHT20):

Channel	Frequency	Channel	Frequency
100	5500 MHz	124	5620 MHz
104	5520 MHz	128	5640 MHz
108	5540 MHz	132	5660 MHz
112	5560 MHz	136	5680 MHz
116	5580 MHz	140	5700 MHz
120	5600 MHz		

5 channels are provided for 802.11n (HT40), 802.11ac (VHT40):

Channel	Frequency	Channel	Frequency
102	5510 MHz	126	5630 MHz
110	5550 MHz	134	5670 MHz
118	5590 MHz		

2 channels are provided for 802.11ac (VHT80):

Channel	Frequency	Channel	Frequency
106	5530MHz	122	5610 MHz

3.2.1 Test Mode Applicability and Tested Channel Detail

EUT Configure Mode	Applicable To				Description
	RE≥1G	RE<1G	PLC	APCM	
-	√	√	√	√	-

Where **RE≥1G**: Radiated Emission above 1GHz **RE<1G**: Radiated Emission below 1GHz
PLC: Power Line Conducted Emission **APCM**: Antenna Port Conducted Measurement

Radiated Emission Test (Above 1GHz):

- Pre-Scan has been conducted to determine the worst-case mode from all possible combinations between available modulations, data rates and antenna ports (if EUT with antenna diversity architecture).
- Following channel(s) was (were) selected for the final test as listed below.

Mode	FREQ. Band (MHz)	Available Channel	Tested Channel	Modulation Technology	Modulation Type	Data Rate (Mbps)
802.11a	5260-5320	52 to 64	52, 60, 64	OFDM	BPSK	6
802.11ac (VHT20)		52 to 64	52, 60, 64	OFDM	BPSK	6.5
802.11ac (VHT40)		54 to 62	54, 62	OFDM	BPSK	13.5
802.11ac (VHT80)		58	58	OFDM	BPSK	29.3
802.11a	5500-5700	100 to 140	100, 116, 140	OFDM	BPSK	6
802.11ac (VHT20)		100 to 140	100, 116, 140	OFDM	BPSK	6.5
802.11ac (VHT40)		102 to 134	102, 110, 134	OFDM	BPSK	13.5
802.11ac (VHT80)		106 to 122	106, 122	OFDM	BPSK	29.3

Radiated Emission Test (Below 1GHz):

- Pre-Scan has been conducted to determine the worst-case mode from all possible combinations between available modulations, data rates and antenna ports (if EUT with antenna diversity architecture).
- Following channel(s) was (were) selected for the final test as listed below.

Mode	FREQ. Band (MHz)	Available Channel	Tested Channel	Modulation Technology	Modulation Type	Data Rate (Mbps)
802.11ac (VHT20)	5260-5320	52 to 64	60	OFDM	BPSK	6

Power Line Conducted Emission Test:

- Pre-Scan has been conducted to determine the worst-case mode from all possible combinations between available modulations, data rates and antenna ports (if EUT with antenna diversity architecture).
- Following channel(s) was (were) selected for the final test as listed below.

Mode	FREQ. Band (MHz)	Available Channel	Tested Channel	Modulation Technology	Modulation Type	Data Rate (Mbps)
802.11ac (VHT20)	5260-5320	52 to 64	60	OFDM	BPSK	6

Antenna Port Conducted Measurement:

- This item includes all test value of each mode, but only includes spectrum plot of worst value of each mode.
- Pre-Scan has been conducted to determine the worst-case mode from all possible combinations between available modulations, data rates and antenna ports (if EUT with antenna diversity architecture).
- Following channel(s) was (were) selected for the final test as listed below.

Mode	FREQ. Band (MHz)	Available Channel	Tested Channel	Modulation Technology	Modulation Type	Data Rate (Mbps)
802.11a	5260-5320	52 to 64	52, 60, 64	OFDM	BPSK	6
802.11ac (VHT20)		52 to 64	52, 60, 64	OFDM	BPSK	6.5
802.11ac (VHT40)		54 to 62	54, 62	OFDM	BPSK	13.5
802.11ac (VHT80)		58	58	OFDM	BPSK	29.3
802.11a	5500-5700	100 to 140	100, 116, 140	OFDM	BPSK	6
802.11ac (VHT20)		100 to 140	100, 116, 140	OFDM	BPSK	6.5
802.11ac (VHT40)		102 to 134	102, 110, 134	OFDM	BPSK	13.5
802.11ac (VHT80)		106 to 122	106, 122	OFDM	BPSK	29.3

Test Condition:

Applicable To	Environmental Conditions	Input Power	Tested By
RE \geq 1G	23deg. C, 66%RH	120Vac, 60Hz	Terry Huang
RE $<$ 1G	23deg. C, 66%RH	120Vac, 60Hz	Terry Huang
PLC	25deg. C, 75%RH	120Vac, 60Hz	Andy Ho
APCM	20deg. C, 66%RH	120Vac, 60Hz	Andy Ho

3.3 Duty Cycle of Test Signal

If duty cycle of test signal is $\geq 98\%$, duty factor is not required.

If duty cycle of test signal is $< 98\%$, duty factor shall be considered.

802.11a: Duty cycle = $1.44 \text{ ms} / 1.467 \text{ ms} = 0.982$

802.11ac (VHT20): Duty cycle = $1.359 \text{ ms} / 1.387 \text{ ms} = 0.98$

802.11ac (VHT40): Duty cycle = $0.675 \text{ ms} / 0.721 \text{ ms} = 0.936$, Duty factor = $10 * \log(1/0.936) = 0.29$

802.11ac (VHT80): Duty cycle = $0.334 \text{ ms} / 0.372 \text{ ms} = 0.898$, Duty factor = $10 * \log(1/0.898) = 0.47$

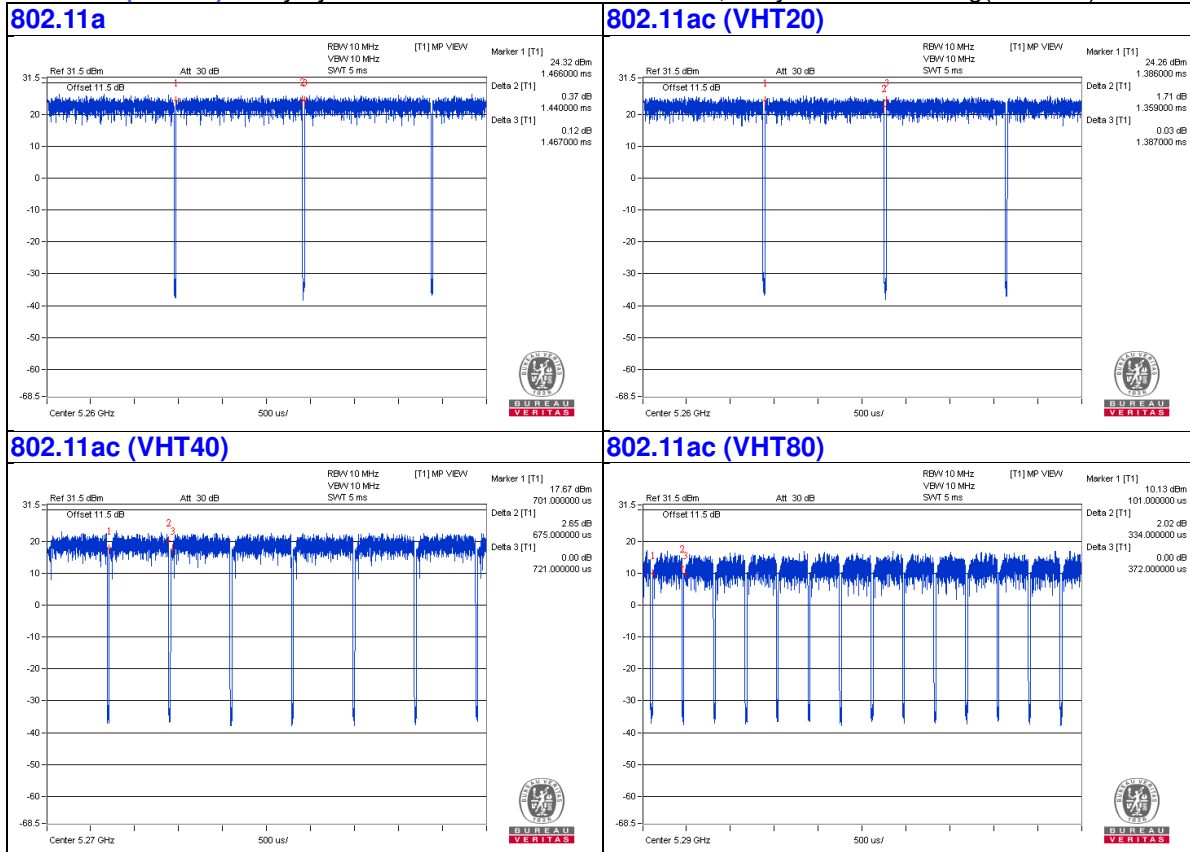

3.4 Description of Support Units

The EUT has been tested as an independent unit together with other necessary accessories or support units. The following support units or accessories were used to form a representative test configuration during the tests.

ID	Product	Brand	Model No.	Serial No.	FCC ID	Remarks
A.	Micro SD Card	SanDisk	NA	NA	NA	Provided by Lab

Note:

1. All power cords of the above support units are non-shielded (1.8m).

ID	Descriptions	Qty.	Length (m)	Shielding (Yes/No)	Cores (Qty.)	Remarks
1.	DC Cable	1	3	No	0	Supplied by client
2.	Console Cable	1	0.1	No	0	Supplied by client(for RF Setup)

3.4.1 Configuration of System under Test

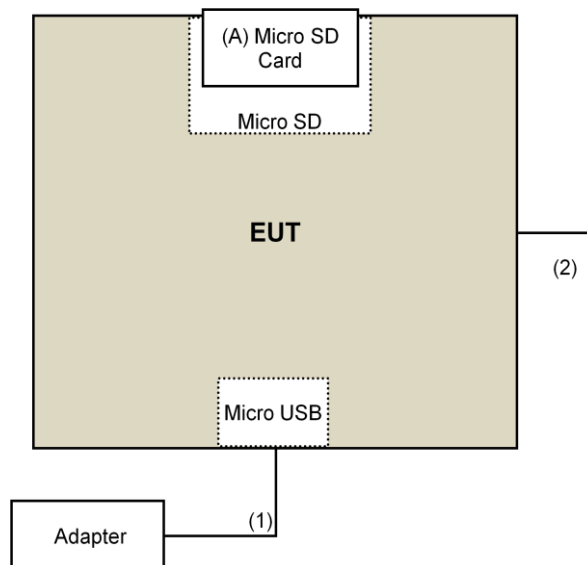

3.5 General Description of Applied Standard

The EUT is a RF Product. According to the specifications of the manufacturer, it must comply with the requirements of the following standards:

FCC Part 15, Subpart E (15.407)
KDB 789033 D02 General UNII Test Procedure New Rules v01r03
ANSI C63.10-2013

All test items have been performed and recorded as per the above standards.

NOTE: The EUT has been verified to comply with the requirements of FCC Part 15, Subpart B, Class B (DoC). The test report has been issued separately.

4 Test Types and Results

4.1 Radiated Emission and Bandedge Measurement

4.1.1 Limits of Radiated Emission and Bandedge Measurement

Radiated emissions which fall in the restricted bands must comply with the radiated emission limits specified as below table.

Frequencies (MHz)	Field Strength (microvolts/meter)	Measurement Distance (meters)
0.009 ~ 0.490	2400/F(kHz)	300
0.490 ~ 1.705	24000/F(kHz)	30
1.705 ~ 30.0	30	30
30 ~ 88	100	3
88 ~ 216	150	3
216 ~ 960	200	3
Above 960	500	3

NOTE:

1. The lower limit shall apply at the transition frequencies.
2. Emission level (dBuV/m) = 20 log Emission level (uV/m).
3. For frequencies above 1000MHz, the field strength limits are based on average detector, however, the peak field strength of any emission shall not exceed the maximum permitted average limits, specified above by more than 20dB under any condition of modulation.

Limits of unwanted emission out of the restricted bands

Applicable To		Limit	
789033 D02 General UNII Test Procedure New Rules v01r03		Field Strength at 3m	
		PK:74 (dBμV/m)	AV:54 (dBμV/m)
Frequency Band	Applicable To	EIRP Limit	Equivalent Field Strength at 3m
5150~5250 MHz	15.407(b)(1)	PK:-27 (dBm/MHz)	PK:68.2(dBμV/m)
5250~5350 MHz	15.407(b)(2)		
5470~5725 MHz	15.407(b)(3)		
5725~5850 MHz	<input type="checkbox"/> 15.407(b)(4)(i)	PK:-27 (dBm/MHz) ^{*1} PK:10 (dBm/MHz) ^{*2} PK:15.6 (dBm/MHz) ^{*3} PK:27 (dBm/MHz) ^{*4}	PK: 68.2(dBμV/m) ^{*1} PK:105.2 (dBμV/m) ^{*2} PK: 110.8(dBμV/m) ^{*3} PK:122.2 (dBμV/m) ^{*4}
	<input type="checkbox"/> 15.407(b)(4)(ii)	Emission limits in section 15.247(d)	
^{*1} beyond 75 MHz or more above of the band edge.		^{*2} below the band edge increasing linearly to 10 dBm/MHz at 25 MHz above.	
^{*3} below the band edge increasing linearly to a level of 15.6 dBm/MHz at 5 MHz above.		^{*4} from 5 MHz above or below the band edge increasing linearly to a level of 27 dBm/MHz at the band edge.	

Note:

The following formula is used to convert the equipment isotropic radiated power (eirp) to field strength:

$$E = \frac{1000000\sqrt{30P}}{3} \mu\text{V/m, where } P \text{ is the eirp (Watts).}$$

4.1.2 Test Instruments

DESCRIPTION & MANUFACTURER	MODEL NO.	SERIAL NO.	CALIBRATED DATE	CALIBRATED UNTIL
Test Receiver Keysight	N9038A	MY54450088	July 20, 2016	July 19, 2017
Pre-Amplifier ^(*) EMCI	EMC001340	980142	Jan. 20, 2016	Jan. 19, 2018
Loop Antenna ^(*) Electro-Metrics	EM-6879	264	Dec. 16, 2016	Dec. 15, 2018
RF Cable	NA	LOOPCAB-001 LOOPCAB-002	Jan. 17, 2017	Jan. 16, 2018
Pre-Amplifier Mini-Circuits	ZFL-1000VH2B	AMP-ZFL-01	Nov. 10, 2016	Nov. 09, 2017
Trilog Broadband Antenna SCHWARZBECK	VULB 9168	9168-406	Dec. 13, 2016	Dec. 12, 2017
RF Cable	8D	966-4-1 966-4-2 966-4-3	Apr. 02, 2016	Apr. 01, 2017
Fixed attenuator Mini-Circuits	UNAT-5+	PAD-3m-4-01	Oct. 05, 2016	Oct. 04, 2017
Horn_Antenna SCHWARZBECK	BBHA 9120D	9120D-783	Dec. 27, 2016	Dec. 26, 2017
Pre-Amplifier EMCI	EMC12630SE	980385	Feb. 02, 2017	Feb. 01, 2018
RF Cable	EMC104-SM-SM-2000 EMC104-SM-SM-5000 EMC104-SM-SM-5000	160923 150318 150323	Feb. 02, 2017 Mar. 30, 2016 Mar. 30, 2016	Feb. 01, 2018 Mar. 29, 2017 Mar. 29, 2017
Pre-Amplifier EMCI	EMC184045SE	980387	Feb. 02, 2017	Feb. 01, 2018
Horn_Antenna SCHWARZBECK	BBHA 9170	BBHA9170608	Dec. 15, 2016	Dec. 14, 2017
RF Cable	SUCOFLEX 102	36432/2 36433/2	Jan. 15, 2017	Jan. 14, 2018
Software	ADT_Radiated_V8.7.08	NA	NA	NA
Antenna Tower & Turn Table Max-Full	MF-7802	MF780208410	NA	NA
Boresight Antenna Fixture	FBA-01	FBA-SIP02	NA	NA
Spectrum Analyzer R&S	FSv40	100964	June 28, 2016	June 27, 2017
Power meter Anritsu	ML2495A	1014008	May 5, 2016	May 4, 2017
Power sensor Anritsu	MA2411B	0917122	May 5, 2016	May 4, 2017
AC Power Source Extech Electronics	6205	1440452	NA	NA
Temperature & Humidity Chamber Giant Force	GTH-150-40-SP-AR	MAA0812-008	Jan. 11, 2017	Jan. 10, 2018
Digital Multimeter FLUKE	87III	73680266	Nov. 10, 2016	Nov. 09, 2017

Note:

1. The calibration interval of the above test instruments is 12 months and the calibrations are traceable to NML/ROC and NIST/USA.
2. *The calibration interval of the above test instruments is 24 months and the calibrations are traceable to NML/ROC and NIST/USA.
- 3 Loop antenna was used for all emissions below 30 MHz.
4. The test was performed in 966 Chamber No. 4.
5. The FCC Site Registration No. is 292998
6. The CANADA Site Registration No. is 20331-2
7. Tested Date: Mar. 03, 2017

4.1.3 Test Procedure

For Radiated emission below 30MHz

- a. The EUT was placed on the top of a rotating table 0.8 meters above the ground at a 3 meter chamber room. The table was rotated 360 degrees to determine the position of the highest radiation.
- b. The EUT was set 3 meters away from the interference-receiving antenna, which was mounted on the top of a variable-height antenna tower.
- c. Both X and Y axes of the antenna are set to make the measurement.
- d. For each suspected emission, the EUT was arranged to its worst case and the rotatable table was turned from 0 degrees to 360 degrees to find the maximum reading.
- e. The test-receiver system was set to Quasi-Peak Detect Function and Specified Bandwidth with Maximum Hold Mode.

NOTE:

1. The resolution bandwidth and video bandwidth of test receiver/spectrum analyzer is 9kHz at frequency below 30MHz.

For Radiated emission above 30MHz

- a. The EUT was placed on the top of a rotating table 0.8 meters (for 30MHz ~ 1GHz) / 1.5 meters (for above 1GHz) above the ground at 3 meter chamber room for test. The table was rotated 360 degrees to determine the position of the highest radiation.
- b. The EUT was set 3 meters away from the interference-receiving antenna, which was mounted on the top of a variable-height antenna tower.
- c. The height of antenna is varied from one meter to four meters above the ground to determine the maximum value of the field strength. Both horizontal and vertical polarizations of the antenna are set to make the measurement.
- d. For each suspected emission, the EUT was arranged to its worst case and then the antenna was tuned to heights from 1 meter to 4 meters and the rotatable table was turned from 0 degrees to 360 degrees to find the maximum reading.
- e. The test-receiver system was set to quasi-peak detect function and specified bandwidth with maximum hold mode when the test frequency is below 1 GHz.
- f. The test-receiver system was set to peak and average detect function and specified bandwidth with maximum hold mode when the test frequency is above 1 GHz. If the peak reading value also meets average limit, measurement with the average detector is unnecessary.

Note:

1. The resolution bandwidth and video bandwidth of test receiver/spectrum analyzer is 120kHz for Quasi-peak detection (QP) at frequency below 1GHz.
2. The resolution bandwidth of test receiver/spectrum analyzer is 1 MHz and the video bandwidth is 3 MHz for Peak detection (PK) at frequency above 1GHz.
3. The resolution bandwidth of test receiver/spectrum analyzer is 1MHz and the video bandwidth is $\geq 1/T$ (Duty cycle < 98%) or 10Hz (Duty cycle $\geq 98\%$) for Average detection (AV) at frequency above 1GHz.
4. All modes of operation were investigated and the worst-case emissions are reported.

4.1.4 Deviation from Test Standard

No deviation.

4.1.5 Test Setup

For Radiated emission below 30MHz

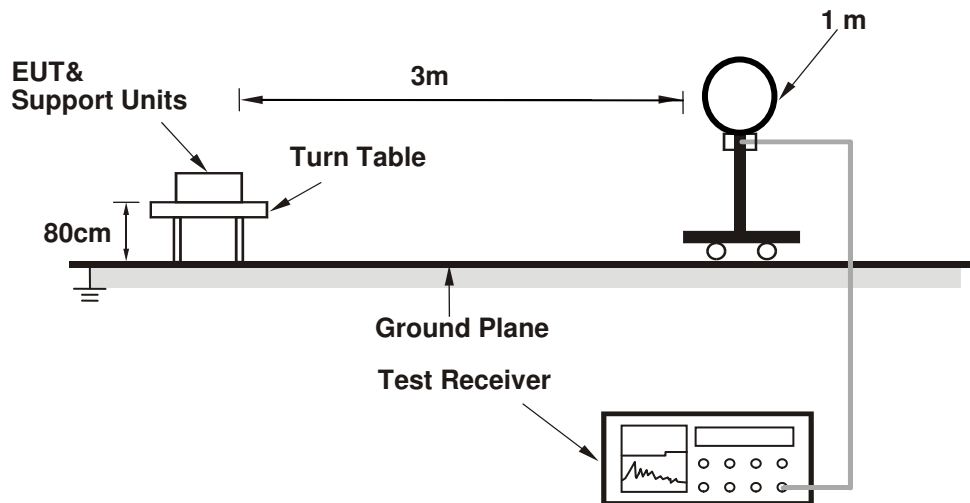

For Radiated emission 30MHz to 1GHz

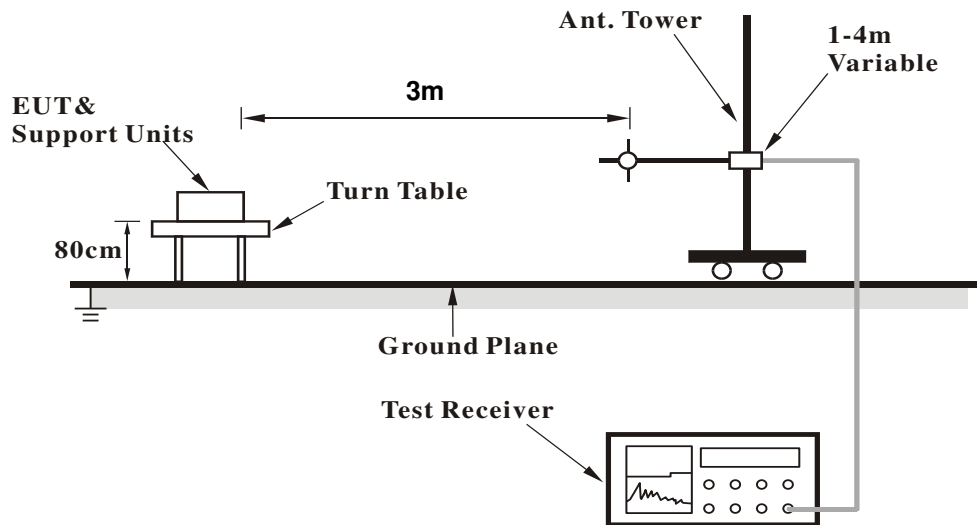

For Radiated emission above 1GHz

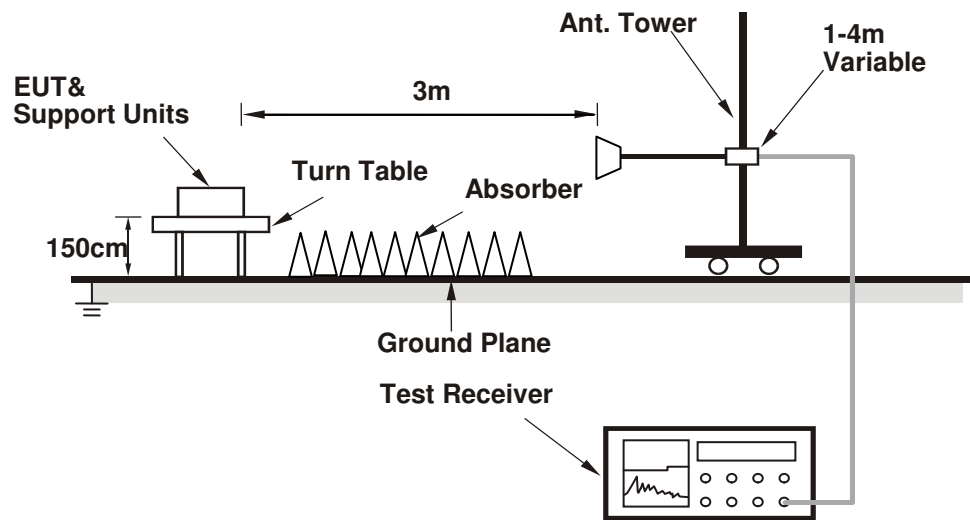

For the actual test configuration, please refer to the attached file (Test Setup Photo).

4.1.6 EUT Operating Condition

- a. Controlling software (MT76xxE QA[V2.0.10.3[1128]]) has been activated to set the EUT on specific status.

4.1.7 Test Results

Above 1GHz Data:

802.11a

CHANNEL	TX Channel 52	DETECTOR FUNCTION	Peak (PK)
FREQUENCY RANGE	1GHz ~ 40GHz		Average (AV)

ANTENNA POLARITY & TEST DISTANCE: HORIZONTAL AT 3 M

NO.	FREQ. (MHz)	EMISSION LEVEL (dBuV/m)	LIMIT (dBuV/m)	MARGIN (dB)	ANTENNA HEIGHT (m)	TABLE ANGLE (Degree)	RAW VALUE (dBuV)	CORRECTION FACTOR (dB/m)
1	4936.00	58.3 PK	74.0	-15.7	2.71 H	11	55.7	2.6
2	4936.00	46.1 AV	54.0	-7.9	2.71 H	11	43.5	2.6
3	*5260.00	118.2 PK			2.71 H	11	115.0	3.2
4	*5260.00	107.7 AV			2.71 H	11	104.5	3.2
5	5350.00	60.1 PK	74.0	-13.9	2.71 H	11	56.7	3.4
6	5350.00	47.0 AV	54.0	-7.0	2.71 H	11	43.6	3.4
7	#10520.00	60.9 PK	74.0	-13.1	1.55 H	19	48.6	12.3
8	#10520.00	49.6 AV	54.0	-4.4	1.55 H	19	37.3	12.3
9	15780.00	54.4 PK	74.0	-19.6	2.42 H	347	41.4	13.0
10	15780.00	42.4 AV	54.0	-11.6	2.42 H	347	29.4	13.0

ANTENNA POLARITY & TEST DISTANCE: VERTICAL AT 3 M

NO.	FREQ. (MHz)	EMISSION LEVEL (dBuV/m)	LIMIT (dBuV/m)	MARGIN (dB)	ANTENNA HEIGHT (m)	TABLE ANGLE (Degree)	RAW VALUE (dBuV)	CORRECTION FACTOR (dB/m)
1	4936.00	55.9 PK	74.0	-18.1	2.07 V	34	53.3	2.6
2	4936.00	43.4 AV	54.0	-10.6	2.07 V	34	40.8	2.6
3	*5260.00	118.6 PK			2.07 V	34	115.4	3.2
4	*5260.00	108.1 AV			2.07 V	34	104.9	3.2
5	5350.00	60.4 PK	74.0	-13.6	2.07 V	34	57.0	3.4
6	5350.00	47.2 AV	54.0	-6.8	2.07 V	34	43.8	3.4
7	#10520.00	63.4 PK	74.0	-10.6	1.00 V	125	51.1	12.3
8	#10520.00	49.9 AV	54.0	-4.1	1.00 V	125	37.6	12.3
9	15780.00	50.6 PK	74.0	-23.4	3.06 V	97	37.6	13.0
10	15780.00	39.9 AV	54.0	-14.1	3.06 V	97	26.9	13.0

REMARKS:

1. Emission Level(dBuV/m) = Raw Value(dBuV) + Correction Factor(dB/m)
2. Correction Factor(dB/m) = Antenna Factor(dB/m) + Cable Factor(dB) – Pre-Amplifier Factor(dB)
3. The other emission levels were very low against the limit.
4. Margin value = Emission Level – Limit value
5. " * " : Fundamental frequency.
6. " # " : The radiated frequency is out of the restricted band.

CHANNEL	TX Channel 60	DETECTOR FUNCTION	Peak (PK)
FREQUENCY RANGE	1GHz ~ 40GHz		Average (AV)

ANTENNA POLARITY & TEST DISTANCE: HORIZONTAL AT 3 M

NO.	FREQ. (MHz)	EMISSION LEVEL (dBuV/m)	LIMIT (dBuV/m)	MARGIN (dB)	ANTENNA HEIGHT (m)	TABLE ANGLE (Degree)	RAW VALUE (dBuV)	CORRECTION FACTOR (dB/m)
1	4908.00	55.6 PK	74.0	-18.4	2.71 H	11	53.2	2.4
2	4908.00	43.8 AV	54.0	-10.2	2.71 H	11	41.4	2.4
3	*5300.00	117.3 PK			2.71 H	11	114.1	3.2
4	*5300.00	106.7 AV			2.71 H	11	103.5	3.2
5	5350.00	68.1 PK	74.0	-5.9	2.71 H	11	64.7	3.4
6	5350.00	53.6 AV	54.0	-0.4	2.71 H	11	50.2	3.4
7	10600.00	58.7 PK	74.0	-15.3	1.50 H	15	46.2	12.5
8	10600.00	47.3 AV	54.0	-6.7	1.50 H	15	34.8	12.5
9	15900.00	52.3 PK	74.0	-21.7	2.37 H	345	39.9	12.4
10	15900.00	40.1 AV	54.0	-13.9	2.37 H	345	27.7	12.4

ANTENNA POLARITY & TEST DISTANCE: VERTICAL AT 3 M

NO.	FREQ. (MHz)	EMISSION LEVEL (dBuV/m)	LIMIT (dBuV/m)	MARGIN (dB)	ANTENNA HEIGHT (m)	TABLE ANGLE (Degree)	RAW VALUE (dBuV)	CORRECTION FACTOR (dB/m)
1	4908.00	53.6 PK	74.0	-20.4	2.07 V	35	51.2	2.4
2	4908.00	41.8 AV	54.0	-12.2	2.07 V	35	39.4	2.4
3	*5300.00	117.6 PK			2.07 V	35	114.4	3.2
4	*5300.00	107.0 AV			2.07 V	35	103.8	3.2
5	5350.00	68.9 PK	74.0	-5.1	2.07 V	35	65.5	3.4
6	5350.00	53.3 AV	54.0	-0.7	2.07 V	35	49.9	3.4
7	10600.00	61.4 PK	74.0	-12.6	1.00 V	135	48.9	12.5
8	10600.00	47.7 AV	54.0	-6.3	1.00 V	135	35.2	12.5
9	15900.00	48.5 PK	74.0	-25.5	3.01 V	101	36.1	12.4
10	15900.00	37.6 AV	54.0	-16.4	3.01 V	101	25.2	12.4

REMARKS:

1. Emission Level(dBuV/m) = Raw Value(dBuV) + Correction Factor(dB/m)
2. Correction Factor(dB/m) = Antenna Factor(dB/m) + Cable Factor(dB) – Pre-Amplifier Factor(dB)
3. The other emission levels were very low against the limit.
4. Margin value = Emission Level – Limit value
5. " * ": Fundamental frequency.

CHANNEL	TX Channel 64	DETECTOR FUNCTION	Peak (PK)
FREQUENCY RANGE	1GHz ~ 40GHz		Average (AV)

ANTENNA POLARITY & TEST DISTANCE: HORIZONTAL AT 3 M

NO.	FREQ. (MHz)	EMISSION LEVEL (dBuV/m)	LIMIT (dBuV/m)	MARGIN (dB)	ANTENNA HEIGHT (m)	TABLE ANGLE (Degree)	RAW VALUE (dBuV)	CORRECTION FACTOR (dB/m)
1	4930.00	52.3 PK	74.0	-21.7	2.69 H	15	49.7	2.6
2	4930.00	40.2 AV	54.0	-13.8	2.69 H	15	37.6	2.6
3	*5320.00	113.7 PK			2.69 H	15	110.5	3.2
4	*5320.00	102.3 AV			2.69 H	15	99.1	3.2
5	5350.00	68.2 PK	74.0	-5.8	2.69 H	15	64.8	3.4
6	5350.00	53.4 AV	54.0	-0.6	2.69 H	15	50.0	3.4
7	10640.00	56.5 PK	74.0	-17.5	1.53 H	6	43.9	12.6
8	10640.00	46.1 AV	54.0	-7.9	1.53 H	6	33.5	12.6
9	15960.00	49.6 PK	74.0	-24.4	2.37 H	357	37.2	12.4
10	15960.00	39.8 AV	54.0	-14.2	2.37 H	357	27.4	12.4

ANTENNA POLARITY & TEST DISTANCE: VERTICAL AT 3 M

NO.	FREQ. (MHz)	EMISSION LEVEL (dBuV/m)	LIMIT (dBuV/m)	MARGIN (dB)	ANTENNA HEIGHT (m)	TABLE ANGLE (Degree)	RAW VALUE (dBuV)	CORRECTION FACTOR (dB/m)
1	4930.00	50.3 PK	74.0	-23.7	1.92 V	31	47.7	2.6
2	4930.00	39.1 AV	54.0	-14.9	1.92 V	31	36.5	2.6
3	*5320.00	114.0 PK			1.92 V	31	110.8	3.2
4	*5320.00	102.9 AV			1.92 V	31	99.7	3.2
5	5350.00	69.3 PK	74.0	-4.7	1.92 V	31	65.9	3.4
6	5350.00	53.8 AV	54.0	-0.2	1.92 V	31	50.4	3.4
7	10640.00	58.2 PK	74.0	-15.8	1.00 V	113	45.6	12.6
8	10640.00	44.6 AV	54.0	-9.4	1.00 V	113	32.0	12.6
9	15960.00	45.4 PK	74.0	-28.6	3.02 V	111	33.0	12.4
10	15960.00	35.1 AV	54.0	-18.9	3.02 V	111	22.7	12.4

REMARKS:

1. Emission Level(dBuV/m) = Raw Value(dBuV) + Correction Factor(dB/m)
2. Correction Factor(dB/m) = Antenna Factor(dB/m) + Cable Factor(dB) – Pre-Amplifier Factor(dB)
3. The other emission levels were very low against the limit.
4. Margin value = Emission Level – Limit value
5. " * ": Fundamental frequency.

CHANNEL	TX Channel 100	DETECTOR FUNCTION	Peak (PK)
FREQUENCY RANGE	1GHz ~ 40GHz		Average (AV)

ANTENNA POLARITY & TEST DISTANCE: HORIZONTAL AT 3 M

NO.	FREQ. (MHz)	EMISSION LEVEL (dBuV/m)	LIMIT (dBuV/m)	MARGIN (dB)	ANTENNA HEIGHT (m)	TABLE ANGLE (Degree)	RAW VALUE (dBuV)	CORRECTION FACTOR (dB/m)
1	4933.00	53.2 PK	74.0	-20.8	2.72 H	12	50.6	2.6
2	4933.00	40.2 AV	54.0	-13.8	2.72 H	12	37.6	2.6
3	#5470.00	69.2 PK	74.0	-4.8	2.72 H	12	65.7	3.5
4	#5470.00	53.4 AV	54.0	-0.6	2.72 H	12	49.9	3.5
5	*5500.00	111.6 PK			2.72 H	12	108.1	3.5
6	*5500.00	101.7 AV			2.72 H	12	98.2	3.5
7	11000.00	57.2 PK	74.0	-16.8	1.49 H	360	43.8	13.4
8	11000.00	45.4 AV	54.0	-8.6	1.49 H	360	32.0	13.4
9	#16500.00	46.7 PK	74.0	-27.3	2.15 H	72	32.2	14.5
10	#16500.00	34.3 AV	54.0	-19.7	2.15 H	72	19.8	14.5

ANTENNA POLARITY & TEST DISTANCE: VERTICAL AT 3 M

NO.	FREQ. (MHz)	EMISSION LEVEL (dBuV/m)	LIMIT (dBuV/m)	MARGIN (dB)	ANTENNA HEIGHT (m)	TABLE ANGLE (Degree)	RAW VALUE (dBuV)	CORRECTION FACTOR (dB/m)
1	4933.00	50.3 PK	74.0	-23.7	1.83 V	50	47.7	2.6
2	4933.00	38.1 AV	54.0	-15.9	1.83 V	50	35.5	2.6
3	#5470.00	69.9 PK	74.0	-4.1	1.83 V	50	66.4	3.5
4	#5470.00	53.6 AV	54.0	-0.4	1.83 V	50	50.1	3.5
5	*5500.00	112.0 PK			1.83 V	50	108.5	3.5
6	*5500.00	102.0 AV			1.83 V	50	98.5	3.5
7	11000.00	59.6 PK	74.0	-14.4	1.01 V	97	46.2	13.4
8	11000.00	47.5 AV	54.0	-6.5	1.01 V	97	34.1	13.4
9	#16500.00	48.8 PK	74.0	-25.2	1.43 V	345	34.3	14.5
10	#16500.00	36.8 AV	54.0	-17.2	1.43 V	345	22.3	14.5

REMARKS:

- Emission Level(dBuV/m) = Raw Value(dBuV) + Correction Factor(dB/m)
- Correction Factor(dB/m) = Antenna Factor(dB/m) + Cable Factor(dB) – Pre-Amplifier Factor(dB)
- The other emission levels were very low against the limit.
- Margin value = Emission Level – Limit value
- " * ": Fundamental frequency.
- " # ": The radiated frequency is out of the restricted band.

CHANNEL	TX Channel 116	DETECTOR FUNCTION	Peak (PK)
FREQUENCY RANGE	1GHz ~ 40GHz		Average (AV)

ANTENNA POLARITY & TEST DISTANCE: HORIZONTAL AT 3 M

NO.	FREQ. (MHz)	EMISSION LEVEL (dBuV/m)	LIMIT (dBuV/m)	MARGIN (dB)	ANTENNA HEIGHT (m)	TABLE ANGLE (Degree)	RAW VALUE (dBuV)	CORRECTION FACTOR (dB/m)
1	*5580.00	116.2 PK			2.70 H	11	112.6	3.6
2	*5580.00	105.8 AV			2.70 H	11	102.2	3.6
3	#5725.00	54.2 PK	74.0	-19.8	2.70 H	11	50.2	4.0
4	#5725.00	42.1 AV	54.0	-11.9	2.70 H	11	38.1	4.0
5	11160.00	58.8 PK	74.0	-15.2	1.49 H	360	45.9	12.9
6	11160.00	47.2 AV	54.0	-6.8	1.49 H	360	34.3	12.9
7	#16740.00	58.0 PK	74.0	-16.0	2.17 H	63	42.4	15.6
8	#16740.00	46.9 AV	54.0	-7.1	2.17 H	63	31.3	15.6

ANTENNA POLARITY & TEST DISTANCE: VERTICAL AT 3 M

NO.	FREQ. (MHz)	EMISSION LEVEL (dBuV/m)	LIMIT (dBuV/m)	MARGIN (dB)	ANTENNA HEIGHT (m)	TABLE ANGLE (Degree)	RAW VALUE (dBuV)	CORRECTION FACTOR (dB/m)
1	*5580.00	117.2 PK			1.82 V	50	113.6	3.6
2	*5580.00	106.1 AV			1.82 V	50	102.5	3.6
3	#5725.00	54.7 PK	74.0	-19.3	1.82 V	50	50.7	4.0
4	#5725.00	42.6 AV	54.0	-11.4	1.82 V	50	38.6	4.0
5	11160.00	65.0 PK	74.0	-9.0	1.00 V	106	52.1	12.9
6	11160.00	52.5 AV	54.0	-1.5	1.00 V	106	39.6	12.9
7	#16740.00	53.8 PK	74.0	-20.2	1.45 V	353	38.2	15.6
8	#16740.00	41.8 AV	54.0	-12.2	1.45 V	353	26.2	15.6

REMARKS:

1. Emission Level(dBuV/m) = Raw Value(dBuV) + Correction Factor(dB/m)
2. Correction Factor(dB/m) = Antenna Factor(dB/m) + Cable Factor(dB) – Pre-Amplifier Factor(dB)
3. The other emission levels were very low against the limit.
4. Margin value = Emission Level – Limit value
5. " * ": Fundamental frequency.
6. " # ": The radiated frequency is out of the restricted band.

CHANNEL	TX Channel 140	DETECTOR FUNCTION	Peak (PK)
FREQUENCY RANGE	1GHz ~ 40GHz		Average (AV)

ANTENNA POLARITY & TEST DISTANCE: HORIZONTAL AT 3 M

NO.	FREQ. (MHz)	EMISSION LEVEL (dBuV/m)	LIMIT (dBuV/m)	MARGIN (dB)	ANTENNA HEIGHT (m)	TABLE ANGLE (Degree)	RAW VALUE (dBuV)	CORRECTION FACTOR (dB/m)
1	*5700.00	109.1 PK			2.75 H	15	105.2	3.9
2	*5700.00	99.1 AV			2.75 H	15	95.2	3.9
3	#5725.00	68.2 PK	74.0	-5.8	2.75 H	15	64.2	4.0
4	#5725.00	53.1 AV	54.0	-0.9	2.75 H	15	49.1	4.0
5	11400.00	47.5 PK	74.0	-26.5	1.51 H	360	34.5	13.0
6	11400.00	34.4 AV	54.0	-19.6	1.51 H	360	21.4	13.0
7	#17100.00	47.3 PK	74.0	-26.7	2.22 H	56	29.9	17.4
8	#17100.00	33.6 AV	54.0	-20.4	2.22 H	56	16.2	17.4

ANTENNA POLARITY & TEST DISTANCE: VERTICAL AT 3 M

NO.	FREQ. (MHz)	EMISSION LEVEL (dBuV/m)	LIMIT (dBuV/m)	MARGIN (dB)	ANTENNA HEIGHT (m)	TABLE ANGLE (Degree)	RAW VALUE (dBuV)	CORRECTION FACTOR (dB/m)
1	*5700.00	109.9 PK			1.76 V	34	106.0	3.9
2	*5700.00	99.4 AV			1.76 V	34	95.5	3.9
3	#5725.00	69.8 PK	74.0	-4.2	1.76 V	34	65.8	4.0
4	#5725.00	53.5 AV	54.0	-0.5	1.76 V	34	49.5	4.0
5	11400.00	47.2 PK	74.0	-26.8	1.02 V	117	34.2	13.0
6	11400.00	34.2 AV	54.0	-19.8	1.02 V	117	21.2	13.0
7	#17100.00	46.5 PK	74.0	-27.5	1.43 V	357	29.1	17.4
8	#17100.00	33.1 AV	54.0	-20.9	1.43 V	357	15.7	17.4

REMARKS:

1. Emission Level(dBuV/m) = Raw Value(dBuV) + Correction Factor(dB/m)
2. Correction Factor(dB/m) = Antenna Factor(dB/m) + Cable Factor(dB) – Pre-Amplifier Factor(dB)
3. The other emission levels were very low against the limit.
4. Margin value = Emission Level – Limit value
5. " * ": Fundamental frequency.
6. " # ": The radiated frequency is out of the restricted band.

802.11ac (VHT20)

CHANNEL	TX Channel 52	DETECTOR FUNCTION	Peak (PK)
FREQUENCY RANGE	1GHz ~ 40GHz		Average (AV)

ANTENNA POLARITY & TEST DISTANCE: HORIZONTAL AT 3 M

NO.	FREQ. (MHz)	EMISSION LEVEL (dBuV/m)	LIMIT (dBuV/m)	MARGIN (dB)	ANTENNA HEIGHT (m)	TABLE ANGLE (Degree)	RAW VALUE (dBuV)	CORRECTION FACTOR (dB/m)
1	4944.00	57.5 PK	74.0	-16.5	2.70 H	48	54.9	2.6
2	4944.00	46.2 AV	54.0	-7.8	2.70 H	48	43.6	2.6
3	*5260.00	116.0 PK			2.70 H	48	112.8	3.2
4	*5260.00	105.2 AV			2.70 H	48	102.0	3.2
5	5350.00	58.9 PK	74.0	-15.1	2.70 H	48	55.5	3.4
6	5350.00	45.5 AV	54.0	-8.5	2.70 H	48	42.1	3.4
7	#10520.00	61.0 PK	74.0	-13.0	1.64 H	23	48.7	12.3
8	#10520.00	48.7 AV	54.0	-5.3	1.64 H	23	36.4	12.3
9	15780.00	58.9 PK	74.0	-15.1	3.12 H	159	45.9	13.0
10	15780.00	47.4 AV	54.0	-6.6	3.12 H	159	34.4	13.0

ANTENNA POLARITY & TEST DISTANCE: VERTICAL AT 3 M

NO.	FREQ. (MHz)	EMISSION LEVEL (dBuV/m)	LIMIT (dBuV/m)	MARGIN (dB)	ANTENNA HEIGHT (m)	TABLE ANGLE (Degree)	RAW VALUE (dBuV)	CORRECTION FACTOR (dB/m)
1	4944.00	54.3 PK	74.0	-19.7	2.07 V	44	51.7	2.6
2	4944.00	41.5 AV	54.0	-12.5	2.07 V	44	38.9	2.6
3	*5260.00	114.3 PK			2.07 V	44	111.1	3.2
4	*5260.00	103.8 AV			2.07 V	44	100.6	3.2
5	5350.00	57.3 PK	74.0	-16.7	2.07 V	44	53.9	3.4
6	5350.00	44.3 AV	54.0	-9.7	2.07 V	44	40.9	3.4
7	#10520.00	62.5 PK	74.0	-11.5	1.03 V	123	50.2	12.3
8	#10520.00	50.6 AV	54.0	-3.4	1.03 V	123	38.3	12.3
9	15780.00	54.0 PK	74.0	-20.0	3.98 V	353	41.0	13.0
10	15780.00	42.8 AV	54.0	-11.2	3.98 V	353	29.8	13.0

REMARKS:

1. Emission Level(dBuV/m) = Raw Value(dBuV) + Correction Factor(dB/m)
2. Correction Factor(dB/m) = Antenna Factor(dB/m) + Cable Factor(dB) – Pre-Amplifier Factor(dB)
3. The other emission levels were very low against the limit.
4. Margin value = Emission Level – Limit value
5. " * ": Fundamental frequency.
6. " # ": The radiated frequency is out of the restricted band.

CHANNEL	TX Channel 60	DETECTOR FUNCTION	Peak (PK)
FREQUENCY RANGE	1GHz ~ 40GHz		Average (AV)

ANTENNA POLARITY & TEST DISTANCE: HORIZONTAL AT 3 M

NO.	FREQ. (MHz)	EMISSION LEVEL (dBuV/m)	LIMIT (dBuV/m)	MARGIN (dB)	ANTENNA HEIGHT (m)	TABLE ANGLE (Degree)	RAW VALUE (dBuV)	CORRECTION FACTOR (dB/m)
1	*5300.00	115.4 PK			2.62 H	43	112.2	3.2
2	*5300.00	104.8 AV			2.62 H	43	101.6	3.2
3	5350.00	67.5 PK	74.0	-6.5	2.62 H	43	64.1	3.4
4	5350.00	53.9 AV	54.0	-0.1	2.62 H	43	50.5	3.4
5	10600.00	59.1 PK	74.0	-14.9	1.66 H	37	46.6	12.5
6	10600.00	46.5 AV	54.0	-7.5	1.66 H	37	34.0	12.5
7	15900.00	56.8 PK	74.0	-17.2	3.15 H	167	44.4	12.4
8	15900.00	45.0 AV	54.0	-9.0	3.15 H	167	32.6	12.4

ANTENNA POLARITY & TEST DISTANCE: VERTICAL AT 3 M

NO.	FREQ. (MHz)	EMISSION LEVEL (dBuV/m)	LIMIT (dBuV/m)	MARGIN (dB)	ANTENNA HEIGHT (m)	TABLE ANGLE (Degree)	RAW VALUE (dBuV)	CORRECTION FACTOR (dB/m)
1	*5300.00	114.4 PK			3.00 V	77	111.2	3.2
2	*5300.00	104.1 AV			3.00 V	77	100.9	3.2
3	5350.00	67.7 PK	74.0	-6.3	3.00 V	77	64.3	3.4
4	5350.00	53.8 AV	54.0	-0.2	3.00 V	77	50.4	3.4
5	10600.00	59.3 PK	74.0	-14.7	1.03 V	136	46.8	12.5
6	10600.00	48.2 AV	54.0	-5.8	1.03 V	136	35.7	12.5
7	15900.00	51.8 PK	74.0	-22.2	3.94 V	360	39.4	12.4
8	15900.00	40.7 AV	54.0	-13.3	3.94 V	360	28.3	12.4

REMARKS:

1. Emission Level(dBuV/m) = Raw Value(dBuV) + Correction Factor(dB/m)
2. Correction Factor(dB/m) = Antenna Factor(dB/m) + Cable Factor(dB) – Pre-Amplifier Factor(dB)
3. The other emission levels were very low against the limit.
4. Margin value = Emission Level – Limit value
5. " * ": Fundamental frequency.

CHANNEL	TX Channel 64	DETECTOR FUNCTION	Peak (PK)
FREQUENCY RANGE	1GHz ~ 40GHz		Average (AV)

ANTENNA POLARITY & TEST DISTANCE: HORIZONTAL AT 3 M

NO.	FREQ. (MHz)	EMISSION LEVEL (dBuV/m)	LIMIT (dBuV/m)	MARGIN (dB)	ANTENNA HEIGHT (m)	TABLE ANGLE (Degree)	RAW VALUE (dBuV)	CORRECTION FACTOR (dB/m)
1	*5320.00	110.4 PK			2.80 H	48	107.2	3.2
2	*5320.00	100.4 AV			2.80 H	48	97.2	3.2
3	5350.00	70.2 PK	74.0	-3.8	2.80 H	48	66.8	3.4
4	5350.00	53.6 AV	54.0	-0.4	2.80 H	48	50.2	3.4
5	10640.00	56.1 PK	74.0	-17.9	1.68 H	33	43.5	12.6
6	10640.00	43.7 AV	54.0	-10.3	1.68 H	33	31.1	12.6
7	15960.00	54.5 PK	74.0	-19.5	3.09 H	181	42.1	12.4
8	15960.00	42.6 AV	54.0	-11.4	3.09 H	181	30.2	12.4

ANTENNA POLARITY & TEST DISTANCE: VERTICAL AT 3 M

NO.	FREQ. (MHz)	EMISSION LEVEL (dBuV/m)	LIMIT (dBuV/m)	MARGIN (dB)	ANTENNA HEIGHT (m)	TABLE ANGLE (Degree)	RAW VALUE (dBuV)	CORRECTION FACTOR (dB/m)
1	*5320.00	110.3 PK			2.68 V	46	107.1	3.2
2	*5320.00	100.1 AV			2.68 V	46	96.9	3.2
3	5350.00	68.5 PK	74.0	-5.5	2.68 V	46	65.1	3.4
4	5350.00	53.1 AV	54.0	-0.9	2.68 V	46	49.7	3.4
5	10640.00	57.2 PK	74.0	-16.8	1.00 V	151	44.6	12.6
6	10640.00	46.2 AV	54.0	-7.8	1.00 V	151	33.6	12.6
7	15960.00	49.8 PK	74.0	-24.2	3.91 V	360	37.4	12.4
8	15960.00	36.8 AV	54.0	-17.2	3.91 V	360	24.4	12.4

REMARKS:

1. Emission Level(dBuV/m) = Raw Value(dBuV) + Correction Factor(dB/m)
2. Correction Factor(dB/m) = Antenna Factor(dB/m) + Cable Factor(dB) – Pre-Amplifier Factor(dB)
3. The other emission levels were very low against the limit.
4. Margin value = Emission Level – Limit value
5. " * ": Fundamental frequency.

CHANNEL	TX Channel 100	DETECTOR FUNCTION	Peak (PK)
FREQUENCY RANGE	1GHz ~ 40GHz		Average (AV)

ANTENNA POLARITY & TEST DISTANCE: HORIZONTAL AT 3 M

NO.	FREQ. (MHz)	EMISSION LEVEL (dBuV/m)	LIMIT (dBuV/m)	MARGIN (dB)	ANTENNA HEIGHT (m)	TABLE ANGLE (Degree)	RAW VALUE (dBuV)	CORRECTION FACTOR (dB/m)
1	#5470.00	69.7 PK	74.0	-4.3	2.14 H	31	66.2	3.5
2	#5470.00	53.6 AV	54.0	-0.4	2.14 H	31	50.1	3.5
3	*5500.00	110.4 PK			2.14 H	31	106.9	3.5
4	*5500.00	100.3 AV			2.14 H	31	96.8	3.5
5	11000.00	47.7 PK	74.0	-26.3	1.45 H	360	34.3	13.4
6	11000.00	34.5 AV	54.0	-19.5	1.45 H	360	21.1	13.4
7	#16500.00	46.9 PK	74.0	-27.1	2.26 H	67	32.4	14.5
8	#16500.00	33.4 AV	54.0	-20.6	2.26 H	67	18.9	14.5

ANTENNA POLARITY & TEST DISTANCE: VERTICAL AT 3 M

NO.	FREQ. (MHz)	EMISSION LEVEL (dBuV/m)	LIMIT (dBuV/m)	MARGIN (dB)	ANTENNA HEIGHT (m)	TABLE ANGLE (Degree)	RAW VALUE (dBuV)	CORRECTION FACTOR (dB/m)
1	#5470.00	68.9 PK	74.0	-5.1	2.90 V	75	65.4	3.5
2	#5470.00	53.8 AV	54.0	-0.2	2.90 V	75	50.3	3.5
3	*5500.00	110.8 PK			2.90 V	75	107.3	3.5
4	*5500.00	101.2 AV			2.90 V	75	97.7	3.5
5	11000.00	47.4 PK	74.0	-26.6	1.07 V	106	34.0	13.4
6	11000.00	34.4 AV	54.0	-19.6	1.07 V	106	21.0	13.4
7	#16500.00	46.7 PK	74.0	-27.3	1.48 V	358	32.2	14.5
8	#16500.00	33.3 AV	54.0	-20.7	1.48 V	358	18.8	14.5

REMARKS:

1. Emission Level(dBuV/m) = Raw Value(dBuV) + Correction Factor(dB/m)
2. Correction Factor(dB/m) = Antenna Factor(dB/m) + Cable Factor(dB) – Pre-Amplifier Factor(dB)
3. The other emission levels were very low against the limit.
4. Margin value = Emission Level – Limit value
5. " * ": Fundamental frequency.
6. " # ": The radiated frequency is out of the restricted band.

CHANNEL	TX Channel 116	DETECTOR FUNCTION	Peak (PK)
FREQUENCY RANGE	1GHz ~ 40GHz		Average (AV)

ANTENNA POLARITY & TEST DISTANCE: HORIZONTAL AT 3 M

NO.	FREQ. (MHz)	EMISSION LEVEL (dBuV/m)	LIMIT (dBuV/m)	MARGIN (dB)	ANTENNA HEIGHT (m)	TABLE ANGLE (Degree)	RAW VALUE (dBuV)	CORRECTION FACTOR (dB/m)
1	#5470.00	59.0 PK	74.0	-15.0	1.90 H	16	55.5	3.5
2	#5470.00	45.6 AV	54.0	-8.4	1.90 H	16	42.1	3.5
3	*5580.00	114.9 PK			1.90 H	16	111.3	3.6
4	*5580.00	104.2 AV			1.90 H	16	100.6	3.6
5	11160.00	61.0 PK	74.0	-13.0	1.64 H	23	48.1	12.9
6	11160.00	48.7 AV	54.0	-5.3	1.64 H	23	35.8	12.9
7	#16740.00	58.9 PK	74.0	-15.1	3.12 H	159	43.3	15.6
8	#16740.00	47.4 AV	54.0	-6.6	3.12 H	159	31.8	15.6

ANTENNA POLARITY & TEST DISTANCE: VERTICAL AT 3 M

NO.	FREQ. (MHz)	EMISSION LEVEL (dBuV/m)	LIMIT (dBuV/m)	MARGIN (dB)	ANTENNA HEIGHT (m)	TABLE ANGLE (Degree)	RAW VALUE (dBuV)	CORRECTION FACTOR (dB/m)
1	#5470.00	61.7 PK	74.0	-12.3	2.75 V	77	58.2	3.5
2	#5470.00	46.1 AV	54.0	-7.9	2.75 V	77	42.6	3.5
3	*5580.00	115.7 PK			2.75 V	77	112.1	3.6
4	*5580.00	105.1 AV			2.75 V	77	101.5	3.6
5	11160.00	63.2 PK	74.0	-10.8	1.00 V	112	50.3	12.9
6	11160.00	51.0 AV	54.0	-3.0	1.00 V	112	38.1	12.9
7	#16740.00	54.3 PK	74.0	-19.7	3.96 V	356	38.7	15.6
8	#16740.00	43.2 AV	54.0	-10.8	3.96 V	356	27.6	15.6

REMARKS:

1. Emission Level(dBuV/m) = Raw Value(dBuV) + Correction Factor(dB/m)
2. Correction Factor(dB/m) = Antenna Factor(dB/m) + Cable Factor(dB) – Pre-Amplifier Factor(dB)
3. The other emission levels were very low against the limit.
4. Margin value = Emission Level – Limit value
5. " * ": Fundamental frequency.
6. " # ": The radiated frequency is out of the restricted band.

CHANNEL	TX Channel 140	DETECTOR FUNCTION	Peak (PK)
FREQUENCY RANGE	1GHz ~ 40GHz		Average (AV)

ANTENNA POLARITY & TEST DISTANCE: HORIZONTAL AT 3 M

NO.	FREQ. (MHz)	EMISSION LEVEL (dBuV/m)	LIMIT (dBuV/m)	MARGIN (dB)	ANTENNA HEIGHT (m)	TABLE ANGLE (Degree)	RAW VALUE (dBuV)	CORRECTION FACTOR (dB/m)
1	*5700.00	108.4 PK			1.91 H	38	104.5	3.9
2	*5700.00	98.1 AV			1.91 H	38	94.2	3.9
3	#5725.00	71.6 PK	74.0	-2.4	1.91 H	38	67.6	4.0
4	#5725.00	53.5 AV	54.0	-0.5	1.91 H	38	49.5	4.0
5	11400.00	47.9 PK	74.0	-26.1	1.43 H	360	34.9	13.0
6	11400.00	34.6 AV	54.0	-19.4	1.43 H	360	21.6	13.0
7	#17100.00	47.0 PK	74.0	-27.0	2.22 H	67	29.6	17.4
8	#17100.00	33.2 AV	54.0	-20.8	2.22 H	67	15.8	17.4

ANTENNA POLARITY & TEST DISTANCE: VERTICAL AT 3 M

NO.	FREQ. (MHz)	EMISSION LEVEL (dBuV/m)	LIMIT (dBuV/m)	MARGIN (dB)	ANTENNA HEIGHT (m)	TABLE ANGLE (Degree)	RAW VALUE (dBuV)	CORRECTION FACTOR (dB/m)
1	*5700.00	108.6 PK			3.12 V	74	104.7	3.9
2	*5700.00	98.5 AV			3.12 V	74	94.6	3.9
3	#5725.00	72.0 PK	74.0	-2.0	3.12 V	74	68.0	4.0
4	#5725.00	53.7 AV	54.0	-0.3	3.12 V	74	49.7	4.0
5	11400.00	47.3 PK	74.0	-26.7	1.13 V	106	34.3	13.0
6	11400.00	34.4 AV	54.0	-19.6	1.13 V	106	21.4	13.0
7	#17100.00	46.8 PK	74.0	-27.2	1.54 V	357	29.4	17.4
8	#17100.00	33.4 AV	54.0	-20.6	1.54 V	357	16.0	17.4

REMARKS:

1. Emission Level(dBuV/m) = Raw Value(dBuV) + Correction Factor(dB/m)
2. Correction Factor(dB/m) = Antenna Factor(dB/m) + Cable Factor(dB) – Pre-Amplifier Factor(dB)
3. The other emission levels were very low against the limit.
4. Margin value = Emission Level – Limit value
5. " * ": Fundamental frequency.
6. " # ": The radiated frequency is out of the restricted band.

802.11ac (VHT40)

CHANNEL	TX Channel 54	DETECTOR FUNCTION	Peak (PK)
FREQUENCY RANGE	1GHz ~ 40GHz		Average (AV)

ANTENNA POLARITY & TEST DISTANCE: HORIZONTAL AT 3 M								
NO.	FREQ. (MHz)	EMISSION LEVEL (dBuV/m)	LIMIT (dBuV/m)	MARGIN (dB)	ANTENNA HEIGHT (m)	TABLE ANGLE (Degree)	RAW VALUE (dBuV)	CORRECTION FACTOR (dB/m)
1	*5270.00	111.2 PK			2.85 H	45	108.0	3.2
2	*5270.00	100.3 AV			2.85 H	45	97.1	3.2
3	5350.00	65.7 PK	74.0	-8.3	2.85 H	45	62.3	3.4
4	5350.00	53.0 AV	54.0	-1.0	2.85 H	45	49.6	3.4
5	#10540.00	55.6 PK	74.0	-18.4	1.65 H	47	43.3	12.3
6	#10540.00	45.0 AV	54.0	-9.0	1.65 H	47	32.7	12.3
7	15810.00	56.1 PK	74.0	-17.9	3.17 H	176	43.2	12.9
8	15810.00	44.3 AV	54.0	-9.7	3.17 H	176	31.4	12.9

ANTENNA POLARITY & TEST DISTANCE: VERTICAL AT 3 M								
NO.	FREQ. (MHz)	EMISSION LEVEL (dBuV/m)	LIMIT (dBuV/m)	MARGIN (dB)	ANTENNA HEIGHT (m)	TABLE ANGLE (Degree)	RAW VALUE (dBuV)	CORRECTION FACTOR (dB/m)
1	*5270.00	110.4 PK			2.57 V	65	107.2	3.2
2	*5270.00	99.9 AV			2.57 V	65	96.7	3.2
3	5350.00	66.1 PK	74.0	-7.9	2.57 V	65	62.7	3.4
4	5350.00	53.6 AV	54.0	-0.4	2.57 V	65	50.2	3.4
5	#10540.00	52.3 PK	74.0	-21.7	1.14 V	96	40.0	12.3
6	#10540.00	40.1 AV	54.0	-13.9	1.14 V	96	27.8	12.3
7	15810.00	49.1 PK	74.0	-24.9	1.60 V	349	36.2	12.9
8	15810.00	36.5 AV	54.0	-17.5	1.60 V	349	23.6	12.9

REMARKS:

1. Emission Level(dBuV/m) = Raw Value(dBuV) + Correction Factor(dB/m)
2. Correction Factor(dB/m) = Antenna Factor(dB/m) + Cable Factor(dB) – Pre-Amplifier Factor(dB)
3. The other emission levels were very low against the limit.
4. Margin value = Emission Level – Limit value
5. " * ": Fundamental frequency.
6. " # ": The radiated frequency is out of the restricted band.

CHANNEL	TX Channel 62	DETECTOR FUNCTION	Peak (PK)
FREQUENCY RANGE	1GHz ~ 40GHz		Average (AV)

ANTENNA POLARITY & TEST DISTANCE: HORIZONTAL AT 3 M

NO.	FREQ. (MHz)	EMISSION LEVEL (dBuV/m)	LIMIT (dBuV/m)	MARGIN (dB)	ANTENNA HEIGHT (m)	TABLE ANGLE (Degree)	RAW VALUE (dBuV)	CORRECTION FACTOR (dB/m)
1	*5310.00	106.3 PK			2.71 H	38	103.1	3.2
2	*5310.00	95.9 AV			2.71 H	38	92.7	3.2
3	5350.00	68.1 PK	74.0	-5.9	2.71 H	38	64.7	3.4
4	5350.00	53.9 AV	54.0	-0.1	2.71 H	38	50.5	3.4
5	10620.00	48.2 PK	74.0	-25.8	1.47 H	349	35.7	12.5
6	10620.00	34.8 AV	54.0	-19.2	1.47 H	349	22.3	12.5
7	15930.00	47.2 PK	74.0	-26.8	2.29 H	73	34.9	12.3
8	15930.00	34.2 AV	54.0	-19.8	2.29 H	73	21.9	12.3

ANTENNA POLARITY & TEST DISTANCE: VERTICAL AT 3 M

NO.	FREQ. (MHz)	EMISSION LEVEL (dBuV/m)	LIMIT (dBuV/m)	MARGIN (dB)	ANTENNA HEIGHT (m)	TABLE ANGLE (Degree)	RAW VALUE (dBuV)	CORRECTION FACTOR (dB/m)
1	*5310.00	106.4 PK			2.52 V	68	103.2	3.2
2	*5310.00	95.8 AV			2.52 V	68	92.6	3.2
3	5350.00	71.1 PK	74.0	-2.9	2.52 V	68	67.7	3.4
4	5350.00	53.7 AV	54.0	-0.3	2.52 V	68	50.3	3.4
5	10620.00	46.5 PK	74.0	-27.5	1.00 V	135	34.0	12.5
6	10620.00	34.9 AV	54.0	-19.1	1.00 V	135	22.4	12.5
7	15930.00	45.1 PK	74.0	-28.9	3.90 V	360	32.8	12.3
8	15930.00	33.8 AV	54.0	-20.2	3.90 V	360	21.5	12.3

REMARKS:

1. Emission Level(dBuV/m) = Raw Value(dBuV) + Correction Factor(dB/m)
2. Correction Factor(dB/m) = Antenna Factor(dB/m) + Cable Factor(dB) – Pre-Amplifier Factor(dB)
3. The other emission levels were very low against the limit.
4. Margin value = Emission Level – Limit value
5. " * ": Fundamental frequency.

CHANNEL	TX Channel 102	DETECTOR FUNCTION	Peak (PK)
FREQUENCY RANGE	1GHz ~ 40GHz		Average (AV)

ANTENNA POLARITY & TEST DISTANCE: HORIZONTAL AT 3 M

NO.	FREQ. (MHz)	EMISSION LEVEL (dBuV/m)	LIMIT (dBuV/m)	MARGIN (dB)	ANTENNA HEIGHT (m)	TABLE ANGLE (Degree)	RAW VALUE (dBuV)	CORRECTION FACTOR (dB/m)
1	#5470.00	69.0 PK	74.0	-5.0	2.70 H	46	65.5	3.5
2	#5470.00	53.0 AV	54.0	-1.0	2.70 H	46	49.5	3.5
3	*5510.00	103.1 PK			2.70 H	46	99.5	3.6
4	*5510.00	93.0 AV			2.70 H	46	89.4	3.6
5	11020.00	47.3 PK	74.0	-26.7	1.49 H	360	33.9	13.4
6	11020.00	34.3 AV	54.0	-19.7	1.49 H	360	20.9	13.4
7	#16530.00	47.4 PK	74.0	-26.6	2.24 H	78	32.7	14.7
8	#16530.00	33.8 AV	54.0	-20.2	2.24 H	78	19.1	14.7

ANTENNA POLARITY & TEST DISTANCE: VERTICAL AT 3 M

NO.	FREQ. (MHz)	EMISSION LEVEL (dBuV/m)	LIMIT (dBuV/m)	MARGIN (dB)	ANTENNA HEIGHT (m)	TABLE ANGLE (Degree)	RAW VALUE (dBuV)	CORRECTION FACTOR (dB/m)
1	#5470.00	68.0 PK	74.0	-6.0	2.65 V	82	64.5	3.5
2	#5470.00	53.8 AV	54.0	-0.2	2.65 V	82	50.3	3.5
3	*5510.00	106.0 PK			2.65 V	82	102.4	3.6
4	*5510.00	94.9 AV			2.65 V	82	91.3	3.6
5	11020.00	47.6 PK	74.0	-26.4	1.00 V	153	34.2	13.4
6	11020.00	34.1 AV	54.0	-19.9	1.00 V	153	20.7	13.4
7	#16530.00	47.1 PK	74.0	-26.9	3.92 V	360	32.4	14.7
8	#16530.00	33.6 AV	54.0	-20.4	3.92 V	360	18.9	14.7

REMARKS:

1. Emission Level(dBuV/m) = Raw Value(dBuV) + Correction Factor(dB/m)
2. Correction Factor(dB/m) = Antenna Factor(dB/m) + Cable Factor(dB) – Pre-Amplifier Factor(dB)
3. The other emission levels were very low against the limit.
4. Margin value = Emission Level – Limit value
5. " * ": Fundamental frequency.
6. " # ": The radiated frequency is out of the restricted band.

CHANNEL	TX Channel 110	DETECTOR FUNCTION	Peak (PK)
FREQUENCY RANGE	1GHz ~ 40GHz		Average (AV)

ANTENNA POLARITY & TEST DISTANCE: HORIZONTAL AT 3 M

NO.	FREQ. (MHz)	EMISSION LEVEL (dBuV/m)	LIMIT (dBuV/m)	MARGIN (dB)	ANTENNA HEIGHT (m)	TABLE ANGLE (Degree)	RAW VALUE (dBuV)	CORRECTION FACTOR (dB/m)
1	#5470.00	65.9 PK	74.0	-8.1	2.69 H	34	62.4	3.5
2	#5470.00	53.7 AV	54.0	-0.3	2.69 H	34	50.2	3.5
3	*5550.00	110.0 PK			2.69 H	34	106.5	3.5
4	*5550.00	98.8 AV			2.69 H	34	95.3	3.5
5	11100.00	48.2 PK	74.0	-25.8	1.42 H	360	35.2	13.0
6	11100.00	35.4 AV	54.0	-18.6	1.42 H	360	22.4	13.0
7	#16650.00	47.6 PK	74.0	-26.4	2.30 H	61	32.1	15.5
8	#16650.00	34.9 AV	54.0	-19.1	2.30 H	61	19.4	15.5

ANTENNA POLARITY & TEST DISTANCE: VERTICAL AT 3 M

NO.	FREQ. (MHz)	EMISSION LEVEL (dBuV/m)	LIMIT (dBuV/m)	MARGIN (dB)	ANTENNA HEIGHT (m)	TABLE ANGLE (Degree)	RAW VALUE (dBuV)	CORRECTION FACTOR (dB/m)
1	#5470.00	66.0 PK	74.0	-8.0	2.51 V	83	62.5	3.5
2	#5470.00	53.8 AV	54.0	-0.2	2.51 V	83	50.3	3.5
3	*5550.00	110.1 PK			2.51 V	83	106.6	3.5
4	*5550.00	99.2 AV			2.51 V	83	95.7	3.5
5	11100.00	48.6 PK	74.0	-25.4	1.18 V	92	35.6	13.0
6	11100.00	35.6 AV	54.0	-18.4	1.18 V	92	22.6	13.0
7	#16650.00	47.5 PK	74.0	-26.5	1.55 V	360	32.0	15.5
8	#16650.00	34.1 AV	54.0	-19.9	1.55 V	360	18.6	15.5

REMARKS:

1. Emission Level(dBuV/m) = Raw Value(dBuV) + Correction Factor(dB/m)
2. Correction Factor(dB/m) = Antenna Factor(dB/m) + Cable Factor(dB) – Pre-Amplifier Factor(dB)
3. The other emission levels were very low against the limit.
4. Margin value = Emission Level – Limit value
5. " * ": Fundamental frequency.
6. " # ": The radiated frequency is out of the restricted band.

CHANNEL	TX Channel 134	DETECTOR FUNCTION	Peak (PK)
FREQUENCY RANGE	1GHz ~ 40GHz		Average (AV)

ANTENNA POLARITY & TEST DISTANCE: HORIZONTAL AT 3 M

NO.	FREQ. (MHz)	EMISSION LEVEL (dBuV/m)	LIMIT (dBuV/m)	MARGIN (dB)	ANTENNA HEIGHT (m)	TABLE ANGLE (Degree)	RAW VALUE (dBuV)	CORRECTION FACTOR (dB/m)
1	*5670.00	107.6 PK			1.82 H	26	103.8	3.8
2	*5670.00	96.3 AV			1.82 H	26	92.5	3.8
3	#5725.00	66.4 PK	74.0	-7.6	1.82 H	26	62.4	4.0
4	#5725.00	53.6 AV	54.0	-0.4	1.82 H	26	49.6	4.0
5	11340.00	48.5 PK	74.0	-25.5	1.43 H	359	35.4	13.1
6	11340.00	35.1 AV	54.0	-18.9	1.43 H	359	22.0	13.1
7	#17010.00	47.8 PK	74.0	-26.2	2.29 H	66	30.3	17.5
8	#17010.00	34.6 AV	54.0	-19.4	2.29 H	66	17.1	17.5

ANTENNA POLARITY & TEST DISTANCE: VERTICAL AT 3 M

NO.	FREQ. (MHz)	EMISSION LEVEL (dBuV/m)	LIMIT (dBuV/m)	MARGIN (dB)	ANTENNA HEIGHT (m)	TABLE ANGLE (Degree)	RAW VALUE (dBuV)	CORRECTION FACTOR (dB/m)
1	*5670.00	107.1 PK			2.94 V	75	103.3	3.8
2	*5670.00	95.9 AV			2.94 V	75	92.1	3.8
3	#5725.00	65.7 PK	74.0	-8.3	2.94 V	75	61.7	4.0
4	#5725.00	53.7 AV	54.0	-0.3	2.94 V	75	49.7	4.0
5	11340.00	54.3 PK	74.0	-19.7	1.00 V	143	41.2	13.1
6	11340.00	44.9 AV	54.0	-9.1	1.00 V	143	31.8	13.1
7	#17010.00	47.1 PK	74.0	-26.9	3.84 V	360	29.6	17.5
8	#17010.00	34.7 AV	54.0	-19.3	3.84 V	360	17.2	17.5

REMARKS:

1. Emission Level(dBuV/m) = Raw Value(dBuV) + Correction Factor(dB/m)
2. Correction Factor(dB/m) = Antenna Factor(dB/m) + Cable Factor(dB) – Pre-Amplifier Factor(dB)
3. The other emission levels were very low against the limit.
4. Margin value = Emission Level – Limit value
5. " * ": Fundamental frequency.
6. " # ": The radiated frequency is out of the restricted band.

802.11ac (VHT80)

CHANNEL	TX Channel 58	DETECTOR FUNCTION	Peak (PK)
FREQUENCY RANGE	1GHz ~ 40GHz		Average (AV)

ANTENNA POLARITY & TEST DISTANCE: HORIZONTAL AT 3 M

NO.	FREQ. (MHz)	EMISSION LEVEL (dBuV/m)	LIMIT (dBuV/m)	MARGIN (dB)	ANTENNA HEIGHT (m)	TABLE ANGLE (Degree)	RAW VALUE (dBuV)	CORRECTION FACTOR (dB/m)
1	4934.00	54.0 PK	74.0	-20.0	2.62 H	36	51.4	2.6
2	4934.00	43.7 AV	54.0	-10.3	2.62 H	36	41.1	2.6
3	*5290.00	103.3 PK			2.62 H	36	100.1	3.2
4	*5290.00	91.1 AV			2.62 H	36	87.9	3.2
5	5350.00	71.0 PK	74.0	-3.0	2.62 H	36	67.6	3.4
6	5350.00	53.9 AV	54.0	-0.1	2.62 H	36	50.5	3.4
7	#10580.00	47.5 PK	74.0	-26.5	1.47 H	360	35.0	12.5
8	#10580.00	34.4 AV	54.0	-19.6	1.47 H	360	21.9	12.5
9	15870.00	47.1 PK	74.0	-26.9	2.25 H	72	34.6	12.5
10	15870.00	33.5 AV	54.0	-20.5	2.25 H	72	21.0	12.5

ANTENNA POLARITY & TEST DISTANCE: VERTICAL AT 3 M

NO.	FREQ. (MHz)	EMISSION LEVEL (dBuV/m)	LIMIT (dBuV/m)	MARGIN (dB)	ANTENNA HEIGHT (m)	TABLE ANGLE (Degree)	RAW VALUE (dBuV)	CORRECTION FACTOR (dB/m)
1	4934.00	50.8 PK	74.0	-23.2	2.74 V	75	48.2	2.6
2	4934.00	39.8 AV	54.0	-14.2	2.74 V	75	37.2	2.6
3	*5290.00	102.5 PK			2.74 V	75	99.3	3.2
4	*5290.00	91.5 AV			2.74 V	75	88.3	3.2
5	5350.00	68.8 PK	74.0	-5.2	2.74 V	75	65.4	3.4
6	5350.00	53.8 AV	54.0	-0.2	2.74 V	75	50.4	3.4
7	#10580.00	47.5 PK	74.0	-26.5	1.00 V	141	35.0	12.5
8	#10580.00	34.3 AV	54.0	-19.7	1.00 V	141	21.8	12.5
9	15870.00	46.5 PK	74.0	-27.5	3.94 V	360	34.0	12.5
10	15870.00	33.2 AV	54.0	-20.8	3.94 V	360	20.7	12.5

REMARKS:

1. Emission Level(dBuV/m) = Raw Value(dBuV) + Correction Factor(dB/m)
2. Correction Factor(dB/m) = Antenna Factor(dB/m) + Cable Factor(dB) – Pre-Amplifier Factor(dB)
3. The other emission levels were very low against the limit.
4. Margin value = Emission Level – Limit value
5. " * ": Fundamental frequency.
6. " # ": The radiated frequency is out of the restricted band.

CHANNEL	TX Channel 106	DETECTOR FUNCTION	Peak (PK)
FREQUENCY RANGE	1GHz ~ 40GHz		Average (AV)

ANTENNA POLARITY & TEST DISTANCE: HORIZONTAL AT 3 M

NO.	FREQ. (MHz)	EMISSION LEVEL (dBuV/m)	LIMIT (dBuV/m)	MARGIN (dB)	ANTENNA HEIGHT (m)	TABLE ANGLE (Degree)	RAW VALUE (dBuV)	CORRECTION FACTOR (dB/m)
1	#5470.00	65.0 PK	74.0	-9.0	2.67 H	43	61.5	3.5
2	#5470.00	52.5 AV	54.0	-1.5	2.67 H	43	49.0	3.5
3	*5530.00	100.3 PK			2.67 H	43	96.8	3.5
4	*5530.00	88.3 AV			2.67 H	43	84.8	3.5
5	#5725.00	51.9 PK	74.0	-22.1	2.67 H	43	47.9	4.0
6	#5725.00	39.2 AV	54.0	-14.8	2.67 H	43	35.2	4.0
7	11060.00	48.0 PK	74.0	-26.0	1.42 H	360	34.8	13.2
8	11060.00	34.7 AV	54.0	-19.3	1.42 H	360	21.5	13.2
9	#16590.00	47.1 PK	74.0	-26.9	2.21 H	52	31.7	15.4
10	#16590.00	33.5 AV	54.0	-20.5	2.21 H	52	18.1	15.4

ANTENNA POLARITY & TEST DISTANCE: VERTICAL AT 3 M

NO.	FREQ. (MHz)	EMISSION LEVEL (dBuV/m)	LIMIT (dBuV/m)	MARGIN (dB)	ANTENNA HEIGHT (m)	TABLE ANGLE (Degree)	RAW VALUE (dBuV)	CORRECTION FACTOR (dB/m)
1	#5470.00	69.4 PK	74.0	-4.6	2.80 V	79	65.9	3.5
2	#5470.00	53.9 AV	54.0	-0.1	2.80 V	79	50.4	3.5
3	*5530.00	101.0 PK			2.80 V	79	97.5	3.5
4	*5530.00	89.7 AV			2.80 V	79	86.2	3.5
5	#5725.00	51.7 PK	74.0	-22.3	2.80 V	79	47.7	4.0
6	#5725.00	39.6 AV	54.0	-14.4	2.80 V	79	35.6	4.0
7	11060.00	47.0 PK	74.0	-27.0	1.08 V	99	33.8	13.2
8	11060.00	34.0 AV	54.0	-20.0	1.08 V	99	20.8	13.2
9	#16590.00	46.3 PK	74.0	-27.7	1.53 V	343	30.9	15.4
10	#16590.00	32.8 AV	54.0	-21.2	1.53 V	343	17.4	15.4

REMARKS:

- Emission Level(dBuV/m) = Raw Value(dBuV) + Correction Factor(dB/m)
- Correction Factor(dB/m) = Antenna Factor(dB/m) + Cable Factor(dB) – Pre-Amplifier Factor(dB)
- The other emission levels were very low against the limit.
- Margin value = Emission Level – Limit value
- " * ": Fundamental frequency.
- " # ": The radiated frequency is out of the restricted band.

CHANNEL	TX Channel 122	DETECTOR FUNCTION	Peak (PK)
FREQUENCY RANGE	1GHz ~ 40GHz		Average (AV)

ANTENNA POLARITY & TEST DISTANCE: HORIZONTAL AT 3 M

NO.	FREQ. (MHz)	EMISSION LEVEL (dBuV/m)	LIMIT (dBuV/m)	MARGIN (dB)	ANTENNA HEIGHT (m)	TABLE ANGLE (Degree)	RAW VALUE (dBuV)	CORRECTION FACTOR (dB/m)
1	*5610.00	106.3 PK			2.66 H	41	102.6	3.7
2	*5610.00	95.2 AV			2.66 H	41	91.5	3.7
3	#5725.00	67.1 PK	74.0	-6.9	2.66 H	41	63.1	4.0
4	#5725.00	53.3 AV	54.0	-0.7	2.66 H	41	49.3	4.0
5	11220.00	49.1 PK	74.0	-24.9	1.45 H	355	36.1	13.0
6	11220.00	36.0 AV	54.0	-18.0	1.45 H	355	23.0	13.0
7	#16830.00	38.5 PK	74.0	-35.5	2.25 H	56	22.5	16.0
8	#16830.00	35.1 AV	54.0	-18.9	2.25 H	56	19.1	16.0

ANTENNA POLARITY & TEST DISTANCE: VERTICAL AT 3 M

NO.	FREQ. (MHz)	EMISSION LEVEL (dBuV/m)	LIMIT (dBuV/m)	MARGIN (dB)	ANTENNA HEIGHT (m)	TABLE ANGLE (Degree)	RAW VALUE (dBuV)	CORRECTION FACTOR (dB/m)
1	*5610.00	108.3 PK			1.97 V	74	104.6	3.7
2	*5610.00	95.4 AV			1.97 V	74	91.7	3.7
3	#5725.00	68.7 PK	74.0	-5.3	1.97 V	74	64.7	4.0
4	#5725.00	53.7 AV	54.0	-0.3	1.97 V	74	49.7	4.0
5	11220.00	56.9 PK	74.0	-17.1	1.00 V	145	43.9	13.0
6	11220.00	45.6 AV	54.0	-8.4	1.00 V	145	32.6	13.0
7	#16830.00	49.5 PK	74.0	-24.5	3.90 V	360	33.5	16.0
8	#16830.00	36.1 AV	54.0	-17.9	3.90 V	360	20.1	16.0

REMARKS:

1. Emission Level(dBuV/m) = Raw Value(dBuV) + Correction Factor(dB/m)
2. Correction Factor(dB/m) = Antenna Factor(dB/m) + Cable Factor(dB) – Pre-Amplifier Factor(dB)
3. The other emission levels were very low against the limit.
4. Margin value = Emission Level – Limit value
5. " * ": Fundamental frequency.
6. " # ": The radiated frequency is out of the restricted band.

Below 1GHz Data:

802.11ac (VHT20)

CHANNEL	TX Channel 60	DETECTOR FUNCTION	Quasi-Peak (QP)
FREQUENCY RANGE	9kHz ~ 1GHz		

ANTENNA POLARITY & TEST DISTANCE: HORIZONTAL AT 3 M

NO.	FREQ. (MHz)	EMISSION LEVEL (dBuV/m)	LIMIT (dBuV/m)	MARGIN (dB)	ANTENNA HEIGHT (m)	TABLE ANGLE (Degree)	RAW VALUE (dBuV)	CORRECTION FACTOR (dB/m)
1	39.55	22.6 QP	40.0	-17.4	1.50 H	296	36.2	-13.6
2	147.47	27.9 QP	43.5	-15.6	2.00 H	99	41.2	-13.3
3	250.00	29.8 QP	46.0	-16.2	1.00 H	285	44.5	-14.7
4	459.01	36.1 QP	46.0	-9.9	1.00 H	183	44.8	-8.7
5	666.78	32.5 QP	46.0	-13.5	1.00 H	33	37.3	-4.8
6	749.98	31.0 QP	46.0	-15.0	1.00 H	229	34.1	-3.1

ANTENNA POLARITY & TEST DISTANCE: VERTICAL AT 3 M

NO.	FREQ. (MHz)	EMISSION LEVEL (dBuV/m)	LIMIT (dBuV/m)	MARGIN (dB)	ANTENNA HEIGHT (m)	TABLE ANGLE (Degree)	RAW VALUE (dBuV)	CORRECTION FACTOR (dB/m)
1	33.42	36.0 QP	40.0	-4.0	1.00 V	360	50.0	-14.0
2	39.46	35.4 QP	40.0	-4.6	1.00 V	190	49.0	-13.6
3	458.98	34.5 QP	46.0	-11.5	2.00 V	360	43.2	-8.7
4	574.99	31.7 QP	46.0	-14.3	2.00 V	163	38.1	-6.4
5	667.07	32.7 QP	46.0	-13.3	1.00 V	55	37.5	-4.8
6	958.34	32.7 QP	46.0	-13.3	1.00 V	159	33.1	-0.4

REMARKS:

1. Emission Level(dBuV/m) = Raw Value(dBuV) + Correction Factor(dB/m)
2. Correction Factor(dB/m) = Antenna Factor(dB/m) + Cable Factor(dB) – Pre-Amplifier Factor(dB)
3. The other emission levels were very low against the limit.
4. Margin value = Emission Level – Limit value

4.2 Conducted Emission Measurement

4.2.1 Limits of Conducted Emission Measurement

Frequency (MHz)	Conducted Limit (dBuV)	
	Quasi-peak	Average
0.15 - 0.5	66 - 56	56 - 46
0.50 - 5.0	56	46
5.0 - 30.0	60	50

Note: 1. The lower limit shall apply at the transition frequencies.

2. The limit decreases in line with the logarithm of the frequency in the range of 0.15 to 0.50MHz.

4.2.2 Test Instruments

DESCRIPTION & MANUFACTURER	MODEL NO.	SERIAL NO.	CALIBRATED DATE	CALIBRATED UNTIL
Test Receiver R&S	ESCS 30	847124/029	Oct. 24, 2016	Oct. 23, 2017
Line-Impedance Stabilization Network (for EUT) R&S	ESH3-Z5	848773/004	Oct. 26, 2016	Oct. 25, 2017
Line-Impedance Stabilization Network (for Peripheral) R&S	ENV216	100072	June 13, 2016	June 12, 2017
50 ohms Terminator	N/A	EMC-02	Sep. 29, 2016	Sep. 28, 2017
RF Cable	5D-FB	COCCAB-001	Sep. 30, 2016	Sep. 29, 2017
10 dB PAD Mini-Circuits	HAT-10+	CONATT-004	June 20, 2016	June 19, 2017
Software BVADT	BVADT_Cond_ V7.3.7.4	NA	NA	NA

Note:

1. The calibration interval of the above test instruments are 12 months and the calibrations are traceable to NML/ROC and NIST/USA.
2. The test was performed in Shielded Room No. 1.
3. Tested Date: Feb. 23, 2017

4.2.3 Test Procedure

- The EUT was placed 0.4 meters from the conducting wall of the shielded room with EUT being connected to the power mains through a line impedance stabilization network (LISN). Other support units were connected to the power mains through another LISN. The two LISNs provide 50 ohm/ 50uH of coupling impedance for the measuring instrument.
- Both lines of the power mains connected to the EUT were checked for maximum conducted interference.
- The frequency range from 150kHz to 30MHz was searched. Emission levels under (Limit - 20dB) was not recorded.

NOTE: All modes of operation were investigated and the worst-case emissions are reported.

4.2.4 Deviation from Test Standard

No deviation.

4.2.5 Test Setup

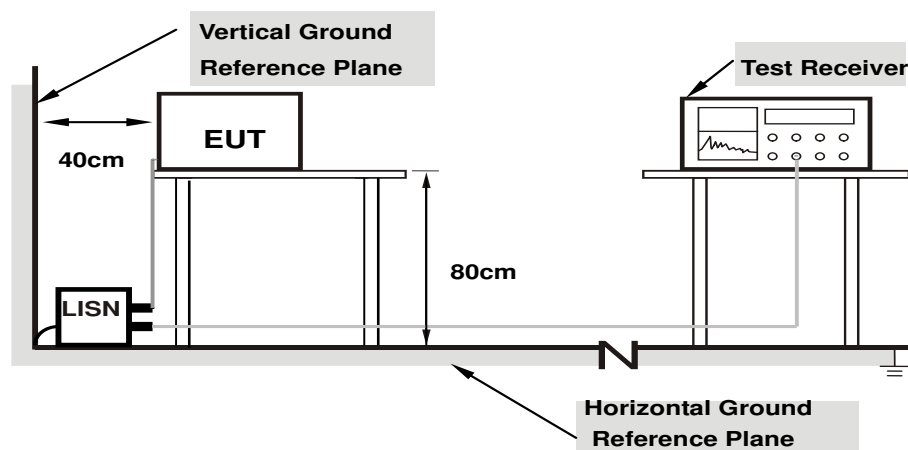

Note: 1.Support units were connected to second LISN.

For the actual test configuration, please refer to the attached file (Test Setup Photo).

4.2.6 EUT Operating Condition

Same as 4.1.6.

4.2.7 Test Results

Phase	Line (L)	Detector Function	Quasi-Peak (QP) / Average (AV)
-------	----------	-------------------	--------------------------------

No	Freq. [MHz]	Corr.	Reading Value		Emission Level		Limit		Margin	
		Factor (dB)	[dB (uV)]		[dB (uV)]		[dB (uV)]		(dB)	
			Q.P.	AV.	Q.P.	AV.	Q.P.	AV.	Q.P.	AV.
1	0.15000	10.20	33.05	22.29	43.25	32.49	66.00	56.00	-22.75	-23.51
2	0.17344	10.20	30.46	19.52	40.66	29.72	64.79	54.79	-24.13	-25.07
3	0.27891	10.22	24.95	13.92	35.17	24.14	60.85	50.85	-25.68	-26.71
4	0.68516	10.27	16.14	10.95	26.41	21.22	56.00	46.00	-29.59	-24.78
5	2.05078	10.29	15.75	9.91	26.04	20.20	56.00	46.00	-29.96	-25.80
6	20.67188	11.71	13.46	7.27	25.17	18.98	60.00	50.00	-34.83	-31.02

REMARKS:

1. Q.P. and AV. are abbreviations of quasi-peak and average individually.
2. The emission levels of other frequencies were very low against the limit.
3. Margin value = Emission level - Limit value
4. Correction factor = Insertion loss + Cable loss
5. Emission Level = Correction Factor + Reading Value.

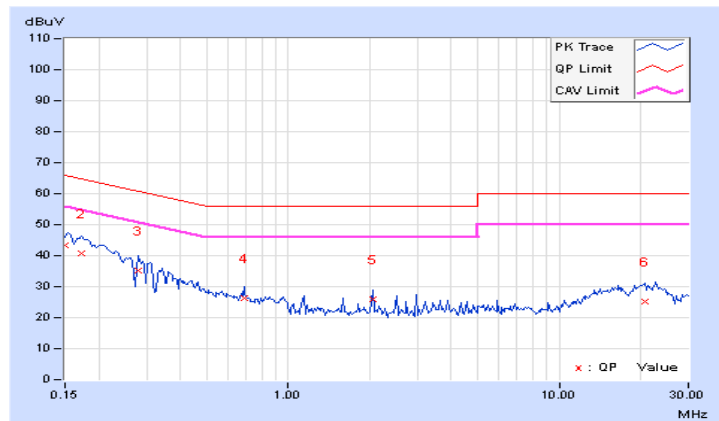

Phase	Neutral (N)	Detector Function	Quasi-Peak (QP) / Average (AV)
-------	-------------	-------------------	--------------------------------

No	Freq. [MHz]	Corr. Factor	Reading Value [dB (uV)]		Emission Level [dB (uV)]		Limit [dB (uV)]		Margin (dB)	
		(dB)	Q.P.	AV.	Q.P.	AV.	Q.P.	AV.	Q.P.	AV.
	1	0.15781	10.19	30.65	18.88	40.84	29.07	65.58	55.58	-24.74
2	0.20469	10.17	28.93	19.17	39.10	29.34	63.42	53.42	-24.32	-24.08
3	0.23984	10.18	24.29	9.43	34.47	19.61	62.10	52.10	-27.63	-32.49
4	0.28672	10.20	25.23	16.16	35.43	26.36	60.62	50.62	-25.19	-24.26
5	14.01172	11.00	9.51	3.54	20.51	14.54	60.00	50.00	-39.49	-35.46
6	20.60938	11.38	14.53	8.04	25.91	19.42	60.00	50.00	-34.09	-30.58

REMARKS:

1. Q.P. and AV. are abbreviations of quasi-peak and average individually.
2. The emission levels of other frequencies were very low against the limit.
3. Margin value = Emission level - Limit value
4. Correction factor = Insertion loss + Cable loss
5. Emission Level = Correction Factor + Reading Value.

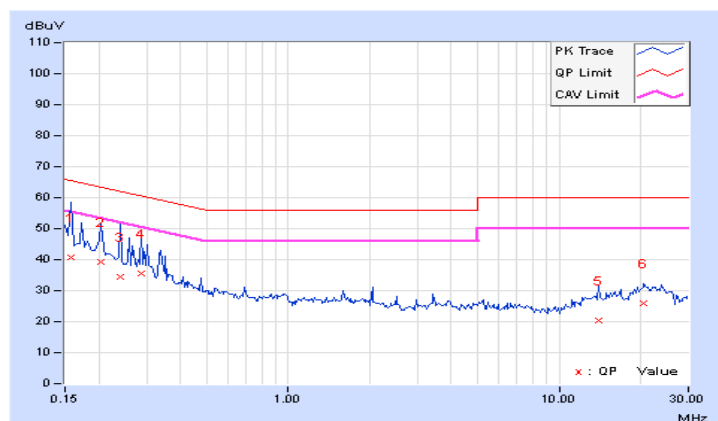

4.3 Transmit Power Measurement

4.3.1 Limits of Transmit Power Measurement

Operation Band	EUT Category		Limit
U-NII-1		Outdoor Access Point	1 Watt (30 dBm) (Max. e.i.r.p \leq 125mW(21 dBm) at any elevation angle above 30 degrees as measured from the horizon)
		Fixed point-to-point Access Point	1 Watt (30 dBm)
		Indoor Access Point	1 Watt (30 dBm)
		Mobile and Portable client device	250mW (24 dBm)
U-NII-2A	√		250mW (24 dBm) or 11 dBm+10 log B*
U-NII-2C	√		250mW (24 dBm) or 11 dBm+10 log B*
U-NII-3			1 Watt (30 dBm)

*B is the 26 dB emission bandwidth in megahertz

4.3.2 Test Setup

FOR POWER OUTPUT MEASUREMENT

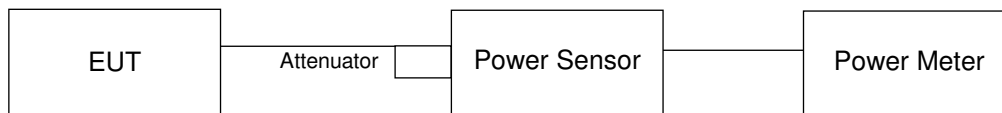

FOR 26dB OCCUPIED BANDWIDTH

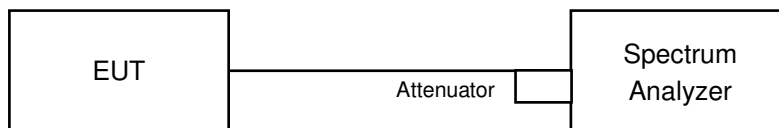

4.3.3 Test Instruments

Refer to section 4.1.2 to get information of above instrument.

4.3.4 Test Procedure

For Average Power Measurement

Method PM is used to perform output power measurement, trigger and gating function of wide band power meter is enabled to measure max output power of TX on burst. Duty factor is not added to measured value.

FOR 26dB OCCUPIED BANDWIDTH

1. Set RBW = approximately 1% of the emission bandwidth.
2. Set the VBW > RBW.
3. Detector = Peak.
4. Trace mode = max hold.
5. Measure the maximum width of the emission that is 26 dB down from the peak of the emission. Compare this with the RBW setting of the analyzer. Readjust RBW and repeat measurement as needed until the RBW/EBW ratio is approximately 1%.

4.3.5 Deviation from Test Standard

No deviation.

4.3.6 EUT Operating Condition

The software provided by client to enable the EUT under transmission condition continuously at lowest, middle and highest channel frequencies individually.

4.3.7 Test Result

802.11a

Power Output:

Chan.	Chan. Freq. (MHz)	Maximum Conducted Power (mW)	Maximum Conducted Power (dBm)	Power Limit (dBm)	Pass/Fail
52	5260	143.549	21.57	24	Pass
60	5300	144.877	21.61	24	Pass
64	5320	120.226	20.80	24	Pass
100	5500	76.384	18.83	24	Pass
116	5580	140.605	21.48	24	Pass
140	5700	48.641	16.87	24	Pass

26dB OCCUPIED BANDWIDTH

Channel	Frequency (MHz)	26dBc Bandwidth (MHz)
52	5260	37.70
60	5300	36.52
64	5320	30.71
100	5500	25.67
116	5580	37.66
140	5700	24.77

Note: For U-NII-2A, U-NII-2C Band output power limitation is determined based on 26dBc bandwidth

Power Limit = 11dBm + 10logB < U-NII-2A, U-NII-2C >			
Channel Number	Freq.(MHz)	Min. B(MHz)	Determined Conducted Limit (dBm)
52	5260	37.70	26.76 > 24
60	5300	36.52	26.62 > 24
64	5320	30.71	25.87 > 24
100	5500	25.67	25.09 > 24
120	5600	37.66	26.75 > 24
140	5700	24.77	24.93 > 24

802.11ac (VHT20)

Power Output:

Chan.	Chan. Freq. (MHz)	Maximum Conducted Power (mW)	Maximum Conducted Power (dBm)	Power Limit (dBm)	Pass/Fail
52	5260	158.855	22.01	24	Pass
60	5300	159.221	22.02	24	Pass
64	5320	111.686	20.48	24	Pass
100	5500	85.901	19.34	24	Pass
116	5580	130.617	21.16	24	Pass
140	5700	46.345	16.66	24	Pass

26dB OCCUPIED BANDWIDTH

Channel	Frequency (MHz)	26dBc Bandwidth (MHz)
52	5260	42.99
60	5300	42.63
64	5320	38.25
100	5500	32.06
116	5580	41.59
140	5700	24.05

Note: For U-NII-2A, U-NII-2C Band output power limitation is determined based on 26dBc bandwidth

Power Limit = 11dBm + 10logB < U-NII-2A, U-NII-2C >			
Channel Number	Freq.(MHz)	Min. B(MHz)	Determined Conducted Limit (dBm)
52	5260	42.99	27.33 > 24
60	5300	42.63	27.29 > 24
64	5320	38.25	26.82 > 24
100	5500	32.06	26.05 > 24
120	5600	41.59	27.18 > 24
140	5700	24.05	24.81 > 24

802.11ac (VHT40)

Power Output:

Chan.	Chan. Freq. (MHz)	Maximum Conducted Power (mW)	Maximum Conducted Power (dBm)	Power Limit (dBm)	Pass/Fail
54	5270	148.252	21.71	24	Pass
62	5310	68.707	18.37	24	Pass
102	5510	38.371	15.84	24	Pass
110	5550	136.144	21.34	24	Pass
134	5670	73.114	18.64	24	Pass

26dB OCCUPIED BANDWIDTH

Channel	Frequency (MHz)	26dBc Bandwidth (MHz)
54	5270	87.92
62	5310	53.24
102	5510	41.87
110	5550	92.13
134	5670	72.75

Note: For U-NII-2A, U-NII-2C Band output power limitation is determined based on 26dBc bandwidth

Power Limit = 11dBm + 10logB < U-NII-2A, U-NII-2C >			
Channel Number	Freq.(MHz)	Min. B(MHz)	Determined Conducted Limit (dBm)
54	5270	87.92	30.44 > 24
62	5310	53.24	28.26 > 24
102	5510	41.87	27.21 > 24
110	5550	92.13	30.64 > 24
134	5670	72.75	29.61 > 24

802.11ac (VHT80)

Power Output:

Chan.	Chan. Freq. (MHz)	Maximum Conducted Power (mW)	Maximum Conducted Power (dBm)	Power Limit (dBm)	Pass/Fail
58	5290	54.2	17.34	24	Pass
106	5530	22.803	13.58	24	Pass
122	5610	111.686	20.48	24	Pass

26dB OCCUPIED BANDWIDTH

Channel	Frequency (MHz)	26dBc Bandwidth (MHz)
58	5290	93.20
106	5530	82.58
122	5610	166.92

Note: For U-NII-2A, U-NII-2C Band output power limitation is determined based on 26dBc bandwidth

Power Limit = 11dBm + 10logB < U-NII-2A, U-NII-2C >			
Channel Number	Freq.(MHz)	Min. B(MHz)	Determined Conducted Limit (dBm)
58	5290	93.20	30.69 > 24
106	5530	82.58	30.16 > 24
122	5610	166.92	33.22 > 24

Spectrum Plot of Worst Value

802.11a / CH140

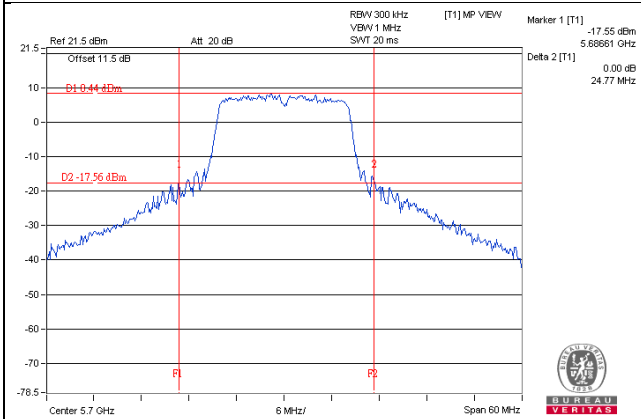

802.11ac (VHT20) / CH140

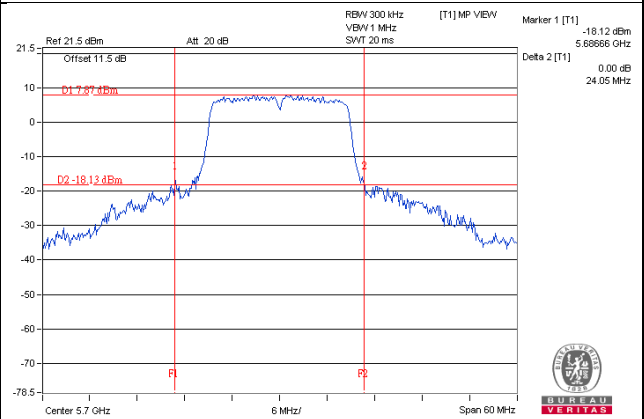

8802.11ac (VHT40) / CH102

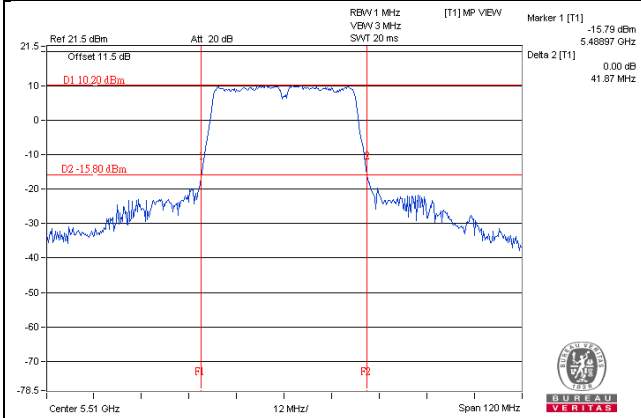

802.11ac (VHT80) / CH106

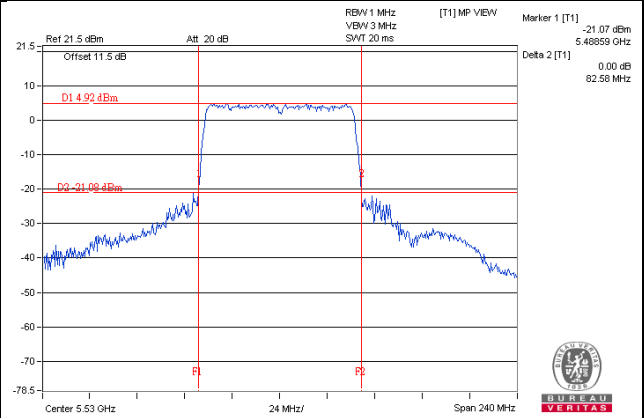

4.4 Occupied Bandwidth Measurement

4.4.1 Test Setup

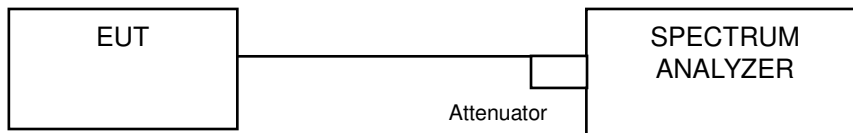

4.4.2 Test Instruments

Refer to section 4.1.2 to get information of above instrument.

4.4.3 Test Procedure

The transmitter output was connected to the spectrum analyzer through an attenuator. The bandwidth of the fundamental frequency was measured by spectrum analyzer with resolution bandwidth in the range of 1% to 5% of the anticipated emission bandwidth, and a video bandwidth at least 3x the resolution bandwidth and set the detector to SAMPLE. The width of a frequency band such that, below the lower and above the upper frequency limits, the mean powers emitted are each equal to a specified percentage 0.5 %of the total mean power of a given emission.

4.4.4 Test Results

802.11a

Channel	Channel Frequency (MHz)	Occupied Bandwidth (MHz)
52	5260	19.92
60	5300	19.08
64	5320	17.04
100	5500	16.80
116	5580	20.16
140	5700	16.68

802.11ac (VHT20)

Channel	Channel Frequency (MHz)	Occupied Bandwidth (MHz)
52	5260	20.64
60	5300	20.76
64	5320	17.88
100	5500	17.88
116	5580	18.96
140	5700	17.76

802.11ac (VHT40)

Channel	Channel Frequency (MHz)	Occupied Bandwidth (MHz)
54	5270	38.88
62	5310	36.72
102	5510	36.48
110	5550	39.36
134	5670	36.96

802.11ac (VHT80)

Channel	Channel Frequency (MHz)	Occupied Bandwidth (MHz)
58	5290	76.32
106	5530	75.84
122	5610	77.28

Spectrum Plot of Worst Value

802.11a / CH116

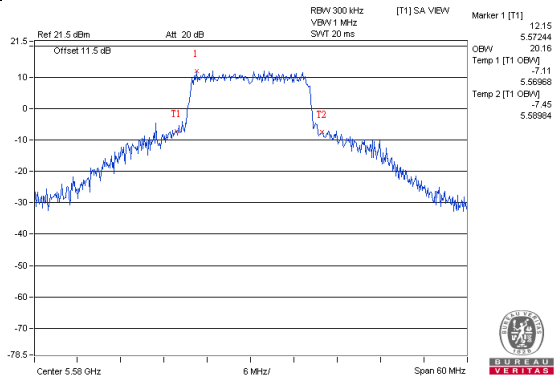

802.11ac (VHT20) / CH60

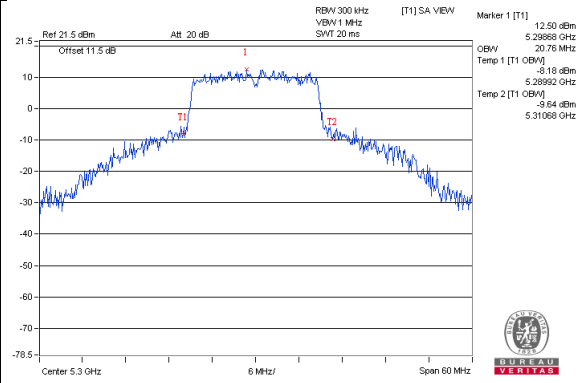

802.11ac (VHT40) / CH110

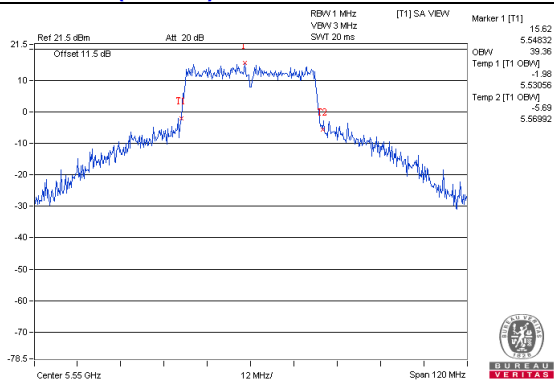

802.11ac (VHT80) / CH122

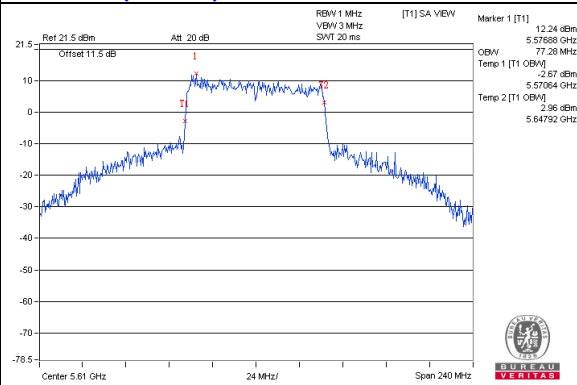

4.5 Peak Power Spectral Density Measurement

4.5.1 Limits of Peak Power Spectral Density Measurement

Operation Band	EUT Category		Limit
U-NII-1		Outdoor Access Point	17dBm/ MHz
		Fixed point-to-point Access Point	
		Indoor Access Point	
		Mobile and Portable client device	11dBm/ MHz
U-NII-2A	√		11dBm/ MHz
U-NII-2C	√		11dBm/ MHz
U-NII-3			30dBm/ 500kHz

4.5.2 Test Setup

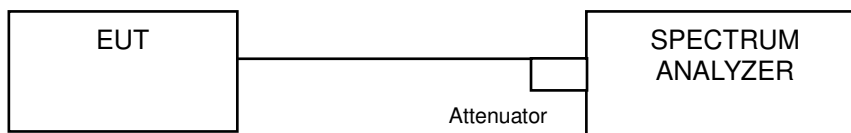

4.5.3 Test Instruments

Refer to section 4.1.2 to get information of above instrument.

4.5.4 Test Procedure

802.11a, 802.11ac (VHT20)

Using method SA-1

1. Set span to encompass the entire emission bandwidth (EBW) of the signal.
2. Set RBW = 1 MHz, Set VBW ≥ 3 MHz, Detector = RMS
3. Sweep time = auto, trigger set to “free run”.
4. Trace average at least 100 traces in power averaging mode.
5. Record the max value

802.11ac (VHT40), 802.11ac (VHT80)

Using method SA-2

1. Set span to encompass the entire emission bandwidth (EBW) of the signal.
2. Set RBW = 1 MHz, Set VBW ≥ 3 MHz, Detector = RMS
3. Sweep time = auto, trigger set to “free run”.
4. Trace average at least 100 traces in power averaging mode.
5. Record the max value and add 10 log (1/duty cycle)

4.5.5 Deviation from Test Standard

No deviation.

4.5.6 EUT Operating Condition

Same as Item 4.3.6.

4.5.7 Test Results

802.11a

Chan.	Chan. Freq. (MHz)	PSD (dBm/MHz)	MAX. Limit (dBm/MHz)	Pass / Fail
52	5260	8.64	11	Pass
60	5300	8.48	11	Pass
64	5320	7.10	11	Pass
100	5500	5.74	11	Pass
116	5580	8.52	11	Pass
140	5700	3.45	11	Pass

802.11ac (VHT20)

Chan.	Chan. Freq. (MHz)	PSD (dBm/MHz)	MAX. Limit (dBm/MHz)	Pass / Fail
52	5260	8.24	11	Pass
60	5300	8.35	11	Pass
64	5320	7.08	11	Pass
100	5500	6.28	11	Pass
116	5580	7.82	11	Pass
140	5700	3.18	11	Pass

802.11ac (VHT40)

Chan.	Chan. Freq. (MHz)	PSD W/O Duty Factor (dBm/MHz)	Duty Factor (dB)	PSD With Duty Factor (dBm/MHz)	MAX. Limit (dBm/MHz)	Pass / Fail
54	5270	4.64	0.29	4.93	11	Pass
62	5310	1.41	0.29	1.70	11	Pass
102	5510	-0.58	0.29	-0.29	11	Pass
110	5550	5.41	0.29	5.70	11	Pass
134	5670	2.35	0.29	2.64	11	Pass

802.11ac (VHT80)

Chan.	Chan. Freq. (MHz)	PSD W/O Duty Factor (dBm/MHz)	Duty Factor (dB)	PSD With Duty Factor (dBm/MHz)	MAX. Limit (dBm/MHz)	Pass / Fail
58	5290	-2.39	0.47	-1.92	11	Pass
106	5530	-5.98	0.47	-5.51	11	Pass
122	5610	2.11	0.47	2.58	11	Pass

Spectrum Plot of Worst Value

802.11a / CH52

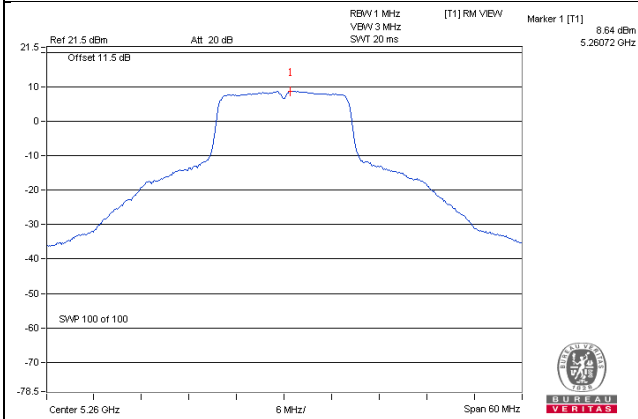

802.11ac (VHT20) / CH60

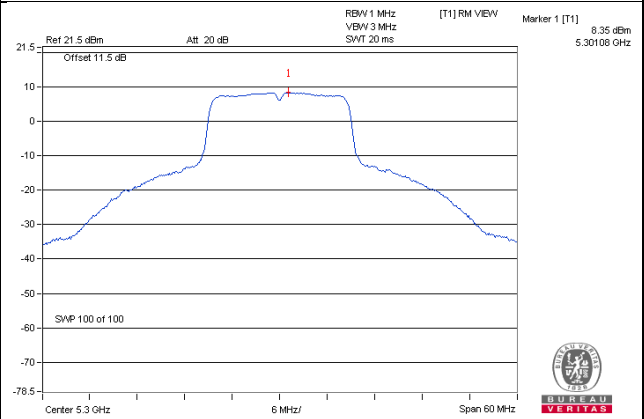

802.11ac (VHT40) / CH110

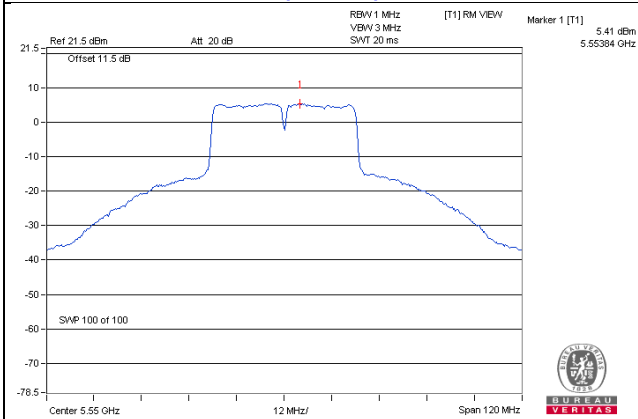

802.11ac (VHT80) / CH122

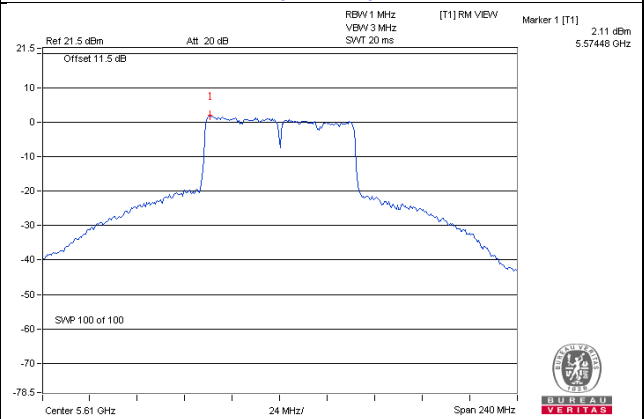

4.6 Frequency Stability Measurement

4.6.1 Limits of Frequency Stability Measurement

The frequency of the carrier signal shall be maintained within band of operation

4.6.2 Test Setup

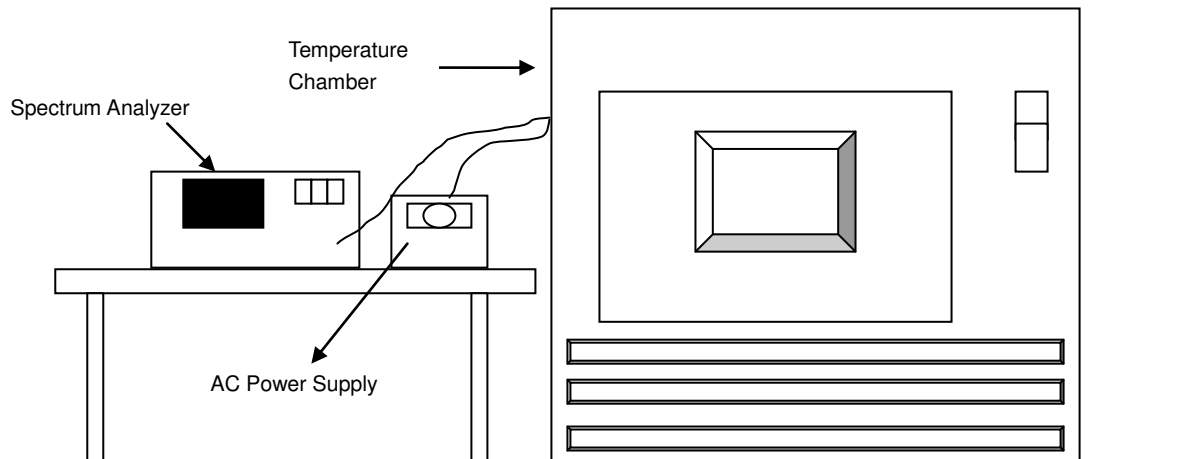

4.6.3 Test Instruments

Refer to section 4.1.2 to get information of above instrument.

4.6.4 Test Procedure

- The EUT was placed inside the environmental test chamber and powered by nominal AC voltage.
- Turn the EUT on and couple its output to a spectrum analyzer.
- Turn the EUT off and set the chamber to the highest temperature specified.
- Allow sufficient time (approximately 30 min) for the temperature of the chamber to stabilize, turn the EUT on and measure the operating frequency after 2, 5, and 10 Minutes.
- Repeat step 2 and 3 with the temperature chamber set to the lowest temperature.
- The test chamber was allowed to stabilize at +20 degree C for a minimum of 30 Minutes. The supply voltage was then adjusted on the EUT from 85% to 115% and the frequency record.

4.6.5 Deviation from Test Standard

No deviation.

4.6.6 EUT Operating Condition

Set the EUT transmit at un-modulation mode to test frequency stability.

4.6.7 Test Results

Frequency Stability Versus Temp.									
Operating Frequency: 5260 MHz									
TEMP. (°C)	Power Supply (Vac)	0 Minute		2 Minute		5 Minute		10 Minute	
		Measured Frequency (MHz)	Pass/Fail	Measured Frequency (MHz)	Pass/Fail	Measured Frequency (MHz)	Pass/Fail	Measured Frequency (MHz)	Pass/Fail
50	120	5260.0239	Pass	5260.0269	Pass	5260.0219	Pass	5260.0239	Pass
40	120	5260.0095	Pass	5260.0059	Pass	5260.0095	Pass	5260.0089	Pass
30	120	5260.0062	Pass	5260.0051	Pass	5260.0038	Pass	5260.0064	Pass
20	120	5259.9937	Pass	5259.9933	Pass	5259.9936	Pass	5259.9926	Pass
10	120	5260.0027	Pass	5260.0022	Pass	5259.9999	Pass	5260.001	Pass
0	120	5259.9923	Pass	5259.9949	Pass	5259.9926	Pass	5259.993	Pass
-10	120	5259.9934	Pass	5259.9948	Pass	5259.9935	Pass	5259.9947	Pass
-20	120	5259.9805	Pass	5259.9833	Pass	5259.9828	Pass	5259.984	Pass
-30	120	5260.0222	Pass	5260.0242	Pass	5260.0248	Pass	5260.0226	Pass

Frequency Stability Versus Voltage									
Operating Frequency: 5260 MHz									
TEMP. (°C)	Power Supply (Vac)	0 Minute		2 Minute		5 Minute		10 Minute	
		Measured Frequency (MHz)	Pass/Fail	Measured Frequency (MHz)	Pass/Fail	Measured Frequency (MHz)	Pass/Fail	Measured Frequency (MHz)	Pass/Fail
20	138	5259.9937	Pass	5259.9925	Pass	5259.9932	Pass	5259.9928	Pass
	120	5259.9937	Pass	5259.9933	Pass	5259.9936	Pass	5259.9926	Pass
	102	5259.9936	Pass	5259.9924	Pass	5259.9936	Pass	5259.9935	Pass

5 Pictures of Test Arrangements

Please refer to the attached file (Test Setup Photo).

Appendix – Information on the Testing Laboratories

We, Bureau Veritas Consumer Products Services (H.K.) Ltd., Taoyuan Branch, were founded in 1988 to provide our best service in EMC, Radio, Telecom and Safety consultation. Our laboratories are accredited and approved according to ISO/IEC 17025.

If you have any comments, please feel free to contact us at the following:

Linko EMC/RF Lab

Tel: 886-2-26052180

Fax: 886-2-26051924

Hsin Chu EMC/RF/Telecom Lab

Tel: 886-3-6668565

Fax: 886-3-6668323

Hwa Ya EMC/RF/Safety Lab

Tel: 886-3-3183232

Fax: 886-3-3270892

Email: service.adt@tw.bureauveritas.com

Web Site: www.bureauveritas-adt.com

The address and road map of all our labs can be found in our web site also.

--- END ---