

FCC Test Report

Report No.: RF161018E04-1

FCC ID: KA2SHC310A1

Test Model: DSH-C310

Received Date: Oct. 18, 2016

Test Date: Oct. 31 to Nov. 22, 2016

Issued Date: Dec. 16, 2016

Applicant: D-Link Corporation

Address: No.289, Sinhu 3rd Rd., Neihu District, Taipei City 114, Taiwan, R.O.C.

Issued By: Bureau Veritas Consumer Products Services (H.K.) Ltd., Taoyuan Branch
Hsin Chu Laboratory

Lab Address: E-2, No.1, Li Hsin 1st Road, Hsinchu Science Park, Hsinchu City 300,
Taiwan R.O.C.

Test Location (1): E-2, No.1, Li Hsin 1st Road, Hsinchu Science Park, Hsinchu City 300,
Taiwan R.O.C.

Test Location (2): No. 49, Ln. 206, Wende Rd., Shangshan Tsuen, Chiung Lin Hsiang, Hsin
Chu Hsien 307, Taiwan R.O.C.



This report is for your exclusive use. Any copying or replication of this report to or for any other person or entity, or use of our name or trademark, is permitted only with our prior written permission. This report sets forth our findings solely with respect to the test samples identified herein. The results set forth in this report are not indicative or representative of the quality or characteristics of the lot from which a test sample was taken or any similar or identical product unless specifically and expressly noted. Our report includes all of the tests requested by you and the results thereof based upon the information that you provided to us. You have 60 days from date of issuance of this report to notify us of any material error or omission caused by our negligence, provided, however, that such notice shall be in writing and shall specifically address the issue you wish to raise. A failure to raise such issue within the prescribed time shall constitute your unqualified acceptance of the completeness of this report, the tests conducted and the correctness of the report contents. Unless specific mention, the uncertainty of measurement has been explicitly taken into account to declare the compliance or non-compliance to the specification. The report must not be used by the client to claim product certification, approval, or endorsement by TAF or any government agencies.

Table of Contents

Release Control Record	4
1 Certificate of Conformity	5
2 Summary of Test Results	6
2.1 Measurement Uncertainty	6
2.2 Modification Record	6
3 General Information	7
3.1 General Description of EUT	7
3.2 Description of Test Modes	9
3.2.1 Test Mode Applicability and Tested Channel Detail	10
3.3 Duty Cycle of Test Signal	12
3.4 Description of Support Units	13
3.4.1 Configuration of System under Test	13
3.5 General Description of Applied Standard	14
4 Test Types and Results	15
4.1 Radiated Emission and Bandedge Measurement	15
4.1.1 Limits of Radiated Emission and Bandedge Measurement	15
4.1.2 Test Instruments	16
4.1.3 Test Procedure	18
4.1.4 Deviation from Test Standard	18
4.1.5 Test Setup	19
4.1.6 EUT Operating Condition	20
4.1.7 Test Results	21
4.2 Conducted Emission Measurement	40
4.2.1 Limits of Conducted Emission Measurement	40
4.2.2 Test Instruments	40
4.2.3 Test Procedure	41
4.2.4 Deviation from Test Standard	41
4.2.5 Test Setup	41
4.2.6 EUT Operating Condition	41
4.2.7 Test Results	42
4.3 Transmit Power Measurement	44
4.3.1 Limits of Transmit Power Measurement	44
4.3.2 Test Setup	44
4.3.3 Test Instruments	44
4.3.4 Test Procedure	44
4.3.5 Deviation from Test Standard	44
4.3.6 EUT Operating Condition	44
4.3.7 Test Result	45
4.4 Occupied Bandwidth Measurement	46
4.4.1 Test Setup	46
4.4.2 Test Instruments	46
4.4.3 Test Procedure	46
4.4.4 Test Results	47
4.5 Peak Power Spectral Density Measurement	51
4.5.1 Limits of Peak Power Spectral Density Measurement	51
4.5.2 Test Setup	51
4.5.3 Test Instruments	51
4.5.4 Test Procedure	52
4.5.5 Deviation from Test Standard	52
4.5.6 EUT Operating Condition	52
4.5.7 Test Results	53
4.6 Frequency Stability Measurement	57
4.6.1 Limits of Frequency Stability Measurement	57

4.6.2	Test Setup.....	57
4.6.3	Test Instruments	57
4.6.4	Test Procedure	57
4.6.5	Deviation from Test Standard	57
4.6.6	EUT Operating Condition	57
4.6.7	Test Results	58
4.7	6dB Bandwidth Measurement	59
4.7.1	Limits of 6dB Bandwidth Measurement.....	59
4.7.2	Test Setup.....	59
4.7.3	Test Instruments	59
4.7.4	Test Procedure	59
4.7.5	Deviation from Test Standard	59
4.7.6	EUT Operating Condition	59
4.7.7	Test Results	60
5	Pictures of Test Arrangements.....	62
	Annex A- Radiated Out of Band Emission (OOBE) Measurement (For U-NII-3 band)	63
	Appendix – Information on the Testing Laboratories	66

Release Control Record

Issue No.	Description	Date Issued
RF161018E04-1	Original release.	Dec. 16, 2016

1 Certificate of Conformity

Product: Omna 180Cam HD

Brand: D-Link

Test Model: DSH-C310

Sample Status: ENGINEERING SAMPLE

Applicant: D-Link Corporation

Test Date: Oct. 31 to Nov. 22, 2016

Standard: 47 CFR FCC Part 15, Subpart E (Section 15.407)
ANSI C63.10: 2013

The above equipment has been tested by **Bureau Veritas Consumer Products Services (H.K.) Ltd., Taoyuan Branch**, and found compliance with the requirement of the above standards. The test record, data evaluation & Equipment Under Test (EUT) configurations represented herein are true and accurate accounts of the measurements of the sample's EMC characteristics under the conditions specified in this report.

Prepared by :  , **Date:** Dec. 16, 2016
Claire Kuan / Specialist

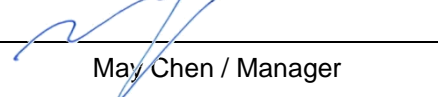
Approved by :  , **Date:** Dec. 16, 2016
May Chen / Manager

2 Summary of Test Results

47 CFR FCC Part 15, Subpart E (Section 15.407)			
FCC Clause	Test Item	Result	Remarks
15.407(b)(6)	AC Power Conducted Emissions	Pass	Meet the requirement of limit. Minimum passing margin is -21.73dB at 0.82578MHz.
15.407(b) (1/2/3/4(i/ii)/6)	Radiated Emissions & Band Edge Measurement*	Pass	Meet the requirement of limit. Minimum passing margin is -0.1dB at 5150.00MHz.
15.407(a)(1/2/3)	Max Average Transmit Power	Pass	Meet the requirement of limit.
---	Occupied Bandwidth Measurement	-	Reference only.
15.407(a)(1/2/3)	Peak Power Spectral Density	Pass	Meet the requirement of limit.
15.407(e)	6dB bandwidth	Pass	Meet the requirement of limit. (U-NII-3 Band only)
15.407(g)	Frequency Stability	Pass	Meet the requirement of limit.
15.203	Antenna Requirement	Pass	Antenna connector is MHF not a standard connector.

*For U-NII-3 band compliance with rule part 15.407(b)(4)(i), the OOB test plots were recorded in Annex A.

2.1 Measurement Uncertainty

Where relevant, the following measurement uncertainty levels have been estimated for tests performed on the EUT as specified in CISPR 16-4-2:

Measurement	Frequency	Expanded Uncertainty (k=2) (±)
Conducted Emissions at mains ports	150kHz ~ 30MHz	1.83 dB
Radiated Emissions up to 1 GHz	30MHz ~ 1GHz	5.34 dB
Radiated Emissions above 1 GHz	1GHz ~ 6GHz	3.41 dB
	6GHz ~ 18GHz	3.49 dB
	18GHz ~ 40GHz	3.30 dB

2.2 Modification Record

There were no modifications required for compliance.

3 General Information

3.1 General Description of EUT

Product	Omna 180Cam HD
Brand	D-Link
Test Model	DSH-C310
Status of EUT	ENGINEERING SAMPLE
Power Supply Rating	DC 5V from adapter
Modulation Type	CCK, DQPSK, DBPSK for DSSS 64QAM, 16QAM, QPSK, BPSK for OFDM 256QAM for OFDM in 11ac mode only
Modulation Technology	DSSS, OFDM
Transfer Rate	802.11b: up to 11Mbps 802.11a/g: up to 54Mbps 802.11n: up to 150Mbps 802.11ac: up to 433.3Mbps
Operating Frequency	2.4GHz: 2.412 ~ 2.462GHz 5GHz: 5.18 ~ 5.24GHz, 5.745 ~ 5.825GHz
Number of Channel	2.4GHz: 802.11b, 802.11g, 802.11n (HT20): 11 5GHz: 802.11a, 802.11n (HT20), 802.11ac (VHT20): 9 802.11n (HT40), 802.11ac (VHT40): 4 802.11ac (VHT80): 2
Output Power	2.4GHz: 349.14mW 5GHz: 5.18GHz ~ 5.24GHz: 221.82mW 5.745GHz ~ 5.825GHz: 224.905mW
Antenna Type	Refer to Note
Antenna Connector	Refer to Note
Accessory Device	Adapter x 1
Data Cable Supplied	NA

Note:

- 2.4GHz and 5GHz technology cannot transmit at same time.
- The antenna provided to the EUT, please refer to the following table:

Brand	Model	Antenna Net Gain(dBi)	Frequency range (GHz ~ GHz)	Antenna Type	Connector Type	Cable Length (mm)
Mgear	C037-511444-A	2.4	2.4~2.4835	PCB	MHF	56.5
		4.8	5.15~5.85			

- The EUT must be supplied with a power adapter and following below table:

Brand	Model No.	Spec.
D-Link	WB-10E05R	Input: 100-240V, 0.4A, 50-60Hz Output: 5V, 2A DC output cable (unshielded, 3m)

4. The EUT incorporates a SISO function.

2.4GHz Band			
MODULATION MODE	DATA RATE (MCS)	TX & RX CONFIGURATION	
802.11b	1 ~ 11Mbps	1TX	1RX
802.11g	6 ~ 54Mbps	1TX	1RX
802.11n (HT20)	MCS 0~7	1TX	1RX
5GHz Band			
MODULATION MODE	DATA RATE (MCS)	TX & RX CONFIGURATION	
802.11a	6 ~ 54Mbps	1TX	1RX
802.11n (HT20)	MCS 0~7	1TX	1RX
802.11n (HT40)	MCS 0~7	1TX	1RX
802.11ac (VHT20)	MCS 0~8, Nss=1	1TX	1RX
802.11ac (VHT40)	MCS 0~9, Nss=1	1TX	1RX
802.11ac (VHT80)	MCS 0~9, Nss=1	1TX	1RX

5. The above EUT information is declared by manufacturer and for more detailed features description, please refer to the manufacturer's specifications or user's manual.

3.2 Description of Test Modes

FOR 5180 ~ 5240MHz

4 channels are provided for 802.11a, 802.11n (HT20), 802.11ac (VHT20):

Channel	Frequency	Channel	Frequency
36	5180MHz	44	5220MHz
40	5200MHz	48	5240MHz

2 channels are provided for 802.11n (HT40), 802.11ac (VHT40):

Channel	Frequency	Channel	Frequency
38	5190MHz	46	5230MHz

1 channel is provided for 802.11ac (VHT80):

Channel	Frequency
42	5210MHz

FOR 5745 ~ 5825MHz:

5 channels are provided for 802.11a, 802.11n (HT20), 802.11ac (VHT20):

Channel	Frequency	Channel	Frequency
149	5745MHz	161	5805MHz
153	5765MHz	165	5825MHz
157	5785MHz		

2 channels are provided for 802.11n (HT40), 802.11ac (VHT40):

Channel	Frequency	Channel	Frequency
151	5755MHz	159	5795MHz

1 channel is provided for 802.11ac (VHT80):

Channel	Frequency
155	5775MHz

3.2.1 Test Mode Applicability and Tested Channel Detail

EUT Configure Mode	Applicable To				Description
	RE \geq 1G	RE $<$ 1G	PLC	APCM	
-	√	√	√	√	-

Where **RE \geq 1G**: Radiated Emission above 1GHz **RE $<$ 1G**: Radiated Emission below 1GHz
PLC: Power Line Conducted Emission **APCM**: Antenna Port Conducted Measurement

Radiated Emission Test (Above 1GHz):

- Pre-Scan has been conducted to determine the worst-case mode from all possible combinations between available modulations, data rates and antenna ports (if EUT with antenna diversity architecture).
- Following channel(s) was (were) selected for the final test as listed below.

Mode	FREQ. Band (MHz)	Available Channel	Tested Channel	Modulation Technology	Modulation Type	Data Rate (Mbps)
802.11a	5180-5240	36 to 48	36, 40, 48	OFDM	BPSK	6
802.11ac (VHT20)		36 to 48	36, 40, 48	OFDM	BPSK	6.5
802.11ac (VHT40)		38 to 46	38, 46	OFDM	BPSK	13.5
802.11ac (VHT80)		42	42	OFDM	BPSK	29.3
802.11a	5745-5825	149 to 165	149, 157, 165	OFDM	BPSK	6
802.11ac (VHT20)		149 to 165	149, 157, 165	OFDM	BPSK	6.5
802.11ac (VHT40)		151 to 159	151, 159	OFDM	BPSK	13.5
802.11ac (VHT80)		155	155	OFDM	BPSK	29.3

Radiated Emission Test (Below 1GHz):

- Pre-Scan has been conducted to determine the worst-case mode from all possible combinations between available modulations, data rates and antenna ports (if EUT with antenna diversity architecture).
- Following channel(s) was (were) selected for the final test as listed below.

Mode	FREQ. Band (MHz)	Available Channel	Tested Channel	Modulation Technology	Modulation Type	Data Rate (Mbps)
802.11a	5180-5240	36 to 48	157	OFDM	BPSK	6
	5745-5825	149 to 165				

Power Line Conducted Emission Test:

- Pre-Scan has been conducted to determine the worst-case mode from all possible combinations between available modulations, data rates and antenna ports (if EUT with antenna diversity architecture).
- Following channel(s) was (were) selected for the final test as listed below.

Mode	FREQ. Band (MHz)	Available Channel	Tested Channel	Modulation Technology	Modulation Type	Data Rate (Mbps)
802.11a	5180-5240	36 to 48	157	OFDM	BPSK	6
	5745-5825	149 to 165				

Antenna Port Conducted Measurement:

- This item includes all test value of each mode, but only includes spectrum plot of worst value of each mode.
- Pre-Scan has been conducted to determine the worst-case mode from all possible combinations between available modulations, data rates and antenna ports (if EUT with antenna diversity architecture).
- Following channel(s) was (were) selected for the final test as listed below.

Mode	FREQ. Band (MHz)	Available Channel	Tested Channel	Modulation Technology	Modulation Type	Data Rate (Mbps)
802.11a	5180-5240	36 to 48	36, 40, 48	OFDM	BPSK	6
802.11ac (VHT20)		36 to 48	36, 40, 48	OFDM	BPSK	6.5
802.11ac (VHT40)		38 to 46	38, 46	OFDM	BPSK	13.5
802.11ac (VHT80)		42	42	OFDM	BPSK	29.3
802.11a	5745-5825	149 to 165	149, 157, 165	OFDM	BPSK	6
802.11ac (VHT20)		149 to 165	149, 157, 165	OFDM	BPSK	6.5
802.11ac (VHT40)		151 to 159	151, 159	OFDM	BPSK	13.5
802.11ac (VHT80)		155	155	OFDM	BPSK	29.3

Test Condition:

APPLICABLE TO	ENVIRONMENTAL CONDITIONS	INPUT POWER	TESTED BY
RE \geq 1G	22deg. C, 64%RH	120Vac, 60Hz	Andy Ho
RE $<$ 1G	25deg. C, 66%RH	120Vac, 60Hz	Gary Cheng
PLC	23deg. C, 73%RH	120Vac, 60Hz	Barry Lee
APCM	25deg. C, 60%RH	120Vac, 60Hz	Tim Ho

3.3 Duty Cycle of Test Signal

If duty cycle of test signal is $\geq 98\%$, duty factor is not required.
 If duty cycle of test signal is $< 98\%$, duty factor shall be considered.

802.11a: Duty cycle = $1.439 \text{ ms} / 1.466 \text{ ms} = 0.982$

802.11ac (VHT20): Duty cycle = $1.358 \text{ ms} / 1.386 \text{ ms} = 0.98$

802.11ac (VHT40): Duty cycle = $0.674 \text{ ms} / 0.701 \text{ ms} = 0.961$, Duty factor = $10 * \log(1/0.961) = 0.17$

802.11ac (VHT80): Duty cycle = $0.335 \text{ ms} / 0.361 \text{ ms} = 0.928$, Duty factor = $10 * \log(1/0.928) = 0.32$

802.11a **802.11ac (VHT20)**

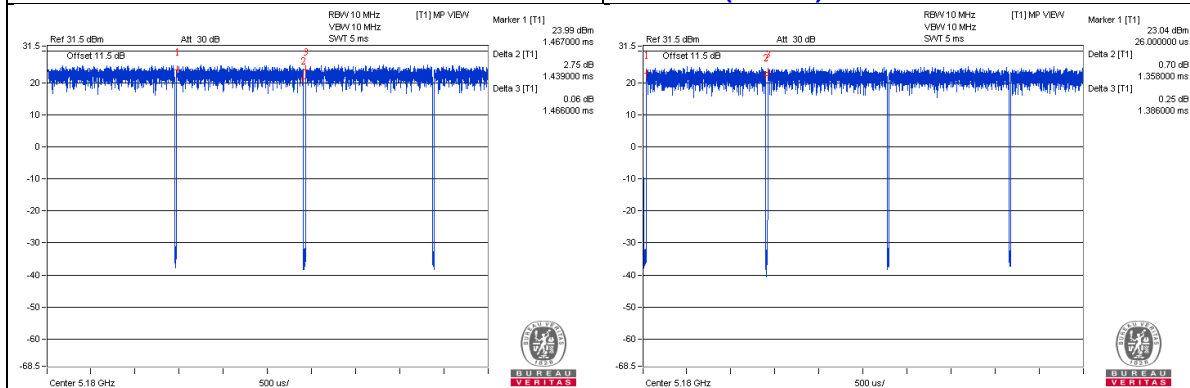

802.11ac (VHT40) **802.11ac (VHT80)**

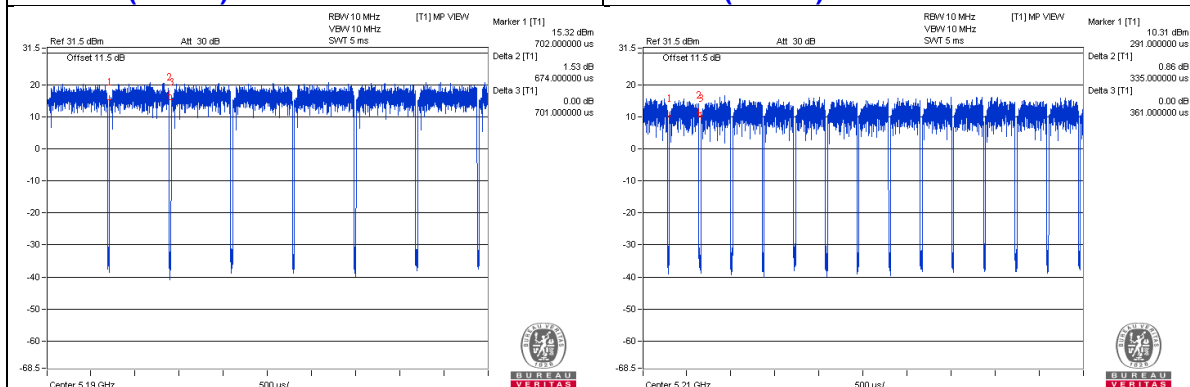

3.4 Description of Support Units

The EUT has been tested as an independent unit together with other necessary accessories or support units. The following support units or accessories were used to form a representative test configuration during the tests.

ID	Product	Brand	Model No.	Serial No.	FCC ID	Remarks
A.	Micro SD Card	SanDisk	NA	NA	NA	Provided by Lab

Note:

1. All power cords of the above support units are non-shielded (1.8m).

ID	Descriptions	Qty.	Length (m)	Shielding (Yes/No)	Cores (Qty.)	Remarks
1.	DC Cable	1	3	No	0	Supplied by client
2.	Console Cable	1	0.1	No	0	Supplied by client(for RF Setup)

3.4.1 Configuration of System under Test

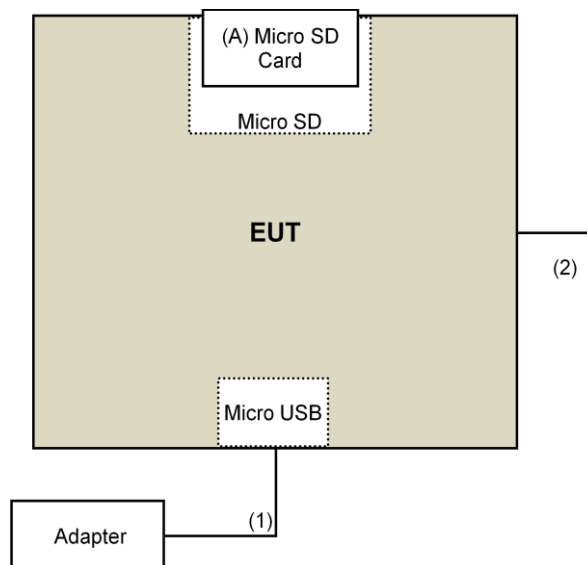

3.5 General Description of Applied Standard

The EUT is a RF Product. According to the specifications of the manufacturer, it must comply with the requirements of the following standards:

FCC Part 15, Subpart E (15.407)
KDB 789033 D02 General UNII Test Procedure New Rules v01r03
ANSI C63.10-2013

All test items have been performed and recorded as per the above standards.

NOTE: The EUT has been verified to comply with the requirements of FCC Part 15, Subpart B, Class B (DoC). The test report has been issued separately.

4 Test Types and Results

4.1 Radiated Emission and Bandedge Measurement

4.1.1 Limits of Radiated Emission and Bandedge Measurement

Radiated emissions which fall in the restricted bands must comply with the radiated emission limits specified as below table.

Frequencies (MHz)	Field Strength (microvolts/meter)	Measurement Distance (meters)
0.009 ~ 0.490	2400/F(kHz)	300
0.490 ~ 1.705	24000/F(kHz)	30
1.705 ~ 30.0	30	30
30 ~ 88	100	3
88 ~ 216	150	3
216 ~ 960	200	3
Above 960	500	3

NOTE:

1. The lower limit shall apply at the transition frequencies.
2. Emission level (dBuV/m) = 20 log Emission level (uV/m).
3. For frequencies above 1000MHz, the field strength limits are based on average detector, however, the peak field strength of any emission shall not exceed the maximum permitted average limits, specified above by more than 20dB under any condition of modulation.

Limits of unwanted emission out of the restricted bands

Applicable To		Limit	
789033 D02 General UNII Test Procedure New Rules v01r03		Field Strength at 3m	
		PK:74 (dBuV/m)	AV:54 (dBuV/m)
Frequency Band	Applicable To	EIRP Limit	Equivalent Field Strength at 3m
5150~5250 MHz	15.407(b)(1)	PK:-27 (dBm/MHz)	PK:68.2(dBuV/m)
5250~5350 MHz	15.407(b)(2)		
5470~5725 MHz	15.407(b)(3)		
5725~5850 MHz	<input checked="" type="checkbox"/> 15.407(b)(4)(i)	PK:-27 (dBm/MHz) ^{*1} PK:10 (dBm/MHz) ^{*2} PK:15.6 (dBm/MHz) ^{*3} PK:27 (dBm/MHz) ^{*4}	PK: 68.2(dBuV/m) ^{*1} PK:105.2 (dBuV/m) ^{*2} PK: 110.8(dBuV/m) ^{*3} PK:122.2 (dBuV/m) ^{*4}
	<input type="checkbox"/> 15.407(b)(4)(ii)	Emission limits in section 15.247(d)	
^{*1} beyond 75 MHz or more above of the band edge.		^{*2} below the band edge increasing linearly to 10 dBm/MHz at 25 MHz above.	
^{*3} below the band edge increasing linearly to a level of 15.6 dBm/MHz at 5 MHz above.		^{*4} from 5 MHz above or below the band edge increasing linearly to a level of 27 dBm/MHz at the band edge.	

Note:

The following formula is used to convert the equipment isotropic radiated power (eirp) to field strength:

$$E = \frac{1000000\sqrt{30P}}{3} \mu\text{V/m, where } P \text{ is the eirp (Watts).}$$

4.1.2 Test Instruments

DESCRIPTION & MANUFACTURER	MODEL NO.	SERIAL NO.	CALIBRATED DATE	CALIBRATED UNTIL
Test Receiver Keysight	N9038A	MY54450088	July 20, 2016	July 19, 2017
Pre-Amplifier ^(*) EMCI	EMC001340	980142	Jan. 20, 2016	Jan. 19, 2018
Loop Antenna ^(*) Electro-Metrics	EM-6879	264	Dec. 16, 2014	Dec. 15, 2016
RF Cable	NA	LOOPCAB-001 LOOPCAB-002	Jan. 18, 2016	Jan. 17, 2017
Pre-Amplifier Mini-Circuits	ZFL-1000VH2B	AMP-ZFL-01	Nov. 11, 2015	Nov. 10, 2016
Trilog Broadband Antenna SCHWARZBECK	VULB 9168	9168-406	Jan. 04, 2016	Jan. 03, 2017
RF Cable	8D	966-4-1 966-4-2 966-4-3	Apr. 02, 2016	Apr. 01, 2017
Fixed attenuator Mini-Circuits	UNAT-5+	PAD-3m-4-01	Oct. 05, 2016	Oct. 04, 2017
Horn_Antenna SCHWARZBECK	BBHA 9120D	9120D-783	Jan. 19, 2016	Jan. 18, 2017
Pre-Amplifier Agilent	8449B	3008A01922	Sep. 18, 2016	Sep. 17, 2017
RF Cable	EMC104-SM-SM-2000 EMC104-SM-SM-5000 EMC104-SM-SM-5000	150318 150323 150324	Mar. 30, 2016	Mar. 29, 2017
Pre-Amplifier EMCI	EMC184045	980143	Jan. 15, 2016	Jan. 14, 2017
Horn_Antenna SCHWARZBECK	BBHA 9170	BBHA9170608	Jan. 08, 2016	Jan. 07, 2017
RF Cable	SUCOFLEX 102	36432/2 36441/2	Jan. 16, 2016	Jan. 15, 2017
Software	ADT_Radiated_V8.7.08	NA	NA	NA
Antenna Tower & Turn Table Max-Full	MF-7802	MF780208410	NA	NA
Boresight Antenna Fixture	FBA-01	FBA-SIP02	NA	NA
Spectrum Analyzer R&S	FSv40	100964	June 28, 2016	June 27, 2017
Power meter Anritsu	ML2495A	1014008	May 05, 2016	May 04, 2017
Power sensor Anritsu	MA2411B	0917122	May 05, 2016	May 04, 2017
AC Power Source Extech Electronics	6205	1440452	NA	NA
Temperature & Humidity Chamber Giant Force	GTH-150-40-SP-AR	MAA0812-008	Jan. 15, 2016	Jan. 14, 2017
Digital Multimeter FLUKE	87III	73680266	Nov. 10, 2015	Nov. 09, 2016

Note:

1. The calibration interval of the above test instruments is 12 months and the calibrations are traceable to NML/ROC and NIST/USA.
2. *The calibration interval of the above test instruments is 24 months and the calibrations are traceable to NML/ROC and NIST/USA.
3. The test was performed in 966 Chamber No. 4.
4. The FCC Site Registration No. is 292998
5. The CANADA Site Registration No. is 20331-2
6. Tested Date: Oct. 31 to Nov. 03, 2016

4.1.3 Test Procedure

For Radiated emission below 30MHz

- a. The EUT was placed on the top of a rotating table 0.8 meters above the ground at a 3 meter chamber room. The table was rotated 360 degrees to determine the position of the highest radiation.
- b. The EUT was set 3 meters away from the interference-receiving antenna, which was mounted on the top of a variable-height antenna tower.
- c. Both X and Y axes of the antenna are set to make the measurement.
- d. For each suspected emission, the EUT was arranged to its worst case and the rotatable table was turned from 0 degrees to 360 degrees to find the maximum reading.
- e. The test-receiver system was set to Quasi-Peak Detect Function and Specified Bandwidth with Maximum Hold Mode.

NOTE:

1. The resolution bandwidth and video bandwidth of test receiver/spectrum analyzer is 9kHz at frequency below 30MHz.

For Radiated emission above 30MHz

- a. The EUT was placed on the top of a rotating table 0.8 meters (for 30MHz ~ 1GHz) / 1.5 meters (for above 1GHz) above the ground at 3 meter chamber room for test. The table was rotated 360 degrees to determine the position of the highest radiation.
- b. The EUT was set 3 meters away from the interference-receiving antenna, which was mounted on the top of a variable-height antenna tower.
- c. The height of antenna is varied from one meter to four meters above the ground to determine the maximum value of the field strength. Both horizontal and vertical polarizations of the antenna are set to make the measurement.
- d. For each suspected emission, the EUT was arranged to its worst case and then the antenna was tuned to heights from 1 meter to 4 meters and the rotatable table was turned from 0 degrees to 360 degrees to find the maximum reading.
- e. The test-receiver system was set to quasi-peak detect function and specified bandwidth with maximum hold mode when the test frequency is below 1 GHz.
- f. The test-receiver system was set to peak and average detect function and specified bandwidth with maximum hold mode when the test frequency is above 1 GHz. If the peak reading value also meets average limit, measurement with the average detector is unnecessary.

Note:

1. The resolution bandwidth and video bandwidth of test receiver/spectrum analyzer is 120kHz for Quasi-peak detection (QP) at frequency below 1GHz.
2. The resolution bandwidth of test receiver/spectrum analyzer is 1 MHz and the video bandwidth is 3 MHz for Peak detection (PK) at frequency above 1GHz.
3. The resolution bandwidth of test receiver/spectrum analyzer is 1MHz and the video bandwidth is $\geq 1/T$ (Duty cycle < 98%) or 10Hz (Duty cycle $\geq 98\%$) for Average detection (AV) at frequency above 1GHz.
4. All modes of operation were investigated and the worst-case emissions are reported.

4.1.4 Deviation from Test Standard

No deviation.

4.1.5 Test Setup

For Radiated emission below 30MHz

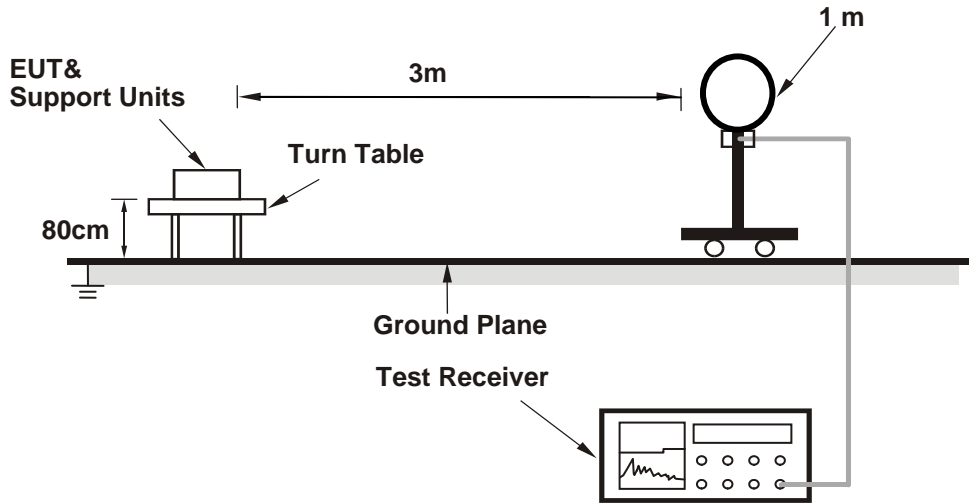

For Radiated emission 30MHz to 1GHz

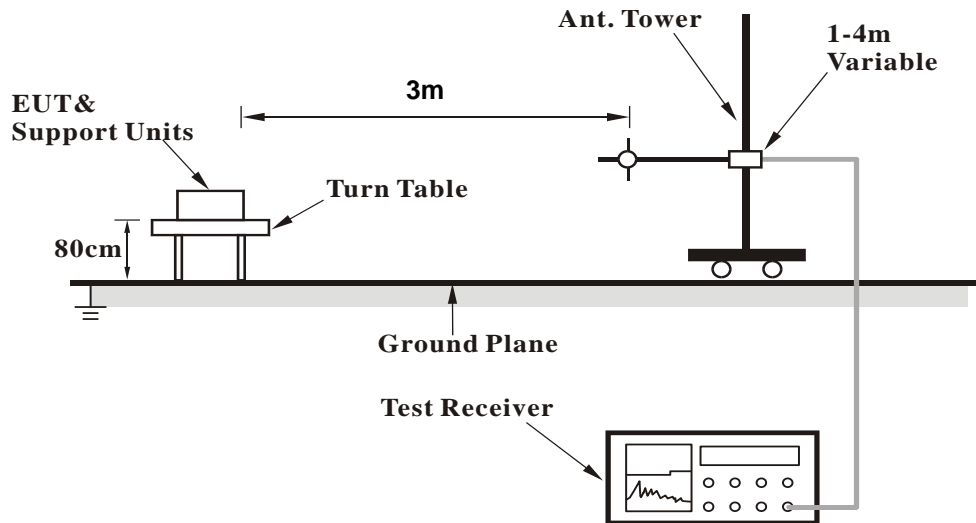

For Radiated emission above 1GHz

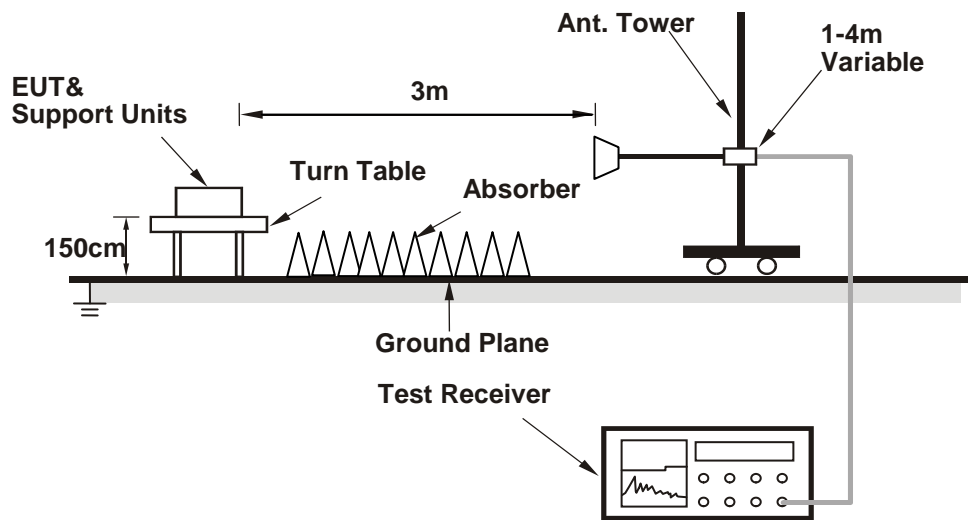

For the actual test configuration, please refer to the attached file (Test Setup Photo).

4.1.6 EUT Operating Condition

- a. Controlling software ((QA Tool MT76xxE)Ver:2.0.10.3) has been activated to set the EUT on specific status.

4.1.7 Test Results

Above 1GHz Data:

802.11a

CHANNEL	TX Channel 36	DETECTOR FUNCTION	Peak (PK)
FREQUENCY RANGE	1GHz ~ 40GHz		Average (AV)

ANTENNA POLARITY & TEST DISTANCE: HORIZONTAL AT 3 M

NO.	FREQ. (MHz)	EMISSION LEVEL (dBuV/m)	LIMIT (dBuV/m)	MARGIN (dB)	ANTENNA HEIGHT (m)	TABLE ANGLE (Degree)	RAW VALUE (dBuV)	CORRECTION FACTOR (dB/m)
1	5150.00	68.0 PK	74.0	-6.0	1.95 H	360	66.5	1.5
2	5150.00	53.8 AV	54.0	-0.2	1.95 H	360	52.3	1.5
3	*5180.00	110.8 PK			1.95 H	360	109.2	1.6
4	*5180.00	101.2 AV			1.95 H	360	99.6	1.6
5	#10360.00	59.5 PK	74.0	-14.5	3.35 H	360	48.0	11.5
6	#10360.00	46.7 AV	54.0	-7.3	3.35 H	360	35.2	11.5
7	15540.00	52.2 PK	74.0	-21.8	1.51 H	360	39.1	13.1
8	15540.00	39.7 AV	54.0	-14.3	1.51 H	360	26.6	13.1

ANTENNA POLARITY & TEST DISTANCE: VERTICAL AT 3 M

NO.	FREQ. (MHz)	EMISSION LEVEL (dBuV/m)	LIMIT (dBuV/m)	MARGIN (dB)	ANTENNA HEIGHT (m)	TABLE ANGLE (Degree)	RAW VALUE (dBuV)	CORRECTION FACTOR (dB/m)
1	5150.00	67.6 PK	74.0	-6.4	2.14 V	35	66.1	1.5
2	5150.00	52.3 AV	54.0	-1.7	2.14 V	35	50.8	1.5
3	*5180.00	110.6 PK			2.14 V	35	109.0	1.6
4	*5180.00	100.3 AV			2.14 V	35	98.7	1.6
5	#10360.00	63.2 PK	74.0	-10.8	2.34 V	229	51.7	11.5
6	#10360.00	49.4 AV	54.0	-4.6	2.34 V	229	37.9	11.5
7	15540.00	51.8 PK	74.0	-22.2	1.68 V	243	38.7	13.1
8	15540.00	39.5 AV	54.0	-14.5	1.68 V	243	26.4	13.1

REMARKS:

1. Emission Level(dBuV/m) = Raw Value(dBuV) + Correction Factor(dB/m)
2. Correction Factor(dB/m) = Antenna Factor(dB/m) + Cable Factor(dB) – Pre-Amplifier Factor(dB)
3. The other emission levels were very low against the limit.
4. Margin value = Emission Level – Limit value
5. " * ": Fundamental frequency.
6. " # ": The radiated frequency is out of the restricted band.

CHANNEL	TX Channel 40	DETECTOR FUNCTION	Peak (PK)
FREQUENCY RANGE	1GHz ~ 40GHz		Average (AV)

ANTENNA POLARITY & TEST DISTANCE: HORIZONTAL AT 3 M

NO.	FREQ. (MHz)	EMISSION LEVEL (dBuV/m)	LIMIT (dBuV/m)	MARGIN (dB)	ANTENNA HEIGHT (m)	TABLE ANGLE (Degree)	RAW VALUE (dBuV)	CORRECTION FACTOR (dB/m)
1	5150.00	64.4 PK	74.0	-9.6	2.90 H	6	62.9	1.5
2	5150.00	51.5 AV	54.0	-2.5	2.90 H	6	50.0	1.5
3	*5200.00	114.0 PK			2.90 H	6	112.3	1.7
4	*5200.00	103.9 AV			2.90 H	6	102.2	1.7
5	5460.00	55.6 PK	74.0	-18.4	2.90 H	6	53.5	2.1
6	5460.00	43.0 AV	54.0	-11.0	2.90 H	6	40.9	2.1
7	#10400.00	60.1 PK	74.0	-13.9	3.33 H	360	48.5	11.6
8	#10400.00	47.0 AV	54.0	-7.0	3.33 H	360	35.4	11.6
9	15600.00	52.1 PK	74.0	-21.9	1.53 H	360	39.0	13.1
10	15600.00	39.5 AV	54.0	-14.5	1.53 H	360	26.4	13.1

ANTENNA POLARITY & TEST DISTANCE: VERTICAL AT 3 M

NO.	FREQ. (MHz)	EMISSION LEVEL (dBuV/m)	LIMIT (dBuV/m)	MARGIN (dB)	ANTENNA HEIGHT (m)	TABLE ANGLE (Degree)	RAW VALUE (dBuV)	CORRECTION FACTOR (dB/m)
1	5150.00	61.3 PK	74.0	-12.7	2.16 V	36	59.8	1.5
2	5150.00	47.5 AV	54.0	-6.5	2.16 V	36	46.0	1.5
3	*5200.00	112.0 PK			2.16 V	36	110.3	1.7
4	*5200.00	101.5 AV			2.16 V	36	99.8	1.7
5	5460.00	53.9 PK	74.0	-20.1	2.16 V	36	51.8	2.1
6	5460.00	41.2 AV	54.0	-12.8	2.16 V	36	39.1	2.1
7	#10400.00	62.9 PK	74.0	-11.1	2.37 V	215	51.3	11.6
8	#10400.00	49.2 AV	54.0	-4.8	2.37 V	215	37.6	11.6
9	15600.00	51.9 PK	74.0	-22.1	1.66 V	231	38.8	13.1
10	15600.00	39.3 AV	54.0	-14.7	1.66 V	231	26.2	13.1

REMARKS:

1. Emission Level(dBuV/m) = Raw Value(dBuV) + Correction Factor(dB/m)
2. Correction Factor(dB/m) = Antenna Factor(dB/m) + Cable Factor(dB) – Pre-Amplifier Factor(dB)
3. The other emission levels were very low against the limit.
4. Margin value = Emission Level – Limit value
5. " * ": Fundamental frequency.
6. " # ": The radiated frequency is out of the restricted band.

CHANNEL	TX Channel 48	DETECTOR FUNCTION	Peak (PK)
FREQUENCY RANGE	1GHz ~ 40GHz		Average (AV)

ANTENNA POLARITY & TEST DISTANCE: HORIZONTAL AT 3 M

NO.	FREQ. (MHz)	EMISSION LEVEL (dBuV/m)	LIMIT (dBuV/m)	MARGIN (dB)	ANTENNA HEIGHT (m)	TABLE ANGLE (Degree)	RAW VALUE (dBuV)	CORRECTION FACTOR (dB/m)
1	*5240.00	114.7 PK			2.76 H	360	113.1	1.6
2	*5240.00	103.2 AV			2.76 H	360	101.6	1.6
3	5350.00	54.7 PK	74.0	-19.3	2.76 H	360	52.8	1.9
4	5350.00	43.3 AV	54.0	-10.7	2.76 H	360	41.4	1.9
5	#10480.00	60.3 PK	74.0	-13.7	3.39 H	360	48.3	12.0
6	#10480.00	47.3 AV	54.0	-6.7	3.39 H	360	35.3	12.0
7	15720.00	51.8 PK	74.0	-22.2	1.55 H	360	38.6	13.2
8	15720.00	39.2 AV	54.0	-14.8	1.55 H	360	26.0	13.2

ANTENNA POLARITY & TEST DISTANCE: VERTICAL AT 3 M

NO.	FREQ. (MHz)	EMISSION LEVEL (dBuV/m)	LIMIT (dBuV/m)	MARGIN (dB)	ANTENNA HEIGHT (m)	TABLE ANGLE (Degree)	RAW VALUE (dBuV)	CORRECTION FACTOR (dB/m)
1	*5240.00	111.4 PK			2.13 V	38	109.8	1.6
2	*5240.00	101.2 AV			2.13 V	38	99.6	1.6
3	5350.00	52.3 PK	74.0	-21.7	2.13 V	38	50.4	1.9
4	5350.00	41.2 AV	54.0	-12.8	2.13 V	38	39.3	1.9
5	#10480.00	62.8 PK	74.0	-11.2	2.32 V	208	50.8	12.0
6	#10480.00	49.0 AV	54.0	-5.0	2.32 V	208	37.0	12.0
7	15720.00	52.2 PK	74.0	-21.8	1.64 V	240	39.0	13.2
8	15720.00	39.4 AV	54.0	-14.6	1.64 V	240	26.2	13.2

REMARKS:

1. Emission Level(dBuV/m) = Raw Value(dBuV) + Correction Factor(dB/m)
2. Correction Factor(dB/m) = Antenna Factor(dB/m) + Cable Factor(dB) – Pre-Amplifier Factor(dB)
3. The other emission levels were very low against the limit.
4. Margin value = Emission Level – Limit value
5. " * ": Fundamental frequency.
6. " # ": The radiated frequency is out of the restricted band.

CHANNEL	TX Channel 149	DETECTOR FUNCTION	Peak (PK)
FREQUENCY RANGE	1GHz ~ 40GHz		Average (AV)

ANTENNA POLARITY & TEST DISTANCE: HORIZONTAL AT 3 M

NO.	FREQ. (MHz)	EMISSION LEVEL (dBuV/m)	LIMIT (dBuV/m)	MARGIN (dB)	ANTENNA HEIGHT (m)	TABLE ANGLE (Degree)	RAW VALUE (dBuV)	CORRECTION FACTOR (dB/m)
1	#5656.87	63.5 PK	73.3	-9.8	1.90 H	34	61.0	2.5
2	*5745.00	113.7 PK			1.90 H	34	111.0	2.7
3	*5745.00	102.6 AV			1.90 H	34	99.9	2.7
4	#5973.23	57.9 PK	68.2	-10.3	1.90 H	34	54.9	3.0
5	11490.00	66.3 PK	74.0	-7.7	2.70 H	23	52.9	13.4
6	11490.00	52.9 AV	54.0	-1.1	2.70 H	23	39.5	13.4
7	#17235.00	56.1 PK	74.0	-17.9	1.68 H	227	37.8	18.3
8	#17235.00	43.8 AV	54.0	-10.2	1.68 H	227	25.5	18.3

ANTENNA POLARITY & TEST DISTANCE: VERTICAL AT 3 M

NO.	FREQ. (MHz)	EMISSION LEVEL (dBuV/m)	LIMIT (dBuV/m)	MARGIN (dB)	ANTENNA HEIGHT (m)	TABLE ANGLE (Degree)	RAW VALUE (dBuV)	CORRECTION FACTOR (dB/m)
1	#5627.43	58.4 PK	68.2	-9.8	1.79 V	34	55.9	2.5
2	*5745.00	112.7 PK			1.79 V	34	110.0	2.7
3	*5745.00	101.5 AV			1.79 V	34	98.8	2.7
4	#6002.68	57.1 PK	68.2	-11.1	1.79 V	34	53.8	3.3
5	11490.00	62.7 PK	74.0	-11.3	1.01 V	126	49.3	13.4
6	11490.00	50.5 AV	54.0	-3.5	1.01 V	126	37.1	13.4
7	#17235.00	56.1 PK	74.0	-17.9	1.48 V	360	37.8	18.3
8	#17235.00	44.1 AV	54.0	-9.9	1.48 V	360	25.8	18.3

REMARKS:

1. Emission Level(dBuV/m) = Raw Value(dBuV) + Correction Factor(dB/m)
2. Correction Factor(dB/m) = Antenna Factor(dB/m) + Cable Factor(dB) – Pre-Amplifier Factor(dB)
3. The other emission levels were very low against the limit.
4. Margin value = Emission Level – Limit value
5. " * ": Fundamental frequency.
6. " # ": The radiated frequency is out of the restricted band.

CHANNEL	TX Channel 157	DETECTOR FUNCTION	Peak (PK)
FREQUENCY RANGE	1GHz ~ 40GHz		Average (AV)

ANTENNA POLARITY & TEST DISTANCE: HORIZONTAL AT 3 M

NO.	FREQ. (MHz)	EMISSION LEVEL (dBuV/m)	LIMIT (dBuV/m)	MARGIN (dB)	ANTENNA HEIGHT (m)	TABLE ANGLE (Degree)	RAW VALUE (dBuV)	CORRECTION FACTOR (dB/m)
1	#5655.93	56.7 PK	72.6	-15.9	2.02 H	360	54.2	2.5
2	*5785.00	113.5 PK			2.02 H	360	110.8	2.7
3	*5785.00	102.7 AV			2.02 H	360	100.0	2.7
4	#5954.23	56.3 PK	68.2	-11.9	2.02 H	360	53.3	3.0
5	11570.00	67.0 PK	74.0	-7.0	2.66 H	24	53.9	13.1
6	11570.00	53.4 AV	54.0	-0.6	2.66 H	24	40.3	13.1
7	#17355.00	56.6 PK	74.0	-17.4	1.70 H	244	37.8	18.8
8	#17355.00	44.1 AV	54.0	-9.9	1.70 H	244	25.3	18.8

ANTENNA POLARITY & TEST DISTANCE: VERTICAL AT 3 M

NO.	FREQ. (MHz)	EMISSION LEVEL (dBuV/m)	LIMIT (dBuV/m)	MARGIN (dB)	ANTENNA HEIGHT (m)	TABLE ANGLE (Degree)	RAW VALUE (dBuV)	CORRECTION FACTOR (dB/m)
1	#5603.20	57.3 PK	68.2	-10.9	1.74 V	30	54.9	2.4
2	*5785.00	112.5 PK			1.74 V	30	109.8	2.7
3	*5785.00	101.3 AV			1.74 V	30	98.6	2.7
4	#6000.30	56.6 PK	68.2	-11.6	1.74 V	30	53.3	3.3
5	11570.00	62.6 PK	74.0	-11.4	1.08 V	104	49.5	13.1
6	11570.00	50.4 AV	54.0	-3.6	1.08 V	104	37.3	13.1
7	#17355.00	56.2 PK	74.0	-17.8	1.49 V	360	37.4	18.8
8	#17355.00	43.9 AV	54.0	-10.1	1.49 V	360	25.1	18.8

REMARKS:

1. Emission Level(dBuV/m) = Raw Value(dBuV) + Correction Factor(dB/m)
2. Correction Factor(dB/m) = Antenna Factor(dB/m) + Cable Factor(dB) – Pre-Amplifier Factor(dB)
3. The other emission levels were very low against the limit.
4. Margin value = Emission Level – Limit value
5. " * ": Fundamental frequency.
6. " # ": The radiated frequency is out of the restricted band.

CHANNEL	TX Channel 165	DETECTOR FUNCTION	Peak (PK)
FREQUENCY RANGE	1GHz ~ 40GHz		Average (AV)

ANTENNA POLARITY & TEST DISTANCE: HORIZONTAL AT 3 M

NO.	FREQ. (MHz)	EMISSION LEVEL (dBuV/m)	LIMIT (dBuV/m)	MARGIN (dB)	ANTENNA HEIGHT (m)	TABLE ANGLE (Degree)	RAW VALUE (dBuV)	CORRECTION FACTOR (dB/m)
1	#5635.50	56.2 PK	68.2	-12.0	1.97 H	25	53.7	2.5
2	*5825.00	113.7 PK			1.97 H	25	111.0	2.7
3	*5825.00	103.1 AV			1.97 H	25	100.4	2.7
4	#5916.23	60.8 PK	74.7	-13.9	1.97 H	25	57.9	2.9
5	11650.00	66.5 PK	74.0	-7.5	2.65 H	27	53.4	13.1
6	11650.00	52.9 AV	54.0	-1.1	2.65 H	27	39.8	13.1
7	#17475.00	56.5 PK	74.0	-17.5	1.67 H	233	37.3	19.2
8	#17475.00	44.2 AV	54.0	-9.8	1.67 H	233	25.0	19.2

ANTENNA POLARITY & TEST DISTANCE: VERTICAL AT 3 M

NO.	FREQ. (MHz)	EMISSION LEVEL (dBuV/m)	LIMIT (dBuV/m)	MARGIN (dB)	ANTENNA HEIGHT (m)	TABLE ANGLE (Degree)	RAW VALUE (dBuV)	CORRECTION FACTOR (dB/m)
1	#5601.77	56.7 PK	68.2	-11.5	1.71 V	21	54.3	2.4
2	*5825.00	112.7 PK			1.71 V	21	110.0	2.7
3	*5825.00	101.8 AV			1.71 V	21	99.1	2.7
4	#5966.57	55.8 PK	68.2	-12.4	1.71 V	21	52.8	3.0
5	11650.00	62.5 PK	74.0	-11.5	1.04 V	118	49.4	13.1
6	11650.00	50.3 AV	54.0	-3.7	1.04 V	118	37.2	13.1
7	#17475.00	56.4 PK	74.0	-17.6	1.50 V	360	37.2	19.2
8	#17475.00	44.3 AV	54.0	-9.7	1.50 V	360	25.1	19.2

REMARKS:

1. Emission Level(dBuV/m) = Raw Value(dBuV) + Correction Factor(dB/m)
2. Correction Factor(dB/m) = Antenna Factor(dB/m) + Cable Factor(dB) – Pre-Amplifier Factor(dB)
3. The other emission levels were very low against the limit.
4. Margin value = Emission Level – Limit value
5. " * ": Fundamental frequency.
6. " # ": The radiated frequency is out of the restricted band.

802.11ac (VHT20)

CHANNEL	TX Channel 36	DETECTOR FUNCTION	Peak (PK)
FREQUENCY RANGE	1GHz ~ 40GHz		Average (AV)

ANTENNA POLARITY & TEST DISTANCE: HORIZONTAL AT 3 M								
NO.	FREQ. (MHz)	EMISSION LEVEL (dBuV/m)	LIMIT (dBuV/m)	MARGIN (dB)	ANTENNA HEIGHT (m)	TABLE ANGLE (Degree)	RAW VALUE (dBuV)	CORRECTION FACTOR (dB/m)
1	5150.00	66.1 PK	74.0	-7.9	2.81 H	360	64.6	1.5
2	5150.00	53.8 AV	54.0	-0.2	2.81 H	360	52.3	1.5
3	*5180.00	110.5 PK			2.81 H	360	108.9	1.6
4	*5180.00	100.6 AV			2.81 H	360	99.0	1.6
5	#10360.00	59.9 PK	74.0	-14.1	3.33 H	360	48.4	11.5
6	#10360.00	46.9 AV	54.0	-7.1	3.33 H	360	35.4	11.5
7	15540.00	52.4 PK	74.0	-21.6	1.55 H	356	39.3	13.1
8	15540.00	39.8 AV	54.0	-14.2	1.55 H	356	26.7	13.1

ANTENNA POLARITY & TEST DISTANCE: VERTICAL AT 3 M								
NO.	FREQ. (MHz)	EMISSION LEVEL (dBuV/m)	LIMIT (dBuV/m)	MARGIN (dB)	ANTENNA HEIGHT (m)	TABLE ANGLE (Degree)	RAW VALUE (dBuV)	CORRECTION FACTOR (dB/m)
1	5150.00	63.7 PK	74.0	-10.3	2.88 V	52	62.2	1.5
2	5150.00	50.9 AV	54.0	-3.1	2.88 V	52	49.4	1.5
3	*5180.00	108.4 PK			2.88 V	52	106.8	1.6
4	*5180.00	98.8 AV			2.88 V	52	97.2	1.6
5	#10360.00	63.4 PK	74.0	-10.6	2.42 V	200	51.9	11.5
6	#10360.00	49.5 AV	54.0	-4.5	2.42 V	200	38.0	11.5
7	15540.00	51.4 PK	74.0	-22.6	1.63 V	220	38.3	13.1
8	15540.00	39.0 AV	54.0	-15.0	1.63 V	220	25.9	13.1

REMARKS:

1. Emission Level(dBuV/m) = Raw Value(dBuV) + Correction Factor(dB/m)
2. Correction Factor(dB/m) = Antenna Factor(dB/m) + Cable Factor(dB) – Pre-Amplifier Factor(dB)
3. The other emission levels were very low against the limit.
4. Margin value = Emission Level – Limit value
5. " * ": Fundamental frequency.
6. " # ": The radiated frequency is out of the restricted band.

CHANNEL	TX Channel 40	DETECTOR FUNCTION	Peak (PK)
FREQUENCY RANGE	1GHz ~ 40GHz		Average (AV)

ANTENNA POLARITY & TEST DISTANCE: HORIZONTAL AT 3 M

NO.	FREQ. (MHz)	EMISSION LEVEL (dBuV/m)	LIMIT (dBuV/m)	MARGIN (dB)	ANTENNA HEIGHT (m)	TABLE ANGLE (Degree)	RAW VALUE (dBuV)	CORRECTION FACTOR (dB/m)
1	5150.00	63.8 PK	74.0	-10.2	2.77 H	360	62.3	1.5
2	5150.00	49.8 AV	54.0	-4.2	2.77 H	360	48.3	1.5
3	*5200.00	113.9 PK			2.77 H	360	112.2	1.7
4	*5200.00	103.4 AV			2.77 H	360	101.7	1.7
5	#10400.00	60.7 PK	74.0	-13.3	3.33 H	360	49.1	11.6
6	#10400.00	47.4 AV	54.0	-6.6	3.33 H	360	35.8	11.6
7	15600.00	51.5 PK	74.0	-22.5	1.49 H	357	38.4	13.1
8	15600.00	39.1 AV	54.0	-14.9	1.49 H	357	26.0	13.1

ANTENNA POLARITY & TEST DISTANCE: VERTICAL AT 3 M

NO.	FREQ. (MHz)	EMISSION LEVEL (dBuV/m)	LIMIT (dBuV/m)	MARGIN (dB)	ANTENNA HEIGHT (m)	TABLE ANGLE (Degree)	RAW VALUE (dBuV)	CORRECTION FACTOR (dB/m)
1	5150.00	61.5 PK	74.0	-12.5	2.11 V	41	60.0	1.5
2	5150.00	47.1 AV	54.0	-6.9	2.11 V	41	45.6	1.5
3	*5200.00	112.7 PK			2.11 V	41	111.0	1.7
4	*5200.00	101.9 AV			2.11 V	41	100.2	1.7
5	#10400.00	62.7 PK	74.0	-11.3	2.35 V	210	51.1	11.6
6	#10400.00	49.0 AV	54.0	-5.0	2.35 V	210	37.4	11.6
7	15600.00	52.0 PK	74.0	-22.0	1.61 V	215	38.9	13.1
8	15600.00	39.1 AV	54.0	-14.9	1.61 V	215	26.0	13.1

REMARKS:

1. Emission Level(dBuV/m) = Raw Value(dBuV) + Correction Factor(dB/m)
2. Correction Factor(dB/m) = Antenna Factor(dB/m) + Cable Factor(dB) – Pre-Amplifier Factor(dB)
3. The other emission levels were very low against the limit.
4. Margin value = Emission Level – Limit value
5. " * ": Fundamental frequency.
6. " # ": The radiated frequency is out of the restricted band.

CHANNEL	TX Channel 48	DETECTOR FUNCTION	Peak (PK)
FREQUENCY RANGE	1GHz ~ 40GHz		Average (AV)

ANTENNA POLARITY & TEST DISTANCE: HORIZONTAL AT 3 M

NO.	FREQ. (MHz)	EMISSION LEVEL (dBuV/m)	LIMIT (dBuV/m)	MARGIN (dB)	ANTENNA HEIGHT (m)	TABLE ANGLE (Degree)	RAW VALUE (dBuV)	CORRECTION FACTOR (dB/m)
1	*5240.00	112.4 PK			2.71 H	22	110.8	1.6
2	*5240.00	102.2 AV			2.71 H	22	100.6	1.6
3	5350.00	54.1 PK	74.0	-19.9	2.71 H	22	52.2	1.9
4	5350.00	42.3 AV	54.0	-11.7	2.71 H	22	40.4	1.9
5	#10480.00	59.8 PK	74.0	-14.2	3.35 H	360	47.8	12.0
6	#10480.00	46.8 AV	54.0	-7.2	3.35 H	360	34.8	12.0
7	15720.00	52.0 PK	74.0	-22.0	1.59 H	360	38.8	13.2
8	15720.00	39.7 AV	54.0	-14.3	1.59 H	360	26.5	13.2

ANTENNA POLARITY & TEST DISTANCE: VERTICAL AT 3 M

NO.	FREQ. (MHz)	EMISSION LEVEL (dBuV/m)	LIMIT (dBuV/m)	MARGIN (dB)	ANTENNA HEIGHT (m)	TABLE ANGLE (Degree)	RAW VALUE (dBuV)	CORRECTION FACTOR (dB/m)
1	*5240.00	111.4 PK			2.11 V	38	109.8	1.6
2	*5240.00	100.9 AV			2.11 V	38	99.3	1.6
3	5350.00	52.2 PK	74.0	-21.8	2.11 V	38	50.3	1.9
4	5350.00	40.2 AV	54.0	-13.8	2.11 V	38	38.3	1.9
5	#10480.00	62.6 PK	74.0	-11.4	2.38 V	219	50.6	12.0
6	#10480.00	48.7 AV	54.0	-5.3	2.38 V	219	36.7	12.0
7	15720.00	52.5 PK	74.0	-21.5	1.72 V	233	39.3	13.2
8	15720.00	39.8 AV	54.0	-14.2	1.72 V	233	26.6	13.2

REMARKS:

1. Emission Level(dBuV/m) = Raw Value(dBuV) + Correction Factor(dB/m)
2. Correction Factor(dB/m) = Antenna Factor(dB/m) + Cable Factor(dB) – Pre-Amplifier Factor(dB)
3. The other emission levels were very low against the limit.
4. Margin value = Emission Level – Limit value
5. " * ": Fundamental frequency.
6. " # ": The radiated frequency is out of the restricted band.

CHANNEL	TX Channel 149	DETECTOR FUNCTION	Peak (PK)
FREQUENCY RANGE	1GHz ~ 40GHz		Average (AV)

ANTENNA POLARITY & TEST DISTANCE: HORIZONTAL AT 3 M

NO.	FREQ. (MHz)	EMISSION LEVEL (dBuV/m)	LIMIT (dBuV/m)	MARGIN (dB)	ANTENNA HEIGHT (m)	TABLE ANGLE (Degree)	RAW VALUE (dBuV)	CORRECTION FACTOR (dB/m)
1	#5656.76	63.4 PK	73.2	-9.8	1.81 H	41	60.9	2.5
2	*5745.00	113.9 PK			1.98 H	30	111.2	2.7
3	*5745.00	102.5 AV			1.98 H	30	99.8	2.7
4	#5973.32	57.8 PK	68.2	-10.4	1.81 H	41	54.8	3.0
5	11490.00	66.9 PK	74.0	-7.1	2.64 H	26	53.5	13.4
6	11490.00	53.2 AV	54.0	-0.8	2.64 H	26	39.8	13.4
7	#17235.00	56.1 PK	74.0	-17.9	1.72 H	217	37.8	18.3
8	#17235.00	44.0 AV	54.0	-10.0	1.72 H	217	25.7	18.3

ANTENNA POLARITY & TEST DISTANCE: VERTICAL AT 3 M

NO.	FREQ. (MHz)	EMISSION LEVEL (dBuV/m)	LIMIT (dBuV/m)	MARGIN (dB)	ANTENNA HEIGHT (m)	TABLE ANGLE (Degree)	RAW VALUE (dBuV)	CORRECTION FACTOR (dB/m)
1	#5627.30	58.0 PK	68.2	-10.2	1.98 V	30	55.5	2.5
2	*5745.00	112.9 PK			1.81 V	41	110.2	2.7
3	*5745.00	101.3 AV			1.81 V	41	98.6	2.7
4	#6002.70	57.1 PK	68.2	-11.1	1.98 V	30	53.8	3.3
5	11490.00	62.6 PK	74.0	-11.4	1.00 V	132	49.2	13.4
6	11490.00	50.5 AV	54.0	-3.5	1.00 V	132	37.1	13.4
7	#17235.00	56.1 PK	74.0	-17.9	1.47 V	360	37.8	18.3
8	#17235.00	43.9 AV	54.0	-10.1	1.47 V	360	25.6	18.3

REMARKS:

1. Emission Level(dBuV/m) = Raw Value(dBuV) + Correction Factor(dB/m)
2. Correction Factor(dB/m) = Antenna Factor(dB/m) + Cable Factor(dB) – Pre-Amplifier Factor(dB)
3. The other emission levels were very low against the limit.
4. Margin value = Emission Level – Limit value
5. " * ": Fundamental frequency.
6. " # ": The radiated frequency is out of the restricted band.

CHANNEL	TX Channel 157	DETECTOR FUNCTION	Peak (PK)
FREQUENCY RANGE	1GHz ~ 40GHz		Average (AV)

ANTENNA POLARITY & TEST DISTANCE: HORIZONTAL AT 3 M

NO.	FREQ. (MHz)	EMISSION LEVEL (dBuV/m)	LIMIT (dBuV/m)	MARGIN (dB)	ANTENNA HEIGHT (m)	TABLE ANGLE (Degree)	RAW VALUE (dBuV)	CORRECTION FACTOR (dB/m)
1	#5605.10	59.0 PK	68.2	-9.2	1.93 H	360	56.5	2.5
2	*5785.00	112.8 PK			1.93 H	360	110.1	2.7
3	*5785.00	102.3 AV			1.93 H	360	99.6	2.7
4	#5967.52	56.8 PK	68.2	-11.4	1.93 H	360	53.8	3.0
5	11570.00	67.1 PK	74.0	-6.9	2.67 H	17	54.0	13.1
6	11570.00	53.3 AV	54.0	-0.7	2.67 H	17	40.2	13.1
7	#17355.00	56.8 PK	74.0	-17.2	1.63 H	218	38.0	18.8
8	#17355.00	44.3 AV	54.0	-9.7	1.63 H	218	25.5	18.8

ANTENNA POLARITY & TEST DISTANCE: VERTICAL AT 3 M

NO.	FREQ. (MHz)	EMISSION LEVEL (dBuV/m)	LIMIT (dBuV/m)	MARGIN (dB)	ANTENNA HEIGHT (m)	TABLE ANGLE (Degree)	RAW VALUE (dBuV)	CORRECTION FACTOR (dB/m)
1	#5569.48	57.9 PK	68.2	-10.3	1.77 V	43	55.6	2.3
2	*5785.00	111.8 PK			1.77 V	43	109.1	2.7
3	*5785.00	101.0 AV			1.77 V	43	98.3	2.7
4	#5961.82	57.3 PK	68.2	-10.9	1.77 V	43	54.3	3.0
5	11570.00	61.8 PK	74.0	-12.2	1.00 V	125	48.7	13.1
6	11570.00	49.8 AV	54.0	-4.2	1.00 V	125	36.7	13.1
7	#17355.00	56.8 PK	74.0	-17.2	1.45 V	360	38.0	18.8
8	#17355.00	44.7 AV	54.0	-9.3	1.45 V	360	25.9	18.8

REMARKS:

1. Emission Level(dBuV/m) = Raw Value(dBuV) + Correction Factor(dB/m)
2. Correction Factor(dB/m) = Antenna Factor(dB/m) + Cable Factor(dB) – Pre-Amplifier Factor(dB)
3. The other emission levels were very low against the limit.
4. Margin value = Emission Level – Limit value
5. " * ": Fundamental frequency.
6. " # ": The radiated frequency is out of the restricted band.

CHANNEL	TX Channel 165	DETECTOR FUNCTION	Peak (PK)
FREQUENCY RANGE	1GHz ~ 40GHz		Average (AV)

ANTENNA POLARITY & TEST DISTANCE: HORIZONTAL AT 3 M

NO.	FREQ. (MHz)	EMISSION LEVEL (dBuV/m)	LIMIT (dBuV/m)	MARGIN (dB)	ANTENNA HEIGHT (m)	TABLE ANGLE (Degree)	RAW VALUE (dBuV)	CORRECTION FACTOR (dB/m)
1	#5612.70	57.3 PK	68.2	-10.9	2.06 H	360	54.8	2.5
2	*5825.00	112.3 PK			2.06 H	360	109.6	2.7
3	*5825.00	101.9 AV			2.06 H	360	99.2	2.7
4	#5924.77	61.8 PK	68.4	-6.6	2.06 H	360	58.9	2.9
5	11650.00	66.6 PK	74.0	-7.4	2.60 H	13	53.5	13.1
6	11650.00	53.0 AV	54.0	-1.0	2.60 H	13	39.9	13.1
7	#17475.00	56.4 PK	74.0	-17.6	1.63 H	231	37.2	19.2
8	#17475.00	44.0 AV	54.0	-10.0	1.63 H	231	24.8	19.2

ANTENNA POLARITY & TEST DISTANCE: VERTICAL AT 3 M

NO.	FREQ. (MHz)	EMISSION LEVEL (dBuV/m)	LIMIT (dBuV/m)	MARGIN (dB)	ANTENNA HEIGHT (m)	TABLE ANGLE (Degree)	RAW VALUE (dBuV)	CORRECTION FACTOR (dB/m)
1	#5668.75	58.5 PK	82.1	-23.6	1.78 V	36	56.0	2.5
2	*5825.00	111.3 PK			1.78 V	36	108.6	2.7
3	*5825.00	100.5 AV			1.78 V	36	97.8	2.7
4	#5937.60	56.9 PK	68.2	-11.3	1.78 V	36	54.0	2.9
5	11650.00	62.5 PK	74.0	-11.5	1.04 V	122	49.4	13.1
6	11650.00	50.4 AV	54.0	-3.6	1.04 V	122	37.3	13.1
7	#17475.00	56.3 PK	74.0	-17.7	1.53 V	360	37.1	19.2
8	#17475.00	44.2 AV	54.0	-9.8	1.53 V	360	25.0	19.2

REMARKS:

1. Emission Level(dBuV/m) = Raw Value(dBuV) + Correction Factor(dB/m)
2. Correction Factor(dB/m) = Antenna Factor(dB/m) + Cable Factor(dB) – Pre-Amplifier Factor(dB)
3. The other emission levels were very low against the limit.
4. Margin value = Emission Level – Limit value
5. " * ": Fundamental frequency.
6. " # ": The radiated frequency is out of the restricted band.

802.11ac (VHT40)

CHANNEL	TX Channel 38	DETECTOR FUNCTION	Peak (PK)
FREQUENCY RANGE	1GHz ~ 40GHz		Average (AV)

ANTENNA POLARITY & TEST DISTANCE: HORIZONTAL AT 3 M								
NO.	FREQ. (MHz)	EMISSION LEVEL (dBuV/m)	LIMIT (dBuV/m)	MARGIN (dB)	ANTENNA HEIGHT (m)	TABLE ANGLE (Degree)	RAW VALUE (dBuV)	CORRECTION FACTOR (dB/m)
1	5150.00	68.6 PK	74.0	-5.4	2.68 H	360	67.1	1.5
2	5150.00	53.9 AV	54.0	-0.1	2.68 H	360	52.4	1.5
3	*5190.00	105.3 PK			2.68 H	360	103.6	1.7
4	*5190.00	95.0 AV			2.68 H	360	93.3	1.7
5	5350.00	55.5 PK	74.0	-18.5	2.68 H	360	53.6	1.9
6	5350.00	42.9 AV	54.0	-11.1	2.68 H	360	41.0	1.9
7	#10380.00	55.6 PK	74.0	-18.4	3.37 H	360	44.1	11.5
8	#10380.00	42.2 AV	54.0	-11.8	3.37 H	360	30.7	11.5
9	15570.00	49.6 PK	74.0	-24.4	1.61 H	360	36.5	13.1
10	15570.00	37.3 AV	54.0	-16.7	1.61 H	360	24.2	13.1

ANTENNA POLARITY & TEST DISTANCE: VERTICAL AT 3 M								
NO.	FREQ. (MHz)	EMISSION LEVEL (dBuV/m)	LIMIT (dBuV/m)	MARGIN (dB)	ANTENNA HEIGHT (m)	TABLE ANGLE (Degree)	RAW VALUE (dBuV)	CORRECTION FACTOR (dB/m)
1	5150.00	66.5 PK	74.0	-7.5	2.16 V	36	65.0	1.5
2	5150.00	51.2 AV	54.0	-2.8	2.16 V	36	49.7	1.5
3	*5190.00	103.1 PK			2.16 V	36	101.4	1.7
4	*5190.00	93.6 AV			2.16 V	36	91.9	1.7
5	5350.00	53.6 PK	74.0	-20.4	2.16 V	36	51.7	1.9
6	5350.00	40.3 AV	54.0	-13.7	2.16 V	36	38.4	1.9
7	#10380.00	58.6 PK	74.0	-15.4	2.43 V	221	47.1	11.5
8	#10380.00	44.3 AV	54.0	-9.7	2.43 V	221	32.8	11.5
9	15570.00	51.3 PK	74.0	-22.7	1.72 V	227	38.2	13.1
10	15570.00	37.9 AV	54.0	-16.1	1.72 V	227	24.8	13.1

REMARKS:

1. Emission Level(dBuV/m) = Raw Value(dBuV) + Correction Factor(dB/m)
2. Correction Factor(dB/m) = Antenna Factor(dB/m) + Cable Factor(dB) – Pre-Amplifier Factor(dB)
3. The other emission levels were very low against the limit.
4. Margin value = Emission Level – Limit value
5. " * ": Fundamental frequency.
6. " # ": The radiated frequency is out of the restricted band.

CHANNEL	TX Channel 46	DETECTOR FUNCTION	Peak (PK)
FREQUENCY RANGE	1GHz ~ 40GHz		Average (AV)

ANTENNA POLARITY & TEST DISTANCE: HORIZONTAL AT 3 M

NO.	FREQ. (MHz)	EMISSION LEVEL (dBuV/m)	LIMIT (dBuV/m)	MARGIN (dB)	ANTENNA HEIGHT (m)	TABLE ANGLE (Degree)	RAW VALUE (dBuV)	CORRECTION FACTOR (dB/m)
1	*5230.00	109.4 PK			2.77 H	354	107.8	1.6
2	*5230.00	98.8 AV			2.77 H	354	97.2	1.6
3	5350.00	58.4 PK	74.0	-15.6	2.77 H	354	56.5	1.9
4	5350.00	45.6 AV	54.0	-8.4	2.77 H	354	43.7	1.9
5	#10460.00	57.1 PK	74.0	-16.9	3.32 H	360	45.2	11.9
6	#10460.00	43.8 AV	54.0	-10.2	3.32 H	360	31.9	11.9
7	15690.00	50.6 PK	74.0	-23.4	1.64 H	360	37.3	13.3
8	15690.00	38.5 AV	54.0	-15.5	1.64 H	360	25.2	13.3

ANTENNA POLARITY & TEST DISTANCE: VERTICAL AT 3 M

NO.	FREQ. (MHz)	EMISSION LEVEL (dBuV/m)	LIMIT (dBuV/m)	MARGIN (dB)	ANTENNA HEIGHT (m)	TABLE ANGLE (Degree)	RAW VALUE (dBuV)	CORRECTION FACTOR (dB/m)
1	*5230.00	107.4 PK			2.16 V	40	105.8	1.6
2	*5230.00	96.4 AV			2.16 V	40	94.8	1.6
3	5350.00	56.4 PK	74.0	-17.6	2.16 V	40	54.5	1.9
4	5350.00	43.5 AV	54.0	-10.5	2.16 V	40	41.6	1.9
5	#10460.00	60.4 PK	74.0	-13.6	2.38 V	226	48.5	11.9
6	#10460.00	46.5 AV	54.0	-7.5	2.38 V	226	34.6	11.9
7	15690.00	51.4 PK	74.0	-22.6	1.69 V	217	38.1	13.3
8	15690.00	37.7 AV	54.0	-16.3	1.69 V	217	24.4	13.3

REMARKS:

1. Emission Level(dBuV/m) = Raw Value(dBuV) + Correction Factor(dB/m)
2. Correction Factor(dB/m) = Antenna Factor(dB/m) + Cable Factor(dB) – Pre-Amplifier Factor(dB)
3. The other emission levels were very low against the limit.
4. Margin value = Emission Level – Limit value
5. " * ": Fundamental frequency.
6. " # ": The radiated frequency is out of the restricted band.

CHANNEL	TX Channel 151	DETECTOR FUNCTION	Peak (PK)
FREQUENCY RANGE	1GHz ~ 40GHz		Average (AV)

ANTENNA POLARITY & TEST DISTANCE: HORIZONTAL AT 3 M

NO.	FREQ. (MHz)	EMISSION LEVEL (dBuV/m)	LIMIT (dBuV/m)	MARGIN (dB)	ANTENNA HEIGHT (m)	TABLE ANGLE (Degree)	RAW VALUE (dBuV)	CORRECTION FACTOR (dB/m)
1	#5649.27	66.0 PK	68.2	-2.2	1.93 H	360	63.5	2.5
2	*5755.00	109.6 PK			1.93 H	360	106.9	2.7
3	*5755.00	98.5 AV			1.93 H	360	95.8	2.7
4	#5939.02	56.7 PK	68.2	-11.5	1.93 H	360	53.8	2.9
5	11510.00	65.4 PK	74.0	-8.6	2.64 H	11	52.0	13.4
6	11510.00	51.4 AV	54.0	-2.6	2.64 H	11	38.0	13.4
7	#17265.00	54.3 PK	74.0	-19.7	1.67 H	205	36.0	18.3
8	#17265.00	42.2 AV	54.0	-11.8	1.67 H	205	23.9	18.3

ANTENNA POLARITY & TEST DISTANCE: VERTICAL AT 3 M

NO.	FREQ. (MHz)	EMISSION LEVEL (dBuV/m)	LIMIT (dBuV/m)	MARGIN (dB)	ANTENNA HEIGHT (m)	TABLE ANGLE (Degree)	RAW VALUE (dBuV)	CORRECTION FACTOR (dB/m)
1	#5639.30	66.1 PK	68.2	-2.1	1.74 V	30	63.6	2.5
2	*5755.00	108.6 PK			1.74 V	30	105.9	2.7
3	*5755.00	97.1 AV			1.74 V	30	94.4	2.7
4	#5934.75	55.8 PK	68.2	-12.4	1.74 V	30	52.9	2.9
5	11510.00	60.4 PK	74.0	-13.6	1.06 V	135	47.0	13.4
6	11510.00	48.5 AV	54.0	-5.5	1.06 V	135	35.1	13.4
7	#17265.00	54.6 PK	74.0	-19.4	1.55 V	360	36.3	18.3
8	#17265.00	42.2 AV	54.0	-11.8	1.55 V	360	23.9	18.3

REMARKS:

1. Emission Level(dBuV/m) = Raw Value(dBuV) + Correction Factor(dB/m)
2. Correction Factor(dB/m) = Antenna Factor(dB/m) + Cable Factor(dB) – Pre-Amplifier Factor(dB)
3. The other emission levels were very low against the limit.
4. Margin value = Emission Level – Limit value
5. " * ": Fundamental frequency.
6. " # ": The radiated frequency is out of the restricted band.

CHANNEL	TX Channel 159	DETECTOR FUNCTION	Peak (PK)
FREQUENCY RANGE	1GHz ~ 40GHz		Average (AV)

ANTENNA POLARITY & TEST DISTANCE: HORIZONTAL AT 3 M

NO.	FREQ. (MHz)	EMISSION LEVEL (dBuV/m)	LIMIT (dBuV/m)	MARGIN (dB)	ANTENNA HEIGHT (m)	TABLE ANGLE (Degree)	RAW VALUE (dBuV)	CORRECTION FACTOR (dB/m)
1	#5630.75	58.8 PK	68.2	-9.4	2.13 H	12	56.3	2.5
2	*5795.00	109.9 PK			2.13 H	12	107.2	2.7
3	*5795.00	98.9 AV			2.13 H	12	96.2	2.7
4	#5941.87	60.5 PK	68.2	-7.7	2.13 H	12	57.6	2.9
5	11590.00	65.8 PK	74.0	-8.2	2.69 H	12	52.8	13.0
6	11590.00	51.9 AV	54.0	-2.1	2.69 H	12	38.9	13.0
7	#17385.00	54.1 PK	74.0	-19.9	1.64 H	219	35.1	19.0
8	#17385.00	41.8 AV	54.0	-12.2	1.64 H	219	22.8	19.0

ANTENNA POLARITY & TEST DISTANCE: VERTICAL AT 3 M

NO.	FREQ. (MHz)	EMISSION LEVEL (dBuV/m)	LIMIT (dBuV/m)	MARGIN (dB)	ANTENNA HEIGHT (m)	TABLE ANGLE (Degree)	RAW VALUE (dBuV)	CORRECTION FACTOR (dB/m)
1	#5636.45	58.3 PK	68.2	-9.9	1.74 V	30	55.8	2.5
2	*5795.00	108.7 PK			1.74 V	30	106.0	2.7
3	*5795.00	98.3 AV			1.74 V	30	95.6	2.7
4	#5920.98	61.1 PK	71.2	-10.1	1.74 V	30	58.2	2.9
5	11590.00	60.9 PK	74.0	-13.1	1.11 V	149	47.9	13.0
6	11590.00	48.9 AV	54.0	-5.1	1.11 V	149	35.9	13.0
7	#17385.00	54.7 PK	74.0	-19.3	1.58 V	360	35.7	19.0
8	#17385.00	42.4 AV	54.0	-11.6	1.58 V	360	23.4	19.0

REMARKS:

1. Emission Level(dBuV/m) = Raw Value(dBuV) + Correction Factor(dB/m)
2. Correction Factor(dB/m) = Antenna Factor(dB/m) + Cable Factor(dB) – Pre-Amplifier Factor(dB)
3. The other emission levels were very low against the limit.
4. Margin value = Emission Level – Limit value
5. " * ": Fundamental frequency.
6. " # ": The radiated frequency is out of the restricted band.

802.11ac (VHT80)

CHANNEL	TX Channel 42	DETECTOR FUNCTION	Peak (PK)
FREQUENCY RANGE	1GHz ~ 40GHz		Average (AV)

ANTENNA POLARITY & TEST DISTANCE: HORIZONTAL AT 3 M

NO.	FREQ. (MHz)	EMISSION LEVEL (dBuV/m)	LIMIT (dBuV/m)	MARGIN (dB)	ANTENNA HEIGHT (m)	TABLE ANGLE (Degree)	RAW VALUE (dBuV)	CORRECTION FACTOR (dB/m)
1	5150.00	67.5 PK	74.0	-6.5	2.45 H	360	66.0	1.5
2	5150.00	53.9 AV	54.0	-0.1	2.45 H	360	52.4	1.5
3	*5210.00	101.3 PK			2.45 H	360	99.6	1.7
4	*5210.00	91.3 AV			2.45 H	360	89.6	1.7
5	5350.00	53.2 PK	74.0	-20.8	2.45 H	360	51.3	1.9
6	5350.00	42.6 AV	54.0	-11.4	2.45 H	360	40.7	1.9
7	#10420.00	55.4 PK	74.0	-18.6	3.32 H	360	43.7	11.7
8	#10420.00	40.1 AV	54.0	-13.9	3.32 H	360	28.4	11.7
9	15630.00	50.9 PK	74.0	-23.1	1.64 H	360	37.7	13.2
10	15630.00	38.8 AV	54.0	-15.2	1.64 H	360	25.6	13.2

ANTENNA POLARITY & TEST DISTANCE: VERTICAL AT 3 M

NO.	FREQ. (MHz)	EMISSION LEVEL (dBuV/m)	LIMIT (dBuV/m)	MARGIN (dB)	ANTENNA HEIGHT (m)	TABLE ANGLE (Degree)	RAW VALUE (dBuV)	CORRECTION FACTOR (dB/m)
1	5150.00	65.2 PK	74.0	-8.8	2.11 V	52	63.7	1.5
2	5150.00	51.3 AV	54.0	-2.7	2.11 V	52	49.8	1.5
3	*5210.00	99.4 PK			2.11 V	52	97.7	1.7
4	*5210.00	89.2 AV			2.11 V	52	87.5	1.7
5	5350.00	51.4 PK	74.0	-22.6	2.11 V	52	49.5	1.9
6	5350.00	40.3 AV	54.0	-13.7	2.11 V	52	38.4	1.9
7	#10420.00	57.6 PK	74.0	-16.4	2.36 V	233	45.9	11.7
8	#10420.00	53.3 AV	54.0	-0.7	2.36 V	233	41.6	11.7
9	15630.00	51.8 PK	74.0	-22.2	1.71 V	226	38.6	13.2
10	15630.00	37.9 AV	54.0	-16.1	1.71 V	226	24.7	13.2

REMARKS:

- Emission Level(dBuV/m) = Raw Value(dBuV) + Correction Factor(dB/m)
- Correction Factor(dB/m) = Antenna Factor(dB/m) + Cable Factor(dB) – Pre-Amplifier Factor(dB)
- The other emission levels were very low against the limit.
- Margin value = Emission Level – Limit value
- " * ": Fundamental frequency.
- " # ": The radiated frequency is out of the restricted band.

CHANNEL	TX Channel 155	DETECTOR FUNCTION	Peak (PK)
FREQUENCY RANGE	1GHz ~ 40GHz		Average (AV)

ANTENNA POLARITY & TEST DISTANCE: HORIZONTAL AT 3 M

NO.	FREQ. (MHz)	EMISSION LEVEL (dBuV/m)	LIMIT (dBuV/m)	MARGIN (dB)	ANTENNA HEIGHT (m)	TABLE ANGLE (Degree)	RAW VALUE (dBuV)	CORRECTION FACTOR (dB/m)
1	#5652.60	68.7 PK	70.1	-1.4	2.01 H	20	66.2	2.5
2	*5775.00	105.2 PK			2.01 H	20	102.5	2.7
3	*5775.00	95.6 AV			2.01 H	20	92.9	2.7
4	#5925.73	67.5 PK	68.2	-0.7	2.01 H	20	64.6	2.9
5	11550.00	63.2 PK	74.0	-10.8	2.70 H	10	50.0	13.2
6	11550.00	49.3 AV	54.0	-4.7	2.70 H	10	36.1	13.2
7	#17325.00	52.2 PK	74.0	-21.8	1.67 H	223	33.6	18.6
8	#17325.00	40.2 AV	54.0	-13.8	1.67 H	223	21.6	18.6

ANTENNA POLARITY & TEST DISTANCE: VERTICAL AT 3 M

NO.	FREQ. (MHz)	EMISSION LEVEL (dBuV/m)	LIMIT (dBuV/m)	MARGIN (dB)	ANTENNA HEIGHT (m)	TABLE ANGLE (Degree)	RAW VALUE (dBuV)	CORRECTION FACTOR (dB/m)
1	#5622.20	64.7 PK	68.2	-3.5	1.74 V	30	62.2	2.5
2	*5775.00	103.7 PK			1.73 V	30	101.0	2.7
3	*5775.00	94.2 AV			1.73 V	30	91.5	2.7
4	#5921.93	64.0 PK	70.5	-6.5	1.74 V	30	61.1	2.9
5	11550.00	59.6 PK	74.0	-14.4	1.17 V	140	46.4	13.2
6	11550.00	46.5 AV	54.0	-7.5	1.17 V	140	33.3	13.2
7	#17325.00	53.2 PK	74.0	-20.8	1.57 V	360	34.6	18.6
8	#17325.00	41.1 AV	54.0	-12.9	1.57 V	360	22.5	18.6

REMARKS:

1. Emission Level(dBuV/m) = Raw Value(dBuV) + Correction Factor(dB/m)
2. Correction Factor(dB/m) = Antenna Factor(dB/m) + Cable Factor(dB) – Pre-Amplifier Factor(dB)
3. The other emission levels were very low against the limit.
4. Margin value = Emission Level – Limit value
5. " * ": Fundamental frequency.
6. " # ": The radiated frequency is out of the restricted band.

BELOW 1GHz WORST-CASE DATA

802.11a

CHANNEL	TX Channel 157	DETECTOR FUNCTION	Quasi-Peak (QP)
FREQUENCY RANGE	9kHz ~ 1GHz		

ANTENNA POLARITY & TEST DISTANCE: HORIZONTAL AT 3 M

NO.	FREQ. (MHz)	EMISSION LEVEL (dBuV/m)	LIMIT (dBuV/m)	MARGIN (dB)	ANTENNA HEIGHT (m)	TABLE ANGLE (Degree)	RAW VALUE (dBuV)	CORRECTION FACTOR (dB/m)
1	32.40	29.5 QP	40.0	-10.5	2.50 H	231	39.3	-9.8
2	289.79	33.3 QP	46.0	-12.7	1.00 H	301	41.5	-8.2
3	398.36	36.7 QP	46.0	-9.3	1.00 H	56	42.2	-5.5
4	435.22	36.2 QP	46.0	-9.8	1.00 H	33	40.3	-4.1
5	666.78	42.1 QP	46.0	-3.9	1.00 H	39	41.9	0.2
6	958.34	36.5 QP	46.0	-9.5	1.50 H	118	31.9	4.6

ANTENNA POLARITY & TEST DISTANCE: VERTICAL AT 3 M

NO.	FREQ. (MHz)	EMISSION LEVEL (dBuV/m)	LIMIT (dBuV/m)	MARGIN (dB)	ANTENNA HEIGHT (m)	TABLE ANGLE (Degree)	RAW VALUE (dBuV)	CORRECTION FACTOR (dB/m)
1	73.82	30.4 QP	40.0	-9.6	1.50 V	360	42.1	-11.7
2	445.45	37.1 QP	46.0	-8.9	1.00 V	99	40.8	-3.7
3	458.98	39.3 QP	46.0	-6.7	1.00 V	183	42.9	-3.6
4	575.02	38.6 QP	46.0	-7.4	1.00 V	51	40.0	-1.4
5	666.83	40.0 QP	46.0	-6.0	1.00 V	43	39.8	0.2
6	958.34	39.2 QP	46.0	-6.8	1.00 V	201	34.6	4.6

REMARKS:

1. Emission Level(dBuV/m) = Raw Value(dBuV) + Correction Factor(dB/m)
2. Correction Factor(dB/m) = Antenna Factor(dB/m) + Cable Factor(dB) – Pre-Amplifier Factor(dB)
3. The other emission levels were very low against the limit.
4. Margin value = Emission Level – Limit value

4.2 Conducted Emission Measurement

4.2.1 Limits of Conducted Emission Measurement

Frequency (MHz)	Conducted Limit (dBuV)	
	Quasi-peak	Average
0.15 - 0.5	66 - 56	56 - 46
0.50 - 5.0	56	46
5.0 - 30.0	60	50

Note: 1. The lower limit shall apply at the transition frequencies.

2. The limit decreases in line with the logarithm of the frequency in the range of 0.15 to 0.50MHz.

4.2.2 Test Instruments

DESCRIPTION & MANUFACTURER	MODEL NO.	SERIAL NO.	CALIBRATED DATE	CALIBRATED UNTIL
Test Receiver R&S	ESCS 30	847124/029	Oct. 24, 2016	Oct. 23, 2017
Line-Impedance Stabilization Network (for EUT) R&S	ESH3-Z5	848773/004	Oct. 26, 2016	Oct. 25, 2017
Line-Impedance Stabilization Network (for Peripheral) R&S	ENV216	100072	June 13, 2016	June 12, 2017
RF Cable	5D-FB	COCCAB-001	Sep. 30, 2016	Sep. 29, 2017
10 dB PAD Mini-Circuits	HAT-10+	CONATT-004	June 20, 2016	June 19, 2017
Software BVADT	BVADT_Cond_ V7.3.7.4	NA	NA	NA

Note:

1. The calibration interval of the above test instruments are 12 months and the calibrations are traceable to NML/ROC and NIST/USA.
2. The test was performed in Shielded Room No. 1.
3. Tested Date: Nov. 22, 2016

4.2.3 Test Procedure

- The EUT was placed 0.4 meters from the conducting wall of the shielded room with EUT being connected to the power mains through a line impedance stabilization network (LISN). Other support units were connected to the power mains through another LISN. The two LISNs provide 50 ohm/ 50uH of coupling impedance for the measuring instrument.
- Both lines of the power mains connected to the EUT were checked for maximum conducted interference.
- The frequency range from 150kHz to 30MHz was searched. Emission levels under (Limit - 20dB) was not recorded.

NOTE: All modes of operation were investigated and the worst-case emissions are reported.

4.2.4 Deviation from Test Standard

No deviation.

4.2.5 Test Setup

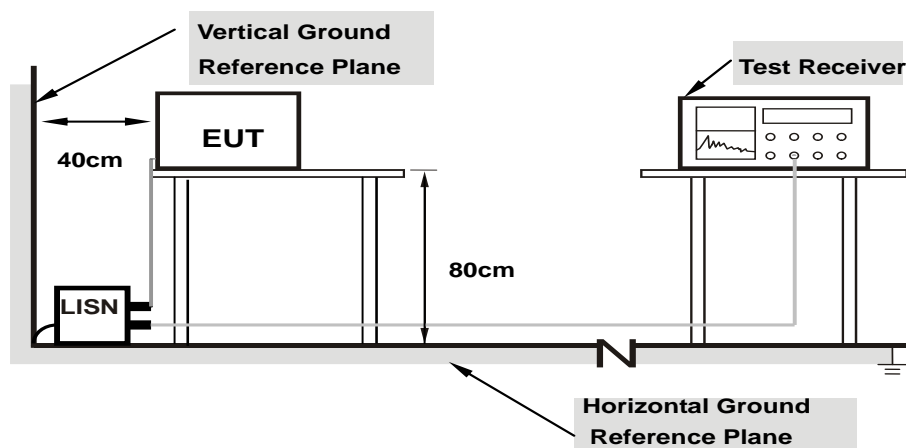

Note: 1.Support units were connected to second LISN.

For the actual test configuration, please refer to the attached file (Test Setup Photo).

4.2.6 EUT Operating Condition

Same as 4.1.6.

4.2.7 Test Results

Phase	Line (L)	Detector Function	Quasi-Peak (QP) / Average (AV)
-------	----------	-------------------	--------------------------------

No	Freq. [MHz]	Corr.	Reading Value		Emission Level		Limit		Margin	
		Factor (dB)	[dB (uV)]		[dB (uV)]		[dB (uV)]		(dB)	
			Q.P.	AV.	Q.P.	AV.	Q.P.	AV.	Q.P.	AV.
1	0.15000	10.20	29.48	16.88	39.68	27.08	66.00	56.00	-26.32	-28.92
2	0.19297	10.20	25.50	13.96	35.70	24.16	63.91	53.91	-28.21	-29.75
3	0.41172	10.24	15.41	11.53	25.65	21.77	57.61	47.61	-31.96	-25.84
4	0.82578	10.28	13.75	12.33	24.03	22.61	56.00	46.00	-31.97	-23.39
5	2.91016	10.30	10.43	6.25	20.73	16.55	56.00	46.00	-35.27	-29.45
6	21.01172	11.72	7.26	0.95	18.98	12.67	60.00	50.00	-41.02	-37.33

REMARKS:

1. Q.P. and AV. are abbreviations of quasi-peak and average individually.
2. The emission levels of other frequencies were very low against the limit.
3. Margin value = Emission level - Limit value
4. Correction factor = Insertion loss + Cable loss
5. Emission Level = Correction Factor + Reading Value.

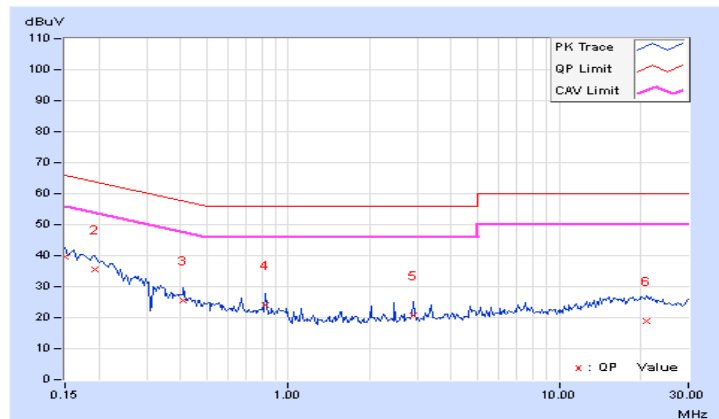

Phase	Neutral (N)	Detector Function	Quasi-Peak (QP) / Average (AV)
-------	-------------	-------------------	--------------------------------

No	Freq. [MHz]	Corr. Factor	Reading Value [dB (uV)]		Emission Level [dB (uV)]		Limit [dB (uV)]		Margin (dB)	
		(dB)	Q.P.	AV.	Q.P.	AV.	Q.P.	AV.	Q.P.	AV.
	1	0.15000	10.19	29.10	15.54	39.29	25.73	66.00	56.00	-26.71
2	0.19687	10.17	24.89	12.87	35.06	23.04	63.74	53.74	-28.68	-30.70
3	0.27500	10.20	21.65	11.99	31.85	22.19	60.97	50.97	-29.12	-28.78
4	0.82578	10.25	15.54	14.02	25.79	24.27	56.00	46.00	-30.21	-21.73
5	2.01563	10.31	10.52	5.88	20.83	16.19	56.00	46.00	-35.17	-29.81
6	4.25781	10.24	6.00	1.59	16.24	11.83	56.00	46.00	-39.76	-34.17

REMARKS:

1. Q.P. and AV. are abbreviations of quasi-peak and average individually.
2. The emission levels of other frequencies were very low against the limit.
3. Margin value = Emission level - Limit value
4. Correction factor = Insertion loss + Cable loss
5. Emission Level = Correction Factor + Reading Value.

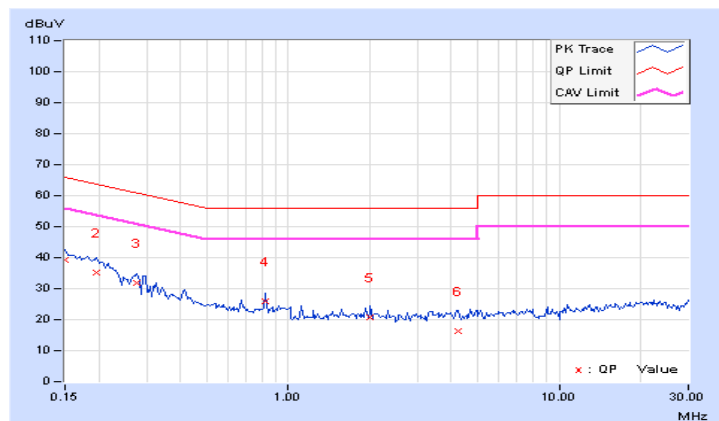

4.3 Transmit Power Measurement

4.3.1 Limits of Transmit Power Measurement

Operation Band	EUT Category		Limit
U-NII-1		Outdoor Access Point	1 Watt (30 dBm) (Max. e.i.r.p \leq 125mW(21 dBm) at any elevation angle above 30 degrees as measured from the horizon)
		Fixed point-to-point Access Point	1 Watt (30 dBm)
		Indoor Access Point	1 Watt (30 dBm)
	√	Mobile and Portable client device	250mW (24 dBm)
U-NII-2A			250mW (24 dBm) or 11 dBm+10 log B*
U-NII-2C			250mW (24 dBm) or 11 dBm+10 log B*
U-NII-3		√	1 Watt (30 dBm)

*B is the 26 dB emission bandwidth in megahertz

4.3.2 Test Setup

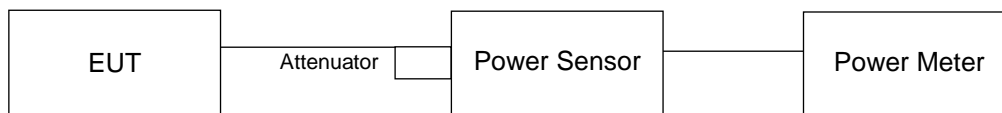

4.3.3 Test Instruments

Refer to section 4.1.2 to get information of above instrument.

4.3.4 Test Procedure

Method PM is used to perform output power measurement, trigger and gating function of wide band power meter is enabled to measure max output power of TX on burst. Duty factor is not added to measured value.

4.3.5 Deviation from Test Standard

No deviation.

4.3.6 EUT Operating Condition

The software provided by client to enable the EUT under transmission condition continuously at lowest, middle and highest channel frequencies individually.

4.3.7 Test Result

802.11a

Chan.	Chan. Freq. (MHz)	Average Power (mW)	Average Power (dBm)	Limit (dBm)	Pass / Fail
36	5180	187.499	22.73	24	Pass
40	5200	221.82	23.46	24	Pass
48	5240	204.174	23.10	24	Pass
149	5745	223.872	23.50	30	Pass
157	5785	224.905	23.52	30	Pass
165	5825	211.349	23.25	30	Pass

802.11ac (VHT20)

Chan.	Chan. Freq. (MHz)	Average Power (mW)	Average Power (dBm)	Limit (dBm)	Pass / Fail
36	5180	145.546	21.63	24	Pass
40	5200	211.836	23.26	24	Pass
48	5240	193.197	22.86	24	Pass
149	5745	210.378	23.23	30	Pass
157	5785	204.644	23.11	30	Pass
165	5825	192.309	22.84	30	Pass

802.11ac (VHT40)

Chan.	Chan. Freq. (MHz)	Average Power (mW)	Average Power (dBm)	Limit (dBm)	Pass / Fail
38	5190	88.512	19.47	24	Pass
46	5230	217.771	23.38	24	Pass
151	5755	193.197	22.86	30	Pass
159	5795	181.97	22.60	30	Pass

802.11ac (VHT80)

Chan.	Chan. Freq. (MHz)	Average Power (mW)	Average Power (dBm)	Limit (dBm)	Pass / Fail
42	5210	53.211	17.26	24	Pass
155	5775	93.111	19.69	30	Pass

4.4 Occupied Bandwidth Measurement

4.4.1 Test Setup

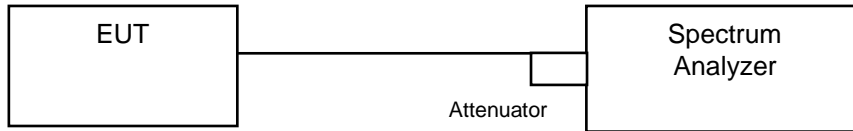

4.4.2 Test Instruments

Refer to section 4.1.2 to get information of above instrument.

4.4.3 Test Procedure

The transmitter output was connected to the spectrum analyzer through an attenuator. The bandwidth of the fundamental frequency was measured by spectrum analyzer with resolution bandwidth in the range of 1% to 5% of the anticipated emission bandwidth, and a video bandwidth at least 3x the resolution bandwidth and set the detector to SAMPLE. The width of a frequency band such that, below the lower and above the upper frequency limits, the mean powers emitted are each equal to a specified percentage 0.5 %of the total mean power of a given emission.

4.4.4 Test Results

802.11a

Channel	Frequency (MHz)	Occupied Bandwidth (MHz)
36	5180	24.60
40	5200	30.60
48	5240	19.92
149	5745	33.36
157	5785	33.24
165	5825	33.12

802.11ac (VHT20)

Channel	Frequency (MHz)	Occupied Bandwidth (MHz)
36	5180	22.56
40	5200	31.08
48	5240	19.32
149	5745	34.56
157	5785	34.08
165	5825	34.32

802.11ac (VHT40)

Channel	Frequency (MHz)	Occupied Bandwidth (MHz)
38	5190	36.72
46	5230	38.88
151	5755	57.12
159	5795	66.72

802.11ac (VHT80)

Channel	Frequency (MHz)	Occupied Bandwidth (MHz)
42	5210	75.84
155	5775	79.20

Spectrum Plot of Worst Value

802.11a / CH149

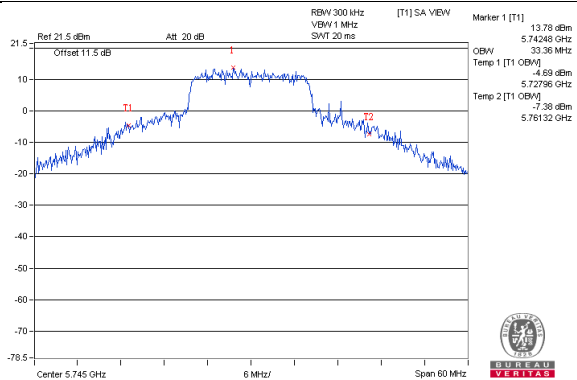

802.11ac (VHT20) / CH149

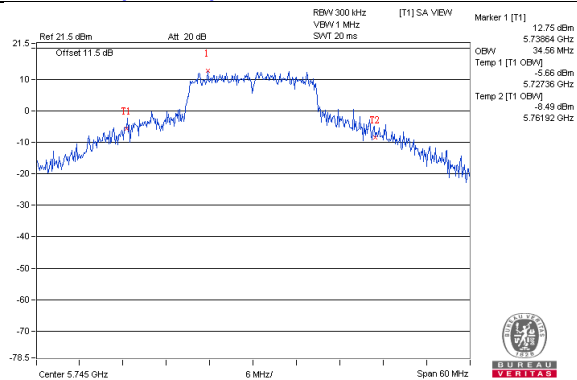

802.11ac (VHT40) / CH159

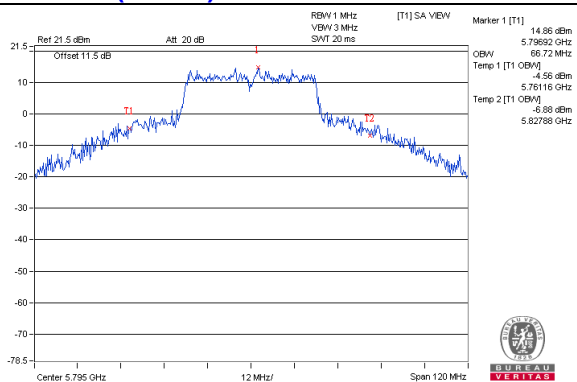

802.11ac (VHT80) / CH155

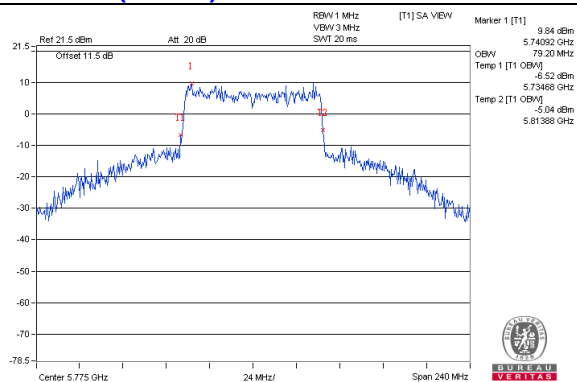

**Spectrum Plot for near by DFS band
(DFS is required, if 99% OCP straddle into U-NII-2A band)**

802.11a / CH48

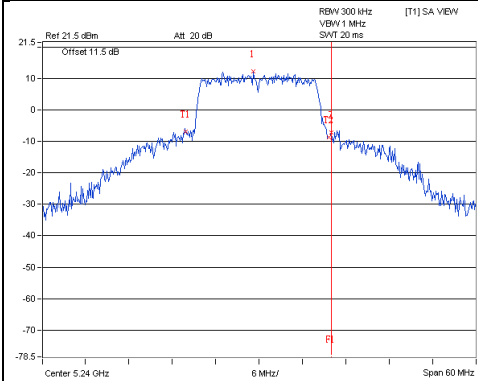

802.11ac(VHT20) / CH48

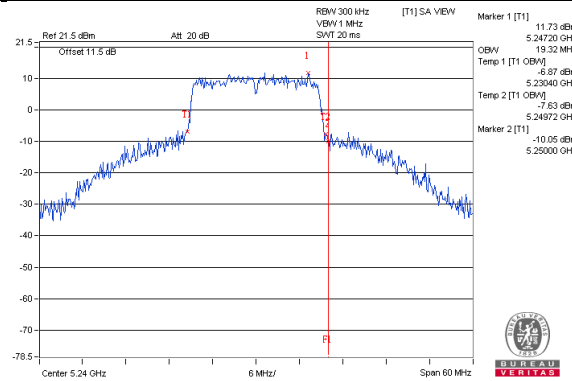

802.11ac(VHT40) / CH46

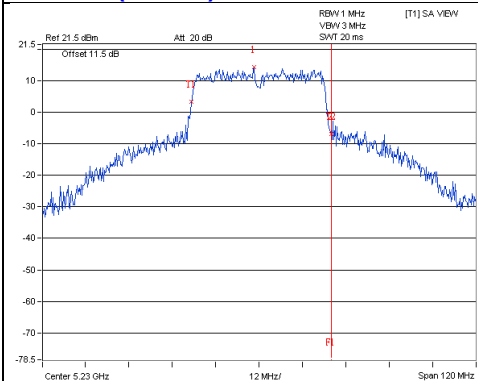

802.11ac(VHT80) / CH42

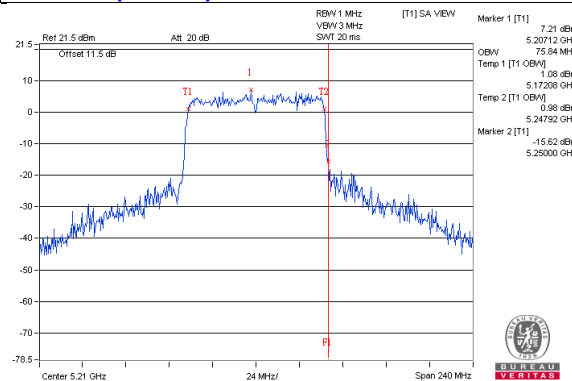

**Spectrum Plot for near by DFS band
(DFS is required, if 99% OCP straddle into U-NII-2C band)**

802.11a / CH149

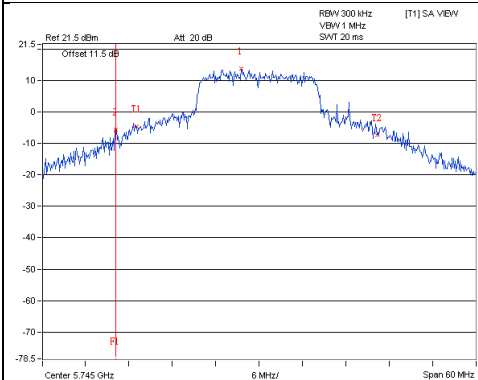

802.11ac(VHT20) / CH149

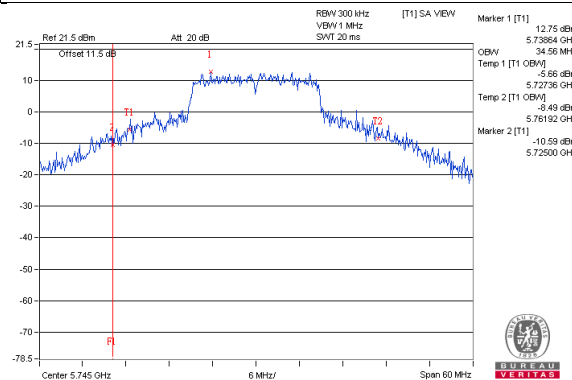

802.11ac(VHT40) / CH151

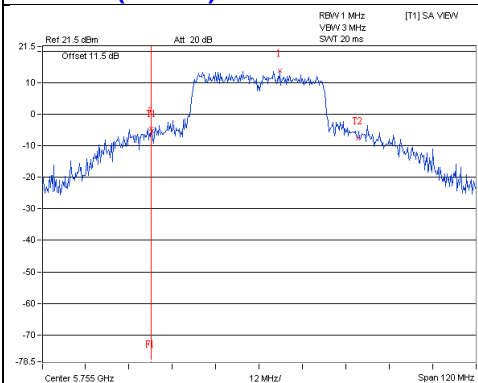

802.11ac(VHT80) / CH155

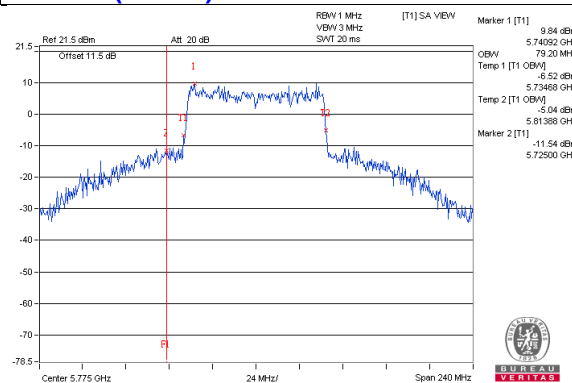

4.5 Peak Power Spectral Density Measurement

4.5.1 Limits of Peak Power Spectral Density Measurement

Operation Band	EUT Category		Limit
U-NII-1		Outdoor Access Point	17dBm/ MHz
		Fixed point-to-point Access Point	
		Indoor Access Point	
	√	Mobile and Portable client device	11dBm/ MHz
U-NII-2A			11dBm/ MHz
U-NII-2C			11dBm/ MHz
U-NII-3		√	30dBm/ 500kHz

4.5.2 Test Setup

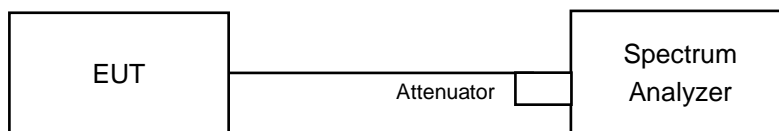

4.5.3 Test Instruments

Refer to section 4.1.2 to get information of above instrument.

4.5.4 Test Procedure

802.11a, 802.11ac (VHT20)

For U-NII-1:

Using method SA-1

1. Set span to encompass the entire emission bandwidth (EBW) of the signal.
2. Set RBW = 1 MHz, Set VBW \geq 3 MHz, Detector = RMS
3. Sweep time = auto, trigger set to "free run".
4. Trace average at least 100 traces in power averaging mode.
5. Record the max value

For U-NII-3:

1. Set span to encompass the entire emission bandwidth (EBW) of the signal.
2. Set RBW = 300 kHz, Set VBW \geq 1 MHz, Detector = RMS
3. Use the peak marker function to determine the maximum power level in any 300 kHz band segment within the fundamental EBW.
4. Scale the observed power level to an equivalent value in 500 kHz by adjusting (reducing) the measured power by a bandwidth correction factor (BWCF) where $BWCF = 10\log(500 \text{ kHz}/300\text{kHz})$
5. Sweep time = auto, trigger set to "free run".
6. Trace average at least 100 traces in power averaging mode.
7. Record the max value

802.11ac (VHT40), 802.11ac (VHT80)

For U-NII-1:

Using method SA-2

1. Set span to encompass the entire emission bandwidth (EBW) of the signal.
2. Set RBW = 1 MHz, Set VBW \geq 3 MHz, Detector = RMS
3. Sweep time = auto, trigger set to "free run".
4. Trace average at least 100 traces in power averaging mode.
5. Record the max value and add $10 \log(1/\text{duty cycle})$

For U-NII-3:

1. Set span to encompass the entire emission bandwidth (EBW) of the signal.
2. Set RBW = 300 kHz, Set VBW \geq 1 MHz, Detector = RMS
3. Use the peak marker function to determine the maximum power level in any 300 kHz band segment within the fundamental EBW.
4. Scale the observed power level to an equivalent value in 500 kHz by adjusting (reducing) the measured power by a bandwidth correction factor (BWCF) where $BWCF = 10\log(500 \text{ kHz}/300\text{kHz})$
5. Sweep time = auto, trigger set to "free run".
6. Trace average at least 100 traces in power averaging mode.
7. Record the max value and add $10 \log(1/\text{duty cycle})$

4.5.5 Deviation from Test Standard

No deviation.

4.5.6 EUT Operating Condition

Same as Item 4.3.6.

4.5.7 Test Results

For U-NII-1:

802.11a

Chan.	Chan. Freq. (MHz)	PSD (dBm/MHz)	MAX. Limit (dBm/MHz)	Pass / Fail
36	5180	8.91	11	Pass
40	5200	10.21	11	Pass
48	5240	8.30	11	Pass

802.11ac (VHT20)

Chan.	Chan. Freq. (MHz)	PSD (dBm/MHz)	MAX. Limit (dBm/MHz)	Pass / Fail
36	5180	7.43	11	Pass
40	5200	10.03	11	Pass
48	5240	7.72	11	Pass

802.11ac (VHT40)

Chan.	Chan. Freq. (MHz)	Conducted PSD W/O Duty Factor (dBm/MHz)	Duty Factor (dB)	PSD With Duty Factor (dBm/MHz)	MAX. EIRP Limit (dBm/MHz)	Pass / Fail
36	5180	1.83	0.17	2.00	11	Pass
40	5200	4.29	0.17	4.46	11	Pass

Note: 1. Refer to section 3.3 for duty cycle spectrum plot.

802.11ac (VHT80)

Chan.	Chan. Freq. (MHz)	Conducted PSD W/O Duty Factor (dBm/MHz)	Duty Factor (dB)	PSD With Duty Factor (dBm/MHz)	MAX. EIRP Limit (dBm/MHz)	Pass / Fail
42	5210	-2.54	0.32	-2.22	11	Pass

Note: 1. Refer to section 3.3 for duty cycle spectrum plot.

Spectrum Plot of Worst Value

802.11a / CH40

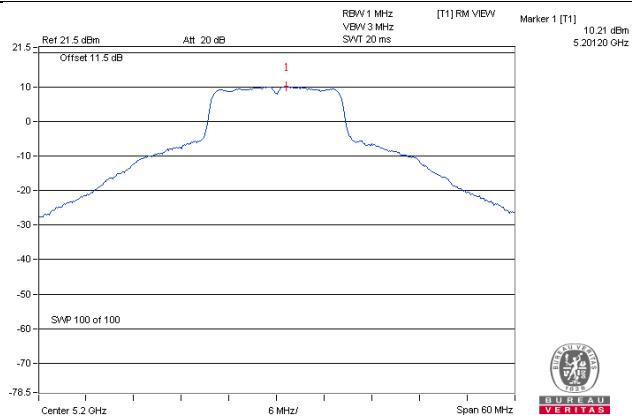

802.11ac (VHT20) / CH40

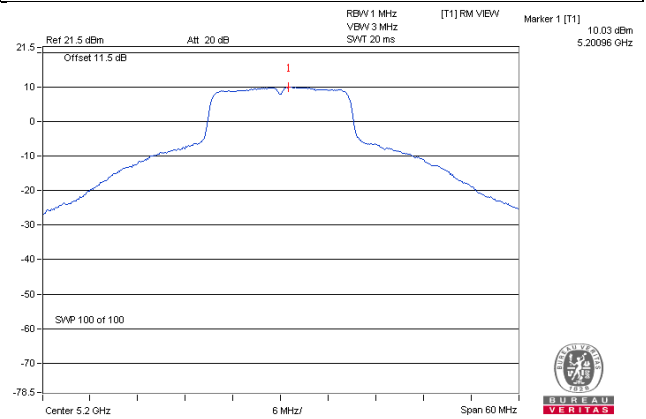

802.11ac (VHT40) / CH46

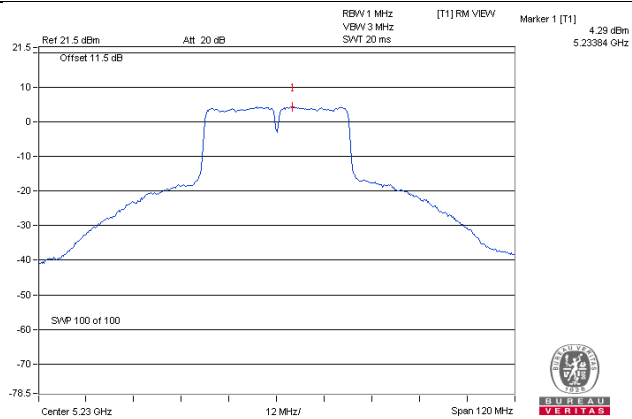

802.11ac (VHT80) / CH42

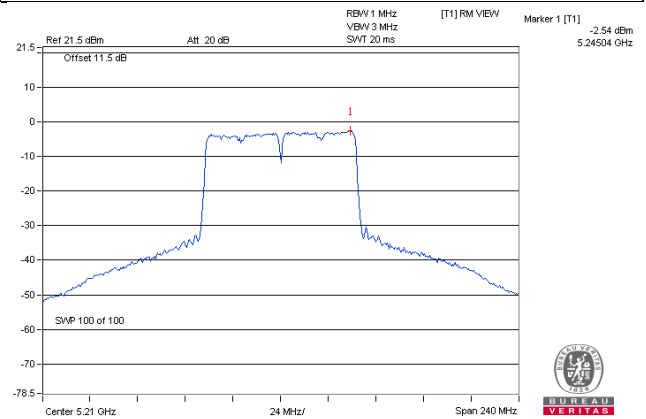

For U-NII-3:
802.11a

Chan.	Chan. Freq. (MHz)	PSD (dBm/300kHz)	PSD (dBm/500kHz)	Limit (dBm/500kHz)	Pass /Fail
149	5745	1.06	3.28	30	Pass
157	5785	0.73	2.95	30	Pass
165	5825	0.40	2.62	30	Pass

802.11ac (VHT20)

Chan.	Chan. Freq. (MHz)	PSD (dBm/300kHz)	PSD (dBm/500kHz)	Limit (dBm/500kHz)	Pass /Fail
149	5745	0.45	2.67	30	Pass
157	5785	-0.02	2.20	30	Pass
165	5825	0.05	2.27	30	Pass

802.11ac (VHT40)

Chan.	Chan. Freq. (MHz)	PSD W/O Duty Factor		Duty Factor (dB)	Total PSD With Duty Factor (dBm/500kHz)	Limit (dBm/500kHz)	Pass /Fail
		(dBm/300kHz)	(dBm/500kHz)				
151	5755	-4.38	-2.16	0.17	-1.99	30	Pass
159	5795	-4.01	-1.79	0.17	-1.62	30	Pass

Note: 1. Refer to section 3.3 for duty cycle spectrum plot.

802.11ac (VHT80)

Chan.	Chan. Freq. (MHz)	PSD W/O Duty Factor		Duty Factor (dB)	Total PSD With Duty Factor (dBm/500kHz)	Limit (dBm/500kHz)	Pass /Fail
		(dBm/300kHz)	(dBm/500kHz)				
155	5775	-9.20	-6.98	0.32	-6.66	30	Pass

Note: 1. Refer to section 3.3 for duty cycle spectrum plot.

Spectrum Plot of Worst Value

802.11a: CH 149

802.11ac (VHT20): CH 149

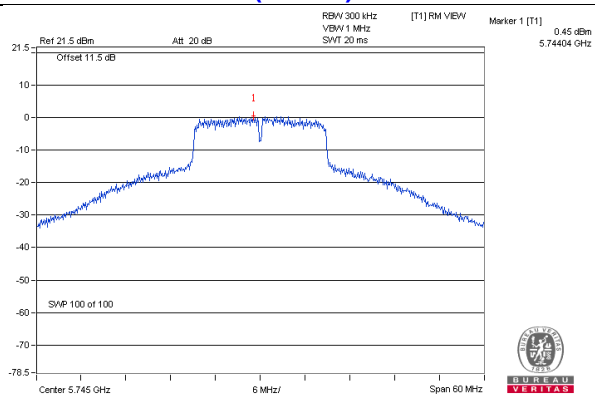
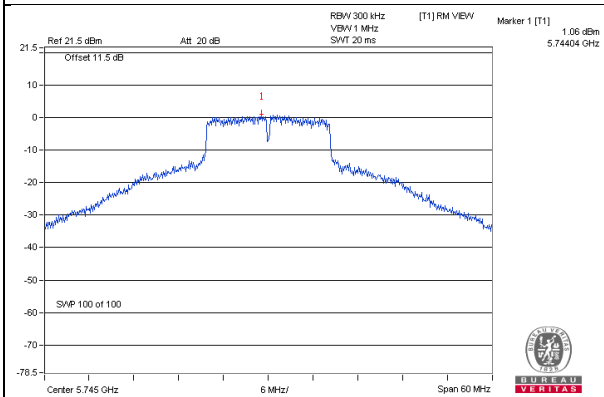

802.11ac (VHT40): CH 159

802.11ac (VHT80): CH 155

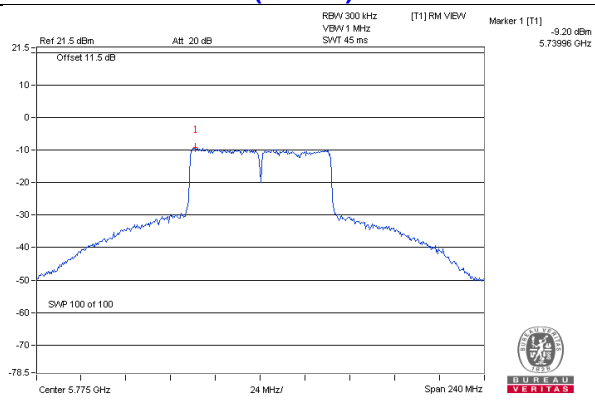
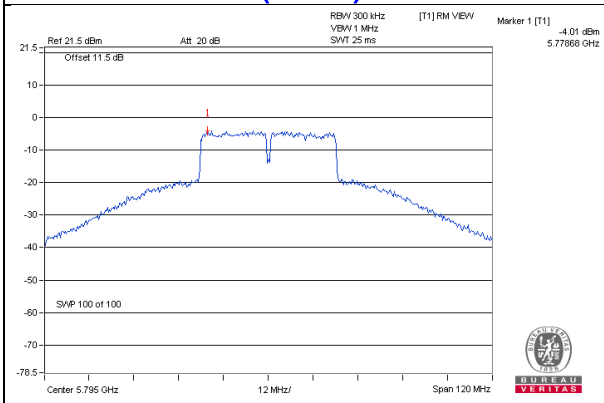

4.6 Frequency Stability Measurement

4.6.1 Limits of Frequency Stability Measurement

The frequency of the carrier signal shall be maintained within band of operation

4.6.2 Test Setup

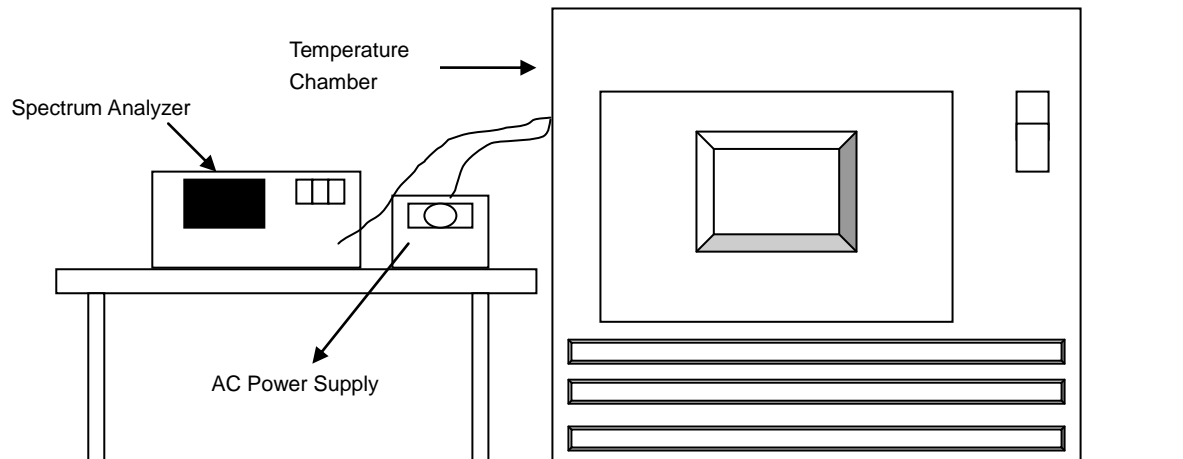

4.6.3 Test Instruments

Refer to section 4.1.2 to get information of above instrument.

4.6.4 Test Procedure

- The EUT was placed inside the environmental test chamber and powered by nominal AC voltage.
- Turn the EUT on and couple its output to a spectrum analyzer.
- Turn the EUT off and set the chamber to the highest temperature specified.
- Allow sufficient time (approximately 30 min) for the temperature of the chamber to stabilize, turn the EUT on and measure the operating frequency after 2, 5, and 10 Minutes.
- Repeat step 2 and 3 with the temperature chamber set to the lowest temperature.
- The test chamber was allowed to stabilize at +20 degree C for a minimum of 30 Minutes. The supply voltage was then adjusted on the EUT from 85% to 115% and the frequency record.

4.6.5 Deviation from Test Standard

No deviation.

4.6.6 EUT Operating Condition

Set the EUT transmit at un-modulation mode to test frequency stability.

4.6.7 Test Results

Frequency Stability Versus Temp.									
Operating Frequency: 5180 MHz									
TEMP. (°C)	Power Supply (Vac)	0 Minute		2 Minute		5 Minute		10 Minute	
		Measured Frequency (MHz)	Pass/Fail	Measured Frequency (MHz)	Pass/Fail	Measured Frequency (MHz)	Pass/Fail	Measured Frequency (MHz)	Pass/Fail
50	120	5179.9764	PASS	5179.9752	PASS	5179.9784	PASS	5179.979	Pass
40	120	5180.0057	PASS	5180.0053	PASS	5180.0072	PASS	5180.0047	Pass
30	120	5179.9753	PASS	5179.9751	PASS	5179.9747	PASS	5179.9744	Pass
20	120	5180.0024	PASS	5180.001	PASS	5180.0041	PASS	5180.0007	Pass
10	120	5179.9879	PASS	5179.9877	PASS	5179.9906	PASS	5179.9888	Pass
0	120	5179.9905	PASS	5179.9928	PASS	5179.9937	PASS	5179.9934	Pass
-10	120	5180.0177	PASS	5180.0195	PASS	5180.0205	PASS	5180.0198	Pass
-20	120	5179.987	PASS	5179.9839	PASS	5179.9852	PASS	5179.9873	Pass
-30	120	5180.0246	PASS	5180.0224	PASS	5180.0207	PASS	5180.0227	Pass

Frequency Stability Versus Voltage									
Operating Frequency: 5180 MHz									
TEMP. (°C)	Power Supply (Vac)	0 Minute		2 Minute		5 Minute		10 Minute	
		Measured Frequency (MHz)	Pass/Fail	Measured Frequency (MHz)	Pass/Fail	Measured Frequency (MHz)	Pass/Fail	Measured Frequency (MHz)	Pass/Fail
20	138	5180.0018	PASS	5180	PASS	5180.0051	PASS	5180.0007	Pass
	120	5180.0024	PASS	5180.001	PASS	5180.0041	PASS	5180.0007	Pass
	102	5180.0018	PASS	5180.0019	PASS	5180.0045	PASS	5180.0017	Pass

4.7 6dB Bandwidth Measurement

4.7.1 Limits of 6dB Bandwidth Measurement

The minimum of 6dB Bandwidth Measurement is 0.5MHz.

4.7.2 Test Setup

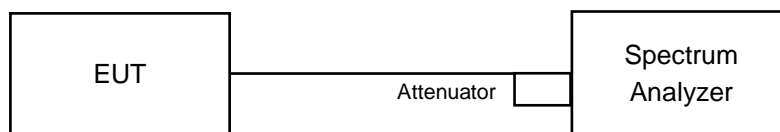

4.7.3 Test Instruments

Refer to section 4.1.2 to get information of above instrument.

4.7.4 Test Procedure

MEASUREMENT PROCEDURE REF

- a. Set resolution bandwidth (RBW) = 100kHz
- b. Set the video bandwidth (VBW) $\geq 3 \times$ RBW, Detector = Peak.
- c. Trace mode = max hold.
- d. Sweep = auto couple.
- e. Measure the maximum width of the emission that is constrained by the frequencies associated with the two amplitude points (upper and lower) that are attenuated by 6 dB relative to the maximum level measured in the fundamental emission

4.7.5 Deviation from Test Standard

No deviation.

4.7.6 EUT Operating Condition

The software provided by client to enable the EUT under transmission condition continuously at lowest, middle and highest channel frequencies individually.

4.7.7 Test Results

802.11a

Channel	Frequency (MHz)	6dB Bandwidth (MHz)	Minimum Limit (MHz)	Pass / Fail
149	5745	16.11	0.5	Pass
157	5785	16.38	0.5	Pass
165	5825	16.33	0.5	Pass

802.11ac (VHT20)

Channel	Frequency (MHz)	6dB Bandwidth (MHz)	Minimum Limit (MHz)	Pass / Fail
149	5745	16.70	0.5	Pass
157	5785	16.61	0.5	Pass
165	5825	16.71	0.5	Pass

802.11ac (VHT40)

Channel	Frequency (MHz)	6dB Bandwidth (MHz)	Minimum Limit (MHz)	Pass / Fail
151	5755	35.82	0.5	Pass
159	5795	35.42	0.5	Pass

802.11ac (VHT80)

Channel	Frequency (MHz)	6dB Bandwidth (MHz)	Minimum Limit (MHz)	Pass / Fail
155	5775	75.48	0.5	Pass

Spectrum Plot of Worst Value

802.11a: CH149

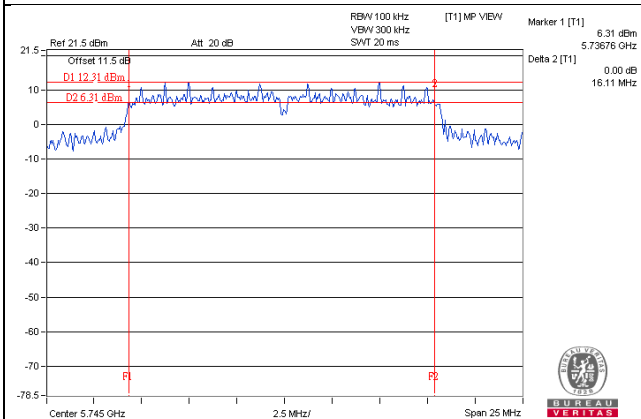

802.11ac(VHT20) : CH157

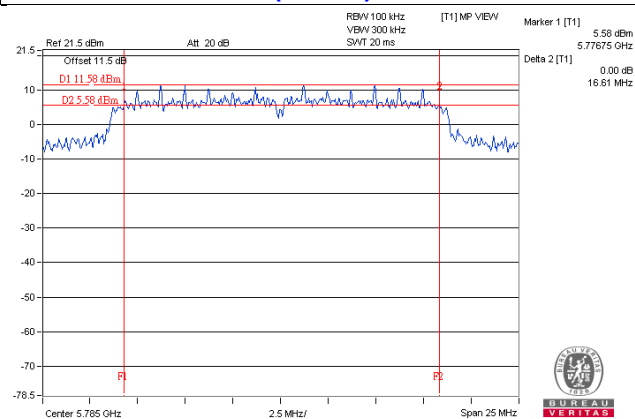

802.11ac(VHT40) : CH159

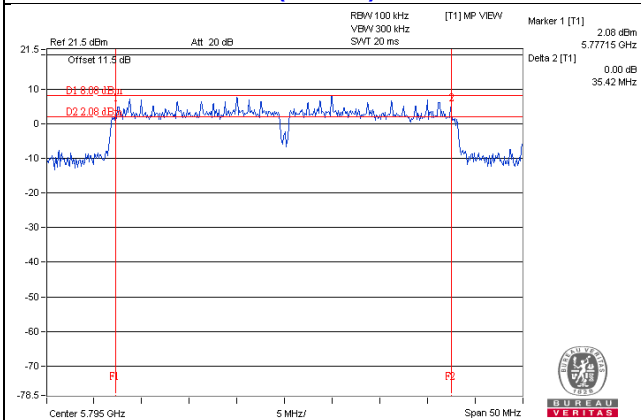

802.11ac(VHT80) / Chain 0 : CH155

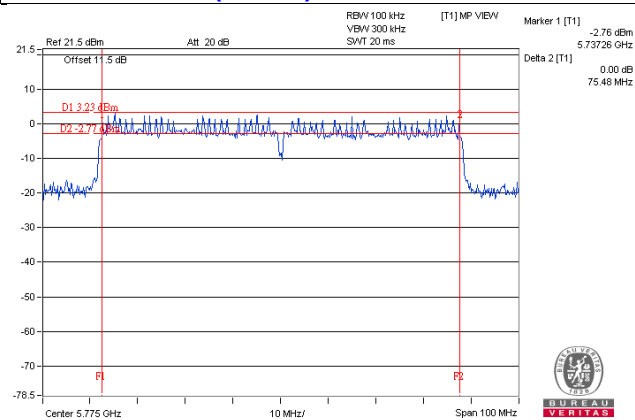

5 Pictures of Test Arrangements

Please refer to the attached file (Test Setup Photo).

Annex A- Radiated Out of Band Emission (OOBE) Measurement (For U-NII-3 band)

802.11a

CH 149 5745 MHz

Horizontal

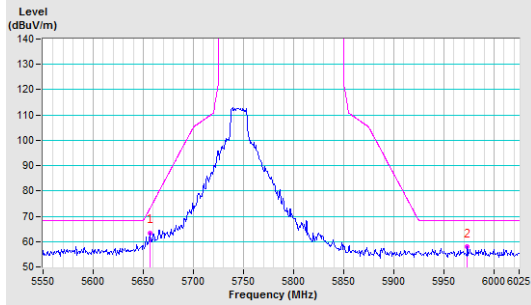

Vertical

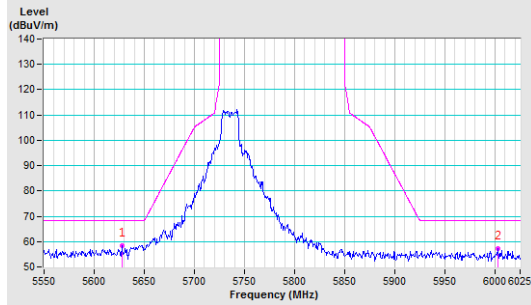

CH 157 5785 MHz

Horizontal

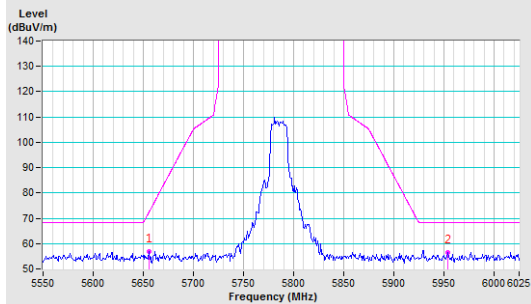

Vertical

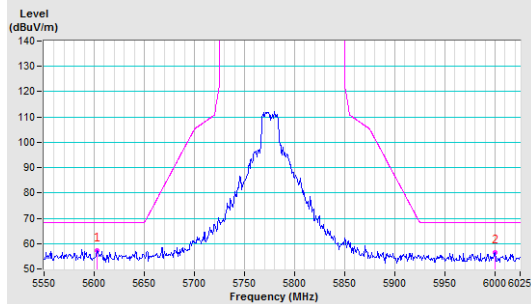

CH 165 5825 MHz

Horizontal

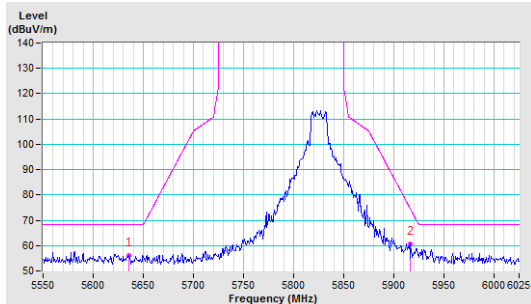

Vertical

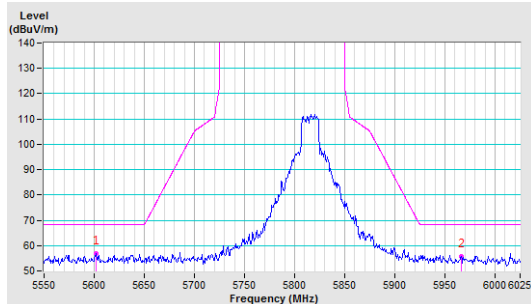

802.11ac (VHT20)

CH 149 5745 MHz

Horizontal

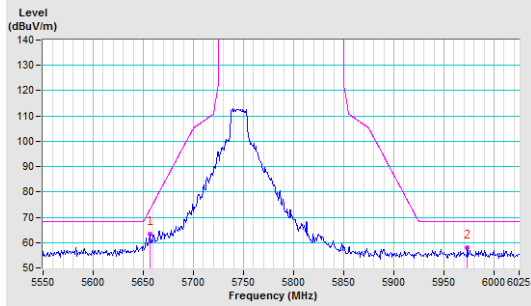

Vertical

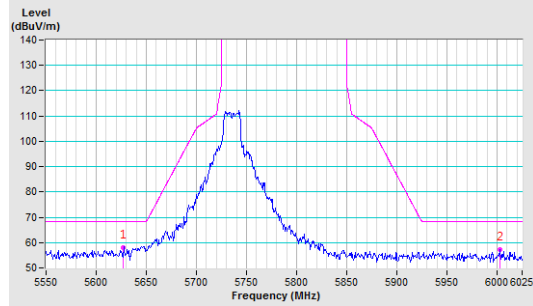

CH 157 5785 MHz

Horizontal

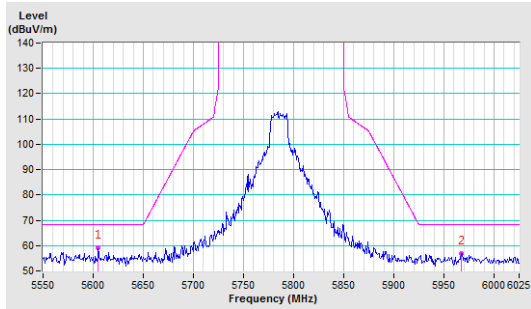

Vertical

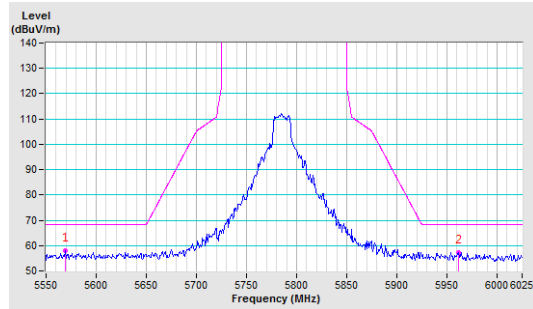

CH 165 5825 MHz

Horizontal

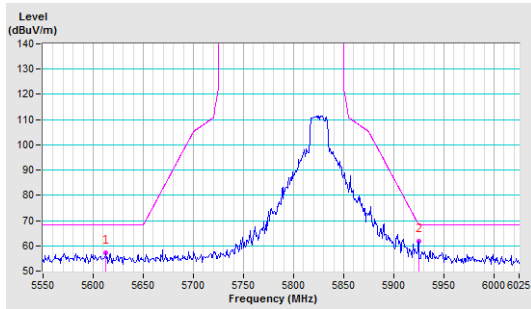

Vertical

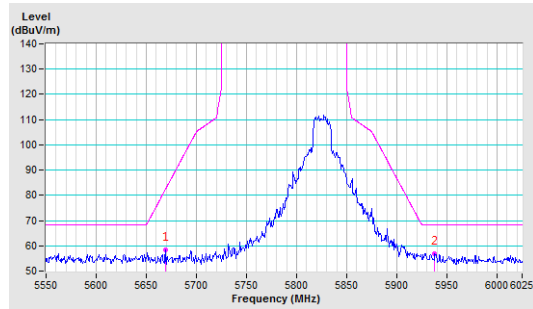

802.11ac (VHT40)

CH 151 5755 MHz

Horizontal

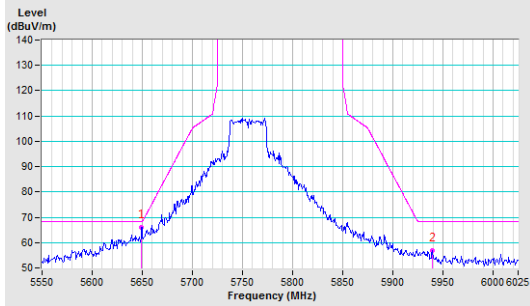

Vertical

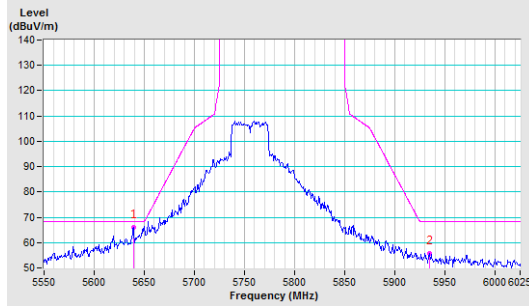

CH 159 5795 MHz

Horizontal

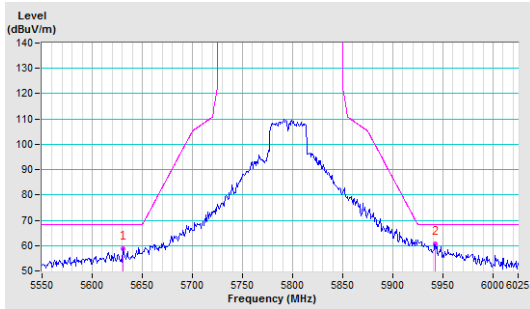

Vertical

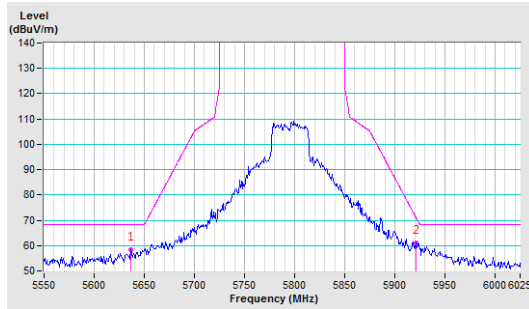

802.11ac (VHT80)

CH 155 5775 MHz

Horizontal

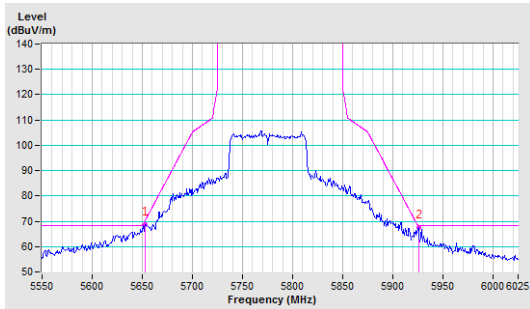

Vertical

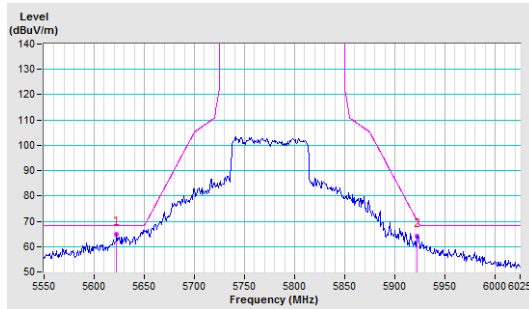

Appendix – Information on the Testing Laboratories

We, Bureau Veritas Consumer Products Services (H.K.) Ltd., Taoyuan Branch, were founded in 1988 to provide our best service in EMC, Radio, Telecom and Safety consultation. Our laboratories are accredited and approved according to ISO/IEC 17025.

If you have any comments, please feel free to contact us at the following:

Linko EMC/RF Lab

Tel: 886-2-26052180

Fax: 886-2-26051924

Hsin Chu EMC/RF/Telecom Lab

Tel: 886-3-6668565

Fax: 886-3-6668323

Hwa Ya EMC/RF/Safety Lab

Tel: 886-3-3183232

Fax: 886-3-3270892

Email: service.adt@tw.bureauveritas.com

Web Site: www.bureauveritas-adt.com

The address and road map of all our labs can be found in our web site also.

--- END ---