



Antenna Specification

Antenna Manufacturer Company Name: Wieson Technologies Co., LTD.

Antenna Manufacturer Company Address: 15F, No.237, Sec.1, Datong Rd., Xizhi Dist., New Taipei City 221006, Taiwan

Antenna Model: ARY196-0232-039-00

Antenna Type: PCB antenna

REV	DATE	DESCRIPTION	ECN NO.	NAME
A1	24.05.31	PROPOSAL		DAVID

RoHS Compliant

A

B

C

D

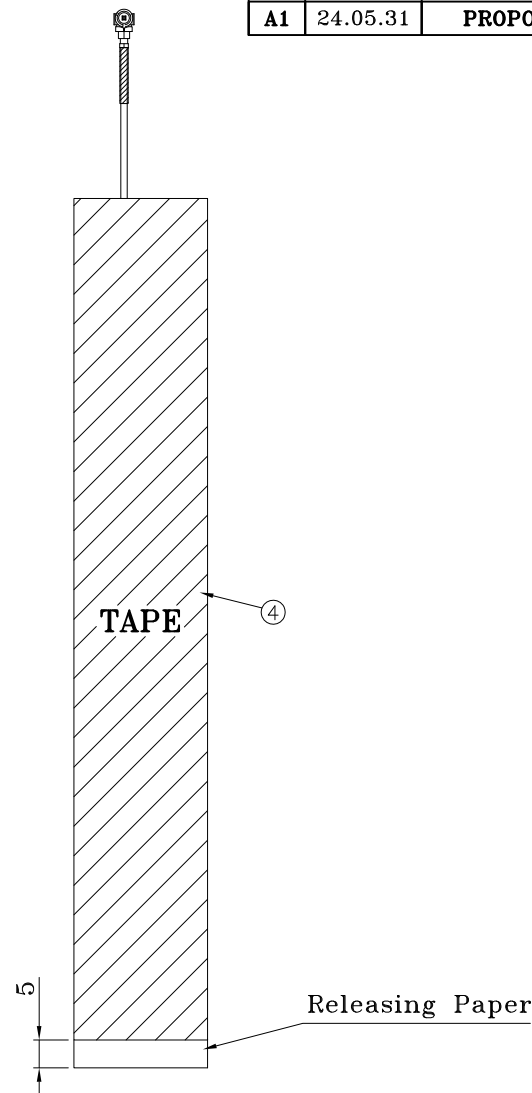
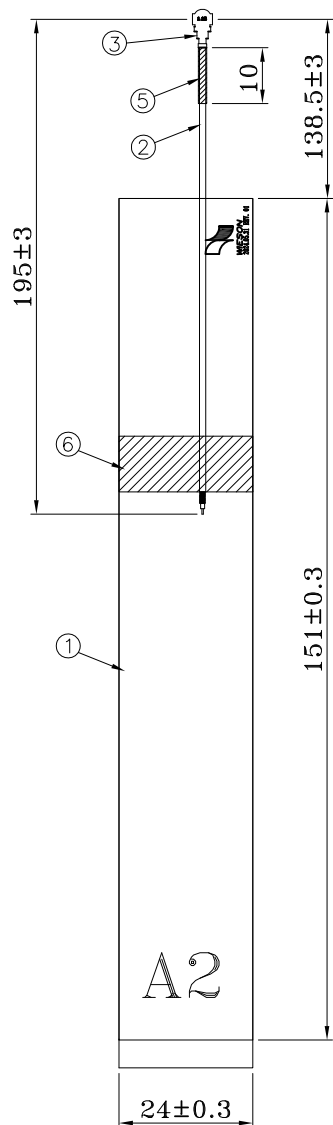

NO.	ITEM	DESCRIPTION	QTY	SORTING NO.	WSC	PAGE	1 OF 1
⑦							
⑥	TAPE	ACETATE TAPE	1				
⑤	H.S TUBE	COLOR : RED , L : 10mm	1				
④	TAPE	G9000 , SIZE: 150.2 X 23.2MM	1				
③	CONNECTOR	MHF I PLUG FOR 1.37MM CABLE , GOLD PLATED	1				
②	CABLE	1.37MM LOW LOSS COAXIAL CABLE , FEP BLACK JACKET	1				
①	PCB	FR-4 , SIZE: 151 X 24 X 0.8MM SOLDER MASK COLOR :GREEN	1				

WIESON TECHNOLOGIES CO., LTD
WIESON

CUST NO.:
11320Y20ZQ00306A1
PART NO.:
ARY196-0232-039-00

ANTENNA 2

TITLE:	DRAWN BY	DAVID(WST)	DRAWING NO.	ARY196-0232-039-00
	CHECKED BY		DRAWING SIZE	A4
	APPROVED BY		UNIT	mm
			PAGE	1 OF 1



WIESON TECHNOLOGIES CO.,LTD

BILL OF MATERIAL

Cust.	永洋	TITLE	RF ANTENNA				
Cust.P/N		WIESON P/N	ARY196-0232-039-00				
NO.	DESCRIPTION	SUPPLIER	SUPPLIER PART NO.	UL NO.	AVL	QUANTITY	REMARK
1	FR-4 , SIZE: 151 X 24 X 0.8MM SOLDER MASK COLOR :GREEN	/	PCB	/		1PCS	
2	1.37MM LOW LOSS COAXIAL CABLE , FEP BLACK JACKET	/	/CABLE	/		MM	
3	MHF I PLUG FOR 1.37MM CABLE , GOLD PLATED	/	Connector/	/		1PCS	
4	G9000 , SIZE: 150.2 X 23.2MM	/	TAPE/			1PCS	
5	COLOR : RED , L : 10mm		H.S TUBE			1PCS	
6	ACETATE TAPE		TAPE			1PCS	
7							
8							

APPROVED BY: ROX

CHECKD BY: JOSN

DESIGNED BY: REASON

A2

Antenna specification

Item	Specification	Item	Specification	Item	Specification
Operating Frequency(GHz)	0.617-0.96	Operating Frequency(GHz)	1.427-2.69	Operating Frequency(GHz)	3.3-4.2
Bandwidth	343 MHz (Min.)	Bandwidth	1263 MHz (Min.)	Bandwidth	900 MHz (Min.)
Return Loss	7 dB (Min.)	Return Loss	6 dB (Min.)	Return Loss	10 dB (Min.)
Polarization	Linear	Polarization	Linear	Polarization	Linear
Azimuth Bandwidth	Omni-directional	Azimuth Bandwidth	Omni-directional	Azimuth Bandwidth	Omni-directional
Impedance	50Ω	Impedance	50Ω	Impedance	50Ω
Material	PCB	Material	PCB	Material	PCB
Connector	MHF I	Connector	MHF I	Connector	MHF I
Cable type	O.D. 1.37 L/L	Cable type	O.D. 1.37 L/L	Cable type	O.D. 1.37 L/L
Maximum Power	1W	Maximum Power	1W	Maximum Power	1W
V.S.W.R	2.5 : 1	V.S.W.R	3 : 1	V.S.W.R	2 : 1
Radiation	Omni directional	Radiation	Omni directional	Radiation	Omni directional
Efficiency	49%(Max.)	Efficiency	57%(Max.)	Efficiency	63%(Max.)
Operating Temperature	-10~60°C	Operating Temperature	-10~60°C	Operating Temperature	-10~60°C
Storage temp	-10~70°C	Storage temp	-10~70°C	Storage temp	-10~70°C

S-Parameter

A2

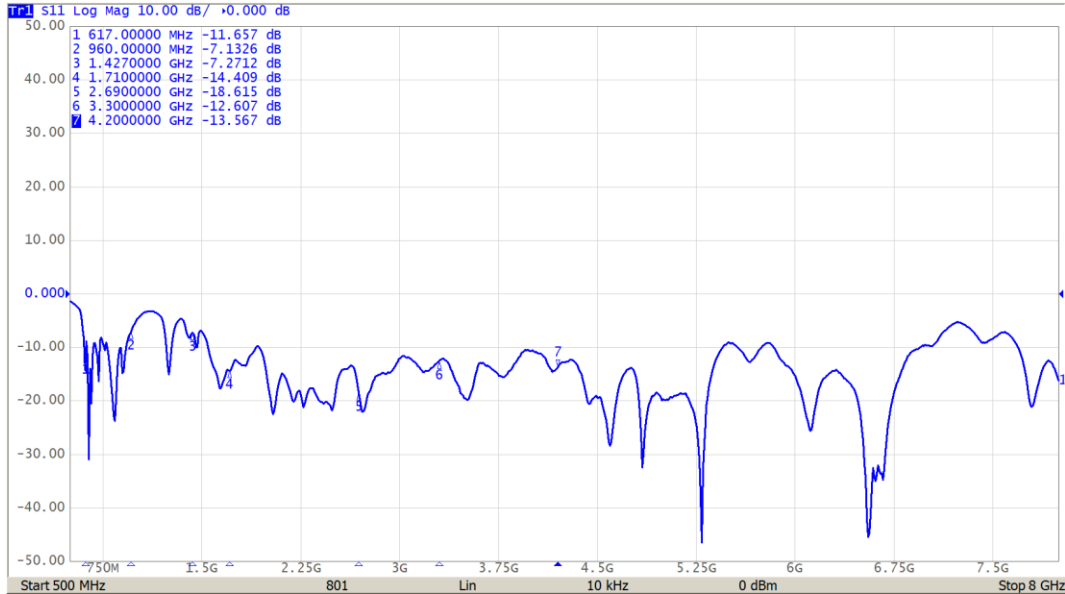

Freq(MHz)	617	960	1427	1710	2690	3300	4200
S11(dB)	-11.7	-7.1	-7.3	-14.4	-18.6	-12.6	-13.6

A2

3D Gain Total



Freq(GHz)	Peak Gain(dBi)	3D-avg Gain(dBi)	Efficiency(%)
0.617	1.9	-3.9	41
0.658	1.7	-3.7	43
0.698	2.2	-4.0	40
0.703	2.6	-4.0	40
0.74	3.7	-3.7	42
0.78	2.7	-3.6	44
0.84	2.3	-3.9	40
0.88	3.6	-3.8	41
0.894	3.4	-3.9	41
0.92	3.9	-3.7	43
0.96	4.7	-3.1	49
1.427	2.4	-4.0	40

Freq(GHz)	Peak Gain(dBi)	3D-avg Gain(dBi)	Efficiency(%)
1.452	3.1	-3.9	41
1.47	1.5	-3.6	44
1.496	2.6	-3.2	48
1.517	2.0	-3.6	44
1.71	2.8	-2.9	52
1.76	2.6	-2.8	53
1.81	2.3	-3.0	50
1.88	2.1	-3.6	43
1.91	2.2	-4.0	40
1.96	3.2	-3.7	43
2.01	3.3	-3.2	48
2.06	4.3	-2.8	53

A2

3D Gain Total

Freq(GHz)	Peak Gain(dBi)	3D-avg Gain(dBi)	Efficiency(%)
2.11	3.2	-3.4	45
2.17	2.8	-2.8	52
2.3	1.1	-2.6	55
2.35	1.0	-2.6	55
2.4	0.9	-2.9	51
2.45	0.2	-2.6	55
2.5	0.1	-2.7	54
2.55	0.1	-2.5	57
2.6	0.2	-3.0	50
2.65	0.0	-2.6	55
2.69	0.1	-2.9	52
3.3	2.2	-2.7	53

Freq(GHz)	Peak Gain(dBi)	3D-avg Gain(dBi)	Efficiency(%)
3.4	0.6	-2.7	54
3.5	0.0	-2.8	53
3.6	0.1	-2.7	54
3.7	0.5	-2.8	53
3.8	0.7	-2.4	57
3.9	0.9	-2.0	63
4	0.5	-2.3	59
4.1	0.0	-2.2	60
4.2	0.5	-2.4	58

A2

Antenna Pattern

Frequency : 617MHz

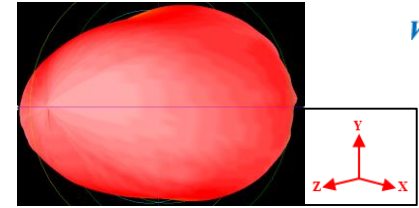

XZ-plane

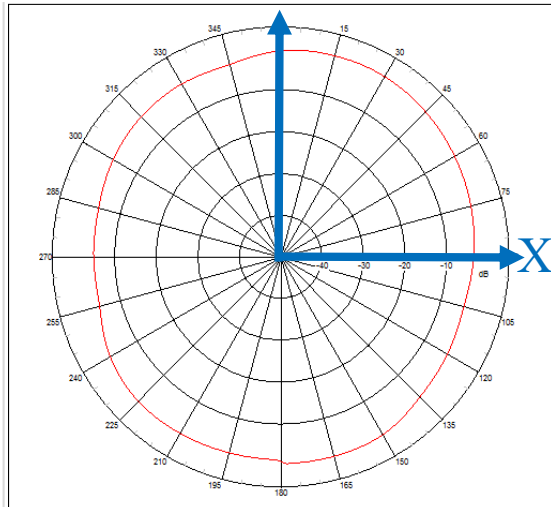

YZ-plane

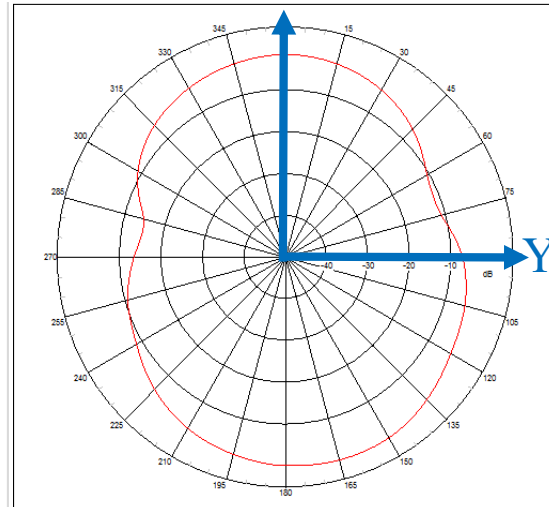

XY-plane

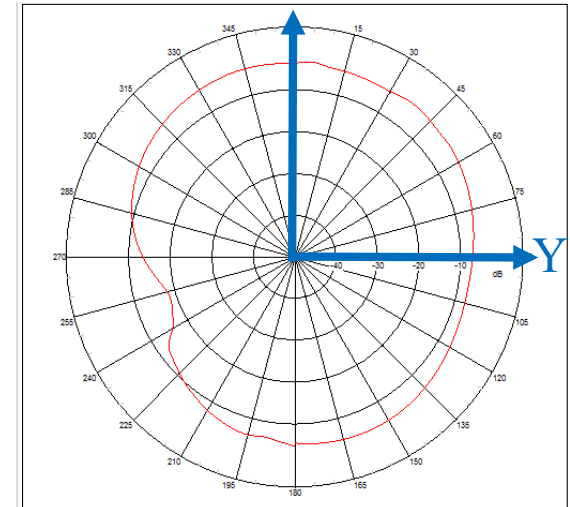

A2

Antenna Pattern

Frequency : 840MHz

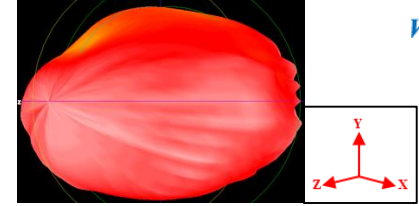

XZ-plane

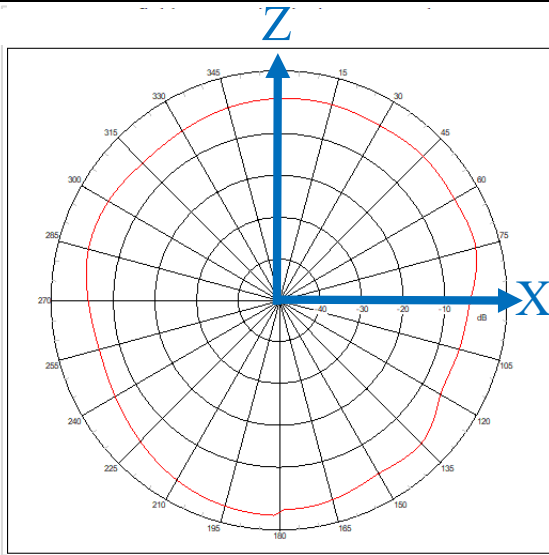

YZ-plane

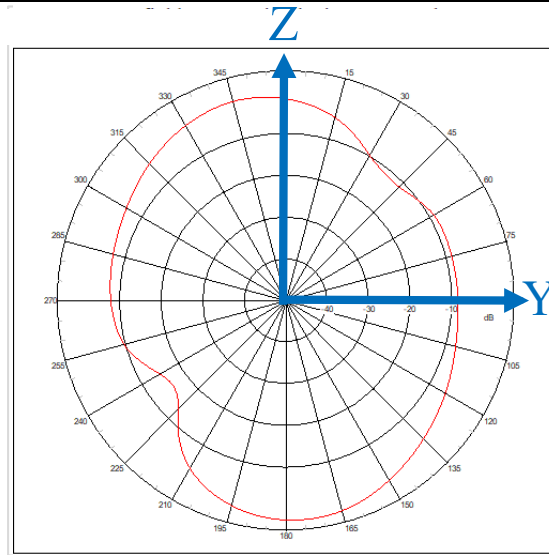

XY-plane

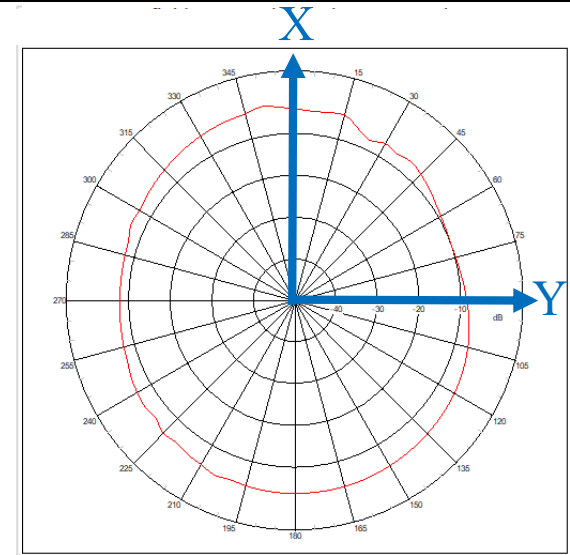

A2

Antenna Pattern

Frequency : 960MHz

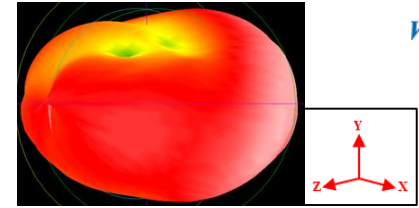

XZ-plane

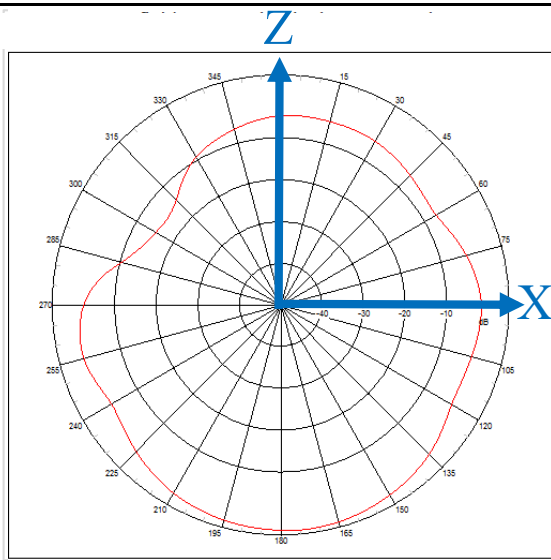

YZ-plane

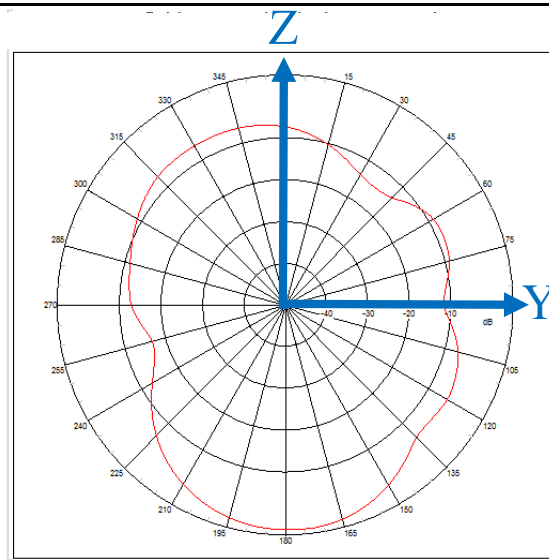

XY-plane

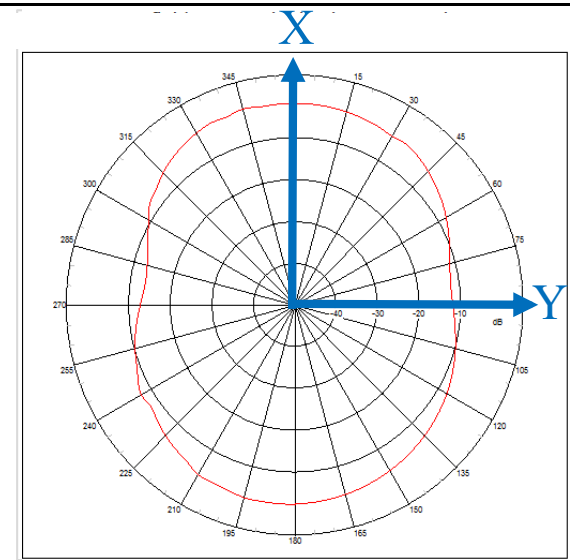

A2

Antenna Pattern

Frequency : 1427MHz

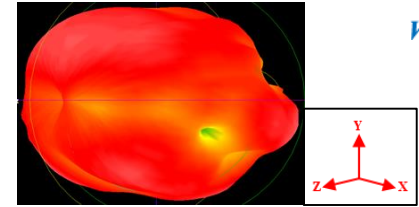

XZ-plane

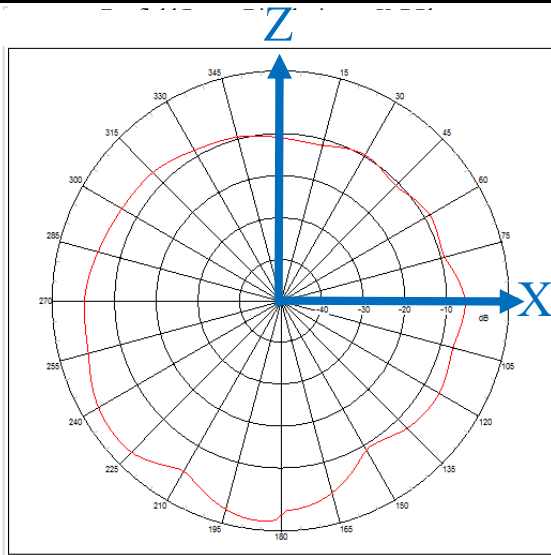

YZ-plane

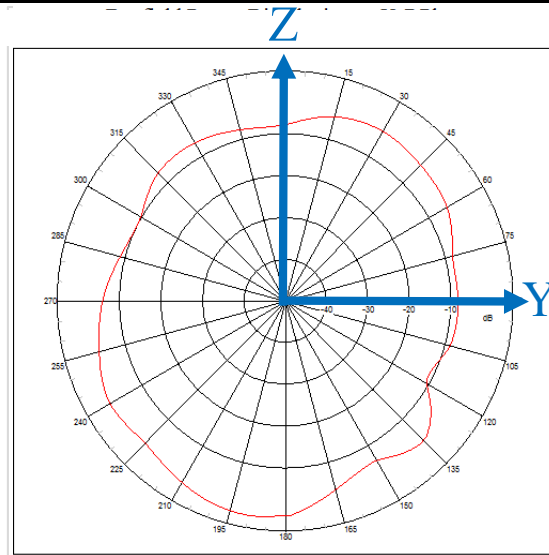

XY-plane

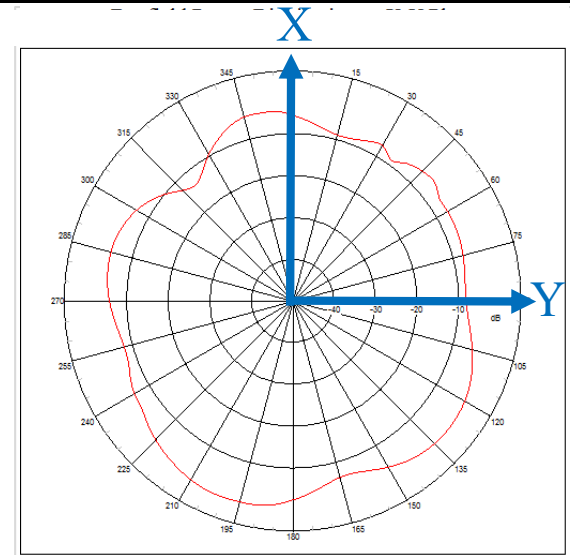

A2

Antenna Pattern

Frequency : 2170MHz

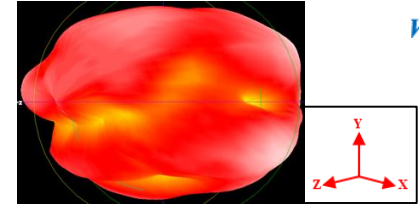

XZ-plane

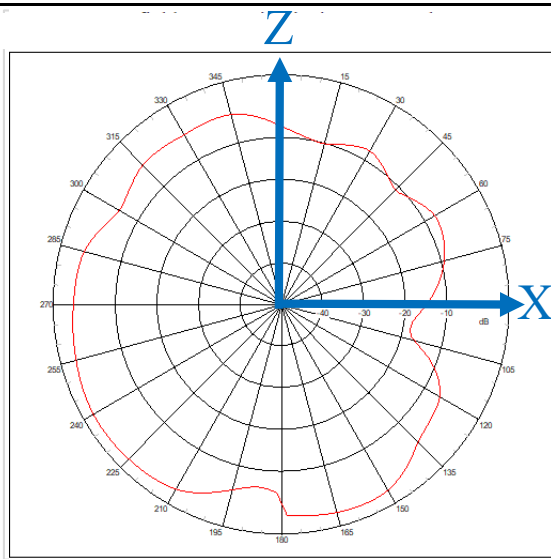

YZ-plane

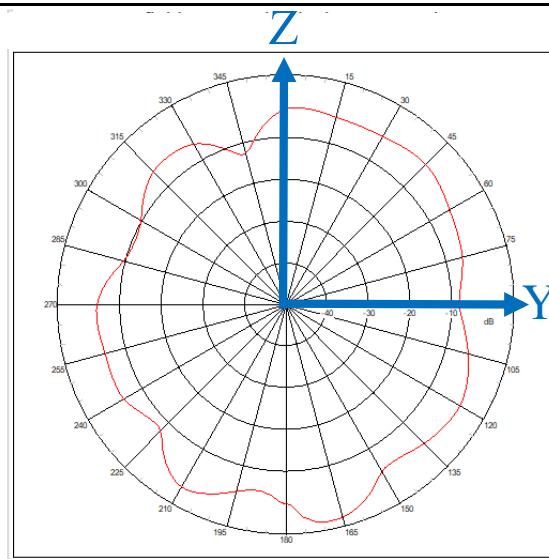

XY-plane

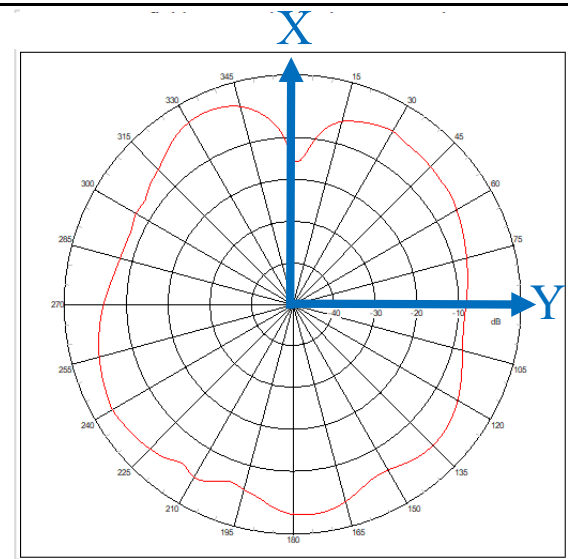

A2

Antenna Pattern

Frequency : 2690MHz

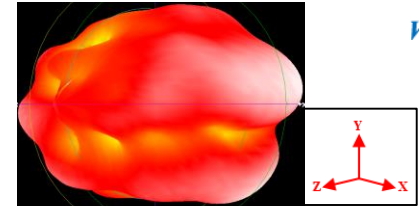

XZ-plane

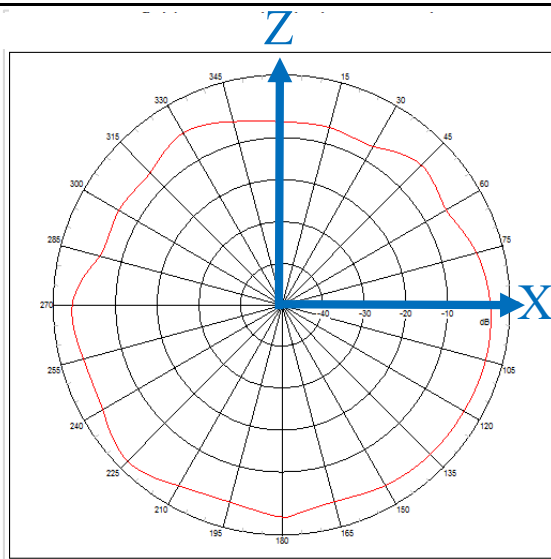

YZ-plane

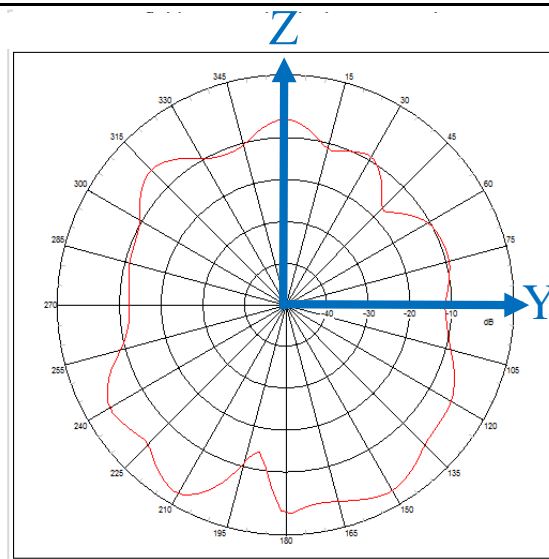

XY-plane

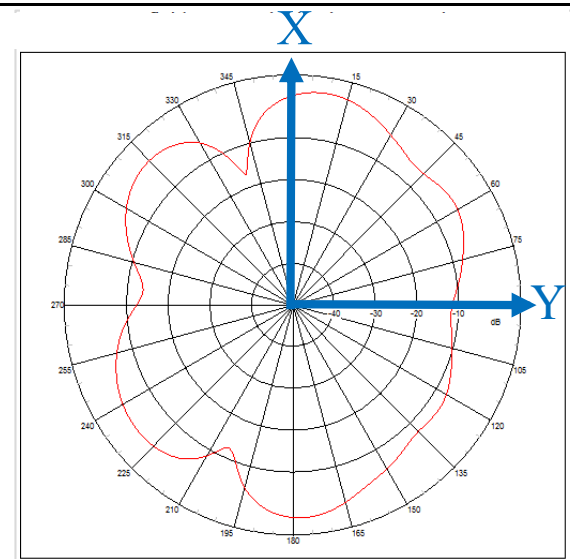

A2

Antenna Pattern

Frequency : 3300MHz

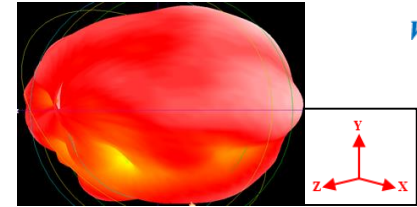

XZ-plane

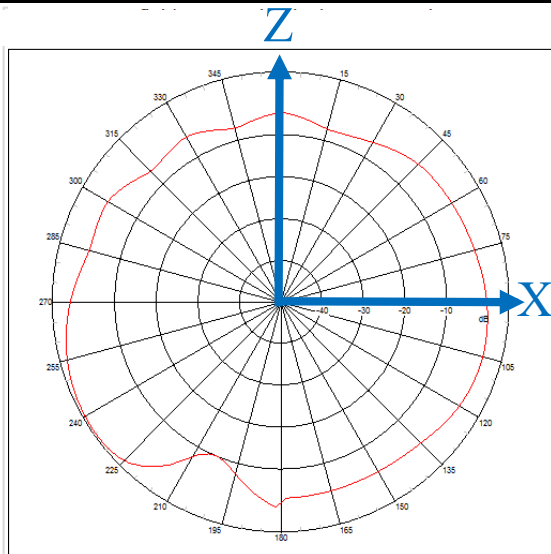

YZ-plane

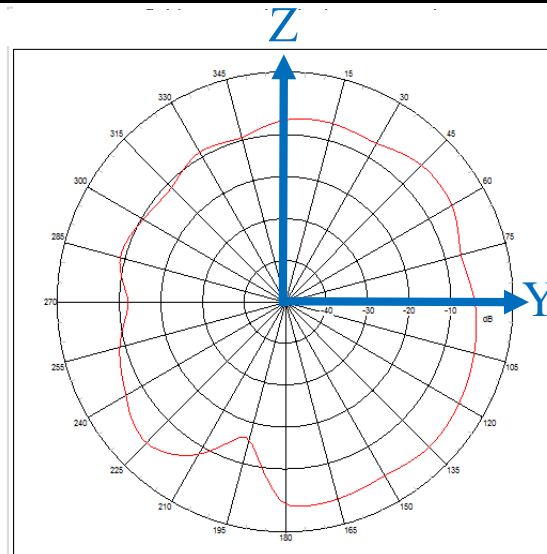

XY-plane

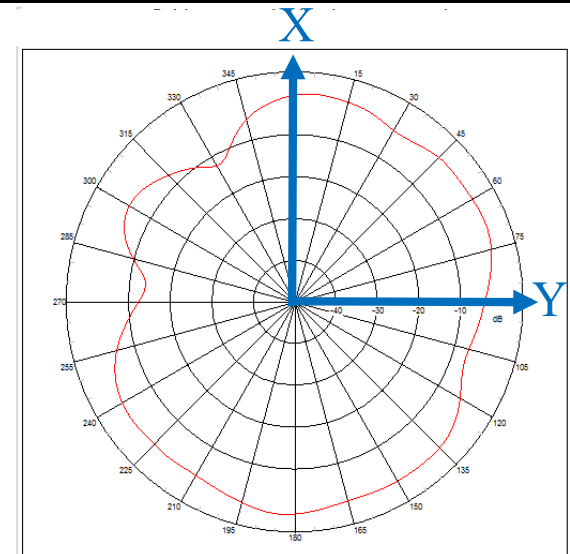

A2

Antenna Pattern

Frequency : 3800MHz

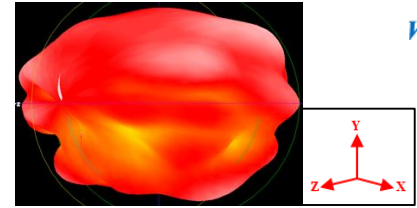

XZ-plane

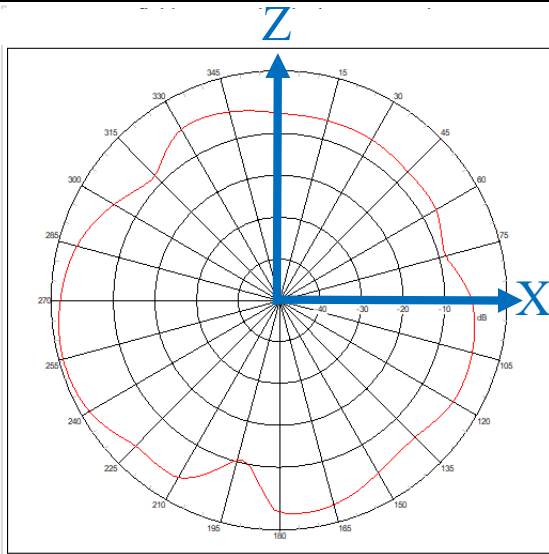

YZ-plane

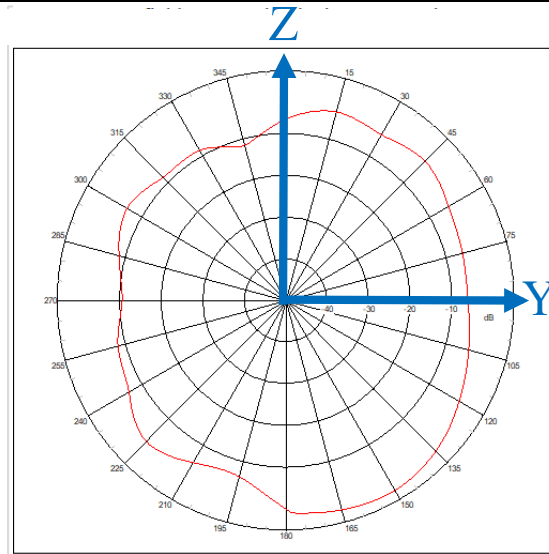

XY-plane

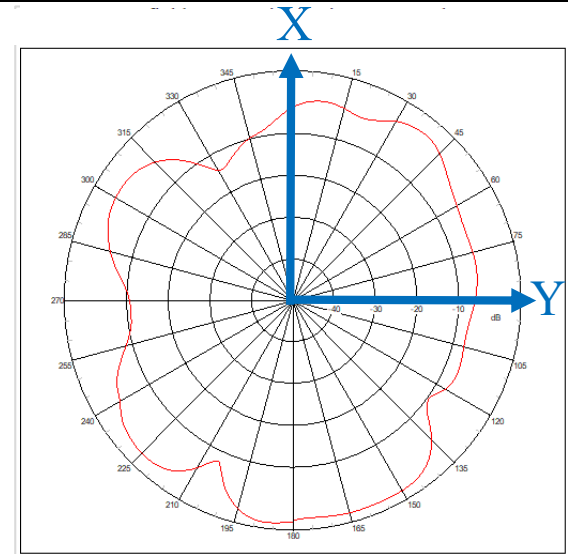

A2

Antenna Pattern

Frequency : 4200MHz

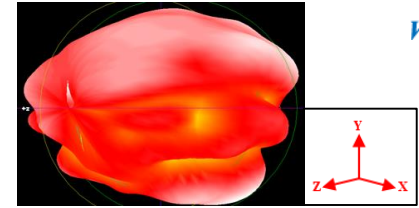

XZ-plane

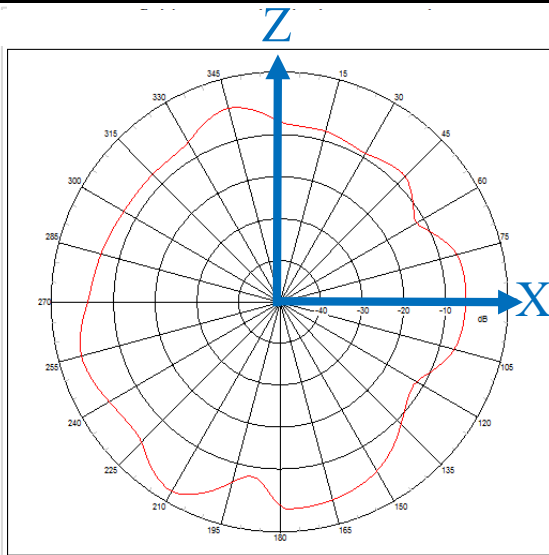

YZ-plane

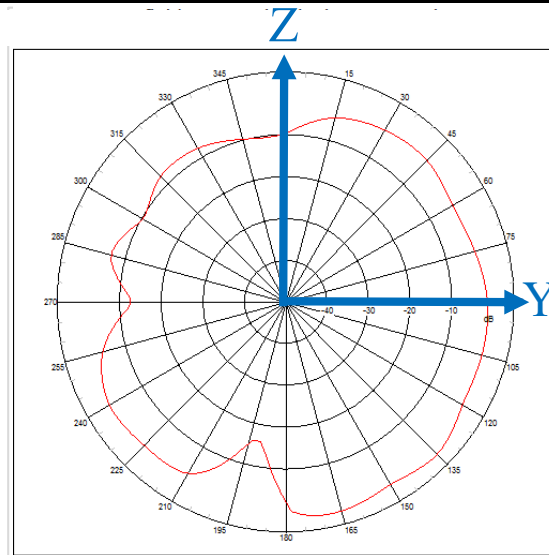

XY-plane

