

FCC Test Report

Report No.: RFBDOI-WTW-P20110878A

FCC ID: KA2M32A1

Test Model: M32

Series Model: DIR-LX3260, M32-SP, M32-TR (refer to item 3.1 for more details)

Received Date: Feb. 27, 2021

Test Date: May 05 ~ Jun. 22, 2021

Issued Date: Jul. 04, 2022

Applicant: D-Link Corporation

Address: 14420 Myford Road Suite 100 Irvine California United States 92606

Issued By: Bureau Veritas Consumer Products Services (H.K.) Ltd., Taoyuan Branch
Lin Kou Laboratories

Lab Address: No. 47-2, 14th Ling, Chia Pau Vil., Lin Kou Dist., New Taipei City, Taiwan

Test Location: No. 19, Hwa Ya 2nd Rd., Wen Hwa Vil., Kwei Shan Dist., Taoyuan City
33383, TAIWAN

**FCC Registration /
Designation Number:** 788550 / TW0003



This report is governed by, and incorporates by reference, the Conditions of Testing as posted at the date of issuance of this report at <http://www.bureauveritas.com/home/about-us/our-business/cps/about-us/terms-conditions/> and is intended for your exclusive use. Any copying or replication of this report to or for any other person or entity, or use of our name or trademark, is permitted only with our prior written permission. This report sets forth our findings solely with respect to the test samples identified herein. The results set forth in this report are not indicative or representative of the quality or characteristics of the lot from which a test sample was taken or any similar or identical product unless specifically and expressly noted. Our report includes all of the tests requested by you and the results thereof based upon the information that you provided to us. Measurement uncertainty is only provided upon request for accredited tests. Statements of conformity are based on simple acceptance criteria without taking measurement uncertainty into account, unless otherwise requested in writing. You have 60 days from date of issuance of this report to notify us of any material error or omission caused by our negligence or if you require measurement uncertainty; provided, however, that such notice shall be in writing and shall specifically address the issue you wish to raise. A failure to raise such issue within the prescribed time shall constitute your unqualified acceptance of the completeness of this report, the tests conducted and the correctness of the report contents.

Table of Contents

Release Control Record	4
1 Certificate of Conformity	5
2 Summary of Test Results	6
2.1 Measurement Uncertainty.....	6
2.2 Modification Record.....	6
3 General Information	7
3.1 General Description of EUT.....	7
3.2 Description of Test Modes.....	10
3.2.1 Test Mode Applicability and Tested Channel Detail.....	11
3.3 Duty Cycle of Test Signal.....	13
3.4 Description of Support Units.....	14
3.4.1 Configuration of System under Test.....	14
3.5 General Description of Applied Standards and References.....	15
4 Test Types and Results	16
4.1 Radiated Emission and Bandedge Measurement.....	16
4.1.1 Limits of Radiated Emission and Bandedge Measurement.....	16
4.1.2 Test Instruments.....	17
4.1.3 Test Procedures.....	18
4.1.4 Deviation from Test Standard.....	18
4.1.5 Test Setup.....	19
4.1.6 EUT Operating Conditions.....	20
4.1.7 Test Results.....	21
4.2 Conducted Emission Measurement.....	47
4.2.1 Limits of Conducted Emission Measurement.....	47
4.2.2 Test Instruments.....	47
4.2.3 Test Procedures.....	48
4.2.4 Deviation from Test Standard.....	48
4.2.5 Test Setup.....	48
4.2.6 EUT Operating Conditions.....	48
4.2.7 Test Results.....	49
4.3 Transmit Power Measurement.....	51
4.3.1 Limits of Transmit Power Measurement.....	51
4.3.2 Test Setup.....	51
4.3.3 Test Instruments.....	52
4.3.4 Test Procedure.....	52
4.3.5 Deviation from Test Standard.....	52
4.3.6 EUT Operating Conditions.....	52
4.3.7 Test Result.....	53
4.4 Occupied Bandwidth Measurement.....	76
4.4.1 Test Setup.....	76
4.4.2 Test Instruments.....	76
4.4.3 Test Procedure.....	76
4.4.4 Test Result.....	77
4.5 Peak Power Spectral Density Measurement.....	80
4.5.1 Limits of Peak Power Spectral Density Measurement.....	80
4.5.2 Test Setup.....	80
4.5.3 Test Instruments.....	80
4.5.4 Test Procedures.....	80
4.5.5 Deviation from Test Standard.....	80
4.5.6 EUT Operating Conditions.....	80
4.5.7 Test Results.....	81
4.6 Frequency Stability.....	86
4.6.1 Limits of Frequency Stability Measurement.....	86

4.6.2 Test Setup.....	86
4.6.3 Test Instruments	86
4.6.4 Test Procedure	86
4.6.5 Deviation from Test Standard	87
4.6.6 EUT Operating Condition	87
4.6.7 Test Results	87
4.7 6dB Bandwidth Measurement.....	88
4.7.1 Limits of 6dB Bandwidth Measurement.....	88
4.7.2 Test Setup.....	88
4.7.3 Test Instruments	88
4.7.4 Test Procedure	88
4.7.5 Deviation from Test Standard	88
4.7.6 EUT Operating Condition	88
4.7.7 Test Results	89
5 Pictures of Test Arrangements.....	91
Annex A- Band Edge Measurement.....	92
Appendix – Information of the Testing Laboratories	100

Release Control Record

Issue No.	Description	Date Issued
RFBDOI-WTW-P20110878A	Original release.	Jul. 04, 2022

1 Certificate of Conformity

Product: AX3200 WI-FI 6 AI MESH SYSTEM, AX3200 WI-FI 6 AI MESH ROUTER, AX3200 MESH ROUTER, AX3200 MESH SYSTEM, AX3200 MESH WI-FI 6 ROUTER (refer to item 3.1 for more details)

Brand: D-Link

Test Model: M32

Series Model: DIR-LX3260, M32-SP, M32-TR (refer to item 3.1 for more details)

Sample Status: Engineering sample

Applicant: D-Link Corporation

Test Date: May 05 ~ Jun. 22, 2021

Standards: 47 CFR FCC Part 15, Subpart E (Section 15.407)
ANSI C63.10:2013

The above equipment has been tested by **Bureau Veritas Consumer Products Services (H.K.) Ltd., Taoyuan Branch**, and found compliance with the requirement of the above standards. The test record, data evaluation & Equipment Under Test (EUT) configurations represented herein are true and accurate accounts of the measurements of the sample's RF characteristics under the conditions specified in this report.

Prepared by :  , **Date:** Jul. 04, 2022
Polly Chien / Specialist

Approved by :  , **Date:** Jul. 04, 2022
Jeremy Lin / Project Engineer

2 Summary of Test Results

47 CFR FCC Part 15, Subpart E (Section 15.407)			
FCC Clause	Test Item	Result	Remarks
15.407(b)(9)	AC Power Conducted Emissions	Pass	Meet the requirement of limit. Minimum passing margin is -15.57dB at 0.42353MHz.
15.407(b)(1/2/3/4(i/ii)/9)	Radiated Emissions & Band Edge Measurement	Pass	Meet the requirement of limit. Minimum passing margin is -0.6dB at 17160.00MHz, 5725.00MHz, 10520.00MHz and 10640.00MHz.
15.407(a)(1/2/3)	Max Average Transmit Power	Pass	Meet the requirement of limit.
---	Occupied Bandwidth Measurement	-	Reference only.
15.407(a)(1/2/3)	Peak Power Spectral Density	Pass	Meet the requirement of limit.
15.407(e)	6dB bandwidth	Pass	Meet the requirement of limit. (U-NII-3 Band only)
15.407(g)	Frequency Stability	Pass	Meet the requirement of limit.
15.203	Antenna Requirement	Pass	Antenna connector are MHF compatible not a standard connector.

Note:

- For U-NII-2A, U-NII-2C band compliance with rule 15.407(b) of the band-edge items, the test plots were recorded in Annex A. Test Procedures refer to report 4.1.3.
- Determining compliance based on the results of the compliance measurement, not taking into account measurement instrumentation uncertainty.

2.1 Measurement Uncertainty

Where relevant, the following measurement uncertainty levels have been estimated for tests performed on the EUT as specified in CISPR 16-4-2:

Measurement	Frequency	Expanded Uncertainty (k=2) (±)
Conducted Emissions at mains ports	150kHz ~ 30MHz	2.79 dB
Radiated Emissions up to 1 GHz	9kHz ~ 30MHz	3.04 dB
	30MHz ~ 200MHz	3.59 dB
	200MHz ~ 1000MHz	3.60 dB
Radiated Emissions above 1 GHz	1GHz ~ 18GHz	2.29 dB
	18GHz ~ 40GHz	2.29 dB

2.2 Modification Record

There were no modifications required for compliance.

3 General Information

3.1 General Description of EUT

Product	AX3200 WI-FI 6 AI MESH SYSTEM, AX3200 WI-FI 6 AI MESH ROUTER, AX3200 MESH ROUTER, AX3200 MESH SYSTEM, AX3200 MESH WI-FI 6 ROUTER (refer to note for more details)
Brand	D-Link
Test Model	M32
Series Model	DIR-LX3260, M32-SP, M32-TR
Model Difference	Refer to note
Sample Status	Engineering sample
Power Supply rating	12Vdc from Adapter
Modulation Type	256QAM, 64QAM, 16QAM, QPSK, BPSK for OFDM 1024QAM, 256QAM, 64QAM, 16QAM, QPSK, BPSK for OFDMA
Modulation Technology	OFDM, OFDMA
Transfer Rate	802.11a: 54/48/36/24/18/12/9/6Mbps 802.11n (HT20/40): up to 600Mbps 802.11ac (VHT20/40/80): up to 1733.3Mbps 802.11ax: up to 2401.9Mbps
Operating Frequency	5260 ~ 5320MHz, 5500 ~ 5720MHz
Number of Channel	5260 ~ 5320MHz: 802.11a, 802.11n (HT20), 802.11ac (VHT20), 802.11ax (HE20): 4 802.11n (HT40), 802.11ac (VHT40), 802.11ax (HE40): 2 802.11ac (VHT80), 802.11ax (HE80): 1 5500 ~ 5720MHz: 802.11a, 802.11n (HT20), 802.11ac (VHT20), 802.11ax (HE20): 12 802.11n (HT40), 802.11ac (VHT40), 802.11ax (HE40): 6 802.11ac (VHT80), 802.11ax (HE80): 3
Output Power	CDD Mode: 5260 ~ 5320MHz: 210.448mW 5500 ~ 5720MHz: 182.159mW Beamforming Mode: 5260 ~ 5320MHz: 52.619mW 5500 ~ 5720MHz: 45.546mW
Antenna Type	Refer to note
Antenna Connector	Refer to note
Accessory Device	Refer to note
Cable Supplied	Refer to note

Note:

1. This report is prepared for FCC class II permissive change. The differences compared with the original report (BV CPS report no.: RFBDOI-WTW-P20110878-1) are adding 5.26GHz to 5.32GHz and 5.50GHz to 5.72GHz and straddle channels (CH144, CH142, CH138) by software.
2. The EUT supports 11ax Full-RU only.

3. All models are listed as below. Model M32 is the representative for final test.

Brand	Product name	Model	Difference
D-Link	AX3200 WI-FI 6 AI MESH SYSTEM	M32	For marketing purpose
	AX3200 WI-FI 6 AI MESH ROUTER		
	AX3200 MESH ROUTER		
	AX3200 MESH SYSTEM		
	AX3200 MESH WI-FI 6 ROUTER	DIR-LX3260	
	AX3200 WI-FI 6 AI MESH SYSTEM	M32-SP	
	AX3200 WI-FI 6 AI MESH ROUTER		
	AX3200 MESH WI-FI 6 ROUTER		
	AX3200 WI-FI 6 AI MESH SYSTEM	M32-TR	
	AX3200 WI-FI 6 AI MESH ROUTER		
	AX3200 MESH WI-FI 6 ROUTER		

4. The top case of the EUT comes with two part number, which is MPCO3260BAXXU1XX and MPCOX320BAXAU1XX. After pretest, MPCO3260BAXXU1XX is found to be the worst case mode and therefore is recorded in the test report.

5. The EUT incorporates a MIMO function. Physically, the EUT provides 4 completed transmitters and 4 receivers.

Modulation Mode	Beamforming Mode	TX Function
802.11a	Not Support	4TX
802.11n (HT20)	Support	4TX
802.11n (HT40)	Support	4TX
802.11ac (VHT20)	Support	4TX
802.11ac (VHT40)	Support	4TX
802.11ac (VHT80)	Support	4TX
802.11ax (HE20)	Support	4TX
802.11ax (HE40)	Support	4TX
802.11ax (HE80)	Support	4TX

* The bandwidth and modulation are similar for HT20/HT40 on 802.11n mode and VHT20/VHT40/VHT80 on 802.11ac mode and HE20/HE40/HE80 on 802.11ax mode. Therefore the investigated worst case is the representative mode in test report. (Final test mode refer section 3.2.1)

* For 802.11n, CDD mode and Beamforming mode are presented in power output test item. For other test items, CDD mode is the worst case for final tests after pretesting.

6. The EUT consumes power from the following accessory device.

Item	Brand	Model	Description
Adapter	Amigo	AMS200-1202000FU	Input Power: 100-240Vac, 50-60Hz, 0.8A Max Output Power: 12Vdc, 2A
CAT5E 24AWG CCA WHITE CABLE	Nienyi	NYS4710 REV.0	1.0m

7. The following antennas were provided to the EUT.

Antenna Type		Dipole x 4 for WiFi Printed PIFA Antenna x 1 for Bluetooth					
		MHF compatible					
Antenna No.		Gain (dBi)					
		2400MHz	2450MHz	2500MHz	5150MHz	5550Mhz	5825MHz
1	WLAN Dual Band	4.5	4.0	3.5	3.3	4.9	3.1
2	WLAN Dual Band	3.0	3.1	3.6	4.0	4.4	3.8
3	WLAN Dual Band	4.6	4.5	5.4	5.4	6.4	6.7
4	WLAN Dual Band	5.4	5.7	5.9	3.8	4.9	6.7
5	BT 2.4G Band	4.4	4.8	4.9	-	-	-

*The above Antenna information is declared by manufacturer and for more detailed features description, please refer to the manufacturer's specifications, the laboratory shall not be held responsible.

8. WLAN 2.4GHz, 5GHz and BT technology can transmit at same time.

9. Spurious emission of the simultaneous operation (WLAN 2.4GHz, 5GHz and BT) has been evaluated and no non-compliance was found.

3.2 Description of Test Modes

5260~5320MHz:

4 channels are provided for 802.11a, 802.11n (HT20), 802.11ac (VHT20), 802.11ax (HE20):

Channel	Frequency	Channel	Frequency
52	5260 MHz	60	5300 MHz
56	5280 MHz	64	5320 MHz

2 channels are provided for 802.11n (HT40), 802.11ac (VHT40), 802.11ax (HE40):

Channel	Frequency	Channel	Frequency
54	5270 MHz	62	5310 MHz

1 channel is provided for 802.11ac (VHT80), 802.11ax (HE80):

Channel	Frequency
58	5290MHz

5500~5720MHz:

12 channels are provided for 802.11a, 802.11n (HT20), 802.11ac (VHT20), 802.11ax (HE20):

Channel	Frequency	Channel	Frequency
100	5500 MHz	124	5620 MHz
104	5520 MHz	128	5640 MHz
108	5540 MHz	132	5660 MHz
112	5560 MHz	136	5680 MHz
116	5580 MHz	140	5700 MHz
120	5600 MHz	144	5720 MHz

6 channels are provided for 802.11n (HT40), 802.11ac (VHT40), 802.11ax (HE40):

Channel	Frequency	Channel	Frequency
102	5510 MHz	126	5630 MHz
110	5550 MHz	134	5670 MHz
118	5590 MHz	142	5710 MHz

3 channels are provided for 802.11ac (VHT80), 802.11ax (HE80):

Channel	Frequency	Channel	Frequency
106	5530 MHz	122	5610 MHz
138	5690 MHz		

3.2.1 Test Mode Applicability and Tested Channel Detail

EUT Configure Mode	Applicable to				Description
	RE \geq 1G	RE<1G	PLC	APCM	
-	√	√	√	√	-

Where RE \geq 1G: Radiated Emission above 1GHz & Bandedge Measurement
 RE<1G: Radiated Emission below 1GHz
 PLC: Power Line Conducted Emission
 APCM: Antenna Port Conducted Measurement

Note:

1. The EUT had been pre-tested on the positioned of each 3 axis. The worst case was found when positioned on **X-plane**.
2. For radiated emission (below 1GHz) and power line conducted emission test items chosen the worst maximum power mode.

Radiated Emission Test (Above 1GHz):

- Pre-Scan has been conducted to determine the worst-case mode from all possible combinations between available modulations, data rates and antenna ports (if EUT with antenna diversity architecture).
- Following channel(s) was (were) selected for the final test as listed below.

EUT Configure Mode	Mode	Frequency Band (MHz)	Available Channel	Tested Channel	Modulation Technology	Data Rate (Mbps)
-	802.11a	5260-5320	52 to 64	52, 60, 64	OFDM	6.0
-	802.11ax (HE20)		52 to 64	52, 60, 64	OFDMA	MCS0
-	802.11ax (HE40)		54 to 62	54, 62	OFDMA	MCS0
-	802.11ax (HE80)		58	58	OFDMA	MCS0
-	802.11a	5500-5720	100 to 144	100, 116, 140, 144	OFDM	6.0
-	802.11ax (HE20)		100 to 144	100, 116, 140, 144	OFDMA	MCS0
-	802.11ax (HE40)		102 to 142	102, 110, 134, 142	OFDMA	MCS0
-	802.11ax (HE80)		106, 138	106, 122, 138	OFDMA	MCS0

Radiated Emission Test (Below 1GHz):

- Pre-Scan has been conducted to determine the worst-case mode from all possible combinations between available modulations, data rates and antenna ports (if EUT with antenna diversity architecture).
- Following channel(s) was (were) selected for the final test as listed below.

EUT Configure Mode	Mode	Frequency Band (MHz)	Available Channel	Tested Channel	Modulation Technology	Data Rate (Mbps)
-	802.11ax (HE80)	5260-5320	52 to 64	58	OFDMA	MCS0

Power Line Conducted Emission Test:

- Pre-Scan has been conducted to determine the worst-case mode from all possible combinations between available modulations, data rates and antenna ports (if EUT with antenna diversity architecture).
- Following channel(s) was (were) selected for the final test as listed below.

EUT Configure Mode	Mode	Frequency Band (MHz)	Available Channel	Tested Channel	Modulation Technology	Data Rate (Mbps)
-	802.11ax (HE80)	5260-5320	52 to 64	58	OFDMA	MCS0

Antenna Port Conducted Measurement:

- This item includes all test value of each mode, but only includes spectrum plot of worst value of each mode.
- Pre-Scan has been conducted to determine the worst-case mode from all possible combinations between available modulations, data rates and antenna ports (if EUT with antenna diversity architecture).
- Following channel(s) was (were) selected for the final test as listed below.

EUT Configure Mode	Mode	Frequency Band (MHz)	Available Channel	Tested Channel	Modulation Technology	Data Rate (Mbps)
-	802.11a	5260-5320	52 to 64	52, 60, 64	OFDM	6.0
-	802.11ax (HE20)		52 to 64	52, 60, 64	OFDMA	MCS0
-	802.11ax (HE40)		54 to 62	54, 62	OFDMA	MCS0
-	802.11ax (HE80)		58	58	OFDMA	MCS0
-	802.11a	5500-5720	100 to 144	100, 116, 140, 144	OFDM	6.0
-	802.11ax (HE20)		100 to 144	100, 116, 140, 144	OFDMA	MCS0
-	802.11ax (HE40)		102 to 142	102, 110, 134, 142	OFDMA	MCS0
-	802.11ax (HE80)		106, 138	106, 122, 138	OFDMA	MCS0

Test Condition:

Applicable to	Environmental Conditions	Input Power	Tested by
RE \geq 1G	22 deg. C, 68% RH	120Vac, 60Hz	Rex Wang
RE<1G	22 deg. C, 68% RH	120Vac, 60Hz	Rex Wang
PLC	25 deg. C, 75% RH	120Vac, 60Hz	Rex Wang
APCM	25 deg. C, 60% RH	120Vac, 60Hz	Ivan Tseng

3.3 Duty Cycle of Test Signal

Duty cycle of test signal is < 98%, duty factor shall be considered.

802.11a: Duty cycle = 1.375ms/1.675ms = 0.821, Duty factor = $10 * \log(1/0.821) = 0.86$

802.11ax (HE20): Duty cycle = 1.010ms/1.240ms = 0.815, Duty factor = $10 * \log(1/0.815) = 0.89$

802.11ax (HE40): Duty cycle = 0.542ms/0.749ms = 0.724, Duty factor = $10 * \log(1/0.724) = 1.40$

802.11ax (HE80): Duty cycle = 0.295ms/0.498ms = 0.592, Duty factor = $10 * \log(1/0.592) = 2.27$

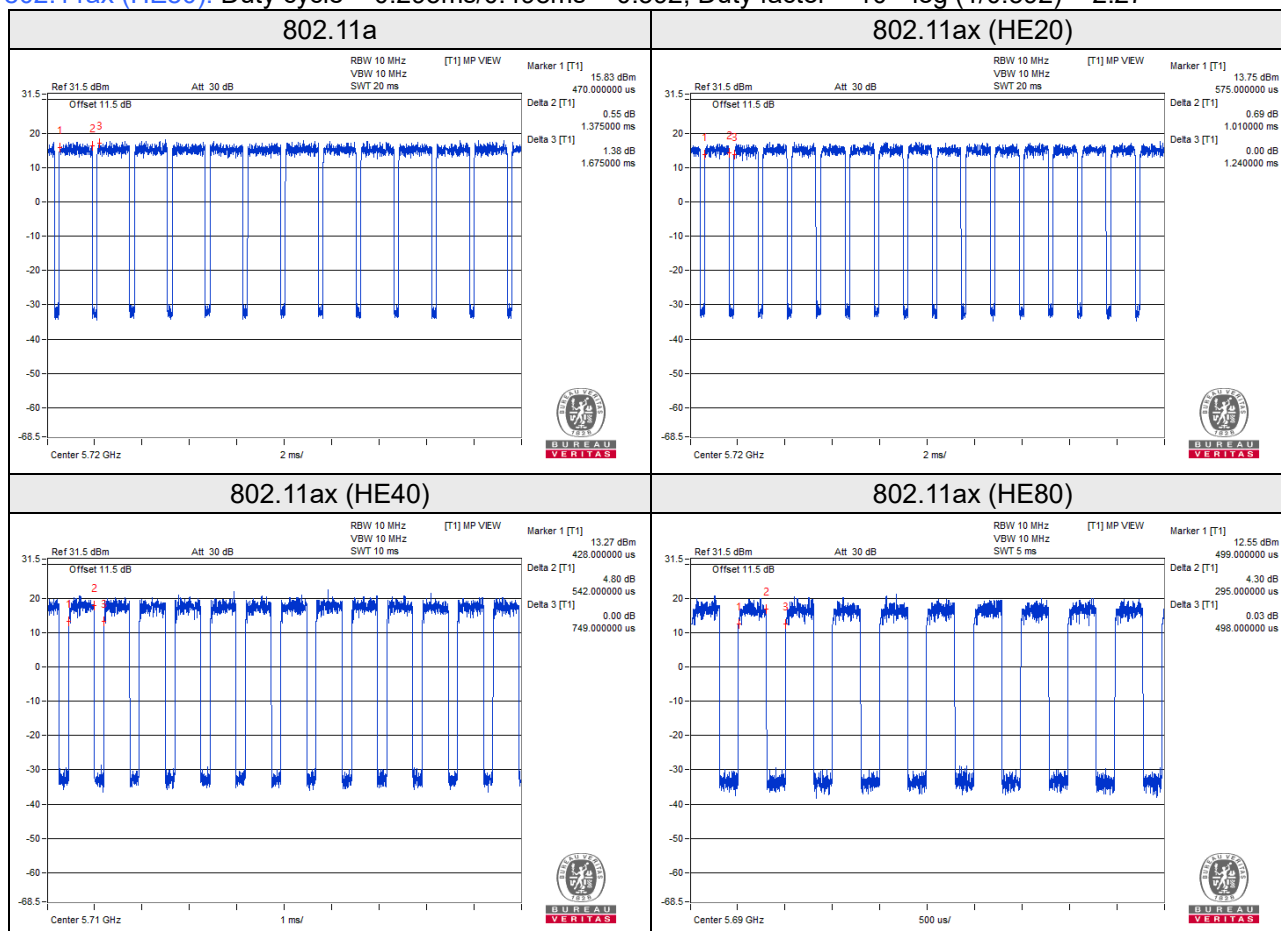

3.4 Description of Support Units

The EUT has been tested as an independent unit together with other necessary accessories or support units. The following support units or accessories were used to form a representative test configuration during the tests.

ID	Product	Brand	Model No.	Serial No.	FCC ID	Remarks
A.	Notebook	DELL	LATITUDE	F9MQBW1	FCC DoC Approved	Provided by lab
B.	Load	NA	NA	NA	NA	Provided by lab

Note:

1. All power cords of the above support units are non-shielded (1.8m).
2. Items A acted as communication partner to transfer data.

ID	Cable Descriptions	Qty.	Length (m)	Shielding (Yes/No)	Cores (Qty.)	Remarks
1.	LAN	2	1.5	N	0	RJ45, Cat5e (provided by lab)
2.	LAN	1	1.5	N	0	RJ45, Cat5e (Accessory)
3.	LAN	1	7	N	0	RJ45, Cat5e (provided by lab)

3.4.1 Configuration of System under Test

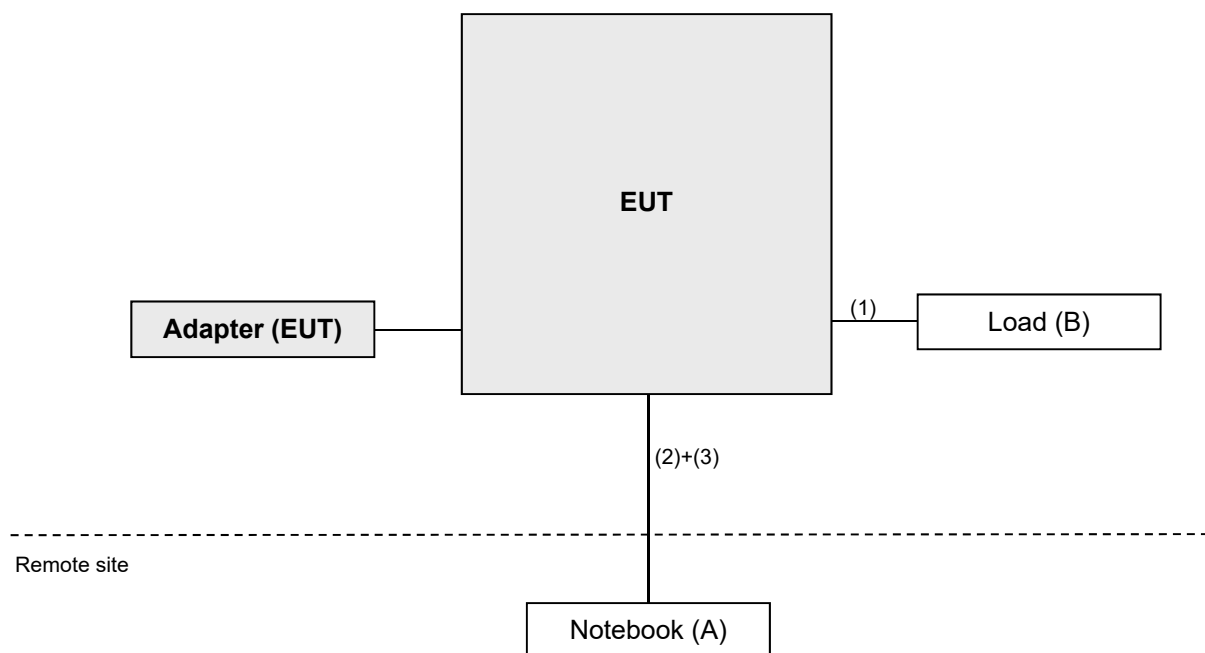

3.5 General Description of Applied Standards and References

The EUT is a RF Product. According to the specifications of the manufacturer, it must comply with the requirements of the following standards and references:

Test standard:

FCC Part 15, Subpart E (15.407)

ANSI C63.10:2013

All test items have been performed and recorded as per the above standards.

KDB References Test Guidance:

KDB 789033 D02 General UNII Test Procedure New Rules v02r01

KDB 662911 D01 Multiple Transmitter Output v02r01

All test items have been performed as a reference to the above KDB test guidance.

4 Test Types and Results

4.1 Radiated Emission and Bandedge Measurement

4.1.1 Limits of Radiated Emission and Bandedge Measurement

Radiated emissions which fall in the restricted bands must comply with the radiated emission limits specified as below table.

Frequencies (MHz)	Field Strength (microvolts/meter)	Measurement Distance (meters)
0.009 ~ 0.490	2400/F(kHz)	300
0.490 ~ 1.705	24000/F(kHz)	30
1.705 ~ 30.0	30	30
30 ~ 88	100	3
88 ~ 216	150	3
216 ~ 960	200	3
Above 960	500	3

Note:

1. The lower limit shall apply at the transition frequencies.
2. Emission level (dBuV/m) = 20 log Emission level (uV/m).
3. For frequencies above 1000MHz, the field strength limits are based on average detector, however, the peak field strength of any emission shall not exceed the maximum permitted average limits, specified above by more than 20dB under any condition of modulation.

Limits of unwanted emission out of the restricted bands

Applicable To		Limit	
789033 D02 General UNII Test Procedure New Rules v02r01		Field Strength at 3m	
		PK: 74 (dBµV/m)	AV: 54 (dBµV/m)
Frequency Band	Applicable To	EIRP Limit	Equivalent Field Strength at 3m
5150~5250 MHz	15.407(b)(1)	PK: -27 (dBm/MHz)	PK: 68.2(dBµV/m)
5250~5350 MHz	15.407(b)(2)		
5470~5725 MHz	15.407(b)(3)		
5725~5850 MHz	<input checked="" type="checkbox"/> 15.407(b)(4)(i)	PK: -27 (dBm/MHz) ^{*1} PK: 10 (dBm/MHz) ^{*2} PK: 15.6 (dBm/MHz) ^{*3} PK: 27 (dBm/MHz) ^{*4}	PK: 68.2(dBµV/m) ^{*1} PK: 105.2 (dBµV/m) ^{*2} PK: 110.8(dBµV/m) ^{*3} PK: 122.2 (dBµV/m) ^{*4}
^{*1} beyond 75 MHz or more above of the band edge.		^{*2} below the band edge increasing linearly to 10 dBm/MHz at 25 MHz above.	
^{*3} below the band edge increasing linearly to a level of 15.6 dBm/MHz at 5 MHz above.		^{*4} from 5 MHz above or below the band edge increasing linearly to a level of 27 dBm/MHz at the band edge.	

Note: The following formula is used to convert the equipment isotropic radiated power (eirp) to field strength:

$$E = \frac{1000000\sqrt{30P}}{3} \mu\text{V/m, where P is the eirp (Watts).}$$

4.1.2 Test Instruments

Description & Manufacturer	Model No.	Serial No.	Cal. Date	Cal. Due
Test Receiver KEYSIGHT	N9038A	MY55420137	Apr. 09, 2021	Apr. 08, 2022
Spectrum Analyzer ROHDE & SCHWARZ	FSP40	100039	Jun. 12, 2020	Jun. 11, 2021
			Jun. 10, 2021	Jun. 09, 2022
BILOG Antenna SCHWARZBECK	VULB9168	9168-160	Nov. 06, 2020	Nov. 05, 2021
HORN Antenna SCHWARZBECK	BBHA 9120 D	9120D-1169	Nov. 22, 2020	Nov. 21, 2021
HORN Antenna SCHWARZBECK	BBHA 9170	BBHA9170241	Nov. 22, 2020	Nov. 21, 2021
Loop Antenna TESEQ	HLA 6121	45745	Jul. 06, 2020	Jul. 05, 2021
Preamplifier Agilent (Below 1GHz)	8447D	2944A10638	Jun. 08, 2020	Jun. 07, 2021
			Jun. 05, 2021	Jun. 04, 2022
Preamplifier Agilent (Above 1GHz)	8449B	3008A02367	Feb. 17, 2021	Feb. 16, 2022
RF signal cable HUBER+SUHNER&EMCI	SUCOFLEX 104 & EMC104-SM- SM8000	CABLE-CH9-02 (248780+171006)	Jan. 16, 2021	Jan. 15, 2022
RF signal cable HUBER+SUHNER	SUCOFLEX 104	CABLE-CH9-(250795 /4)	Jan. 16, 2021	Jan. 15, 2022
RF signal cable Woken	8D-FB	Cable-CH9-01	Jun. 08, 2020	Jun. 07, 2021
			Jun. 05, 2021	Jun. 04, 2022
Software BV ADT	ADT_Radiated_ V7.6.15.9.5	NA	NA	NA
Antenna Tower & Turn BV ADT	AT100	AT93021705	NA	NA
Turn Table BV ADT	TT100	TT93021705	NA	NA
Turn Table Controller BV ADT	SC100	SC93021705	NA	NA
Boresight Antenna Fixture	FBA-01	FBA-SIP01	NA	NA
Pre-amplifier (18GHz-40GHz) EMC	EMC184045B	980175	Sep. 04, 2020	Sep. 03, 2021
Spectrum Analyzer ROHDE & SCHWARZ	FSV40	100979	Mar. 29, 2021	Mar. 28, 2022
Peak Power Analyzer KEYSIGHT	8990B	MY51000485	Jan. 19, 2021	Jan. 18, 2022
Wideband Power Sensor KEYSIGHT	N1923A	MY58020002	Jan. 11, 2021	Jan. 10, 2022

- Note: 1. The calibration interval of the above test instruments is 12 months and the calibrations are traceable to NML/ROC and NIST/USA.
2. The test was performed in HwaYa Chamber 9.

4.1.3 Test Procedures

For Radiated emission below 30MHz

- a. The EUT was placed on the top of a rotating table 0.8 meters above the ground at a 3 meter chamber room. The table was rotated 360 degrees to determine the position of the highest radiation.
- b. The EUT was set 3 meters away from the interference-receiving antenna, which was mounted on the top of a variable-height antenna tower.
- c. Parallel, perpendicular, and ground-parallel orientations of the antenna are set to make the measurement.
- d. For each suspected emission, the EUT was arranged to its worst case and the rotatable table was turned from 0 degrees to 360 degrees to find the maximum reading.
- e. The test-receiver system was set to Quasi-Peak Detect Function and Specified Bandwidth with Maximum Hold Mode.

Note:

1. The resolution bandwidth and video bandwidth of test receiver/spectrum analyzer is 9kHz at frequency below 30MHz.

For Radiated emission above 30MHz

- a. The EUT was placed on the top of a rotating table 0.8 meters (for 30MHz ~ 1GHz) / 1.5 meters (for above 1GHz) above the ground at 3 meter chamber room for test. The table was rotated 360 degrees to determine the position of the highest radiation.
- b. The EUT was set 3 meters away from the interference-receiving antenna, which was mounted on the top of a variable-height antenna tower.
- c. The height of antenna is varied from one meter to four meters above the ground to determine the maximum value of the field strength. Both horizontal and vertical polarizations of the antenna are set to make the measurement.
- d. For each suspected emission, the EUT was arranged to its worst case and then the antenna was tuned to heights from 1 meter to 4 meters and the rotatable table was turned from 0 degrees to 360 degrees to find the maximum reading.
- e. The test-receiver system was set to quasi-peak detect function and specified bandwidth with maximum hold mode when the test frequency is below 1 GHz.
- f. The test-receiver system was set to peak and average detect function and specified bandwidth with maximum hold mode when the test frequency is above 1 GHz. If the peak reading value also meets average limit, measurement with the average detector is unnecessary.

Note:

1. The resolution bandwidth and video bandwidth of test receiver/spectrum analyzer is 120kHz for Quasi-peak detection (QP) at frequency below 1GHz.
2. The resolution bandwidth of test receiver/spectrum analyzer is 1 MHz and the video bandwidth is 3 MHz for Peak detection (PK) at frequency above 1GHz.
3. The resolution bandwidth of test receiver/spectrum analyzer is 1MHz and the video bandwidth is $\geq 1/T$ (Duty cycle < 98%) or 10Hz (Duty cycle $\geq 98\%$) for Average detection (AV) at frequency above 1GHz. (802.11a: RBW = 1MHz, VBW = 1kHz; 802.11ax (HE20): RBW = 1MHz, VBW = 1kHz; 802.11ax (HE40): RBW = 1MHz, VBW = 3kHz; 802.11ax (HE80): RBW = 1MHz, VBW = 10kHz)
4. All modes of operation were investigated and the worst-case emissions are reported.

4.1.4 Deviation from Test Standard

No deviation.

4.1.5 Test Setup

For Radiated emission below 30MHz

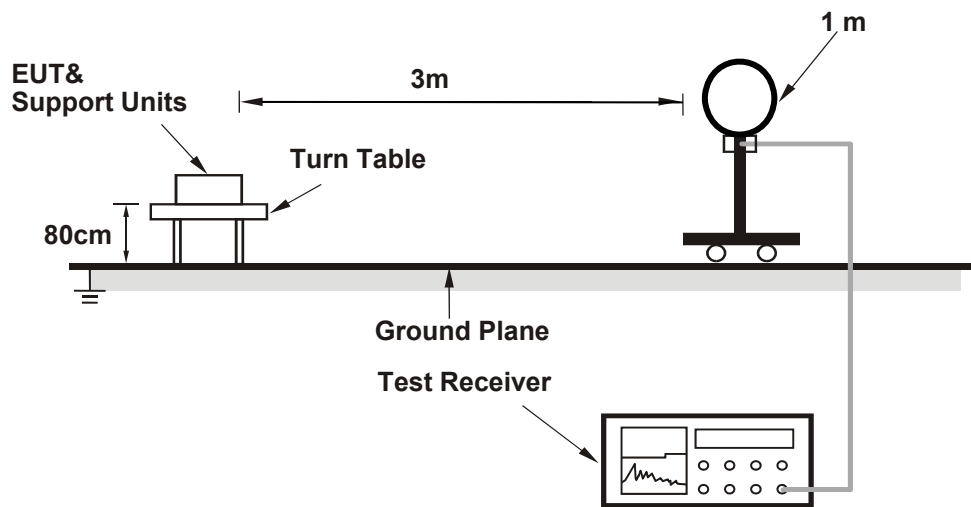

For Radiated emission 30MHz to 1GHz

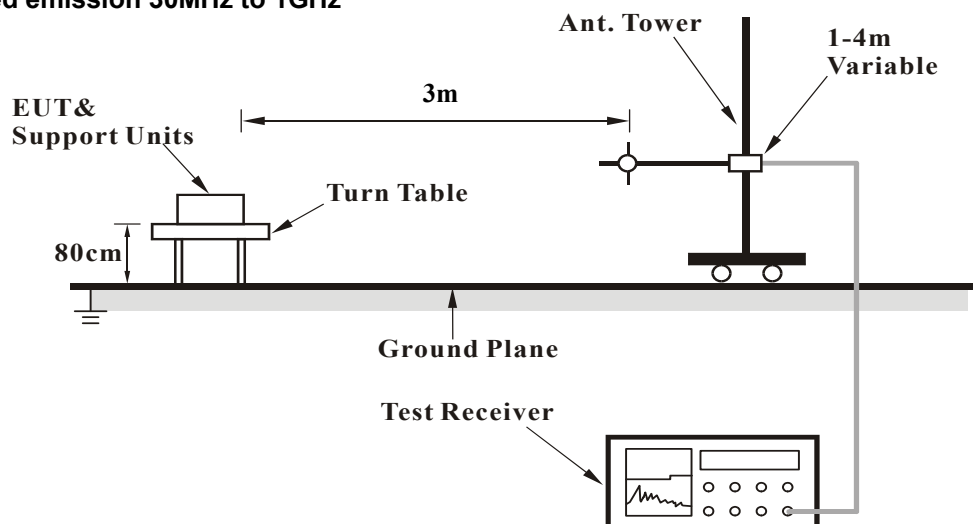

For Radiated emission above 1GHz

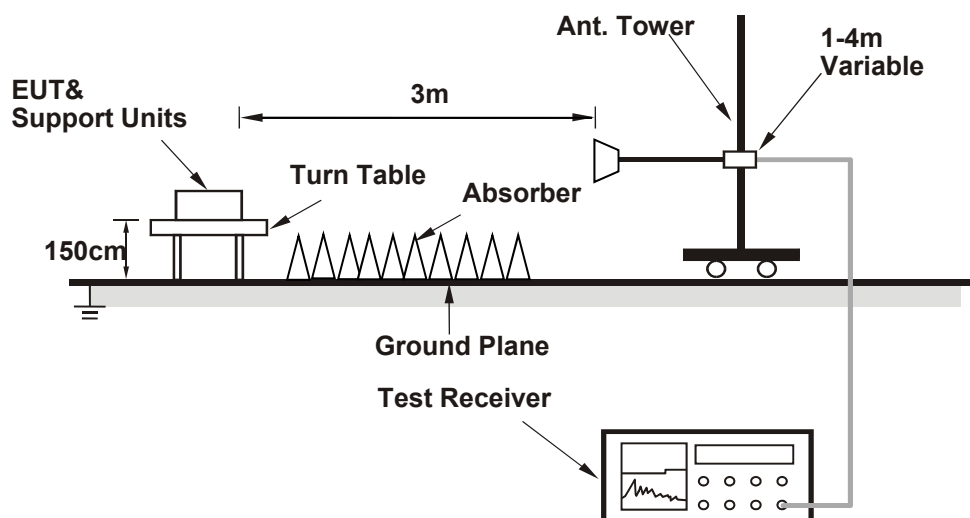

For the actual test configuration, please refer to the attached file (Test Setup Photo).

4.1.6 EUT Operating Conditions

- a. Connected EUT with a notebook system via a RJ45 cable and placed on a testing table.
- b. The notebook ran a test program (provided by manufacturer) to enable EUT under transmission condition continuously at specific channel frequency.

4.1.7 Test Results

Above 1GHz data:

RF Mode	TX 802.11a	Channel	CH 52 : 5260 MHz
Frequency Range	1GHz ~ 40GHz	Detector Function	Peak (PK) Average (AV)

Antenna Polarity & Test Distance : Horizontal at 3 m								
No	Frequency (MHz)	Emission Level (dBuV/m)	Limit (dBuV/m)	Margin (dB)	Antenna Height (m)	Table Angle (Degree)	Raw Value (dBuV)	Correction Factor (dB/m)
1	*5260.00	108.7 PK			1.46 H	55	72.5	36.2
2	*5260.00	99.6 AV			1.46 H	55	63.4	36.2
3	5350.00	51.7 PK	74.0	-22.3	1.46 H	55	49.7	2.0
4	5350.00	38.9 AV	54.0	-15.1	1.46 H	55	36.9	2.0
5	#10520.00	62.8 PK	68.2	-5.4	1.68 H	307	47.8	15.0
6	15780.00	61.3 PK	74.0	-12.7	2.19 H	292	44.1	17.2
7	15780.00	47.0 AV	54.0	-7.0	2.19 H	292	29.8	17.2

Antenna Polarity & Test Distance : Vertical at 3 m								
No	Frequency (MHz)	Emission Level (dBuV/m)	Limit (dBuV/m)	Margin (dB)	Antenna Height (m)	Table Angle (Degree)	Raw Value (dBuV)	Correction Factor (dB/m)
1	5150.00	53.0 PK	74.0	-21.0	3.37 V	350	50.9	2.1
2	5150.00	39.6 AV	54.0	-14.4	3.37 V	350	37.5	2.1
3	*5260.00	115.3 PK			3.37 V	350	79.1	36.2
4	*5260.00	105.5 AV			3.37 V	350	69.3	36.2
5	#10520.00	67.6 PK	68.2	-0.6	1.43 V	45	52.6	15.0
6	15780.00	61.2 PK	74.0	-12.8	3.56 V	335	44.0	17.2
7	15780.00	47.8 AV	54.0	-6.2	3.56 V	335	30.6	17.2

Remarks:

1. Emission Level(dBuV/m) = Raw Value(dBuV) + Correction Factor(dB/m)
2. Correction Factor(dB/m) = Antenna Factor(dB/m) + Cable Factor(dB) – Pre-Amplifier Factor(dB)
3. Margin value = Emission Level – Limit value
4. The other emission levels were very low against the limit.
5. " * ": Fundamental frequency.
6. " # ": The radiated frequency is out of the restricted band.

RF Mode	TX 802.11a	Channel	CH 60 : 5300 MHz
Frequency Range	1GHz ~ 40GHz	Detector Function	Peak (PK) Average (AV)

Antenna Polarity & Test Distance : Horizontal at 3 m

No	Frequency (MHz)	Emission Level (dBuV/m)	Limit (dBuV/m)	Margin (dB)	Antenna Height (m)	Table Angle (Degree)	Raw Value (dBuV)	Correction Factor (dB/m)
1	*5300.00	108.5 PK			1.49 H	57	72.5	36.0
2	*5300.00	99.3 AV			1.49 H	57	63.3	36.0
3	10600.00	63.3 PK	74.0	-10.7	1.80 H	304	47.7	15.6
4	10600.00	50.3 AV	54.0	-3.7	1.80 H	304	34.7	15.6
5	15900.00	61.1 PK	74.0	-12.9	2.18 H	290	43.5	17.6
6	15900.00	47.4 AV	54.0	-6.6	2.18 H	290	29.8	17.6

Antenna Polarity & Test Distance : Vertical at 3 m

No	Frequency (MHz)	Emission Level (dBuV/m)	Limit (dBuV/m)	Margin (dB)	Antenna Height (m)	Table Angle (Degree)	Raw Value (dBuV)	Correction Factor (dB/m)
1	*5300.00	113.7 PK			3.02 V	351	77.7	36.0
2	*5300.00	104.7 AV			3.02 V	351	68.7	36.0
3	10600.00	66.1 PK	74.0	-7.9	1.00 V	36	50.5	15.6
4	10600.00	53.2 AV	54.0	-0.8	1.00 V	36	37.6	15.6
5	15900.00	61.6 PK	74.0	-12.4	3.56 V	345	44.0	17.6
6	15900.00	48.5 AV	54.0	-5.5	3.56 V	345	30.9	17.6

Remarks:

1. Emission Level(dBuV/m) = Raw Value(dBuV) + Correction Factor(dB/m)
2. Correction Factor(dB/m) = Antenna Factor(dB/m) + Cable Factor(dB) – Pre-Amplifier Factor(dB)
3. Margin value = Emission Level – Limit value
4. The other emission levels were very low against the limit.
5. " * ": Fundamental frequency.

RF Mode	TX 802.11a	Channel	CH 64 : 5320 MHz
Frequency Range	1GHz ~ 40GHz	Detector Function	Peak (PK) Average (AV)

Antenna Polarity & Test Distance : Horizontal at 3 m

No	Frequency (MHz)	Emission Level (dBuV/m)	Limit (dBuV/m)	Margin (dB)	Antenna Height (m)	Table Angle (Degree)	Raw Value (dBuV)	Correction Factor (dB/m)
1	*5320.00	108.5 PK			1.52 H	58	72.3	36.2
2	*5320.00	100.0 AV			1.52 H	58	63.8	36.2
3	5350.00	56.2 PK	74.0	-17.8	1.52 H	58	54.2	2.0
4	5350.00	41.7 AV	54.0	-12.3	1.52 H	58	39.7	2.0
5	10640.00	63.6 PK	74.0	-10.4	1.75 H	305	48.0	15.6
6	10640.00	50.4 AV	54.0	-3.6	1.75 H	305	34.8	15.6
7	15960.00	61.4 PK	74.0	-12.6	2.44 H	323	44.1	17.3
8	15960.00	48.3 AV	54.0	-5.7	2.44 H	323	31.0	17.3

Antenna Polarity & Test Distance : Vertical at 3 m

No	Frequency (MHz)	Emission Level (dBuV/m)	Limit (dBuV/m)	Margin (dB)	Antenna Height (m)	Table Angle (Degree)	Raw Value (dBuV)	Correction Factor (dB/m)
1	*5320.00	113.7 PK			3.00 V	337	77.5	36.2
2	*5320.00	104.8 AV			3.00 V	337	68.6	36.2
3	5350.00	61.6 PK	74.0	-12.4	3.00 V	337	59.6	2.0
4	5350.00	42.7 AV	54.0	-11.3	3.00 V	337	40.7	2.0
5	10640.00	66.1 PK	74.0	-7.9	1.40 V	39	50.5	15.6
6	10640.00	53.4 AV	54.0	-0.6	1.40 V	39	37.8	15.6
7	15960.00	63.9 PK	74.0	-10.1	3.62 V	324	46.6	17.3
8	15960.00	49.8 AV	54.0	-4.2	3.62 V	324	32.5	17.3

Remarks:

1. Emission Level(dBuV/m) = Raw Value(dBuV) + Correction Factor(dB/m)
2. Correction Factor(dB/m) = Antenna Factor(dB/m) + Cable Factor(dB) – Pre-Amplifier Factor(dB)
3. Margin value = Emission Level – Limit value
4. The other emission levels were very low against the limit.
5. " * ": Fundamental frequency.

RF Mode	TX 802.11a	Channel	CH 100 : 5500 MHz
Frequency Range	1GHz ~ 40GHz	Detector Function	Peak (PK) Average (AV)

Antenna Polarity & Test Distance : Horizontal at 3 m								
No	Frequency (MHz)	Emission Level (dBuV/m)	Limit (dBuV/m)	Margin (dB)	Antenna Height (m)	Table Angle (Degree)	Raw Value (dBuV)	Correction Factor (dB/m)
1	5460.00	54.8 PK	74.0	-19.2	1.60 H	53	52.2	2.6
2	5460.00	40.0 AV	54.0	-14.0	1.60 H	53	37.4	2.6
3	#5470.00	62.4 PK	68.2	-5.8	1.60 H	53	59.8	2.6
4	*5500.00	108.5 PK			1.60 H	53	71.5	37.0
5	*5500.00	99.5 AV			1.60 H	53	62.5	37.0
6	11000.00	60.3 PK	74.0	-13.7	2.48 H	359	43.8	16.5
7	11000.00	47.8 AV	54.0	-6.2	2.48 H	359	31.3	16.5
8	#16500.00	66.7 PK	68.2	-1.5	2.77 H	121	48.8	17.9

Antenna Polarity & Test Distance : Vertical at 3 m								
No	Frequency (MHz)	Emission Level (dBuV/m)	Limit (dBuV/m)	Margin (dB)	Antenna Height (m)	Table Angle (Degree)	Raw Value (dBuV)	Correction Factor (dB/m)
1	5460.00	56.8 PK	74.0	-17.2	3.01 V	292	54.2	2.6
2	5460.00	41.9 AV	54.0	-12.1	3.01 V	292	39.3	2.6
3	#5470.00	61.9 PK	68.2	-6.3	3.01 V	292	59.3	2.6
4	*5500.00	114.7 PK			3.01 V	292	77.7	37.0
5	*5500.00	105.2 AV			3.01 V	292	68.2	37.0
6	11000.00	61.2 PK	74.0	-12.8	1.50 V	224	44.7	16.5
7	11000.00	49.1 AV	54.0	-4.9	1.50 V	224	32.6	16.5
8	#16500.00	65.6 PK	68.2	-2.6	3.25 V	241	47.7	17.9

Remarks:

1. Emission Level(dBuV/m) = Raw Value(dBuV) + Correction Factor(dB/m)
2. Correction Factor(dB/m) = Antenna Factor(dB/m) + Cable Factor(dB) – Pre-Amplifier Factor(dB)
3. Margin value = Emission Level – Limit value
4. The other emission levels were very low against the limit.
5. " * ": Fundamental frequency.
6. " # ": The radiated frequency is out of the restricted band.

RF Mode	TX 802.11a	Channel	CH 116 : 5580 MHz
Frequency Range	1GHz ~ 40GHz	Detector Function	Peak (PK) Average (AV)

Antenna Polarity & Test Distance : Horizontal at 3 m

No	Frequency (MHz)	Emission Level (dBuV/m)	Limit (dBuV/m)	Margin (dB)	Antenna Height (m)	Table Angle (Degree)	Raw Value (dBuV)	Correction Factor (dB/m)
1	*5580.00	109.3 PK			1.55 H	57	72.3	37.0
2	*5580.00	100.0 AV			1.55 H	57	63.0	37.0
3	11160.00	61.7 PK	74.0	-12.3	3.03 H	279	45.9	15.8
4	11160.00	49.6 AV	54.0	-4.4	3.03 H	279	33.8	15.8
5	#16740.00	67.5 PK	68.2	-0.7	2.71 H	125	46.8	20.7

Antenna Polarity & Test Distance : Vertical at 3 m

No	Frequency (MHz)	Emission Level (dBuV/m)	Limit (dBuV/m)	Margin (dB)	Antenna Height (m)	Table Angle (Degree)	Raw Value (dBuV)	Correction Factor (dB/m)
1	*5580.00	114.6 PK			3.05 V	299	77.6	37.0
2	*5580.00	105.2 AV			3.05 V	299	68.2	37.0
3	11160.00	62.3 PK	74.0	-11.7	1.52 V	226	46.5	15.8
4	11160.00	50.4 AV	54.0	-3.6	1.52 V	226	34.6	15.8
5	#16740.00	66.4 PK	68.2	-1.8	3.25 V	236	45.7	20.7

Remarks:

1. Emission Level(dBuV/m) = Raw Value(dBuV) + Correction Factor(dB/m)
2. Correction Factor(dB/m) = Antenna Factor(dB/m) + Cable Factor(dB) – Pre-Amplifier Factor(dB)
3. Margin value = Emission Level – Limit value
4. The other emission levels were very low against the limit.
5. " * " : Fundamental frequency.
6. " # " : The radiated frequency is out of the restricted band.

RF Mode	TX 802.11a	Channel	CH 140 : 5700 MHz
Frequency Range	1GHz ~ 40GHz	Detector Function	Peak (PK) Average (AV)

Antenna Polarity & Test Distance : Horizontal at 3 m								
No	Frequency (MHz)	Emission Level (dBuV/m)	Limit (dBuV/m)	Margin (dB)	Antenna Height (m)	Table Angle (Degree)	Raw Value (dBuV)	Correction Factor (dB/m)
1	*5700.00	108.7 PK			1.81 H	7	71.5	37.2
2	*5700.00	100.1 AV			1.81 H	7	62.9	37.2
3	#5725.00	54.8 PK	68.2	-13.4	1.81 H	7	51.8	3.0
4	11400.00	60.2 PK	74.0	-13.8	2.95 H	294	43.7	16.5
5	11400.00	47.8 AV	54.0	-6.2	2.95 H	294	31.3	16.5
6	#17100.00	67.1 PK	68.2	-1.1	2.17 H	123	45.5	21.6

Antenna Polarity & Test Distance : Vertical at 3 m								
No	Frequency (MHz)	Emission Level (dBuV/m)	Limit (dBuV/m)	Margin (dB)	Antenna Height (m)	Table Angle (Degree)	Raw Value (dBuV)	Correction Factor (dB/m)
1	*5700.00	114.3 PK			2.87 V	355	77.1	37.2
2	*5700.00	105.3 AV			2.87 V	355	68.1	37.2
3	#5725.00	60.8 PK	68.2	-7.4	2.87 V	355	57.8	3.0
4	11400.00	61.3 PK	74.0	-12.7	1.45 V	220	44.8	16.5
5	11400.00	49.3 AV	54.0	-4.7	1.45 V	220	32.8	16.5
6	#17100.00	66.2 PK	68.2	-2.0	3.28 V	234	44.6	21.6

Remarks:

1. Emission Level(dBuV/m) = Raw Value(dBuV) + Correction Factor(dB/m)
2. Correction Factor(dB/m) = Antenna Factor(dB/m) + Cable Factor(dB) – Pre-Amplifier Factor(dB)
3. Margin value = Emission Level – Limit value
4. The other emission levels were very low against the limit.
5. " * ": Fundamental frequency.
6. " # ": The radiated frequency is out of the restricted band.

RF Mode	TX 802.11a	Channel	CH 144 : 5720 MHz
Frequency Range	1GHz ~ 40GHz	Detector Function	Peak (PK) Average (AV)

Antenna Polarity & Test Distance : Horizontal at 3 m

No	Frequency (MHz)	Emission Level (dBuV/m)	Limit (dBuV/m)	Margin (dB)	Antenna Height (m)	Table Angle (Degree)	Raw Value (dBuV)	Correction Factor (dB/m)
1	*5720.00	109.4 PK			1.50 H	4	72.1	37.3
2	*5720.00	100.3 AV			1.50 H	4	63.0	37.3
3	#5850.00	52.9 PK	68.2	-15.3	1.50 H	4	49.4	3.5
4	11440.00	62.2 PK	74.0	-11.8	3.00 H	292	45.9	16.3
5	11440.00	49.5 AV	54.0	-4.5	3.00 H	292	33.2	16.3
6	#17160.00	67.6 PK	68.2	-0.6	2.34 H	120	45.7	21.9

Antenna Polarity & Test Distance : Vertical at 3 m

No	Frequency (MHz)	Emission Level (dBuV/m)	Limit (dBuV/m)	Margin (dB)	Antenna Height (m)	Table Angle (Degree)	Raw Value (dBuV)	Correction Factor (dB/m)
1	*5720.00	114.5 PK			3.06 V	340	77.2	37.3
2	*5720.00	105.5 AV			3.06 V	340	68.2	37.3
3	#5850.00	53.0 PK	68.2	-15.2	3.06 V	340	49.5	3.5
4	11440.00	63.2 PK	74.0	-10.8	1.48 V	223	46.9	16.3
5	11440.00	50.6 AV	54.0	-3.4	1.48 V	223	34.3	16.3
6	#17160.00	66.9 PK	68.2	-1.3	3.30 V	234	45.0	21.9

Remarks:

1. Emission Level(dBuV/m) = Raw Value(dBuV) + Correction Factor(dB/m)
2. Correction Factor(dB/m) = Antenna Factor(dB/m) + Cable Factor(dB) – Pre-Amplifier Factor(dB)
3. Margin value = Emission Level – Limit value
4. The other emission levels were very low against the limit.
5. " * ": Fundamental frequency.
6. " # ": The radiated frequency is out of the restricted band.

RF Mode	TX 802.11ax (HE20)	Channel	CH 52 : 5260 MHz
Frequency Range	1GHz ~ 40GHz	Detector Function	Peak (PK) Average (AV)

Antenna Polarity & Test Distance : Horizontal at 3 m								
No	Frequency (MHz)	Emission Level (dBuV/m)	Limit (dBuV/m)	Margin (dB)	Antenna Height (m)	Table Angle (Degree)	Raw Value (dBuV)	Correction Factor (dB/m)
1	5150.00	51.6 PK	74.0	-22.4	1.50 H	55	49.5	2.1
2	5150.00	39.1 AV	54.0	-14.9	1.50 H	55	37.0	2.1
3	*5260.00	112.1 PK			1.50 H	55	75.9	36.2
4	*5260.00	100.5 AV			1.50 H	55	64.3	36.2
5	#10520.00	59.7 PK	68.2	-8.5	1.80 H	348	44.7	15.0
6	15780.00	62.3 PK	74.0	-11.7	2.76 H	337	45.1	17.2
7	15780.00	49.0 AV	54.0	-5.0	2.76 H	337	31.8	17.2

Antenna Polarity & Test Distance : Vertical at 3 m								
No	Frequency (MHz)	Emission Level (dBuV/m)	Limit (dBuV/m)	Margin (dB)	Antenna Height (m)	Table Angle (Degree)	Raw Value (dBuV)	Correction Factor (dB/m)
1	5150.00	53.9 PK	74.0	-20.1	2.94 V	342	51.8	2.1
2	5150.00	40.6 AV	54.0	-13.4	2.94 V	342	38.5	2.1
3	*5260.00	116.0 PK			2.94 V	342	79.8	36.2
4	*5260.00	104.8 AV			2.94 V	342	68.6	36.2
5	#10520.00	57.6 PK	68.2	-10.6	1.08 V	40	42.6	15.0
6	15780.00	60.1 PK	74.0	-13.9	3.04 V	343	42.9	17.2
7	15780.00	48.7 AV	54.0	-5.3	3.04 V	343	31.5	17.2

Remarks:

1. Emission Level(dBuV/m) = Raw Value(dBuV) + Correction Factor(dB/m)
2. Correction Factor(dB/m) = Antenna Factor(dB/m) + Cable Factor(dB) – Pre-Amplifier Factor(dB)
3. Margin value = Emission Level – Limit value
4. The other emission levels were very low against the limit.
5. " * ": Fundamental frequency.
6. " # ": The radiated frequency is out of the restricted band.

RF Mode	TX 802.11ax (HE20)	Channel	CH 60 : 5300 MHz
Frequency Range	1GHz ~ 40GHz	Detector Function	Peak (PK) Average (AV)

Antenna Polarity & Test Distance : Horizontal at 3 m

No	Frequency (MHz)	Emission Level (dBuV/m)	Limit (dBuV/m)	Margin (dB)	Antenna Height (m)	Table Angle (Degree)	Raw Value (dBuV)	Correction Factor (dB/m)
1	*5300.00	110.9 PK			1.55 H	52	74.9	36.0
2	*5300.00	100.4 AV			1.55 H	52	64.4	36.0
3	10600.00	60.8 PK	74.0	-13.2	2.00 H	322	45.2	15.6
4	10600.00	49.6 AV	54.0	-4.4	2.00 H	322	34.0	15.6
5	15900.00	61.8 PK	74.0	-12.2	2.47 H	323	44.2	17.6
6	15900.00	48.8 AV	54.0	-5.2	2.47 H	323	31.2	17.6

Antenna Polarity & Test Distance : Vertical at 3 m

No	Frequency (MHz)	Emission Level (dBuV/m)	Limit (dBuV/m)	Margin (dB)	Antenna Height (m)	Table Angle (Degree)	Raw Value (dBuV)	Correction Factor (dB/m)
1	*5300.00	117.5 PK			3.21 V	341	81.5	36.0
2	*5300.00	105.0 AV			3.21 V	341	69.0	36.0
3	10600.00	65.0 PK	74.0	-9.0	1.00 V	37	49.4	15.6
4	10600.00	52.9 AV	54.0	-1.1	1.00 V	37	37.3	15.6
5	15900.00	62.4 PK	74.0	-11.6	3.52 V	325	44.8	17.6
6	15900.00	48.5 AV	54.0	-5.5	3.52 V	325	30.9	17.6

Remarks:

1. Emission Level(dBuV/m) = Raw Value(dBuV) + Correction Factor(dB/m)
2. Correction Factor(dB/m) = Antenna Factor(dB/m) + Cable Factor(dB) – Pre-Amplifier Factor(dB)
3. Margin value = Emission Level – Limit value
4. The other emission levels were very low against the limit.
5. " * ": Fundamental frequency.

RF Mode	TX 802.11ax (HE20)	Channel	CH 64 : 5320 MHz
Frequency Range	1GHz ~ 40GHz	Detector Function	Peak (PK) Average (AV)

Antenna Polarity & Test Distance : Horizontal at 3 m

No	Frequency (MHz)	Emission Level (dBuV/m)	Limit (dBuV/m)	Margin (dB)	Antenna Height (m)	Table Angle (Degree)	Raw Value (dBuV)	Correction Factor (dB/m)
1	*5320.00	111.9 PK			1.71 H	51	75.7	36.2
2	*5320.00	100.0 AV			1.71 H	51	63.8	36.2
3	5350.00	60.8 PK	74.0	-13.2	1.71 H	51	58.8	2.0
4	5350.00	44.7 AV	54.0	-9.3	1.71 H	51	42.7	2.0
5	10640.00	62.2 PK	74.0	-11.8	2.21 H	324	46.6	15.6
6	10640.00	49.6 AV	54.0	-4.4	2.21 H	324	34.0	15.6
7	15960.00	64.2 PK	74.0	-9.8	2.41 H	327	46.9	17.3
8	15960.00	49.6 AV	54.0	-4.4	2.41 H	327	32.3	17.3

Antenna Polarity & Test Distance : Vertical at 3 m

No	Frequency (MHz)	Emission Level (dBuV/m)	Limit (dBuV/m)	Margin (dB)	Antenna Height (m)	Table Angle (Degree)	Raw Value (dBuV)	Correction Factor (dB/m)
1	*5320.00	116.5 PK			3.67 V	300	80.3	36.2
2	*5320.00	103.7 AV			3.67 V	300	67.5	36.2
3	5350.00	69.5 PK	74.0	-4.5	3.67 V	300	67.5	2.0
4	5350.00	49.1 AV	54.0	-4.9	3.67 V	300	47.1	2.0
5	10640.00	64.2 PK	74.0	-9.8	1.09 V	37	48.6	15.6
6	10640.00	52.2 AV	54.0	-1.8	1.09 V	37	36.6	15.6
7	15960.00	63.6 PK	74.0	-10.4	3.48 V	324	46.3	17.3
8	15960.00	50.3 AV	54.0	-3.7	3.48 V	324	33.0	17.3

Remarks:

1. Emission Level(dBuV/m) = Raw Value(dBuV) + Correction Factor(dB/m)
2. Correction Factor(dB/m) = Antenna Factor(dB/m) + Cable Factor(dB) – Pre-Amplifier Factor(dB)
3. Margin value = Emission Level – Limit value
4. The other emission levels were very low against the limit.
5. " * ": Fundamental frequency.

RF Mode	TX 802.11ax (HE20)	Channel	CH 100 : 5500 MHz
Frequency Range	1GHz ~ 40GHz	Detector Function	Peak (PK) Average (AV)

Antenna Polarity & Test Distance : Horizontal at 3 m								
No	Frequency (MHz)	Emission Level (dBuV/m)	Limit (dBuV/m)	Margin (dB)	Antenna Height (m)	Table Angle (Degree)	Raw Value (dBuV)	Correction Factor (dB/m)
1	5460.00	52.6 PK	74.0	-21.4	1.87 H	73	50.0	2.6
2	5460.00	40.1 AV	54.0	-13.9	1.87 H	73	37.5	2.6
3	#5470.00	55.3 PK	68.2	-12.9	1.87 H	73	52.7	2.6
4	*5500.00	109.7 PK			1.87 H	73	72.7	37.0
5	*5500.00	98.7 AV			1.87 H	73	61.7	37.0
6	11000.00	61.5 PK	74.0	-12.5	3.43 H	326	45.0	16.5
7	11000.00	49.5 AV	54.0	-4.5	3.43 H	326	33.0	16.5
8	#16500.00	67.3 PK	68.2	-0.9	3.04 H	130	49.4	17.9

Antenna Polarity & Test Distance : Vertical at 3 m								
No	Frequency (MHz)	Emission Level (dBuV/m)	Limit (dBuV/m)	Margin (dB)	Antenna Height (m)	Table Angle (Degree)	Raw Value (dBuV)	Correction Factor (dB/m)
1	5460.00	55.0 PK	74.0	-19.0	2.63 V	306	52.4	2.6
2	5460.00	42.2 AV	54.0	-11.8	2.63 V	306	39.6	2.6
3	#5470.00	62.3 PK	68.2	-5.9	2.63 V	306	59.7	2.6
4	*5500.00	115.5 PK			2.63 V	306	78.5	37.0
5	*5500.00	103.6 AV			2.63 V	306	66.6	37.0
6	11000.00	63.2 PK	74.0	-10.8	2.91 V	144	46.7	16.5
7	11000.00	51.7 AV	54.0	-2.3	2.91 V	144	35.2	16.5
8	#16500.00	66.3 PK	68.2	-1.9	3.00 V	189	48.4	17.9

Remarks:

1. Emission Level(dBuV/m) = Raw Value(dBuV) + Correction Factor(dB/m)
2. Correction Factor(dB/m) = Antenna Factor(dB/m) + Cable Factor(dB) – Pre-Amplifier Factor(dB)
3. Margin value = Emission Level – Limit value
4. The other emission levels were very low against the limit.
5. " * ": Fundamental frequency.
6. " # ": The radiated frequency is out of the restricted band.

RF Mode	TX 802.11ax (HE20)	Channel	CH 116 : 5580 MHz
Frequency Range	1GHz ~ 40GHz	Detector Function	Peak (PK) Average (AV)

Antenna Polarity & Test Distance : Horizontal at 3 m

No	Frequency (MHz)	Emission Level (dBuV/m)	Limit (dBuV/m)	Margin (dB)	Antenna Height (m)	Table Angle (Degree)	Raw Value (dBuV)	Correction Factor (dB/m)
1	*5580.00	109.7 PK			1.84 H	71	72.7	37.0
2	*5580.00	99.0 AV			1.84 H	71	62.0	37.0
3	11160.00	60.4 PK	74.0	-13.6	2.70 H	272	44.6	15.8
4	11160.00	48.4 AV	54.0	-5.6	2.70 H	272	32.6	15.8
5	#16740.00	67.2 PK	68.2	-1.0	2.48 H	122	46.5	20.7

Antenna Polarity & Test Distance : Vertical at 3 m

No	Frequency (MHz)	Emission Level (dBuV/m)	Limit (dBuV/m)	Margin (dB)	Antenna Height (m)	Table Angle (Degree)	Raw Value (dBuV)	Correction Factor (dB/m)
1	*5580.00	115.4 PK			2.98 V	304	78.4	37.0
2	*5580.00	103.7 AV			2.98 V	304	66.7	37.0
3	11160.00	61.6 PK	74.0	-12.4	2.96 V	157	45.8	15.8
4	11160.00	50.6 AV	54.0	-3.4	2.96 V	157	34.8	15.8
5	#16740.00	66.4 PK	68.2	-1.8	3.47 V	177	45.7	20.7

Remarks:

1. Emission Level(dBuV/m) = Raw Value(dBuV) + Correction Factor(dB/m)
2. Correction Factor(dB/m) = Antenna Factor(dB/m) + Cable Factor(dB) – Pre-Amplifier Factor(dB)
3. Margin value = Emission Level – Limit value
4. The other emission levels were very low against the limit.
5. " * " : Fundamental frequency.
6. " # " : The radiated frequency is out of the restricted band.

RF Mode	TX 802.11ax (HE20)	Channel	CH 140 : 5700 MHz
Frequency Range	1GHz ~ 40GHz	Detector Function	Peak (PK) Average (AV)

Antenna Polarity & Test Distance : Horizontal at 3 m								
No	Frequency (MHz)	Emission Level (dBuV/m)	Limit (dBuV/m)	Margin (dB)	Antenna Height (m)	Table Angle (Degree)	Raw Value (dBuV)	Correction Factor (dB/m)
1	*5700.00	112.2 PK			1.69 H	62	75.0	37.2
2	*5700.00	100.1 AV			1.69 H	62	62.9	37.2
3	#5725.00	62.9 PK	68.2	-5.3	1.69 H	62	59.9	3.0
4	11400.00	59.5 PK	74.0	-14.5	3.46 H	284	43.0	16.5
5	11400.00	48.7 AV	54.0	-5.3	3.46 H	284	32.2	16.5
6	#17100.00	67.0 PK	68.2	-1.2	3.45 H	142	45.4	21.6

Antenna Polarity & Test Distance : Vertical at 3 m								
No	Frequency (MHz)	Emission Level (dBuV/m)	Limit (dBuV/m)	Margin (dB)	Antenna Height (m)	Table Angle (Degree)	Raw Value (dBuV)	Correction Factor (dB/m)
1	*5700.00	114.8 PK			2.67 V	335	77.6	37.2
2	*5700.00	103.6 AV			2.67 V	335	66.4	37.2
3	#5725.00	64.0 PK	68.2	-4.2	2.67 V	335	61.0	3.0
4	11400.00	61.7 PK	74.0	-12.3	2.95 V	169	45.2	16.5
5	11400.00	50.6 AV	54.0	-3.4	2.95 V	169	34.1	16.5
6	#17100.00	66.4 PK	68.2	-1.8	3.04 V	188	44.8	21.6

Remarks:

1. Emission Level(dBuV/m) = Raw Value(dBuV) + Correction Factor(dB/m)
2. Correction Factor(dB/m) = Antenna Factor(dB/m) + Cable Factor(dB) – Pre-Amplifier Factor(dB)
3. Margin value = Emission Level – Limit value
4. The other emission levels were very low against the limit.
5. " * ": Fundamental frequency.
6. " # ": The radiated frequency is out of the restricted band.

RF Mode	TX 802.11ax (HE20)	Channel	CH 144 : 5720 MHz
Frequency Range	1GHz ~ 40GHz	Detector Function	Peak (PK) Average (AV)

Antenna Polarity & Test Distance : Horizontal at 3 m

No	Frequency (MHz)	Emission Level (dBuV/m)	Limit (dBuV/m)	Margin (dB)	Antenna Height (m)	Table Angle (Degree)	Raw Value (dBuV)	Correction Factor (dB/m)
1	*5720.00	111.7 PK			1.71 H	75	74.4	37.3
2	*5720.00	100.2 AV			1.71 H	75	62.9	37.3
3	#5850.00	53.2 PK	68.2	-15.0	1.71 H	75	49.7	3.5
4	11440.00	59.6 PK	74.0	-14.4	3.12 H	293	43.3	16.3
5	11440.00	47.1 AV	54.0	-6.9	3.12 H	293	30.8	16.3
6	#17160.00	67.5 PK	68.2	-0.7	3.65 H	111	45.6	21.9

Antenna Polarity & Test Distance : Vertical at 3 m

No	Frequency (MHz)	Emission Level (dBuV/m)	Limit (dBuV/m)	Margin (dB)	Antenna Height (m)	Table Angle (Degree)	Raw Value (dBuV)	Correction Factor (dB/m)
1	*5720.00	115.7 PK			3.00 V	334	78.4	37.3
2	*5720.00	104.9 AV			3.00 V	334	67.6	37.3
3	#5850.00	52.9 PK	68.2	-15.3	3.00 V	334	49.4	3.5
4	11440.00	60.1 PK	74.0	-13.9	2.18 V	159	43.8	16.3
5	11440.00	48.6 AV	54.0	-5.4	2.18 V	159	32.3	16.3
6	#17160.00	66.5 PK	68.2	-1.7	3.76 V	170	44.6	21.9

Remarks:

1. Emission Level(dBuV/m) = Raw Value(dBuV) + Correction Factor(dB/m)
2. Correction Factor(dB/m) = Antenna Factor(dB/m) + Cable Factor(dB) – Pre-Amplifier Factor(dB)
3. Margin value = Emission Level – Limit value
4. The other emission levels were very low against the limit.
5. " * " : Fundamental frequency.
6. " # " : The radiated frequency is out of the restricted band.

RF Mode	TX 802.11ax (HE40)	Channel	CH 54 : 5270 MHz
Frequency Range	1GHz ~ 40GHz	Detector Function	Peak (PK) Average (AV)

Antenna Polarity & Test Distance : Horizontal at 3 m

No	Frequency (MHz)	Emission Level (dBuV/m)	Limit (dBuV/m)	Margin (dB)	Antenna Height (m)	Table Angle (Degree)	Raw Value (dBuV)	Correction Factor (dB/m)
1	5150.00	52.9 PK	74.0	-21.1	1.53 H	54	50.8	2.1
2	5150.00	40.2 AV	54.0	-13.8	1.53 H	54	38.1	2.1
3	*5270.00	109.8 PK			1.53 H	54	73.6	36.2
4	*5270.00	98.9 AV			1.53 H	54	62.7	36.2
5	#10540.00	58.5 PK	68.2	-9.7	2.23 H	327	43.3	15.2
6	15810.00	59.0 PK	74.0	-15.0	2.42 H	343	41.7	17.3
7	15810.00	47.8 AV	54.0	-6.2	2.42 H	343	30.5	17.3

Antenna Polarity & Test Distance : Vertical at 3 m

No	Frequency (MHz)	Emission Level (dBuV/m)	Limit (dBuV/m)	Margin (dB)	Antenna Height (m)	Table Angle (Degree)	Raw Value (dBuV)	Correction Factor (dB/m)
1	5150.00	53.1 PK	74.0	-20.9	3.54 V	353	51.0	2.1
2	5150.00	40.4 AV	54.0	-13.6	3.54 V	353	38.3	2.1
3	*5270.00	113.7 PK			3.54 V	353	77.5	36.2
4	*5270.00	103.0 AV			3.54 V	353	66.8	36.2
5	#10540.00	64.2 PK	68.2	-4.0	1.00 V	42	49.0	15.2
6	15810.00	59.7 PK	74.0	-14.3	3.53 V	345	42.4	17.3
7	15810.00	48.3 AV	54.0	-5.7	3.53 V	345	31.0	17.3

Remarks:

1. Emission Level(dBuV/m) = Raw Value(dBuV) + Correction Factor(dB/m)
2. Correction Factor(dB/m) = Antenna Factor(dB/m) + Cable Factor(dB) – Pre-Amplifier Factor(dB)
3. Margin value = Emission Level – Limit value
4. The other emission levels were very low against the limit.
5. " * ": Fundamental frequency.
6. " # ": The radiated frequency is out of the restricted band.

RF Mode	TX 802.11ax (HE40)	Channel	CH 62 : 5310 MHz
Frequency Range	1GHz ~ 40GHz	Detector Function	Peak (PK) Average (AV)

Antenna Polarity & Test Distance : Horizontal at 3 m								
No	Frequency (MHz)	Emission Level (dBuV/m)	Limit (dBuV/m)	Margin (dB)	Antenna Height (m)	Table Angle (Degree)	Raw Value (dBuV)	Correction Factor (dB/m)
1	*5310.00	109.0 PK			1.46 H	51	72.9	36.1
2	*5310.00	98.4 AV			1.46 H	51	62.3	36.1
3	5350.00	64.8 PK	74.0	-9.2	1.46 H	51	62.8	2.0
4	5350.00	48.3 AV	54.0	-5.7	1.46 H	51	46.3	2.0
5	10620.00	61.3 PK	74.0	-12.7	2.36 H	320	45.7	15.6
6	10620.00	49.8 AV	54.0	-4.2	2.36 H	320	34.2	15.6
7	15930.00	62.3 PK	74.0	-11.7	2.64 H	339	44.8	17.5
8	15930.00	49.6 AV	54.0	-4.4	2.64 H	339	32.1	17.5

Antenna Polarity & Test Distance : Vertical at 3 m								
No	Frequency (MHz)	Emission Level (dBuV/m)	Limit (dBuV/m)	Margin (dB)	Antenna Height (m)	Table Angle (Degree)	Raw Value (dBuV)	Correction Factor (dB/m)
1	*5310.00	112.8 PK			3.52 V	290	76.7	36.1
2	*5310.00	102.2 AV			3.52 V	290	66.1	36.1
3	5350.00	72.9 PK	74.0	-1.1	3.52 V	290	70.9	2.0
4	5350.00	50.0 AV	54.0	-4.0	3.52 V	290	48.0	2.0
5	10620.00	63.8 PK	74.0	-10.2	1.00 V	43	48.2	15.6
6	10620.00	52.6 AV	54.0	-1.4	1.00 V	43	37.0	15.6
7	15930.00	60.1 PK	74.0	-13.9	3.66 V	329	42.6	17.5
8	15930.00	49.0 AV	54.0	-5.0	3.66 V	329	31.5	17.5

Remarks:

1. Emission Level(dBuV/m) = Raw Value(dBuV) + Correction Factor(dB/m)
2. Correction Factor(dB/m) = Antenna Factor(dB/m) + Cable Factor(dB) – Pre-Amplifier Factor(dB)
3. Margin value = Emission Level – Limit value
4. The other emission levels were very low against the limit.
5. " * ": Fundamental frequency.

RF Mode	TX 802.11ax (HE40)	Channel	CH 102 : 5510 MHz
Frequency Range	1GHz ~ 40GHz	Detector Function	Peak (PK) Average (AV)

Antenna Polarity & Test Distance : Horizontal at 3 m

No	Frequency (MHz)	Emission Level (dBuV/m)	Limit (dBuV/m)	Margin (dB)	Antenna Height (m)	Table Angle (Degree)	Raw Value (dBuV)	Correction Factor (dB/m)
1	5460.00	58.7 PK	74.0	-15.3	1.83 H	76	56.1	2.6
2	5460.00	40.5 AV	54.0	-13.5	1.83 H	76	37.9	2.6
3	#5470.00	59.4 PK	68.2	-8.8	1.83 H	76	56.8	2.6
4	*5510.00	109.4 PK			1.83 H	76	72.4	37.0
5	*5510.00	97.4 AV			1.83 H	76	60.4	37.0
6	11020.00	59.9 PK	74.0	-14.1	3.45 H	328	43.5	16.4
7	11020.00	47.4 AV	54.0	-6.6	3.45 H	328	31.0	16.4
8	#16530.00	63.7 PK	68.2	-4.5	3.05 H	128	45.2	18.5

Antenna Polarity & Test Distance : Vertical at 3 m

No	Frequency (MHz)	Emission Level (dBuV/m)	Limit (dBuV/m)	Margin (dB)	Antenna Height (m)	Table Angle (Degree)	Raw Value (dBuV)	Correction Factor (dB/m)
1	5460.00	64.7 PK	74.0	-9.3	2.77 V	346	62.1	2.6
2	5460.00	43.5 AV	54.0	-10.5	2.77 V	346	40.9	2.6
3	#5470.00	66.8 PK	68.2	-1.4	2.77 V	346	64.2	2.6
4	*5510.00	114.4 PK			2.77 V	346	77.4	37.0
5	*5510.00	103.2 AV			2.77 V	346	66.2	37.0
6	11020.00	61.4 PK	74.0	-12.6	1.40 V	51	45.0	16.4
7	11020.00	48.9 AV	54.0	-5.1	1.40 V	51	32.5	16.4
8	#16530.00	62.9 PK	68.2	-5.3	2.28 V	205	44.4	18.5

Remarks:

1. Emission Level(dBuV/m) = Raw Value(dBuV) + Correction Factor(dB/m)
2. Correction Factor(dB/m) = Antenna Factor(dB/m) + Cable Factor(dB) – Pre-Amplifier Factor(dB)
3. Margin value = Emission Level – Limit value
4. The other emission levels were very low against the limit.
5. " * ": Fundamental frequency.
6. " # ": The radiated frequency is out of the restricted band.

RF Mode	TX 802.11ax (HE40)	Channel	CH 110 : 5550 MHz
Frequency Range	1GHz ~ 40GHz	Detector Function	Peak (PK) Average (AV)

Antenna Polarity & Test Distance : Horizontal at 3 m

No	Frequency (MHz)	Emission Level (dBuV/m)	Limit (dBuV/m)	Margin (dB)	Antenna Height (m)	Table Angle (Degree)	Raw Value (dBuV)	Correction Factor (dB/m)
1	*5550.00	109.2 PK			1.57 H	77	72.2	37.0
2	*5550.00	97.5 AV			1.57 H	77	60.5	37.0
3	11100.00	57.2 PK	74.0	-16.8	3.45 H	326	41.5	15.7
4	11100.00	45.5 AV	54.0	-8.5	3.45 H	326	29.8	15.7
5	#16650.00	63.9 PK	68.2	-4.3	2.41 H	178	43.8	20.1

Antenna Polarity & Test Distance : Vertical at 3 m

No	Frequency (MHz)	Emission Level (dBuV/m)	Limit (dBuV/m)	Margin (dB)	Antenna Height (m)	Table Angle (Degree)	Raw Value (dBuV)	Correction Factor (dB/m)
1	*5550.00	114.1 PK			2.28 V	359	77.1	37.0
2	*5550.00	103.3 AV			2.28 V	359	66.3	37.0
3	11100.00	57.9 PK	74.0	-16.1	1.45 V	52	42.2	15.7
4	11100.00	47.0 AV	54.0	-7.0	1.45 V	52	31.3	15.7
5	#16650.00	62.7 PK	68.2	-5.5	2.36 V	188	42.6	20.1

Remarks:

1. Emission Level(dBuV/m) = Raw Value(dBuV) + Correction Factor(dB/m)
2. Correction Factor(dB/m) = Antenna Factor(dB/m) + Cable Factor(dB) – Pre-Amplifier Factor(dB)
3. Margin value = Emission Level – Limit value
4. The other emission levels were very low against the limit.
5. " * " : Fundamental frequency.
6. " # " : The radiated frequency is out of the restricted band.

RF Mode	TX 802.11ax (HE40)	Channel	CH 134 : 5670 MHz
Frequency Range	1GHz ~ 40GHz	Detector Function	Peak (PK) Average (AV)

Antenna Polarity & Test Distance : Horizontal at 3 m

No	Frequency (MHz)	Emission Level (dBuV/m)	Limit (dBuV/m)	Margin (dB)	Antenna Height (m)	Table Angle (Degree)	Raw Value (dBuV)	Correction Factor (dB/m)
1	*5670.00	108.8 PK			1.65 H	61	71.7	37.1
2	*5670.00	97.7 AV			1.65 H	61	60.6	37.1
3	#5725.00	61.6 PK	68.2	-6.6	1.65 H	61	58.6	3.0
4	11340.00	57.2 PK	74.0	-16.8	3.48 H	320	40.8	16.4
5	11340.00	44.8 AV	54.0	-9.2	3.48 H	320	28.4	16.4
6	#17010.00	62.8 PK	68.2	-5.4	3.04 H	122	40.5	22.3

Antenna Polarity & Test Distance : Vertical at 3 m

No	Frequency (MHz)	Emission Level (dBuV/m)	Limit (dBuV/m)	Margin (dB)	Antenna Height (m)	Table Angle (Degree)	Raw Value (dBuV)	Correction Factor (dB/m)
1	*5670.00	113.2 PK			2.20 V	358	76.1	37.1
2	*5670.00	102.1 AV			2.20 V	358	65.0	37.1
3	#5725.00	67.6 PK	68.2	-0.6	2.20 V	358	64.6	3.0
4	11340.00	57.6 PK	74.0	-16.4	1.97 V	152	41.2	16.4
5	11340.00	45.7 AV	54.0	-8.3	1.97 V	152	29.3	16.4
6	#17010.00	59.3 PK	68.2	-8.9	2.21 V	220	37.0	22.3

Remarks:

1. Emission Level(dBuV/m) = Raw Value(dBuV) + Correction Factor(dB/m)
2. Correction Factor(dB/m) = Antenna Factor(dB/m) + Cable Factor(dB) – Pre-Amplifier Factor(dB)
3. Margin value = Emission Level – Limit value
4. The other emission levels were very low against the limit.
5. " * " : Fundamental frequency.
6. " # " : The radiated frequency is out of the restricted band.

RF Mode	TX 802.11ax (HE40)	Channel	CH 142 : 5710 MHz
Frequency Range	1GHz ~ 40GHz	Detector Function	Peak (PK) Average (AV)

Antenna Polarity & Test Distance : Horizontal at 3 m

No	Frequency (MHz)	Emission Level (dBuV/m)	Limit (dBuV/m)	Margin (dB)	Antenna Height (m)	Table Angle (Degree)	Raw Value (dBuV)	Correction Factor (dB/m)
1	*5710.00	108.7 PK			1.55 H	73	71.5	37.2
2	*5710.00	98.3 AV			1.55 H	73	61.1	37.2
3	#5850.00	53.3 PK	68.2	-14.9	1.55 H	73	49.8	3.5
4	11420.00	54.7 PK	74.0	-19.3	3.44 H	325	38.3	16.4
5	11420.00	43.7 AV	54.0	-10.3	3.44 H	325	27.3	16.4
6	#17130.00	62.9 PK	68.2	-5.3	3.41 H	157	41.2	21.7

Antenna Polarity & Test Distance : Vertical at 3 m

No	Frequency (MHz)	Emission Level (dBuV/m)	Limit (dBuV/m)	Margin (dB)	Antenna Height (m)	Table Angle (Degree)	Raw Value (dBuV)	Correction Factor (dB/m)
1	*5710.00	114.5 PK			2.51 V	328	77.3	37.2
2	*5710.00	103.4 AV			2.51 V	328	66.2	37.2
3	#5850.00	54.1 PK	68.2	-14.1	2.51 V	328	50.6	3.5
4	11420.00	55.3 PK	74.0	-18.7	1.58 V	23	38.9	16.4
5	11420.00	44.0 AV	54.0	-10.0	1.58 V	23	27.6	16.4
6	#17130.00	62.4 PK	68.2	-5.8	2.41 V	191	40.7	21.7

Remarks:

1. Emission Level(dBuV/m) = Raw Value(dBuV) + Correction Factor(dB/m)
2. Correction Factor(dB/m) = Antenna Factor(dB/m) + Cable Factor(dB) – Pre-Amplifier Factor(dB)
3. Margin value = Emission Level – Limit value
4. The other emission levels were very low against the limit.
5. " * " : Fundamental frequency.
6. " # " : The radiated frequency is out of the restricted band.

RF Mode	TX 802.11ax (HE80)	Channel	CH 58 : 5290 MHz
Frequency Range	1GHz ~ 40GHz	Detector Function	Peak (PK) Average (AV)

Antenna Polarity & Test Distance : Horizontal at 3 m

No	Frequency (MHz)	Emission Level (dBuV/m)	Limit (dBuV/m)	Margin (dB)	Antenna Height (m)	Table Angle (Degree)	Raw Value (dBuV)	Correction Factor (dB/m)
1	*5290.00	103.9 PK			1.63 H	49	67.8	36.1
2	*5290.00	94.1 AV			1.63 H	49	58.0	36.1
3	5350.00	65.8 PK	74.0	-8.2	1.63 H	49	63.8	2.0
4	5350.00	46.0 AV	54.0	-8.0	1.63 H	49	44.0	2.0
5	#10580.00	58.2 PK	68.2	-10.0	2.21 H	306	42.8	15.4
6	15870.00	58.9 PK	74.0	-15.1	2.33 H	342	41.5	17.4
7	15870.00	47.4 AV	54.0	-6.6	2.33 H	342	30.0	17.4

Antenna Polarity & Test Distance : Vertical at 3 m

No	Frequency (MHz)	Emission Level (dBuV/m)	Limit (dBuV/m)	Margin (dB)	Antenna Height (m)	Table Angle (Degree)	Raw Value (dBuV)	Correction Factor (dB/m)
1	*5290.00	108.8 PK			3.55 V	351	72.7	36.1
2	*5290.00	99.6 AV			3.55 V	351	63.5	36.1
3	5350.00	71.0 PK	74.0	-3.0	3.55 V	351	69.0	2.0
4	5350.00	48.8 AV	54.0	-5.2	3.55 V	351	46.8	2.0
5	#10580.00	60.9 PK	68.2	-7.3	1.00 V	41	45.5	15.4
6	15870.00	60.2 PK	74.0	-13.8	3.08 V	322	42.8	17.4
7	15870.00	48.1 AV	54.0	-5.9	3.08 V	322	30.7	17.4

Remarks:

1. Emission Level(dBuV/m) = Raw Value(dBuV) + Correction Factor(dB/m)
2. Correction Factor(dB/m) = Antenna Factor(dB/m) + Cable Factor(dB) – Pre-Amplifier Factor(dB)
3. Margin value = Emission Level – Limit value
4. The other emission levels were very low against the limit.
5. " * ": Fundamental frequency.
6. " # ": The radiated frequency is out of the restricted band.

RF Mode	TX 802.11ax (HE80)	Channel	CH 106 : 5530 MHz
Frequency Range	1GHz ~ 40GHz	Detector Function	Peak (PK) Average (AV)

Antenna Polarity & Test Distance : Horizontal at 3 m

No	Frequency (MHz)	Emission Level (dBuV/m)	Limit (dBuV/m)	Margin (dB)	Antenna Height (m)	Table Angle (Degree)	Raw Value (dBuV)	Correction Factor (dB/m)
1	5460.00	60.4 PK	74.0	-13.6	1.69 H	72	57.8	2.6
2	5460.00	44.2 AV	54.0	-9.8	1.69 H	72	41.6	2.6
3	#5470.00	64.1 PK	68.2	-4.1	1.69 H	72	61.5	2.6
4	*5530.00	104.4 PK			1.69 H	72	67.4	37.0
5	*5530.00	94.6 AV			1.69 H	72	57.6	37.0
6	#5725.00	52.5 PK	68.2	-15.7	1.69 H	72	49.5	3.0
7	11060.00	56.8 PK	74.0	-17.2	3.43 H	315	40.7	16.1
8	11060.00	44.8 AV	54.0	-9.2	3.43 H	315	28.7	16.1
9	#16590.00	59.1 PK	68.2	-9.1	2.54 H	117	39.6	19.5

Antenna Polarity & Test Distance : Vertical at 3 m

No	Frequency (MHz)	Emission Level (dBuV/m)	Limit (dBuV/m)	Margin (dB)	Antenna Height (m)	Table Angle (Degree)	Raw Value (dBuV)	Correction Factor (dB/m)
1	5460.00	66.3 PK	74.0	-7.7	2.92 V	359	63.7	2.6
2	5460.00	47.0 AV	54.0	-7.0	2.92 V	359	44.4	2.6
3	#5470.00	65.6 PK	68.2	-2.6	2.92 V	359	63.0	2.6
4	*5530.00	110.8 PK			2.92 V	359	73.8	37.0
5	*5530.00	98.9 AV			2.92 V	359	61.9	37.0
6	#5725.00	54.5 PK	68.2	-13.7	2.92 V	359	51.5	3.0
7	11060.00	57.2 PK	74.0	-16.8	1.82 V	38	41.1	16.1
8	11060.00	45.7 AV	54.0	-8.3	1.82 V	38	29.6	16.1
9	#16590.00	57.1 PK	68.2	-11.1	2.37 V	228	37.6	19.5

Remarks:

1. Emission Level(dBuV/m) = Raw Value(dBuV) + Correction Factor(dB/m)
2. Correction Factor(dB/m) = Antenna Factor(dB/m) + Cable Factor(dB) – Pre-Amplifier Factor(dB)
3. Margin value = Emission Level – Limit value
4. The other emission levels were very low against the limit.
5. " * ": Fundamental frequency.
6. " # ": The radiated frequency is out of the restricted band.

RF Mode	TX 802.11ax (HE80)	Channel	CH 122 : 5610 MHz
Frequency Range	1GHz ~ 40GHz	Detector Function	Peak (PK) Average (AV)

Antenna Polarity & Test Distance : Horizontal at 3 m								
No	Frequency (MHz)	Emission Level (dBuV/m)	Limit (dBuV/m)	Margin (dB)	Antenna Height (m)	Table Angle (Degree)	Raw Value (dBuV)	Correction Factor (dB/m)
1	5460.00	52.5 PK	74.0	-21.5	1.01 H	49	49.9	2.6
2	5460.00	40.4 AV	54.0	-13.6	1.01 H	49	37.8	2.6
3	#5470.00	54.6 PK	68.2	-13.6	1.01 H	49	52.0	2.6
4	*5610.00	106.0 PK			1.01 H	49	69.0	37.0
5	*5610.00	96.0 AV			1.01 H	49	59.0	37.0
6	#5725.00	57.9 PK	68.2	-10.3	1.01 H	49	54.9	3.0
7	11220.00	54.4 PK	74.0	-19.6	3.42 H	326	38.7	15.7
8	11220.00	43.6 AV	54.0	-10.4	3.42 H	326	27.9	15.7
9	#16830.00	58.5 PK	68.2	-9.7	2.97 H	125	37.5	21.0

Antenna Polarity & Test Distance : Vertical at 3 m								
No	Frequency (MHz)	Emission Level (dBuV/m)	Limit (dBuV/m)	Margin (dB)	Antenna Height (m)	Table Angle (Degree)	Raw Value (dBuV)	Correction Factor (dB/m)
1	5460.00	54.1 PK	74.0	-19.9	2.14 V	358	51.5	2.6
2	5460.00	41.2 AV	54.0	-12.8	2.14 V	358	38.6	2.6
3	#5470.00	57.8 PK	68.2	-10.4	2.14 V	358	55.2	2.6
4	*5610.00	111.4 PK			2.14 V	358	74.4	37.0
5	*5610.00	101.4 AV			2.14 V	358	64.4	37.0
6	#5725.00	57.5 PK	68.2	-10.7	2.14 V	358	54.5	3.0
7	11220.00	55.6 PK	74.0	-18.4	2.00 V	36	39.9	15.7
8	11220.00	44.2 AV	54.0	-9.8	2.00 V	36	28.5	15.7
9	#16830.00	57.2 PK	68.2	-11.0	2.52 V	233	36.2	21.0

Remarks:

1. Emission Level(dBuV/m) = Raw Value(dBuV) + Correction Factor(dB/m)
2. Correction Factor(dB/m) = Antenna Factor(dB/m) + Cable Factor(dB) – Pre-Amplifier Factor(dB)
3. Margin value = Emission Level – Limit value
4. The other emission levels were very low against the limit.
5. " * ": Fundamental frequency.
6. " # ": The radiated frequency is out of the restricted band.

RF Mode	TX 802.11ax (HE80)	Channel	CH 138 : 5690 MHz
Frequency Range	1GHz ~ 40GHz	Detector Function	Peak (PK) Average (AV)

Antenna Polarity & Test Distance : Horizontal at 3 m

No	Frequency (MHz)	Emission Level (dBuV/m)	Limit (dBuV/m)	Margin (dB)	Antenna Height (m)	Table Angle (Degree)	Raw Value (dBuV)	Correction Factor (dB/m)
1	*5690.00	104.8 PK			1.00 H	50	67.6	37.2
2	*5690.00	93.7 AV			1.00 H	50	56.5	37.2
3	#5850.00	53.6 PK	68.2	-14.6	1.00 H	50	50.1	3.5
4	11380.00	54.0 PK	74.0	-20.0	3.43 H	329	37.5	16.5
5	11380.00	44.1 AV	54.0	-9.9	3.43 H	329	27.6	16.5
6	#17070.00	61.9 PK	68.2	-6.3	2.89 H	122	40.2	21.7

Antenna Polarity & Test Distance : Vertical at 3 m

No	Frequency (MHz)	Emission Level (dBuV/m)	Limit (dBuV/m)	Margin (dB)	Antenna Height (m)	Table Angle (Degree)	Raw Value (dBuV)	Correction Factor (dB/m)
1	*5690.00	111.2 PK			2.40 V	358	74.0	37.2
2	*5690.00	100.4 AV			2.40 V	358	63.2	37.2
3	#5850.00	53.8 PK	68.2	-14.4	2.40 V	358	50.3	3.5
4	11380.00	54.2 PK	74.0	-19.8	1.46 V	50	37.7	16.5
5	11380.00	44.5 AV	54.0	-9.5	1.46 V	50	28.0	16.5
6	#17070.00	60.2 PK	68.2	-8.0	2.27 V	207	38.5	21.7

Remarks:

1. Emission Level(dBuV/m) = Raw Value(dBuV) + Correction Factor(dB/m)
2. Correction Factor(dB/m) = Antenna Factor(dB/m) + Cable Factor(dB) – Pre-Amplifier Factor(dB)
3. Margin value = Emission Level – Limit value
4. The other emission levels were very low against the limit.
5. " * " : Fundamental frequency.
6. " # " : The radiated frequency is out of the restricted band.

Below 1GHz Worst-Case

RF Mode	TX 802.11ax (HE80)	Channel	CH 58 : 5290 MHz
Frequency Range	9kHz ~ 1GHz	Detector Function	Quasi-Peak (QP)

Antenna Polarity & Test Distance : Horizontal at 3 m								
No	Frequency (MHz)	Emission Level (dBuV/m)	Limit (dBuV/m)	Margin (dB)	Antenna Height (m)	Table Angle (Degree)	Raw Value (dBuV)	Correction Factor (dB/m)
1	79.47	31.7 QP	40.0	-8.3	1.00 H	2	44.8	-13.1
2	112.45	20.0 QP	43.5	-23.5	1.50 H	291	31.4	-11.4
3	186.17	23.7 QP	43.5	-19.8	2.00 H	269	34.1	-10.4
4	301.60	26.4 QP	46.0	-19.6	1.00 H	102	33.2	-6.8
5	465.53	23.9 QP	46.0	-22.1	1.00 H	152	27.1	-3.2
6	579.99	28.1 QP	46.0	-17.9	1.25 H	43	29.1	-1.0

Remarks:

1. Emission Level(dBuV/m) = Raw Value(dBuV) + Correction Factor(dB/m)
2. Correction Factor(dB/m) = Antenna Factor(dB/m) + Cable Factor(dB) – Pre-Amplifier Factor(dB)
3. Margin value = Emission Level – Limit value
4. The other emission levels were very low against the limit of frequency range 30MHz~1000MHz.
5. The emission levels were very low against the limit of frequency range 9kHz~30MHz: the amplitude of spurious emissions attenuated more than 20 dB below the permissible value to be report.

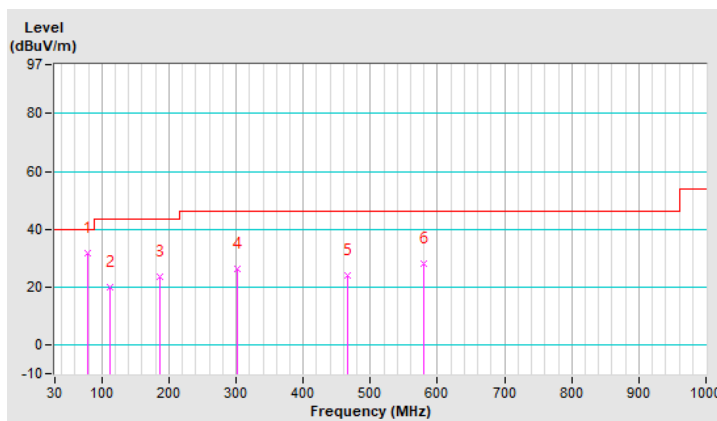

RF Mode	TX 802.11ax (HE80)	Channel	CH 58 : 5290 MHz
Frequency Range	9kHz ~ 1GHz	Detector Function	Quasi-Peak (QP)

Antenna Polarity & Test Distance : Vertical at 3 m								
No	Frequency (MHz)	Emission Level (dBuV/m)	Limit (dBuV/m)	Margin (dB)	Antenna Height (m)	Table Angle (Degree)	Raw Value (dBuV)	Correction Factor (dB/m)
1	39.70	28.6 QP	40.0	-11.4	1.00 V	24	38.3	-9.7
2	135.73	35.8 QP	43.5	-7.7	1.50 V	298	45.1	-9.3
3	151.25	24.8 QP	43.5	-18.7	1.50 V	19	33.2	-8.4
4	424.79	23.2 QP	46.0	-22.8	1.25 V	160	27.2	-4.0
5	519.85	25.7 QP	46.0	-20.3	1.00 V	129	28.0	-2.3
6	669.23	28.0 QP	46.0	-18.0	2.00 V	27	27.4	0.6

Remarks:

1. Emission Level(dBuV/m) = Raw Value(dBuV) + Correction Factor(dB/m)
2. Correction Factor(dB/m) = Antenna Factor(dB/m) + Cable Factor(dB) – Pre-Amplifier Factor(dB)
3. Margin value = Emission Level – Limit value
4. The other emission levels were very low against the limit of frequency range 30MHz~1000MHz.
5. The emission levels were very low against the limit of frequency range 9kHz~30MHz: the amplitude of spurious emissions attenuated more than 20 dB below the permissible value to be report.

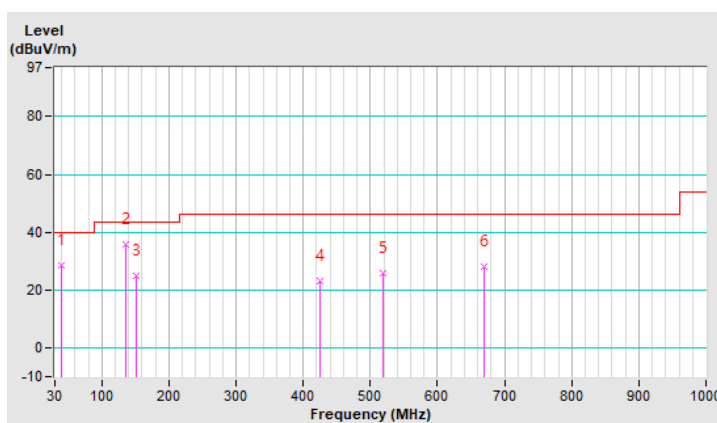

4.2 Conducted Emission Measurement

4.2.1 Limits of Conducted Emission Measurement

Frequency (MHz)	Conducted Limit (dBuV)	
	Quasi-peak	Average
0.15 - 0.5	66 - 56	56 - 46
0.50 - 5.0	56	46
5.0 - 30.0	60	50

Note: 1. The lower limit shall apply at the transition frequencies.

2. The limit decreases in line with the logarithm of the frequency in the range of 0.15 to 0.50MHz.

4.2.2 Test Instruments

Description & Manufacturer	Model No.	Serial No.	Cal. Date	Cal. Due
Test Receiver ROHDE & SCHWARZ	ESR3	102783	Dec. 21, 2020	Dec. 20, 2021
RF signal cable (with 10dB PAD) Woken	5D-FB	Cable-cond2-01	Sep. 04, 2020	Sep. 03, 2021
LISN ROHDE & SCHWARZ (EUT)	ESH2-Z5	100100	Jan. 28, 2021	Jan. 27, 2022
LISN ROHDE & SCHWARZ (Peripheral)	ESH3-Z5	100312	Aug. 18, 2020	Aug. 17, 2021
Software ADT	BV ADT_Cond_ V7.3.7.4	NA	NA	NA

Note: 1. The calibration interval of the above test instruments is 12 months and the calibrations are traceable to NML/ROC and NIST/USA.

2. The test was performed in HwaYa Shielded Room 2 (Conduction 2).

3. The VCCI Site Registration No. is C-12047.

4. Test Date: May 05, 2021

4.2.3 Test Procedures

- The EUT was placed 0.4 meters from the conducting wall of the shielded room with EUT being connected to the power mains through a line impedance stabilization network (LISN). Other support units were connected to the power mains through another LISN. The two LISNs provide 50 ohm/ 50uH of coupling impedance for the measuring instrument.
- Both lines of the power mains connected to the EUT were checked for maximum conducted interference.
- The frequency range from 150kHz to 30MHz was searched. Emission levels under (Limit - 20dB) was not recorded.

Note: The resolution bandwidth and video bandwidth of test receiver is 9kHz for quasi-peak detection (QP) and average detection (AV) at frequency 0.15MHz-30MHz.

4.2.4 Deviation from Test Standard

No deviation.

4.2.5 Test Setup

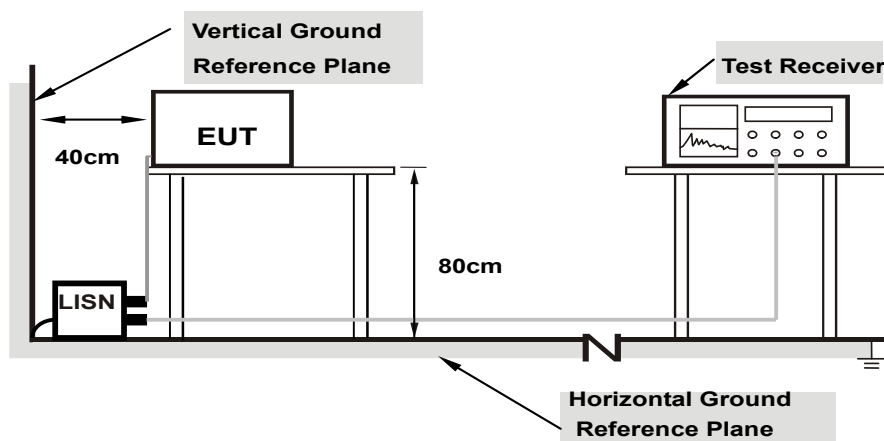

Note: 1.Support units were connected to second LISN.

For the actual test configuration, please refer to the attached file (Test Setup Photo).

4.2.6 EUT Operating Conditions

Same as 4.1.6.

4.2.7 Test Results

Worst-case data:

802.11ax (HE80)

Phase	Line (L)	Detector Function	Quasi-Peak (QP) / Average (AV)
-------	----------	-------------------	--------------------------------

No	Freq. [MHz]	Corr. Factor (dB)	Reading Value		Emission Level		Limit		Margin	
			[dB (uV)]		[dB (uV)]		[dB (uV)]		(dB)	
			Q.P.	AV.	Q.P.	AV.	Q.P.	AV.	Q.P.	AV.
1	0.15400	10.09	38.12	23.80	48.21	33.89	65.78	55.78	-17.57	-21.89
2	0.17400	10.10	33.13	18.49	43.23	28.59	64.77	54.77	-21.54	-26.18
3	0.42353	10.18	25.85	21.63	36.03	31.81	57.38	47.38	-21.35	-15.57
4	0.81800	10.24	12.62	7.96	22.86	18.20	56.00	46.00	-33.14	-27.80
5	2.77400	10.32	8.47	5.23	18.79	15.55	56.00	46.00	-37.21	-30.45
6	11.83000	10.52	15.54	9.99	26.06	20.51	60.00	50.00	-33.94	-29.49

Remarks:

1. Q.P. and AV. are abbreviations of quasi-peak and average individually.
2. The emission levels of other frequencies were very low against the limit.
3. Margin value = Emission level - Limit value
4. Correction factor = Insertion loss + Cable loss
5. Emission Level = Correction Factor + Reading Value.

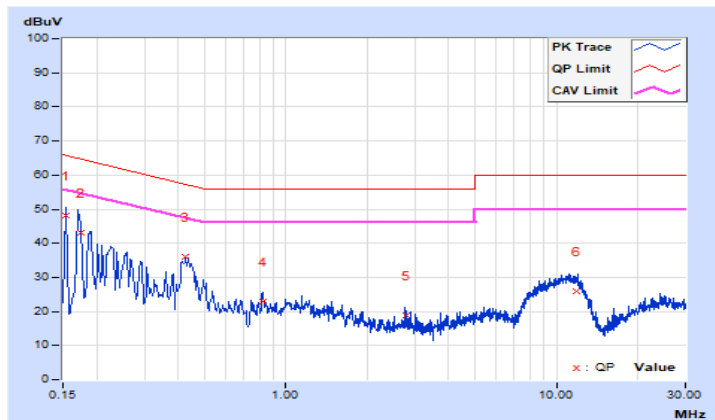

Phase	Neutral (N)	Detector Function	Quasi-Peak (QP) / Average (AV)
-------	-------------	-------------------	--------------------------------

No	Freq. [MHz]	Corr. Factor (dB)	Reading Value [dB (uV)]		Emission Level [dB (uV)]		Limit [dB (uV)]		Margin (dB)	
			Q.P.	AV.	Q.P.	AV.	Q.P.	AV.	Q.P.	AV.
			1	0.15687	10.10	38.34	24.14	48.44	34.24	65.63
2	0.25139	10.14	23.85	10.29	33.99	20.43	61.71	51.71	-27.72	-31.28
3	0.40179	10.20	15.28	6.24	25.48	16.44	57.82	47.82	-32.34	-31.38
4	1.15800	10.29	9.23	4.82	19.52	15.11	56.00	46.00	-36.48	-30.89
5	3.35905	10.39	14.36	3.24	24.75	13.63	56.00	46.00	-31.25	-32.37
6	7.27800	10.52	21.14	15.97	31.66	26.49	60.00	50.00	-28.34	-23.51

Remarks:

1. Q.P. and AV. are abbreviations of quasi-peak and average individually.
2. The emission levels of other frequencies were very low against the limit.
3. Margin value = Emission level - Limit value
4. Correction factor = Insertion loss + Cable loss
5. Emission Level = Correction Factor + Reading Value.

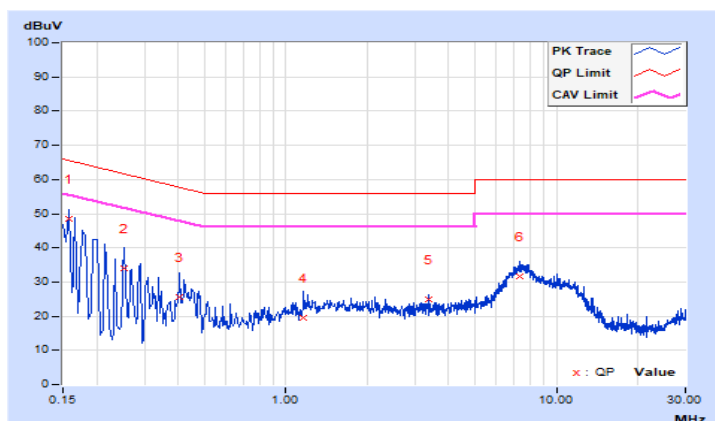

4.3 Transmit Power Measurement

4.3.1 Limits of Transmit Power Measurement

Operation Band	EUT Category		Limit
U-NII-1		Outdoor Access Point	1 Watt (30 dBm) (Max. e.i.r.p \leq 125mW(21 dBm) at any elevation angle above 30 degrees as measured from the horizon)
		Fixed point-to-point Access Point	1 Watt (30 dBm)
		Indoor Access Point	1 Watt (30 dBm)
		Mobile and Portable client device	250mW (24 dBm)
U-NII-2A	√		250mW (24 dBm) or 11 dBm+10 log B*
U-NII-2C	√		250mW (24 dBm) or 11 dBm+10 log B*
U-NII-3	√		1 Watt (30 dBm)

*B is the 26 dB emission bandwidth in megahertz

Per KDB 662911 Method of conducted output power measurement on IEEE 802.11 devices,

Array Gain = 0 dB (i.e., no array gain) for $N_{ANT} \leq 4$;

Array Gain = 0 dB (i.e., no array gain) for channel widths ≥ 40 MHz for any N_{ANT} ;

Array Gain = $5 \log(N_{ANT}/N_{SS})$ dB or 3 dB, whichever is less for 20-MHz channel widths with $N_{ANT} \geq 5$.

For power measurements on all other devices: Array Gain = $10 \log(N_{ANT}/N_{SS})$ dB.

4.3.2 Test Setup

For Power Output

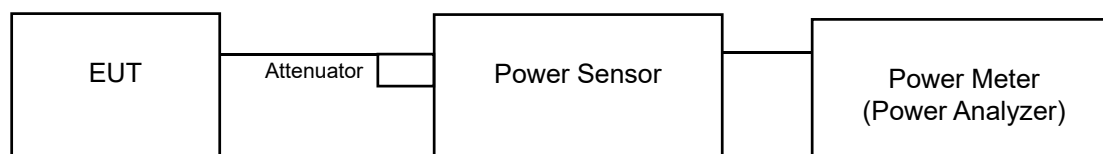

For 26dB Bandwidth and power output of transmission above 5.725 GHz where the EBW crosses 5.725 GHz

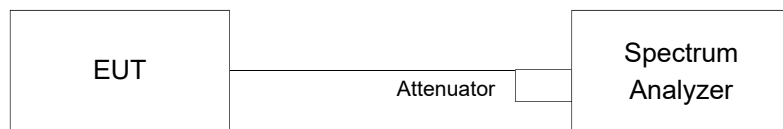

4.3.3 Test Instruments

Refer to section 4.1.2 to get information of above instrument.

4.3.4 Test Procedure

For Average Power Measurement

Method PM is used to perform output power measurement, trigger and gating function of wide band power meter is enabled to measure max output power of TX on burst. Duty factor is not added to measured value.

For transmission above 5.725 GHz where the EBW crosses 5.725 GHz

For channel aggregation (channel 138, 142, 144) measurement refer to KDB 789033 D02 General UNII Test Procedures New Rules v02r01 Section II E 2 b) method SA-1.

For 26dB Bandwidth

- a. Set RBW = approximately 1% of the emission bandwidth.
- b. Set the VBW > RBW.
- c. Detector = Peak.
- d. Trace mode = max hold.
- e. Measure the maximum width of the emission that is 26 dB down from the peak of the emission. Compare this with the RBW setting of the analyzer. Readjust RBW and repeat measurement as needed until the RBW/EBW ratio is approximately 1%.

4.3.5 Deviation from Test Standard

No deviation.

4.3.6 EUT Operating Conditions

The software provided by client to enable the EUT under transmission condition continuously at lowest, middle and highest channel frequencies individually.

4.3.7 Test Result

Power Output:

CDD Mode

802.11a

Chan.	Freq. (MHz)	Maximum Conducted Power (dBm)				Total Power (mW)	Total Power (dBm)	Power Limit (dBm)	Pass / Fail
		Chain 0	Chain 1	Chain 2	Chain 3				
52	5260	12.67	12.39	12.82	12.55	72.962	18.63	24.00	Pass
60	5300	12.74	12.63	12.40	12.58	72.608	18.61	24.00	Pass
64	5320	12.86	12.73	12.45	12.79	74.660	18.73	24.00	Pass
100	5500	11.77	11.95	11.90	11.64	60.775	17.84	23.60	Pass
116	5580	11.35	11.67	11.90	11.84	59.099	17.72	23.60	Pass
140	5700	11.91	11.67	11.77	11.29	58.703	17.69	23.60	Pass
144	5720 (For U-NII-2C)	11.19	10.56	10.75	10.85	48.575	16.86	22.39	Pass
144	5720 (For U-NII-3)	2.25	2.46	2.30	2.24	6.814	8.33	29.30	Pass

Note:

5260~5320MHz: Gain = 5.4dBi < 6dBi, so the limit is not reduced.

5500~5700MHz: Gain = 6.4dBi > 6dBi, so the limit shall be reduced to 24-(6.4-6) = 23.60dBm.

5720MHz: Gain = 6.4dBi > 6dBi, so the limit shall be reduced to 22.79-(6.4-6) = 22.39dBm.

5745~5825MHz: Gain = 6.7dBi > 6dBi, so the limit shall be reduced to 30-(6.7-6) = 29.30dBm.

For U-NII-2A, U-NII-2C Band:

Chain 0

1. 11dBm + 10log (20.42) = 24.10 > 24dBm
2. 11dBm + 10log (20.42) = 24.10 > 24dBm
3. 11dBm + 10log (20.41) = 24.09 > 24dBm
4. 11dBm + 10log (20.41) = 24.09 > 24dBm
5. 11dBm + 10log (20.52) = 24.12 > 24dBm
6. 11dBm + 10log (20.51) = 24.11 > 24dBm
7. 11dBm + 10log (5725.00 - 5709.87) = 22.79 < 24dBm

Chain 1

1. 11dBm + 10log (20.35) = 24.08 > 24dBm
2. 11dBm + 10log (20.46) = 24.10 > 24dBm
3. 11dBm + 10log (20.41) = 24.09 > 24dBm
4. 11dBm + 10log (20.45) = 24.10 > 24dBm
5. 11dBm + 10log (20.46) = 24.10 > 24dBm
6. 11dBm + 10log (20.49) = 24.11 > 24dBm
7. 11dBm + 10log (5725.00 - 5709.79) = 22.82 < 24dBm

Chain 2

1. $11\text{dBm} + 10\log(20.41) = 24.09 > 24\text{dBm}$
2. $11\text{dBm} + 10\log(20.48) = 24.11 > 24\text{dBm}$
3. $11\text{dBm} + 10\log(20.51) = 24.11 > 24\text{dBm}$
4. $11\text{dBm} + 10\log(20.51) = 24.11 > 24\text{dBm}$
5. $11\text{dBm} + 10\log(20.44) = 24.10 > 24\text{dBm}$
6. $11\text{dBm} + 10\log(20.49) = 24.11 > 24\text{dBm}$
7. $11\text{dBm} + 10\log(5725.00 - 5709.85) = 22.80 < 24\text{dBm}$

Chain 3

1. $11\text{dBm} + 10\log(20.45) = 24.10 > 24\text{dBm}$
2. $11\text{dBm} + 10\log(20.47) = 24.11 > 24\text{dBm}$
3. $11\text{dBm} + 10\log(20.54) = 24.12 > 24\text{dBm}$
4. $11\text{dBm} + 10\log(20.30) = 24.07 > 24\text{dBm}$
5. $11\text{dBm} + 10\log(20.45) = 24.10 > 24\text{dBm}$
6. $11\text{dBm} + 10\log(20.49) = 24.11 > 24\text{dBm}$
7. $11\text{dBm} + 10\log(5725.00 - 5709.83) = 22.80 < 24\text{dBm}$

802.11ax (HE20)

Chan.	Freq. (MHz)	Maximum Conducted Power (dBm)				Total Power (mW)	Total Power (dBm)	Power Limit (dBm)	Pass / Fail
		Chain 0	Chain 1	Chain 2	Chain 3				
52	5260	13.07	12.65	12.96	12.67	76.947	18.86	24.00	Pass
60	5300	13.27	13.08	12.88	12.87	80.329	19.05	24.00	Pass
64	5320	13.13	13.27	13.13	12.82	81.493	19.11	24.00	Pass
100	5500	11.70	12.07	12.34	12.10	64.255	18.08	23.60	Pass
116	5580	12.07	11.98	12.29	11.78	63.892	18.05	23.60	Pass
140	5700	12.12	12.24	11.87	12.55	66.413	18.22	23.60	Pass
144	5720 (For U-NII-2C)	11.01	11.51	11.52	11.06	53.731	17.30	23.25	Pass
144	5720 (For U-NII-3)	3.87	3.83	3.89	3.43	9.505	9.78	29.30	Pass

Note:

5260~5320MHz: Gain = 5.4dBi < 6dBi, so the limit is not reduced.

5500~5700MHz: Gain = 6.4dBi > 6dBi, so the limit shall be reduced to 24-(6.4-6) = 23.60dBm

5720MHz: Gain = 6.4dBi > 6dBi, so the limit shall be reduced to 23.65-(6.4-6) = 22.39dBm

5745~5825MHz: Gain = 6.7dBi > 6dBi, so the limit shall be reduced to 30-(6.7-6) = 29.30dBm.

For U-NII-2A, U-NII-2C Band:

Chain 0

1. 11dBm + 10log (36.57) = 26.63 > 24dBm
2. 11dBm + 10log (36.66) = 26.64 > 24dBm
3. 11dBm + 10log (26.10) = 25.16 > 24dBm
4. 11dBm + 10log (25.49) = 25.06 > 24dBm
5. 11dBm + 10log (36.54) = 26.62 > 24dBm
6. 11dBm + 10log (23.64) = 24.73 > 24dBm
7. 11dBm + 10log (5725.00 - 5706.55) = 23.65 < 24dBm

Chain 1

1. 11dBm + 10log (28.18) = 25.49 > 24dBm
2. 11dBm + 10log (24.59) = 24.90 > 24dBm
3. 11dBm + 10log (23.19) = 24.65 > 24dBm
4. 11dBm + 10log (24.87) = 24.95 > 24dBm
5. 11dBm + 10log (26.61) = 25.25 > 24dBm
6. 11dBm + 10log (24.81) = 24.94 > 24dBm
7. 11dBm + 10log (5725.00 - 5704.33) = 24.15 > 24dBm

Chain 2

1. 11dBm + 10log (26.49) = 25.23 > 24dBm
2. 11dBm + 10log (24.57) = 24.90 > 24dBm
3. 11dBm + 10log (26.02) = 25.15 > 24dBm
4. 11dBm + 10log (24.59) = 24.90 > 24dBm
5. 11dBm + 10log (29.14) = 25.64 > 24dBm
6. 11dBm + 10log (26.68) = 25.26 > 24dBm
7. 11dBm + 10log (5725.00 - 5704.21) = 24.17 > 24dBm

Chain 3

1. $11\text{dBm} + 10\log(26.10) = 25.16 > 24\text{dBm}$
2. $11\text{dBm} + 10\log(26.42) = 25.21 > 24\text{dBm}$
3. $11\text{dBm} + 10\log(23.61) = 24.73 > 24\text{dBm}$
4. $11\text{dBm} + 10\log(27.09) = 25.32 > 24\text{dBm}$
5. $11\text{dBm} + 10\log(37.43) = 26.73 > 24\text{dBm}$
6. $11\text{dBm} + 10\log(26.61) = 25.25 > 24\text{dBm}$
7. $11\text{dBm} + 10\log(5725.00 - 5705.70) = 23.85 < 24\text{dBm}$

802.11ax (HE40)

Chan.	Freq. (MHz)	Maximum Conducted Power (dBm)				Total Power (mW)	Total Power (dBm)	Power Limit (dBm)	Pass / Fail
		Chain 0	Chain 1	Chain 2	Chain 3				
54	5270	15.27	15.16	15.03	15.25	131.799	21.20	24.00	Pass
62	5310	15.02	15.39	15.28	15.50	135.573	21.32	24.00	Pass
102	5510	14.56	14.22	14.14	14.33	108.044	20.34	23.60	Pass
110	5550	14.08	14.02	14.51	14.14	105.011	20.21	23.60	Pass
134	5670	14.00	14.09	14.22	14.61	106.095	20.26	23.60	Pass
142	5710 (For U-NII-2C)	13.53	13.48	13.42	13.48	89.090	19.50	23.60	Pass
142	5710 (For U-NII-3)	4.30	3.89	3.86	3.87	10.011	10.00	29.30	Pass

Note:

5260~5320MHz: Gain = 5.4dBi < 6dBi, so the limit is not reduced.

5500~5720MHz: Gain = 6.4dBi > 6dBi, so the limit shall be reduced to 24-(6.4-6) = 23.60dBm

5745~5825MHz: Gain = 6.7dBi > 6dBi, so the limit shall be reduced to 30-(6.7-6) = 29.30dBm.

For U-NII-2A, U-NII-2C Band:

Chain 0

1. 11dBm + 10log (40.75) = 27.10 > 24dBm
2. 11dBm + 10log (40.77) = 27.10 > 24dBm
3. 11dBm + 10log (40.87) = 27.11 > 24dBm
4. 11dBm + 10log (40.71) = 27.09 > 24dBm
5. 11dBm + 10log (40.81) = 27.10 > 24dBm
6. 11dBm + 10log (5725.00 - 5689.85) = 26.45 > 24dBm

Chain 1

1. 11dBm + 10log (40.72) = 27.09 > 24dBm
2. 11dBm + 10log (40.73) = 27.09 > 24dBm
3. 11dBm + 10log (40.68) = 27.09 > 24dBm
4. 11dBm + 10log (40.73) = 27.09 > 24dBm
5. 11dBm + 10log (40.72) = 27.09 > 24dBm
6. 11dBm + 10log (5725.00 - 5689.81) = 26.46 > 24dBm

Chain 2

1. 11dBm + 10log (40.68) = 27.09 > 24dBm
2. 11dBm + 10log (40.62) = 27.08 > 24dBm
3. 11dBm + 10log (40.59) = 27.08 > 24dBm
4. 11dBm + 10log (40.77) = 27.10 > 24dBm
5. 11dBm + 10log (40.70) = 27.09 > 24dBm
6. 11dBm + 10log (5725.00 - 5689.73) = 26.47 > 24dBm

Chain 3

1. $11\text{dBm} + 10\log(40.72) = 27.09 > 24\text{dBm}$
2. $11\text{dBm} + 10\log(40.54) = 27.07 > 24\text{dBm}$
3. $11\text{dBm} + 10\log(40.65) = 27.09 > 24\text{dBm}$
4. $11\text{dBm} + 10\log(40.72) = 27.09 > 24\text{dBm}$
5. $11\text{dBm} + 10\log(40.76) = 27.10 > 24\text{dBm}$
6. $11\text{dBm} + 10\log(5725.00 - 5689.77) = 26.46 > 24\text{dBm}$

802.11ax (HE80)

Chan.	Freq. (MHz)	Maximum Conducted Power (dBm)				Total Power (mW)	Total Power (dBm)	Power Limit (dBm)	Pass / Fail
		Chain 0	Chain 1	Chain 2	Chain 3				
58	5290	17.35	17.20	17.12	17.17	210.448	23.23	24.00	Pass
106	5530	16.42	16.15	16.07	16.37	168.871	22.28	23.60	Pass
122	5610	16.83	16.53	16.32	16.64	182.159	22.60	23.60	Pass
138	5690 (For U-NII-2C)	16.01	16.11	15.95	16.01	159.992	22.04	23.60	Pass
138	5690 (For U-NII-3)	1.00	0.91	0.91	1.02	4.990	6.98	29.30	Pass

Note:

5260~5320MHz: Gain = 5.4dBi < 6dBi, so the limit is not reduced.

5500~5720MHz: Gain = 6.4dBi > 6dBi, so the limit shall be reduced to $24 - (6.4 - 6) = 23.60\text{dBm}$

5745~5825MHz: Gain = 6.7dBi > 6dBi, so the limit shall be reduced to $30 - (6.7 - 6) = 29.30\text{dBm}$.

For U-NII-2A, U-NII-2C Band:

Chain 0

1. $11\text{dBm} + 10\log(80.89) = 30.07 > 24\text{dBm}$
2. $11\text{dBm} + 10\log(81.01) = 30.08 > 24\text{dBm}$
3. $11\text{dBm} + 10\log(81.19) = 30.09 > 24\text{dBm}$
4. $11\text{dBm} + 10\log(5725.00 - 5649.85) = 29.75 > 24\text{dBm}$

Chain 1

1. $11\text{dBm} + 10\log(81.03) = 30.08 > 24\text{dBm}$
2. $11\text{dBm} + 10\log(80.93) = 30.08 > 24\text{dBm}$
3. $11\text{dBm} + 10\log(81.01) = 30.08 > 24\text{dBm}$
4. $11\text{dBm} + 10\log(5725.00 - 5649.79) = 29.76 > 24\text{dBm}$

Chain 2

1. $11\text{dBm} + 10\log(81.04) = 30.08 > 24\text{dBm}$
2. $11\text{dBm} + 10\log(80.93) = 30.08 > 24\text{dBm}$
3. $11\text{dBm} + 10\log(81.19) = 30.09 > 24\text{dBm}$
4. $11\text{dBm} + 10\log(5725.00 - 5649.81) = 29.76 > 24\text{dBm}$

Chain 3

1. $11\text{dBm} + 10\log(81.20) = 30.09 > 24\text{dBm}$
2. $11\text{dBm} + 10\log(80.87) = 30.07 > 24\text{dBm}$
3. $11\text{dBm} + 10\log(81.18) = 30.09 > 24\text{dBm}$
4. $11\text{dBm} + 10\log(5725.00 - 5649.67) = 29.76 > 24\text{dBm}$

Beamforming Mode

802.11ax (HE20)

Chan.	Freq. (MHz)	Maximum Conducted Power (dBm)				Total Power (mW)	Total Power (dBm)	Power Limit (dBm)	Pass / Fail
		Chain 0	Chain 1	Chain 2	Chain 3				
52	5260	7.05	6.63	6.94	6.65	19.239	12.84	19.82	Pass
60	5300	7.25	7.06	6.86	6.85	20.085	13.03	19.82	Pass
64	5320	7.11	7.25	7.11	6.80	20.376	13.09	19.82	Pass
100	5500	5.68	6.05	6.32	6.08	16.066	12.06	18.80	Pass
116	5580	6.05	5.96	6.27	5.76	15.975	12.03	18.80	Pass
140	5700	6.10	6.22	5.85	6.53	16.605	12.20	18.80	Pass
144	5720 (For U-NII-2C)	4.99	5.49	5.50	5.04	13.435	11.28	18.45	Pass
144	5720 (For U-NII-3)	-2.15	-2.19	-2.13	-2.59	2.377	3.76	24.75	Pass

Note:

For U-NII-2A, The directional gain is $10 \log[(10^{G1/20} + 10^{G2/20} + \dots + 10^{GN/20})^2/4] = 10.18\text{dBi} > 6\text{dBi}$, so the limit shall be reduced to $24 - (10.18 - 6) = 19.82\text{dBm}$.

For U-NII-2C, The directional gain is $10 \log[(10^{G1/20} + 10^{G2/20} + \dots + 10^{GN/20})^2/4] = 11.20\text{dBi} > 6\text{dBi}$, so the limit shall be reduced to $24 - (11.20 - 6) = 18.80\text{dBm}$.

For U-NII-2C(5720MHz), The directional gain is $10 \log[(10^{G1/20} + 10^{G2/20} + \dots + 10^{GN/20})^2/4] = 11.20\text{dBi} > 6\text{dBi}$, so the limit shall be reduced to $23.65 - (11.20 - 6) = 18.45\text{dBm}$.

For U-NII-3, The directional gain is $10 \log[(10^{G1/20} + 10^{G2/20} + \dots + 10^{GN/20})^2/4] = 11.25\text{dBi} > 6\text{dBi}$, so the limit shall be reduced to $30 - (11.25 - 6) = 24.75\text{dBm}$.

For U-NII-2A, U-NII-2C Band:

Chain 0

1. $11\text{dBm} + 10\log(36.57) = 26.63 > 24\text{dBm}$
2. $11\text{dBm} + 10\log(36.66) = 26.64 > 24\text{dBm}$
3. $11\text{dBm} + 10\log(26.10) = 25.16 > 24\text{dBm}$
4. $11\text{dBm} + 10\log(25.49) = 25.06 > 24\text{dBm}$
5. $11\text{dBm} + 10\log(36.54) = 26.62 > 24\text{dBm}$
6. $11\text{dBm} + 10\log(23.64) = 24.73 > 24\text{dBm}$
7. $11\text{dBm} + 10\log(5725.00 - 5706.55) = 23.65 < 24\text{dBm}$

Chain 1

1. $11\text{dBm} + 10\log(28.18) = 25.49 > 24\text{dBm}$
2. $11\text{dBm} + 10\log(24.59) = 24.90 > 24\text{dBm}$
3. $11\text{dBm} + 10\log(23.19) = 24.65 > 24\text{dBm}$
4. $11\text{dBm} + 10\log(24.87) = 24.95 > 24\text{dBm}$
5. $11\text{dBm} + 10\log(26.61) = 25.25 > 24\text{dBm}$
6. $11\text{dBm} + 10\log(24.81) = 24.94 > 24\text{dBm}$
7. $11\text{dBm} + 10\log(5725.00 - 5704.33) = 24.15 > 24\text{dBm}$

Chain 2

1. $11\text{dBm} + 10\log(26.49) = 25.23 > 24\text{dBm}$
2. $11\text{dBm} + 10\log(24.57) = 24.90 > 24\text{dBm}$
3. $11\text{dBm} + 10\log(26.02) = 25.15 > 24\text{dBm}$
4. $11\text{dBm} + 10\log(24.59) = 24.90 > 24\text{dBm}$
5. $11\text{dBm} + 10\log(29.14) = 25.64 > 24\text{dBm}$
6. $11\text{dBm} + 10\log(26.68) = 25.26 > 24\text{dBm}$
7. $11\text{dBm} + 10\log(5725.00 - 5704.21) = 24.17 > 24\text{dBm}$

Chain 3

1. $11\text{dBm} + 10\log(26.10) = 25.16 > 24\text{dBm}$
2. $11\text{dBm} + 10\log(26.42) = 25.21 > 24\text{dBm}$
3. $11\text{dBm} + 10\log(23.61) = 24.73 > 24\text{dBm}$
4. $11\text{dBm} + 10\log(27.09) = 25.32 > 24\text{dBm}$
5. $11\text{dBm} + 10\log(37.43) = 26.73 > 24\text{dBm}$
6. $11\text{dBm} + 10\log(26.61) = 25.25 > 24\text{dBm}$
7. $11\text{dBm} + 10\log(5725.00 - 5705.70) = 23.85 < 24\text{dBm}$

802.11ax (HE40)

Chan.	Freq. (MHz)	Maximum Conducted Power (dBm)				Total Power (mW)	Total Power (dBm)	Power Limit (dBm)	Pass / Fail
		Chain 0	Chain 1	Chain 2	Chain 3				
54	5270	9.25	9.14	9.01	9.23	32.954	15.18	19.82	Pass
62	5310	9.00	9.37	9.26	9.48	33.898	15.30	19.82	Pass
102	5510	8.54	8.20	8.12	8.31	27.015	14.32	18.80	Pass
110	5550	8.06	8.00	8.49	8.12	26.256	14.19	18.80	Pass
134	5670	7.98	8.07	8.20	8.59	26.527	14.24	18.80	Pass
142	5710 (For U-NII-2C)	7.51	7.46	7.40	7.46	22.276	13.48	18.80	Pass
142	5710 (For U-NII-3)	-1.72	-2.13	-2.16	-2.15	2.503	3.98	24.75	Pass

Note:

For U-NII-2A, The directional gain is $10 \log[(10^{G1/20} + 10^{G2/20} + \dots + 10^{GN/20})^2/4] = 10.18 \text{dBi} > 6 \text{dBi}$, so the limit shall be reduced to $24 - (10.18 - 6) = 19.82 \text{dBm}$.

For U-NII-2C, The directional gain is $10 \log[(10^{G1/20} + 10^{G2/20} + \dots + 10^{GN/20})^2/4] = 11.20 \text{dBi} > 6 \text{dBi}$, so the limit shall be reduced to $24 - (11.20 - 6) = 18.80 \text{dBm}$.

For U-NII-3, The directional gain is $10 \log[(10^{G1/20} + 10^{G2/20} + \dots + 10^{GN/20})^2/4] = 11.25 \text{dBi} > 6 \text{dBi}$, so the limit shall be reduced to $30 - (11.25 - 6) = 24.75 \text{dBm}$.

For U-NII-2A, U-NII-2C Band:

Chain 0

1. $11 \text{dBm} + 10 \log(40.75) = 27.10 > 24 \text{dBm}$
2. $11 \text{dBm} + 10 \log(40.77) = 27.10 > 24 \text{dBm}$
3. $11 \text{dBm} + 10 \log(40.87) = 27.11 > 24 \text{dBm}$
4. $11 \text{dBm} + 10 \log(40.71) = 27.09 > 24 \text{dBm}$
5. $11 \text{dBm} + 10 \log(40.81) = 27.10 > 24 \text{dBm}$
6. $11 \text{dBm} + 10 \log(5725.00 - 5689.85) = 26.45 > 24 \text{dBm}$

Chain 1

1. $11 \text{dBm} + 10 \log(40.72) = 27.09 > 24 \text{dBm}$
2. $11 \text{dBm} + 10 \log(40.73) = 27.09 > 24 \text{dBm}$
3. $11 \text{dBm} + 10 \log(40.68) = 27.09 > 24 \text{dBm}$
4. $11 \text{dBm} + 10 \log(40.73) = 27.09 > 24 \text{dBm}$
5. $11 \text{dBm} + 10 \log(40.72) = 27.09 > 24 \text{dBm}$
6. $11 \text{dBm} + 10 \log(5725.00 - 5689.81) = 26.46 > 24 \text{dBm}$

Chain 2

1. $11 \text{dBm} + 10 \log(40.68) = 27.09 > 24 \text{dBm}$
2. $11 \text{dBm} + 10 \log(40.62) = 27.08 > 24 \text{dBm}$
3. $11 \text{dBm} + 10 \log(40.59) = 27.08 > 24 \text{dBm}$
4. $11 \text{dBm} + 10 \log(40.77) = 27.10 > 24 \text{dBm}$
5. $11 \text{dBm} + 10 \log(40.70) = 27.09 > 24 \text{dBm}$
6. $11 \text{dBm} + 10 \log(5725.00 - 5689.73) = 26.47 > 24 \text{dBm}$

Chain 3

1. $11\text{dBm} + 10\log(40.72) = 27.09 > 24\text{dBm}$
2. $11\text{dBm} + 10\log(40.54) = 27.07 > 24\text{dBm}$
3. $11\text{dBm} + 10\log(40.65) = 27.09 > 24\text{dBm}$
4. $11\text{dBm} + 10\log(40.72) = 27.09 > 24\text{dBm}$
5. $11\text{dBm} + 10\log(40.76) = 27.10 > 24\text{dBm}$
6. $11\text{dBm} + 10\log(5725.00 - 5689.77) = 26.46 > 24\text{dBm}$

802.11ax (HE80)

Chan.	Freq. (MHz)	Maximum Conducted Power (dBm)				Total Power (mW)	Total Power (dBm)	Power Limit (dBm)	Pass / Fail
		Chain 0	Chain 1	Chain 2	Chain 3				
58	5290	11.33	11.18	11.10	11.15	52.619	17.21	19.82	Pass
106	5530	10.40	10.13	10.05	10.35	42.224	16.26	18.80	Pass
122	5610	10.81	10.51	10.30	10.62	45.546	16.58	18.80	Pass
138	5690 (For U-NII-2C)	9.99	10.09	9.93	9.99	40.004	16.02	18.80	Pass
138	5690 (For U-NII-3)	-5.02	-5.11	-5.11	-5.00	1.248	0.96	24.75	Pass

Note:

For U-NII-2A, The directional gain is $10 \log[(10^{G1/20} + 10^{G2/20} + \dots + 10^{GN/20})^2/4] = 10.18 \text{dBi} > 6 \text{dBi}$, so the limit shall be reduced to $24 - (10.18 - 6) = 19.82 \text{dBm}$.

For U-NII-2C, The directional gain is $10 \log[(10^{G1/20} + 10^{G2/20} + \dots + 10^{GN/20})^2/4] = 11.20 \text{dBi} > 6 \text{dBi}$, so the limit shall be reduced to $24 - (11.20 - 6) = 18.80 \text{dBm}$.

For U-NII-3, The directional gain is $10 \log[(10^{G1/20} + 10^{G2/20} + \dots + 10^{GN/20})^2/4] = 11.25 \text{dBi} > 6 \text{dBi}$, so the limit shall be reduced to $30 - (11.25 - 6) = 24.75 \text{dBm}$.

For U-NII-2A, U-NII-2C Band:

Chain 0

- $11 \text{dBm} + 10 \log(80.89) = 30.07 > 24 \text{dBm}$
- $11 \text{dBm} + 10 \log(81.01) = 30.08 > 24 \text{dBm}$
- $11 \text{dBm} + 10 \log(81.19) = 30.09 > 24 \text{dBm}$
- $11 \text{dBm} + 10 \log(5725.00 - 5649.85) = 29.75 > 24 \text{dBm}$

Chain 1

- $11 \text{dBm} + 10 \log(81.03) = 30.08 > 24 \text{dBm}$
- $11 \text{dBm} + 10 \log(80.93) = 30.08 > 24 \text{dBm}$
- $11 \text{dBm} + 10 \log(81.01) = 30.08 > 24 \text{dBm}$
- $11 \text{dBm} + 10 \log(5725.00 - 5649.79) = 29.76 > 24 \text{dBm}$

Chain 2

- $11 \text{dBm} + 10 \log(81.04) = 30.08 > 24 \text{dBm}$
- $11 \text{dBm} + 10 \log(80.93) = 30.08 > 24 \text{dBm}$
- $11 \text{dBm} + 10 \log(81.19) = 30.09 > 24 \text{dBm}$
- $11 \text{dBm} + 10 \log(5725.00 - 5649.81) = 29.76 > 24 \text{dBm}$

Chain 3

- $11 \text{dBm} + 10 \log(81.20) = 30.09 > 24 \text{dBm}$
- $11 \text{dBm} + 10 \log(80.87) = 30.07 > 24 \text{dBm}$
- $11 \text{dBm} + 10 \log(81.18) = 30.09 > 24 \text{dBm}$
- $11 \text{dBm} + 10 \log(5725.00 - 5649.67) = 29.76 > 24 \text{dBm}$

Straddle channel power plots:

802.11a

Chain 0

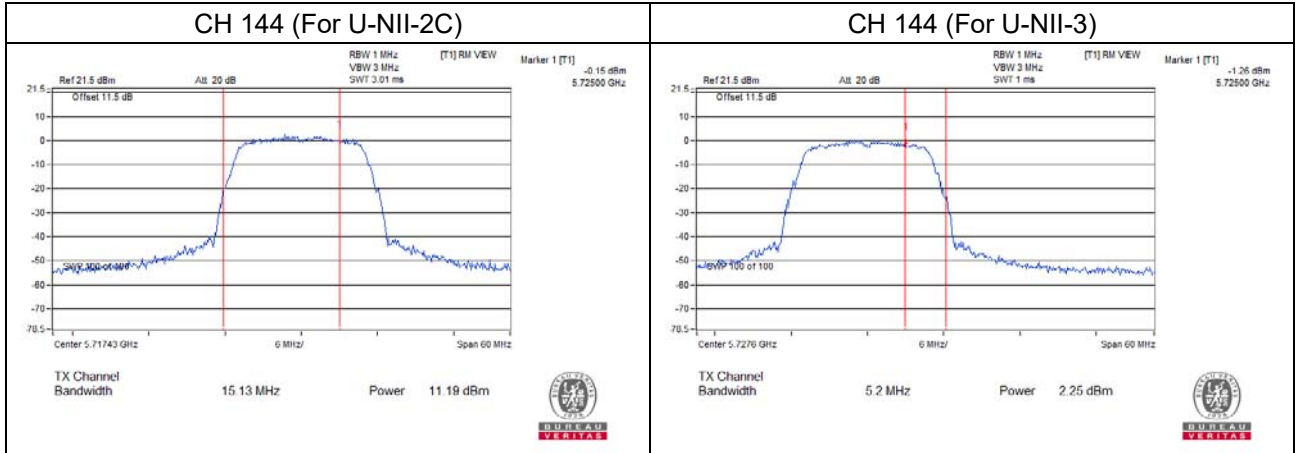

Chain 1

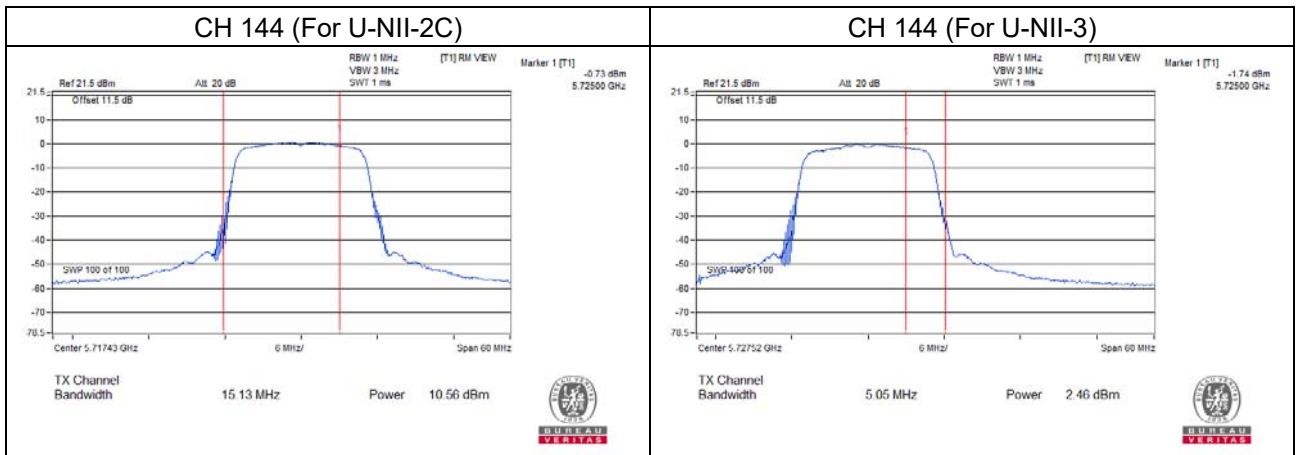

Chain 2

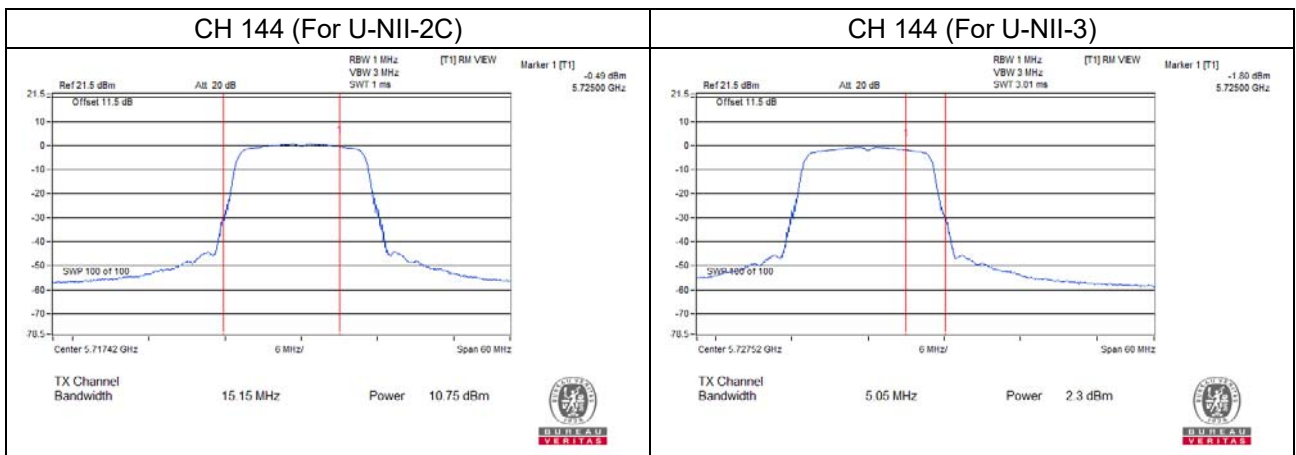

Chain 3

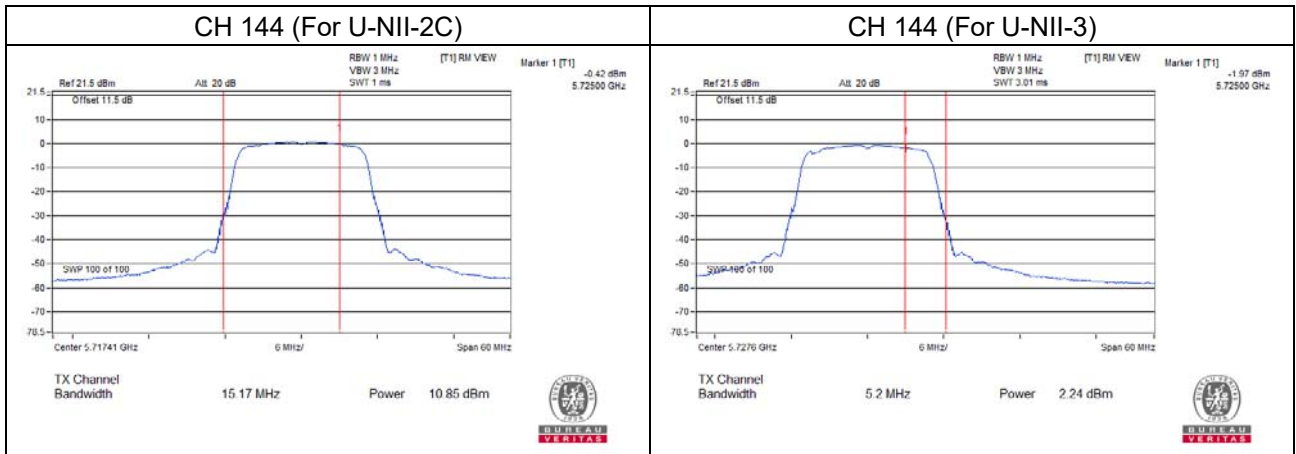

802.11ax (HE20)

Chain 0

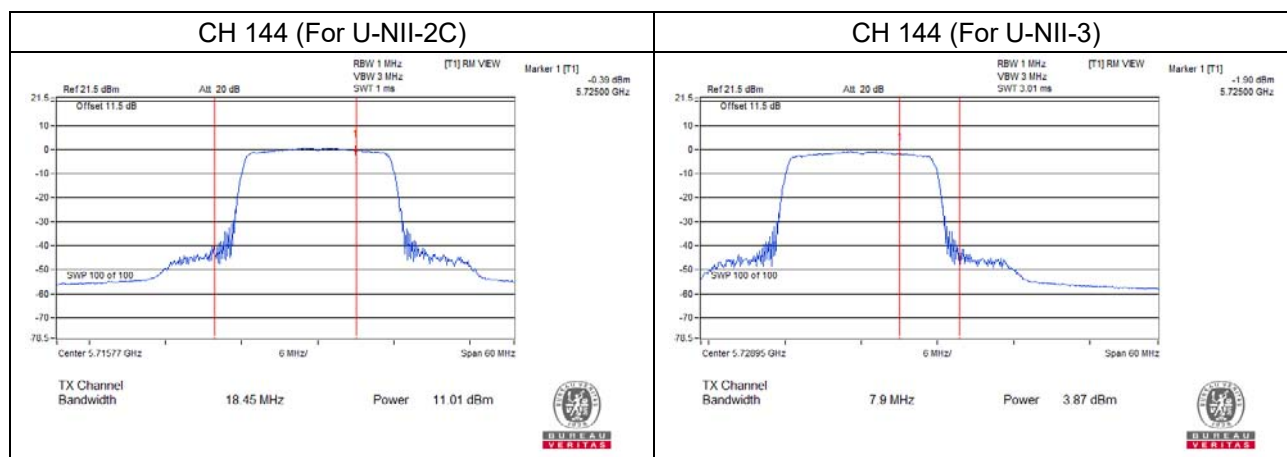

Chain 1

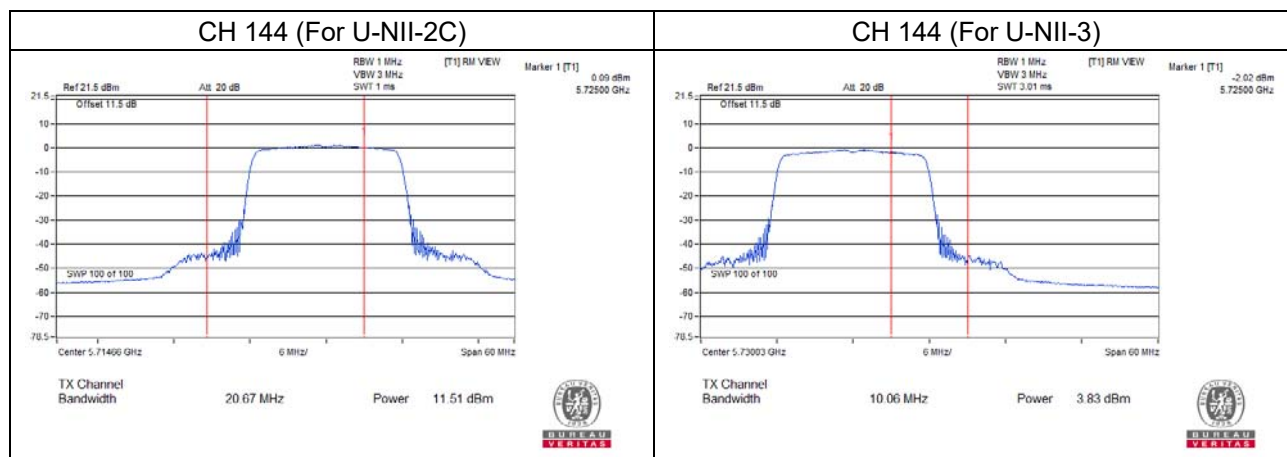

Chain 2

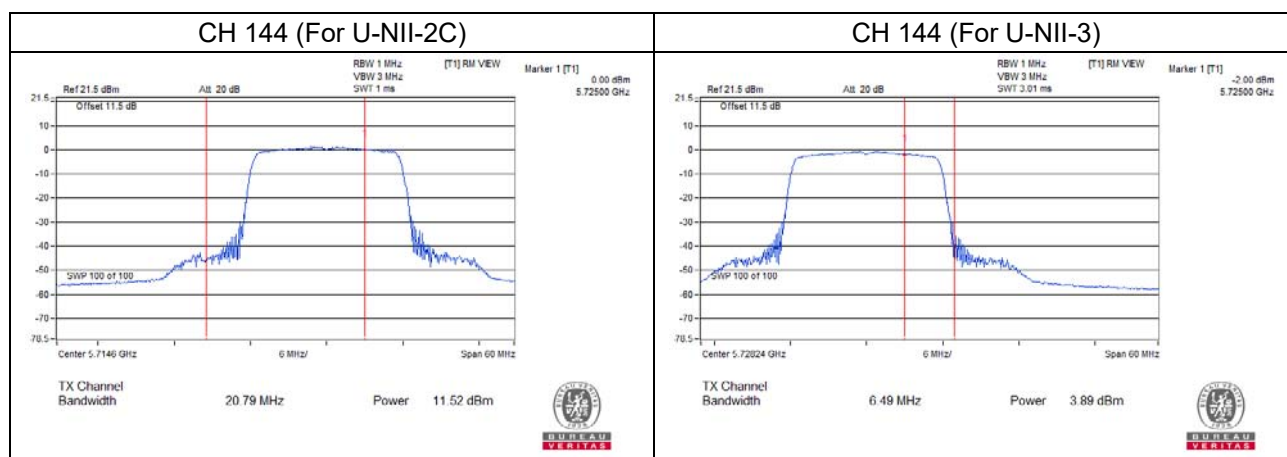

Chain 3

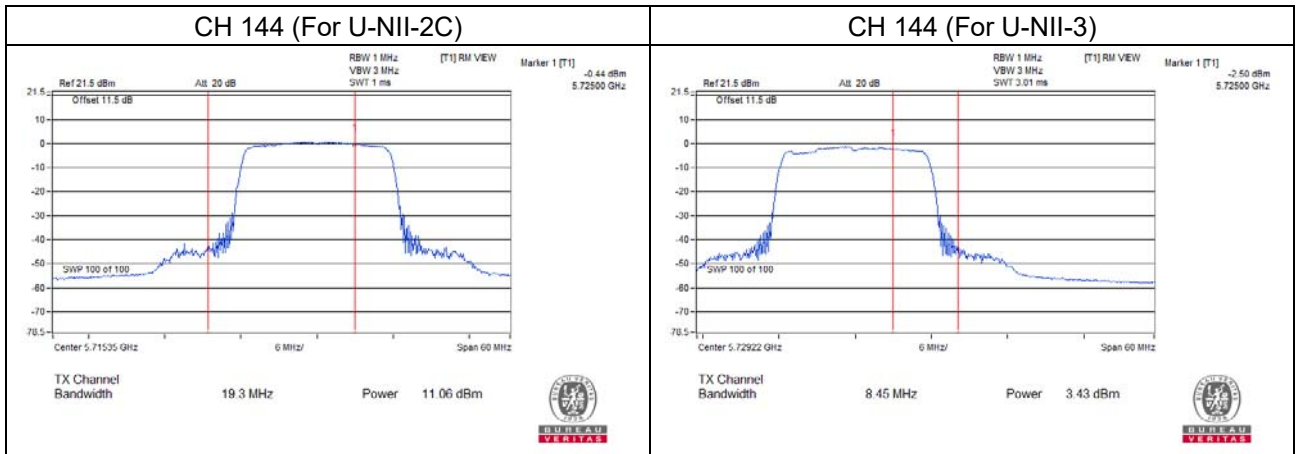

802.11ax (HE40)

Chain 0

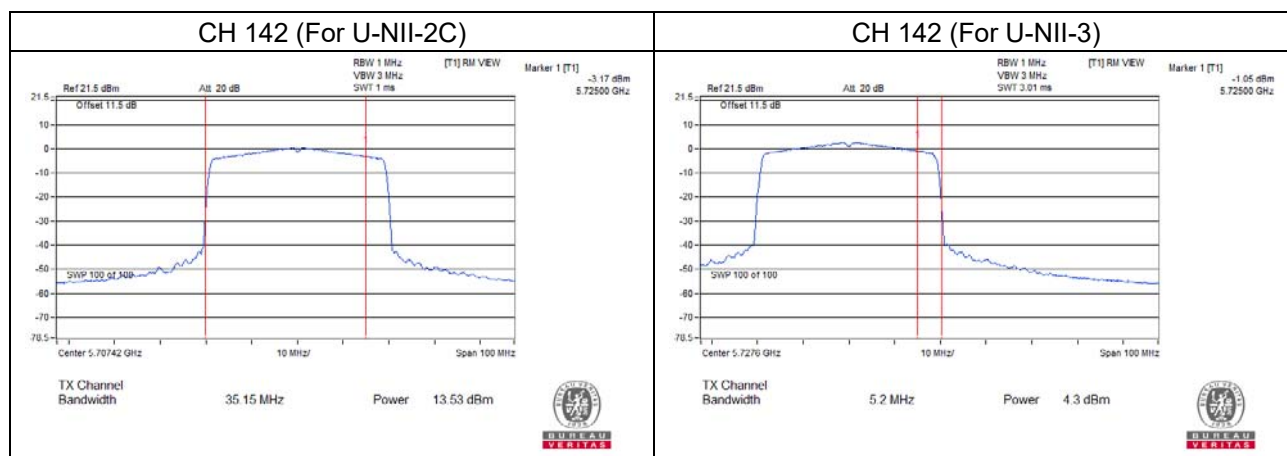

Chain 1

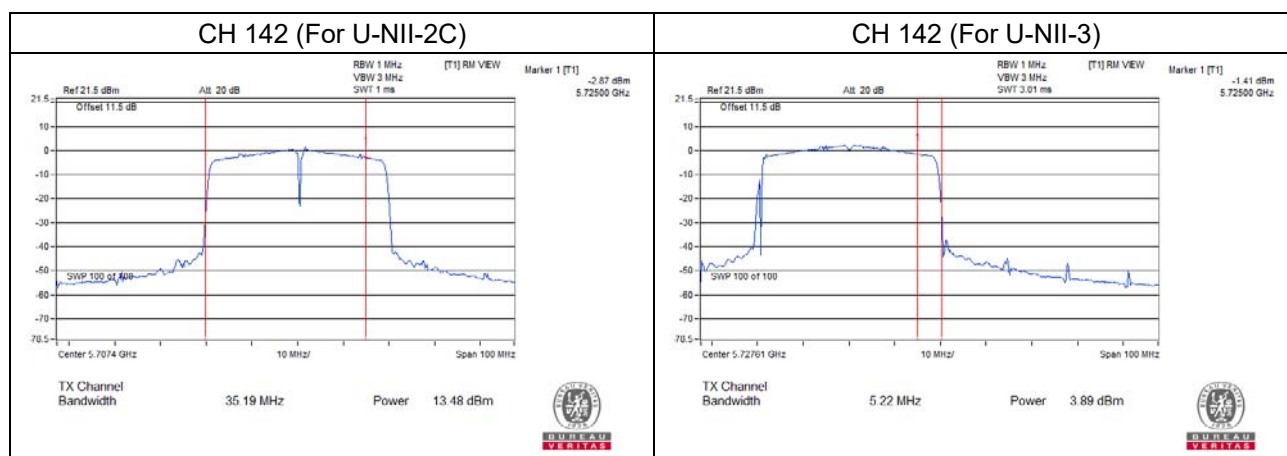

Chain 2

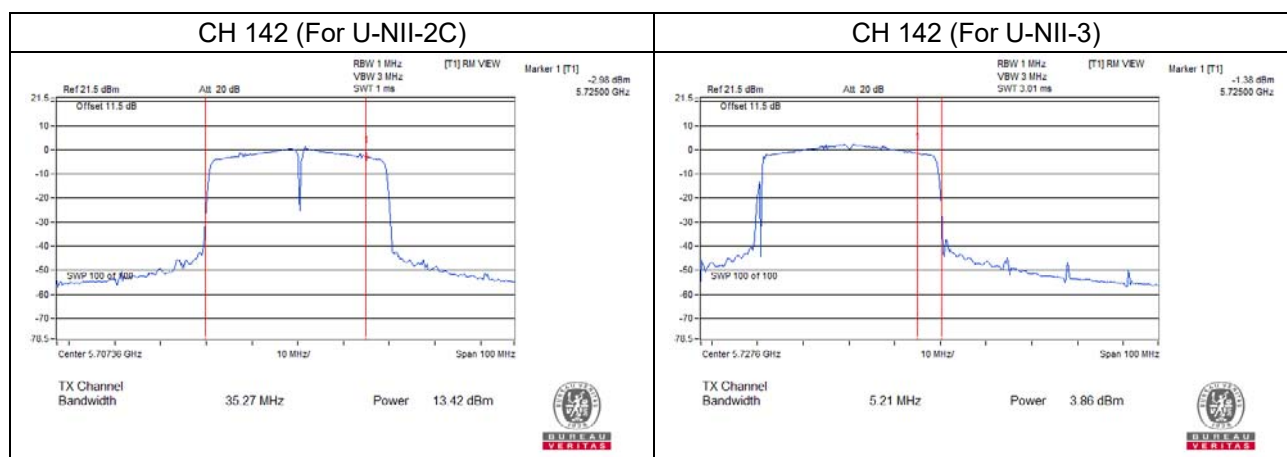

Chain 3

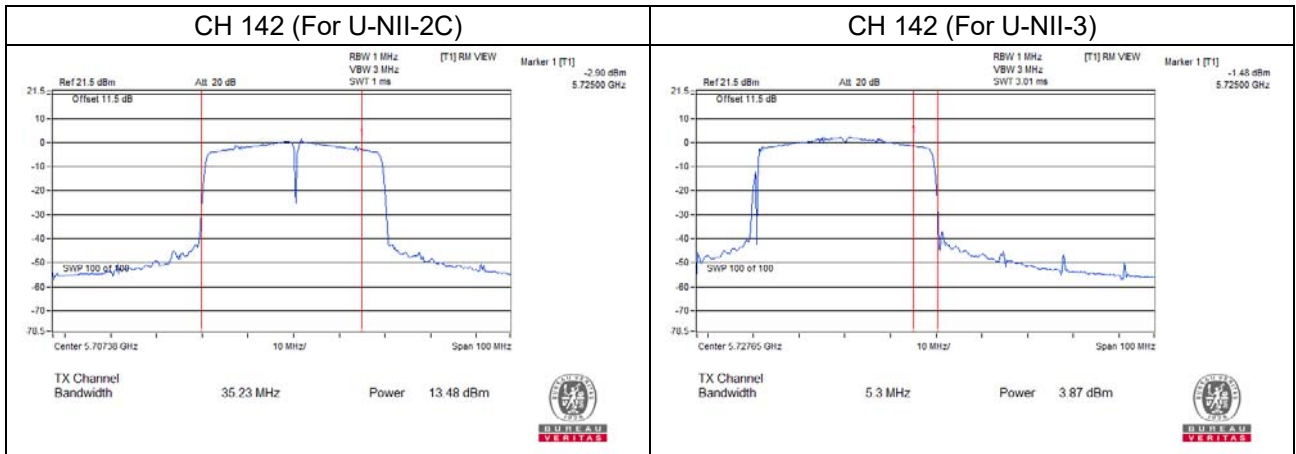

802.11ax (HE80)

Chain 0

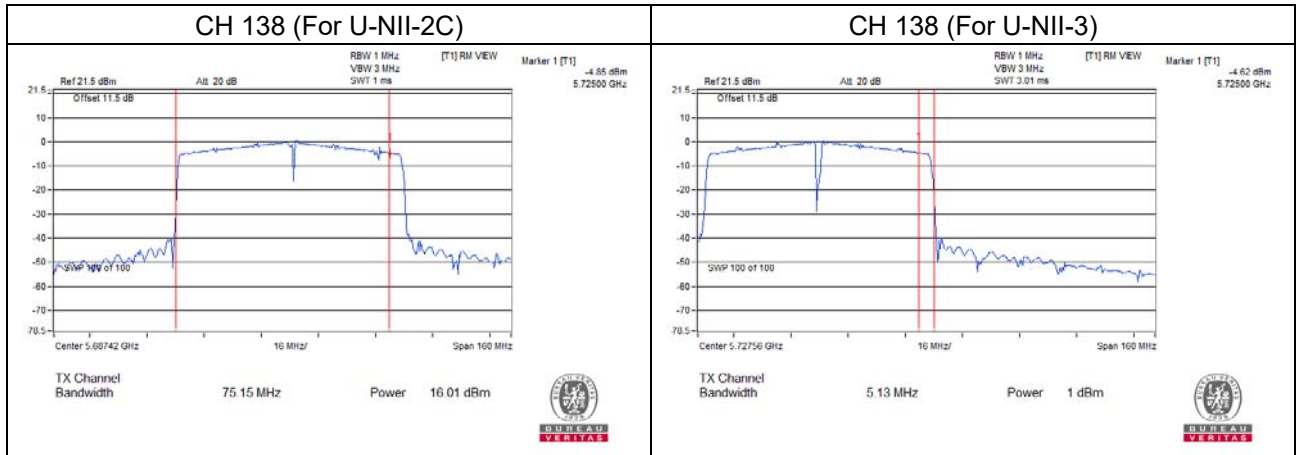

Chain 1

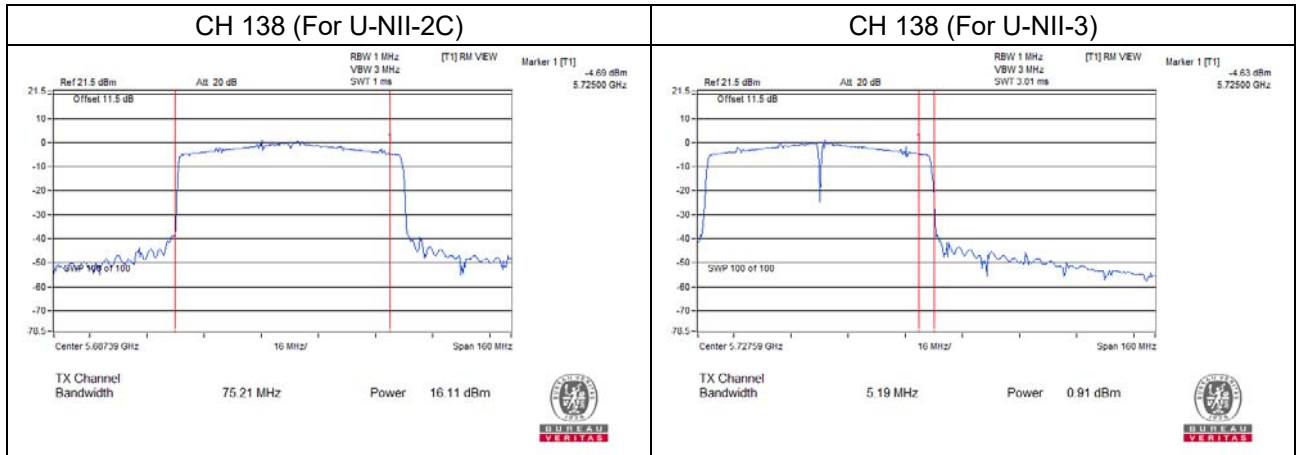

Chain 2

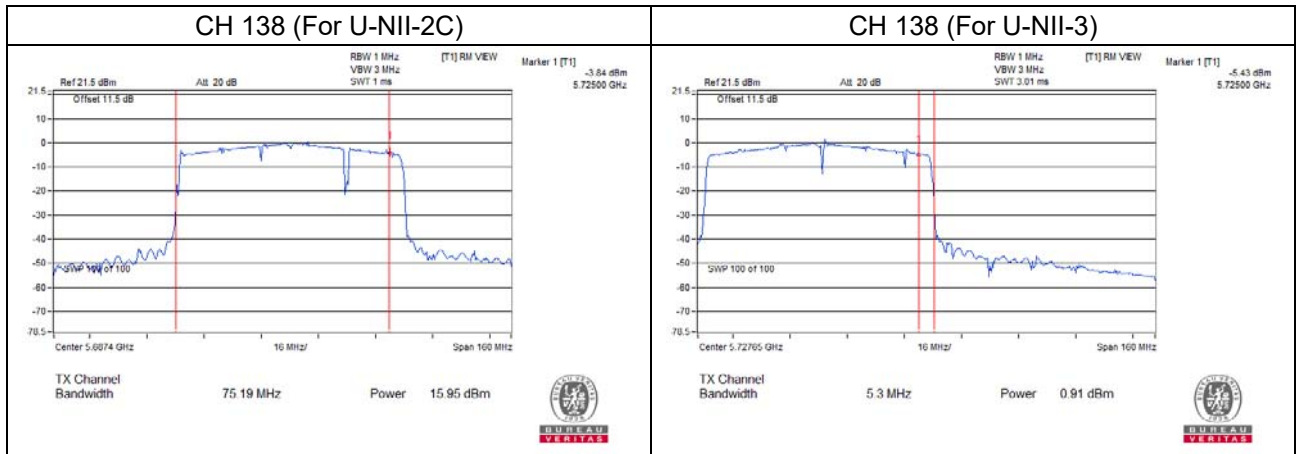

Chain 3

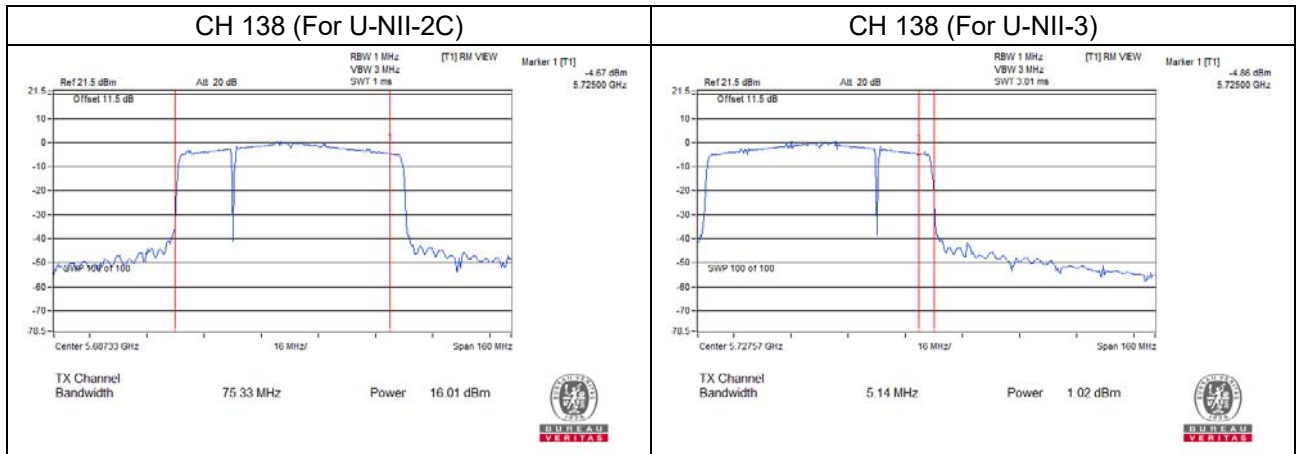

26dB Bandwidth:
802.11a

Channel	Frequency (MHz)	26dBc Bandwidth (MHz)			
		Chain 0	Chain 1	Chain 2	Chain 3
52	5260	20.42	20.35	20.41	20.45
60	5300	20.42	20.46	20.48	20.47
64	5320	20.41	20.41	20.51	20.54
100	5500	20.41	20.45	20.51	20.30
116	5580	20.52	20.46	20.44	20.45
140	5700	20.51	20.49	20.49	20.49
144	5720 (For U-NII-2C)	15.13	15.21	15.15	15.17

For CH144 (U-NII-2C Band): The 26dBc bandwidth below 5725MHz = 5725MHz - Marker 1

802.11ax (HE20)

Channel	Frequency (MHz)	26dBc Bandwidth (MHz)			
		Chain 0	Chain 1	Chain 2	Chain 3
52	5260	36.57	28.18	26.49	26.10
60	5300	36.66	24.59	24.57	26.42
64	5320	26.10	23.19	26.02	23.61
100	5500	25.49	24.87	24.59	27.09
116	5580	36.54	26.61	29.14	37.43
140	5700	23.64	24.81	26.68	26.61
144	5720 (For U-NII-2C)	18.45	20.67	20.79	19.30

For CH144 (U-NII-2C Band): The 26dBc bandwidth below 5725MHz = 5725MHz - Marker 1

802.11ax (HE40)

Channel	Frequency (MHz)	26dBc Bandwidth (MHz)			
		Chain 0	Chain 1	Chain 2	Chain 3
54	5270	40.75	40.72	40.68	40.72
62	5310	40.77	40.73	40.62	40.54
102	5510	40.87	40.68	40.59	40.65
110	5550	40.71	40.73	40.77	40.72
134	5670	40.81	40.72	40.70	40.76
142	5710 (For U-NII-2C)	35.15	35.19	35.27	35.23

For CH142 (U-NII-2C Band): The 26dBc bandwidth below 5725MHz = 5725MHz - Marker 1

802.11ax (HE80)

Channel	Frequency (MHz)	26dBc Bandwidth (MHz)			
		Chain 0	Chain 1	Chain 2	Chain 3
58	5290	80.89	81.03	81.04	81.20
106	5530	81.01	80.93	80.93	80.87
122	5610	81.19	81.01	81.19	81.18
138	5690 (For U-NII-2C)	75.15	75.21	75.19	75.33

For CH138 (U-NII-2C Band): The 26dBc bandwidth below 5725MHz = 5725MHz - Marker 1

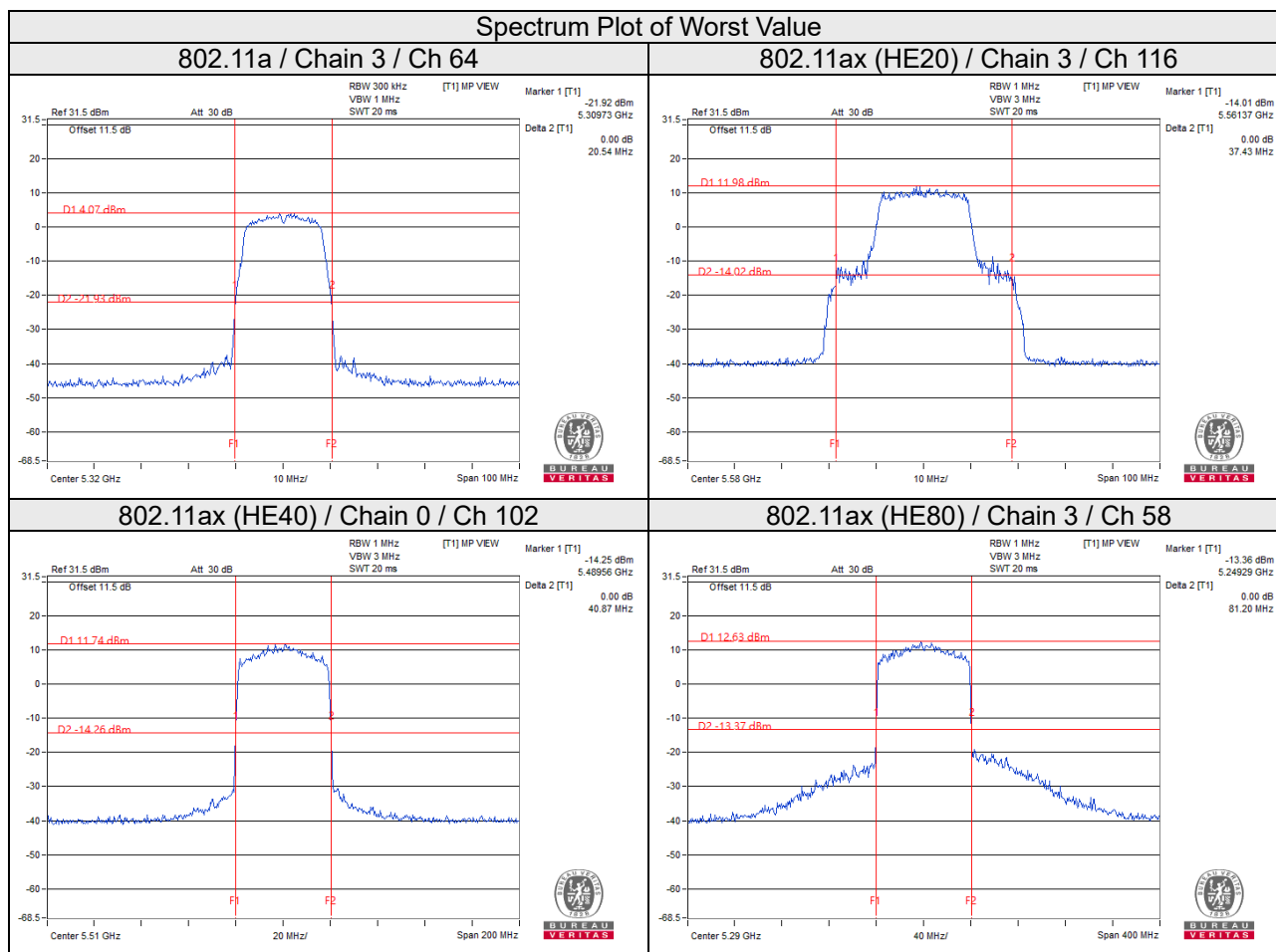

EUT Maximum Conducted Power

CDD Mode

802.11a

Frequency Band (MHz)	Max. Power	
	Output Power (mW)	Output Power (dBm)
5250~5350	74.660	18.73
5470~5725	60.775	17.84

802.11ax (HE20)

Frequency Band (MHz)	Max. Power	
	Output Power (mW)	Output Power (dBm)
5250~5350	81.493	19.11
5470~5725	66.413	18.22

802.11ax (HE40)

Frequency Band (MHz)	Max. Power	
	Output Power (mW)	Output Power (dBm)
5250~5350	135.573	21.32
5470~5725	108.044	20.34

802.11ax (HE80)

Frequency Band (MHz)	Max. Power	
	Output Power (mW)	Output Power (dBm)
5250~5350	210.448	23.23
5470~5725	182.159	22.60

Beamforming Mode

802.11ax (HE20)

Frequency Band (MHz)	Max. Power	
	Output Power (mW)	Output Power (dBm)
5250~5350	20.376	13.09
5470~5725	16.605	12.20

802.11ax (HE40)

Frequency Band (MHz)	Max. Power	
	Output Power (mW)	Output Power (dBm)
5250~5350	33.898	15.30
5470~5725	27.015	14.32

802.11ax (HE80)

Frequency Band (MHz)	Max. Power	
	Output Power (mW)	Output Power (dBm)
5250~5350	52.619	17.21
5470~5725	45.546	16.58

4.4 Occupied Bandwidth Measurement

4.4.1 Test Setup

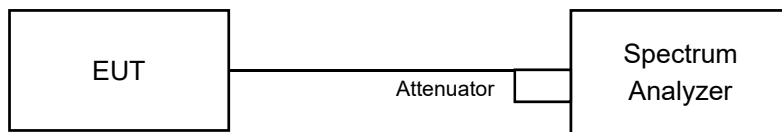

4.4.2 Test Instruments

Refer to section 4.1.2 to get information of above instrument.

4.4.3 Test Procedure

The transmitter output was connected to the spectrum analyzer through an attenuator. The bandwidth of the fundamental frequency was measured by spectrum analyzer with resolution bandwidth in the range of 1% to 5% of the anticipated emission bandwidth, and a video bandwidth at least 3x the resolution bandwidth and set the detector to sampling. The width of a frequency band such that, below the lower and above the upper frequency limits, the mean powers emitted are each equal to a specified percentage 0.5 % of the total mean power of a given emission.

4.4.4 Test Result

802.11a

Channel	Frequency (MHz)	Occupied Bandwidth (MHz)			
		Chain 0	Chain 1	Chain 2	Chain 3
52	5260	16.68	16.68	16.80	16.68
60	5300	16.68	16.68	16.68	16.68
64	5320	16.68	16.68	16.68	16.68
100	5500	16.80	16.68	16.80	16.68
116	5580	16.80	16.80	16.68	16.68
140	5700	16.68	16.68	16.80	16.80
144	5720 (For U-NII-2C)	13.52	13.40	13.40	13.40
144	5720 (For U-NII-3)	3.28	3.28	3.28	3.28

For CH144 (U-NII-2C Band): The Occupied bandwidth below 5725MHz = 5725MHz - Marker 1

For CH144 (UNII-3 Band): The Occupied bandwidth above 5725MHz = Marker 1 + Delta 2 - 5725MHz

802.11ax (HE20)

Channel	Frequency (MHz)	Occupied Bandwidth (MHz)			
		Chain 0	Chain 1	Chain 2	Chain 3
52	5260	19.20	19.08	19.08	19.08
60	5300	19.08	19.08	19.08	19.08
64	5320	19.20	19.20	19.08	19.20
100	5500	19.08	19.08	19.08	19.20
116	5580	19.20	19.08	19.20	19.08
140	5700	19.08	19.20	19.20	19.08
144	5720 (For U-NII-2C)	14.60	14.60	14.60	14.60
144	5720 (For U-NII-3)	4.48	4.48	4.48	4.48

For CH144 (U-NII-2C Band): The Occupied bandwidth below 5725MHz = 5725MHz - Marker 1

For CH144 (UNII-3 Band): The Occupied bandwidth above 5725MHz = Marker 1 + Delta 2 - 5725MHz

802.11ax (HE40)

Channel	Frequency (MHz)	Occupied Bandwidth (MHz)			
		Chain 0	Chain 1	Chain 2	Chain 3
54	5270	37.56	37.80	37.68	37.68
62	5310	37.80	37.56	37.56	37.68
102	5510	37.68	37.56	37.56	37.80
110	5550	37.68	37.80	37.80	37.68
134	5670	37.56	37.68	37.56	37.68
142	5710 (For U-NII-2C)	33.96	33.84	33.84	33.84
142	5710 (For U-NII-3)	3.84	3.84	3.72	3.72

For CH142 (U-NII-2C Band): The Occupied bandwidth below 5725MHz = 5725MHz - Marker 1

For CH142 (UNII-3 Band): The Occupied bandwidth above 5725MHz = Marker 1 + Delta 2 - 5725MHz

802.11ax (HE80)

Channel	Frequency (MHz)	Occupied Bandwidth (MHz)			
		Chain 0	Chain 1	Chain 2	Chain 3
58	5290	76.56	76.80	76.56	76.56
106	5530	76.80	76.80	76.80	76.80
122	5610	76.56	76.80	76.80	76.80
138	5690 (For U-NII-2C)	73.64	73.40	73.40	73.64
138	5690 (For U-NII-3)	3.16	3.16	3.40	3.40

For CH138 (U-NII-2C Band): The Occupied bandwidth below 5725MHz = 5725MHz - Marker 1

For CH138 (UNII-3 Band): The Occupied bandwidth above 5725MHz = Marker 1 + Delta 2 - 5725MHz

Spectrum Plot of Worst Value

802.11a

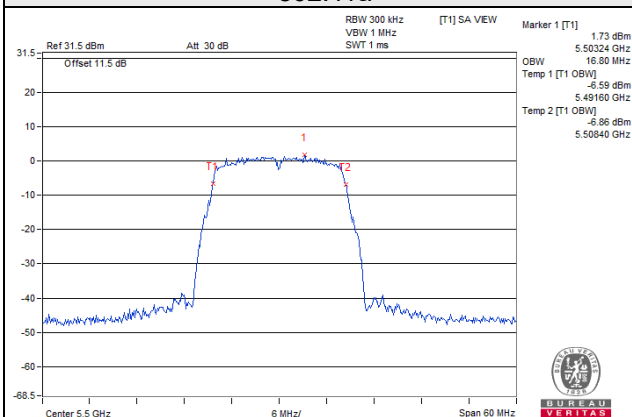

802.11ax (HE20)

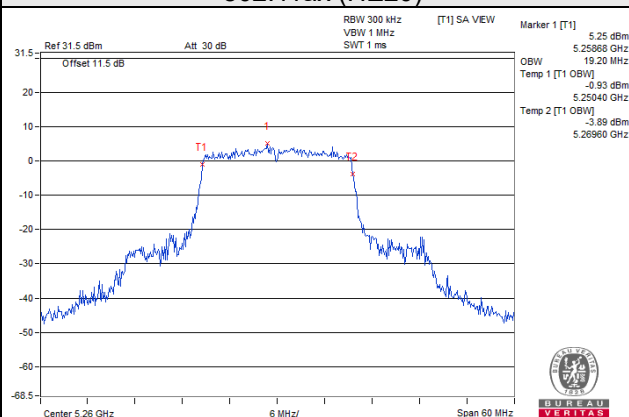

802.11ax (HE40)

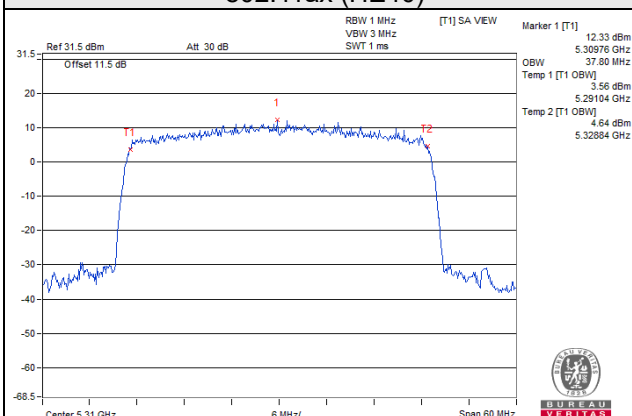

802.11ax (HE80)

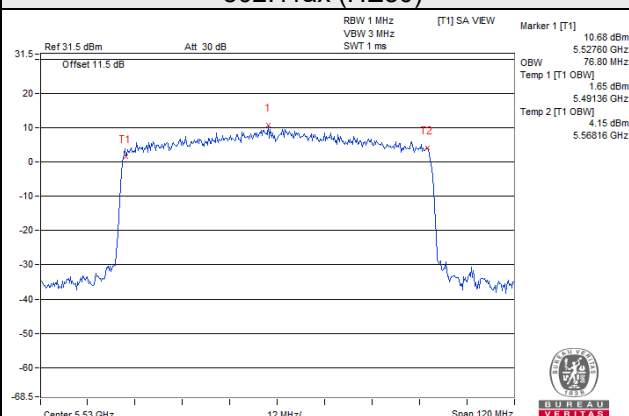

4.5 Peak Power Spectral Density Measurement

4.5.1 Limits of Peak Power Spectral Density Measurement

Operation Band	EUT Category		Limit
U-NII-1		Outdoor Access Point	17dBm/ MHz
		Fixed point-to-point Access Point	
		Indoor Access Point	
		Mobile and Portable client device	11dBm/ MHz
U-NII-2A	√		11dBm/ MHz
U-NII-2C	√		11dBm/ MHz
U-NII-3	√		30dBm/ 500kHz

4.5.2 Test Setup

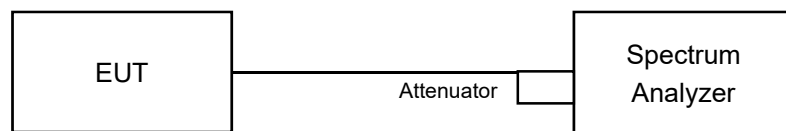

4.5.3 Test Instruments

Refer to section 4.1.2 to get information of above instrument.

4.5.4 Test Procedures

For U-NII-2A, U-NII-2C band:

Duty cycle of test signal is < 98%

Using method SA-2

- 1) Set span to encompass the entire emission bandwidth (EBW) of the signal.
- 2) Set RBW = 1MHz, Set VBW ≥ 3 MHz, Detector = RMS
- 3) Set Channel power measure = 1MHz
- 4) Sweep time = auto, trigger set to "free run".
- 5) Trace average at least 100 traces in power averaging mode.
- 6) Record the max value and add 10 log (1/duty cycle)

4.5.5 Deviation from Test Standard

No deviation.

4.5.6 EUT Operating Conditions

Same as 4.3.6.

4.5.7 Test Results

For U-NII-2A, U-NII-2C band:
802.11a

Chan.	Freq. (MHz)	PSD W/O Duty Factor (dBm/MHz)				Duty Factor (dB)	Total PSD With Duty Factor (dBm/MHz)	Max. Limit (dBm/MHz)	Pass / Fail
		Chain 0	Chain 1	Chain 2	Chain 3				
52	5260	-0.34	-0.67	0.05	-0.12	0.86	6.62	6.82	Pass
60	5300	0.19	-0.27	-0.81	-0.24	0.86	6.61	6.82	Pass
64	5320	0.10	-0.14	-0.43	-0.03	0.86	6.76	6.82	Pass
100	5500	-1.41	-1.00	-1.01	-1.48	0.86	5.66	5.80	Pass
116	5580	-1.70	-1.11	-1.06	-1.08	0.86	5.65	5.80	Pass
140	5700	-0.98	-1.54	-1.44	-1.70	0.86	5.47	5.80	Pass
144	5720 (For U-NII-2C)	-0.91	-1.41	-1.34	-1.71	0.86	5.54	5.80	Pass

Note:

- Method E) 2) a) of power density measurement of KDB 662911 is using for calculating total power density. Total power density is summing entire spectra across corresponding frequency bins on the various outputs by computer.
- For U-NII-2A: Directional Gain = $10 \log[(10^{G1/20} + 10^{G2/20} + \dots + 10^{GN/20})^2/4] = 10.18\text{dBi} > 6\text{dBi}$, so the limit shall be reduced to $11 - (10.18 - 6) = 6.82\text{dBm}$.
For U-NII-2C: Directional Gain = $10 \log[(10^{G1/20} + 10^{G2/20} + \dots + 10^{GN/20})^2/4] = 11.20\text{dBi} > 6\text{dBi}$, so the limit shall be reduced to $11 - (11.20 - 6) = 5.80\text{dBm}$.
- Refer to section 3.3 for duty cycle spectrum plot.

802.11ax (HE20)

Chan.	Freq. (MHz)	PSD W/O Duty Factor (dBm/MHz)				Duty Factor (dB)	Total PSD With Duty Factor (dBm/MHz)	Max. Limit (dBm/MHz)	Pass / Fail
		Chain 0	Chain 1	Chain 2	Chain 3				
52	5260	-0.12	-0.50	-0.24	-0.50	0.89	6.57	6.82	Pass
60	5300	0.08	-0.07	-0.32	-0.30	0.89	6.76	6.82	Pass
64	5320	-0.06	0.02	-0.07	-0.35	0.89	6.80	6.82	Pass
100	5500	-1.69	-1.08	-0.86	-1.07	0.89	5.75	5.80	Pass
116	5580	-1.12	-1.17	-0.91	-1.39	0.89	5.77	5.80	Pass
140	5700	-1.07	-1.01	-1.93	-0.62	0.89	5.78	5.80	Pass
144	5720 (For U-NII-2C)	-1.66	-0.88	-1.05	-1.18	0.89	5.73	5.80	Pass

Note:

- Method E) 2) a) of power density measurement of KDB 662911 is using for calculating total power density. Total power density is summing entire spectra across corresponding frequency bins on the various outputs by computer.
- For U-NII-2A: Directional Gain = $10 \log[(10^{G1/20} + 10^{G2/20} + \dots + 10^{GN/20})^2/4] = 10.18\text{dBi} > 6\text{dBi}$, so the limit shall be reduced to $11 - (10.18 - 6) = 6.82\text{dBm}$.
For U-NII-2C: Directional Gain = $10 \log[(10^{G1/20} + 10^{G2/20} + \dots + 10^{GN/20})^2/4] = 11.20\text{dBi} > 6\text{dBi}$, so the limit shall be reduced to $11 - (11.20 - 6) = 5.80\text{dBm}$.
- Refer to section 3.3 for duty cycle spectrum plot.

802.11ax (HE40)

Chan.	Freq. (MHz)	PSD W/O Duty Factor (dBm/MHz)				Duty Factor (dB)	Total PSD With Duty Factor (dBm/MHz)	Max. Limit (dBm/MHz)	Pass / Fail
		Chain 0	Chain 1	Chain 2	Chain 3				
54	5270	-0.84	-0.99	-1.15	-0.89	1.40	6.46	6.82	Pass
62	5310	-1.14	-0.76	-0.84	-0.64	1.40	6.58	6.82	Pass
102	5510	-1.55	-1.93	-1.98	-1.81	1.40	5.61	5.80	Pass
110	5550	-2.33	-2.33	-1.21	-2.10	1.40	5.46	5.80	Pass
134	5670	-2.36	-2.19	-1.90	-1.53	1.40	5.44	5.80	Pass
142	5710 (For U-NII-2C)	-1.74	-2.39	-1.89	-1.88	1.40	5.46	5.80	Pass

Note:

- Method E) 2) a) of power density measurement of KDB 662911 is using for calculating total power density. Total power density is summing entire spectra across corresponding frequency bins on the various outputs by computer.
- For U-NII-2A: Directional Gain = $10 \log[(10^{G1/20} + 10^{G2/20} + \dots + 10^{GN/20})^2/4] = 10.18\text{dBi} > 6\text{dBi}$, so the limit shall be reduced to $11 - (10.18 - 6) = 6.82\text{dBm}$.
For U-NII-2C: Directional Gain = $10 \log[(10^{G1/20} + 10^{G2/20} + \dots + 10^{GN/20})^2/4] = 11.20\text{dBi} > 6\text{dBi}$, so the limit shall be reduced to $11 - (11.20 - 6) = 5.80\text{dBm}$.
- Refer to section 3.3 for duty cycle spectrum plot.

802.11ax (HE80)

Chan.	Freq. (MHz)	PSD W/O Duty Factor (dBm/MHz)				Duty Factor (dB)	Total PSD With Duty Factor (dBm/MHz)	Max. Limit (dBm/MHz)	Pass / Fail
		Chain 0	Chain 1	Chain 2	Chain 3				
58	5290	-1.99	-1.65	-1.83	-1.80	2.27	6.48	6.82	Pass
106	5530	-2.53	-2.85	-2.75	-2.75	2.27	5.58	5.80	Pass
122	5610	-2.66	-2.01	-2.62	-2.78	2.27	5.79	5.80	Pass
138	5690 (For U-NII-2C)	-2.87	-2.27	-2.51	-2.51	2.27	5.76	5.80	Pass

Note:

- Method E) 2) a) of power density measurement of KDB 662911 is using for calculating total power density. Total power density is summing entire spectra across corresponding frequency bins on the various outputs by computer.
- For U-NII-2A: Directional Gain = $10 \log[(10^{G1/20} + 10^{G2/20} + \dots + 10^{GN/20})^2/4] = 10.18\text{dBi} > 6\text{dBi}$, so the limit shall be reduced to $11 - (10.18 - 6) = 6.82\text{dBm}$.
For U-NII-2C: Directional Gain = $10 \log[(10^{G1/20} + 10^{G2/20} + \dots + 10^{GN/20})^2/4] = 11.20\text{dBi} > 6\text{dBi}$, so the limit shall be reduced to $11 - (11.20 - 6) = 5.80\text{dBm}$.
- Refer to section 3.3 for duty cycle spectrum plot.

Spectrum Plot of Worst Value

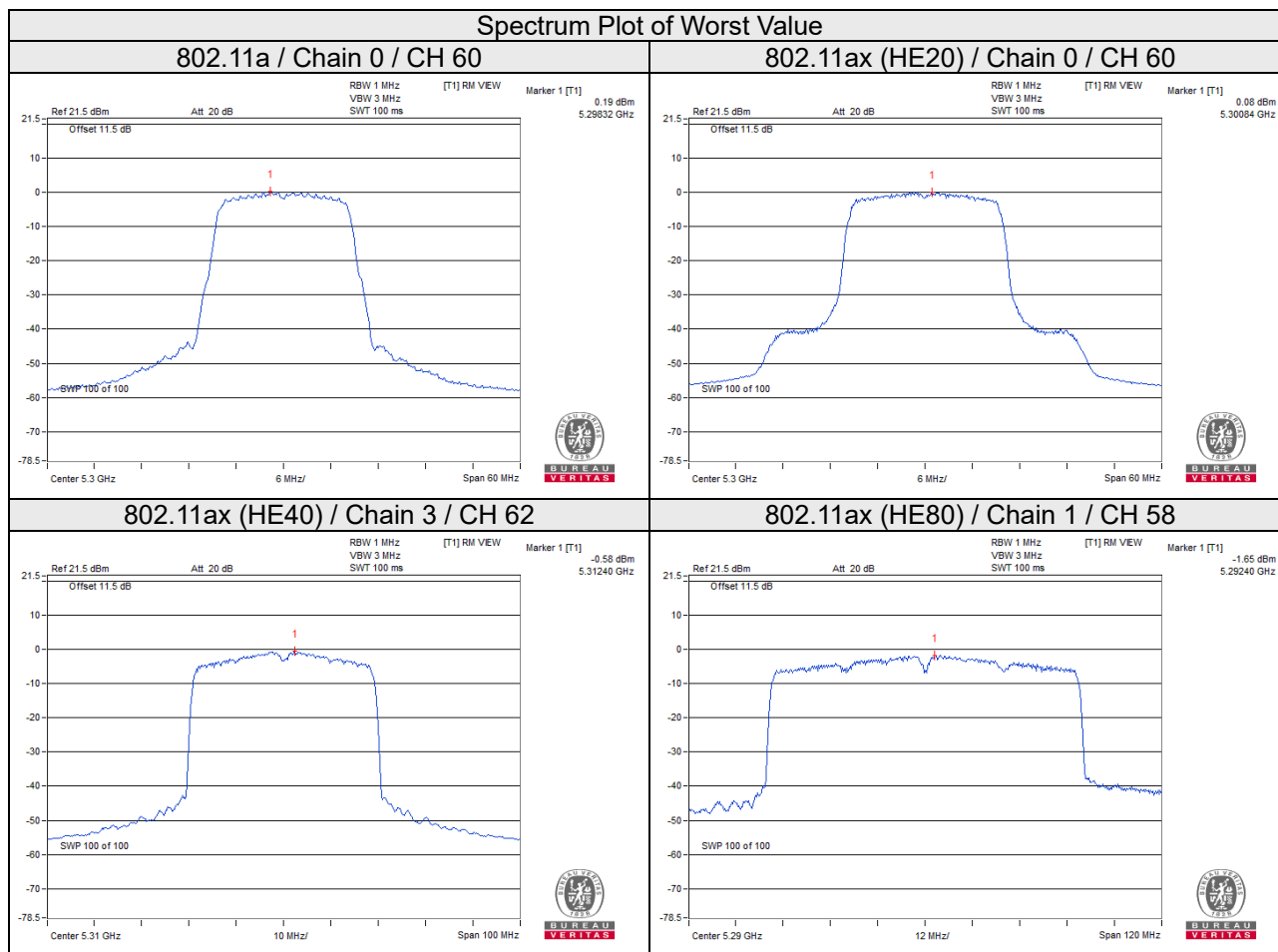

For U-NII-3 band

802.11a

TX chain	Chan.	Freq. (MHz)	PSD w/o Duty Factor		10 log (N=4) dB	Duty Factor (dB)	Total PSD with Duty Factor (dBm/500kHz)	Limit (dBm/500kHz)	Pass / Fail
			(dBm/300kHz)	(dBm/500kHz)					
0	144	5720 (For U-NII-3)	-7.36	-5.14	6.02	0.86	1.74	24.75	Pass
1	144	5720 (For U-NII-3)	-8.25	-6.03	6.02	0.86	0.85	24.75	Pass
2	144	5720 (For U-NII-3)	-8.03	-5.81	6.02	0.86	1.07	24.75	Pass
3	144	5720 (For U-NII-3)	-7.80	-5.58	6.02	0.86	1.30	24.75	Pass

Note:

- Method E) 2) c) of power density measurement of KDB 662911 is using for calculating total power density, Measure and add 10 log (N_{ANT}) dB.
- For U-NII-3: Directional Gain = 10 log[(10^{G₁/20} + 10^{G₂/20} + ... + 10^{G_N/20})²/4]=11.25dBi > 6dBi, so the limit shall be reduced to 30-(11.25-6) = 24.75dBm.
- Refer to section 3.3 for duty cycle spectrum plot.

802.11ax (HE20)

TX chain	Chan.	Freq. (MHz)	PSD w/o Duty Factor		10 log (N=4) dB	Duty Factor (dB)	Total PSD with Duty Factor (dBm/500kHz)	Limit (dBm/500kHz)	Pass / Fail
			(dBm/300kHz)	(dBm/500kHz)					
0	144	5720 (For U-NII-3)	-7.21	-4.99	6.02	0.89	1.92	24.75	Pass
1	144	5720 (For U-NII-3)	-6.93	-4.71	6.02	0.89	2.20	24.75	Pass
2	144	5720 (For U-NII-3)	-6.98	-4.76	6.02	0.89	2.15	24.75	Pass
3	144	5720 (For U-NII-3)	-6.89	-4.67	6.02	0.89	2.24	24.75	Pass

Note:

- Method E) 2) c) of power density measurement of KDB 662911 is using for calculating total power density, Measure and add 10 log (N_{ANT}) dB.
- For U-NII-3: Directional Gain = 10 log[(10^{G₁/20} + 10^{G₂/20} + ... + 10^{G_N/20})²/4]=11.25dBi > 6dBi, so the limit shall be reduced to 30-(11.25-6) = 24.75dBm.
- Refer to section 3.3 for duty cycle spectrum plot.

802.11ax (HE40)

TX chain	Chan.	Freq. (MHz)	PSD w/o Duty Factor		10 log (N=4) dB	Duty Factor (dB)	Total PSD with Duty Factor (dBm/500kHz)	Limit (dBm/500kHz)	Pass / Fail
			(dBm/300kHz)	(dBm/500kHz)					
0	142	5710 (For U-NII-3)	-8.84	-6.62	6.02	1.40	0.80	24.75	Pass
1	142	5710 (For U-NII-3)	-9.11	-6.89	6.02	1.40	0.53	24.75	Pass
2	142	5710 (For U-NII-3)	-8.96	-6.74	6.02	1.40	0.68	24.75	Pass
3	142	5710 (For U-NII-3)	-8.94	-6.72	6.02	1.40	0.70	24.75	Pass

Note:

- Method E) 2) c) of power density measurement of KDB 662911 is using for calculating total power density, Measure and add 10 log (N_{ANT}) dB.
- For U-NII-3: Directional Gain = 10 log[(10^{G₁/20} + 10^{G₂/20} + ... + 10^{G_N/20})²/4]=11.25dBi > 6dBi, so the limit shall be reduced to 30-(11.25-6) = 24.75dBm.
- Refer to section 3.3 for duty cycle spectrum plot.

802.11ax (HE80)

TX chain	Chan.	Freq. (MHz)	PSD w/o Duty Factor		10 log (N=4) dB	Duty Factor (dB)	Total PSD with Duty Factor (dBm/500kHz)	Limit (dBm/500kHz)	Pass / Fail
			(dBm/300kHz)	(dBm/500kHz)					
0	138	5690 (For U-NII-3)	-10.99	-8.77	6.02	2.27	-0.48	24.75	Pass
1	138	5690 (For U-NII-3)	-10.63	-8.41	6.02	2.27	-0.12	24.75	Pass
2	138	5690 (For U-NII-3)	-10.94	-8.72	6.02	2.27	-0.43	24.75	Pass
3	138	5690 (For U-NII-3)	-10.25	-8.03	6.02	2.27	0.26	24.75	Pass

Note:

- Method E) 2) c) of power density measurement of KDB 662911 is using for calculating total power density, Measure and add 10 log (N_{ANT}) dB.
- For U-NII-3: Directional Gain = 10 log[(10^{G1/20} + 10^{G2/20} + ... + 10^{GN/20})²/4]=11.25dBi > 6dBi, so the limit shall be reduced to 30-(11.25-6) = 24.75dBm.
- Refer to section 3.3 for duty cycle spectrum plot.

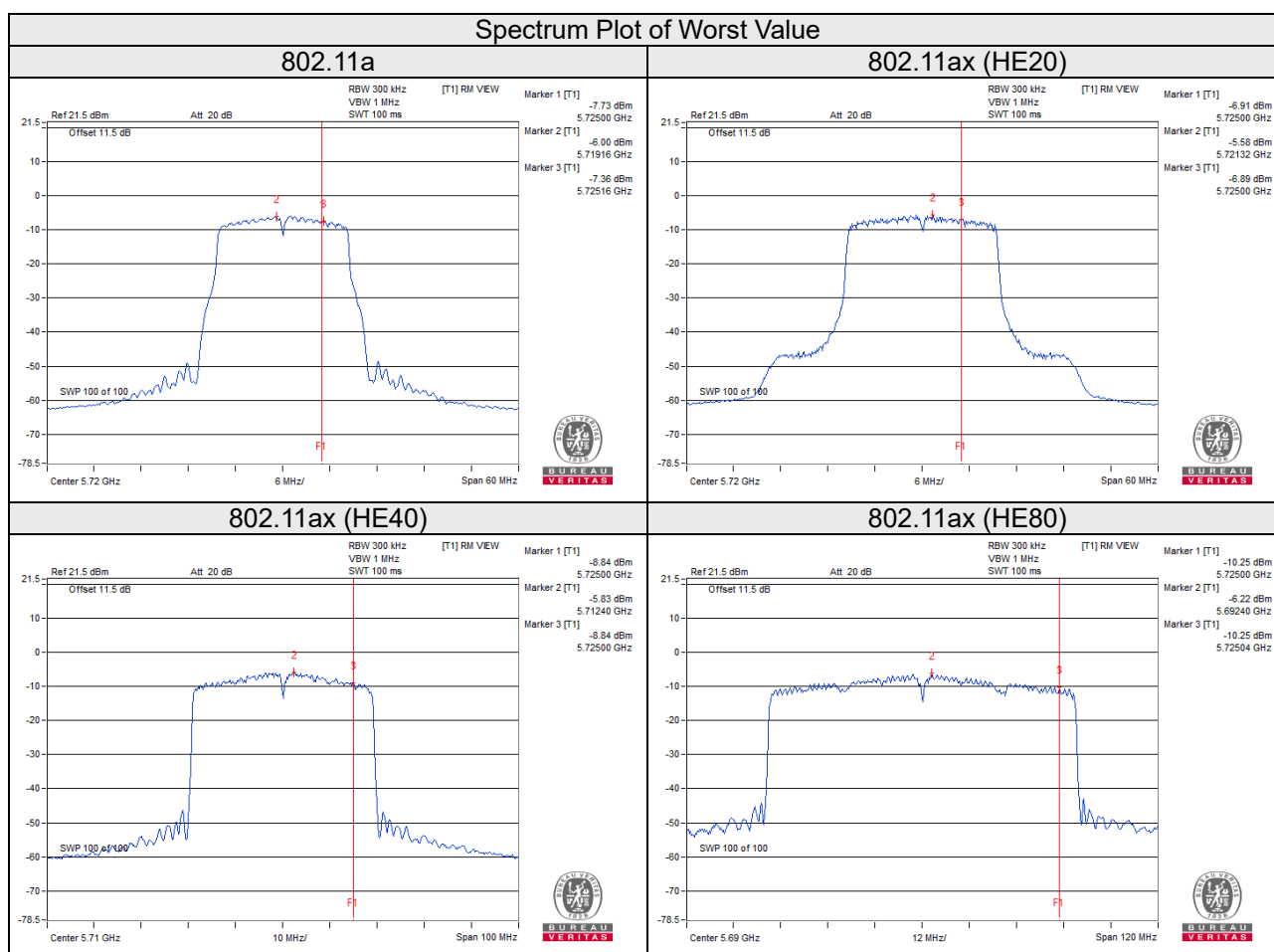

4.6 Frequency Stability

4.6.1 Limits of Frequency Stability Measurement

The frequency of the carrier signal shall be maintained within band of operation

4.6.2 Test Setup

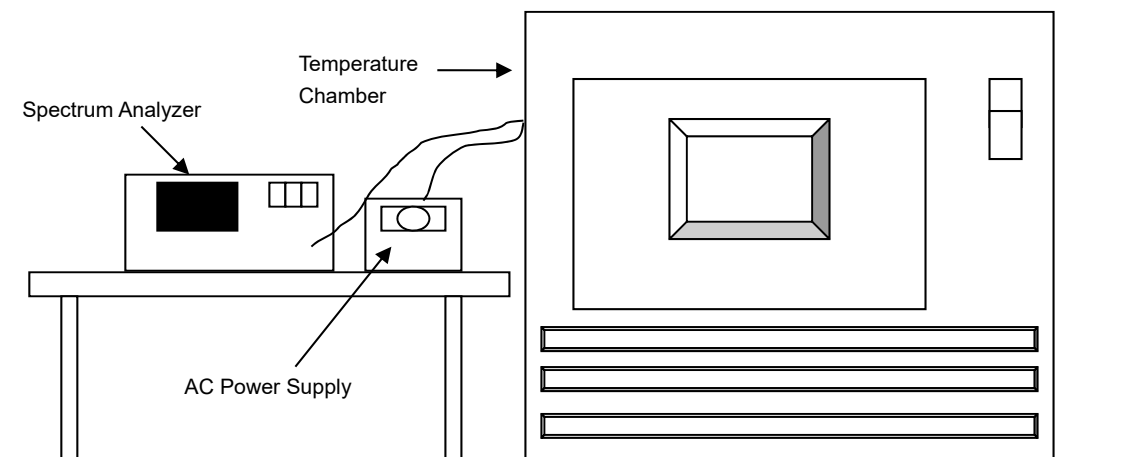

4.6.3 Test Instruments

Description & Manufacturer	Model No.	Serial No.	Cal. Date	Cal. Due
Spectrum Analyzer ROHDE & SCHWARZ	FSP40	100039	Jun. 12, 2020	Jun. 11, 2021
Standard Temperature And Humidity Chamber GIANT FORCE	GTH-120-40-CP-AR	MAA1306-019	Sep. 09, 2020	Sep. 08, 2021
Digital Multimeter Fluke	87-III	70360742	Jun. 23, 2020	Jun. 22, 2021
AC Power Supply Exttech	CFW-105	E000603	NA	NA

Note: 1. The calibration interval of the above test instruments is 12 months and the calibrations are traceable to NML/ROC and NIST/USA.

2. Tested date: Jun. 02, 2021

4.6.4 Test Procedure

- The EUT was placed inside the environmental test chamber and powered by nominal AC voltage.
- Turn the EUT on and couple its output to a spectrum analyzer.
- Turn the EUT off and set the chamber to the highest temperature specified.
- Allow sufficient time (approximately 30 min) for the temperature of the chamber to stabilize, turn the EUT on and measure the operating frequency after 2, 5, and 10 minutes.
- Repeat step (d) with the temperature chamber set to the next desired temperature until measurements down to the lowest specified temperature have been completed.
- The test chamber was allowed to stabilize at +20 degree C for a minimum of 30 minutes. The supply voltage was then adjusted on the EUT from 85% to 115% and the frequency record.

4.6.5 Deviation from Test Standard

No deviation.

4.6.6 EUT Operating Condition

Set the EUT transmit at un-modulation mode to test frequency stability.

4.6.7 Test Results

Frequency Stability Versus Temp.									
Operating Frequency: 5260MHz									
Temp. (°C)	Power Supply (Vac)	0 Minute		2 Minute		5 Minute		10 Minute	
		Measured Frequency (MHz)	Result	Measured Frequency (MHz)	Result	Measured Frequency (MHz)	Result	Measured Frequency (MHz)	Result
40	120	5260.0009	PASS	5260.0017	PASS	5260.0001	PASS	5260.0007	PASS
30	120	5260.0162	PASS	5260.0116	PASS	5260.0114	PASS	5260.0113	PASS
20	120	5260.0097	PASS	5260.0110	PASS	5260.0075	PASS	5260.0123	PASS
10	120	5260.0232	PASS	5260.0228	PASS	5260.0239	PASS	5260.0230	PASS
0	120	5260.0138	PASS	5260.0125	PASS	5260.0147	PASS	5260.0164	PASS

Frequency Stability Versus Voltage									
Operating Frequency: 5260MHz									
Temp. (°C)	Power Supply (Vac)	0 Minute		2 Minute		5 Minute		10 Minute	
		Measured Frequency (MHz)	Result	Measured Frequency (MHz)	Result	Measured Frequency (MHz)	Result	Measured Frequency (MHz)	Result
20	138	5260.0090	PASS	5260.0113	PASS	5260.0081	PASS	5260.0128	PASS
	120	5260.0097	PASS	5260.0110	PASS	5260.0075	PASS	5260.0123	PASS
	102	5260.0100	PASS	5260.0108	PASS	5260.0081	PASS	5260.0127	PASS

4.7 6dB Bandwidth Measurement

4.7.1 Limits of 6dB Bandwidth Measurement

The minimum of 6dB Bandwidth Measurement is 0.5MHz.

4.7.2 Test Setup

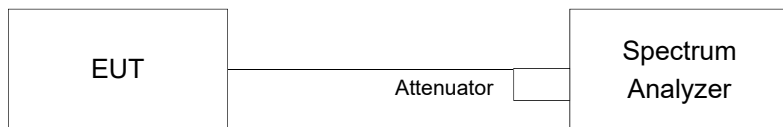

4.7.3 Test Instruments

Refer to section 4.1.2 to get information of above instrument.

4.7.4 Test Procedure

- Set resolution bandwidth (RBW) = 100kHz
- Set the video bandwidth (VBW) $\geq 3 \times$ RBW, Detector = Peak.
- Trace mode = max hold.
- Sweep = auto couple.
- Measure the maximum width of the emission that is constrained by the frequencies associated with the two amplitude points (upper and lower) that are attenuated by 6 dB relative to the maximum level measured in the fundamental emission

4.7.5 Deviation from Test Standard

No deviation.

4.7.6 EUT Operating Condition

The software provided by client to enable the EUT under transmission condition continuously at lowest, middle and highest channel frequencies individually.

4.7.7 Test Results

802.11a

Channel	Frequency (MHz)	6dB Bandwidth (MHz)				Minimum Limit (MHz)	Pass / Fail
		Chain 0	Chain 1	Chain 2	Chain 3		
144	5720 (For U-NII-3)	2.92	2.92	3.15	2.91	0.5	Pass

802.11ax (HE20)

Channel	Frequency (MHz)	6dB Bandwidth (MHz)				Minimum Limit (MHz)	Pass / Fail
		Chain 0	Chain 1	Chain 2	Chain 3		
144	5720 (For U-NII-3)	4.47	4.43	4.47	4.47	0.5	Pass

802.11ax (HE40)

Channel	Frequency (MHz)	6dB Bandwidth (MHz)				Minimum Limit (MHz)	Pass / Fail
		Chain 0	Chain 1	Chain 2	Chain 3		
142	5710 (For U-NII-3)	3.04	2.67	2.64	2.64	0.5	Pass

802.11ax (HE80)

Channel	Frequency (MHz)	6dB Bandwidth (MHz)				Minimum Limit (MHz)	Pass / Fail
		Chain 0	Chain 1	Chain 2	Chain 3		
138	5690 (For U-NII-3)	2.70	2.71	2.73	2.69	0.5	Pass

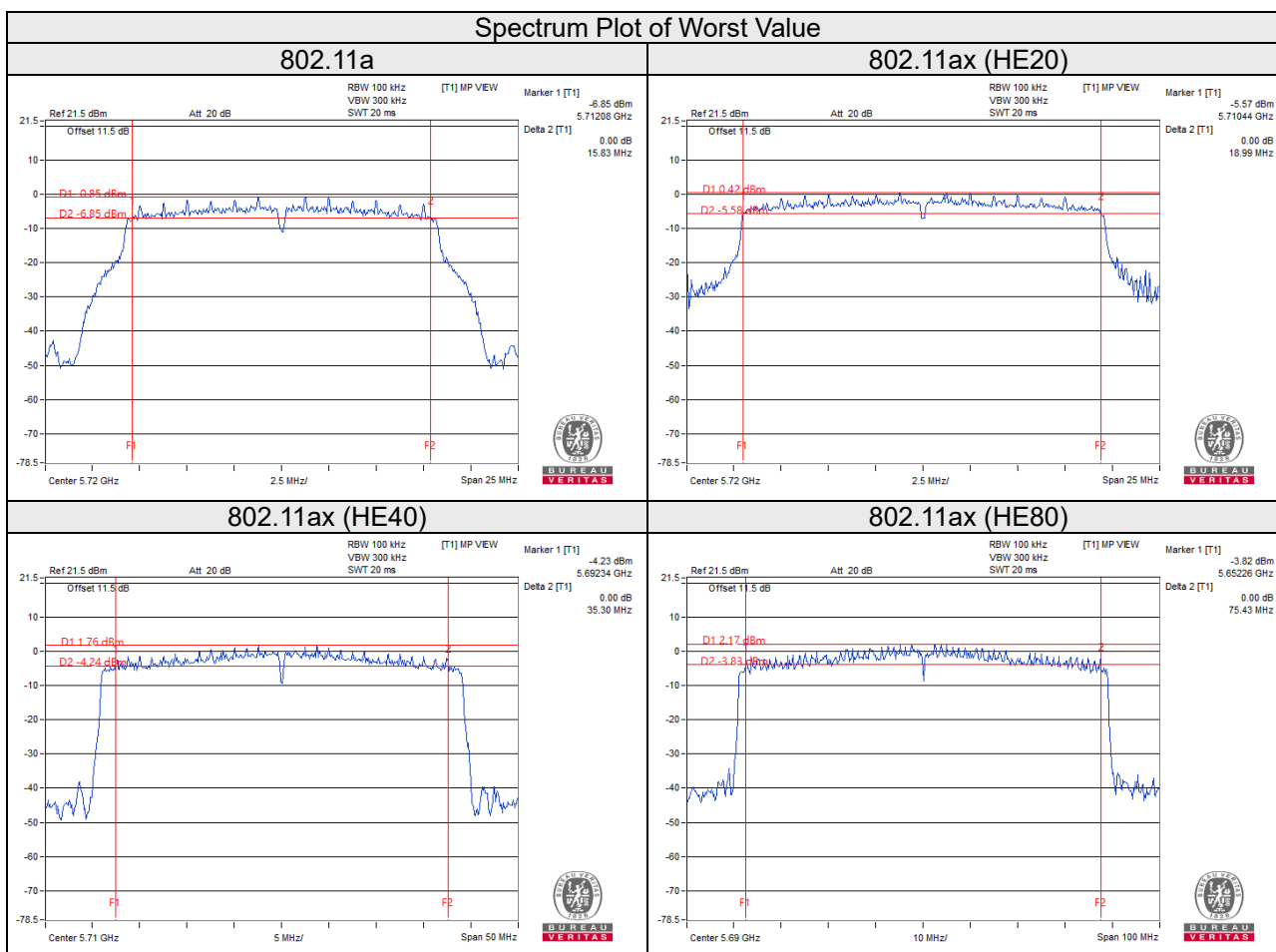

Note:

For CH144 (UNII-3 Band): The 6dB bandwidth above 5725MHz = Marker 1 + Delta 2 - 5725MHz

For CH142 (UNII-3 Band): The 6dB bandwidth above 5725MHz = Marker 1 + Delta 2 - 5725MHz

For CH138 (UNII-3 Band): The 6dB bandwidth above 5725MHz = Marker 1 + Delta 2 - 5725MHz

5 Pictures of Test Arrangements

Please refer to the attached file (Test Setup Photo).

Annex A- Band Edge Measurement

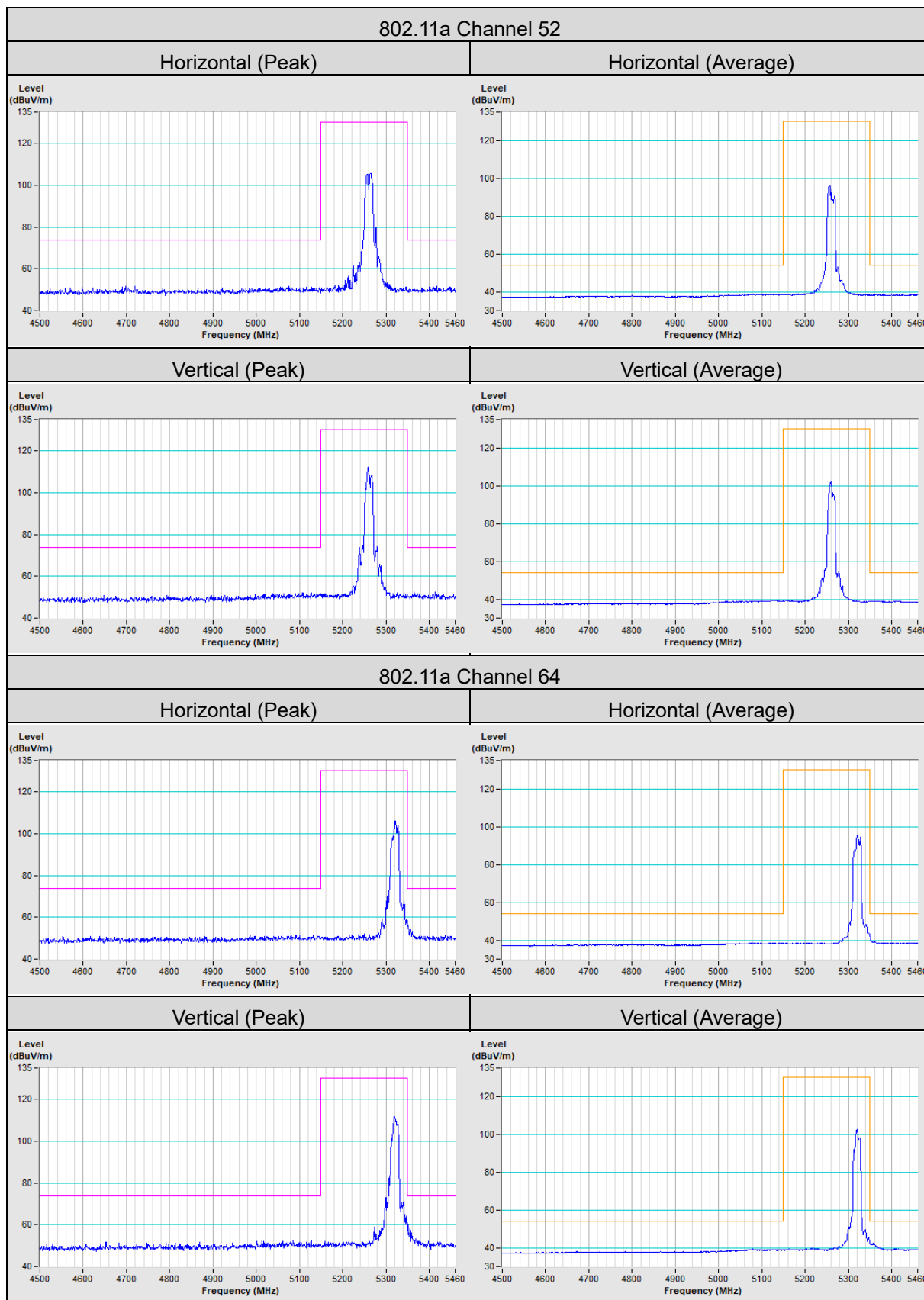

802.11a Channel 100

Horizontal (Peak)	Horizontal (Average)
-------------------	----------------------

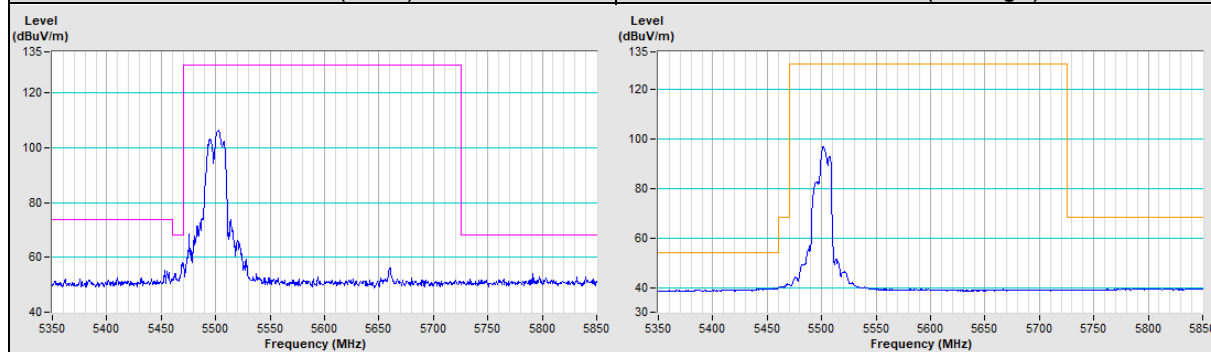

Vertical (Peak)	Vertical (Average)
-----------------	--------------------

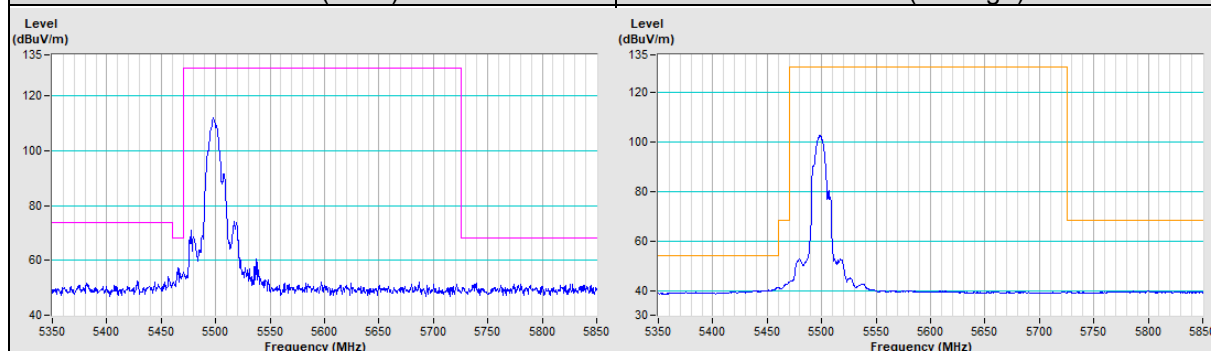

802.11a Channel 140

Horizontal (Peak)	Vertical (Peak)
-------------------	-----------------

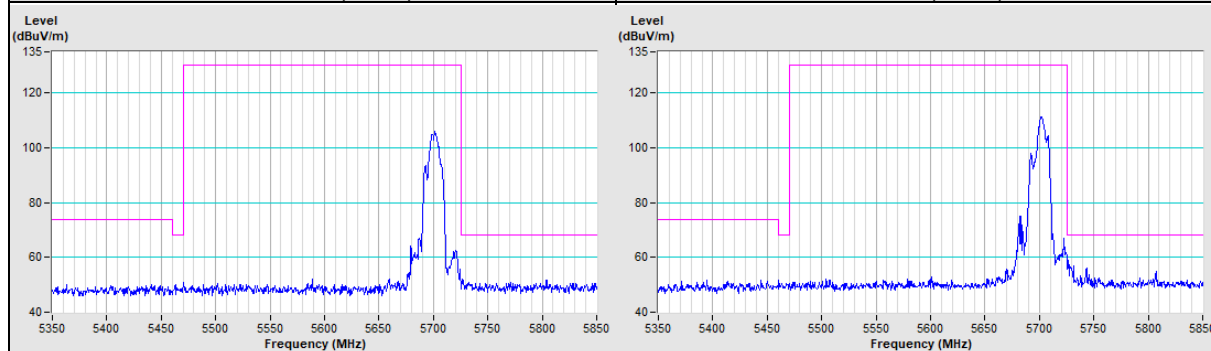

802.11a Channel 144

Horizontal (Peak)	Vertical (Peak)
-------------------	-----------------

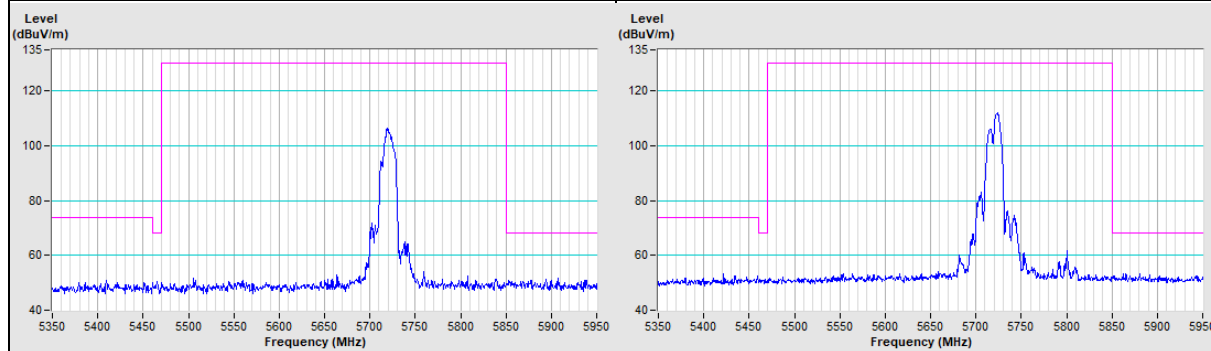

802.11ax (HE20) Channel 52

Horizontal (Peak)	Horizontal (Average)
--------------------------	-----------------------------

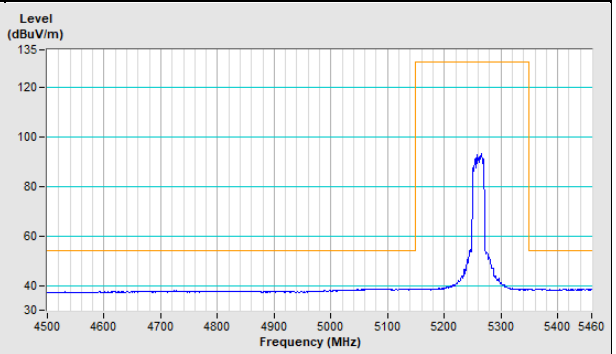
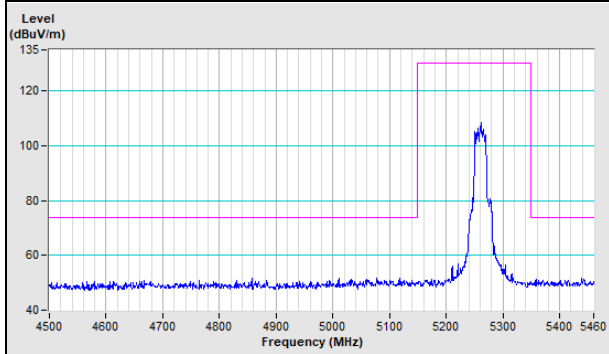

Vertical (Peak)	Vertical (Average)
------------------------	---------------------------

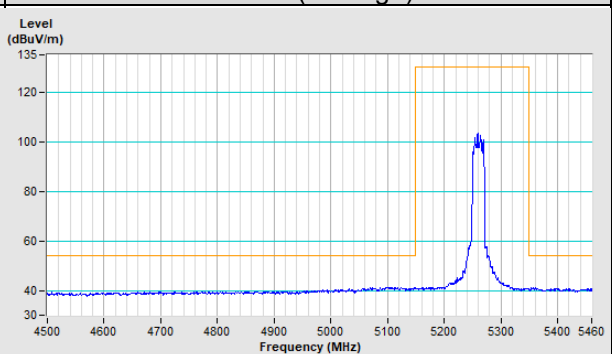
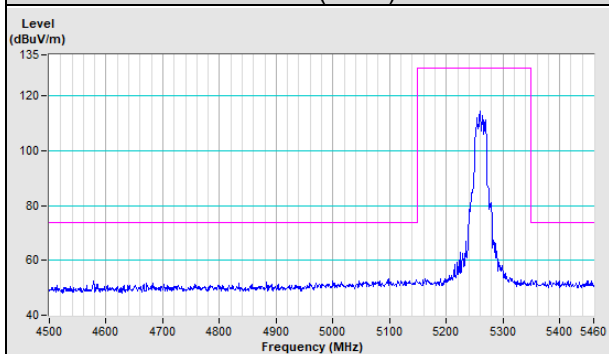

802.11ax (HE20) Channel 64

Horizontal (Peak)	Horizontal (Average)
--------------------------	-----------------------------

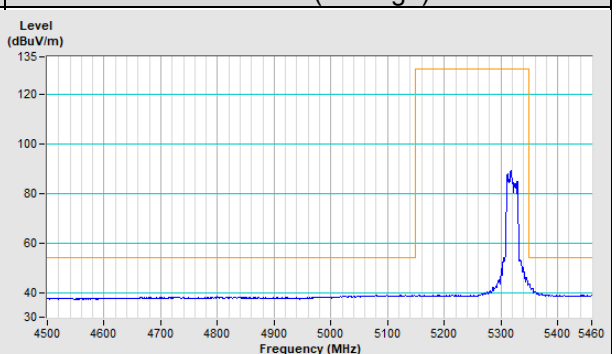
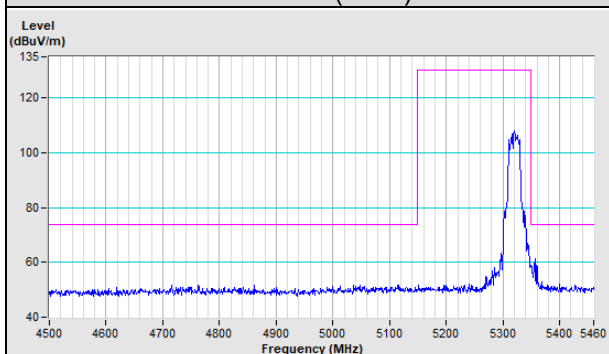

Vertical (Peak)	Vertical (Average)
------------------------	---------------------------

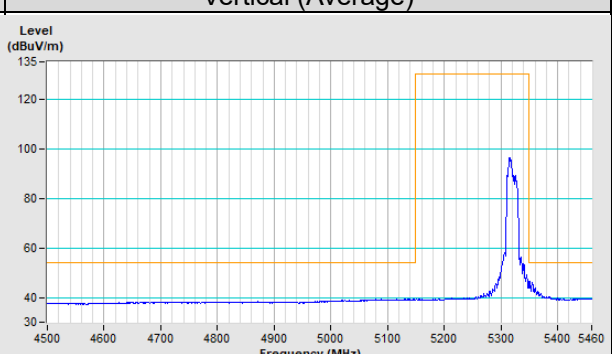
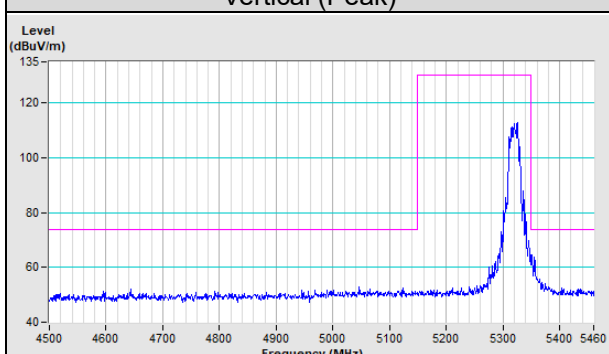

802.11ax (HE20) Channel 100

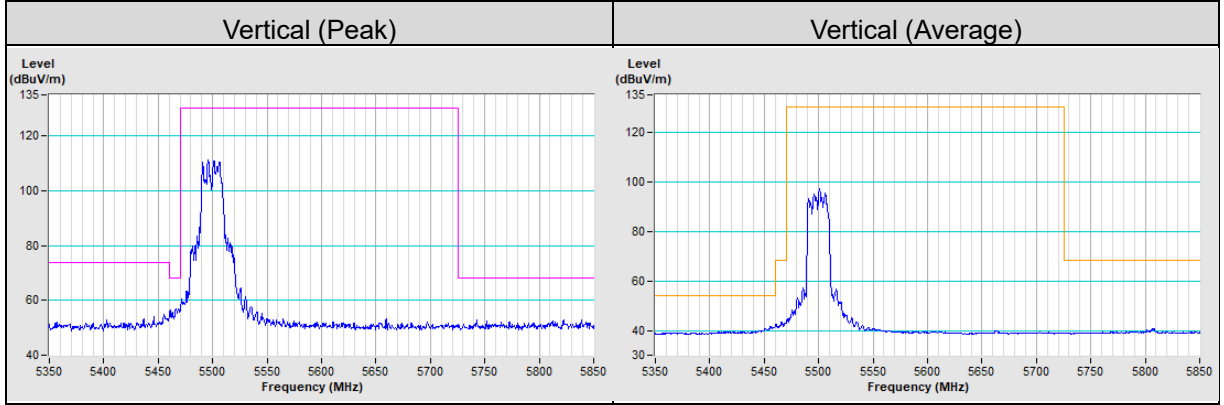
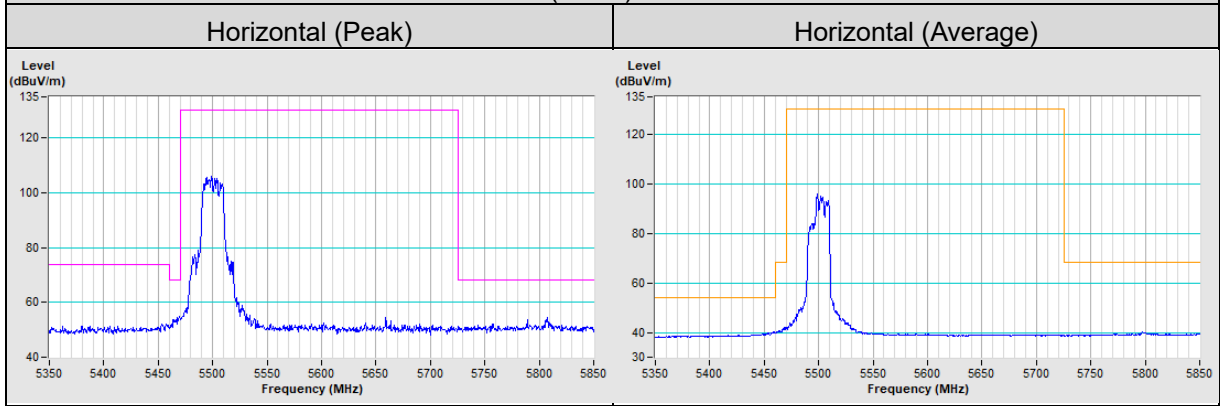

802.11ax (HE20) Channel 140

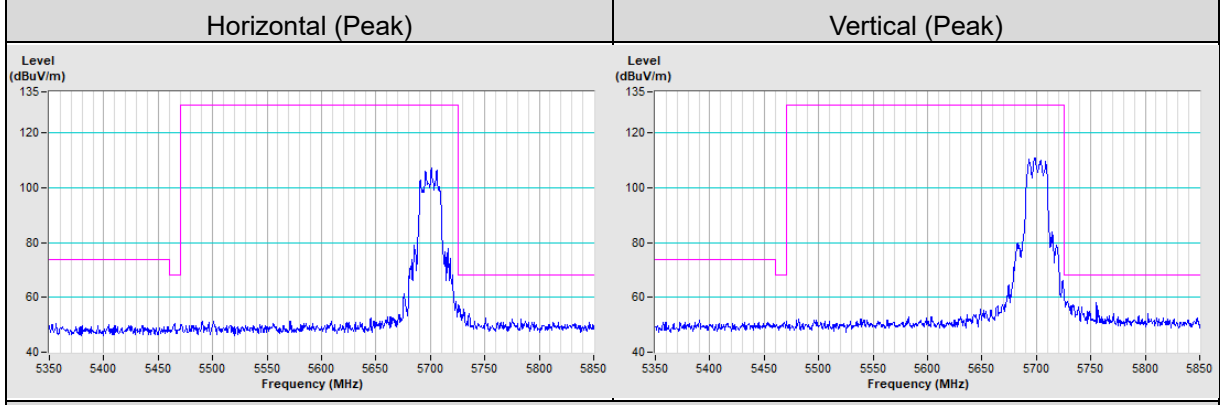

802.11ax (HE20) Channel 144

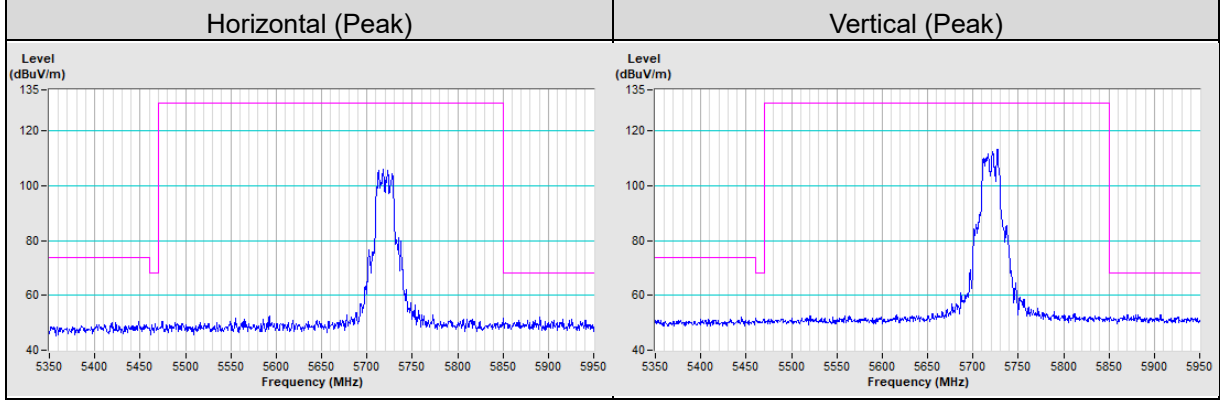

802.11ax (HE80) Channel 122

Horizontal (Peak)

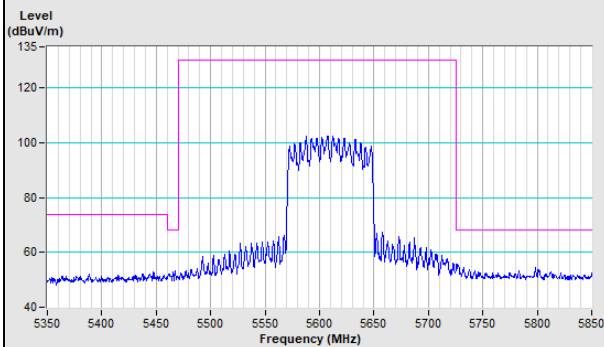

Horizontal (Average)

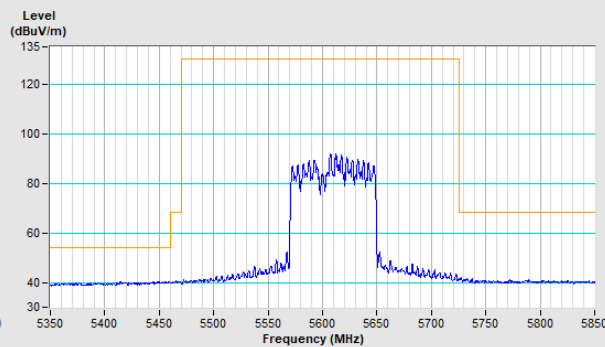

Vertical (Peak)

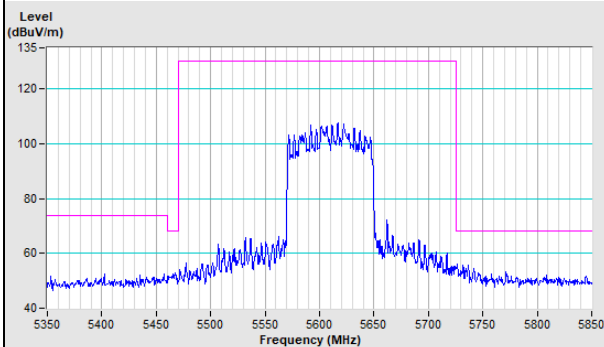

Vertical (Average)

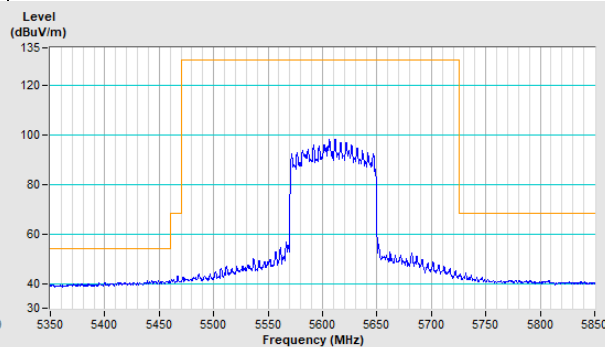

802.11ax (HE80) Channel 138

Horizontal (Peak)

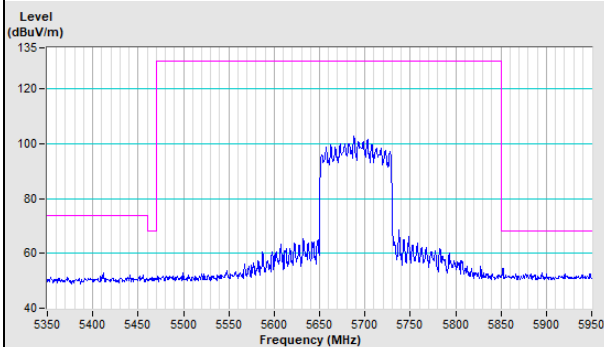

Vertical (Peak)

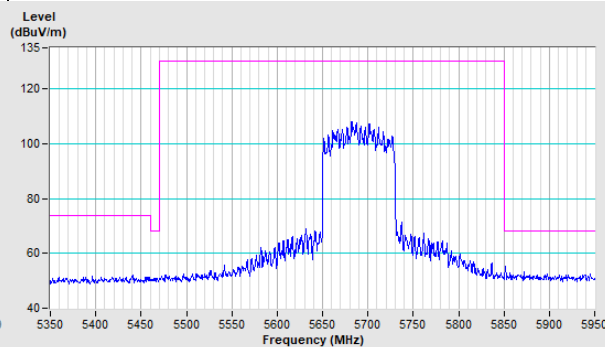

Appendix – Information of the Testing Laboratories

We, Bureau Veritas Consumer Products Services (H.K.) Ltd., Taoyuan Branch, were founded in 1988 to provide our best service in EMC, Radio, Telecom and Safety consultation. Our laboratories are FCC recognized accredited test firms and accredited and approved according to ISO/IEC 17025.

If you have any comments, please feel free to contact us at the following:

Lin Kou EMC/RF Lab

Tel: 886-2-26052180

Fax: 886-2-26051924

Hsin Chu EMC/RF/Telecom Lab

Tel: 886-3-6668565

Fax: 886-3-6668323

Hwa Ya EMC/RF/Safety Lab

Tel: 886-3-3183232

Fax: 886-3-3270892

Email: service.adt@tw.bureauveritas.com

Web Site: www.bureauveritas-adt.com

The address and road map of all our labs can be found in our web site also.

--- END ---