

FCC Test Report

Report No.: RFBEBW-WTW-P21010678

FCC ID: KA2IS3650APA1

Test Model: DIS-3650AP

Received Date: Jan. 22, 2021

Test Date: Apr. 13~ May 26, 2021

Issued Date: Sep. 03, 2021

Applicant: D-Link Corporation

Address: 14420 Myford Road Suite 100 Irvine California 92606 United States

Issued By: Bureau Veritas Consumer Products Services (H.K.) Ltd., Taoyuan Branch
Lin Kou Laboratories

Lab Address: No. 47-2, 14th Ling, Chia Pau Vil., Lin Kou Dist., New Taipei City, Taiwan

Test Location: No. 19, Hwa Ya 2nd Rd., Wen Hwa Vil., Kwei Shan Dist., Taoyuan City
33383, TAIWAN

**FCC Registration /
Designation Number:** 788550 / TW0003



This report is for your exclusive use. Any copying or replication of this report to or for any other person or entity, or use of our name or trademark, is permitted only with our prior written permission. This report sets forth our findings solely with respect to the test samples identified herein. The results set forth in this report are not indicative or representative of the quality or characteristics of the lot from which a test sample was taken or any similar or identical product unless specifically and expressly noted. Our report includes all of the tests requested by you and the results thereof based upon the information that you provided to us. You have 60 days from date of issuance of this report to notify us of any material error or omission caused by our negligence, provided, however, that such notice shall be in writing and shall specifically address the issue you wish to raise. A failure to raise such issue within the prescribed time shall constitute your unqualified acceptance of the completeness of this report, the tests conducted and the correctness of the report contents. Unless specific mention, the uncertainty of measurement has been explicitly taken into account to declare the compliance or non-compliance to the specification.

Table of Contents

| | |
|--|-----------|
| Release Control Record | 4 |
| 1 Certificate of Conformity | 5 |
| 2 Summary of Test Results | 6 |
| 2.1 Measurement Uncertainty..... | 6 |
| 2.2 Modification Record..... | 6 |
| 3 General Information | 7 |
| 3.1 General Description of EUT..... | 7 |
| 3.2 Description of Test Modes..... | 8 |
| 3.2.1 Test Mode Applicability and Tested Channel Detail..... | 9 |
| 3.3 Duty Cycle of Test Signal..... | 11 |
| 3.4 Description of Support Units..... | 12 |
| 3.4.1 Configuration of System under Test..... | 12 |
| 3.5 General Description of Applied Standards and References..... | 13 |
| 4 Test Types and Results | 14 |
| 4.1 Radiated Emission and Bandedge Measurement..... | 14 |
| 4.1.1 Limits of Radiated Emission and Bandedge Measurement..... | 14 |
| 4.1.2 Test Instruments..... | 15 |
| 4.1.3 Test Procedures..... | 16 |
| 4.1.4 Deviation from Test Standard..... | 16 |
| 4.1.5 Test Setup..... | 17 |
| 4.1.6 EUT Operating Conditions..... | 18 |
| 4.1.7 Test Results..... | 19 |
| 4.2 Conducted Emission Measurement..... | 33 |
| 4.2.1 Limits of Conducted Emission Measurement..... | 33 |
| 4.2.2 Test Instruments..... | 33 |
| 4.2.3 Test Procedures..... | 34 |
| 4.2.4 Deviation from Test Standard..... | 34 |
| 4.2.5 Test Setup..... | 34 |
| 4.2.6 EUT Operating Conditions..... | 34 |
| 4.2.7 Test Results..... | 35 |
| 4.3 6dB Bandwidth Measurement..... | 37 |
| 4.3.1 Limits of 6dB Bandwidth Measurement..... | 37 |
| 4.3.2 Test Setup..... | 37 |
| 4.3.3 Test Instruments..... | 37 |
| 4.3.4 Test Procedure..... | 37 |
| 4.3.5 Deviation from Test Standard..... | 37 |
| 4.3.6 EUT Operating Conditions..... | 37 |
| 4.3.7 Test Result..... | 38 |
| 4.4 Conducted Output Power Measurement..... | 40 |
| 4.4.1 Limits of Conducted Output Power Measurement..... | 40 |
| 4.4.2 Test Setup..... | 40 |
| 4.4.3 Test Instruments..... | 40 |
| 4.4.4 Test Procedures..... | 40 |
| 4.4.5 Deviation from Test Standard..... | 40 |
| 4.4.6 EUT Operating Conditions..... | 40 |
| 4.4.7 Test Results..... | 41 |
| 4.5 Power Spectral Density Measurement..... | 44 |
| 4.5.1 Limits of Power Spectral Density Measurement..... | 44 |
| 4.5.2 Test Setup..... | 44 |
| 4.5.3 Test Instruments..... | 44 |
| 4.5.4 Test Procedure..... | 44 |
| 4.5.5 Deviation from Test Standard..... | 45 |
| 4.5.6 EUT Operating Condition..... | 45 |

| | |
|--|-----------|
| 4.5.7 Test Results | 46 |
| 4.6 Conducted Out of Band Emission Measurement..... | 49 |
| 4.6.1 Limits of Conducted Out of Band Emission Measurement | 49 |
| 4.6.2 Test Setup..... | 49 |
| 4.6.3 Test Instruments | 49 |
| 4.6.4 Test Procedure | 49 |
| 4.6.5 Deviation from Test Standard | 49 |
| 4.6.6 EUT Operating Condition | 49 |
| 4.6.7 Test Results | 49 |
| Annex A - Band Edge Measurement | 58 |
| 5 Pictures of Test Arrangements..... | 62 |
| Appendix – Information of the Testing Laboratories | 63 |

Release Control Record

| Issue No. | Description | Date Issued |
|----------------------|------------------|---------------|
| RFBEBW-WTW-P21010678 | Original release | Sep. 03, 2021 |

1 Certificate of Conformity

Product: Wireless AC1200 Wave 2 Industrial Outdoor Access Point

Brand: D-Link

Test Model: DIS-3650AP

Sample Status: Engineering sample

Applicant: D-Link Corporation

Test Date: Apr. 13~ May 26, 2021

Standards: 47 CFR FCC Part 15, Subpart C (Section 15.247)
ANSI C63.10:2013

The above equipment has been tested by **Bureau Veritas Consumer Products Services (H.K.) Ltd., Taoyuan Branch**, and found compliance with the requirement of the above standards. The test record, data evaluation & Equipment Under Test (EUT) configurations represented herein are true and accurate accounts of the measurements of the sample's RF characteristics under the conditions specified in this report.

Prepared by : , **Date:** Sep. 03, 2021
Polly Chien / Specialist

Approved by : , **Date:** Sep. 03, 2021
Bruce Chen / Senior Engineer

2 Summary of Test Results

| 47 CFR FCC Part 15, Subpart C (Section 15.247) | | | |
|--|--|--------|---|
| FCC Clause | Test Item | Result | Remarks |
| 15.207 | AC Power Conducted Emission | Pass | Meet the requirement of limit. Minimum passing margin is -10.43dB at 14.21427MHz. |
| 15.205 / 15.209 / 15.247(d) | Radiated Emissions and Band Edge Measurement | Pass | Meet the requirement of limit. Minimum passing margin is -0.6dB at 2483.50MHz. |
| 15.247(d) | Antenna Port Emission | Pass | Meet the requirement of limit. |
| 15.247(a)(2) | 6dB bandwidth | Pass | Meet the requirement of limit. |
| 15.247(b) | Conducted power | Pass | Meet the requirement of limit. |
| 15.247(e) | Power Spectral Density | Pass | Meet the requirement of limit. |
| 15.203 | Antenna Requirement | Pass | Antenna connector is N Plug not a standard connector. |

Note:

- For 2.4G band compliance with rule 15.247(d) of the band-edge items, the test plots were recorded in Annex A. Test Procedures refer to report 4.1.3.
- Determining compliance based on the results of the compliance measurement, not taking into account measurement instrumentation uncertainty.

2.1 Measurement Uncertainty

Where relevant, the following measurement uncertainty levels have been estimated for tests performed on the EUT as specified in CISPR 16-4-2:

| Measurement | Frequency | Expanded Uncertainty (k=2) (±) |
|------------------------------------|------------------|--------------------------------|
| Conducted Emissions at mains ports | 150kHz ~ 30MHz | 2.79 dB |
| Radiated Emissions up to 1 GHz | 9kHz ~ 30MHz | 3.04 dB |
| | 30MHz ~ 200MHz | 3.59 dB |
| | 200MHz ~ 1000MHz | 3.60 dB |
| Radiated Emissions above 1 GHz | 1GHz ~ 18GHz | 2.29 dB |
| | 18GHz ~ 40GHz | 2.29 dB |

2.2 Modification Record

There were no modifications required for compliance.

3 General Information

3.1 General Description of EUT

| | |
|-----------------------|--|
| Product | Wireless AC1200 Wave 2 Industrial Outdoor Access Point |
| Brand | D-Link |
| Test Model | DIS-3650AP |
| Sample Status | Engineering sample |
| Power Supply Rating | 56Vdc (POE) |
| Modulation Type | CCK, DQPSK, DBPSK for DSSS 256QAM, 64QAM, 16QAM, QPSK, BPSK for OFDM |
| Modulation Technology | DSSS, OFDM |
| Transfer Rate | 802.11b: 11/5.5/2/1Mbps 802.11g: 54/48/36/24/18/12/9/6Mbps 802.11n (HT20/40): up to 300Mbps 802.11n (VHT20/40): up to 400Mbps |
| Operating Frequency | 2412 ~ 2462MHz |
| Number of Channel | 802.11b, 802.11g, 802.11n (HT20), 802.11n (VHT20): 11 802.11n (HT40), 802.11n (VHT40): 7 |
| Output Power | CDD Mode: 641.805mW Beamforming Mode: 85.260mW |
| Antenna Type | Refer to note |
| Antenna Connector | Refer to note |
| Accessory Device | NA |
| Cable Supplied | NA |

Note:

- The EUT incorporates a MIMO function. Physically, the EUT provides 2 completed transmitters and 2 receivers.

| Modulation Mode | Beamforming Mode | TX Function |
|-----------------|------------------|-------------|
| 802.11b | Not Support | 2TX |
| 802.11g | Not Support | 2TX |
| 802.11n (HT20) | Support | 2TX |
| 802.11n (HT40) | Support | 2TX |
| 802.11n (VHT20) | Support | 2TX |
| 802.11n (VHT40) | Support | 2TX |

** The bandwidth and modulation are similar for HT20/HT40/VHT20/VHT40 on 802.11n mode. Therefore the investigated worst case is the representative mode in test report. (Final test mode refer section 3.2.1)

* For 802.11n, CDD mode and Beamforming mode are presented in power output test item. For other test items, CDD mode is the worst case for final tests after pretesting.

2. The EUT consumes power from the following PoE. (Support units only)

| | |
|-------------------------|---------------------------|
| POE (Support unit only) | |
| Brand | D-Link |
| Model | DPE-311GI |
| Input Power | 100-240Vac, 0.8A, 50-60Hz |
| Output Power | 56Vdc, 0.54A |
| Power cord | Non-shielded AC (0.55m) |

3. The following antennas were provided to the EUT.

| | | |
|-------------------|--------------|--------------|
| Antenna Type | Omni Antenna | |
| Antenna Connector | N Plug | |
| Frequency | 2400~2500MHz | 5150~5850MHz |
| Gain (dBi) | 3.2 | 6.5 |

*The above Antenna information is declared by manufacturer and for more detailed features description, please refer to the manufacturer's specifications, the laboratory shall not be held responsible.

4. WLAN 2.4GHz & 5GHz technology can transmit at same time.

3.2 Description of Test Modes

11 channels are provided for 802.11b, 802.11g, 802.11n (HT20), 802.11n (VHT20):

| Channel | Frequency | Channel | Frequency |
|---------|-----------|---------|-----------|
| 1 | 2412MHz | 7 | 2442MHz |
| 2 | 2417MHz | 8 | 2447MHz |
| 3 | 2422MHz | 9 | 2452MHz |
| 4 | 2427MHz | 10 | 2457MHz |
| 5 | 2432MHz | 11 | 2462MHz |
| 6 | 2437MHz | | |

7 channels are provided for 802.11n (HT40), 802.11n (VHT40):

| Channel | Frequency | Channel | Frequency |
|---------|-----------|---------|-----------|
| 3 | 2422MHz | 7 | 2442MHz |
| 4 | 2427MHz | 8 | 2447MHz |
| 5 | 2432MHz | 9 | 2452MHz |
| 6 | 2437MHz | | |

3.2.1 Test Mode Applicability and Tested Channel Detail

| EUT Configure Mode | Applicable to | | | | Description |
|--------------------|---------------|-------|-----|------|-------------|
| | RE \geq 1G | RE<1G | PLC | APCM | |
| - | √ | √ | √ | √ | - |

Where RE \geq 1G: Radiated Emission above 1GHz & Bandedge Measurement
 RE<1G: Radiated Emission below 1GHz
 PLC: Power Line Conducted Emission
 APCM: Antenna Port Conducted Measurement

Note:

1. The EUT had been pre-tested on the positioned of each 3 axis. The worst case was found when positioned on **Z-plane**.
2. Radiated emission test (below 1GHz) and power line conducted emission test items chosen the worst maximum power.

Radiated Emission Test (Above 1GHz):

- Pre-Scan has been conducted to determine the worst-case mode from all possible combinations between available modulations, data rates and antenna ports (if EUT with antenna diversity architecture).
- Following channel(s) was (were) selected for the final test as listed below.

| EUT Configure Mode | Mode | Available Channel | Tested Channel | Modulation Technology | Modulation Type | Data Rate (Mbps) |
|--------------------|-----------------|-------------------|----------------|-----------------------|-----------------|------------------|
| - | 802.11b | 1 to 11 | 1, 6, 11 | DSSS | DBPSK | 1.0 |
| - | 802.11g | 1 to 11 | 1, 6, 11 | OFDM | BPSK | 6.0 |
| - | 802.11n (VHT20) | 1 to 11 | 1, 6, 11 | OFDM | OFDM | 7.2 |
| - | 802.11n (VHT40) | 3 to 9 | 3, 6, 9 | OFDM | OFDM | 15.0 |

Radiated Emission Test (Below 1GHz):

- Pre-Scan has been conducted to determine the worst-case mode from all possible combinations between available modulations, data rates and antenna ports (if EUT with antenna diversity architecture).
- Following channel(s) was (were) selected for the final test as listed below.

| EUT Configure Mode | Mode | Available Channel | Tested Channel | Modulation Technology | Modulation Type | Data Rate (Mbps) |
|--------------------|---------|-------------------|----------------|-----------------------|-----------------|------------------|
| - | 802.11b | 1 to 11 | 6 | DSSS | DBPSK | 1.0 |

Power Line Conducted Emission Test:

- Pre-Scan has been conducted to determine the worst-case mode from all possible combinations between available modulations, data rates and antenna ports (if EUT with antenna diversity architecture).
- Following channel(s) was (were) selected for the final test as listed below.

| EUT Configure Mode | Mode | Available Channel | Tested Channel | Modulation Technology | Modulation Type | Data Rate (Mbps) |
|--------------------|---------|-------------------|----------------|-----------------------|-----------------|------------------|
| - | 802.11b | 1 to 11 | 6 | DSSS | DBPSK | 1.0 |

Transmit Power Measurement:

This item includes all test value of each mode, but only includes spectrum plot of worst value of each mode.

- Pre-Scan has been conducted to determine the worst-case mode from all possible combinations between available modulations, data rates and antenna ports (if EUT with antenna diversity architecture).
- Following channel(s) was (were) selected for the final test as listed below.

| EUT Configure Mode | Mode | Available Channel | Tested Channel | Modulation Technology | Modulation Type | Data Rate (Mbps) |
|--------------------|-----------------|-------------------|----------------|-----------------------|-----------------|------------------|
| - | 802.11b | 1 to 11 | 1, 6, 11 | DSSS | DBPSK | 1.0 |
| - | 802.11g | 1 to 11 | 1, 6, 11 | OFDM | BPSK | 6.0 |
| - | 802.11n (HT20) | 1 to 11 | 1, 6, 11 | OFDM | BPSK | 6.5 |
| - | 802.11n (HT40) | 3 to 9 | 3, 6, 9 | OFDM | BPSK | 13.5 |
| - | 802.11n (VHT20) | 1 to 11 | 1, 6, 11 | OFDM | BPSK | 7.2 |
| - | 802.11n (VHT40) | 3 to 9 | 3, 6, 9 | OFDM | BPSK | 15.0 |

Bandwidth, Peak Power Spectral Density and Frequency Stability Measurement:

- This item includes all test value of each mode, but only includes spectrum plot of worst value of each mode.
- Pre-Scan has been conducted to determine the worst-case mode from all possible combinations between available modulations, data rates and antenna ports (if EUT with antenna diversity architecture).
- Following channel(s) was (were) selected for the final test as listed below.

| EUT Configure Mode | Mode | Available Channel | Tested Channel | Modulation Technology | Modulation Type | Data Rate (Mbps) |
|--------------------|-----------------|-------------------|----------------|-----------------------|-----------------|------------------|
| - | 802.11b | 1 to 11 | 1, 6, 11 | DSSS | DBPSK | 1.0 |
| - | 802.11g | 1 to 11 | 1, 6, 11 | OFDM | BPSK | 6.0 |
| - | 802.11n (VHT20) | 1 to 11 | 1, 6, 11 | OFDM | BPSK | 7.2 |
| - | 802.11n (VHT40) | 3 to 9 | 3, 6, 9 | OFDM | BPSK | 15.0 |

Test Condition:

| Applicable to | Environmental Conditions | Input Power (System) | Tested by |
|------------------------------|--------------------------|----------------------|-----------|
| RE\geq1G | 22 deg. C, 68% RH | 120Vac, 60Hz | Greg Lin |
| RE$<$1G | 22 deg. C, 68% RH | 120Vac, 60Hz | Rex Wang |
| PLC | 25 deg. C, 75% RH | 120Vac, 60Hz | Rex Wang |
| APCM | 25 deg. C, 60% RH | 120Vac, 60Hz | Dalen Dai |

3.3 Duty Cycle of Test Signal

Duty cycle of test signal is > 98%, duty factor is not required.

Duty cycle of test signal is < 98%, duty factor is required.

802.11b: Duty cycle = $12.173/12.240 = 0.995$

802.11g: Duty cycle = $2.020/2.093 = 0.965$, Duty factor = $10 * \log(1/0.965) = 0.15$

802.11n (VHT20): Duty cycle = $1.878/1.960 = 0.958$, Duty factor = $10 * \log(1/0.958) = 0.19$

802.11n (VHT40): Duty cycle = $0.927/0.964 = 0.962$, Duty factor = $10 * \log(1/0.962) = 0.17$

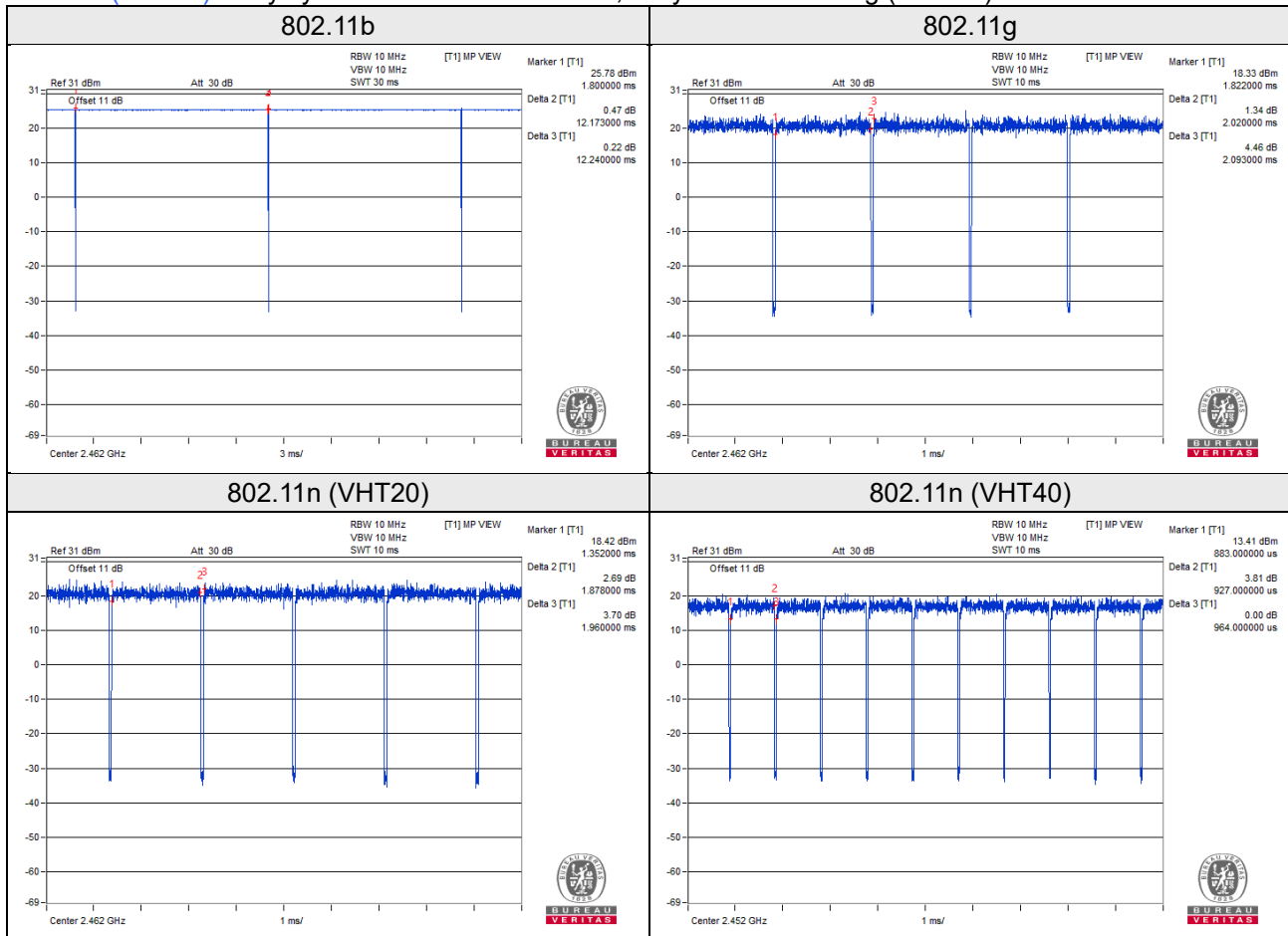

3.4 Description of Support Units

The EUT has been tested as an independent unit together with other necessary accessories or support units. The following support units or accessories were used to form a representative test configuration during the tests.

| ID | Product | Brand | Model No. | Serial No. | FCC ID | Remarks |
|----|----------|--------|-----------|------------|------------------|--------------------|
| A. | Notebook | Lenovo | 81A4 | YD02TWF5 | FCC DoC Approved | - |
| B. | POE | D-link | DPE-311GI | NA | NA | Provided by client |

Note:

1. All power cords of the above support units are non-shielded (1.8m).
2. Item A acted as a communication partner to transfer data.

| ID | Cable Descriptions | Qty. | Length (m) | Shielding (Yes/No) | Cores (Qty.) | Remarks |
|----|--------------------|------|------------|--------------------|--------------|--------------------|
| 1. | Power cable | 1 | 0.55 | N | 0 | Provided by client |
| 2. | LAN cable | 1 | 1 | N | 0 | RJ45, Cat5e |
| 3. | LAN cable | 1 | 7 | N | 0 | RJ45, Cat5e |

3.4.1 Configuration of System under Test

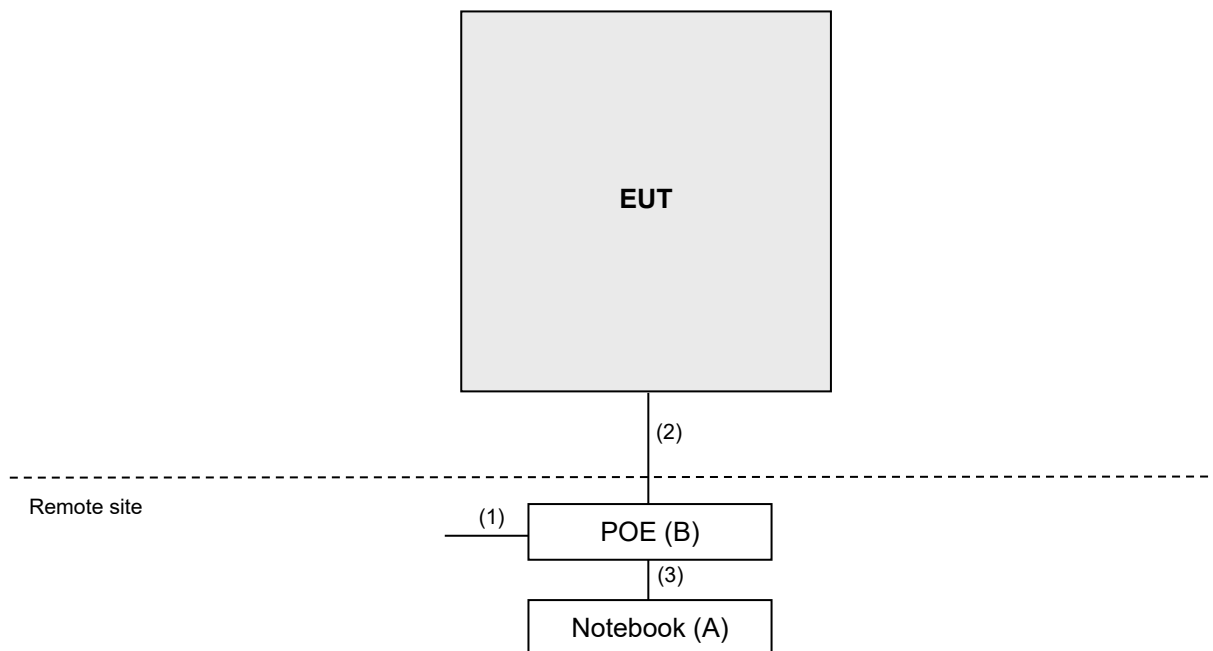

3.5 General Description of Applied Standards and References

The EUT is a RF Product. According to the specifications of the manufacturer, it must comply with the requirements of the following standards and references:

Test standard:

FCC Part 15, Subpart C (15.247)

ANSI C63.10-2013

All test items have been performed and recorded as per the above standards.

References Test Guidance:

KDB 558074 D01 15.247 Meas Guidance v05r02

KDB 662911 D01 Multiple Transmitter Output v02r01

All test items have been performed as a reference to the above KDB test guidance.

4 Test Types and Results

4.1 Radiated Emission and Bandedge Measurement

4.1.1 Limits of Radiated Emission and Bandedge Measurement

Radiated emissions which fall in the restricted bands must comply with the radiated emission limits specified as below table. Other emissions shall be at least 30dB below the highest level of the desired power:

| Frequencies (MHz) | Field Strength (microvolts/meter) | Measurement Distance (meters) |
|-------------------|-----------------------------------|-------------------------------|
| 0.009 ~ 0.490 | 2400/F(kHz) | 300 |
| 0.490 ~ 1.705 | 24000/F(kHz) | 30 |
| 1.705 ~ 30.0 | 30 | 30 |
| 30 ~ 88 | 100 | 3 |
| 88 ~ 216 | 150 | 3 |
| 216 ~ 960 | 200 | 3 |
| Above 960 | 500 | 3 |

Note:

1. The lower limit shall apply at the transition frequencies.
2. Emission level (dBuV/m) = 20 log Emission level (uV/m).
3. For frequencies above 1000MHz, the field strength limits are based on average detector, however, the peak field strength of any emission shall not exceed the maximum permitted average limits, specified above by more than 20dB under any condition of modulation.

4.1.2 Test Instruments

| Description & Manufacturer | Model No. | Serial No. | Cal. Date | Cal. Due |
|---|--|---|---------------|---------------|
| Test Receiver KEYSIGHT | N9038A | MY55420137 | Apr. 09, 2021 | Apr. 08, 2022 |
| Spectrum Analyzer ROHDE & SCHWARZ | FSP40 | 100039 | Jun. 12, 2020 | Jun. 11, 2021 |
| BILOG Antenna SCHWARZBECK | VULB9168 | 9168-160 | Nov. 06, 2020 | Nov. 05, 2021 |
| HORN Antenna SCHWARZBECK | BBHA 9120 D | 9120D-1169 | Nov. 22, 2020 | Nov. 21, 2021 |
| HORN Antenna SCHWARZBECK | BBHA 9170 | BBHA9170241 | Nov. 22, 2020 | Nov. 21, 2021 |
| Loop Antenna TESEQ | HLA 6121 | 45745 | Jul. 06, 2020 | Jul. 05, 2021 |
| Preamplifier Agilent (Below 1GHz) | 8447D | 2944A10638 | Jun. 08, 2020 | Jun. 07, 2021 |
| Preamplifier Agilent (Above 1GHz) | 8449B | 3008A02367 | Feb. 17, 2021 | Feb. 16, 2022 |
| RF signal cable HUBER+SUHNER&EMCI | SUCOFLEX 104 & EMC104-SM-SM800 0 | CABLE-CH9-02 (248780+171006) | Jan. 16, 2021 | Jan. 15, 2022 |
| RF signal cable HUBER+SUHNER | SUCOFLEX 104 | CABLE-CH9-(250795/ 4) | Jan. 16, 2021 | Jan. 15, 2022 |
| RF signal cable Woken | 8D-FB | Cable-CH9-01 | Jun. 08, 2020 | Jun. 07, 2021 |
| Software BV ADT | ADT_Radiated_ V7.6.15.9.5 | NA | NA | NA |
| Antenna Tower & Turn BV ADT | AT100 | AT93021705 | NA | NA |
| Turn Table BV ADT | TT100 | TT93021705 | NA | NA |
| Turn Table Controller BV ADT | SC100 | SC93021705 | NA | NA |
| Boresight Antenna Fixture | FBA-01 | FBA-SIP01 | NA | NA |
| USB Wideband Power Sensor KEYSIGHT | U2021XA | MY55050005/MY5519 0004/MY55190007/MY 55210005 | Jul. 13, 2020 | Jul. 12, 2021 |
| Spectrum Analyzer ROHDE & SCHWARZ | FSV40 | 100979 | Mar. 29, 2021 | Mar. 28, 2022 |

- Note: 1. The calibration interval of the above test instruments is 12 months and the calibrations are traceable to NML/ROC and NIST/USA.
2. The test was performed in HwaYa Chamber 9.

4.1.3 Test Procedures

For Radiated emission below 30MHz

- a. The EUT was placed on the top of a rotating table 0.8 meters above the ground at a 3 meter chamber room. The table was rotated 360 degrees to determine the position of the highest radiation.
- b. The EUT was set 3 meters away from the interference-receiving antenna, which was mounted on the top of a variable-height antenna tower.
- c. Parallel, perpendicular, and ground-parallel orientations of the antenna are set to make the measurement.
- d. For each suspected emission, the EUT was arranged to its worst case and the rotatable table was turned from 0 degrees to 360 degrees to find the maximum reading.
- e. The test-receiver system was set to Quasi-Peak Detect Function and Specified Bandwidth with Maximum Hold Mode.

Note:

1. The resolution bandwidth and video bandwidth of test receiver/spectrum analyzer is 9kHz at frequency below 30MHz.

For Radiated emission above 30MHz

- a. The EUT was placed on the top of a rotating table 0.8 meters (for 30MHz ~ 1GHz) / 1.5 meters (for above 1GHz) above the ground at 3 meter chamber room for test. The table was rotated 360 degrees to determine the position of the highest radiation.
- b. The EUT was set 3 meters away from the interference-receiving antenna, which was mounted on the top of a variable-height antenna tower.
- c. The height of antenna is varied from one meter to four meters above the ground to determine the maximum value of the field strength. Both horizontal and vertical polarizations of the antenna are set to make the measurement.
- d. For each suspected emission, the EUT was arranged to its worst case and then the antenna was tuned to heights from 1 meter to 4 meters and the rotatable table was turned from 0 degrees to 360 degrees to find the maximum reading.
- e. The test-receiver system was set to quasi-peak detect function and specified bandwidth with maximum hold mode when the test frequency is below 1 GHz.
- f. The test-receiver system was set to peak and average detect function and specified bandwidth with maximum hold mode when the test frequency is above 1 GHz. If the peak reading value also meets average limit, measurement with the average detector is unnecessary.

Note:

1. The resolution bandwidth and video bandwidth of test receiver/spectrum analyzer is 120kHz for Quasi-peak detection (QP) at frequency below 1GHz.
2. The resolution bandwidth of test receiver/spectrum analyzer is 1 MHz and the video bandwidth is 3 MHz for Peak detection (PK) at frequency above 1GHz.
3. The resolution bandwidth of test receiver/spectrum analyzer is 1MHz and the video bandwidth is $\geq 1/T$ (Duty cycle < 98%) or 10Hz (Duty cycle $\geq 98\%$) for Average detection (AV) at frequency above 1GHz. (802.11b: RBW = 1MHz, VBW = 10Hz; 802.11g: RBW = 1MHz, VBW = 1kHz; 802.11n (VHT20): RBW = 1MHz, VBW = 1kHz; 802.11n (VHT40): RBW = 1MHz, VBW = 3kHz)
4. All modes of operation were investigated and the worst-case emissions are reported.

4.1.4 Deviation from Test Standard

No deviation.

4.1.5 Test Setup

For Radiated emission below 30MHz

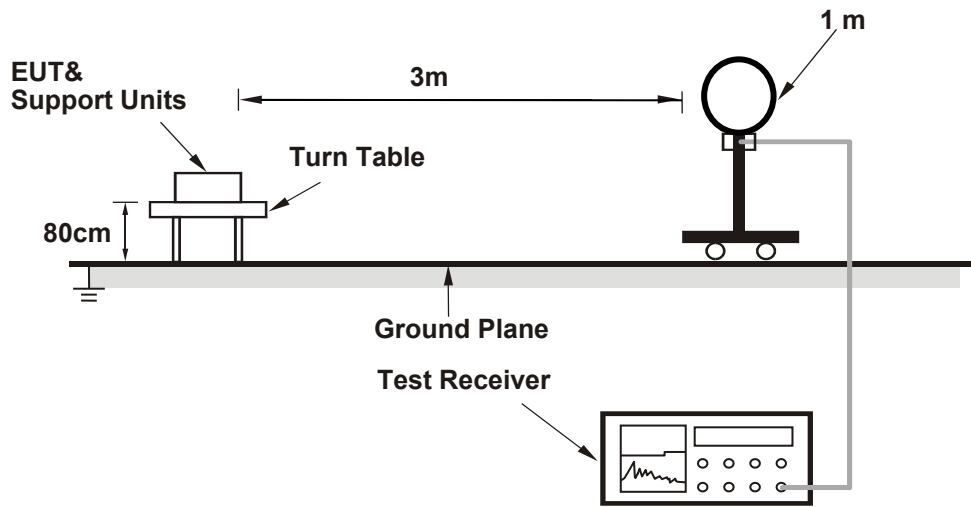

For Radiated emission 30MHz to 1GHz

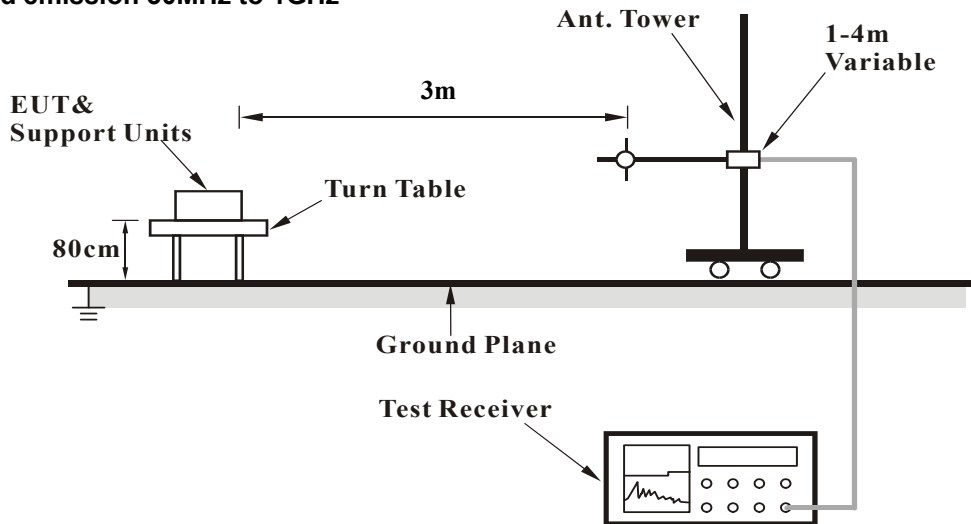

For Radiated emission above 1GHz

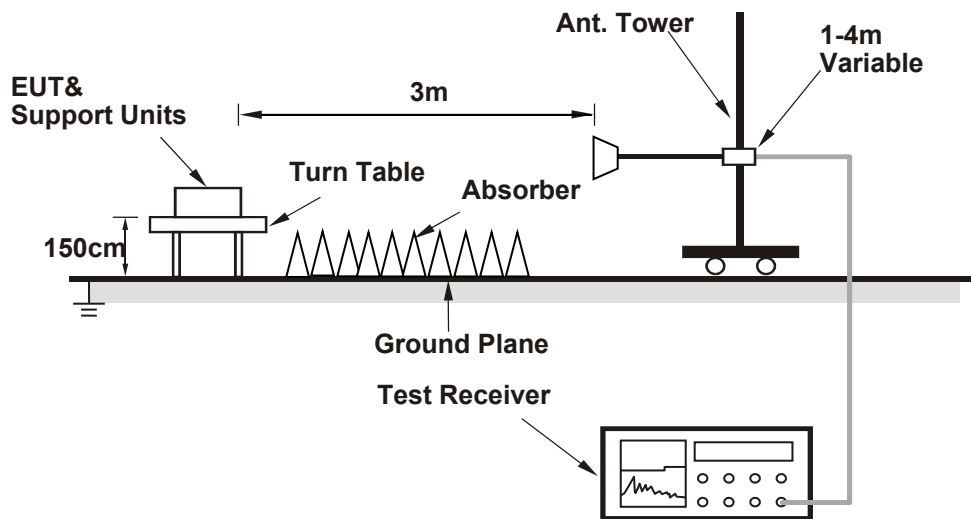

For the actual test configuration, please refer to the attached file (Test Setup Photo).

4.1.6 EUT Operating Conditions

- a. Placed the EUT on the testing table.
- b. Prepared a notebook to act as a communication partner and placed it outside of testing area.
- c. The communication partner connected with EUT via a RJ45 cable and ran a test program (provided by manufacturer) to enable EUT under transmission condition continuously at specific channel frequency.
- d. The communication partner sent data to EUT by command "PING".

4.1.7 Test Results

Above 1GHz Data:

| | | | |
|-----------------|--------------|-------------------|---------------------------|
| RF Mode | TX 802.11b | Channel | CH 1 : 2412 MHz |
| Frequency Range | 1GHz ~ 25GHz | Detector Function | Peak (PK) Average (AV) |

| Antenna Polarity & Test Distance : Horizontal at 3 m | | | | | | | | |
|--|-----------------|-------------------------|----------------|-------------|--------------------|----------------------|------------------|--------------------------|
| No | Frequency (MHz) | Emission Level (dBuV/m) | Limit (dBuV/m) | Margin (dB) | Antenna Height (m) | Table Angle (Degree) | Raw Value (dBuV) | Correction Factor (dB/m) |
| 1 | 2390.00 | 60.8 PK | 74.0 | -13.2 | 3.47 H | 226 | 29.6 | 31.2 |
| 2 | 2390.00 | 48.0 AV | 54.0 | -6.0 | 3.47 H | 226 | 16.8 | 31.2 |
| 3 | *2412.00 | 102.9 PK | | | 3.47 H | 226 | 71.7 | 31.2 |
| 4 | *2412.00 | 99.9 AV | | | 3.47 H | 226 | 68.7 | 31.2 |
| 5 | 4824.00 | 56.6 PK | 74.0 | -17.4 | 2.63 H | 119 | 54.5 | 2.1 |
| 6 | 4824.00 | 51.9 AV | 54.0 | -2.1 | 2.63 H | 119 | 49.8 | 2.1 |

| Antenna Polarity & Test Distance : Vertical at 3 m | | | | | | | | |
|--|-----------------|-------------------------|----------------|-------------|--------------------|----------------------|------------------|--------------------------|
| No | Frequency (MHz) | Emission Level (dBuV/m) | Limit (dBuV/m) | Margin (dB) | Antenna Height (m) | Table Angle (Degree) | Raw Value (dBuV) | Correction Factor (dB/m) |
| 1 | 2390.00 | 64.5 PK | 74.0 | -9.5 | 2.28 V | 303 | 33.3 | 31.2 |
| 2 | 2390.00 | 53.3 AV | 54.0 | -0.7 | 2.28 V | 303 | 22.1 | 31.2 |
| 3 | *2412.00 | 115.9 PK | | | 2.28 V | 303 | 84.7 | 31.2 |
| 4 | *2412.00 | 112.8 AV | | | 2.28 V | 303 | 81.6 | 31.2 |
| 5 | 4824.00 | 50.7 PK | 74.0 | -23.3 | 2.73 V | 131 | 48.6 | 2.1 |
| 6 | 4824.00 | 45.0 AV | 54.0 | -9.0 | 2.73 V | 131 | 42.9 | 2.1 |

Remarks:

1. Emission Level(dBuV/m) = Raw Value(dBuV) + Correction Factor(dB/m)
2. Correction Factor(dB/m) = Antenna Factor(dB/m) + Cable Factor(dB) – Pre-Amplifier Factor(dB)
3. Margin value = Emission Level – Limit value
4. The other emission levels were very low against the limit.
5. " * ": Fundamental frequency.

| | | | |
|-----------------|--------------|-------------------|---------------------------|
| RF Mode | TX 802.11b | Channel | CH 6 : 2437 MHz |
| Frequency Range | 1GHz ~ 25GHz | Detector Function | Peak (PK) Average (AV) |

Antenna Polarity & Test Distance : Horizontal at 3 m

| No | Frequency (MHz) | Emission Level (dBuV/m) | Limit (dBuV/m) | Margin (dB) | Antenna Height (m) | Table Angle (Degree) | Raw Value (dBuV) | Correction Factor (dB/m) |
|----|-----------------|-------------------------|----------------|-------------|--------------------|----------------------|------------------|--------------------------|
| 1 | *2437.00 | 104.9 PK | | | 1.94 H | 332 | 73.8 | 31.1 |
| 2 | *2437.00 | 101.8 AV | | | 1.94 H | 332 | 70.7 | 31.1 |
| 3 | 4874.00 | 57.5 PK | 74.0 | -16.5 | 1.95 H | 123 | 55.4 | 2.1 |
| 4 | 4874.00 | 52.7 AV | 54.0 | -1.3 | 1.95 H | 123 | 50.6 | 2.1 |

Antenna Polarity & Test Distance : Vertical at 3 m

| No | Frequency (MHz) | Emission Level (dBuV/m) | Limit (dBuV/m) | Margin (dB) | Antenna Height (m) | Table Angle (Degree) | Raw Value (dBuV) | Correction Factor (dB/m) |
|----|-----------------|-------------------------|----------------|-------------|--------------------|----------------------|------------------|--------------------------|
| 1 | *2437.00 | 117.8 PK | | | 1.94 V | 357 | 86.7 | 31.1 |
| 2 | *2437.00 | 114.7 AV | | | 1.94 V | 357 | 83.6 | 31.1 |
| 3 | 4874.00 | 51.4 PK | 74.0 | -22.6 | 2.68 V | 128 | 49.3 | 2.1 |
| 4 | 4874.00 | 45.8 AV | 54.0 | -8.2 | 2.68 V | 128 | 43.7 | 2.1 |

Remarks:

1. Emission Level(dBuV/m) = Raw Value(dBuV) + Correction Factor(dB/m)
2. Correction Factor(dB/m) = Antenna Factor(dB/m) + Cable Factor(dB) – Pre-Amplifier Factor(dB)
3. Margin value = Emission Level – Limit value
4. The other emission levels were very low against the limit.
5. " * " : Fundamental frequency.

| | | | |
|-----------------|--------------|-------------------|---------------------------|
| RF Mode | TX 802.11b | Channel | CH 11 : 2462 MHz |
| Frequency Range | 1GHz ~ 25GHz | Detector Function | Peak (PK) Average (AV) |

Antenna Polarity & Test Distance : Horizontal at 3 m

| No | Frequency (MHz) | Emission Level (dBuV/m) | Limit (dBuV/m) | Margin (dB) | Antenna Height (m) | Table Angle (Degree) | Raw Value (dBuV) | Correction Factor (dB/m) |
|----|-----------------|-------------------------|----------------|-------------|--------------------|----------------------|------------------|--------------------------|
| 1 | *2462.00 | 104.3 PK | | | 3.47 H | 234 | 73.2 | 31.1 |
| 2 | *2462.00 | 101.3 AV | | | 3.47 H | 234 | 70.2 | 31.1 |
| 3 | 2483.50 | 60.9 PK | 74.0 | -13.1 | 4.00 H | 234 | 29.8 | 31.1 |
| 4 | 2483.50 | 50.7 AV | 54.0 | -3.3 | 4.00 H | 234 | 19.6 | 31.1 |
| 5 | 4924.00 | 55.8 PK | 74.0 | -18.2 | 1.73 H | 138 | 53.7 | 2.1 |
| 6 | 4924.00 | 50.6 AV | 54.0 | -3.4 | 1.73 H | 138 | 48.5 | 2.1 |

Antenna Polarity & Test Distance : Vertical at 3 m

| No | Frequency (MHz) | Emission Level (dBuV/m) | Limit (dBuV/m) | Margin (dB) | Antenna Height (m) | Table Angle (Degree) | Raw Value (dBuV) | Correction Factor (dB/m) |
|----|-----------------|-------------------------|----------------|-------------|--------------------|----------------------|------------------|--------------------------|
| 1 | *2462.00 | 117.5 PK | | | 2.67 V | 284 | 86.4 | 31.1 |
| 2 | *2462.00 | 114.4 AV | | | 2.67 V | 284 | 83.3 | 31.1 |
| 3 | 2483.50 | 63.5 PK | 74.0 | -10.5 | 2.67 V | 284 | 32.4 | 31.1 |
| 4 | 2483.50 | 53.3 AV | 54.0 | -0.7 | 2.67 V | 284 | 22.2 | 31.1 |
| 5 | 4924.00 | 48.7 PK | 74.0 | -25.3 | 2.77 V | 137 | 46.6 | 2.1 |
| 6 | 4924.00 | 43.4 AV | 54.0 | -10.6 | 2.77 V | 137 | 41.3 | 2.1 |

Remarks:

1. Emission Level(dBuV/m) = Raw Value(dBuV) + Correction Factor(dB/m)
2. Correction Factor(dB/m) = Antenna Factor(dB/m) + Cable Factor(dB) – Pre-Amplifier Factor(dB)
3. Margin value = Emission Level – Limit value
4. The other emission levels were very low against the limit.
5. " * ": Fundamental frequency.

| | | | |
|-----------------|--------------|-------------------|---------------------------|
| RF Mode | TX 802.11g | Channel | CH 1 : 2412 MHz |
| Frequency Range | 1GHz ~ 25GHz | Detector Function | Peak (PK) Average (AV) |

Antenna Polarity & Test Distance : Horizontal at 3 m

| No | Frequency (MHz) | Emission Level (dBuV/m) | Limit (dBuV/m) | Margin (dB) | Antenna Height (m) | Table Angle (Degree) | Raw Value (dBuV) | Correction Factor (dB/m) |
|----|-----------------|-------------------------|----------------|-------------|--------------------|----------------------|------------------|--------------------------|
| 1 | 2390.00 | 63.6 PK | 74.0 | -10.4 | 3.56 H | 227 | 32.4 | 31.2 |
| 2 | 2390.00 | 46.5 AV | 54.0 | -7.5 | 3.56 H | 227 | 15.3 | 31.2 |
| 3 | *2412.00 | 101.1 PK | | | 3.56 H | 227 | 69.9 | 31.2 |
| 4 | *2412.00 | 91.0 AV | | | 3.56 H | 227 | 59.8 | 31.2 |
| 5 | 4824.00 | 60.7 PK | 74.0 | -13.3 | 1.71 H | 145 | 58.6 | 2.1 |
| 6 | 4824.00 | 46.6 AV | 54.0 | -7.4 | 1.71 H | 145 | 44.5 | 2.1 |

Antenna Polarity & Test Distance : Vertical at 3 m

| No | Frequency (MHz) | Emission Level (dBuV/m) | Limit (dBuV/m) | Margin (dB) | Antenna Height (m) | Table Angle (Degree) | Raw Value (dBuV) | Correction Factor (dB/m) |
|----|-----------------|-------------------------|----------------|-------------|--------------------|----------------------|------------------|--------------------------|
| 1 | 2390.00 | 73.0 PK | 74.0 | -1.0 | 2.19 V | 317 | 41.8 | 31.2 |
| 2 | 2390.00 | 52.5 AV | 54.0 | -1.5 | 2.19 V | 317 | 21.3 | 31.2 |
| 3 | *2412.00 | 114.0 PK | | | 2.19 V | 317 | 82.8 | 31.2 |
| 4 | *2412.00 | 104.0 AV | | | 2.19 V | 317 | 72.8 | 31.2 |
| 5 | 4824.00 | 53.3 PK | 74.0 | -20.7 | 2.76 V | 118 | 51.2 | 2.1 |
| 6 | 4824.00 | 39.4 AV | 54.0 | -14.6 | 2.76 V | 118 | 37.3 | 2.1 |

Remarks:

1. Emission Level(dBuV/m) = Raw Value(dBuV) + Correction Factor(dB/m)
2. Correction Factor(dB/m) = Antenna Factor(dB/m) + Cable Factor(dB) – Pre-Amplifier Factor(dB)
3. Margin value = Emission Level – Limit value
4. The other emission levels were very low against the limit.
5. " * ": Fundamental frequency.

| | | | |
|-----------------|--------------|-------------------|---------------------------|
| RF Mode | TX 802.11g | Channel | CH 6 : 2437 MHz |
| Frequency Range | 1GHz ~ 25GHz | Detector Function | Peak (PK) Average (AV) |

Antenna Polarity & Test Distance : Horizontal at 3 m

| No | Frequency (MHz) | Emission Level (dBuV/m) | Limit (dBuV/m) | Margin (dB) | Antenna Height (m) | Table Angle (Degree) | Raw Value (dBuV) | Correction Factor (dB/m) |
|----|-----------------|-------------------------|----------------|-------------|--------------------|----------------------|------------------|--------------------------|
| 1 | 2390.00 | 62.7 PK | 74.0 | -11.3 | 3.42 H | 224 | 31.5 | 31.2 |
| 2 | 2390.00 | 46.9 AV | 54.0 | -7.1 | 3.42 H | 224 | 15.7 | 31.2 |
| 3 | *2437.00 | 102.7 PK | | | 3.42 H | 224 | 71.6 | 31.1 |
| 4 | *2437.00 | 92.6 AV | | | 3.42 H | 224 | 61.5 | 31.1 |
| 5 | 4874.00 | 60.5 PK | 74.0 | -13.5 | 1.64 H | 133 | 58.4 | 2.1 |
| 6 | 4874.00 | 46.4 AV | 54.0 | -7.6 | 1.64 H | 133 | 44.3 | 2.1 |

Antenna Polarity & Test Distance : Vertical at 3 m

| No | Frequency (MHz) | Emission Level (dBuV/m) | Limit (dBuV/m) | Margin (dB) | Antenna Height (m) | Table Angle (Degree) | Raw Value (dBuV) | Correction Factor (dB/m) |
|----|-----------------|-------------------------|----------------|-------------|--------------------|----------------------|------------------|--------------------------|
| 1 | 2390.00 | 69.4 PK | 74.0 | -4.6 | 2.30 V | 334 | 38.2 | 31.2 |
| 2 | 2390.00 | 52.6 AV | 54.0 | -1.4 | 2.30 V | 334 | 21.4 | 31.2 |
| 3 | *2437.00 | 114.6 PK | | | 2.30 V | 334 | 83.5 | 31.1 |
| 4 | *2437.00 | 104.7 AV | | | 2.30 V | 334 | 73.6 | 31.1 |
| 5 | 4874.00 | 53.3 PK | 74.0 | -20.7 | 2.65 V | 127 | 51.2 | 2.1 |
| 6 | 4874.00 | 39.4 AV | 54.0 | -14.6 | 2.65 V | 127 | 37.3 | 2.1 |

Remarks:

1. Emission Level(dBuV/m) = Raw Value(dBuV) + Correction Factor(dB/m)
2. Correction Factor(dB/m) = Antenna Factor(dB/m) + Cable Factor(dB) – Pre-Amplifier Factor(dB)
3. Margin value = Emission Level – Limit value
4. The other emission levels were very low against the limit.
5. " * ": Fundamental frequency.

| | | | |
|-----------------|--------------|-------------------|---------------------------|
| RF Mode | TX 802.11g | Channel | CH 11 : 2462 MHz |
| Frequency Range | 1GHz ~ 25GHz | Detector Function | Peak (PK) Average (AV) |

Antenna Polarity & Test Distance : Horizontal at 3 m

| No | Frequency (MHz) | Emission Level (dBuV/m) | Limit (dBuV/m) | Margin (dB) | Antenna Height (m) | Table Angle (Degree) | Raw Value (dBuV) | Correction Factor (dB/m) |
|----|-----------------|-------------------------|----------------|-------------|--------------------|----------------------|------------------|--------------------------|
| 1 | *2462.00 | 102.3 PK | | | 3.39 H | 217 | 71.2 | 31.1 |
| 2 | *2462.00 | 92.4 AV | | | 3.39 H | 217 | 61.3 | 31.1 |
| 3 | 2483.50 | 65.3 PK | 74.0 | -8.7 | 3.39 H | 217 | 34.2 | 31.1 |
| 4 | 2483.50 | 46.4 AV | 54.0 | -7.6 | 3.39 H | 217 | 15.3 | 31.1 |
| 5 | 4924.00 | 58.7 PK | 74.0 | -15.3 | 1.67 H | 141 | 56.6 | 2.1 |
| 6 | 4924.00 | 44.9 AV | 54.0 | -9.1 | 1.67 H | 141 | 42.8 | 2.1 |

Antenna Polarity & Test Distance : Vertical at 3 m

| No | Frequency (MHz) | Emission Level (dBuV/m) | Limit (dBuV/m) | Margin (dB) | Antenna Height (m) | Table Angle (Degree) | Raw Value (dBuV) | Correction Factor (dB/m) |
|----|-----------------|-------------------------|----------------|-------------|--------------------|----------------------|------------------|--------------------------|
| 1 | *2462.00 | 113.3 PK | | | 2.27 V | 293 | 82.2 | 31.1 |
| 2 | *2462.00 | 103.3 AV | | | 2.27 V | 293 | 72.2 | 31.1 |
| 3 | 2483.50 | 73.2 PK | 74.0 | -0.8 | 2.27 V | 293 | 42.1 | 31.1 |
| 4 | 2483.50 | 52.6 AV | 54.0 | -1.4 | 2.27 V | 293 | 21.5 | 31.1 |
| 5 | 4924.00 | 51.8 PK | 74.0 | -22.2 | 2.73 V | 125 | 49.7 | 2.1 |
| 6 | 4924.00 | 38.0 AV | 54.0 | -16.0 | 2.73 V | 125 | 35.9 | 2.1 |

Remarks:

1. Emission Level(dBuV/m) = Raw Value(dBuV) + Correction Factor(dB/m)
2. Correction Factor(dB/m) = Antenna Factor(dB/m) + Cable Factor(dB) – Pre-Amplifier Factor(dB)
3. Margin value = Emission Level – Limit value
4. The other emission levels were very low against the limit.
5. " * ": Fundamental frequency.

| | | | |
|-----------------|--------------------|-------------------|---------------------------|
| RF Mode | TX 802.11n (VHT20) | Channel | CH 1 : 2412 MHz |
| Frequency Range | 1GHz ~ 25GHz | Detector Function | Peak (PK) Average (AV) |

Antenna Polarity & Test Distance : Horizontal at 3 m

| No | Frequency (MHz) | Emission Level (dBuV/m) | Limit (dBuV/m) | Margin (dB) | Antenna Height (m) | Table Angle (Degree) | Raw Value (dBuV) | Correction Factor (dB/m) |
|----|-----------------|-------------------------|----------------|-------------|--------------------|----------------------|------------------|--------------------------|
| 1 | 2390.00 | 60.4 PK | 74.0 | -13.6 | 1.00 H | 136 | 29.2 | 31.2 |
| 2 | 2390.00 | 44.6 AV | 54.0 | -9.4 | 1.00 H | 136 | 13.4 | 31.2 |
| 3 | *2412.00 | 100.5 PK | | | 1.00 H | 136 | 69.3 | 31.2 |
| 4 | *2412.00 | 90.4 AV | | | 1.00 H | 136 | 59.2 | 31.2 |
| 5 | 4874.00 | 58.7 PK | 74.0 | -15.3 | 1.66 H | 145 | 56.6 | 2.1 |
| 6 | 4874.00 | 44.9 AV | 54.0 | -9.1 | 1.66 H | 145 | 42.8 | 2.1 |

Antenna Polarity & Test Distance : Vertical at 3 m

| No | Frequency (MHz) | Emission Level (dBuV/m) | Limit (dBuV/m) | Margin (dB) | Antenna Height (m) | Table Angle (Degree) | Raw Value (dBuV) | Correction Factor (dB/m) |
|----|-----------------|-------------------------|----------------|-------------|--------------------|----------------------|------------------|--------------------------|
| 1 | 2390.00 | 72.9 PK | 74.0 | -1.1 | 2.25 V | 182 | 41.7 | 31.2 |
| 2 | 2390.00 | 53.2 AV | 54.0 | -0.8 | 2.25 V | 182 | 22.0 | 31.2 |
| 3 | *2412.00 | 113.3 PK | | | 2.25 V | 182 | 82.1 | 31.2 |
| 4 | *2412.00 | 102.4 AV | | | 2.25 V | 182 | 71.2 | 31.2 |
| 5 | 4874.00 | 52.5 PK | 74.0 | -21.5 | 2.77 V | 110 | 50.4 | 2.1 |
| 6 | 4874.00 | 39.1 AV | 54.0 | -14.9 | 2.77 V | 110 | 37.0 | 2.1 |

Remarks:

1. Emission Level(dBuV/m) = Raw Value(dBuV) + Correction Factor(dB/m)
2. Correction Factor(dB/m) = Antenna Factor(dB/m) + Cable Factor(dB) – Pre-Amplifier Factor(dB)
3. Margin value = Emission Level – Limit value
4. The other emission levels were very low against the limit.
5. " * ": Fundamental frequency.

| | | | |
|-----------------|--------------------|-------------------|---------------------------|
| RF Mode | TX 802.11n (VHT20) | Channel | CH 6 : 2437 MHz |
| Frequency Range | 1GHz ~ 25GHz | Detector Function | Peak (PK) Average (AV) |

Antenna Polarity & Test Distance : Horizontal at 3 m

| No | Frequency (MHz) | Emission Level (dBuV/m) | Limit (dBuV/m) | Margin (dB) | Antenna Height (m) | Table Angle (Degree) | Raw Value (dBuV) | Correction Factor (dB/m) |
|----|-----------------|-------------------------|----------------|-------------|--------------------|----------------------|------------------|--------------------------|
| 1 | 2390.00 | 64.6 PK | 74.0 | -9.4 | 3.56 H | 224 | 33.4 | 31.2 |
| 2 | 2390.00 | 46.5 AV | 54.0 | -7.5 | 3.56 H | 224 | 15.3 | 31.2 |
| 3 | *2437.00 | 104.0 PK | | | 3.56 H | 224 | 72.9 | 31.1 |
| 4 | *2437.00 | 93.9 AV | | | 3.56 H | 224 | 62.8 | 31.1 |
| 5 | 4874.00 | 59.8 PK | 74.0 | -14.2 | 1.63 H | 144 | 57.7 | 2.1 |
| 6 | 4874.00 | 45.7 AV | 54.0 | -8.3 | 1.63 H | 144 | 43.6 | 2.1 |

Antenna Polarity & Test Distance : Vertical at 3 m

| No | Frequency (MHz) | Emission Level (dBuV/m) | Limit (dBuV/m) | Margin (dB) | Antenna Height (m) | Table Angle (Degree) | Raw Value (dBuV) | Correction Factor (dB/m) |
|----|-----------------|-------------------------|----------------|-------------|--------------------|----------------------|------------------|--------------------------|
| 1 | 2390.00 | 67.4 PK | 74.0 | -6.6 | 2.58 V | 4 | 36.2 | 31.2 |
| 2 | 2390.00 | 52.8 AV | 54.0 | -1.2 | 2.58 V | 4 | 21.6 | 31.2 |
| 3 | *2437.00 | 115.3 PK | | | 2.58 V | 4 | 84.2 | 31.1 |
| 4 | *2437.00 | 105.2 AV | | | 2.58 V | 4 | 74.1 | 31.1 |
| 5 | 4874.00 | 53.0 PK | 74.0 | -21.0 | 2.74 V | 136 | 50.9 | 2.1 |
| 6 | 4874.00 | 38.8 AV | 54.0 | -15.2 | 2.74 V | 136 | 36.7 | 2.1 |

Remarks:

1. Emission Level(dBuV/m) = Raw Value(dBuV) + Correction Factor(dB/m)
2. Correction Factor(dB/m) = Antenna Factor(dB/m) + Cable Factor(dB) – Pre-Amplifier Factor(dB)
3. Margin value = Emission Level – Limit value
4. The other emission levels were very low against the limit.
5. " * ": Fundamental frequency.

| | | | |
|-----------------|--------------------|-------------------|---------------------------|
| RF Mode | TX 802.11n (VHT20) | Channel | CH 11 : 2462 MHz |
| Frequency Range | 1GHz ~ 25GHz | Detector Function | Peak (PK) Average (AV) |

Antenna Polarity & Test Distance : Horizontal at 3 m

| No | Frequency (MHz) | Emission Level (dBuV/m) | Limit (dBuV/m) | Margin (dB) | Antenna Height (m) | Table Angle (Degree) | Raw Value (dBuV) | Correction Factor (dB/m) |
|----|-----------------|-------------------------|----------------|-------------|--------------------|----------------------|------------------|--------------------------|
| 1 | *2462.00 | 101.8 PK | | | 3.37 H | 232 | 70.7 | 31.1 |
| 2 | *2462.00 | 91.7 AV | | | 3.37 H | 232 | 60.6 | 31.1 |
| 3 | 2483.50 | 66.6 PK | 74.0 | -7.4 | 3.37 H | 232 | 35.5 | 31.1 |
| 4 | 2483.50 | 46.5 AV | 54.0 | -7.5 | 3.37 H | 232 | 15.4 | 31.1 |
| 5 | 4924.00 | 58.8 PK | 74.0 | -15.2 | 1.66 H | 147 | 56.7 | 2.1 |
| 6 | 4924.00 | 44.7 AV | 54.0 | -9.3 | 1.66 H | 147 | 42.6 | 2.1 |

Antenna Polarity & Test Distance : Vertical at 3 m

| No | Frequency (MHz) | Emission Level (dBuV/m) | Limit (dBuV/m) | Margin (dB) | Antenna Height (m) | Table Angle (Degree) | Raw Value (dBuV) | Correction Factor (dB/m) |
|----------|-----------------|-------------------------|----------------|-------------|--------------------|----------------------|------------------|--------------------------|
| 1 | *2462.00 | 113.2 PK | | | 2.52 V | 346 | 82.1 | 31.1 |
| 2 | *2462.00 | 103.3 AV | | | 2.52 V | 346 | 72.2 | 31.1 |
| 3 | 2483.50 | 73.4 PK | 74.0 | -0.6 | 2.52 V | 346 | 42.3 | 31.1 |
| 4 | 2483.50 | 52.4 AV | 54.0 | -1.6 | 2.52 V | 346 | 21.3 | 31.1 |
| 5 | 4924.00 | 51.4 PK | 74.0 | -22.6 | 2.74 V | 121 | 49.3 | 2.1 |
| 6 | 4924.00 | 37.8 AV | 54.0 | -16.2 | 2.74 V | 121 | 35.7 | 2.1 |

Remarks:

1. Emission Level(dBuV/m) = Raw Value(dBuV) + Correction Factor(dB/m)
2. Correction Factor(dB/m) = Antenna Factor(dB/m) + Cable Factor(dB) – Pre-Amplifier Factor(dB)
3. Margin value = Emission Level – Limit value
4. The other emission levels were very low against the limit.
5. " * ": Fundamental frequency.

| | | | |
|-----------------|--------------------|-------------------|---------------------------|
| RF Mode | TX 802.11n (VHT40) | Channel | CH 3 : 2422 MHz |
| Frequency Range | 1GHz ~ 25GHz | Detector Function | Peak (PK) Average (AV) |

Antenna Polarity & Test Distance : Horizontal at 3 m

| No | Frequency (MHz) | Emission Level (dBuV/m) | Limit (dBuV/m) | Margin (dB) | Antenna Height (m) | Table Angle (Degree) | Raw Value (dBuV) | Correction Factor (dB/m) |
|----|-----------------|-------------------------|----------------|-------------|--------------------|----------------------|------------------|--------------------------|
| 1 | 2390.00 | 68.0 PK | 74.0 | -6.0 | 3.51 H | 227 | 36.8 | 31.2 |
| 2 | 2390.00 | 48.1 AV | 54.0 | -5.9 | 3.51 H | 227 | 16.9 | 31.2 |
| 3 | *2422.00 | 97.3 PK | | | 3.51 H | 227 | 66.1 | 31.2 |
| 4 | *2422.00 | 87.6 AV | | | 3.51 H | 227 | 56.4 | 31.2 |
| 5 | 4844.00 | 50.7 PK | 74.0 | -23.3 | 1.64 H | 137 | 48.6 | 2.1 |
| 6 | 4844.00 | 37.6 AV | 54.0 | -16.4 | 1.64 H | 137 | 35.5 | 2.1 |

Antenna Polarity & Test Distance : Vertical at 3 m

| No | Frequency (MHz) | Emission Level (dBuV/m) | Limit (dBuV/m) | Margin (dB) | Antenna Height (m) | Table Angle (Degree) | Raw Value (dBuV) | Correction Factor (dB/m) |
|----|-----------------|-------------------------|----------------|-------------|--------------------|----------------------|------------------|--------------------------|
| 1 | 2390.00 | 73.3 PK | 74.0 | -0.7 | 2.85 V | 337 | 42.1 | 31.2 |
| 2 | 2390.00 | 52.7 AV | 54.0 | -1.3 | 2.85 V | 337 | 21.5 | 31.2 |
| 3 | *2422.00 | 107.5 PK | | | 2.85 V | 337 | 76.3 | 31.2 |
| 4 | *2422.00 | 97.9 AV | | | 2.85 V | 337 | 66.7 | 31.2 |
| 5 | 4844.00 | 43.4 PK | 74.0 | -30.6 | 2.54 V | 208 | 41.3 | 2.1 |
| 6 | 4844.00 | 30.5 AV | 54.0 | -23.5 | 2.54 V | 208 | 28.4 | 2.1 |

Remarks:

1. Emission Level(dBuV/m) = Raw Value(dBuV) + Correction Factor(dB/m)
2. Correction Factor(dB/m) = Antenna Factor(dB/m) + Cable Factor(dB) – Pre-Amplifier Factor(dB)
3. Margin value = Emission Level – Limit value
4. The other emission levels were very low against the limit.
5. " * ": Fundamental frequency.

| | | | |
|-----------------|--------------------|-------------------|---------------------------|
| RF Mode | TX 802.11n (VHT40) | Channel | CH 6 : 2437 MHz |
| Frequency Range | 1GHz ~ 25GHz | Detector Function | Peak (PK) Average (AV) |

Antenna Polarity & Test Distance : Horizontal at 3 m

| No | Frequency (MHz) | Emission Level (dBuV/m) | Limit (dBuV/m) | Margin (dB) | Antenna Height (m) | Table Angle (Degree) | Raw Value (dBuV) | Correction Factor (dB/m) |
|----|-----------------|-------------------------|----------------|-------------|--------------------|----------------------|------------------|--------------------------|
| 1 | *2437.00 | 98.7 PK | | | 3.54 H | 232 | 67.6 | 31.1 |
| 2 | *2437.00 | 88.7 AV | | | 3.54 H | 232 | 57.6 | 31.1 |
| 3 | 2483.50 | 62.0 PK | 74.0 | -12.0 | 3.54 H | 232 | 30.9 | 31.1 |
| 4 | 2483.50 | 46.9 AV | 54.0 | -7.1 | 3.54 H | 232 | 15.8 | 31.1 |
| 5 | 4874.00 | 51.5 PK | 74.0 | -22.5 | 1.71 H | 149 | 49.4 | 2.1 |
| 6 | 4874.00 | 38.7 AV | 54.0 | -15.3 | 1.71 H | 149 | 36.6 | 2.1 |

Antenna Polarity & Test Distance : Vertical at 3 m

| No | Frequency (MHz) | Emission Level (dBuV/m) | Limit (dBuV/m) | Margin (dB) | Antenna Height (m) | Table Angle (Degree) | Raw Value (dBuV) | Correction Factor (dB/m) |
|----|-----------------|-------------------------|----------------|-------------|--------------------|----------------------|------------------|--------------------------|
| 1 | *2437.00 | 110.6 PK | | | 2.03 V | 322 | 79.5 | 31.1 |
| 2 | *2437.00 | 100.6 AV | | | 2.03 V | 322 | 69.5 | 31.1 |
| 3 | 2483.50 | 70.5 PK | 74.0 | -3.5 | 2.03 V | 322 | 39.4 | 31.1 |
| 4 | 2483.50 | 52.7 AV | 54.0 | -1.3 | 2.03 V | 322 | 21.6 | 31.1 |
| 5 | 4874.00 | 44.5 PK | 74.0 | -29.5 | 2.10 V | 215 | 42.4 | 2.1 |
| 6 | 4874.00 | 31.6 AV | 54.0 | -22.4 | 2.10 V | 215 | 29.5 | 2.1 |

Remarks:

1. Emission Level(dBuV/m) = Raw Value(dBuV) + Correction Factor(dB/m)
2. Correction Factor(dB/m) = Antenna Factor(dB/m) + Cable Factor(dB) – Pre-Amplifier Factor(dB)
3. Margin value = Emission Level – Limit value
4. The other emission levels were very low against the limit.
5. " * ": Fundamental frequency.

| | | | |
|-----------------|--------------------|-------------------|---------------------------|
| RF Mode | TX 802.11n (VHT40) | Channel | CH 9 : 2452 MHz |
| Frequency Range | 1GHz ~ 25GHz | Detector Function | Peak (PK) Average (AV) |

Antenna Polarity & Test Distance : Horizontal at 3 m

| No | Frequency (MHz) | Emission Level (dBuV/m) | Limit (dBuV/m) | Margin (dB) | Antenna Height (m) | Table Angle (Degree) | Raw Value (dBuV) | Correction Factor (dB/m) |
|----|-----------------|-------------------------|----------------|-------------|--------------------|----------------------|------------------|--------------------------|
| 1 | *2452.00 | 98.0 PK | | | 3.37 H | 235 | 66.9 | 31.1 |
| 2 | *2452.00 | 87.9 AV | | | 3.37 H | 235 | 56.8 | 31.1 |
| 3 | 2483.50 | 66.2 PK | 74.0 | -7.8 | 3.37 H | 235 | 35.1 | 31.1 |
| 4 | 2483.50 | 48.6 AV | 54.0 | -5.4 | 3.37 H | 235 | 17.5 | 31.1 |
| 5 | 4904.00 | 51.2 PK | 74.0 | -22.8 | 1.71 H | 147 | 49.2 | 2.0 |
| 6 | 4904.00 | 36.7 AV | 54.0 | -17.3 | 1.71 H | 147 | 34.7 | 2.0 |

Antenna Polarity & Test Distance : Vertical at 3 m

| No | Frequency (MHz) | Emission Level (dBuV/m) | Limit (dBuV/m) | Margin (dB) | Antenna Height (m) | Table Angle (Degree) | Raw Value (dBuV) | Correction Factor (dB/m) |
|----|-----------------|-------------------------|----------------|-------------|--------------------|----------------------|------------------|--------------------------|
| 1 | *2452.00 | 108.7 PK | | | 2.28 V | 287 | 77.6 | 31.1 |
| 2 | *2452.00 | 98.2 AV | | | 2.28 V | 287 | 67.1 | 31.1 |
| 3 | 2483.50 | 72.7 PK | 74.0 | -1.3 | 2.28 V | 287 | 41.6 | 31.1 |
| 4 | 2483.50 | 52.5 AV | 54.0 | -1.5 | 2.28 V | 287 | 21.4 | 31.1 |
| 5 | 4904.00 | 44.2 PK | 74.0 | -29.8 | 2.67 V | 134 | 42.2 | 2.0 |
| 6 | 4904.00 | 29.8 AV | 54.0 | -24.2 | 2.67 V | 134 | 27.8 | 2.0 |

Remarks:

1. Emission Level(dBuV/m) = Raw Value(dBuV) + Correction Factor(dB/m)
2. Correction Factor(dB/m) = Antenna Factor(dB/m) + Cable Factor(dB) – Pre-Amplifier Factor(dB)
3. Margin value = Emission Level – Limit value
4. The other emission levels were very low against the limit.
5. " * ": Fundamental frequency.

Below 1GHz worst-case data:

802.11b

| | | | |
|-----------------|--------------|----------------------|-----------------|
| CHANNEL | TX Channel 6 | DETECTOR FUNCTION | Quasi-Peak (QP) |
| FREQUENCY RANGE | 9kHz ~ 1GHz | | |

| ANTENNA POLARITY & TEST DISTANCE: HORIZONTAL AT 3 M | | | | | | | | |
|---|-------------|-------------------------|----------------|-------------|--------------------|----------------------|------------------|--------------------------|
| NO. | FREQ. (MHz) | EMISSION LEVEL (dBuV/m) | LIMIT (dBuV/m) | MARGIN (dB) | ANTENNA HEIGHT (m) | TABLE ANGLE (Degree) | RAW VALUE (dBuV) | CORRECTION FACTOR (dB/m) |
| 1 | 36.79 | 34.2 QP | 40.0 | -5.8 | 1.25 H | 193 | 44.1 | -9.9 |
| 2 | 63.95 | 28.6 QP | 40.0 | -11.4 | 1.00 H | 328 | 38.5 | -9.9 |
| 3 | 99.84 | 27.6 QP | 43.5 | -15.9 | 2.00 H | 187 | 40.7 | -13.1 |
| 4 | 156.10 | 24.3 QP | 43.5 | -19.2 | 1.00 H | 8 | 32.4 | -8.1 |
| 5 | 375.32 | 22.3 QP | 46.0 | -23.7 | 1.25 H | 193 | 27.3 | -5.0 |
| 6 | 563.50 | 26.5 QP | 46.0 | -19.5 | 1.00 H | 49 | 28.0 | -1.5 |

Remarks:

1. Emission Level(dBuV/m) = Raw Value(dBuV) + Correction Factor(dB/m).
2. Correction Factor(dB/m) = Antenna Factor(dB/m) + Cable Factor(dB) – Pre-Amplifier Factor(dB).
3. The other emission levels were very low against the limit of frequency range 30MHz ~ 1000MHz.
4. Margin value = Emission Level – Limit value.
5. The emission levels were very low against the limit of frequency range 9kHz ~ 30MHz: the amplitude of spurious emissions attenuated more than 20 dB below the permissible value to be report.

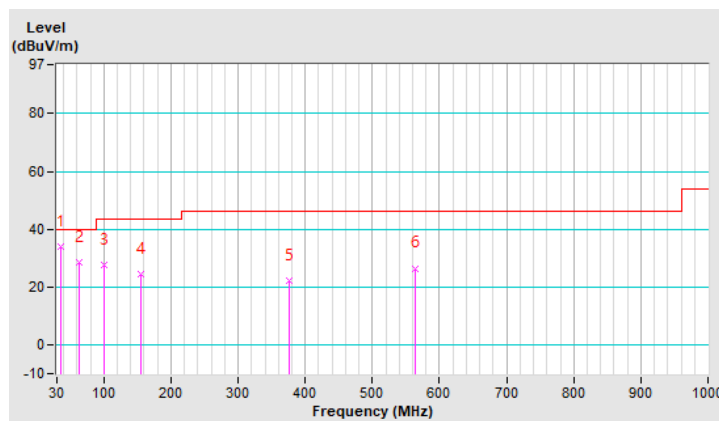

| | | | |
|-----------------|--------------|----------------------|-----------------|
| CHANNEL | TX Channel 6 | DETECTOR FUNCTION | Quasi-Peak (QP) |
| FREQUENCY RANGE | 9kHz ~ 1GHz | | |

| ANTENNA POLARITY & TEST DISTANCE: VERTICAL AT 3 M | | | | | | | | |
|---|-------------|-------------------------|----------------|-------------|--------------------|----------------------|------------------|--------------------------|
| NO. | FREQ. (MHz) | EMISSION LEVEL (dBuV/m) | LIMIT (dBuV/m) | MARGIN (dB) | ANTENNA HEIGHT (m) | TABLE ANGLE (Degree) | RAW VALUE (dBuV) | CORRECTION FACTOR (dB/m) |
| 1 | 37.76 | 32.3 QP | 40.0 | -7.7 | 1.50 V | 239 | 42.2 | -9.9 |
| 2 | 65.89 | 28.0 QP | 40.0 | -12.0 | 1.00 V | 18 | 38.1 | -10.1 |
| 3 | 96.93 | 33.5 QP | 43.5 | -10.0 | 1.25 V | 180 | 47.3 | -13.8 |
| 4 | 170.65 | 19.3 QP | 43.5 | -24.2 | 1.00 V | 231 | 28.0 | -8.7 |
| 5 | 235.64 | 21.2 QP | 46.0 | -24.8 | 2.00 V | 257 | 30.8 | -9.6 |
| 6 | 481.05 | 24.2 QP | 46.0 | -21.8 | 1.25 V | 160 | 27.2 | -3.0 |

Remarks:

1. Emission Level(dBuV/m) = Raw Value(dBuV) + Correction Factor(dB/m).
2. Correction Factor(dB/m) = Antenna Factor(dB/m) + Cable Factor(dB) – Pre-Amplifier Factor(dB).
3. The other emission levels were very low against the limit of frequency range 30MHz ~ 1000MHz.
4. Margin value = Emission Level – Limit value.
5. The emission levels were very low against the limit of frequency range 9kHz ~ 30MHz: the amplitude of spurious emissions attenuated more than 20 dB below the permissible value to be report.

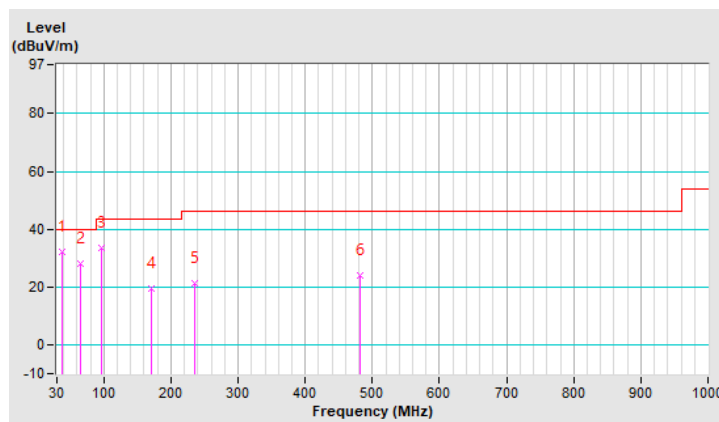

4.2 Conducted Emission Measurement

4.2.1 Limits of Conducted Emission Measurement

| Frequency (MHz) | Conducted Limit (dBuV) | |
|-----------------|------------------------|---------|
| | Quasi-peak | Average |
| 0.15 - 0.5 | 66 - 56 | 56 - 46 |
| 0.50 - 5.0 | 56 | 46 |
| 5.0 - 30.0 | 60 | 50 |

Note: 1. The lower limit shall apply at the transition frequencies.
 2. The limit decreases in line with the logarithm of the frequency in the range of 0.15 to 0.50MHz.

4.2.2 Test Instruments

| Description & Manufacturer | Model No. | Serial No. | Cal. Date | Cal. Due |
|---|--------------------------|----------------|---------------|---------------|
| Test Receiver ROHDE & SCHWARZ | ESR3 | 102412 | Jan. 29, 2021 | Jan. 28, 2022 |
| RF signal cable (with 10dB PAD) Woken | 5D-FB | Cable-cond2-01 | Sep. 04, 2020 | Sep. 03, 2021 |
| LISN/AMN ROHDE & SCHWARZ (EUT) | ESH2-Z5 | 100100 | Jan. 28, 2021 | Jan. 27, 2022 |
| LISN/AMN ROHDE & SCHWARZ (Peripheral) | ESH3-Z5 | 100312 | Aug. 18, 2020 | Aug. 17, 2021 |
| Software ADT | BV ADT_Cond_ V7.3.7.4 | NA | NA | NA |

Note: 1. The calibration interval of the above test instruments is 12 months and the calibrations are traceable to NML/ROC and NIST/USA.
 2. The test was performed in HwaYa Shielded Room 2 (Conduction 2).
 3. The VCCI Site Registration No. is C-12047.

4.2.3 Test Procedures

- The EUT was placed 0.4 meters from the conducting wall of the shielded room with EUT being connected to the power mains through a line impedance stabilization network (LISN). Other support units were connected to the power mains through another LISN. The two LISNs provide 50 ohm/ 50uH of coupling impedance for the measuring instrument.
- Both lines of the power mains connected to the EUT were checked for maximum conducted interference.
- The frequency range from 150kHz to 30MHz was searched. Emission levels under (Limit - 20dB) was not recorded.

Note: The resolution bandwidth and video bandwidth of test receiver is 9kHz for quasi-peak detection (QP) and average detection (AV) at frequency 0.15MHz-30MHz.

4.2.4 Deviation from Test Standard

No deviation.

4.2.5 Test Setup

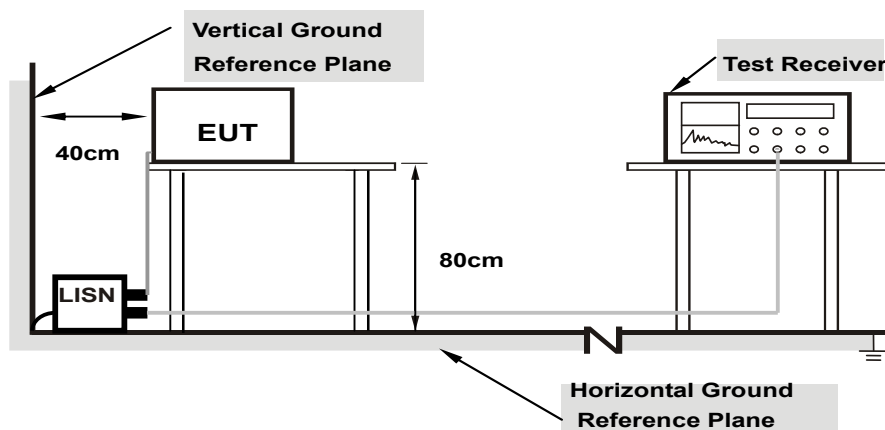

Note: 1.Support units were connected to second LISN.

For the actual test configuration, please refer to the attached file (Test Setup Photo).

4.2.6 EUT Operating Conditions

Same as 4.1.6.

4.2.7 Test Results

Worst-case data:

802.11b

| Phase | Line (L) | Detector Function | Quasi-Peak (QP) / Average (AV) |
|-------|----------|-------------------|--------------------------------|
|-------|----------|-------------------|--------------------------------|

| No | Freq. [MHz] | Corr. Factor (dB) | Reading Value [dB (uV)] | | Emission Level [dB (uV)] | | Limit [dB (uV)] | | Margin (dB) | |
|----------|-----------------|-------------------------|----------------------------|--------------|-----------------------------|--------------|--------------------|--------------|----------------|---------------|
| | | | Q.P. | AV. | Q.P. | AV. | Q.P. | AV. | Q.P. | AV. |
| | | | 1 | 0.15391 | 10.07 | 38.69 | 29.58 | 48.76 | 39.65 | 65.79 |
| 2 | 0.20865 | 10.08 | 36.51 | 27.07 | 46.59 | 37.15 | 63.26 | 53.26 | -16.67 | -16.11 |
| 3 | 0.50972 | 10.10 | 28.28 | 20.51 | 38.38 | 30.61 | 56.00 | 46.00 | -17.62 | -15.39 |
| 4 | 3.15679 | 10.19 | 22.73 | 14.06 | 32.92 | 24.25 | 56.00 | 46.00 | -23.08 | -21.75 |
| 5 | 14.21427 | 10.37 | 29.70 | 29.20 | 40.07 | 39.57 | 60.00 | 50.00 | -19.93 | -10.43 |
| 6 | 18.39406 | 10.43 | 26.95 | 25.92 | 37.38 | 36.35 | 60.00 | 50.00 | -22.62 | -13.65 |

Remarks:

1. Q.P. and AV. are abbreviations of quasi-peak and average individually.
2. The emission levels of other frequencies were very low against the limit.
3. Margin value = Emission level - Limit value
4. Correction factor = Insertion loss + Cable loss
5. Emission Level = Correction Factor + Reading Value.

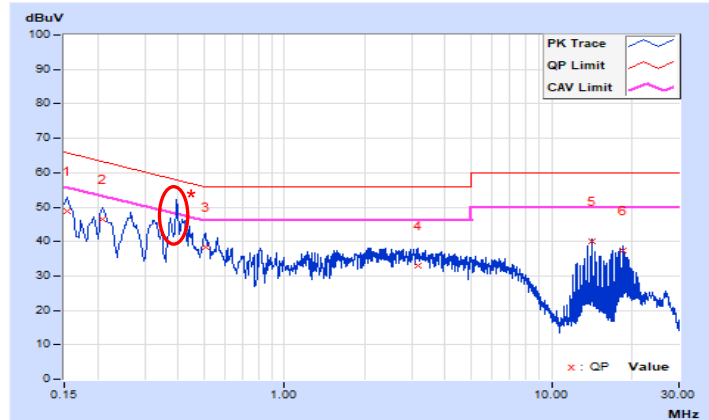

*This EUT is Class A product, the non-RF signal please refer to FCC Part 15, subpart B test report (BV CPS Repor No.: FDBEBW-WTW-P21010678).

| | | | |
|-------|-------------|-------------------|--------------------------------|
| Phase | Neutral (N) | Detector Function | Quasi-Peak (QP) / Average (AV) |
|-------|-------------|-------------------|--------------------------------|

| No | Freq. [MHz] | Corr. Factor (dB) | Reading Value [dB (uV)] | | Emission Level [dB (uV)] | | Limit [dB (uV)] | | Margin (dB) | |
|----|----------------|----------------------|----------------------------|---------|-----------------------------|-------|--------------------|-------|----------------|--------|
| | | | Q.P. | AV. | Q.P. | AV. | Q.P. | AV. | Q.P. | AV. |
| | | | 1 | 0.15391 | 10.08 | 38.75 | 29.65 | 48.83 | 39.73 | 65.79 |
| 2 | 0.20458 | 10.08 | 37.78 | 27.97 | 47.86 | 38.05 | 63.42 | 53.42 | -15.56 | -15.37 |
| 3 | 0.51177 | 10.11 | 28.31 | 20.00 | 38.42 | 30.11 | 56.00 | 46.00 | -17.58 | -15.89 |
| 4 | 3.70419 | 10.25 | 25.37 | 16.65 | 35.62 | 26.90 | 56.00 | 46.00 | -20.38 | -19.10 |
| 5 | 13.93666 | 10.50 | 29.77 | 29.06 | 40.27 | 39.56 | 60.00 | 50.00 | -19.73 | -10.44 |
| 6 | 18.12036 | 10.60 | 23.05 | 20.22 | 33.65 | 30.82 | 60.00 | 50.00 | -26.35 | -19.18 |

Remarks:

1. Q.P. and AV. are abbreviations of quasi-peak and average individually.
2. The emission levels of other frequencies were very low against the limit.
3. Margin value = Emission level - Limit value
4. Correction factor = Insertion loss + Cable loss
5. Emission Level = Correction Factor + Reading Value.

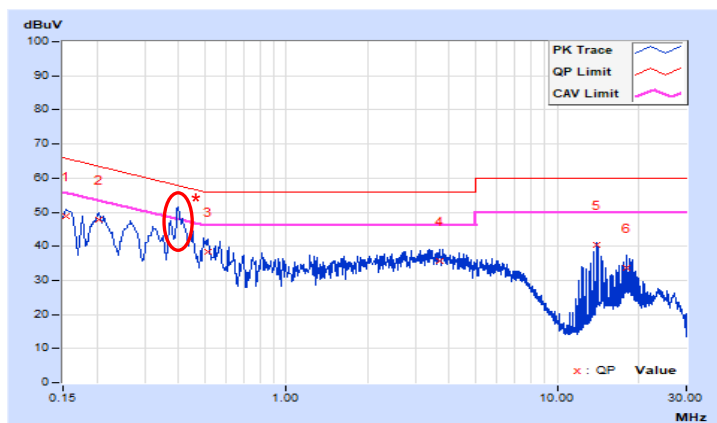

*This EUT is Class A product, the non-RF signal please refer to FCC Part 15, subpart B test report (BV CPS Repor No.: FDBEBW-WTW-P21010678).

4.3 6dB Bandwidth Measurement

4.3.1 Limits of 6dB Bandwidth Measurement

The minimum of 6dB Bandwidth Measurement is 0.5 MHz.

4.3.2 Test Setup

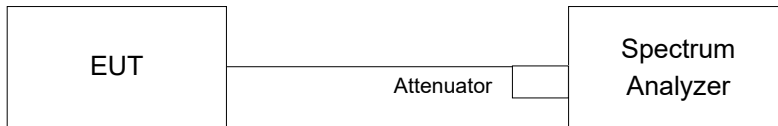

4.3.3 Test Instruments

Refer to section 4.1.2 to get information of above instrument.

4.3.4 Test Procedure

- Set resolution bandwidth (RBW) = 100kHz.
- Set the video bandwidth (VBW) $\geq 3 \times$ RBW, Detector = peak.
- Trace mode = max hold.
- Sweep = auto couple.
- Measure the maximum width of the emission that is constrained by the frequencies associated with the two amplitude points (upper and lower) that are attenuated by 6 dB relative to the maximum level measured in the fundamental emission.

4.3.5 Deviation from Test Standard

No deviation.

4.3.6 EUT Operating Conditions

The software provided by client to enable the EUT under transmission condition continuously at lowest, middle and highest channel frequencies individually.

4.3.7 Test Result

802.11b

| Channel | Frequency (MHz) | 6dB Bandwidth (MHz) | | Minimum Limit (MHz) | Pass / Fail |
|---------|-----------------|---------------------|---------|---------------------|-------------|
| | | Chain 0 | Chain 1 | | |
| 1 | 2412 | 7.05 | 7.09 | 0.5 | Pass |
| 6 | 2437 | 7.11 | 7.12 | 0.5 | Pass |
| 11 | 2462 | 7.10 | 7.11 | 0.5 | Pass |

802.11g

| Channel | Frequency (MHz) | 6dB Bandwidth (MHz) | | Minimum Limit (MHz) | Pass / Fail |
|---------|-----------------|---------------------|---------|---------------------|-------------|
| | | Chain 0 | Chain 1 | | |
| 1 | 2412 | 15.14 | 15.14 | 0.5 | Pass |
| 6 | 2437 | 15.17 | 15.13 | 0.5 | Pass |
| 11 | 2462 | 15.14 | 15.15 | 0.5 | Pass |

802.11n (VHT20)

| Channel | Frequency (MHz) | 6dB Bandwidth (MHz) | | Minimum Limit (MHz) | Pass / Fail |
|---------|-----------------|---------------------|---------|---------------------|-------------|
| | | Chain 0 | Chain 1 | | |
| 1 | 2412 | 15.15 | 15.15 | 0.5 | Pass |
| 6 | 2437 | 15.14 | 15.16 | 0.5 | Pass |
| 11 | 2462 | 15.11 | 15.16 | 0.5 | Pass |

802.11n (VHT40)

| Channel | Frequency (MHz) | 6dB Bandwidth (MHz) | | Minimum Limit (MHz) | Pass / Fail |
|---------|-----------------|---------------------|---------|---------------------|-------------|
| | | Chain 0 | Chain 1 | | |
| 3 | 2422 | 30.14 | 32.59 | 0.5 | Pass |
| 6 | 2437 | 35.10 | 32.60 | 0.5 | Pass |
| 9 | 2452 | 32.57 | 32.62 | 0.5 | Pass |

Spectrum Plot of Worst Value

802.11b

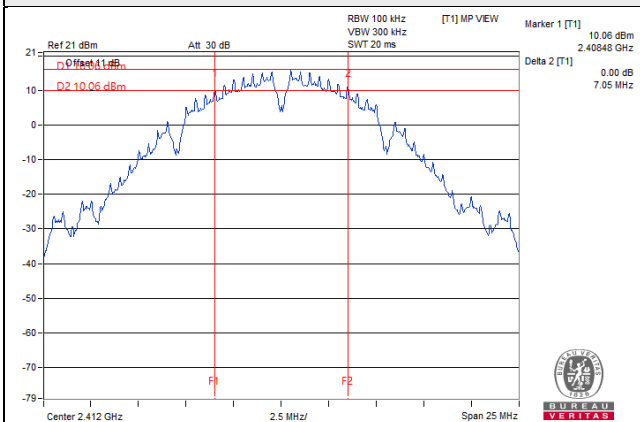

802.11g

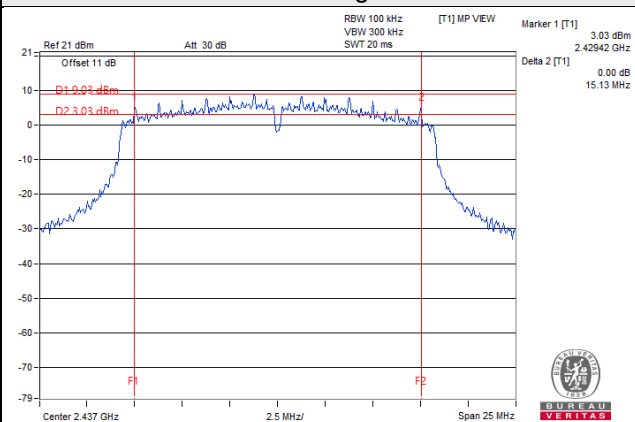

802.11n (VHT20)

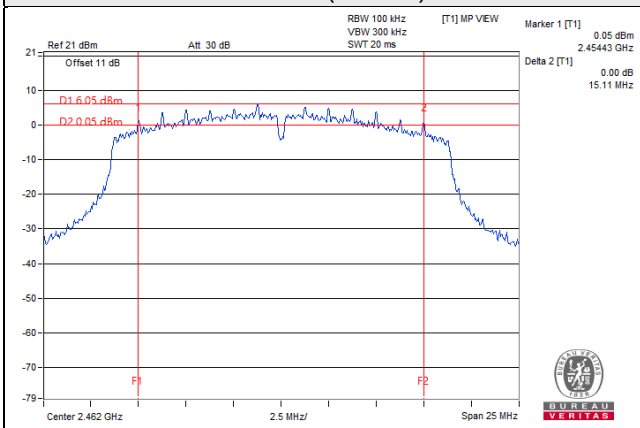

802.11n (VHT40)

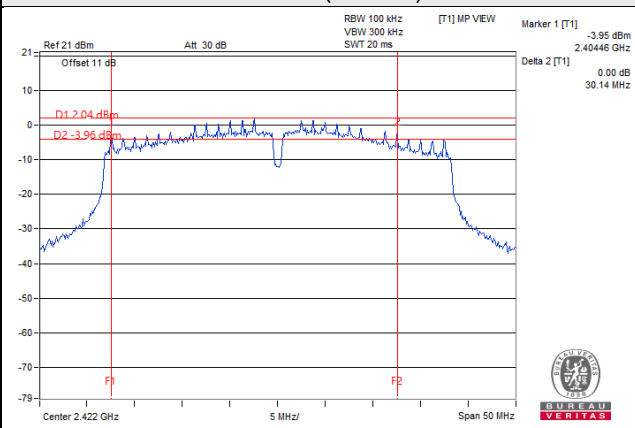

4.4 Conducted Output Power Measurement

4.4.1 Limits of Conducted Output Power Measurement

For systems using digital modulation in the 2400–2483.5 MHz bands: 1 Watt (30dBm)

Per KDB 662911 D01 Multiple Transmitter Output Method of conducted output power measurement on IEEE 802.11 devices,

Array Gain = 0 dB (i.e., no array gain) for $N_{ANT} \leq 4$;

Array Gain = 0 dB (i.e., no array gain) for channel widths ≥ 40 MHz for any N_{ANT} ;

Array Gain = $5 \log(N_{ANT}/N_{SS})$ dB or 3 dB, whichever is less for 20-MHz channel widths with $N_{ANT} \geq 5$.

For power measurements on all other devices: Array Gain = $10 \log(N_{ANT}/N_{SS})$ dB.

4.4.2 Test Setup

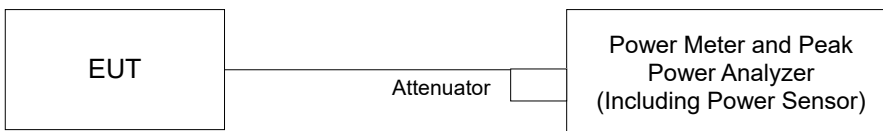

4.4.3 Test Instruments

Refer to section 4.1.2 to get information of above instrument.

4.4.4 Test Procedures

Average power sensor was used to perform output power measurement, trigger and gating function of wide band power meter is enabled to measure max output power of TX on burst. Duty factor is not added to measured value.

4.4.5 Deviation from Test Standard

No deviation.

4.4.6 EUT Operating Conditions

Same as item 4.3.6.

4.4.7 Test Results

CDD Mode

802.11b

| Channel | Frequency (MHz) | Average Power (dBm) | | Total Power (mW) | Total Power (dBm) | Limit (dBm) | Pass / Fail |
|---------|-----------------|---------------------|---------|------------------|-------------------|-------------|-------------|
| | | Chain 0 | Chain 1 | | | | |
| 1 | 2412 | 23.99 | 23.11 | 455.255 | 26.58 | 30.00 | Pass |
| 6 | 2437 | 25.24 | 24.88 | 641.805 | 28.07 | 30.00 | Pass |
| 11 | 2462 | 23.47 | 23.25 | 433.680 | 26.37 | 30.00 | Pass |

802.11g

| Channel | Frequency (MHz) | Average Power (dBm) | | Total Power (mW) | Total Power (dBm) | Limit (dBm) | Pass / Fail |
|---------|-----------------|---------------------|---------|------------------|-------------------|-------------|-------------|
| | | Chain 0 | Chain 1 | | | | |
| 1 | 2412 | 18.71 | 17.99 | 137.253 | 21.38 | 30.00 | Pass |
| 6 | 2437 | 19.21 | 18.45 | 153.352 | 21.86 | 30.00 | Pass |
| 11 | 2462 | 17.26 | 16.98 | 103.099 | 20.13 | 30.00 | Pass |

802.11n (HT20)

| Channel | Frequency (MHz) | Average Power (dBm) | | Total Power (mW) | Total Power (dBm) | Limit (dBm) | Pass / Fail |
|---------|-----------------|---------------------|---------|------------------|-------------------|-------------|-------------|
| | | Chain 0 | Chain 1 | | | | |
| 1 | 2412 | 17.71 | 17.45 | 114.611 | 20.59 | 30.00 | Pass |
| 6 | 2437 | 19.53 | 18.84 | 166.303 | 22.21 | 30.00 | Pass |
| 11 | 2462 | 17.01 | 16.52 | 95.109 | 19.78 | 30.00 | Pass |

802.11n (HT40)

| Channel | Frequency (MHz) | Average Power (dBm) | | Total Power (mW) | Total Power (dBm) | Limit (dBm) | Pass / Fail |
|---------|-----------------|---------------------|---------|------------------|-------------------|-------------|-------------|
| | | Chain 0 | Chain 1 | | | | |
| 3 | 2422 | 15.35 | 14.98 | 65.754 | 18.18 | 30.00 | Pass |
| 6 | 2437 | 18.74 | 18.24 | 141.498 | 21.51 | 30.00 | Pass |
| 9 | 2452 | 15.25 | 15.00 | 65.119 | 18.14 | 30.00 | Pass |

802.11n (VHT20)

| Channel | Frequency (MHz) | Average Power (dBm) | | Total Power (mW) | Total Power (dBm) | Limit (dBm) | Pass / Fail |
|---------|-----------------|---------------------|---------|------------------|-------------------|-------------|-------------|
| | | Chain 0 | Chain 1 | | | | |
| 1 | 2412 | 17.82 | 17.51 | 116.898 | 20.68 | 30.00 | Pass |
| 6 | 2437 | 19.62 | 18.97 | 170.508 | 22.32 | 30.00 | Pass |
| 11 | 2462 | 17.05 | 16.57 | 96.093 | 19.83 | 30.00 | Pass |

802.11n (VHT40)

| Channel | Frequency (MHz) | Average Power (dBm) | | Total Power (mW) | Total Power (dBm) | Limit (dBm) | Pass / Fail |
|---------|-----------------|---------------------|---------|------------------|-------------------|-------------|-------------|
| | | Chain 0 | Chain 1 | | | | |
| 3 | 2422 | 15.47 | 15.03 | 67.079 | 18.27 | 30.00 | Pass |
| 6 | 2437 | 18.87 | 18.32 | 145.011 | 21.61 | 30.00 | Pass |
| 9 | 2452 | 15.34 | 15.03 | 66.040 | 18.20 | 30.00 | Pass |

Beamforming Mode

802.11n (HT20)

| Channel | Frequency (MHz) | Average Power (dBm) | | Total Power (mW) | Total Power (dBm) | Limit (dBm) | Pass / Fail |
|---------|-----------------|---------------------|---------|------------------|-------------------|-------------|-------------|
| | | Chain 0 | Chain 1 | | | | |
| 1 | 2412 | 14.70 | 14.44 | 57.309 | 17.58 | 29.79 | Pass |
| 6 | 2437 | 16.52 | 15.83 | 83.157 | 19.20 | 29.79 | Pass |
| 11 | 2462 | 14.00 | 13.51 | 47.558 | 16.77 | 29.79 | Pass |

Note: Directional gain = $3.2\text{dBi} + 10\log(2) = 6.21\text{dBi} > 6\text{dBi}$, so the power limit shall be reduced to $30 - (6.21 - 6) = 29.79\text{dBi}$.

802.11n (HT40)

| Channel | Frequency (MHz) | Average Power (dBm) | | Total Power (mW) | Total Power (dBm) | Limit (dBm) | Pass / Fail |
|---------|-----------------|---------------------|---------|------------------|-------------------|-------------|-------------|
| | | Chain 0 | Chain 1 | | | | |
| 3 | 2422 | 12.34 | 11.97 | 32.879 | 15.17 | 29.79 | Pass |
| 6 | 2437 | 15.73 | 15.23 | 70.754 | 18.50 | 29.79 | Pass |
| 9 | 2452 | 12.24 | 11.99 | 32.562 | 15.13 | 29.79 | Pass |

Note: Directional gain = $3.2\text{dBi} + 10\log(2) = 6.21\text{dBi} > 6\text{dBi}$, so the power limit shall be reduced to $30 - (6.21 - 6) = 29.79\text{dBi}$.

802.11n (VHT20)

| Channel | Frequency (MHz) | Average Power (dBm) | | Total Power (mW) | Total Power (dBm) | Limit (dBm) | Pass / Fail |
|---------|-----------------|---------------------|---------|------------------|-------------------|-------------|-------------|
| | | Chain 0 | Chain 1 | | | | |
| 1 | 2412 | 14.81 | 14.50 | 58.453 | 17.67 | 29.79 | Pass |
| 6 | 2437 | 16.61 | 15.96 | 85.260 | 19.31 | 29.79 | Pass |
| 11 | 2462 | 14.04 | 13.56 | 48.050 | 16.82 | 29.79 | Pass |

Note: Directional gain = $3.2\text{dBi} + 10\log(2) = 6.21\text{dBi} > 6\text{dBi}$, so the power limit shall be reduced to $30 - (6.21 - 6) = 29.79\text{dBi}$.

802.11n (VHT40)

| Channel | Frequency (MHz) | Average Power (dBm) | | Total Power (mW) | Total Power (dBm) | Limit (dBm) | Pass / Fail |
|---------|-----------------|---------------------|---------|------------------|-------------------|-------------|-------------|
| | | Chain 0 | Chain 1 | | | | |
| 3 | 2422 | 12.46 | 12.02 | 33.542 | 15.26 | 29.79 | Pass |
| 6 | 2437 | 15.86 | 15.31 | 72.510 | 18.60 | 29.79 | Pass |
| 9 | 2452 | 12.33 | 12.02 | 33.022 | 15.19 | 29.79 | Pass |

Note: Directional gain = $3.2\text{dBi} + 10\log(2) = 6.21\text{dBi} > 6\text{dBi}$, so the power limit shall be reduced to $30 - (6.21 - 6) = 29.79\text{dBi}$.

4.5 Power Spectral Density Measurement

4.5.1 Limits of Power Spectral Density Measurement

The Maximum of Power Spectral Density Measurement is 8dBm in any 3 kHz.

4.5.2 Test Setup

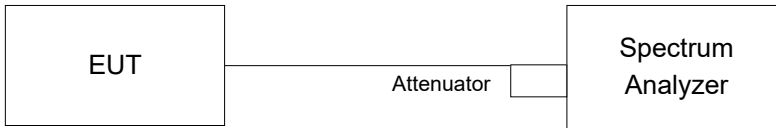

4.5.3 Test Instruments

Refer to section 4.1.2 to get information of above instrument.

4.5.4 Test Procedure

For Average Power (Duty cycle $\geq 98\%$)

- Set instrument center frequency to DTS channel center frequency.
- Set span to at least 1.5 times the OBW.
- Set RBW to: $3 \text{ kHz} \leq \text{RBW} \leq 100 \text{ kHz}$.
- Set VBW $\geq 3 \times \text{RBW}$.
- Detector = power averaging (RMS) or sample detector (when RMS not available).
- Ensure that the number of measurement points in the sweep $\geq 2 \times \text{span}/\text{RBW}$.
- Sweep time = auto couple.
- Employ trace averaging (RMS) mode over a minimum of 100 traces.
- Use the peak marker function to determine the maximum amplitude level.

For Average Power (Duty cycle $< 98\%$)

- Measure the duty cycle (x).
- Set instrument center frequency to DTS channel center frequency.
- Set span to at least 1.5 times the OBW.
- Set RBW to: $3 \text{ kHz} \leq \text{RBW} \leq 100 \text{ kHz}$.
- Set VBW $\geq 3 \times \text{RBW}$.
- Detector = power averaging (RMS) or sample detector (when RMS not available).
- Ensure that the number of measurement points in the sweep $\geq 2 \times \text{span}/\text{RBW}$.
- Sweep time = auto couple.
- Do not use sweep triggering. Allow sweep to "free run".
- Employ trace averaging (RMS) mode over a minimum of 100 traces.
- Use the peak marker function to determine the maximum amplitude level.
- Add $10 \log (1/x)$, where x is the duty cycle measured in step (a), to the measured PSD to compute the average PSD during the actual transmission time.

4.5.5 Deviation from Test Standard

No deviation.

4.5.6 EUT Operating Condition

Same as item 4.3.6

4.5.7 Test Results

802.11b

| TX chain | Channel | Frequency (MHz) | PSD (dBm/3kHz) | 10 log (N=2) dB | Total PSD (dBm/3kHz) | Limit (dBm/3kHz) | Pass / Fail |
|----------|---------|-----------------|----------------|-----------------|----------------------|------------------|-------------|
| 0 | 1 | 2412 | -8.50 | 3.01 | -5.49 | 7.79 | Pass |
| | 6 | 2437 | -8.17 | 3.01 | -5.16 | 7.79 | Pass |
| | 11 | 2462 | -9.79 | 3.01 | -6.78 | 7.79 | Pass |
| 1 | 1 | 2412 | -8.68 | 3.01 | -5.67 | 7.79 | Pass |
| | 6 | 2437 | -8.19 | 3.01 | -5.18 | 7.79 | Pass |
| | 11 | 2462 | -8.95 | 3.01 | -5.94 | 7.79 | Pass |

Note:

- Method E) 2) c) of power density measurement of KDB 662911 is using for calculating total power density, Measure and add $10 \log (N_{ANT})$ dB.
- Directional gain = $3.2\text{dBi} + 10\log(2) = 6.21\text{dBi} > 6\text{dBi}$, so the power density limit shall be reduced to $8 - (6.21 - 6) = 7.79\text{dBm}$.

802.11g

| TX chain | Channel | Frequency (MHz) | PSD w/o Duty Factor (dBm/3kHz) | 10 log (N=2) dB | Duty Factor (dB) | Total PSD With Duty Factor (dBm/3kHz) | Limit (dBm/3kHz) | Pass / Fail |
|----------|---------|-----------------|--------------------------------|-----------------|------------------|---------------------------------------|------------------|-------------|
| 0 | 1 | 2412 | -16.63 | 3.01 | 0.15 | -13.47 | 7.79 | Pass |
| | 6 | 2437 | -15.66 | 3.01 | 0.15 | -12.5 | 7.79 | Pass |
| | 11 | 2462 | -18.83 | 3.01 | 0.15 | -15.67 | 7.79 | Pass |
| 1 | 1 | 2412 | -16.63 | 3.01 | 0.15 | -13.47 | 7.79 | Pass |
| | 6 | 2437 | -16.14 | 3.01 | 0.15 | -12.98 | 7.79 | Pass |
| | 11 | 2462 | -17.55 | 3.01 | 0.15 | -14.39 | 7.79 | Pass |

Note:

- Method E) 2) c) of power density measurement of KDB 662911 is using for calculating total power density, Measure and add $10 \log (N_{ANT})$ dB.
- Directional gain = $3.2\text{dBi} + 10\log(2) = 6.21\text{dBi} > 6\text{dBi}$, so the power density limit shall be reduced to $8 - (6.21 - 6) = 7.79\text{dBm}$.
- Refer to section 3.3 for duty cycle spectrum plot.

802.11n (VHT20)

| TX chain | Channel | Frequency (MHz) | PSD w/o Duty Factor (dBm/3kHz) | 10 log (N=2) dB | Duty Factor (dB) | Total PSD With Duty Factor (dBm/3kHz) | Limit (dBm/3kHz) | Pass / Fail |
|----------|---------|-----------------|--------------------------------|-----------------|------------------|---------------------------------------|------------------|-------------|
| 0 | 1 | 2412 | -18.48 | 3.01 | 0.19 | -15.28 | 7.79 | Pass |
| | 6 | 2437 | -16.53 | 3.01 | 0.19 | -13.33 | 7.79 | Pass |
| | 11 | 2462 | -18.55 | 3.01 | 0.19 | -15.35 | 7.79 | Pass |
| 1 | 1 | 2412 | -18.73 | 3.01 | 0.19 | -15.53 | 7.79 | Pass |
| | 6 | 2437 | -16.11 | 3.01 | 0.19 | -12.91 | 7.79 | Pass |
| | 11 | 2462 | -17.54 | 3.01 | 0.19 | -14.34 | 7.79 | Pass |

Note:

- Method E) 2) c) of power density measurement of KDB 662911 is using for calculating total power density, Measure and add $10 \log (N_{ANT})$ dB.
- Directional gain = $3.2\text{dBi} + 10\log(2) = 6.21\text{dBi} > 6\text{dBi}$, so the power density limit shall be reduced to $8 - (6.21 - 6) = 7.79\text{dBm}$.
- Refer to section 3.3 for duty cycle spectrum plot.

802.11n (VHT40)

| TX chain | Channel | Frequency (MHz) | PSD w/o Duty Factor (dBm/3kHz) | 10 log (N=2) dB | Duty Factor (dB) | Total PSD With Duty Factor (dBm/3kHz) | Limit (dBm/3kHz) | Pass / Fail |
|----------|---------|-----------------|--------------------------------|-----------------|------------------|---------------------------------------|------------------|-------------|
| 0 | 3 | 2422 | -23.77 | 3.01 | 0.17 | -20.59 | 7.79 | Pass |
| | 6 | 2437 | -20.15 | 3.01 | 0.17 | -16.97 | 7.79 | Pass |
| | 9 | 2452 | -23.31 | 3.01 | 0.17 | -20.13 | 7.79 | Pass |
| 1 | 3 | 2422 | -24.28 | 3.01 | 0.17 | -21.1 | 7.79 | Pass |
| | 6 | 2437 | -20.67 | 3.01 | 0.17 | -17.49 | 7.79 | Pass |
| | 9 | 2452 | -22.36 | 3.01 | 0.17 | -19.18 | 7.79 | Pass |

Note:

- Method E) 2) c) of power density measurement of KDB 662911 is using for calculating total power density, Measure and add $10 \log (N_{ANT})$ dB.
- Directional gain = $3.2\text{dBi} + 10\log(2) = 6.21\text{dBi} > 6\text{dBi}$, so the power density limit shall be reduced to $8 - (6.21 - 6) = 7.79\text{dBm}$.
- Refer to section 3.3 for duty cycle spectrum plot.

Spectrum Plot of Worst Value

802.11b

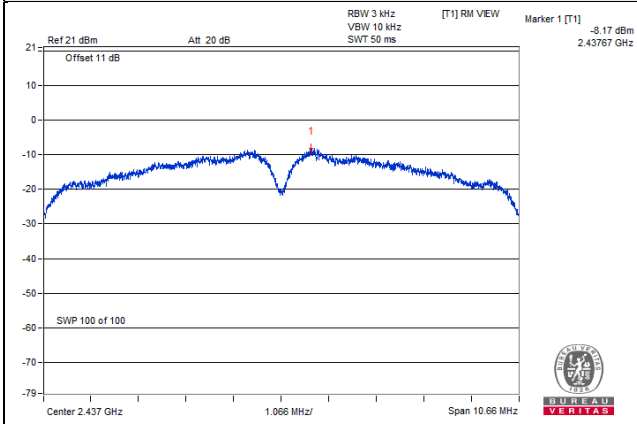

802.11g

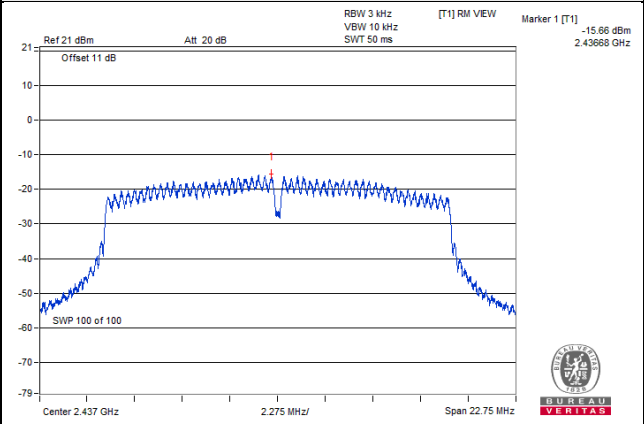

802.11n (VHT20)

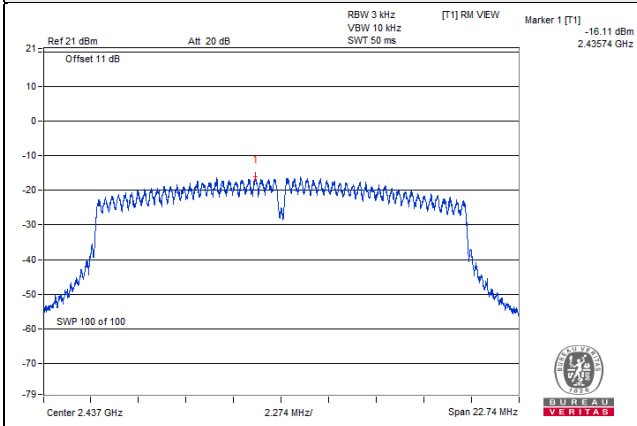

802.11n (VHT40)

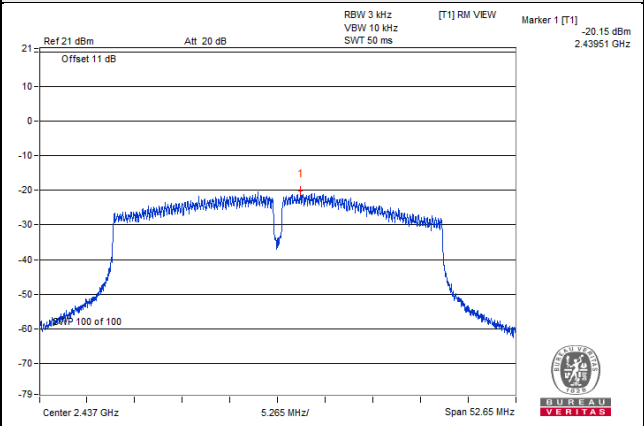

4.6 Conducted Out of Band Emission Measurement

4.6.1 Limits of Conducted Out of Band Emission Measurement

Below -30dB of the highest emission level of operating band (in 100kHz Resolution Bandwidth).

4.6.2 Test Setup

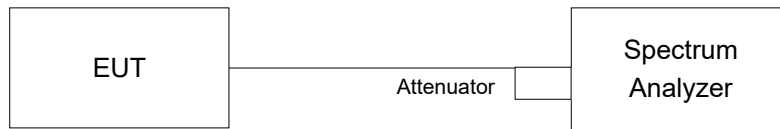

4.6.3 Test Instruments

Refer to section 4.1.2 to get information of above instrument.

4.6.4 Test Procedure

MEASUREMENT PROCEDURE REF

- Set the RBW = 100 kHz.
- Set the VBW \geq 300 kHz.
- Detector = peak.
- Sweep time = auto couple.
- Trace mode = max hold.
- Allow trace to fully stabilize.
- Use the peak marker function to determine the maximum power level in any 100 kHz band segment within the fundamental EBW.

MEASUREMENT PROCEDURE OOB

- Set RBW = 100 kHz.
- Set VBW \geq 300 kHz.
- Detector = peak.
- Sweep = auto couple.
- Trace Mode = max hold.
- Allow trace to fully stabilize.
- Use the peak marker function to determine the maximum amplitude level.

4.6.5 Deviation from Test Standard

No deviation.

4.6.6 EUT Operating Condition

Same as item 4.3.6

4.6.7 Test Results

The conducted emission test is performed on each TX port of operating mode without summing or adding 10log (N) since the limit is relative emission limit.

The spectrum plots are attached on the following pages. D1 line indicates the highest level, and D2 line indicates the 30dB offset below D1. It shows compliance with the requirement.

802.11b_Chain 0

CH 1

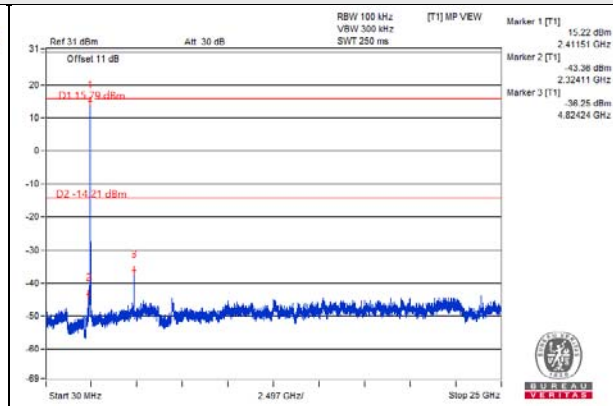
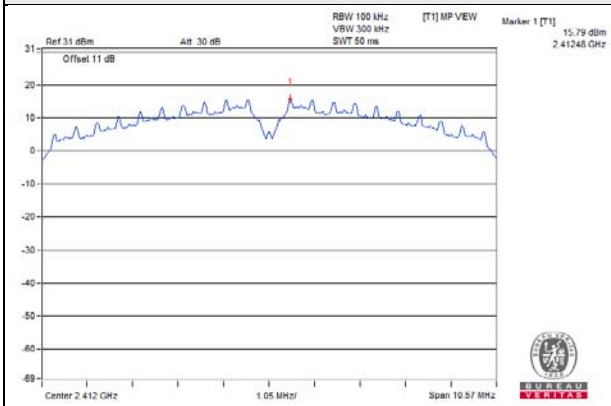

CH 6

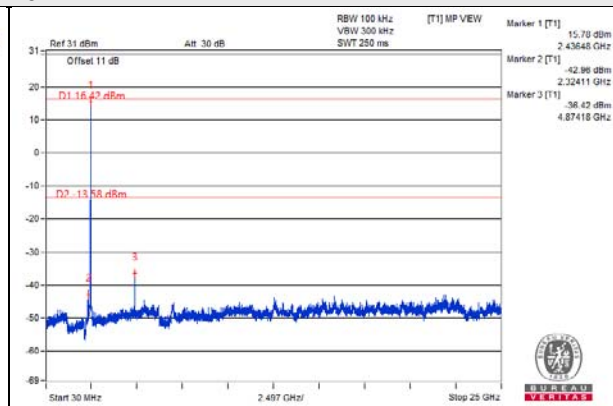
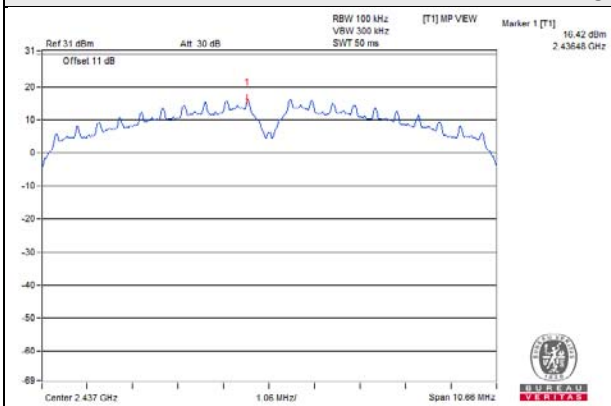

CH 11

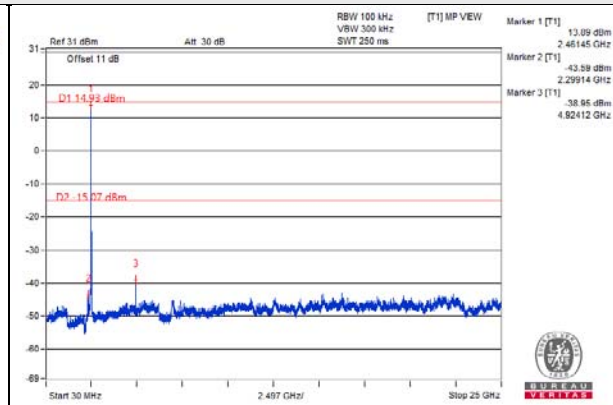
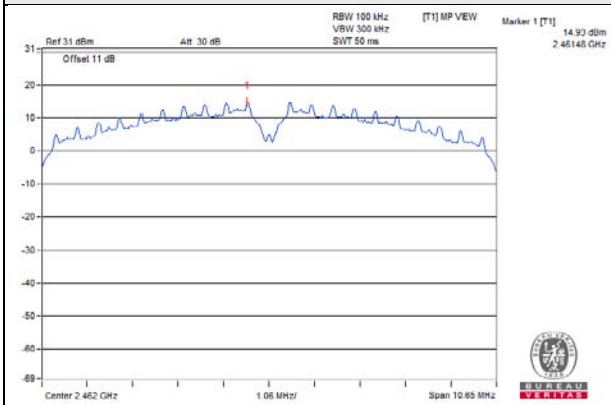

CH 1 Band edge

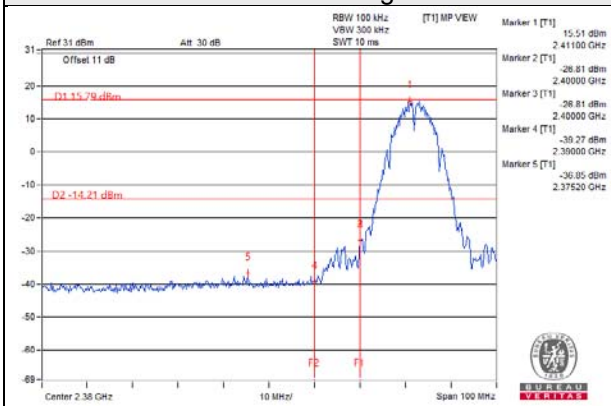

CH 11 Band edge

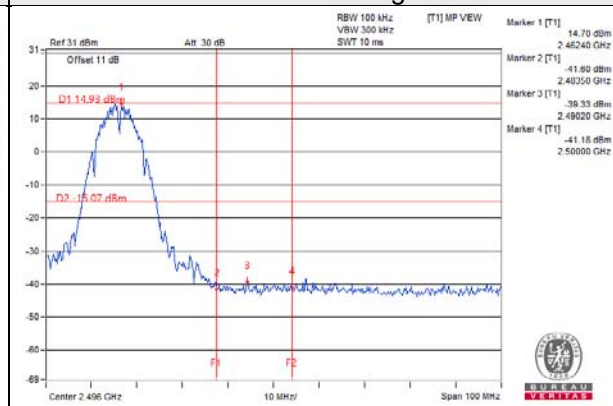

802.11b_Chain 1

CH 1

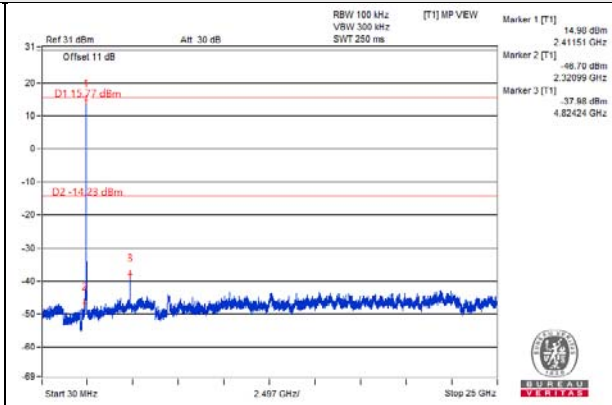
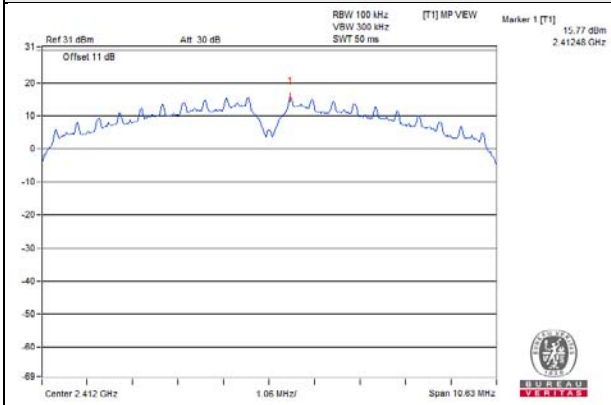

CH 6

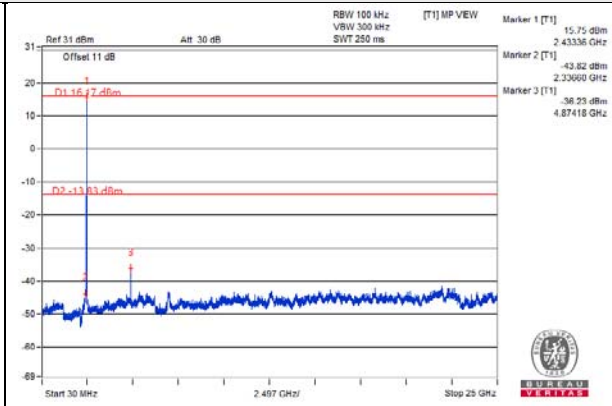
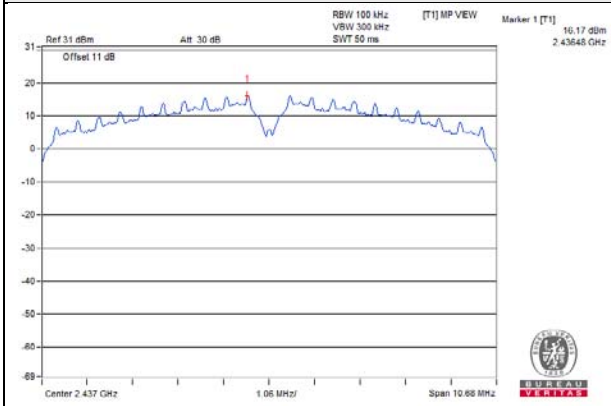

CH 11

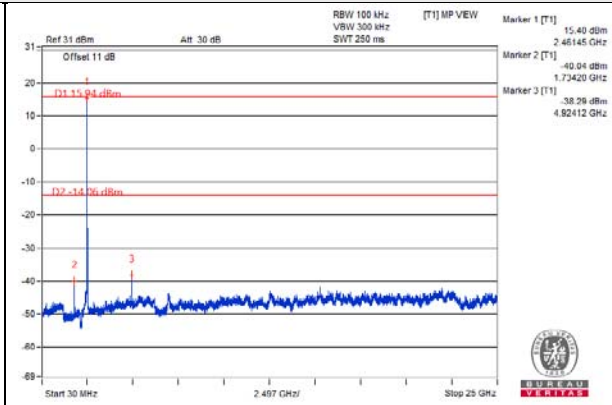
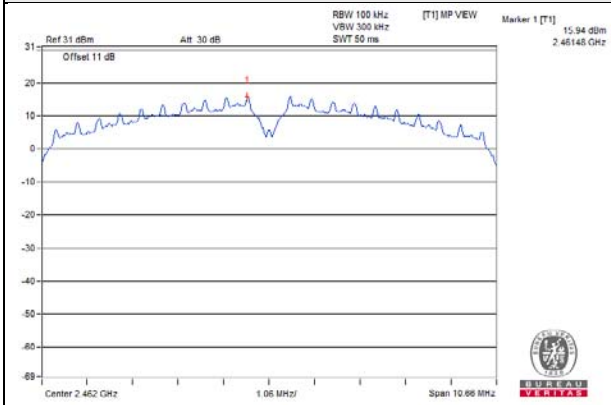

CH 1 Band edge

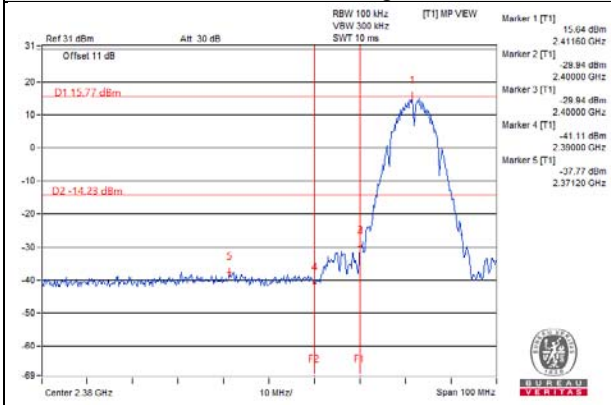

CH 11 Band edge

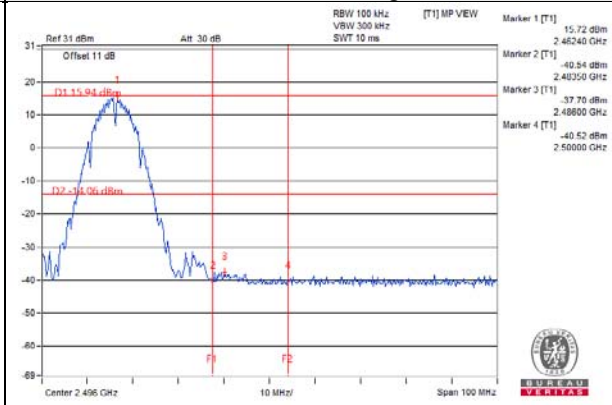

802.11g_Chain 0

CH 1

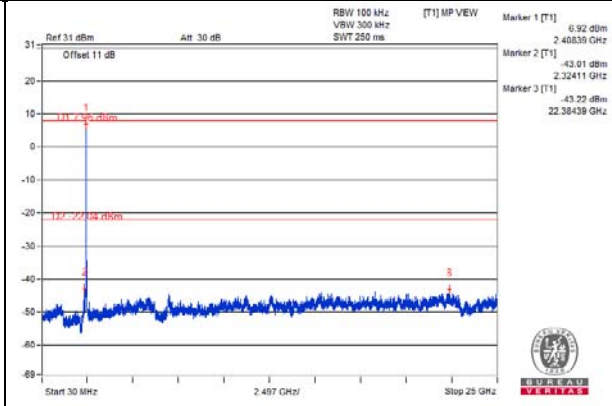
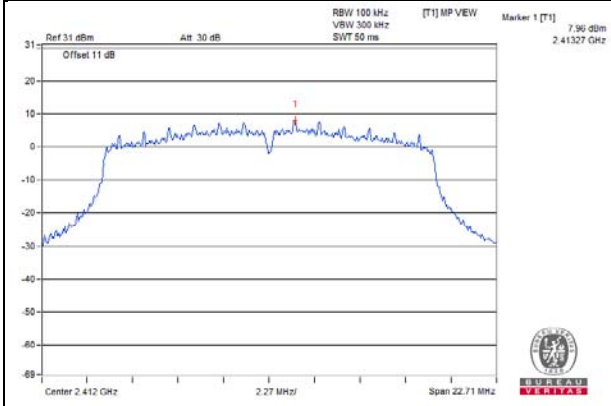

CH 6

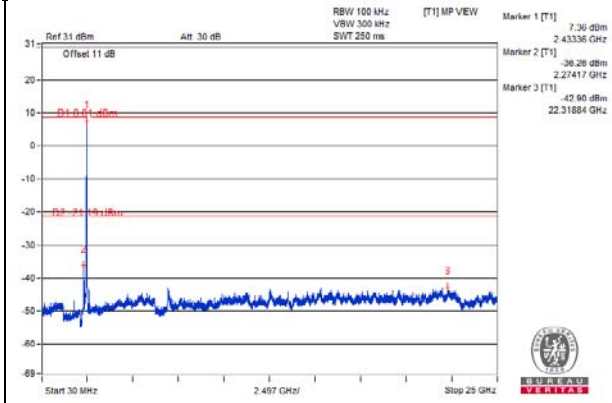
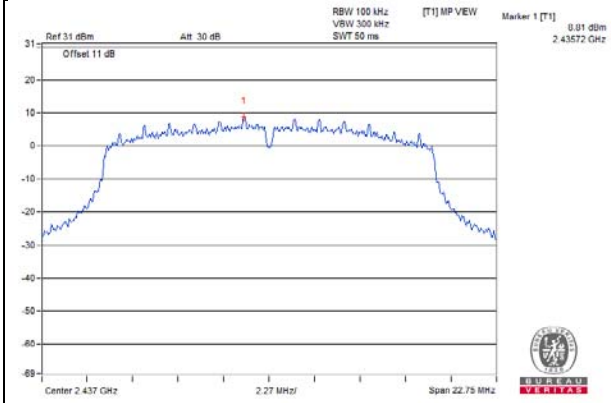

CH 11

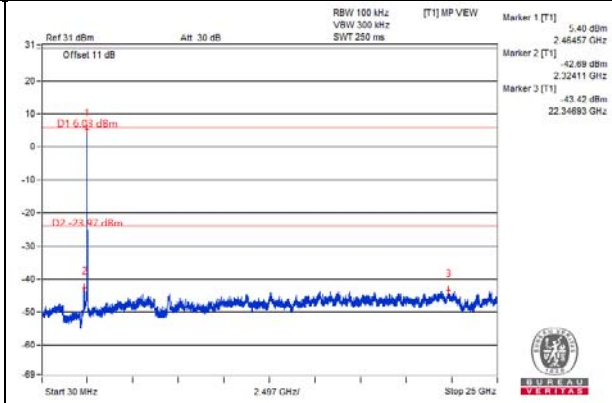
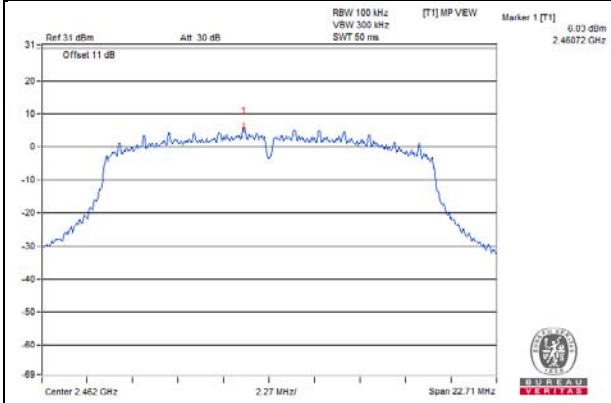

CH 1 Band edge

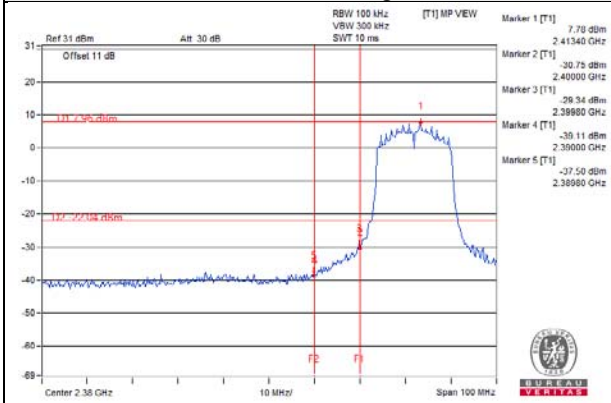

CH 11 Band edge

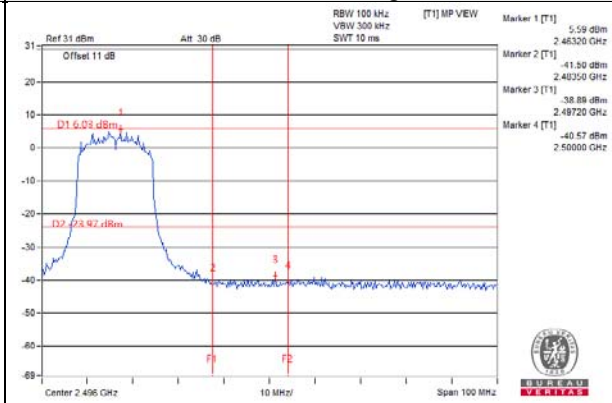

802.11g_Chain 1

CH 1

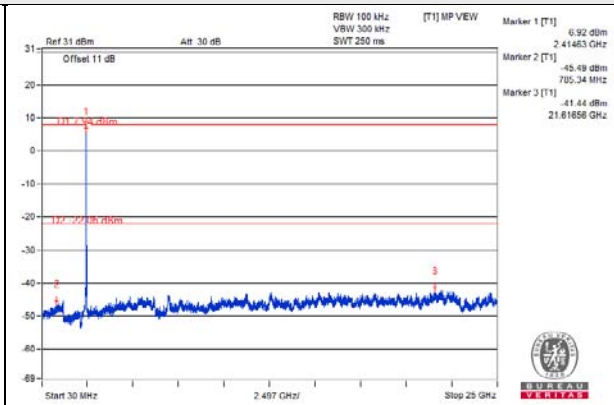
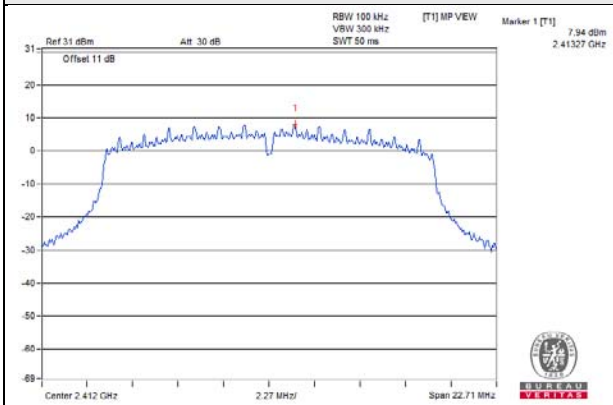

CH 6

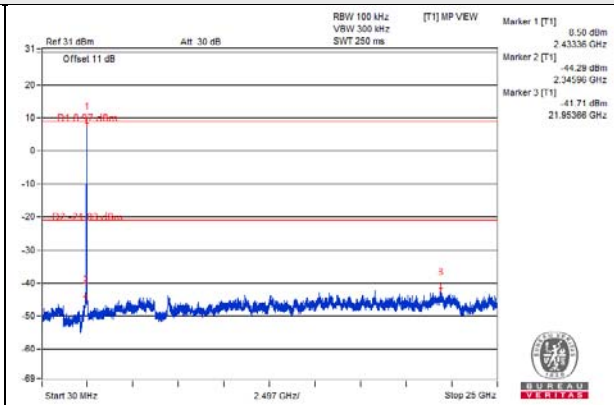
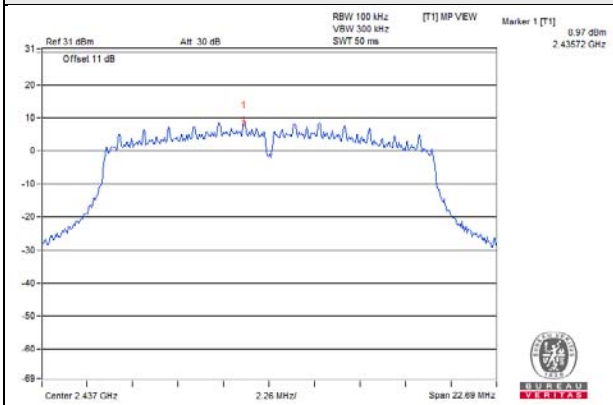

CH 11

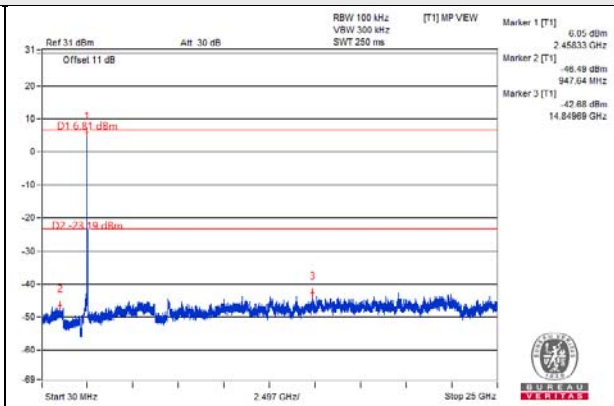
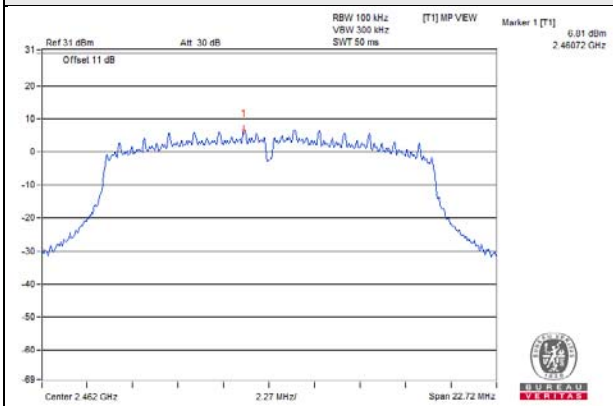

CH 1 Band edge

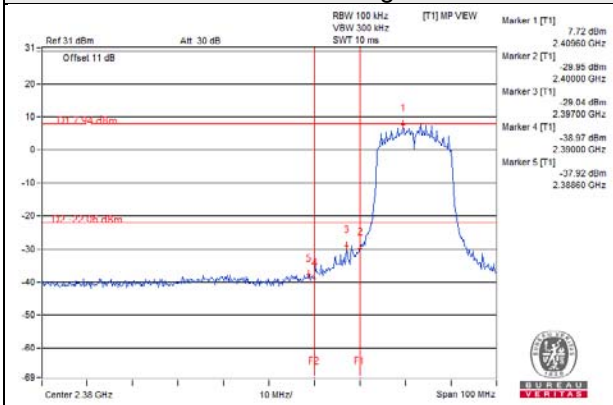

CH 11 Band edge

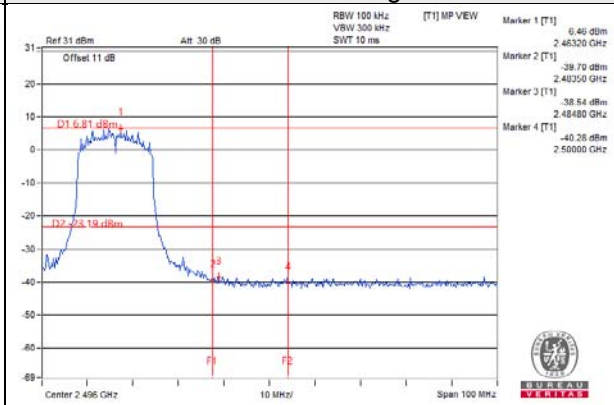

802.11n (VHT20)_Chain 0

CH 1

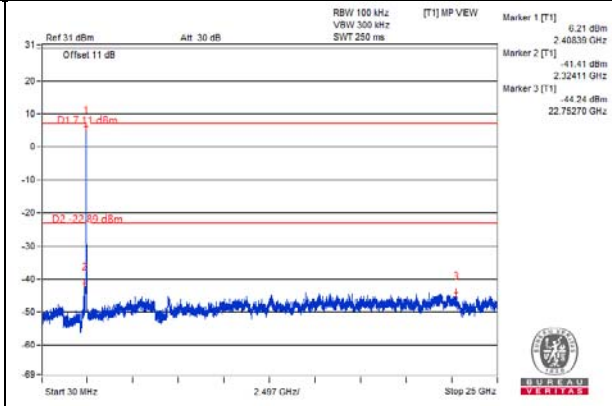
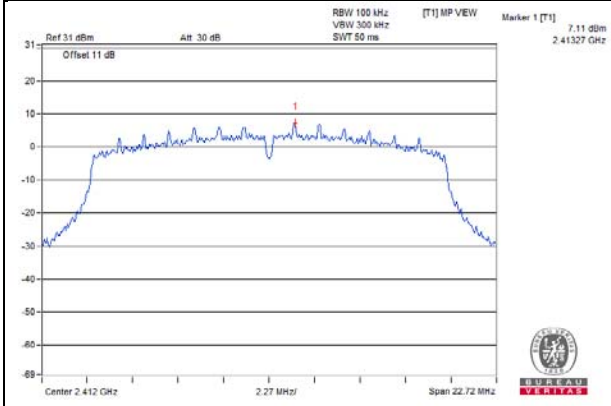

CH 6

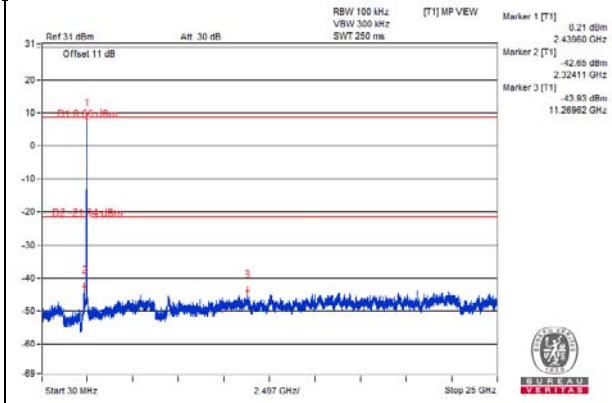
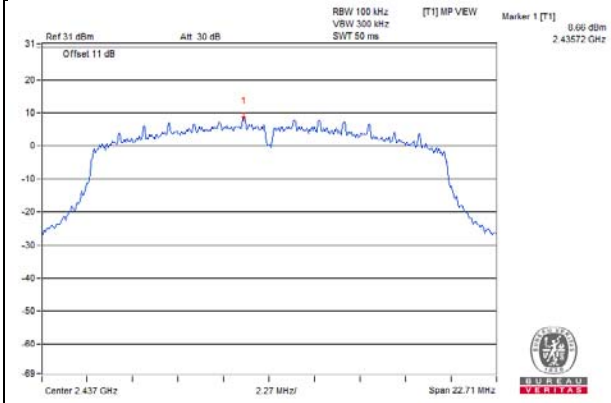

CH 11

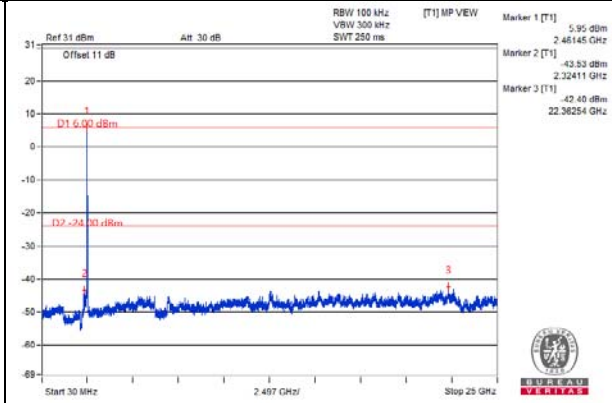
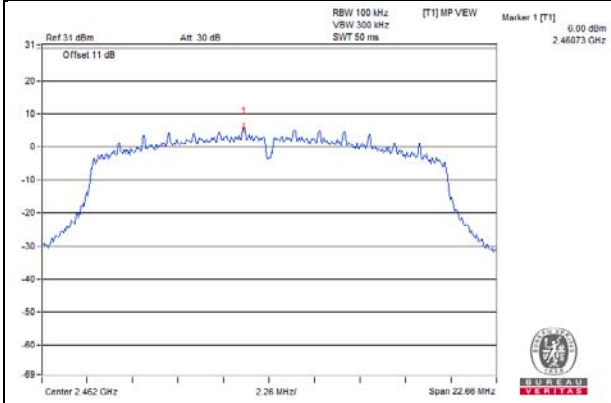

CH 1 Band edge

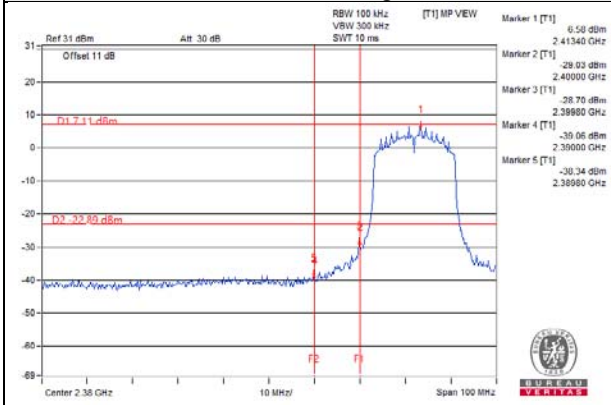

CH 11 Band edge

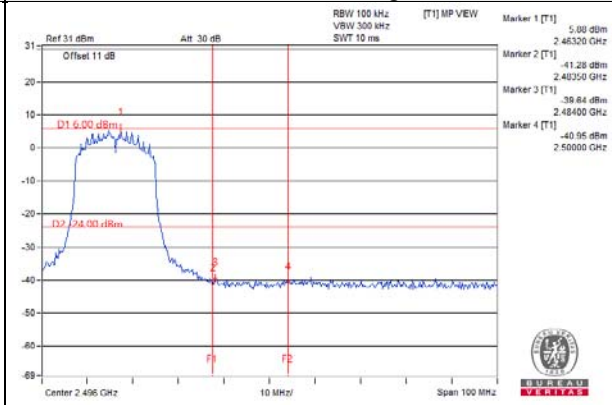

802.11n (VHT20)_Chain 1

CH 1

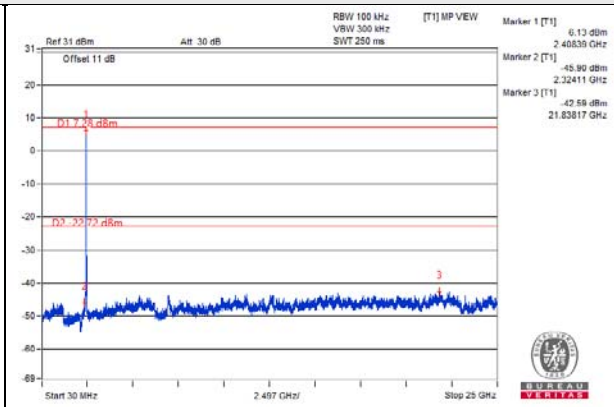
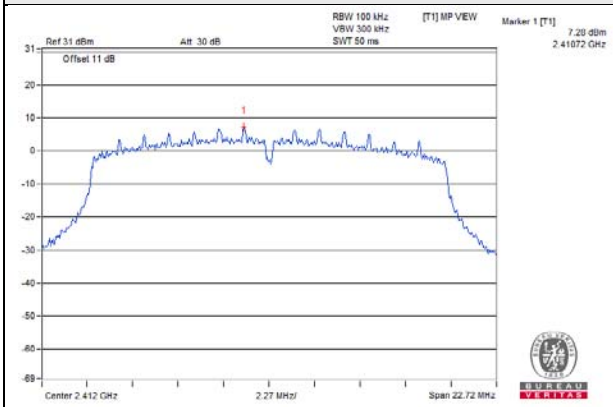

CH 6

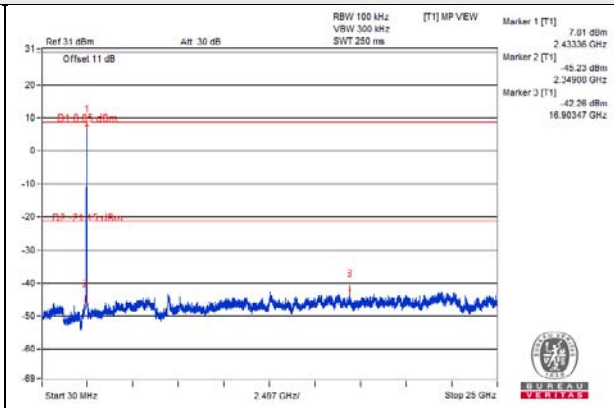
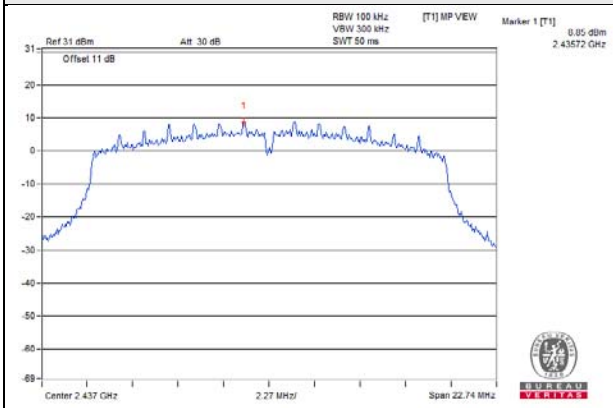

CH 11

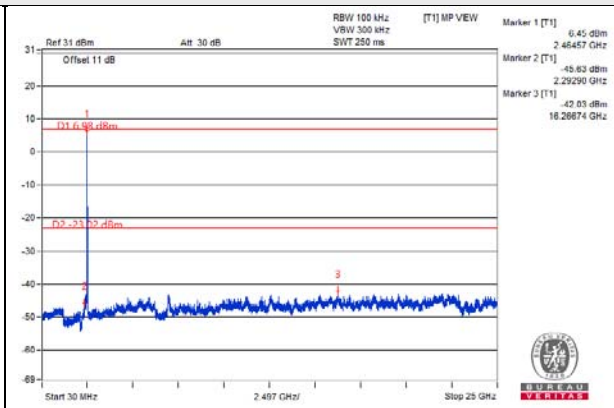
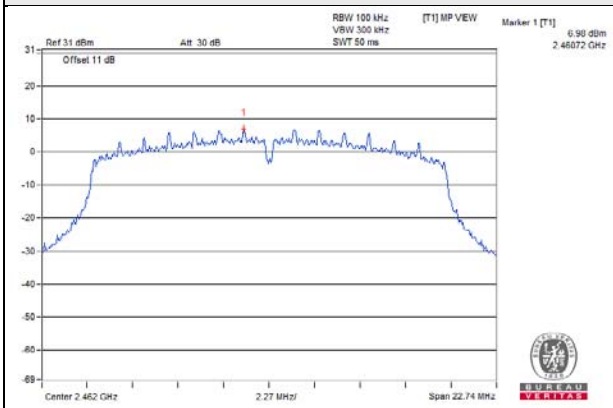

CH 1 Band edge

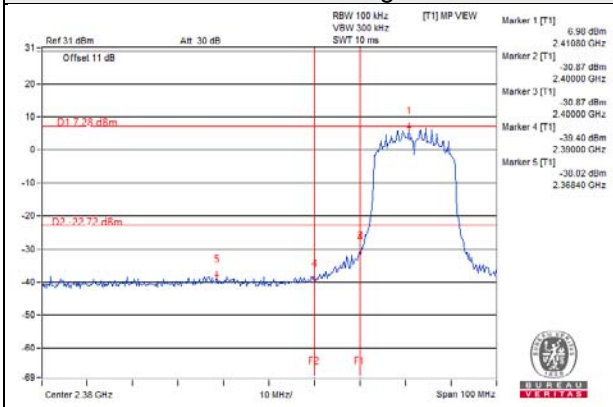

CH 11 Band edge

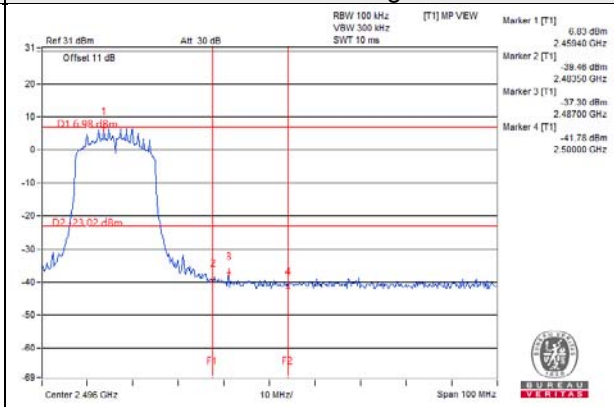

802.11n (VHT40)_Chain 0

CH 1

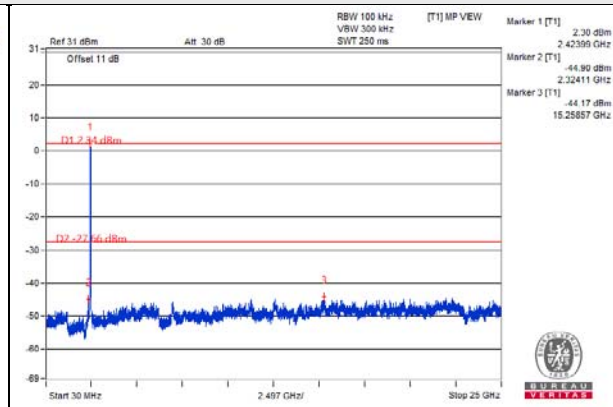
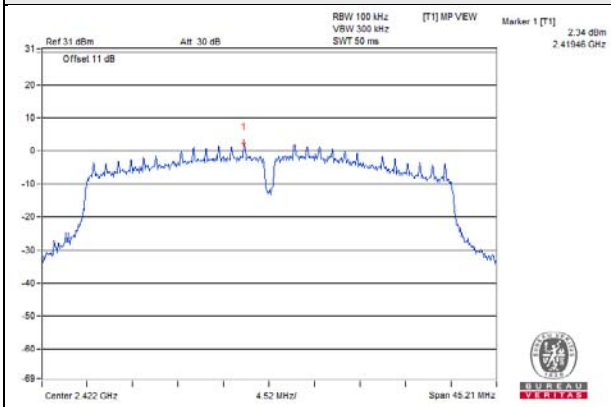

CH 6

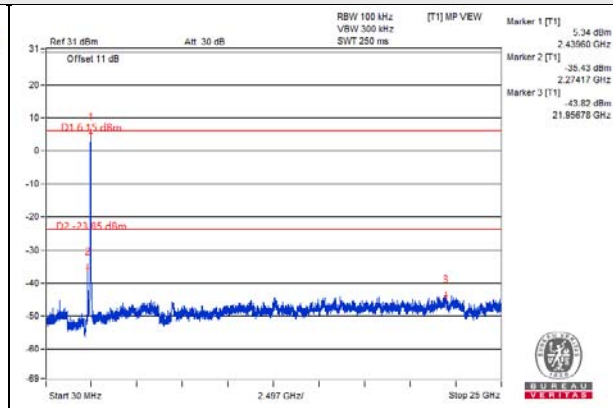
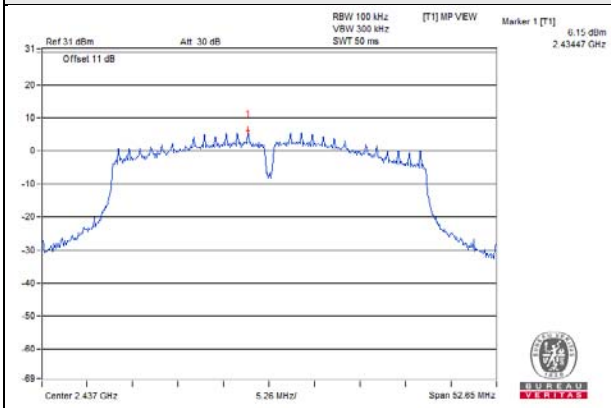

CH 11

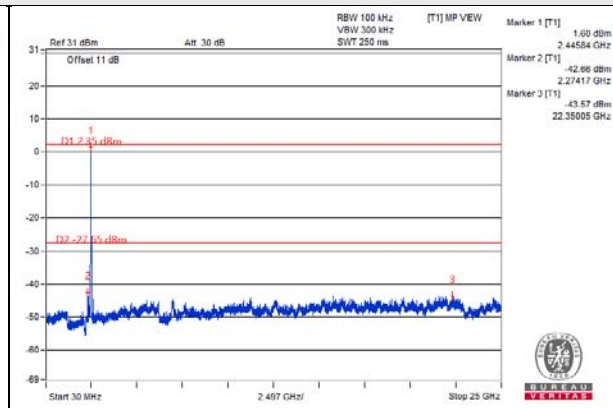
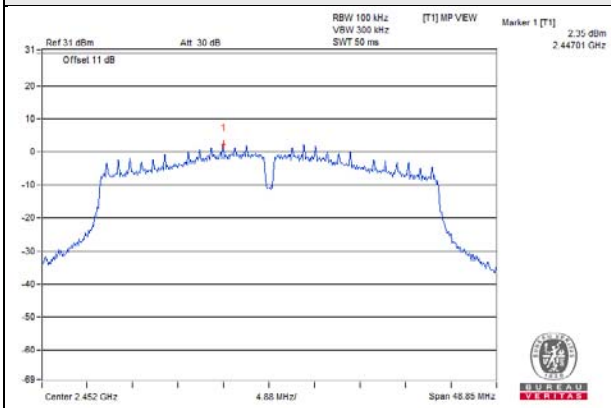

CH 1 Band edge

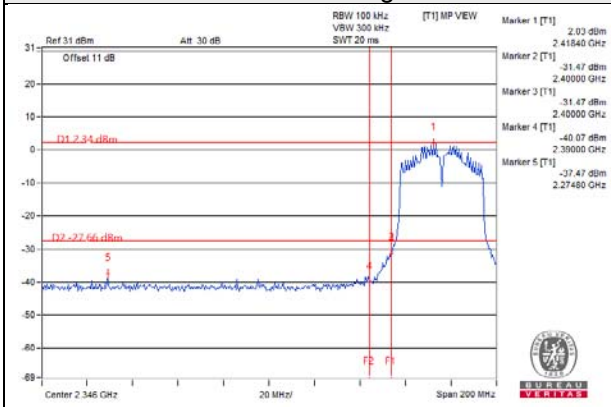

CH 11 Band edge

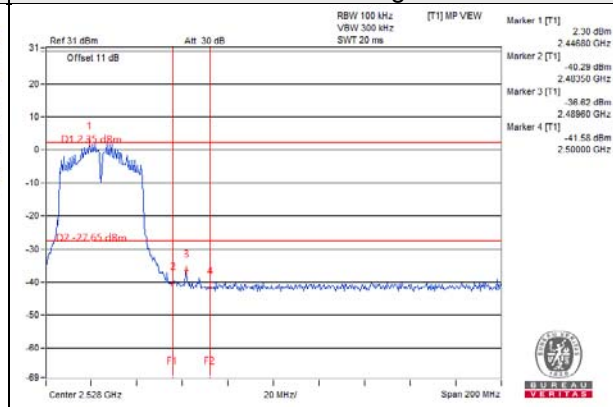

802.11n (VHT40)_Chain 1

CH 1

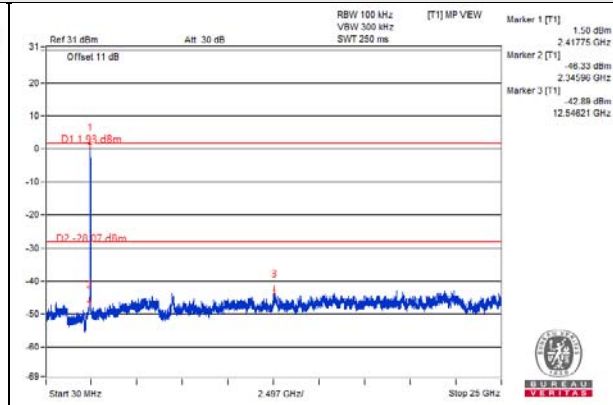
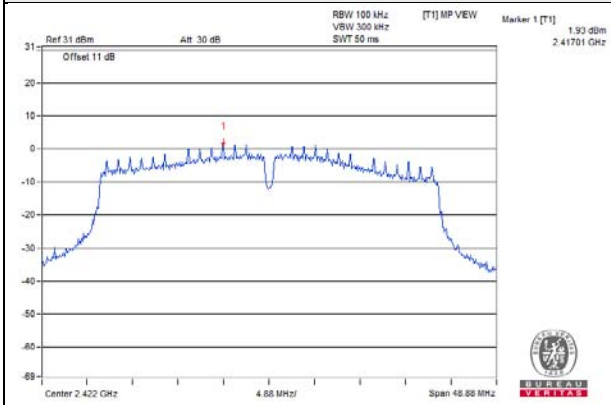

CH 6

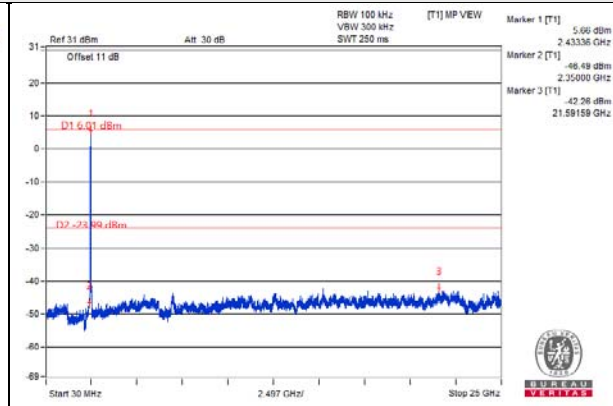
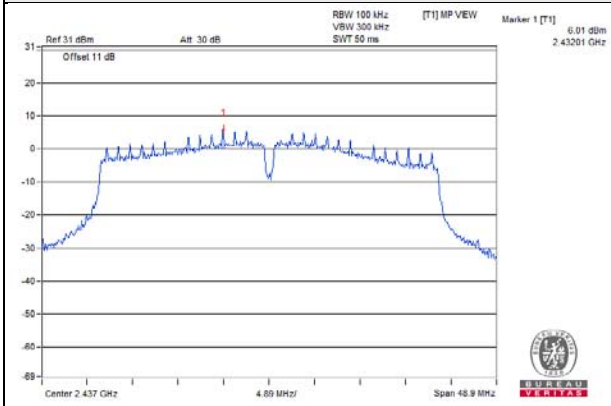

CH 11

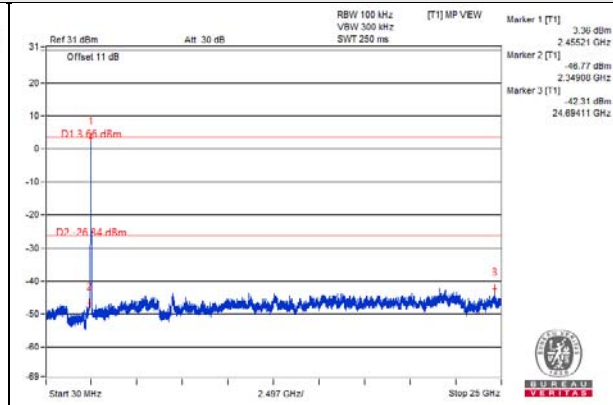
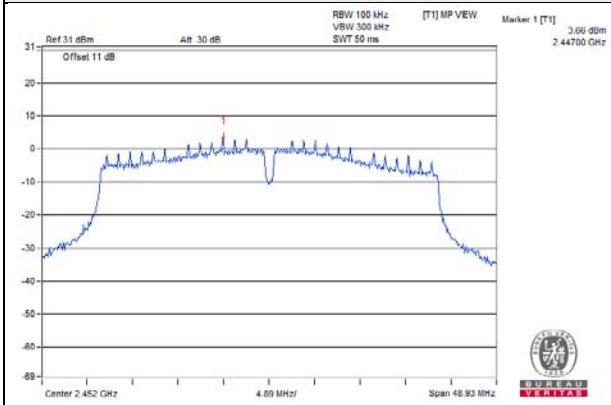

CH 1 Band edge

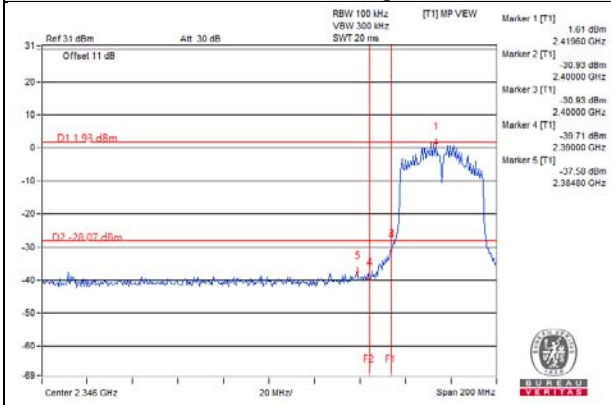

CH 11 Band edge

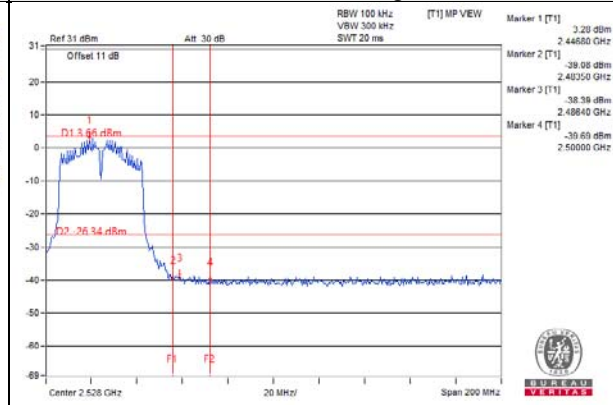

Annex A - Band Edge Measurement

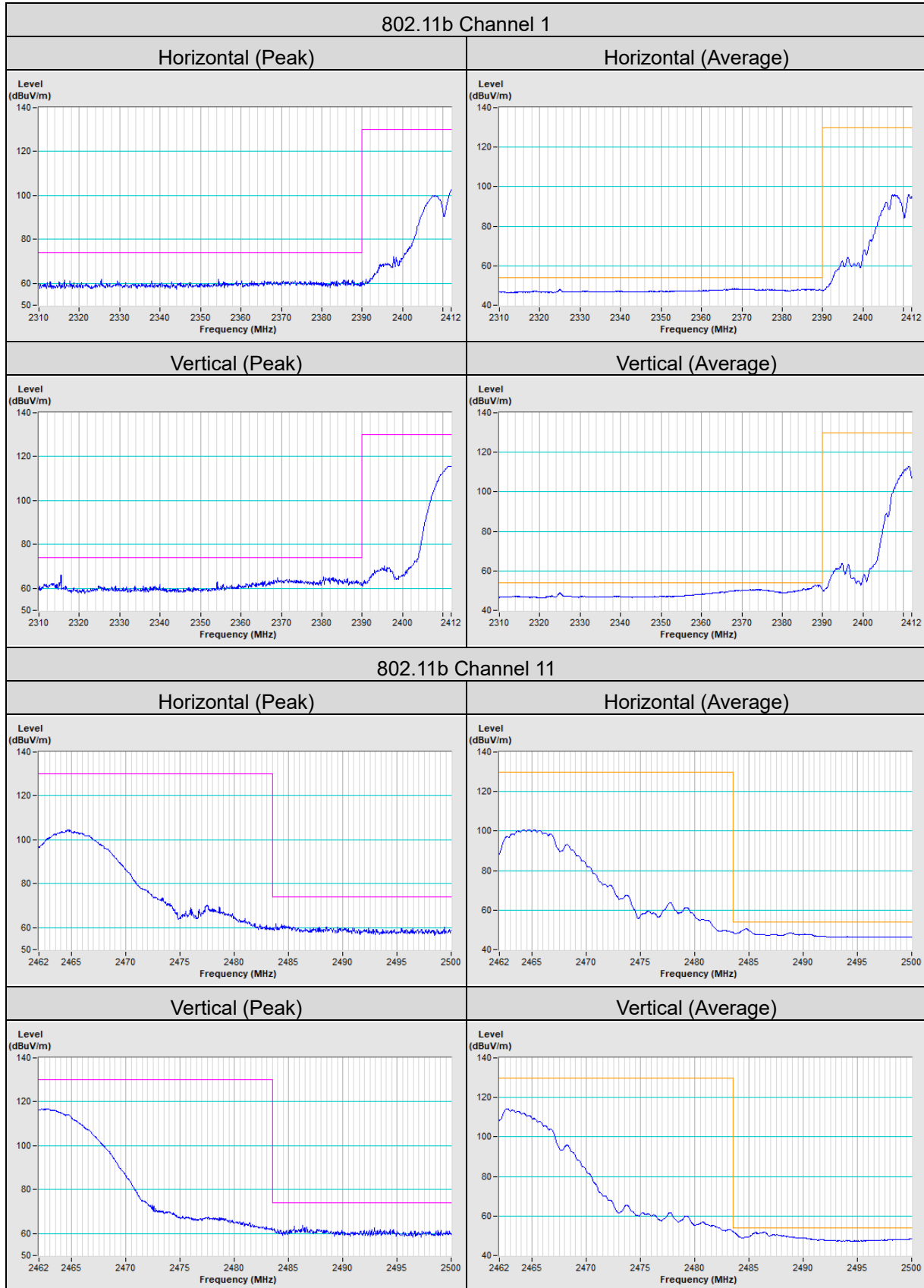

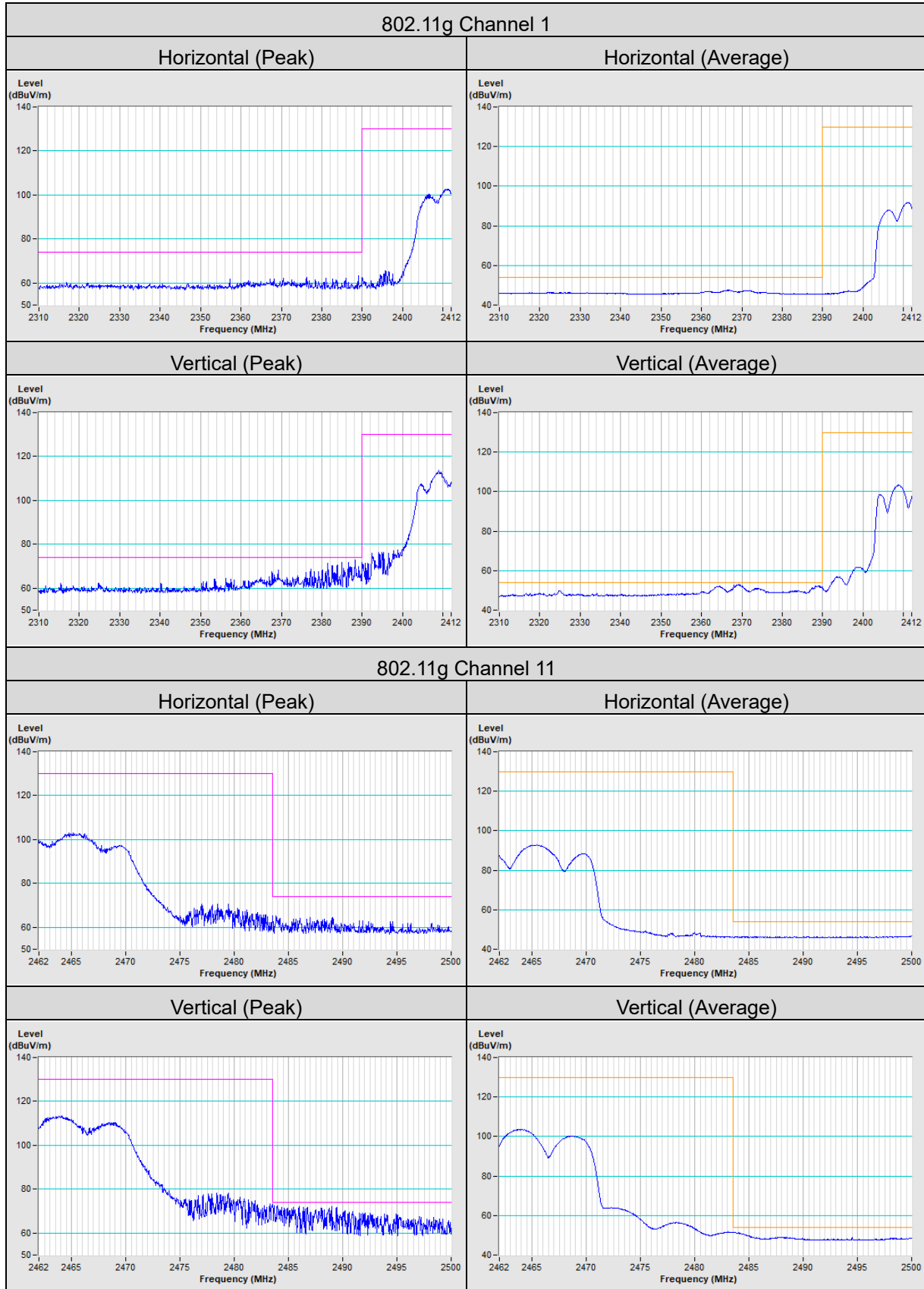

802.11n (VHT20) Channel 1

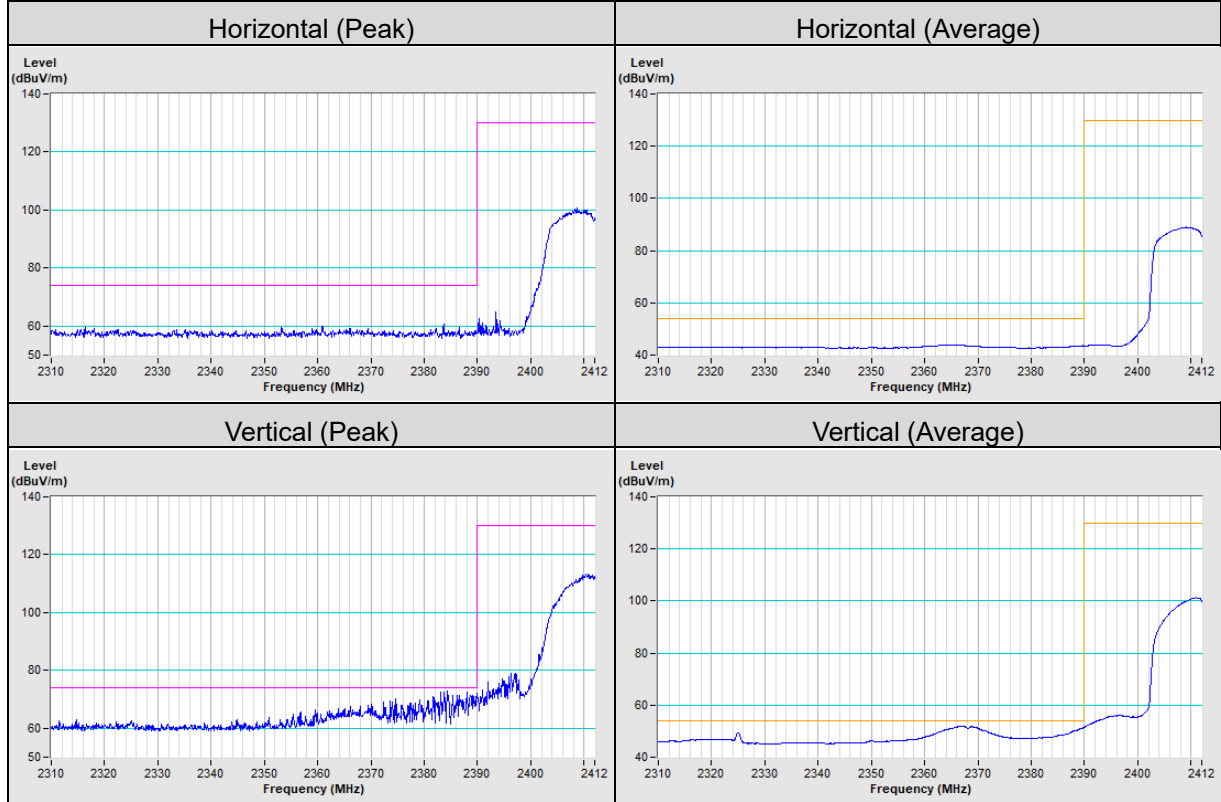

802.11n (VHT20) Channel 11

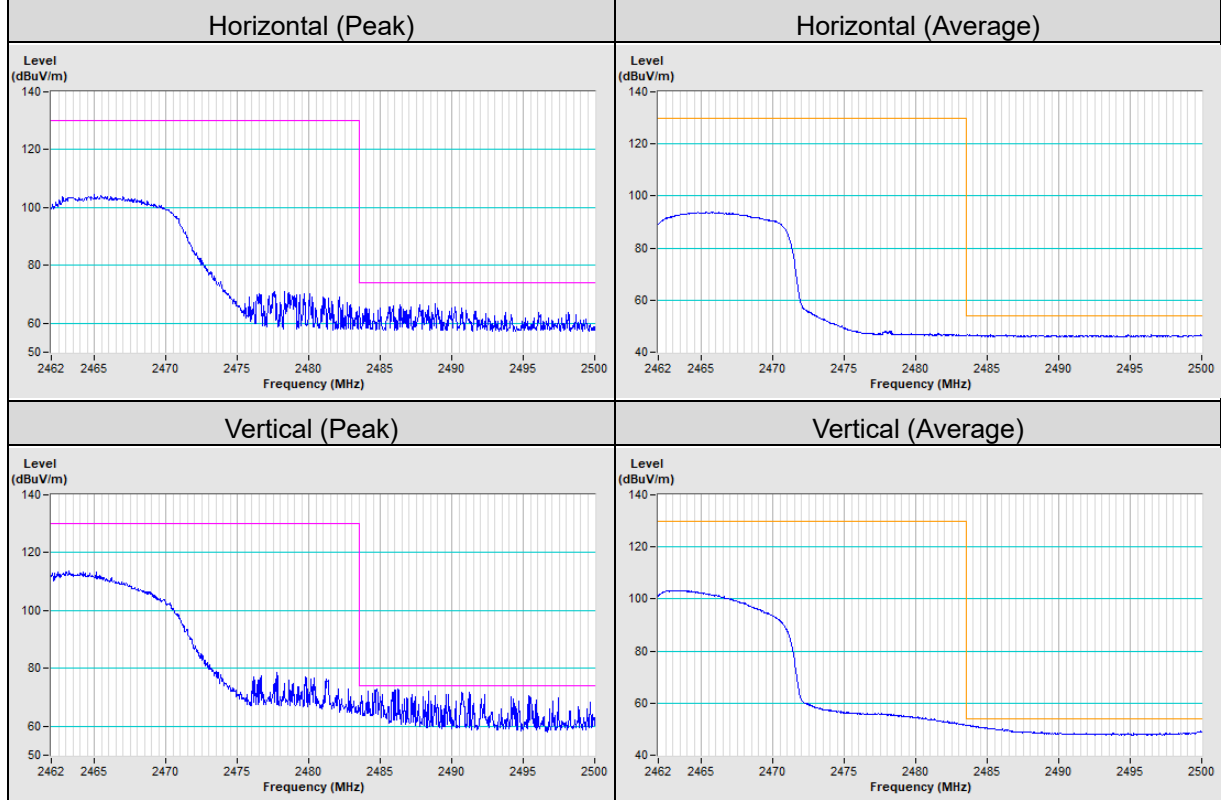

802.11n (VHT40) Channel 3

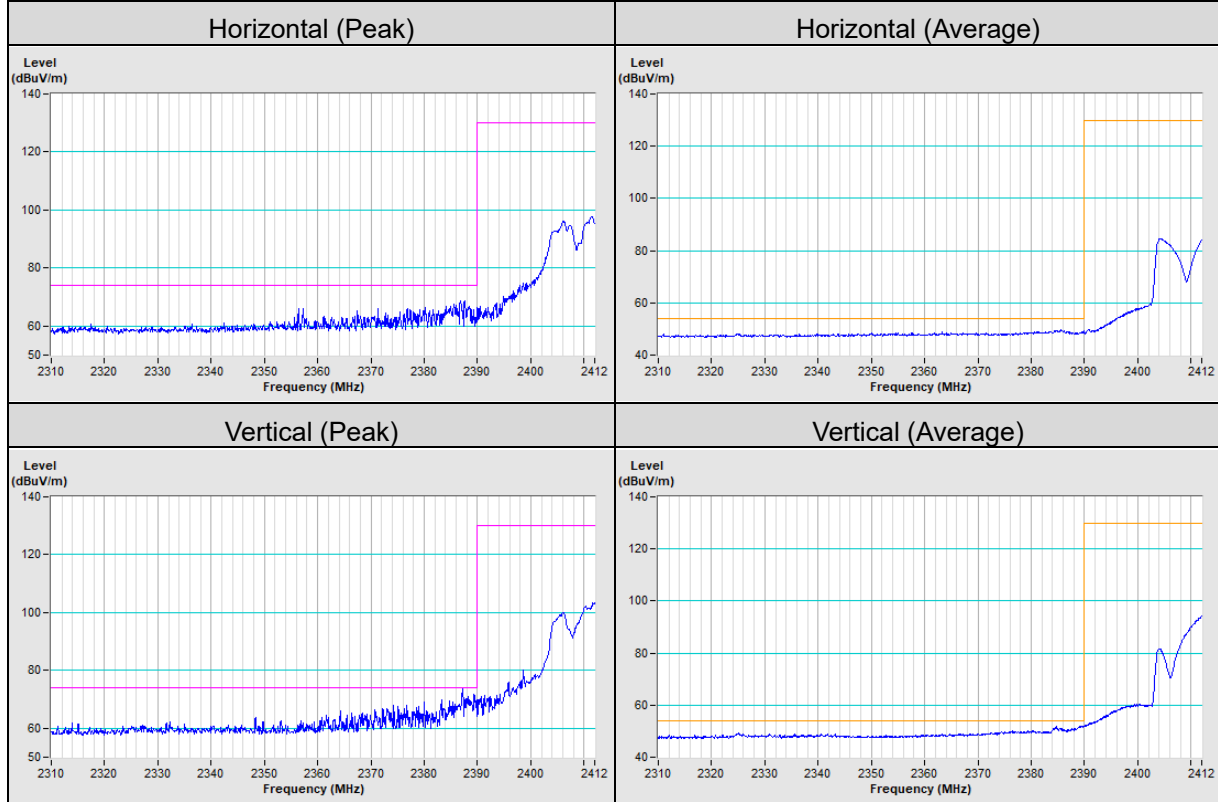

802.11n (VHT40) Channel 9

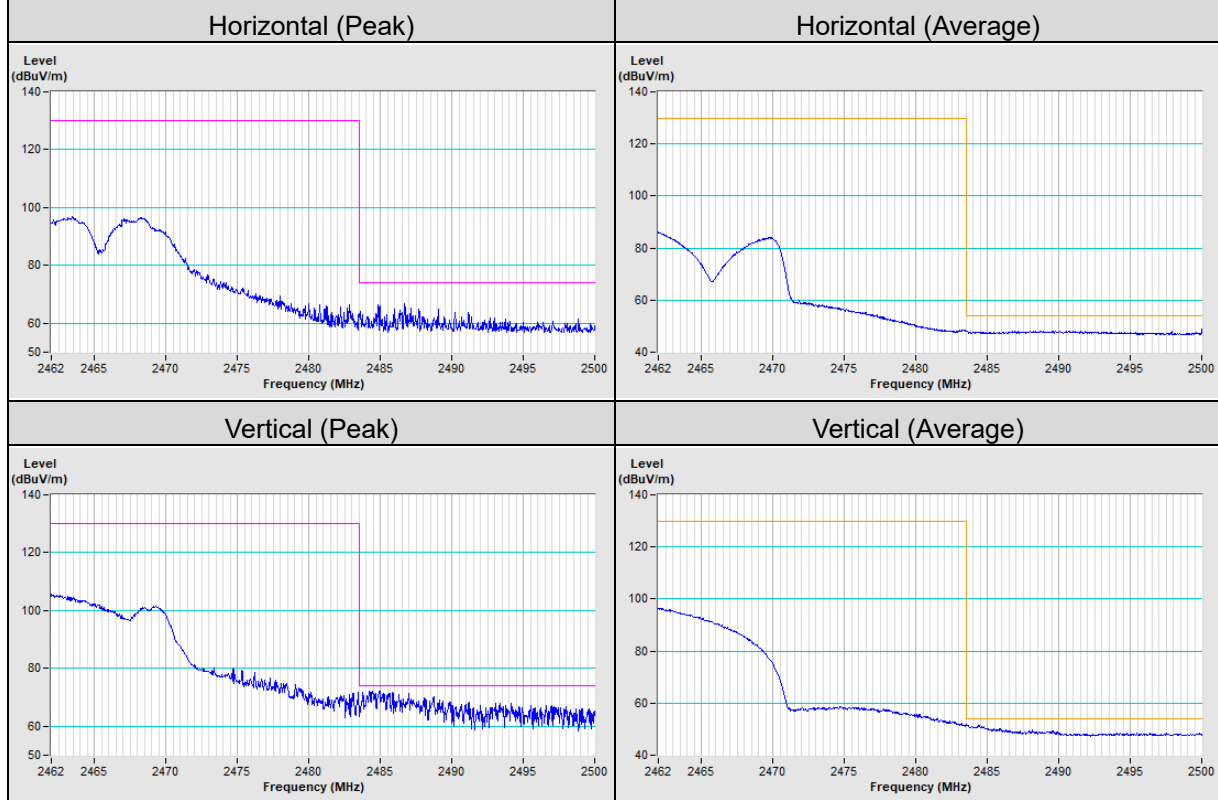

5 Pictures of Test Arrangements

Please refer to the attached file (Test Setup Photo).

Appendix – Information of the Testing Laboratories

We, Bureau Veritas Consumer Products Services (H.K.) Ltd., Taoyuan Branch, were founded in 1988 to provide our best service in EMC, Radio, Telecom and Safety consultation. Our laboratories are FCC recognized accredited test firms and accredited and approved according to ISO/IEC 17025.

If you have any comments, please feel free to contact us at the following:

Lin Kou EMC/RF Lab

Tel: 886-2-26052180

Fax: 886-2-26051924

Hsin Chu EMC/RF/Telecom Lab

Tel: 886-3-6668565

Fax: 886-3-6668323

Hwa Ya EMC/RF/Safety Lab

Tel: 886-3-3183232

Fax: 886-3-3270892

Email: service.adt@tw.bureauveritas.com

Web Site: www.bureauveritas-adt.com

The address and road map of all our labs can be found in our web site also.

--- END ---