

FCC Test Report

Report No.: RFDLK-WTW-P20080511-1

FCC ID: KA2IS2650APA1

Test Model: DIS-2650AP

Received Date: Aug. 26, 2020

Test Date: Sep. 28, 2020 ~ Sep. 30, 2020

Issued Date: Oct. 30, 2020

Applicant: D-Link Corporation

Address: No. 289, Sinhu 3rd Rd., Neihu District, Taipei City, 114, Taiwan

Issued By: Bureau Veritas Consumer Products Services (H.K.) Ltd., Taoyuan Branch
Lin Kou Laboratories

Lab Address: No. 47-2, 14th Ling, Chia Pau Vil., Lin Kou Dist., New Taipei City, Taiwan

Test Location: No.19, Hwa Ya 2nd Rd., Wen Hwa Vil., Kwei Shan Dist., Taoyuan City
33383, Taiwan

**FCC Registration /
Designation Number:** 788550 / TW0003



This report is for your exclusive use. Any copying or replication of this report to or for any other person or entity, or use of our name or trademark, is permitted only with our prior written permission. This report sets forth our findings solely with respect to the test samples identified herein. The results set forth in this report are not indicative or representative of the quality or characteristics of the lot from which a test sample was taken or any similar or identical product unless specifically and expressly noted. Our report includes all of the tests requested by you and the results thereof based upon the information that you provided to us. You have 60 days from date of issuance of this report to notify us of any material error or omission caused by our negligence, provided, however, that such notice shall be in writing and shall specifically address the issue you wish to raise. A failure to raise such issue within the prescribed time shall constitute your unqualified acceptance of the completeness of this report, the tests conducted and the correctness of the report contents. Unless specific mention, the uncertainty of measurement has been explicitly taken into account to declare the compliance or non-compliance to the specification.

Table of Contents

Release Control Record	4
1 Certificate of Conformity	5
2 Summary of Test Results	6
2.1 Measurement Uncertainty	6
2.2 Modification Record	6
3 General Information	7
3.1 General Description of EUT	7
3.2 Description of Test Modes	9
3.2.1 Test Mode Applicability and Tested Channel Detail	10
3.3 Duty Cycle of Test Signal	12
3.4 Description of Support Units	13
3.4.1 Configuration of System under Test	13
3.5 General Description of Applied Standards and References	14
4 Test Types and Results	15
4.1 Radiated Emission and Bandedge Measurement	15
4.1.1 Limits of Radiated Emission and Bandedge Measurement	15
4.1.2 Test Instruments	17
4.1.3 Test Procedures	19
4.1.4 Deviation from Test Standard	19
4.1.5 Test Setup	20
4.1.6 EUT Operating Conditions	21
4.1.7 Test Results	22
4.2 Conducted Emission Measurement	44
4.2.1 Limits of Conducted Emission Measurement	44
4.2.2 Test Instruments	44
4.2.3 Test Procedures	45
4.2.4 Deviation from Test Standard	45
4.2.5 Test Setup	45
4.2.6 EUT Operating Conditions	45
4.2.7 Test Results	46
4.3 Transmit Power Measurement	50
4.3.1 Limits of Transmit Power Measurement	50
4.3.2 Test Setup	50
4.3.3 Test Instruments	51
4.3.4 Test Procedure	51
4.3.5 Deviation from Test Standard	51
4.3.6 EUT Operating Conditions	51
4.3.7 Test Results	52
4.4 Occupied Bandwidth Measurement	57
4.4.1 Test Setup	57
4.4.2 Test Instruments	57
4.4.3 Test Procedure	57
4.4.4 Test Results	58
4.5 Peak Power Spectral Density Measurement	62
4.5.1 Limits of Peak Power Spectral Density Measurement	62
4.5.2 Test Setup	62
4.5.3 Test Instruments	62
4.5.4 Test Procedures	62
4.5.5 Deviation from Test Standard	63
4.5.6 EUT Operating Conditions	63
4.5.7 Test Results	64
4.6 Frequency Stability	70
4.6.1 Limit of Frequency Stability Measurement	70

4.6.2 Test Setup	70
4.6.3 Test Instruments	70
4.6.4 Test Procedure	70
4.6.5 Deviation from Test Standard	70
4.6.6 EUT Operating Condition	70
4.6.7 Test Results	71
4.7 6 dB Bandwidth Measurement.....	72
4.7.1 Limits of 6 dB Bandwidth Measurement.....	72
4.7.2 Test Setup.....	72
4.7.3 Test Instruments	72
4.7.4 Test Procedure	72
4.7.5 Deviation from Test Standard	72
4.7.6 EUT Operating Condition	72
4.7.7 Test Results	73
5 Pictures of Test Arrangements.....	75
Annex A- Radiated Out of Band Emission (OOBE) Measurement (For U-NII-3 band)	76
Annex B- Band-edge measurement.....	79
Appendix – Information of the Testing Laboratories	85

Release Control Record

Issue No.	Description	Date Issued
RFDLK-WTW-P20080511-1	Original Release	Oct. 30, 2020

1 Certificate of Conformity

Product: Wireless AC1200 Wave 2 Industrial indoor access point

Brand: D-Link

Test Model: DIS-2650AP

Sample Status: Engineering Sample

Applicant: D-Link Corporation

Test Date: Sep. 28, 2020 ~ Sep. 30, 2020

Standards: 47 CFR FCC Part 15, Subpart E (Section 15.407)
ANSI C63.10:2013

The above equipment has been tested by **Bureau Veritas Consumer Products Services (H.K.) Ltd., Taoyuan Branch**, and found compliance with the requirement of the above standards. The test record, data evaluation & Equipment Under Test (EUT) configurations represented herein are true and accurate accounts of the measurements of the sample's RF characteristics under the conditions specified in this report.

Prepared by :  , **Date:** Oct. 30, 2020
Shelly Hsueh / Specialist

Approved by :  , **Date:** Oct. 30, 2020
Dylan Chiou / Senior Project Engineer

2 Summary of Test Results

47 CFR FCC Part 15, Subpart E (Section 15.407)			
FCC Clause	Test Item	Result	Remarks
15.407(b)(6)	AC Power Conducted Emissions	Pass	Meet the requirement of limit. Minimum passing margin is -3.85 dB at 0.398 MHz.
15.407(b)(1/2/3/4(i/ii)/6)	Radiated Emissions & Band Edge Measurement	Pass	Meet the requirement of limit. Minimum passing margin is -0.13 dB at 5150 MHz.
15.407(a)(1/2/3)	Max Average Transmit Power	Pass	Meet the requirement of limit.
---	Occupied Bandwidth Measurement	-	Reference only
15.407(a)(1/2/3)	Peak Power Spectral Density	Pass	Meet the requirement of limit.
15.407(e)	6 dB Bandwidth	Pass	Meet the requirement of limit. (U-NII-3 Band only)
15.407(g)	Frequency Stability	Pass	Meet the requirement of limit.
15.203	Antenna Requirement	Pass	Antenna connector is SMA Male Reverse connector not a standard connector.

Note:

- For U-NII-3 band compliance with rule part 15.407(b)(4)(i), the OOB test plots were recorded in Annex A.
- For U-NII-1 band compliance with rule 15.407(b) of the band-edge items, the test plots were recorded in Annex B. Test Procedures refer to report 4.1.3.
- Determining compliance based on the results of the compliance measurement, not taking into account measurement instrumentation uncertainty.

2.1 Measurement Uncertainty

Where relevant, the following measurement uncertainty levels have been estimated for tests performed on the EUT as specified in CISPR 16-4-2:

Measurement	Frequency	Expanded Uncertainty (k=2) (\pm)
Conducted Emissions at mains ports	150 kHz ~ 30 MHz	2.79 dB
Radiated Emissions up to 1 GHz	9 kHz ~ 30 MHz	3.04 dB
	30 MHz ~ 200 MHz	2.93 dB
	200 MHz ~ 1000 MHz	2.95 dB
Radiated Emissions above 1 GHz	1 GHz ~ 18 GHz	2.26 dB
	18 GHz ~ 40 GHz	1.94 dB

2.2 Modification Record

There were no modifications required for compliance.

3 General Information

3.1 General Description of EUT

Product	Wireless AC1200 Wave 2 Industrial indoor access point
Brand	D-Link
Test Model	DIS-2650AP
Status of EUT	Engineering Sample
Power Supply Rating	48 Vdc (from POE) 12Vdc (from DC power source)
Modulation Type	256QAM, 64QAM, 16QAM, QPSK, BPSK
Modulation Technology	OFDM
Transfer Rate	802.11a: 54.0/ 48.0/ 36.0/ 24.0/ 18.0/ 12.0/ 9.0/ 6.0 Mbps 802.11n: up to 300Mbps 802.11ac: up to 867Mbps
Operating Frequency	5180 ~ 5240 MHz, 5745 ~ 5825 MHz
Number of Channel	5180 ~ 5240 MHz: 4 for 802.11a, 802.11n (HT20), 802.11ac (VHT20) 2 for 802.11n (HT40), 802.11ac (VHT40) 1 for 802.11ac (VHT80) 5745 ~ 5825 MHz: 5 for 802.11a, 802.11n (HT20), 802.11ac (VHT20) 2 for 802.11n (HT40), 802.11ac (VHT40) 1 for 802.11ac (VHT80)
Output Power	CDD Mode: 299.716 mW for 5180 ~ 5240 MHz 367.378 mW for 5745 ~ 5825 MHz Beamforming Mode: 290.472 mW for 5180 ~ 5240 MHz 367.378 mW for 5745 ~ 5825 MHz
Antenna Type	Dipole antenna with 4.33 dBi gain (5180 ~ 5240 MHz) Dipole antenna with 5.74 dBi gain (5745 ~ 5825 MHz)
Antenna Connector	SMA Male Reverse
Accessory Device	N/A
Data Cable Supplied	N/A

Note:

- The EUT incorporates a MIMO function. Physically, the EUT provides 2 completed transmitters and 2 receivers.

Modulation Mode	CDD Mode	Beamforming Mode
802.11a	Support	Not Support
802.11n (HT20)	Support	Support
802.11n (HT40)	Support	Support
802.11ac (VHT20)	Support	Support
802.11ac (VHT40)	Support	Support
802.11ac (VHT80)	Support	Support

* The modulation and bandwidth are similar for 802.11n mode for HT20 / HT40 and 802.11ac mode for VHT20 / VHT40, therefore investigated worst case to representative mode in test report. (Final test mode refer section 3.2.1)

2. The above Antenna information is declared by manufacturer and for more detailed features description, please refer to the manufacturer's specifications, the laboratory shall not be held responsible.
3. The above EUT information is declared by manufacturer and for more detailed features description, please refers to the manufacturer's specifications or user's manual.

3.2 Description of Test Modes

For 5180 ~ 5240 MHz

4 channels are provided for 802.11a, 802.11n (HT20), 802.11ac (VHT20):

Channel	Frequency (MHz)	Channel	Frequency (MHz)
36	5180	44	5220
40	5200	48	5240

2 channels are provided for 802.11n (HT40), 802.11ac (VHT40):

Channel	Frequency (MHz)	Channel	Frequency (MHz)
38	5190	46	5230

1 channel is provided for 802.11ac (VHT80):

Channel	Frequency (MHz)
42	5210

For 5745 ~ 5825 MHz:

5 channels are provided for 802.11a, 802.11n (HT20), 802.11ac (VHT20):

Channel	Frequency (MHz)	Channel	Frequency (MHz)
149	5745	161	5805
153	5765	165	5825
157	5785		

2 channels are provided for 802.11n (HT40), 802.11ac (VHT40):

Channel	Frequency (MHz)	Channel	Frequency (MHz)
151	5755	159	5795

1 channel is provided for 802.11ac (VHT80):

Channel	Frequency (MHz)
155	5775

3.2.1 Test Mode Applicability and Tested Channel Detail

EUT Configure Mode	Applicable To				Description
	RE≥1G	RE<1G	PLC	APCM	
A	√	√	√	√	Power from POE
B	-	√	√	-	Power from DC Source

Where **RE≥1G**: Radiated Emission above 1 GHz **RE<1G**: Radiated Emission below 1 GHz
PLC: Power Line Conducted Emission **APCM**: Antenna Port Conducted Measurement

NOTE: The EUT had been pre-tested on the positioned of each 3 axis. The worst case was found when positioned on **Z-plane**.
NOTE: For radiated emission (below 1GHz) and power line conducted emission test items, the worst maximum power was selected.
NOTE: "-" means no effect.

Radiated Emission Test (Above 1 GHz):

- Pre-Scan has been conducted to determine the worst-case mode from all possible combinations between available modulations, data rates and antenna ports (if EUT with antenna diversity architecture).
- Following channel(s) was (were) selected for the final test as listed below.

EUT Configure Mode	Frequency Band (MHz)	Mode	Available Channel	Tested Channel	Modulation Technology	Modulation Type	Data Rate (Mbps)
A	5180-5240	802.11a	36 to 48	36, 40, 48	OFDM	BPSK	6.0
A		802.11ac (VHT20)	36 to 48	36, 40, 48	OFDM	BPSK	6.5
A		802.11ac (VHT40)	38 to 46	38, 46	OFDM	BPSK	13.5
A		802.11ac (VHT80)	42	42	OFDM	BPSK	29.3
A	5745-5825	802.11a	149 to 165	149, 157, 165	OFDM	BPSK	6.0
A		802.11ac (VHT20)	149 to 165	149, 157, 165	OFDM	BPSK	6.5
A		802.11ac (VHT40)	151 to 159	151, 159	OFDM	BPSK	13.5
A		802.11ac (VHT80)	155	155	OFDM	BPSK	29.3

Radiated Emission Test (Below 1 GHz):

- Pre-Scan has been conducted to determine the worst-case mode from all possible combinations between available modulations, data rates and antenna ports (if EUT with antenna diversity architecture).
- Following channel(s) was (were) selected for the final test as listed below.

EUT Configure Mode	Frequency Band (MHz)	Mode	Available Channel	Tested Channel	Modulation Technology	Modulation Type	Data Rate (Mbps)
A, B	5180-5240	802.11n (HT20)	36 to 48	36	OFDM	BPSK	6.5

Power Line Conducted Emission Test:

- Pre-Scan has been conducted to determine the worst-case mode from all possible combinations between available modulations, data rates and antenna ports (if EUT with antenna diversity architecture).
- Following channel(s) was (were) selected for the final test as listed below.

EUT Configure Mode	Frequency Band (MHz)	Mode	Available Channel	Tested Channel	Modulation Technology	Modulation Type	Data Rate (Mbps)
A, B	5180-5240	802.11n (HT20)	36 to 48	36	OFDM	BPSK	6.5

Antenna Port Conducted Measurement:

- This item includes all test value of each mode, but only includes spectrum plot of worst value of each mode.
- Pre-Scan has been conducted to determine the worst-case mode from all possible combinations between available modulations, data rates and antenna ports (if EUT with antenna diversity architecture).
- Following channel(s) was (were) selected for the final test as listed below.

EUT Configure Mode	Frequency Band (MHz)	Mode	Available Channel	Tested Channel	Modulation Technology	Modulation Type	Data Rate (Mbps)
A	5180-5240	802.11a	36 to 48	36, 40, 48	OFDM	BPSK	6.0
A		802.11ac (VHT20)	36 to 48	36, 40, 48	OFDM	BPSK	6.5
A		802.11ac (VHT40)	38 to 46	38, 46	OFDM	BPSK	13.5
A		802.11ac (VHT80)	42	42	OFDM	BPSK	29.3
A	5745-5825	802.11a	149 to 165	149, 157, 165	OFDM	BPSK	6.0
A		802.11ac (VHT20)	149 to 165	149, 157, 165	OFDM	BPSK	6.5
A		802.11ac (VHT40)	151 to 159	151, 159	OFDM	BPSK	13.5
A		802.11ac (VHT80)	155	155	OFDM	BPSK	29.3

Test Condition:

Applicable To	Environmental Conditions	Input Power	Tested by
RE \geq 1G	25 deg. C, 65 % RH	120 Vac, 60 Hz	Cyril Chen
RE $<$ 1G	25 deg. C, 65 % RH	120 Vac, 60 Hz	Tim Chen
PLC	25 deg. C, 65 % RH	120 Vac, 60 Hz	Cyril Chen
APCM	25 deg. C, 65 % RH	48 Vdc	Ivan Tseng

3.3 Duty Cycle of Test Signal

MODULATION TYPE: BPSK

Duty cycle of test signal is $\geq 98\%$, duty factor is not required.

Duty cycle of test signal is $< 98\%$, duty factor is required.

802.11a: Duty cycle = $2.005/2.115 = 0.948$, Duty factor = $10 * \log(1/0.948) = 0.23$

802.11ac (VHT20): Duty cycle = $4.925/5.025 = 0.98$

802.11ac (VHT40): Duty cycle = $2.415/2.485 = 0.972$, Duty factor = $10 * \log(1/0.972) = 0.12$

802.11ac (VHT80): Duty cycle = $1.12/1.205 = 0.929$, Duty factor = $10 * \log(1/0.929) = 0.32$

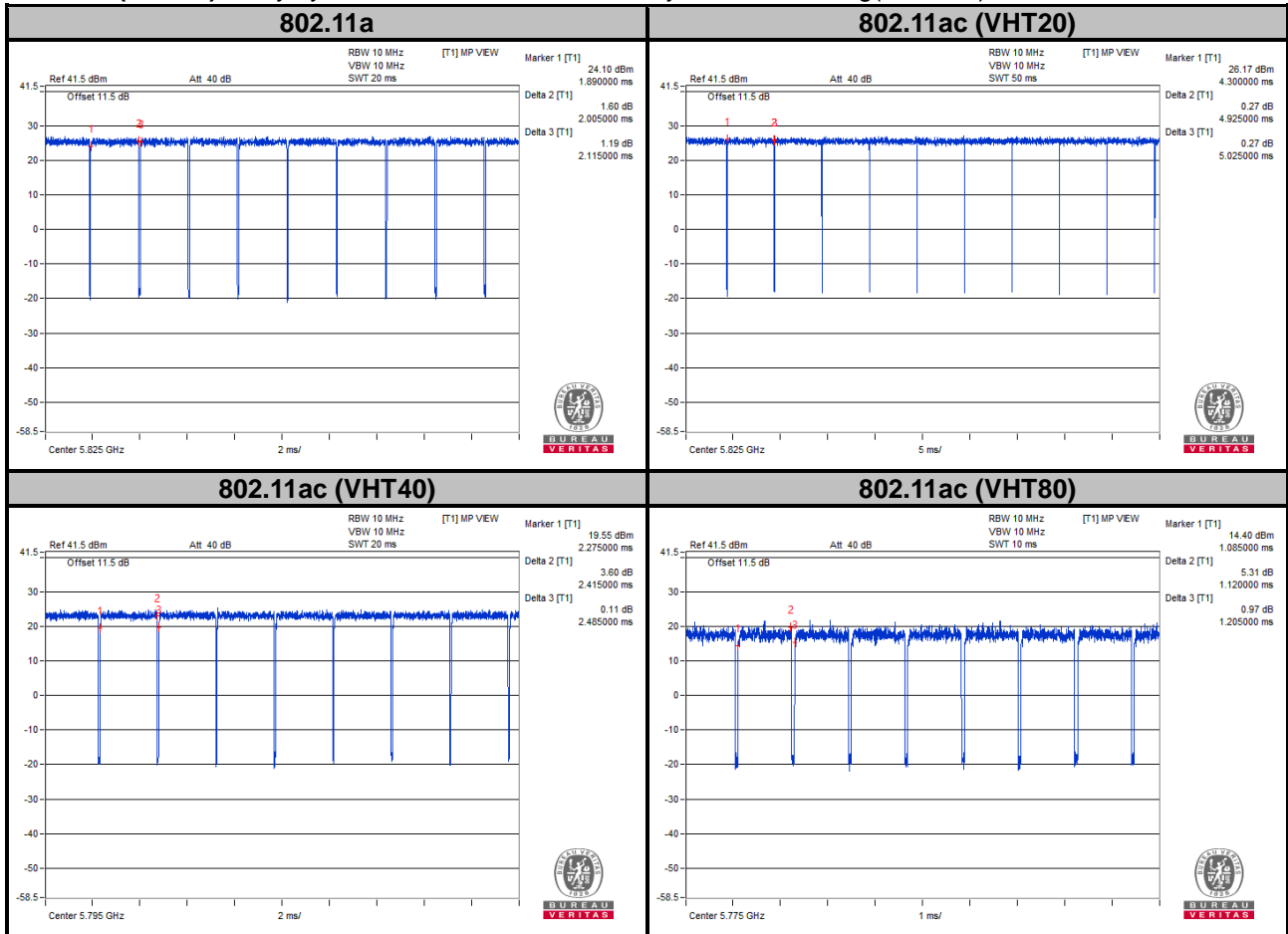

3.4 Description of Support Units

The EUT has been tested as an independent unit together with other necessary accessories or support units. The following support units or accessories were used to form a representative test configuration during the tests.

No.	Product	Brand	Model No.	Serial No.	FCC ID
1.	POE	PLANET	POE-171A-95	N/A	N/A
2.	DC Power Supply	GAIRAUGUS	33010D	807748	N/A

Note:

1. All power cords of the above support units are non-shielded (1.8m).

3.4.1 Configuration of System under Test

Mode A

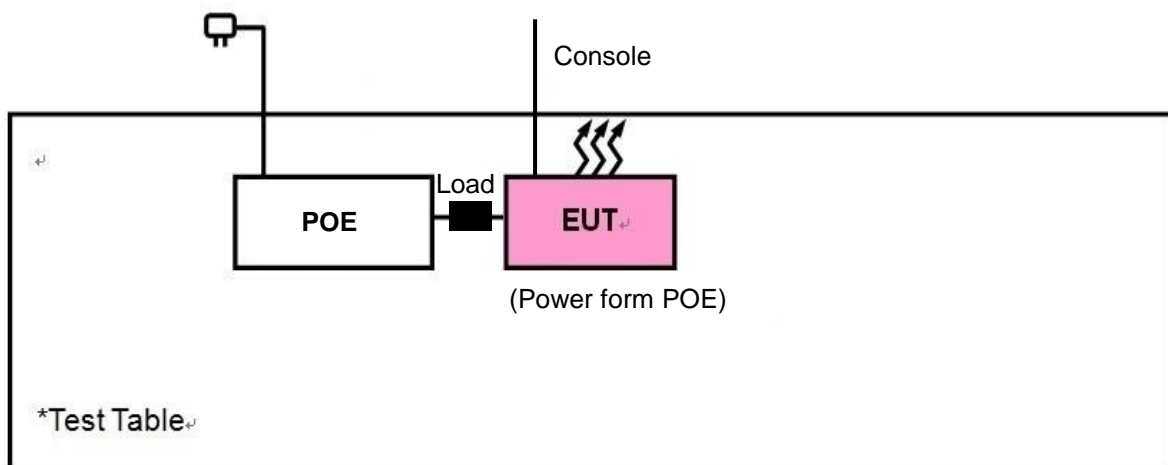

Mode B

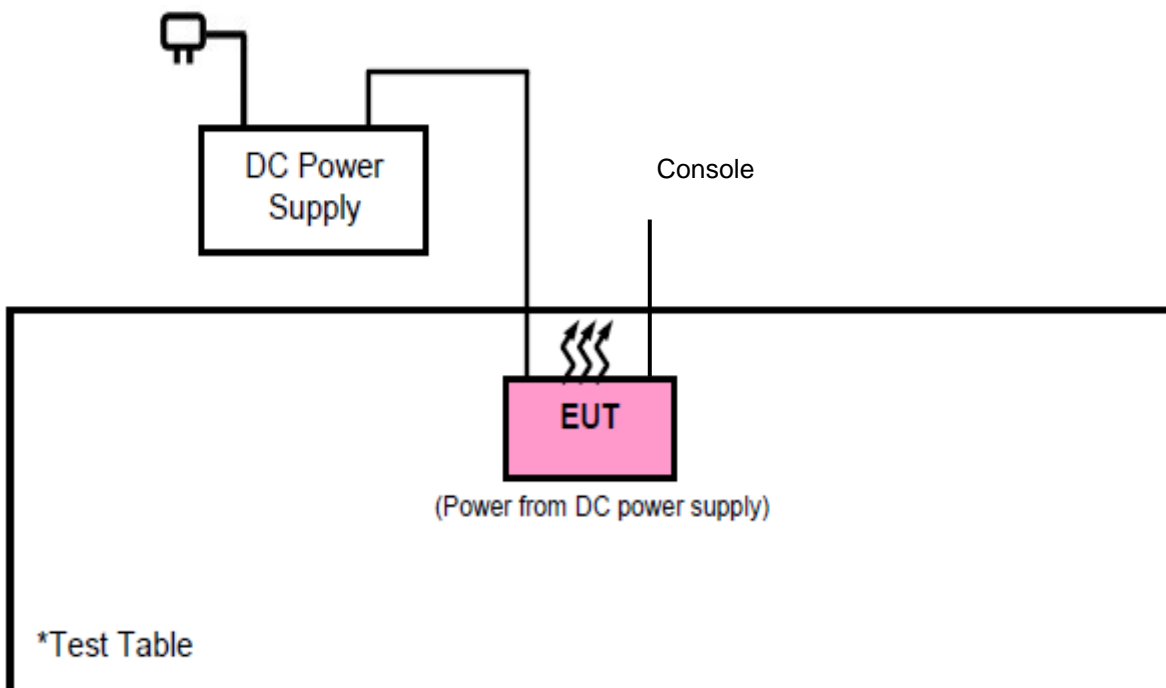

3.5 General Description of Applied Standards and References

The EUT is a RF Product. According to the specifications of the manufacturer, it must comply with the requirements of the following standards and references:

Test Standard:

FCC Part 15, Subpart E (15.407)

ANSI C63.10-2013

All test items have been performed and recorded as per the above standards.

References Test Guidance:

KDB 789033 D02 General UNII Test Procedures New Rules v02r01

KDB 662911 D01 Multiple Transmitter Output v02r01

All test items have been performed as a reference to the above KDB test guidance.

4 Test Types and Results

4.1 Radiated Emission and Bandedge Measurement

4.1.1 Limits of Radiated Emission and Bandedge Measurement

Radiated emissions which fall in the restricted bands must comply with the radiated emission limits specified as below table.

Frequencies (MHz)	Field Strength (microvolts/meter)	Measurement Distance (meters)
0.009 ~ 0.490	2400/F (kHz)	300
0.490 ~ 1.705	24000/F (kHz)	30
1.705 ~ 30.0	30	30
30 ~ 88	100	3
88 ~ 216	150	3
216 ~ 960	200	3
Above 960	500	3

Note:

1. The lower limit shall apply at the transition frequencies.
2. Emission level (dBuV/m) = 20 log Emission level (uV/m).
3. For frequencies above 1000 MHz, the field strength limits are based on average detector, however, the peak field strength of any emission shall not exceed the maximum permitted average limits, specified above by more than 20 dB under any condition of modulation.

Limits of Unwanted Emission Out of the Restricted Bands

Applicable To		Limit	
789033 D02 General UNII Test Procedures New Rules v02r01		Field Strength at 3 m	
		PK: 74 (dBµV/m)	AV: 54 (dBµV/m)
Frequency Band	Applicable To	EIRP Limit	Equivalent Field Strength at 3 m
5150~5250 MHz	15.407(b)(1)	PK: -27 (dBm/MHz)	PK: 68.2 (dBµV/m)
5250~5350 MHz	15.407(b)(2)		
5470~5725 MHz	15.407(b)(3)		
5725~5850 MHz	<input checked="" type="checkbox"/> 15.407(b)(4)(i)	PK:-27 (dBm/MHz) *1 PK:10 (dBm/MHz) *2 PK:15.6 (dBm/MHz) *3 PK:27 (dBm/MHz) *4	PK: 68.2 (dBµV/m) *1 PK:105.2 (dBµV/m) *2 PK: 110.8 (dBµV/m) *3 PK:122.2 (dBµV/m) *4
	<input type="checkbox"/> 15.407(b)(4)(ii)	Emission limits in section 15.247(d)	
<p>*1 beyond 75 MHz or more above of the band edge.</p> <p>*2 below the band edge increasing linearly to 10 dBm/MHz at 25 MHz above.</p> <p>*3 below the band edge increasing linearly to a level of 15.6 dBm/MHz at 5 MHz above.</p> <p>*4 from 5 MHz above or below the band edge increasing linearly to a level of 27 dBm/MHz at the band edge.</p>			

Note:

The following formula is used to convert the equipment isotropic radiated power (eirp) to field strength:

$$E = \frac{1000000\sqrt{30P}}{3} \mu\text{V/m, where P is the eirp (Watts).$$

4.1.2 Test Instruments

Description & Manufacturer	Model No.	Serial No.	Date of Calibration	Due Date of Calibration
Test Receiver Agilent	N9038A	MY51210203	Mar. 18, 2020	Mar. 17, 2021
Spectrum Analyzer Agilent	N9010A	MY52220314	Dec. 12, 2019	Dec. 11, 2020
Spectrum Analyzer ROHDE & SCHWARZ	FSU43	101261	Apr. 16, 2020	Apr. 15, 2021
Broadband Horn Antenna SCHWARZBECK	BBHA 9170	148	Nov. 24, 2019	Nov. 23, 2020
HORN Antenna SCHWARZBECK	BBHA 9120D	9120D-969	Nov. 24, 2019	Nov. 23, 2020
BILOG Antenna SCHWARZBECK	VULB 9168	9168-472	Nov. 08, 2019	Nov. 07, 2020
Fixed Attenuator WORKEN	MDCS18N-10	MDCS18N-10-01	Apr. 14, 2020	Apr. 13, 2021
Loop Antenna	EM-6879	269	Sep. 17, 2020	Sep. 16, 2021
Preamplifier EMCI	EMC001340	980201	Oct. 21, 2019	Oct. 20, 2020
Preamplifier EMCI	EMC 012645	980115	Oct. 07, 2019	Oct. 06, 2020
Preamplifier EMCI	EMC 184045	980116	Oct. 07, 2019	Oct. 06, 2020
Preamplifier EMCI	EMC 330H	980112	Oct. 07, 2019	Oct. 06, 2020
Power Meter Anritsu	ML2495A	1012010	Sep. 01, 2020	Aug. 31, 2021
Power Sensor Anritsu	MA2411B	1315050	Sep. 01, 2020	Aug. 31, 2021
RF Coaxial Cable EMCI	EMC104-SM-SM-8000	171005	Oct. 07, 2019	Oct. 06, 2020
RF Coaxial Cable HUBER+SUHNNER	SUCOFLEX 104	EMC104-SM-SM-1000(140807)	Oct. 07, 2019	Oct. 06, 2020
RF Coaxial Cable Worken	8D-FB	Cable-Ch10-01	Oct. 07, 2019	Oct. 06, 2020
Boresight Antenna Fixture	FBA-01	FBA-SIP01	NA	NA
Software BV ADT	E3 6.120103	NA	NA	NA
Antenna Tower MF	MFA-440H	NA	NA	NA
Turn Table MF	MFT-201SS	NA	NA	NA
Antenna Tower & Turn Table Controller MF	MF-7802	NA	NA	NA

- NOTE:** 1. The calibration interval of the above test instruments is 12 months and the calibrations are traceable to NML/ROC and NIST/USA.
2. The test was performed in HwaYa Chamber 10.

4.1.3 Test Procedures

For Radiated Emission below 30 MHz

- a. The EUT was placed on the top of a rotating table 0.8 meters above the ground at a 3 meter chamber room. The table was rotated 360 degrees to determine the position of the highest radiation.
- b. The EUT was set 3 meters away from the interference-receiving antenna, which was mounted on the top of a variable-height antenna tower.
- c. Parallel, perpendicular, and ground-parallel orientations of the antenna are set to make the measurement.
- d. For each suspected emission, the EUT was arranged to its worst case and the rotatable table was turned from 0 degrees to 360 degrees to find the maximum reading.
- e. The test-receiver system was set to Quasi-Peak Detect Function and Specified Bandwidth with Maximum Hold Mode.

Note:

1. The resolution bandwidth and video bandwidth of test receiver/spectrum analyzer is 9 kHz at frequency below 30 MHz.

For Radiated Emission above 30 MHz

- a. The EUT was placed on the top of a rotating table 0.8 meters (for 30 MHz ~ 1 GHz) / 1.5 meters (for above 1 GHz) above the ground at 3 meter chamber room for test. The table was rotated 360 degrees to determine the position of the highest radiation.
- b. The EUT was set 3 meters away from the interference-receiving antenna, which was mounted on the top of a variable-height antenna tower.
- c. The height of antenna is varied from one meter to four meters above the ground to determine the maximum value of the field strength. Both horizontal and vertical polarizations of the antenna are set to make the measurement.
- d. For each suspected emission, the EUT was arranged to its worst case and then the antenna was tuned to heights from 1 meter to 4 meters and the rotatable table was turned from 0 degrees to 360 degrees to find the maximum reading.
- e. The test-receiver system was set to quasi-peak detect function and specified bandwidth with maximum hold mode when the test frequency is below 1 GHz.
- f. The test-receiver system was set to peak and average detected function and specified bandwidth with maximum hold mode when the test frequency is above 1 GHz. If the peak reading value also meets average limit, measurement with the average detector is unnecessary.

Note:

1. The resolution bandwidth and video bandwidth of test receiver/spectrum analyzer is 120 kHz for Quasi-peak detection (QP) or Peak detection (PK) at frequency below 1 GHz.
2. The resolution bandwidth of test receiver/spectrum analyzer is 1 MHz and the video bandwidth is 3 MHz for Peak detection (PK) at frequency above 1 GHz.
3. The resolution bandwidth of test receiver/spectrum analyzer is 1 MHz and the video bandwidth is $\geq 1/T$ (Duty cycle $< 98\%$) or 10 Hz (Duty cycle $\geq 98\%$) for Average detection (AV) at frequency above 1 GHz.
(11a: RBW = 1 MHz, VBW = 1 kHz ; 11ac (VHT20): RBW = 1 MHz, VBW = 10 Hz ;
11ac (VHT40): RBW = 1 MHz, VBW = 1 kHz ; 11ac (VHT80): RBW = 1 MHz, VBW = 1 kHz)
4. All modes of operation were investigated and the worst-case emissions are reported.

4.1.4 Deviation from Test Standard

No deviation.

4.1.5 Test Setup

<Radiated Emission below 30 MHz>

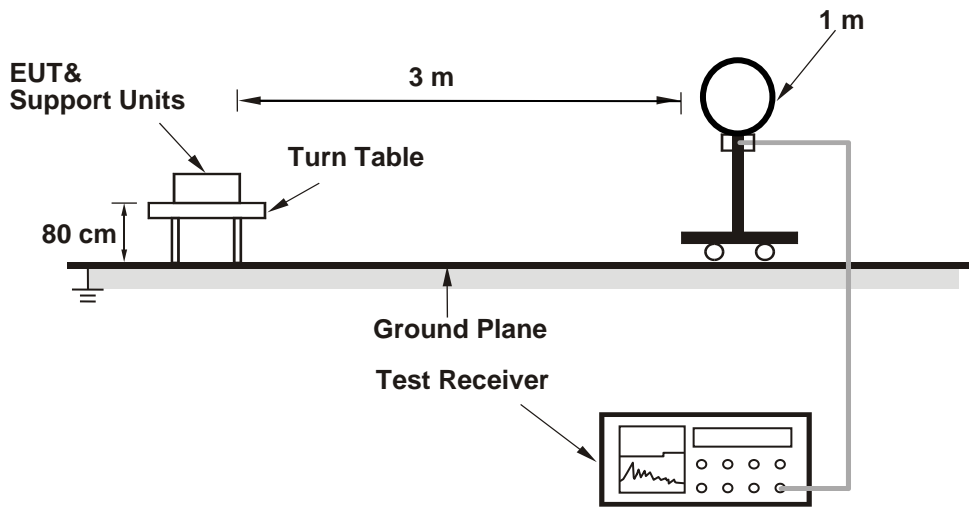

<Radiated Emission 30 MHz to 1 GHz>

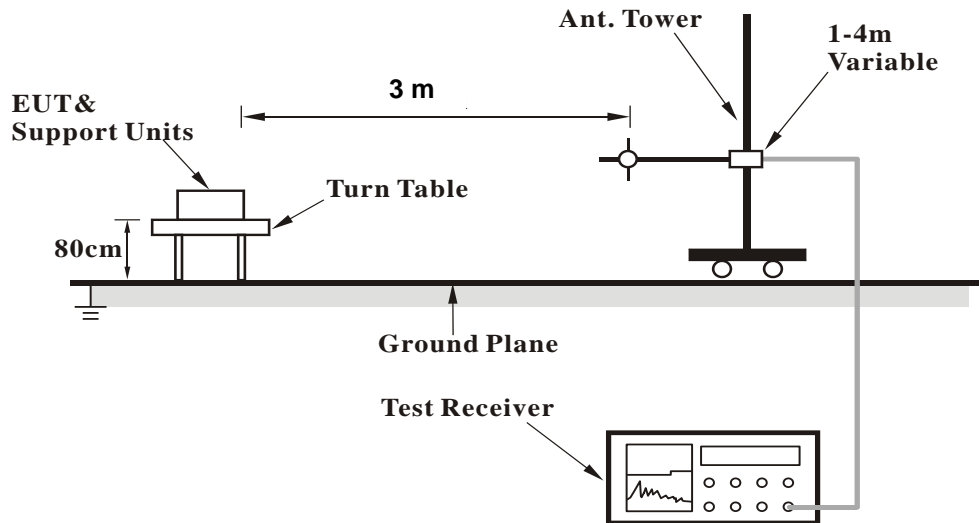

<Radiated Emission above 1 GHz>

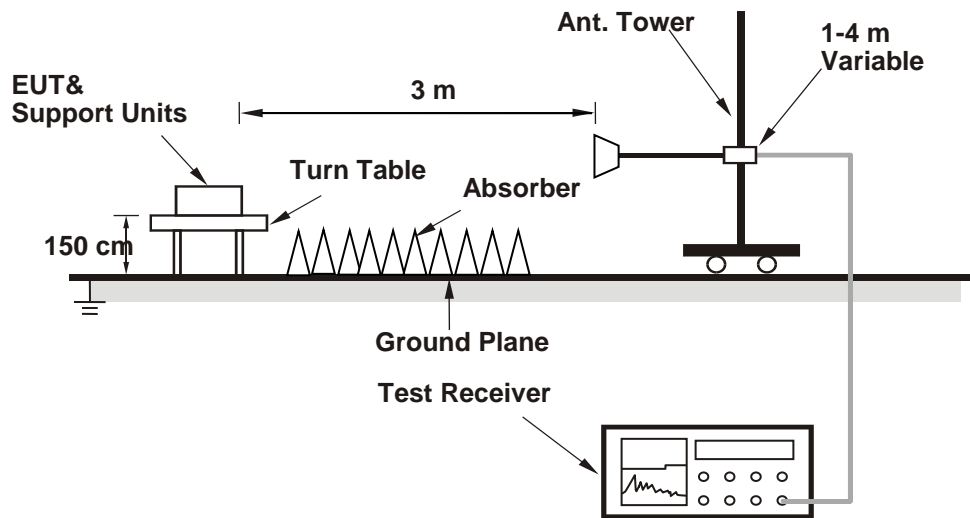

For the actual test configuration, please refer to the attached file (Test Setup Photo).

4.1.6 EUT Operating Conditions

- a. Placed the EUT on a testing table.
- b. Use the software to control the EUT under transmission condition continuously at specific channel frequency.

4.1.7 Test Results

Above 1 GHz Data :
802.11a

EUT Test Condition		Measurement Detail	
Channel	Channel 36	Frequency Range	1 GHz ~ 40 GHz
Input Power	120 Vac, 60 Hz	Detector Function	Peak (PK) Average (AV)
Environmental Conditions	25 deg. C, 65 % RH	Tested By	Cyril Chen

Antenna Polarity & Test Distance: Horizontal at 3 m								
Frequency (MHz)	Emission Level (dBuV/m)	Read Level (dBuV)	Factor (dB/m)	Limit (dBuV/m)	Margin (dB)	Antenna Height (cm)	Table Angle (Degree)	Remark
5150	42.66	42.24	0.42	54	-11.34	104	233	Average
5150	50.68	50.26	0.42	74	-23.32	104	233	Peak
5180	97.18	96.92	0.26	-----	-----	104	233	Average
5180	104.83	104.57	0.26	-----	-----	104	233	Peak
10360	52.96	54.88	-1.92	68.2	-15.24	167	199	Peak
Antenna Polarity & Test Distance: Vertical at 3 m								
Frequency (MHz)	Emission Level (dBuV/m)	Read Level (dBuV)	Factor (dB/m)	Limit (dBuV/m)	Margin (dB)	Antenna Height (cm)	Table Angle (Degree)	Remark
5150	53.53	53.11	0.42	54	-0.47	114	295	Average
5150	61.04	60.62	0.42	74	-12.96	114	295	Peak
5180	108.6	108.34	0.26	-----	-----	114	295	Average
5180	114.95	114.69	0.26	-----	-----	114	295	Peak
10360	53.23	55.15	-1.92	68.2	-14.97	102	55	Peak

Remarks:

- Emission Level = Read Level + Factor
Margin value = Emission level – Limit value
- 5180 MHz: Fundamental Frequency
- The emission levels of other frequencies were very low against the limit

EUT Test Condition		Measurement Detail	
Channel	Channel 40	Frequency Range	1 GHz ~ 40 GHz
Input Power	120 Vac, 60 Hz	Detector Function	Peak (PK) Average (AV)
Environmental Conditions	25 deg. C, 65 % RH	Tested By	Cyril Chen

Antenna Polarity & Test Distance: Horizontal at 3 m								
Frequency (MHz)	Emission Level (dBuV/m)	Read Level (dBuV)	Factor (dB/m)	Limit (dBuV/m)	Margin (dB)	Antenna Height (cm)	Table Angle (Degree)	Remark
5150	40.24	39.82	0.42	54	-13.76	101	232	Average
5150	49.28	48.86	0.42	74	-24.72	101	232	Peak
5200	99.41	99.27	0.14	-----	-----	101	232	Average
5200	106.39	106.25	0.14	-----	-----	101	232	Peak
5350	40.19	39.86	0.33	54	-13.81	101	232	Average
5350	50.03	49.7	0.33	74	-23.97	101	232	Peak
10400	54.39	56.21	-1.82	68.2	-13.81	107	139	Peak
Antenna Polarity & Test Distance: Vertical at 3 m								
Frequency (MHz)	Emission Level (dBuV/m)	Read Level (dBuV)	Factor (dB/m)	Limit (dBuV/m)	Margin (dB)	Antenna Height (cm)	Table Angle (Degree)	Remark
5150	45.17	44.75	0.42	54	-8.83	121	297	Average
5150	53.89	53.47	0.42	74	-20.11	121	297	Peak
5200	109.26	109.12	0.14	-----	-----	121	297	Average
5200	114.92	114.78	0.14	-----	-----	121	297	Peak
5350	45.54	45.21	0.33	54	-8.46	121	297	Average
5350	53.76	53.43	0.33	74	-20.24	121	297	Peak
10400	56.21	58.03	-1.82	68.2	-11.99	111	103	Peak

Remarks:

1. Emission Level = Read Level + Factor
Margin value = Emission level – Limit value
2. 5200 MHz: Fundamental Frequency
3. The emission levels of other frequencies were very low against the limit

EUT Test Condition		Measurement Detail	
Channel	Channel 48	Frequency Range	1 GHz ~ 40 GHz
Input Power	120 Vac, 60 Hz	Detector Function	Peak (PK) Average (AV)
Environmental Conditions	25 deg. C, 65 % RH	Tested By	Cyril Chen

Antenna Polarity & Test Distance: Horizontal at 3 m								
Frequency (MHz)	Emission Level (dBuV/m)	Read Level (dBuV)	Factor (dB/m)	Limit (dBuV/m)	Margin (dB)	Antenna Height (cm)	Table Angle (Degree)	Remark
5150	39.83	39.41	0.42	54	-14.17	122	235	Average
5150	49.09	48.67	0.42	74	-24.91	122	235	Peak
5240	98.8	98.7	0.1	-----	-----	122	235	Average
5240	105.73	105.63	0.1	-----	-----	122	235	Peak
5350	39.85	39.52	0.33	54	-14.15	122	235	Average
5350	48.66	48.33	0.33	74	-25.34	122	235	Peak
10480	55.2	56.68	-1.48	68.2	-13	111	178	Peak

Antenna Polarity & Test Distance: Vertical at 3 m								
Frequency (MHz)	Emission Level (dBuV/m)	Read Level (dBuV)	Factor (dB/m)	Limit (dBuV/m)	Margin (dB)	Antenna Height (cm)	Table Angle (Degree)	Remark
4920.48	48.71	48.86	-0.15	54	-5.29	120	295	Average
4920.48	53.62	53.77	-0.15	74	-20.38	120	295	Peak
5150	43.62	43.2	0.42	54	-10.38	120	295	Average
5150	52.45	52.03	0.42	74	-21.55	120	295	Peak
5240	108.82	108.72	0.1	-----	-----	120	295	Average
5240	115.26	115.16	0.1	-----	-----	120	295	Peak
5350	44.8	44.47	0.33	54	-9.2	120	295	Average
5350	53.82	53.49	0.33	74	-20.18	120	295	Peak
10480	54.59	56.07	-1.48	68.2	-13.61	134	167	Peak

Remarks:

1. Emission Level = Read Level + Factor
Margin value = Emission level – Limit value
2. 5240 MHz: Fundamental Frequency
3. The emission levels of other frequencies were very low against the limit

EUT Test Condition		Measurement Detail	
Channel	Channel 149	Frequency Range	1 GHz ~ 40 GHz
Input Power	120 Vac, 60 Hz	Detector Function	Peak (PK) Average (AV)
Environmental Conditions	25 deg. C, 65 % RH	Tested By	Cyril Chen

<Spurious Emission>

Antenna Polarity & Test Distance: Horizontal at 3 m								
Frequency (MHz)	Emission Level (dBuV/m)	Read Level (dBuV)	Factor (dB/m)	Limit (dBuV/m)	Margin (dB)	Antenna Height (cm)	Table Angle (Degree)	Remark
5745	103.05	102.17	0.88	-----	-----	102	203	Average
5745	109.74	108.86	0.88	-----	-----	102	203	Peak
11490	46.92	48.24	-1.32	54	-7.08	131	106	Average
11490	55.22	56.54	-1.32	74	-18.78	131	106	Peak

Antenna Polarity & Test Distance: Vertical at 3 m								
Frequency (MHz)	Emission Level (dBuV/m)	Read Level (dBuV)	Factor (dB/m)	Limit (dBuV/m)	Margin (dB)	Antenna Height (cm)	Table Angle (Degree)	Remark
5745	109.77	108.89	0.88	-----	-----	166	354	Average
5745	117.02	116.14	0.88	-----	-----	166	354	Peak
11490	48.32	49.64	-1.32	54	-5.68	178	159	Average
11490	57.22	58.54	-1.32	74	-16.78	178	159	Peak

<Out of Band Emission (OOBE)>

Antenna Polarity & Test Distance: Horizontal at 3 m								
Frequency (MHz)	Emission Level (dBuV/m)	Read Level (dBuV)	Factor (dB/m)	Limit (dBuV/m)	Margin (dB)	Antenna Height (cm)	Table Angle (Degree)	Remark
5635.5	50.58	49.91	0.67	68.2	-17.62	102	203	Peak
5653.075	49.87	49.17	0.7	70.49	-20.62	102	203	Peak
5916.7	51.05	49.75	1.3	74.32	-23.27	102	203	Peak
5978.925	52.06	50.71	1.35	68.2	-16.14	102	203	Peak

Antenna Polarity & Test Distance: Vertical at 3 m								
Frequency (MHz)	Emission Level (dBuV/m)	Read Level (dBuV)	Factor (dB/m)	Limit (dBuV/m)	Margin (dB)	Antenna Height (cm)	Table Angle (Degree)	Remark
5579.45	55.01	54.21	0.8	68.2	-13.19	166	354	Peak
5656.875	54.08	53.43	0.65	73.31	-19.23	166	354	Peak
5915.275	51.73	50.43	1.3	75.37	-23.64	166	354	Peak
5978.45	51.74	50.39	1.35	68.2	-16.46	166	354	Peak

Remarks:

- Emission Level = Read Level + Factor
Margin value = Emission level – Limit value
- 5745 MHz: Fundamental Frequency
- The emission levels of other frequencies were very low against the limit

EUT Test Condition		Measurement Detail	
Channel	Channel 157	Frequency Range	1 GHz ~ 40 GHz
Input Power	120 Vac, 60 Hz	Detector Function	Peak (PK) Average (AV)
Environmental Conditions	25 deg. C, 65 % RH	Tested By	Cyril Chen

<Spurious Emission>

Antenna Polarity & Test Distance: Horizontal at 3 m								
Frequency (MHz)	Emission Level (dBuV/m)	Read Level (dBuV)	Factor (dB/m)	Limit (dBuV/m)	Margin (dB)	Antenna Height (cm)	Table Angle (Degree)	Remark
5785	103.82	102.9	0.92	-----	-----	120	206	Average
5785	111.06	110.14	0.92	-----	-----	120	206	Peak
11570	46.31	48.02	-1.71	54	-7.69	106	137	Average
11570	54.75	56.46	-1.71	74	-19.25	106	137	Peak

Antenna Polarity & Test Distance: Vertical at 3 m								
Frequency (MHz)	Emission Level (dBuV/m)	Read Level (dBuV)	Factor (dB/m)	Limit (dBuV/m)	Margin (dB)	Antenna Height (cm)	Table Angle (Degree)	Remark
5785	109.89	108.97	0.92	-----	-----	154	10	Average
5785	116.15	115.23	0.92	-----	-----	154	10	Peak
11570	46.69	48.4	-1.71	54	-7.31	126	197	Average
11570	53.6	55.31	-1.71	74	-20.4	126	197	Peak

<Out of Band Emission (OOBE)>

Antenna Polarity & Test Distance: Horizontal at 3 m								
Frequency (MHz)	Emission Level (dBuV/m)	Read Level (dBuV)	Factor (dB/m)	Limit (dBuV/m)	Margin (dB)	Antenna Height (cm)	Table Angle (Degree)	Remark
5552.85	51.1	50.26	0.84	68.2	-17.1	120	206	Peak
5657.35	50.12	49.46	0.66	73.66	-23.54	120	206	Peak
5916.225	49.73	48.43	1.3	74.67	-24.94	120	206	Peak
5946.625	50.65	49.33	1.32	68.2	-17.55	120	206	Peak

Antenna Polarity & Test Distance: Vertical at 3 m								
Frequency (MHz)	Emission Level (dBuV/m)	Read Level (dBuV)	Factor (dB/m)	Limit (dBuV/m)	Margin (dB)	Antenna Height (cm)	Table Angle (Degree)	Remark
5580.875	55	54.2	0.8	68.2	-13.2	154	10	Peak
5653.075	54.79	54.09	0.7	70.49	-15.7	154	10	Peak
5918.125	51.33	50.03	1.3	73.27	-21.94	154	10	Peak
5940.925	52.17	50.85	1.32	68.2	-16.03	154	10	Peak

Remarks:

- Emission Level = Read Level + Factor
Margin value = Emission level – Limit value
- 5785 MHz: Fundamental Frequency
- The emission levels of other frequencies were very low against the limit

EUT Test Condition		Measurement Detail	
Channel	Channel 165	Frequency Range	1 GHz ~ 40 GHz
Input Power	120 Vac, 60 Hz	Detector Function	Peak (PK) Average (AV)
Environmental Conditions	25 deg. C, 65 % RH	Tested By	Cyril Chen

<Spurious Emission>

Antenna Polarity & Test Distance: Horizontal at 3 m								
Frequency (MHz)	Emission Level (dBuV/m)	Read Level (dBuV)	Factor (dB/m)	Limit (dBuV/m)	Margin (dB)	Antenna Height (cm)	Table Angle (Degree)	Remark
5825	104.12	103.06	1.06	-----	-----	120	205	Average
5825	111.32	110.26	1.06	-----	-----	120	205	Peak
11650	46.57	48.63	-2.06	54	-7.43	103	168	Average
11650	55.24	57.3	-2.06	74	-18.76	103	168	Peak
Antenna Polarity & Test Distance: Vertical at 3 m								
Frequency (MHz)	Emission Level (dBuV/m)	Read Level (dBuV)	Factor (dB/m)	Limit (dBuV/m)	Margin (dB)	Antenna Height (cm)	Table Angle (Degree)	Remark
5825	109.58	108.52	1.06	-----	-----	175	10	Average
5825	116.89	115.83	1.06	-----	-----	175	10	Peak
11650	46.13	48.19	-2.06	54	-7.87	163	207	Average
11650	55.38	57.44	-2.06	74	-18.62	163	207	Peak

<Out of Band Emission (OOBE)>

Antenna Polarity & Test Distance: Horizontal at 3 m								
Frequency (MHz)	Emission Level (dBuV/m)	Read Level (dBuV)	Factor (dB/m)	Limit (dBuV/m)	Margin (dB)	Antenna Height (cm)	Table Angle (Degree)	Remark
5582.3	51.36	50.56	0.8	68.2	-16.84	120	205	Peak
5655.45	50.56	49.91	0.65	72.25	-21.69	120	205	Peak
5921.925	49.26	47.96	1.3	70.47	-21.21	120	205	Peak
5933.8	50.67	49.37	1.3	68.2	-17.53	120	205	Peak
Antenna Polarity & Test Distance: Vertical at 3 m								
Frequency (MHz)	Emission Level (dBuV/m)	Read Level (dBuV)	Factor (dB/m)	Limit (dBuV/m)	Margin (dB)	Antenna Height (cm)	Table Angle (Degree)	Remark
5614.6	54.09	53.36	0.73	68.2	-14.11	175	10	Peak
5652.125	53.08	52.39	0.69	69.78	-16.7	175	10	Peak
5920.5	52.27	50.97	1.3	71.52	-19.25	175	10	Peak
6000.3	51.96	50.58	1.38	68.2	-16.24	175	10	Peak

Remarks:

- Emission Level = Read Level + Factor
Margin value = Emission level – Limit value
- 5825 MHz: Fundamental Frequency
- The emission levels of other frequencies were very low against the limit

802.11n (HT20)

EUT Test Condition		Measurement Detail	
Channel	Channel 36	Frequency Range	1 GHz ~ 40 GHz
Input Power	120 Vac, 60 Hz	Detector Function	Peak (PK) Average (AV)
Environmental Conditions	25 deg. C, 65 % RH	Tested By	Cyril Chen

Antenna Polarity & Test Distance: Horizontal at 3 m								
Frequency (MHz)	Emission Level (dBuV/m)	Read Level (dBuV)	Factor (dB/m)	Limit (dBuV/m)	Margin (dB)	Antenna Height (cm)	Table Angle (Degree)	Remark
5150	40.43	40.01	0.42	54	-13.57	102	232	Average
5150	48.82	48.4	0.42	74	-25.18	102	232	Peak
5180	96.63	96.37	0.26	-----	-----	102	232	Average
5180	103.9	103.64	0.26	-----	-----	102	232	Peak
10360	54.71	56.63	-1.92	68.2	-13.49	137	46	Peak
Antenna Polarity & Test Distance: Vertical at 3 m								
Frequency (MHz)	Emission Level (dBuV/m)	Read Level (dBuV)	Factor (dB/m)	Limit (dBuV/m)	Margin (dB)	Antenna Height (cm)	Table Angle (Degree)	Remark
5150	53.87	53.45	0.42	54	-0.13	115	297	Average
5150	61.92	61.5	0.42	74	-12.08	115	297	Peak
5180	107.64	107.38	0.26	-----	-----	115	297	Average
5180	114.18	113.92	0.26	-----	-----	115	297	Peak
10360	54.96	56.88	-1.92	68.2	-13.24	104	147	Peak

Remarks:

- Emission Level = Read Level + Factor
Margin value = Emission level – Limit value
- 5180 MHz: Fundamental Frequency
- The emission levels of other frequencies were very low against the limit

EUT Test Condition		Measurement Detail	
Channel	Channel 40	Frequency Range	1 GHz ~ 40 GHz
Input Power	120 Vac, 60 Hz	Detector Function	Peak (PK) Average (AV)
Environmental Conditions	25 deg. C, 65 % RH	Tested By	Cyril Chen

Antenna Polarity & Test Distance: Horizontal at 3 m								
Frequency (MHz)	Emission Level (dBuV/m)	Read Level (dBuV)	Factor (dB/m)	Limit (dBuV/m)	Margin (dB)	Antenna Height (cm)	Table Angle (Degree)	Remark
5150	39.87	39.45	0.42	54	-14.13	103	232	Average
5150	48.25	47.83	0.42	74	-25.75	103	232	Peak
5200	98.46	98.32	0.14	-----	-----	103	232	Average
5200	106.21	106.07	0.14	-----	-----	103	232	Peak
5350	39.86	39.53	0.33	54	-14.14	103	232	Average
5350	49.02	48.69	0.33	74	-24.98	103	232	Peak
10400	56.41	58.23	-1.82	68.2	-11.79	201	117	Peak
Antenna Polarity & Test Distance: Vertical at 3 m								
Frequency (MHz)	Emission Level (dBuV/m)	Read Level (dBuV)	Factor (dB/m)	Limit (dBuV/m)	Margin (dB)	Antenna Height (cm)	Table Angle (Degree)	Remark
4880.16	47.43	47.62	-0.19	54	-6.57	101	312	Average
4880.16	53.91	54.1	-0.19	74	-20.09	101	312	Peak
5150	44.76	44.34	0.42	54	-9.24	101	312	Average
5150	52.8	52.38	0.42	74	-21.2	101	312	Peak
5200	106.82	106.68	0.14	-----	-----	101	312	Average
5200	113.24	113.1	0.14	-----	-----	101	312	Peak
5350	43.43	43.1	0.33	54	-10.57	101	312	Average
5350	51.84	51.51	0.33	74	-22.16	101	312	Peak
10400	56.53	58.35	-1.82	68.2	-11.67	108	197	Peak

Remarks:

- Emission Level = Read Level + Factor
Margin value = Emission level – Limit value
- 5200 MHz: Fundamental Frequency
- The emission levels of other frequencies were very low against the limit

EUT Test Condition		Measurement Detail	
Channel	Channel 48	Frequency Range	1 GHz ~ 40 GHz
Input Power	120 Vac, 60 Hz	Detector Function	Peak (PK) Average (AV)
Environmental Conditions	25 deg. C, 65 % RH	Tested By	Cyril Chen

Antenna Polarity & Test Distance: Horizontal at 3 m								
Frequency (MHz)	Emission Level (dBuV/m)	Read Level (dBuV)	Factor (dB/m)	Limit (dBuV/m)	Margin (dB)	Antenna Height (cm)	Table Angle (Degree)	Remark
5150	39.87	39.45	0.42	54	-14.13	111	233	Average
5150	48.81	48.39	0.42	74	-25.19	111	233	Peak
5240	98.93	98.83	0.1	-----	-----	111	233	Average
5240	106.11	106.01	0.1	-----	-----	111	233	Peak
5350	39.88	39.55	0.33	54	-14.12	111	233	Average
5350	49.68	49.35	0.33	74	-24.32	111	233	Peak
10480	57.07	58.55	-1.48	68.2	-11.13	178	326	Peak

Antenna Polarity & Test Distance: Vertical at 3 m								
Frequency (MHz)	Emission Level (dBuV/m)	Read Level (dBuV)	Factor (dB/m)	Limit (dBuV/m)	Margin (dB)	Antenna Height (cm)	Table Angle (Degree)	Remark
4919.52	47.05	47.2	-0.15	54	-6.95	104	299	Average
4919.52	55.18	55.33	-0.15	74	-18.82	104	299	Peak
5150	44.38	43.96	0.42	54	-9.62	104	299	Average
5150	52.85	52.43	0.42	74	-21.15	104	299	Peak
5240	106.64	106.54	0.1	-----	-----	104	299	Average
5240	113.24	113.14	0.1	-----	-----	104	299	Peak
5350	45.46	45.13	0.33	54	-8.54	104	299	Average
5350	54.4	54.07	0.33	74	-19.6	104	299	Peak
10480	57.19	58.67	-1.48	68.2	-11.01	136	13	Peak

Remarks:

1. Emission Level = Read Level + Factor
Margin value = Emission level – Limit value
2. 5240 MHz: Fundamental Frequency
3. The emission levels of other frequencies were very low against the limit

EUT Test Condition		Measurement Detail	
Channel	Channel 149	Frequency Range	1 GHz ~ 40 GHz
Input Power	120 Vac, 60 Hz	Detector Function	Peak (PK) Average (AV)
Environmental Conditions	25 deg. C, 65 % RH	Tested By	Cyril Chen

<Spurious Emission>

Antenna Polarity & Test Distance: Horizontal at 3 m								
Frequency (MHz)	Emission Level (dBuV/m)	Read Level (dBuV)	Factor (dB/m)	Limit (dBuV/m)	Margin (dB)	Antenna Height (cm)	Table Angle (Degree)	Remark
5745	100.64	99.76	0.88	-----	-----	100	319	Average
5745	108.19	107.31	0.88	-----	-----	100	319	Peak
11490	49.04	50.36	-1.32	54	-4.96	191	320	Average
11490	57.39	58.71	-1.32	74	-16.61	191	320	Peak
Antenna Polarity & Test Distance: Vertical at 3 m								
Frequency (MHz)	Emission Level (dBuV/m)	Read Level (dBuV)	Factor (dB/m)	Limit (dBuV/m)	Margin (dB)	Antenna Height (cm)	Table Angle (Degree)	Remark
5745	109.94	109.06	0.88	-----	-----	170	351	Average
5745	115.83	114.95	0.88	-----	-----	170	351	Peak
11490	48.74	50.06	-1.32	54	-5.26	147	161	Average
11490	57.11	58.43	-1.32	74	-16.89	147	161	Peak

<Out of Band Emission (OOBE)>

Antenna Polarity & Test Distance: Horizontal at 3 m								
Frequency (MHz)	Emission Level (dBuV/m)	Read Level (dBuV)	Factor (dB/m)	Limit (dBuV/m)	Margin (dB)	Antenna Height (cm)	Table Angle (Degree)	Remark
5593.225	49.94	49.15	0.79	68.2	-18.26	100	319	Peak
5652.125	48.97	48.28	0.69	69.78	-20.81	100	319	Peak
5917.175	50.11	48.81	1.3	73.97	-23.86	100	319	Peak
5968.95	50.64	49.3	1.34	68.2	-17.56	100	319	Peak
Antenna Polarity & Test Distance: Vertical at 3 m								
Frequency (MHz)	Emission Level (dBuV/m)	Read Level (dBuV)	Factor (dB/m)	Limit (dBuV/m)	Margin (dB)	Antenna Height (cm)	Table Angle (Degree)	Remark
5624.575	54.85	54.12	0.73	68.2	-13.35	170	351	Peak
5658.3	55.52	54.86	0.66	74.36	-18.84	170	351	Peak
5918.6	52.4	51.1	1.3	72.92	-20.52	170	351	Peak
5933.325	53.06	51.76	1.3	68.2	-15.14	170	351	Peak

Remarks:

- Emission Level = Read Level + Factor
Margin value = Emission level – Limit value
- 5745 MHz: Fundamental Frequency
- The emission levels of other frequencies were very low against the limit

EUT Test Condition		Measurement Detail	
Channel	Channel 157	Frequency Range	1 GHz ~ 40 GHz
Input Power	120 Vac, 60 Hz	Detector Function	Peak (PK) Average (AV)
Environmental Conditions	25 deg. C, 65 % RH	Tested By	Cyril Chen

<Spurious Emission>

Antenna Polarity & Test Distance: Horizontal at 3 m								
Frequency (MHz)	Emission Level (dBuV/m)	Read Level (dBuV)	Factor (dB/m)	Limit (dBuV/m)	Margin (dB)	Antenna Height (cm)	Table Angle (Degree)	Remark
5785	101.86	100.94	0.92	-----	-----	130	204	Average
5785	109.42	108.5	0.92	-----	-----	130	204	Peak
11570	47.45	49.16	-1.71	54	-6.55	167	273	Average
11570	55.99	57.7	-1.71	74	-18.01	167	273	Peak

Antenna Polarity & Test Distance: Vertical at 3 m								
Frequency (MHz)	Emission Level (dBuV/m)	Read Level (dBuV)	Factor (dB/m)	Limit (dBuV/m)	Margin (dB)	Antenna Height (cm)	Table Angle (Degree)	Remark
5785	109.03	108.11	0.92	-----	-----	174	343	Average
5785	116.13	115.21	0.92	-----	-----	174	343	Peak
11570	49.35	51.06	-1.71	54	-4.65	129	144	Average
11570	58.35	60.06	-1.71	74	-15.65	129	144	Peak

<Out of Band Emission (OOBE)>

Antenna Polarity & Test Distance: Horizontal at 3 m								
Frequency (MHz)	Emission Level (dBuV/m)	Read Level (dBuV)	Factor (dB/m)	Limit (dBuV/m)	Margin (dB)	Antenna Height (cm)	Table Angle (Degree)	Remark
5592.275	49.62	48.83	0.79	68.2	-18.58	130	204	Peak
5654.975	48.82	48.18	0.64	71.9	-23.08	130	204	Peak
5922.875	49.31	48.01	1.3	69.77	-20.46	130	204	Peak
6013.6	50.81	49.39	1.42	68.2	-17.39	130	204	Peak

Antenna Polarity & Test Distance: Vertical at 3 m								
Frequency (MHz)	Emission Level (dBuV/m)	Read Level (dBuV)	Factor (dB/m)	Limit (dBuV/m)	Margin (dB)	Antenna Height (cm)	Table Angle (Degree)	Remark
5550.475	55.14	54.27	0.87	68.2	-13.06	174	343	Peak
5653.55	52.81	52.11	0.7	70.84	-18.03	174	343	Peak
5921.925	52.81	51.51	1.3	70.47	-17.66	174	343	Peak
5944.25	53.5	52.18	1.32	68.2	-14.7	174	343	Peak

Remarks:

- Emission Level = Read Level + Factor
Margin value = Emission level – Limit value
- 5785 MHz: Fundamental Frequency
- The emission levels of other frequencies were very low against the limit

EUT Test Condition		Measurement Detail	
Channel	Channel 165	Frequency Range	1 GHz ~ 40 GHz
Input Power	120 Vac, 60 Hz	Detector Function	Peak (PK) Average (AV)
Environmental Conditions	25 deg. C, 65 % RH	Tested By	Cyril Chen

<Spurious Emission>

Antenna Polarity & Test Distance: Horizontal at 3 m								
Frequency (MHz)	Emission Level (dBuV/m)	Read Level (dBuV)	Factor (dB/m)	Limit (dBuV/m)	Margin (dB)	Antenna Height (cm)	Table Angle (Degree)	Remark
5825	102.3	101.24	1.06	-----	-----	137	205	Average
5825	109.24	108.18	1.06	-----	-----	137	205	Peak
11650	47.91	49.97	-2.06	54	-6.09	171	227	Average
11650	56.19	58.25	-2.06	74	-17.81	171	227	Peak
Antenna Polarity & Test Distance: Vertical at 3 m								
Frequency (MHz)	Emission Level (dBuV/m)	Read Level (dBuV)	Factor (dB/m)	Limit (dBuV/m)	Margin (dB)	Antenna Height (cm)	Table Angle (Degree)	Remark
5825	109.54	108.48	1.06	-----	-----	169	344	Average
5825	115.5	114.44	1.06	-----	-----	169	344	Peak
11650	47.08	49.14	-2.06	54	-6.92	124	157	Average
11650	55.49	57.55	-2.06	74	-18.51	124	157	Peak

<Out of Band Emission (OOBE)>

Antenna Polarity & Test Distance: Horizontal at 3 m								
Frequency (MHz)	Emission Level (dBuV/m)	Read Level (dBuV)	Factor (dB/m)	Limit (dBuV/m)	Margin (dB)	Antenna Height (cm)	Table Angle (Degree)	Remark
5598.925	49.9	49.11	0.79	68.2	-18.3	137	205	Peak
5660.2	49.58	48.91	0.67	75.77	-26.19	137	205	Peak
5917.65	50.08	48.78	1.3	73.62	-23.54	137	205	Peak
5981.3	50.94	49.59	1.35	68.2	-17.26	137	205	Peak
Antenna Polarity & Test Distance: Vertical at 3 m								
Frequency (MHz)	Emission Level (dBuV/m)	Read Level (dBuV)	Factor (dB/m)	Limit (dBuV/m)	Margin (dB)	Antenna Height (cm)	Table Angle (Degree)	Remark
5593.7	55.08	54.29	0.79	68.2	-13.12	169	344	Peak
5660.2	54.31	53.64	0.67	75.77	-21.46	169	344	Peak
5917.65	52.43	51.13	1.3	73.62	-21.19	169	344	Peak
5978.925	53.29	51.94	1.35	68.2	-14.91	169	344	Peak

Remarks:

- Emission Level = Read Level + Factor
Margin value = Emission level – Limit value
- 5825 MHz: Fundamental Frequency
- The emission levels of other frequencies were very low against the limit

802.11n (HT40)

EUT Test Condition		Measurement Detail	
Channel	Channel 38	Frequency Range	1 GHz ~ 40 GHz
Input Power	120 Vac, 60 Hz	Detector Function	Peak (PK) Average (AV)
Environmental Conditions	25 deg. C, 65 % RH	Tested By	Cyril Chen

Antenna Polarity & Test Distance: Horizontal at 3 m								
Frequency (MHz)	Emission Level (dBuV/m)	Read Level (dBuV)	Factor (dB/m)	Limit (dBuV/m)	Margin (dB)	Antenna Height (cm)	Table Angle (Degree)	Remark
5150	41.86	41.44	0.42	54	-12.14	100	232	Average
5150	52.31	51.89	0.42	74	-21.69	100	232	Peak
5190	90.22	90.02	0.2	-----	-----	100	232	Average
5190	99.68	99.48	0.2	-----	-----	100	232	Peak
5350	38.71	38.38	0.33	54	-15.29	100	232	Average
5350	50.43	50.1	0.33	74	-23.57	100	232	Peak
10380	55.89	57.75	-1.86	68.2	-12.31	199	326	Peak

Antenna Polarity & Test Distance: Vertical at 3 m								
Frequency (MHz)	Emission Level (dBuV/m)	Read Level (dBuV)	Factor (dB/m)	Limit (dBuV/m)	Margin (dB)	Antenna Height (cm)	Table Angle (Degree)	Remark
5150	53	52.58	0.42	54	-1	100	294	Average
5150	65.45	65.03	0.42	74	-8.55	100	294	Peak
5190	101.23	101.03	0.2	-----	-----	100	294	Average
5190	110.73	110.53	0.2	-----	-----	100	294	Peak
5350	42.78	42.45	0.33	54	-11.22	100	294	Average
5350	54.68	54.35	0.33	74	-19.32	100	294	Peak
10380	56.43	58.29	-1.86	68.2	-11.77	152	136	Peak

Remarks:

- Emission Level = Read Level + Factor
Margin value = Emission level – Limit value
- 5190 MHz: Fundamental Frequency
- The emission levels of other frequencies were very low against the limit

EUT Test Condition		Measurement Detail	
Channel	Channel 46	Frequency Range	1 GHz ~ 40 GHz
Input Power	120 Vac, 60 Hz	Detector Function	Peak (PK) Average (AV)
Environmental Conditions	25 deg. C, 65 % RH	Tested By	Cyril Chen

Antenna Polarity & Test Distance: Horizontal at 3 m								
Frequency (MHz)	Emission Level (dBuV/m)	Read Level (dBuV)	Factor (dB/m)	Limit (dBuV/m)	Margin (dB)	Antenna Height (cm)	Table Angle (Degree)	Remark
5150	39.55	39.13	0.42	54	-14.45	100	233	Average
5150	50.32	49.9	0.42	74	-23.68	100	233	Peak
5230	96.52	96.4	0.12	-----	-----	100	233	Average
5230	105.93	105.81	0.12	-----	-----	100	233	Peak
5350	39.01	38.68	0.33	54	-14.99	100	233	Average
5350	50.57	50.24	0.33	74	-23.43	100	233	Peak
10460	57.41	59	-1.59	68.2	-10.79	174	158	Peak

Antenna Polarity & Test Distance: Vertical at 3 m								
Frequency (MHz)	Emission Level (dBuV/m)	Read Level (dBuV)	Factor (dB/m)	Limit (dBuV/m)	Margin (dB)	Antenna Height (cm)	Table Angle (Degree)	Remark
5150	48.24	47.82	0.42	54	-5.76	118	298	Average
5150	59.12	58.7	0.42	74	-14.88	118	298	Peak
5230	105.69	105.57	0.12	-----	-----	118	298	Average
5230	114.35	114.23	0.12	-----	-----	118	298	Peak
5350	44.61	44.28	0.33	54	-9.39	118	298	Average
5350	56.62	56.29	0.33	74	-17.38	118	298	Peak
10460	55.97	57.56	-1.59	68.2	-12.23	125	304	Peak

Remarks:

- Emission Level = Read Level + Factor
Margin value = Emission level – Limit value
- 5230 MHz: Fundamental Frequency
- The emission levels of other frequencies were very low against the limit

EUT Test Condition		Measurement Detail	
Channel	Channel 151	Frequency Range	1 GHz ~ 40 GHz
Input Power	120 Vac, 60 Hz	Detector Function	Peak (PK) Average (AV)
Environmental Conditions	25 deg. C, 65 % RH	Tested By	Cyril Chen

<Spurious Emission>

Antenna Polarity & Test Distance: Horizontal at 3 m								
Frequency (MHz)	Emission Level (dBuV/m)	Read Level (dBuV)	Factor (dB/m)	Limit (dBuV/m)	Margin (dB)	Antenna Height (cm)	Table Angle (Degree)	Remark
5755	101.09	100.18	0.91	-----	-----	100	318	Average
5755	108.16	107.25	0.91	-----	-----	100	318	Peak
11510	49.51	50.86	-1.35	54	-4.49	138	132	Average
11510	58.38	59.73	-1.35	74	-15.62	138	132	Peak

Antenna Polarity & Test Distance: Vertical at 3 m								
Frequency (MHz)	Emission Level (dBuV/m)	Read Level (dBuV)	Factor (dB/m)	Limit (dBuV/m)	Margin (dB)	Antenna Height (cm)	Table Angle (Degree)	Remark
5755	109.46	108.55	0.91	-----	-----	169	354	Average
5755	115.79	114.88	0.91	-----	-----	169	354	Peak
11510	48.51	49.86	-1.35	54	-5.49	176	323	Average
11510	56.99	58.34	-1.35	74	-17.01	176	323	Peak

<Out of Band Emission (OOBE)>

Antenna Polarity & Test Distance: Horizontal at 3 m								
Frequency (MHz)	Emission Level (dBuV/m)	Read Level (dBuV)	Factor (dB/m)	Limit (dBuV/m)	Margin (dB)	Antenna Height (cm)	Table Angle (Degree)	Remark
5577.55	50.43	49.63	0.8	68.2	-17.77	100	318	Peak
5658.775	48.88	48.22	0.66	74.72	-25.84	100	318	Peak
5918.125	50.13	48.83	1.3	73.27	-23.14	100	318	Peak
5986.05	50.94	49.58	1.36	68.2	-17.26	100	318	Peak

Antenna Polarity & Test Distance: Vertical at 3 m								
Frequency (MHz)	Emission Level (dBuV/m)	Read Level (dBuV)	Factor (dB/m)	Limit (dBuV/m)	Margin (dB)	Antenna Height (cm)	Table Angle (Degree)	Remark
5565.675	55.48	54.65	0.83	68.2	-12.72	169	354	Peak
5653.55	53.16	52.46	0.7	70.84	-17.68	169	354	Peak
5919.075	53.95	52.65	1.3	72.57	-18.62	169	354	Peak
5929.05	51.85	50.55	1.3	68.2	-16.35	169	354	Peak

Remarks:

- Emission Level = Read Level + Factor
Margin value = Emission level – Limit value
- 5755 MHz: Fundamental Frequency
- The emission levels of other frequencies were very low against the limit

EUT Test Condition		Measurement Detail	
Channel	Channel 159	Frequency Range	1 GHz ~ 40 GHz
Input Power	120 Vac, 60 Hz	Detector Function	Peak (PK) Average (AV)
Environmental Conditions	25 deg. C, 65 % RH	Tested By	Cyril Chen

<Spurious Emission>

Antenna Polarity & Test Distance: Horizontal at 3 m								
Frequency (MHz)	Emission Level (dBuV/m)	Read Level (dBuV)	Factor (dB/m)	Limit (dBuV/m)	Margin (dB)	Antenna Height (cm)	Table Angle (Degree)	Remark
5795	98.47	97.52	0.95	-----	-----	111	319	Average
5795	105.67	104.72	0.95	-----	-----	111	319	Peak
11590	49.26	51.06	-1.8	54	-4.74	174	255	Average
11590	59.12	60.92	-1.8	74	-14.88	174	255	Peak

Antenna Polarity & Test Distance: Vertical at 3 m								
Frequency (MHz)	Emission Level (dBuV/m)	Read Level (dBuV)	Factor (dB/m)	Limit (dBuV/m)	Margin (dB)	Antenna Height (cm)	Table Angle (Degree)	Remark
5795	107.34	106.39	0.95	-----	-----	177	355	Average
5795	114.22	113.27	0.95	-----	-----	177	355	Peak
11590	46.68	48.48	-1.8	54	-7.32	169	205	Average
11590	55.15	56.95	-1.8	74	-18.85	169	205	Peak

<Out of Band Emission (OOBE)>

Antenna Polarity & Test Distance: Horizontal at 3 m								
Frequency (MHz)	Emission Level (dBuV/m)	Read Level (dBuV)	Factor (dB/m)	Limit (dBuV/m)	Margin (dB)	Antenna Height (cm)	Table Angle (Degree)	Remark
5638.825	50.7	50.03	0.67	68.2	-17.5	111	319	Peak
5655.925	48.6	47.95	0.65	72.6	-24	111	319	Peak
5918.125	50.02	48.72	1.3	73.27	-23.25	111	319	Peak
6006.95	51.66	50.26	1.4	68.2	-16.54	111	319	Peak

Antenna Polarity & Test Distance: Vertical at 3 m								
Frequency (MHz)	Emission Level (dBuV/m)	Read Level (dBuV)	Factor (dB/m)	Limit (dBuV/m)	Margin (dB)	Antenna Height (cm)	Table Angle (Degree)	Remark
5647.375	55.52	54.85	0.67	68.2	-12.68	177	355	Peak
5660.2	53.03	52.36	0.67	75.77	-22.74	177	355	Peak
5915.75	54.02	52.72	1.3	75.02	-21	177	355	Peak
5938.55	54.22	52.9	1.32	68.2	-13.98	177	355	Peak

Remarks:

- Emission Level = Read Level + Factor
Margin value = Emission level – Limit value
- 5795 MHz: Fundamental Frequency
- The emission levels of other frequencies were very low against the limit

802.11ac (VHT80)

EUT Test Condition		Measurement Detail	
Channel	Channel 42	Frequency Range	1 GHz ~ 40 GHz
Input Power	120 Vac, 60 Hz	Detector Function	Peak (PK) Average (AV)
Environmental Conditions	25 deg. C, 65 % RH	Tested By	Cyril Chen

Antenna Polarity & Test Distance: Horizontal at 3 m								
Frequency (MHz)	Emission Level (dBuV/m)	Read Level (dBuV)	Factor (dB/m)	Limit (dBuV/m)	Margin (dB)	Antenna Height (cm)	Table Angle (Degree)	Remark
5148.96	42.42	42	0.42	54	-11.58	272	204	Average
5148.96	53.5	53.08	0.42	74	-20.5	272	204	Peak
5210	87.03	86.91	0.12	-----	-----	272	204	Average
5210	95.78	95.66	0.12	-----	-----	272	204	Peak
5351.52	39.98	39.65	0.33	54	-14.02	272	204	Average
5351.52	51.82	51.49	0.33	74	-22.18	272	204	Peak
10420	55.69	57.43	-1.74	68.2	-12.51	123	168	Peak
Antenna Polarity & Test Distance: Vertical at 3 m								
Frequency (MHz)	Emission Level (dBuV/m)	Read Level (dBuV)	Factor (dB/m)	Limit (dBuV/m)	Margin (dB)	Antenna Height (cm)	Table Angle (Degree)	Remark
5147.04	53.02	52.59	0.43	54	-0.98	112	290	Average
5147.04	63.6	63.17	0.43	74	-10.4	112	290	Peak
5210	98.06	97.94	0.12	-----	-----	112	290	Average
5210	107.28	107.16	0.12	-----	-----	112	290	Peak
5350.56	46.7	46.37	0.33	54	-7.3	112	290	Average
5350.56	57.27	56.94	0.33	74	-16.73	112	290	Peak
10420	55.88	57.62	-1.74	68.2	-12.32	104	154	Peak

Remarks:

- Emission Level = Read Level + Factor
Margin value = Emission level – Limit value
- 5210 MHz: Fundamental Frequency
- The emission levels of other frequencies were very low against the limit

EUT Test Condition		Measurement Detail	
Channel	Channel 155	Frequency Range	1 GHz ~ 40 GHz
Input Power	120 Vac, 60 Hz	Detector Function	Peak (PK) Average (AV)
Environmental Conditions	25 deg. C, 65 % RH	Tested By	Cyril Chen

<Spurious Emission>

Antenna Polarity & Test Distance: Horizontal at 3 m								
Frequency (MHz)	Emission Level (dBuV/m)	Read Level (dBuV)	Factor (dB/m)	Limit (dBuV/m)	Margin (dB)	Antenna Height (cm)	Table Angle (Degree)	Remark
5775	93.57	92.63	0.94	-----	-----	100	319	Average
5775	100.1	99.16	0.94	-----	-----	100	319	Peak
11550	47.96	49.56	-1.6	54	-6.04	181	247	Average
11550	56.3	57.9	-1.6	74	-17.7	181	247	Peak

Antenna Polarity & Test Distance: Vertical at 3 m								
Frequency (MHz)	Emission Level (dBuV/m)	Read Level (dBuV)	Factor (dB/m)	Limit (dBuV/m)	Margin (dB)	Antenna Height (cm)	Table Angle (Degree)	Remark
5775	104.96	104.02	0.94	-----	-----	174	349	Average
5775	111.97	111.03	0.94	-----	-----	174	349	Peak
11550	48.51	50.11	-1.6	54	-5.49	181	247	Average
11550	56.53	58.13	-1.6	74	-17.47	181	247	Peak

<Out of Band Emission (OOBE)>

Antenna Polarity & Test Distance: Horizontal at 3 m								
Frequency (MHz)	Emission Level (dBuV/m)	Read Level (dBuV)	Factor (dB/m)	Limit (dBuV/m)	Margin (dB)	Antenna Height (cm)	Table Angle (Degree)	Remark
5643.1	57.83	57.15	0.68	68.2	-10.37	100	319	Peak
5659.725	58.42	57.75	0.67	75.42	-17	100	319	Peak
5921.925	55.89	54.59	1.3	70.47	-14.58	100	319	Peak
5943.3	53.01	51.69	1.32	68.2	-15.19	100	319	Peak

Antenna Polarity & Test Distance: Vertical at 3 m								
Frequency (MHz)	Emission Level (dBuV/m)	Read Level (dBuV)	Factor (dB/m)	Limit (dBuV/m)	Margin (dB)	Antenna Height (cm)	Table Angle (Degree)	Remark
5647.375	67.75	67.08	0.67	68.2	-0.45	174	349	Peak
5654.5	70	69.36	0.64	71.54	-1.54	174	349	Peak
5916.225	65.95	64.65	1.3	74.67	-8.72	174	349	Peak
5926.675	63.92	62.62	1.3	68.2	-4.28	174	349	Peak

Remarks:

- Emission Level = Read Level + Factor
Margin value = Emission level – Limit value
- 5775 MHz: Fundamental Frequency
- The emission levels of other frequencies were very low against the limit

9 kHz ~ 30 MHz Data:

The amplitude of spurious emissions attenuated more than 20 dB below the permissible value is not required to be report.

30 MHz ~ 1 GHz Worst-Case Data:

Mode A

802.11n (HT20)

EUT Test Condition		Measurement Detail	
Channel	Channel 36	Frequency Range	30 MHz ~ 1 GHz
Input Power	120 Vac, 60 Hz	Detector Function	Peak (PK) Quasi-peak (QP)
Environmental Conditions	25 deg. C, 65 % RH	Tested By	Tim Chen

Horizontal

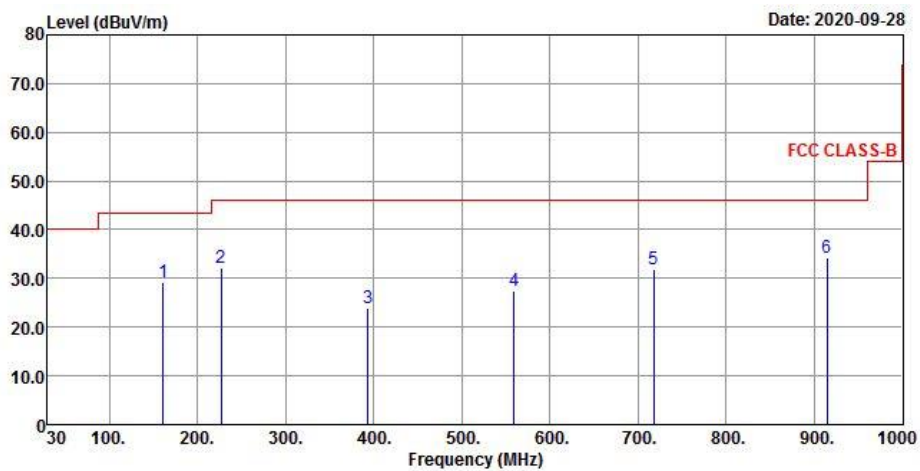

Vertical

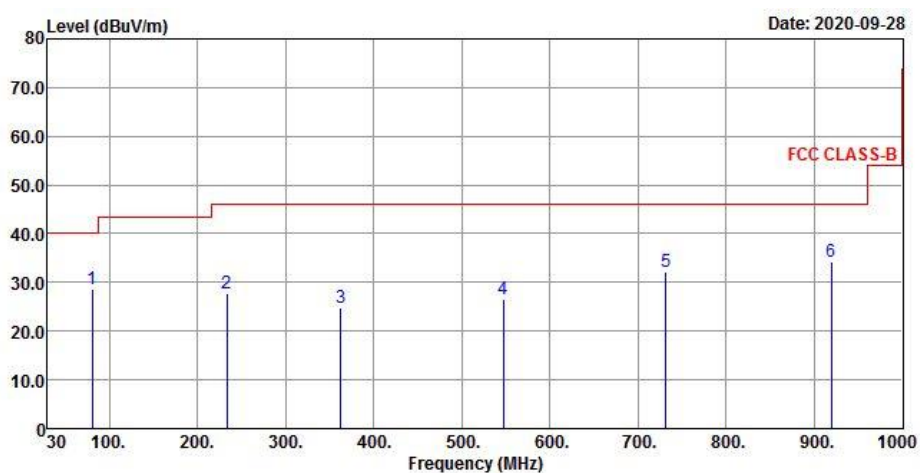

Antenna Polarity & Test Distance: Horizontal at 3 m								
Frequency (MHz)	Emission Level (dBuV/m)	Read Level (dBuV)	Factor (dB/m)	Limit (dBuV/m)	Margin (dB)	Antenna Height (cm)	Table Angle (Degree)	Remark
160.95	29.36	41.22	-11.86	43.5	-14.14	182	58	QP
226.91	32.17	47.11	-14.94	46	-13.83	174	132	QP
393.75	24.02	32.52	-8.5	46	-21.98	212	282	QP
559.62	27.34	31.5	-4.16	46	-18.66	284	133	QP
717.73	31.88	32.17	-0.29	46	-14.12	164	23	QP
914.64	34.29	31.06	3.23	46	-11.71	249	236	QP
Antenna Polarity & Test Distance: Vertical at 3 m								
Frequency (MHz)	Emission Level (dBuV/m)	Read Level (dBuV)	Factor (dB/m)	Limit (dBuV/m)	Margin (dB)	Antenna Height (cm)	Table Angle (Degree)	Remark
80.44	28.69	45.29	-16.6	40	-11.31	177	85	QP
233.7	27.68	41.63	-13.95	46	-18.32	242	83	QP
362.71	24.92	34.23	-9.31	46	-21.08	226	190	QP
547.01	26.53	31.08	-4.55	46	-19.47	279	55	QP
731.31	32.04	31.61	0.43	46	-13.96	298	274	QP
919.49	34.22	30.94	3.28	46	-11.78	163	97	QP

Remarks:

- Emission Level = Read Level + Factor
Margin value = Emission level – Limit value
- The emission levels of other frequencies were very low against the limit

Mode B

802.11n (HT20)

EUT Test Condition		Measurement Detail	
Channel	Channel 36	Frequency Range	30 MHz ~ 1 GHz
Input Power	120 Vac, 60 Hz	Detector Function	Peak (PK) Quasi-peak (QP)
Environmental Conditions	25 deg. C, 65 % RH	Tested By	Tim Chen

Horizontal

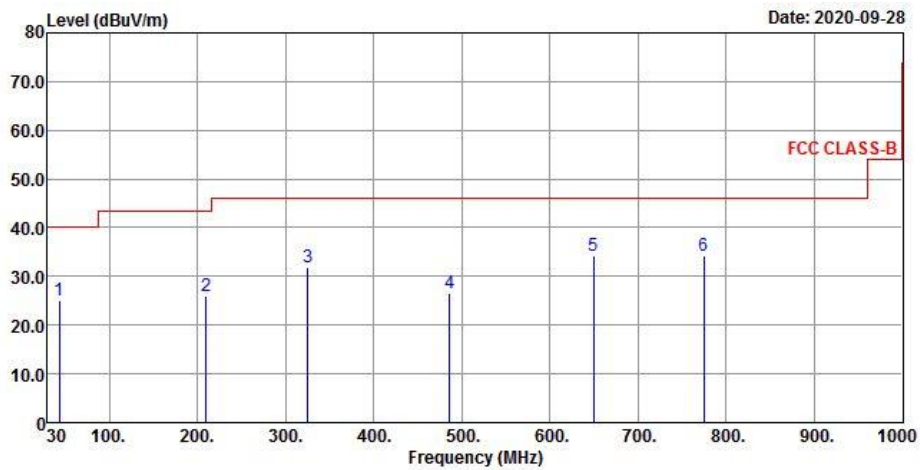

Vertical

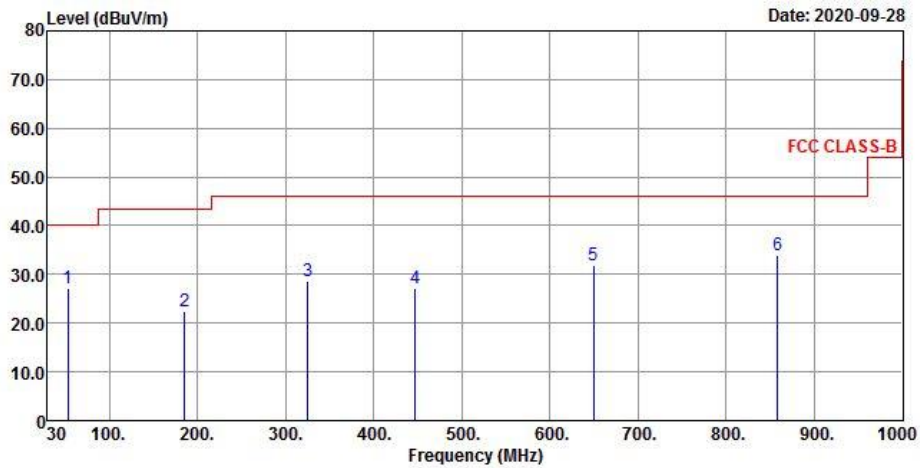

Antenna Polarity & Test Distance: Horizontal at 3 m								
Frequency (MHz)	Emission Level (dBuV/m)	Read Level (dBuV)	Factor (dB/m)	Limit (dBuV/m)	Margin (dB)	Antenna Height (cm)	Table Angle (Degree)	Remark
43.58	25.04	36.96	-11.92	40	-14.96	234	176	QP
209.45	26.12	41.21	-15.09	43.5	-17.38	288	142	QP
324.88	31.95	42.17	-10.22	46	-14.05	178	351	QP
485.9	26.44	32.19	-5.75	46	-19.56	294	168	QP
649.83	34.27	35.88	-1.61	46	-11.73	375	266	QP
774.96	34.22	32.78	1.44	46	-11.78	196	69	QP
Antenna Polarity & Test Distance: Vertical at 3 m								
Frequency (MHz)	Emission Level (dBuV/m)	Read Level (dBuV)	Factor (dB/m)	Limit (dBuV/m)	Margin (dB)	Antenna Height (cm)	Table Angle (Degree)	Remark
53.28	27.14	38.99	-11.85	40	-12.86	176	58	QP
185.2	22.32	36.41	-14.09	43.5	-21.18	371	224	QP
324.88	28.77	38.99	-10.22	46	-17.23	258	66	QP
447.1	27.23	33.74	-6.51	46	-18.77	183	311	QP
649.83	31.78	33.39	-1.61	46	-14.22	285	77	QP
858.38	33.87	31.31	2.56	46	-12.13	156	286	QP

Remarks:

1. Emission Level = Read Level + Factor
Margin value = Emission level – Limit value
2. The emission levels of other frequencies were very low against the limit

4.2 Conducted Emission Measurement

4.2.1 Limits of Conducted Emission Measurement

Frequency (MHz)	Conducted Limit (dBuV)	
	Quasi-Peak	Average
0.15 - 0.5	66 - 56	56 - 46
0.50 - 5.0	56	46
5.0 - 30.0	60	50

- Note: 1. The lower limit shall apply at the transition frequencies.
 2. The limit decreases in line with the logarithm of the frequency in the range of 0.15 to 0.50 MHz.

4.2.2 Test Instruments

Description & Manufacturer	Model No.	Serial No.	Date of Calibration	Due Date of Calibration
Test Receiver ROHDE & SCHWARZ	ESCI	100613	Dec. 11, 2019	Dec. 10, 2020
RF signal cable Woken	5D-FB	Cable-cond1-01	Sep. 04, 2020	Sep. 03, 2021
LISN/AMN ROHDE & SCHWARZ (EUT)	ENV216	101826	Feb. 20, 2020	Feb. 19, 2021
LISN/AMN ROHDE & SCHWARZ (Peripheral)	ESH3-Z5	100311	Aug. 28, 2020	Aug. 27, 2021
V-LISN/AMN SCHWARZBECK (Peripheral)	NNBL 8226-2	8226-142	Jul. 31, 2020	Jul. 30, 2021
Software ADT	BV ADT_Cond_ V7.3.7.4	NA	NA	NA

- Note: 1. The calibration interval of the above test instruments is 12 months and the calibrations are traceable to NML/ROC and NIST/USA.
 2. The test was performed in HwaYa Shielded Room 1.
 3. The VCCI Site Registration No. is C-12040.

4.2.3 Test Procedures

- The EUT was placed 0.4 meters from the conducting wall of the shielded room with EUT being connected to the power mains through a line impedance stabilization network (LISN). Other support units were connected to the power mains through another LISN. The two LISNs provide 50 ohm/ 50uH of coupling impedance for the measuring instrument.
- Both lines of the power mains connected to the EUT were checked for maximum conducted interference.
- The frequency range from 150 kHz to 30 MHz was searched. Emission levels under (Limit -20 dB) was not recorded.

Note: All modes of operation were investigated and the worst-case emissions are reported.

4.2.4 Deviation from Test Standard

No deviation.

4.2.5 Test Setup

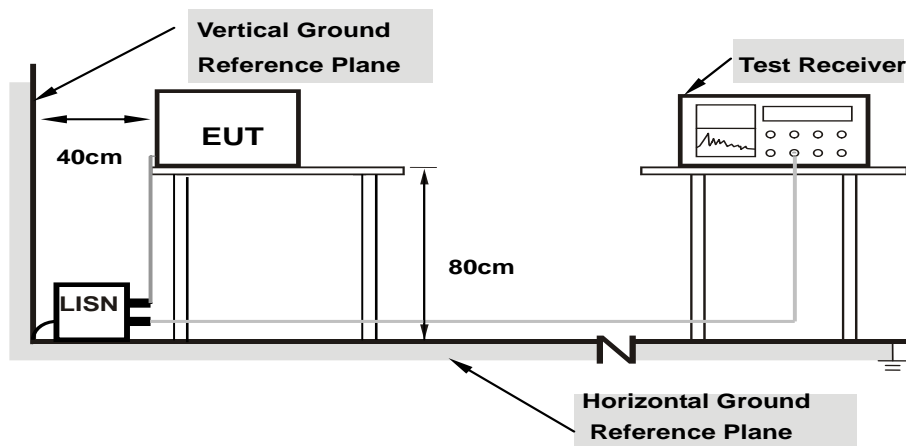

- Note:**
- Support units were connected to second LISN.
 - Both of LISNs (AMN) are 80 cm from EUT and at least 80 from other units and other metal planes

For the actual test configuration, please refer to the attached file (Test Setup Photo).

4.2.6 EUT Operating Conditions

- Placed the EUT on a testing table.
- Use the software to control the EUT under transmission condition continuously at specific channel frequency.

4.2.7 Test Results

Mode A

Frequency Range	150kHz ~ 30MHz	Detector Function & Bandwidth	Quasi-Peak (QP) / Average (AV), 9kHz
Input Power	120Vac, 60Hz	Environmental Conditions	22°C, 69%RH

Phase Of Power : Line (L)										
No	Frequency (MHz)	Correction Factor (dB)	Reading Value (dBuV)		Emission Level (dBuV)		Limit (dBuV)		Margin (dB)	
			Q.P.	AV.	Q.P.	AV.	Q.P.	AV.	Q.P.	AV.
1	0.15728	9.65	38.53	30.08	48.18	39.73	65.61	55.61	-17.43	-15.88
2	0.20042	9.66	36.90	28.16	46.56	37.82	63.59	53.59	-17.03	-15.77
3	0.39800	9.66	40.78	34.39	50.44	44.05	57.90	47.90	-7.46	-3.85
4	1.21400	9.68	27.13	18.12	36.81	27.80	56.00	46.00	-19.19	-18.20
5	14.26600	9.84	17.34	11.72	27.18	21.56	60.00	50.00	-32.82	-28.44
6	21.40600	9.85	26.08	25.67	35.93	35.52	60.00	50.00	-24.07	-14.48

Remarks:

1. Q.P. and AV. are abbreviations of quasi-peak and average individually.
2. The emission levels of other frequencies were very low against the limit.
3. Margin value = Emission level – Limit value
4. Correction factor = Insertion loss + Cable loss
5. Emission Level = Correction Factor + Reading Value

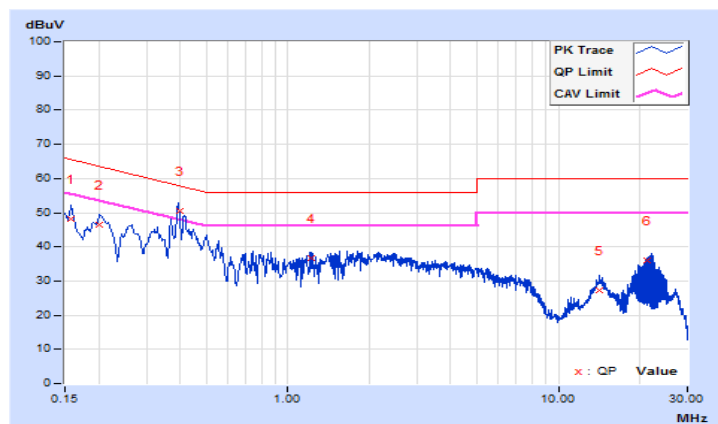

Frequency Range	150kHz ~ 30MHz	Detector Function & Bandwidth	Quasi-Peak (QP) / Average (AV), 9kHz
Input Power	120Vac, 60Hz	Environmental Conditions	22°C, 69%RH

Phase Of Power : Neutral (N)										
No	Frequency (MHz)	Correction Factor (dB)	Reading Value (dBuV)		Emission Level (dBuV)		Limit (dBuV)		Margin (dB)	
			Q.P.	AV.	Q.P.	AV.	Q.P.	AV.	Q.P.	AV.
1	0.15400	9.68	39.19	30.59	48.87	40.27	65.78	55.78	-16.91	-15.51
2	0.26429	9.68	35.34	26.55	45.02	36.23	61.30	51.30	-16.28	-15.07
3	0.38929	9.68	38.41	33.96	48.09	43.64	58.08	48.08	-9.99	-4.44
4	1.53000	9.71	26.58	18.25	36.29	27.96	56.00	46.00	-19.71	-18.04
5	14.57000	9.92	19.11	12.05	29.03	21.97	60.00	50.00	-30.97	-28.03
6	21.67400	9.98	25.45	24.62	35.43	34.60	60.00	50.00	-24.57	-15.40

Remarks:

1. Q.P. and AV. are abbreviations of quasi-peak and average individually.
2. The emission levels of other frequencies were very low against the limit.
3. Margin value = Emission level – Limit value
4. Correction factor = Insertion loss + Cable loss
5. Emission Level = Correction Factor + Reading Value

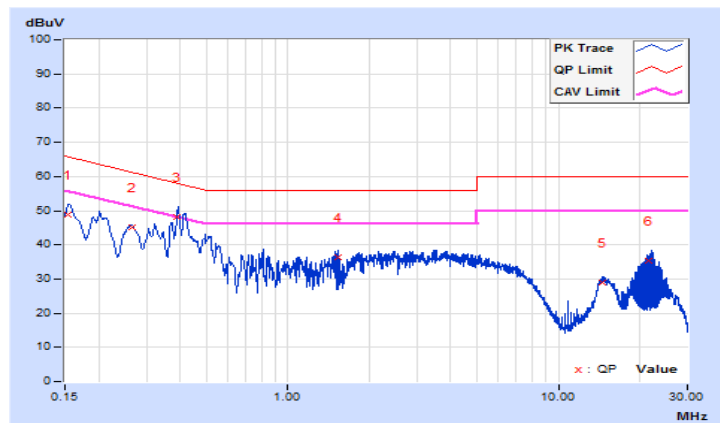

Mode B

Frequency Range	150kHz ~ 30MHz	Detector Function & Bandwidth	Quasi-Peak (QP) / Average (AV), 9kHz
Input Power	120Vac, 60Hz	Environmental Conditions	22°C, 69%RH

Phase Of Power : Line (L)										
No	Frequency (MHz)	Correction Factor (dB)	Reading Value (dBuV)		Emission Level (dBuV)		Limit (dBuV)		Margin (dB)	
			Q.P.	AV.	Q.P.	AV.	Q.P.	AV.	Q.P.	AV.
1	0.15400	9.65	27.03	2.44	36.68	12.09	65.78	55.78	-29.10	-43.69
2	0.17000	9.65	25.45	1.54	35.10	11.19	64.96	54.96	-29.86	-43.77
3	0.24200	9.66	15.28	1.05	24.94	10.71	62.03	52.03	-37.09	-41.32
4	0.88600	9.67	12.48	2.83	22.15	12.50	56.00	46.00	-33.85	-33.50
5	1.41400	9.68	10.15	1.18	19.83	10.86	56.00	46.00	-36.17	-35.14
6	16.22600	9.85	10.62	6.91	20.47	16.76	60.00	50.00	-39.53	-33.24

Remarks:

1. Q.P. and AV. are abbreviations of quasi-peak and average individually.
2. The emission levels of other frequencies were very low against the limit.
3. Margin value = Emission level – Limit value
4. Correction factor = Insertion loss + Cable loss
5. Emission Level = Correction Factor + Reading Value

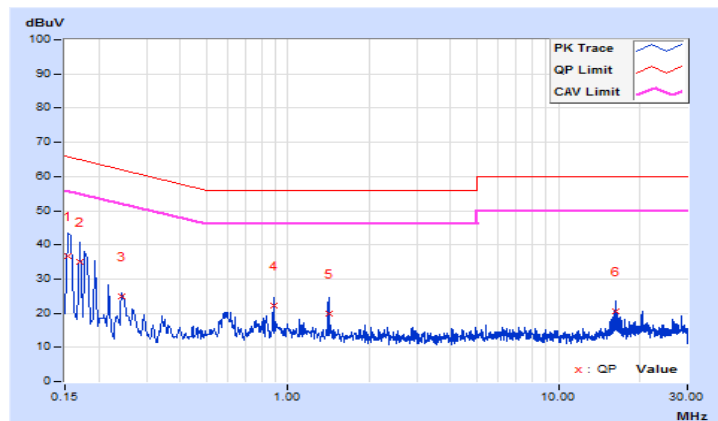

Frequency Range	150kHz ~ 30MHz	Detector Function & Bandwidth	Quasi-Peak (QP) / Average (AV), 9kHz
Input Power	120Vac, 60Hz	Environmental Conditions	22°C, 69%RH

Phase Of Power : Neutral (N)										
No	Frequency (MHz)	Correction Factor (dB)	Reading Value (dBuV)		Emission Level (dBuV)		Limit (dBuV)		Margin (dB)	
			Q.P.	AV.	Q.P.	AV.	Q.P.	AV.	Q.P.	AV.
1	0.16200	9.68	26.20	3.92	35.88	13.60	65.36	55.36	-29.48	-41.76
2	0.18600	9.68	18.85	2.92	28.53	12.60	64.21	54.21	-35.68	-41.61
3	0.21000	9.68	14.71	1.83	24.39	11.51	63.21	53.21	-38.82	-41.70
4	0.78200	9.69	11.32	1.22	21.01	10.91	56.00	46.00	-34.99	-35.09
5	0.96200	9.69	12.50	2.14	22.19	11.83	56.00	46.00	-33.81	-34.17
6	16.53400	9.95	5.29	1.26	15.24	11.21	60.00	50.00	-44.76	-38.79

Remarks:

1. Q.P. and AV. are abbreviations of quasi-peak and average individually.
2. The emission levels of other frequencies were very low against the limit.
3. Margin value = Emission level – Limit value
4. Correction factor = Insertion loss + Cable loss
5. Emission Level = Correction Factor + Reading Value

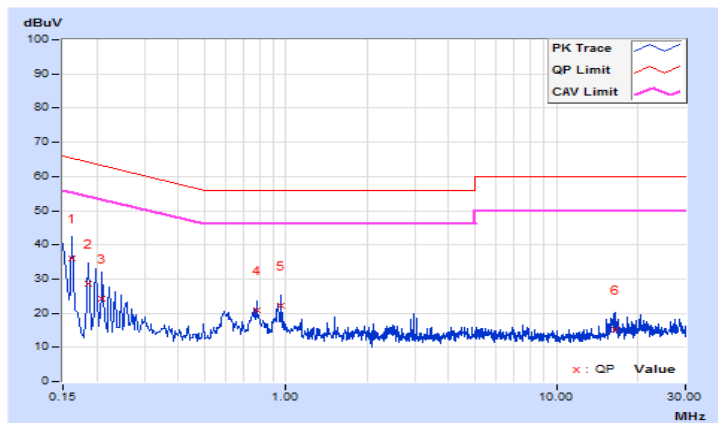

4.3 Transmit Power Measurement

4.3.1 Limits of Transmit Power Measurement

Operation Band	EUT Category		Limit
U-NII-1		Outdoor Access Point	1 Watt (30 dBm) (Max. e.i.r.p \leq 125 mW (21 dBm) at any elevation angle above 30 degrees as measured from the horizon)
		Fixed point-to-point Access Point	1 Watt (30 dBm)
	√	Indoor Access Point	1 Watt (30 dBm)
		Mobile and Portable client device	250 mW (24 dBm)
U-NII-2A			250 mW (24 dBm) or 11 dBm + 10 log B*
U-NII-2C			250 mW (24 dBm) or 11 dBm + 10 log B*
U-NII-3	√		1 Watt (30 dBm)

*B is the 26 dB emission bandwidth in megahertz

4.3.2 Test Setup

<Power Output Measurement>

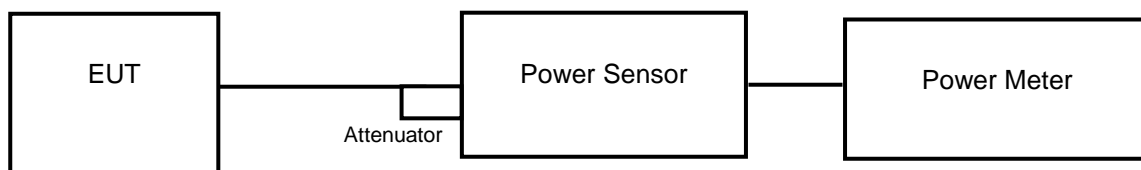

<26 dB Bandwidth>

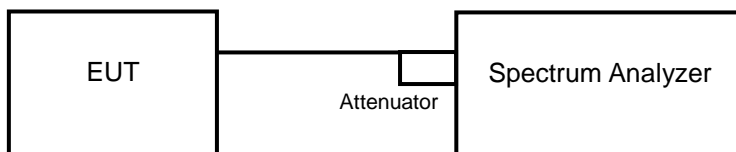

4.3.3 Test Instruments

Refer to section 4.1.3 to get information of above instrument.

4.3.4 Test Procedure

Average Power Measurement

Method PM is used to perform output power measurement, trigger and gating function of wide band power meter is enabled to measure max output power of TX on burst. Duty factor is not added to measured value.

26 dB Bandwidth

- a. Set RBW = approximately 1 % of the emission bandwidth.
- b. Set the VBW > RBW.
- c. Detector = Peak.
- d. Trace mode = max hold.
- e. Measure the maximum width of the emission that is 26 dB down from the peak of the emission. Compare this with the RBW setting of the analyzer. Readjust RBW and repeat measurement as needed until the RBW/EBW ratio is approximately 1 %.

4.3.5 Deviation from Test Standard

No deviation.

4.3.6 EUT Operating Conditions

The software provided by client to enable the EUT under transmission condition continuously at lowest, middle and highest channel frequencies individually.

4.3.7 Test Results

Power Output:

CDD Mode

802.11a

Channel	Frequency (MHz)	Maximum Conducted Power (dBm)		Total Power (mW)	Total Power (dBm)	Power Limit (dBm)	Pass / Fail
		Chain 0	Chain 1				
36	5180	21.12	20.97	254.445	24.06	30	Pass
40	5200	21.88	21.63	299.716	24.77	30	Pass
48	5240	21.79	21.34	287.152	24.58	30	Pass
149	5745	22.12	21.78	313.59	24.96	30	Pass
157	5785	22.31	22.14	333.898	25.24	30	Pass
165	5825	22.53	22.12	341.99	25.34	30	Pass

802.11ac (VHT20)

Channel	Frequency (MHz)	Maximum Conducted Power (dBm)		Total Power (mW)	Total Power (dBm)	Power Limit (dBm)	Pass / Fail
		Chain 0	Chain 1				
36	5180	21.08	20.80	248.46	23.95	30	Pass
40	5200	21.60	21.29	279.13	24.46	30	Pass
48	5240	21.57	21.11	272.671	24.36	30	Pass
149	5745	22.11	21.67	309.448	24.91	30	Pass
157	5785	22.26	21.88	322.437	25.08	30	Pass
165	5825	22.41	22.08	335.617	25.26	30	Pass

802.11ac (VHT40)

Channel	Frequency (MHz)	Maximum Conducted Power (dBm)		Total Power (mW)	Total Power (dBm)	Power Limit (dBm)	Pass / Fail
		Chain 0	Chain 1				
38	5190	16.61	16.24	87.887	19.44	30	Pass
46	5230	21.70	21.54	290.472	24.63	30	Pass
151	5755	22.68	22.13	348.658	25.42	30	Pass
159	5795	22.86	22.41	367.378	25.65	30	Pass

802.11ac (VHT80)

Channel	Frequency (MHz)	Maximum Conducted Power (dBm)		Total Power (mW)	Total Power (dBm)	Power Limit (dBm)	Pass / Fail
		Chain 0	Chain 1				
42	5210	14.85	14.39	58.028	17.64	30	Pass
155	5775	20.53	20.49	224.923	23.52	30	Pass

Beamforming Mode

802.11ac (VHT20)

Channel	Frequency (MHz)	Maximum Conducted Power (dBm)		Total Power (mW)	Total Power (dBm)	Power Limit (dBm)	Pass / Fail
		Chain 0	Chain 1				
36	5180	21.08	20.80	248.46	23.95	28.66	Pass
40	5200	21.60	21.29	279.13	24.46	28.66	Pass
48	5240	21.57	21.11	272.671	24.36	28.66	Pass

NOTE: Directional gain = 7.34dBi > 6dBi , so the output power limit shall be reduced to $30-(7.34-6) = 28.66$ dBm.

Channel	Frequency (MHz)	Maximum Conducted Power (dBm)		Total Power (mW)	Total Power (dBm)	Power Limit (dBm)	Pass / Fail
		Chain 0	Chain 1				
149	5745	22.11	21.67	309.448	24.91	27.25	Pass
157	5785	22.26	21.88	322.437	25.08	27.25	Pass
165	5825	22.41	22.08	335.617	25.26	27.25	Pass

NOTE: Directional gain = 8.75dBi > 6dBi , so the output power limit shall be reduced to $30-(8.75-6) = 27.25$ dBm.

802.11ac (VHT40)

Channel	Frequency (MHz)	Maximum Conducted Power (dBm)		Total Power (mW)	Total Power (dBm)	Power Limit (dBm)	Pass / Fail
		Chain 0	Chain 1				
38	5190	16.61	16.24	87.887	19.44	28.66	Pass
46	5230	21.70	21.54	290.472	24.63	28.66	Pass

NOTE: Directional gain = 7.34dBi > 6dBi , so the output power limit shall be reduced to $30-(7.34-6) = 28.66$ dBm.

Channel	Frequency (MHz)	Maximum Conducted Power (dBm)		Total Power (mW)	Total Power (dBm)	Power Limit (dBm)	Pass / Fail
		Chain 0	Chain 1				
151	5755	22.68	22.13	348.658	25.42	27.25	Pass
159	5795	22.86	22.41	367.378	25.65	27.25	Pass

NOTE: Directional gain = 8.75dBi > 6dBi , so the output power limit shall be reduced to $30-(8.75-6) = 27.25$ dBm.

802.11ac (VHT80)

Channel	Frequency (MHz)	Maximum Conducted Power (dBm)		Total Power (mW)	Total Power (dBm)	Power Limit (dBm)	Pass / Fail
		Chain 0	Chain 1				
42	5210	14.85	14.39	58.028	17.64	28.66	Pass

NOTE: Directional gain = 7.34dBi > 6dBi , so the output power limit shall be reduced to $30-(7.34-6) = 28.66$ dBm.

Channel	Frequency (MHz)	Maximum Conducted Power (dBm)		Total Power (mW)	Total Power (dBm)	Power Limit (dBm)	Pass / Fail
		Chain 0	Chain 1				
155	5775	20.53	20.49	224.923	23.52	27.25	Pass

NOTE: Directional gain = 8.75dBi > 6dBi , so the output power limit shall be reduced to $30-(8.75-6) = 27.25$ dBm.

26 dB Bandwidth:

802.11a

Channel	Frequency (MHz)	26 dBc Bandwidth (MHz)	
		Chain 0	Chain 1
36	5180	20.03	20.06
40	5200	20.15	20.18
48	5240	20.43	20.46

802.11ac (VHT20)

Channel	Frequency (MHz)	26 dBc Bandwidth (MHz)	
		Chain 0	Chain 1
36	5180	21.13	20.55
40	5200	21.24	20.98
48	5240	21.46	21.20

802.11ac (VHT40)

Channel	Frequency (MHz)	26 dBc Bandwidth (MHz)	
		Chain 0	Chain 1
38	5190	40.36	40.96
46	5230	40.80	40.84

802.11ac (VHT80)

Channel	Frequency (MHz)	26 dBc Bandwidth (MHz)	
		Chain 0	Chain 1
42	5210	82.87	84.52

Spectrum Plot of Worst Value

802.11a

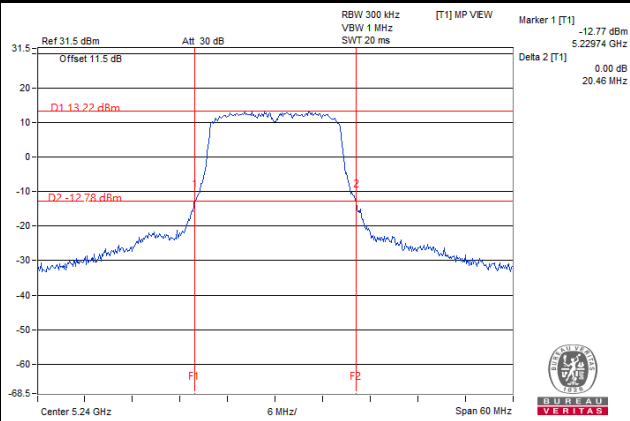

802.11ac (VHT20)

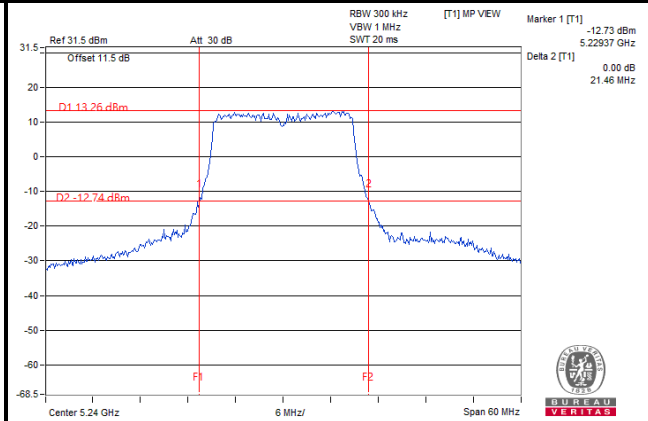

802.11ac (VHT40)

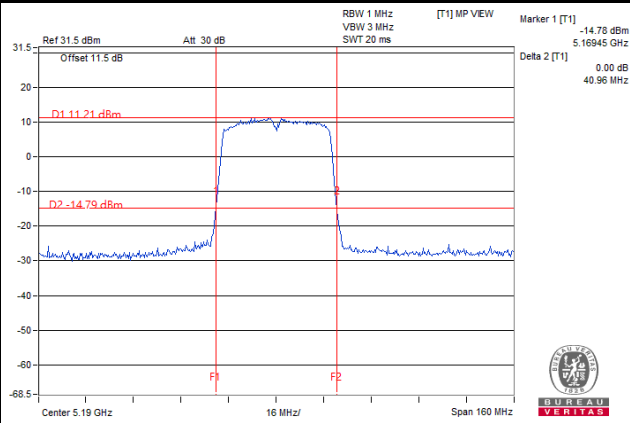

802.11ac (VHT80)

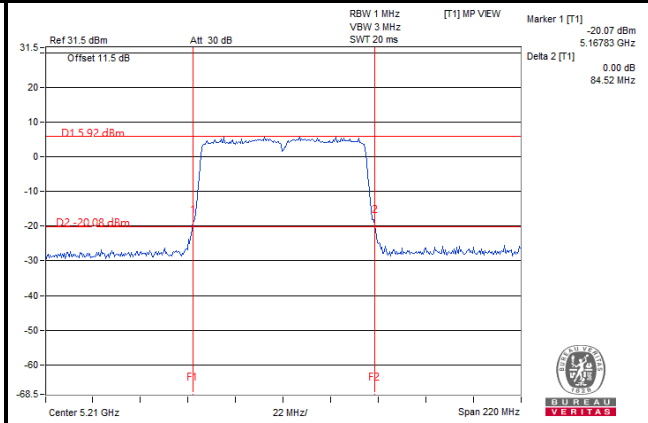

4.4 Occupied Bandwidth Measurement

4.4.1 Test Setup

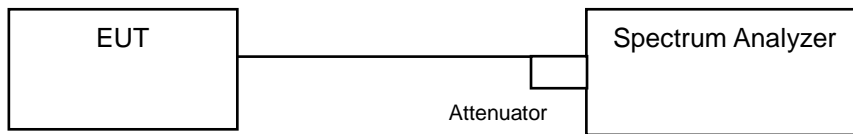

4.4.2 Test Instruments

Refer to section 4.1.3 to get information of above instrument.

4.4.3 Test Procedure

The transmitter output was connected to the spectrum analyzer through an attenuator. The bandwidth of the fundamental frequency was measured by spectrum analyzer with resolution bandwidth in the range of 1 % to 5 % of the anticipated emission bandwidth, and a video bandwidth at least 3x the resolution bandwidth and set the detector to SAMPLE. The width of a frequency band such that, below the lower and above the upper frequency limits, the mean powers emitted are each equal to a specified percentage 0.5 % of the total mean power of a given emission.

4.4.4 Test Results

802.11a

Channel	Channel Frequency (MHz)	Occupied Bandwidth (MHz)	
		Chain 0	Chain 1
36	5180	16.56	16.44
40	5200	16.56	16.44
48	5240	16.56	16.44
149	5745	16.43	16.44
157	5785	16.44	16.44
165	5825	16.56	16.68

802.11ac (VHT20)

Channel	Channel Frequency (MHz)	Occupied Bandwidth (MHz)	
		Chain 0	Chain 1
36	5180	17.76	17.64
40	5200	17.76	17.64
48	5240	17.76	17.64
149	5745	17.64	17.64
157	5785	17.64	17.64
165	5825	17.76	17.64

802.11ac (VHT40)

Channel	Channel Frequency (MHz)	Occupied Bandwidth (MHz)	
		Chain 0	Chain 1
38	5190	36.00	36.24
46	5230	36.36	36.12
151	5755	36.12	36.36
159	5795	36.24	36.24

802.11ac (VHT80)

Channel	Channel Frequency (MHz)	Occupied Bandwidth (MHz)	
		Chain 0	Chain 1
42	5210	75.36	76.08
155	5775	75.84	76.08

Spectrum Plot of Worst Value

802.11a

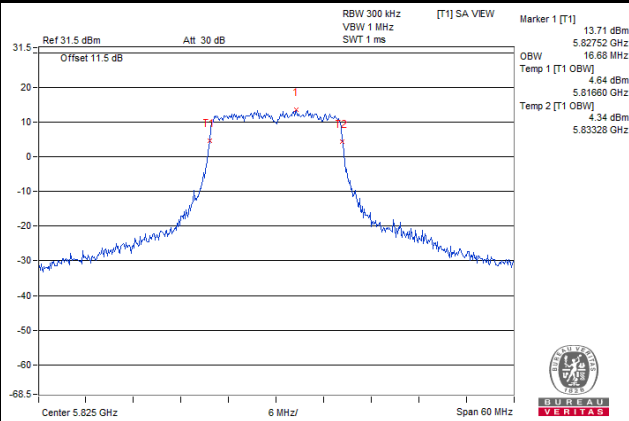

802.11ac (VHT20)

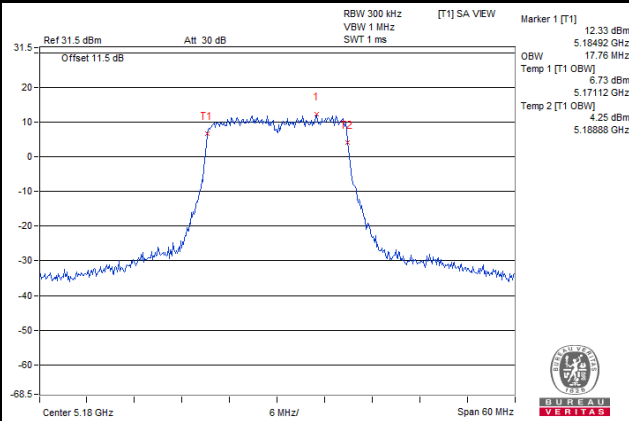

802.11ac (VHT40)

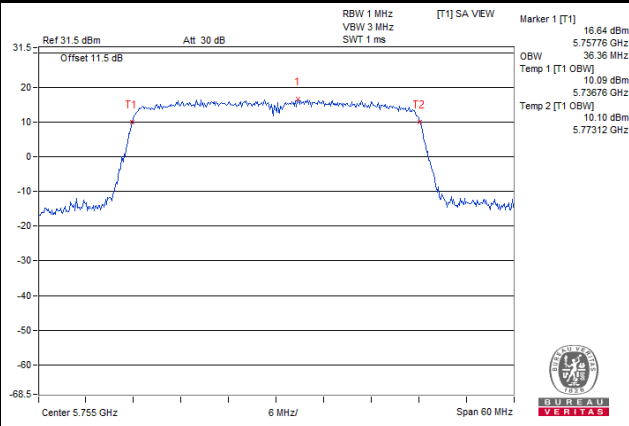

802.11ac (VHT80)

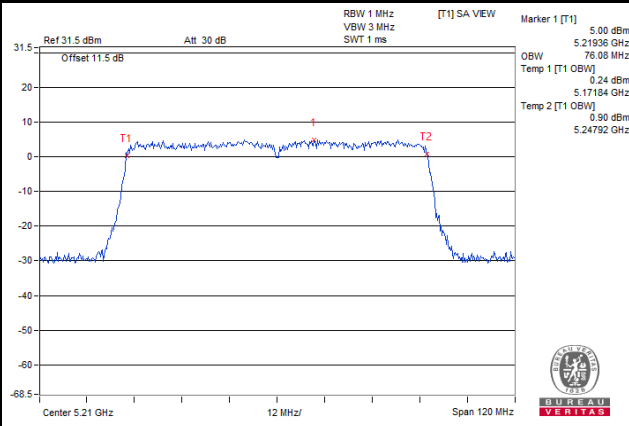

Chain 0

Spectrum Plot for Nearby DFS Band

802.11a

Ch 48 (5240 MHz)

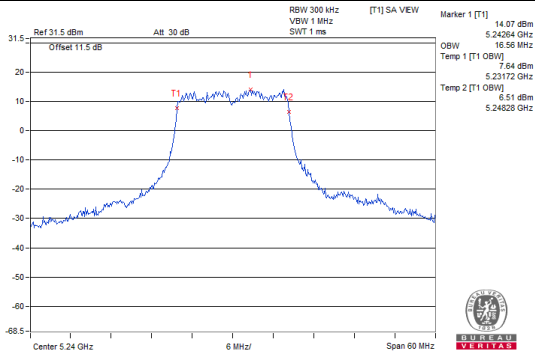

Ch 149 (5745 MHz)

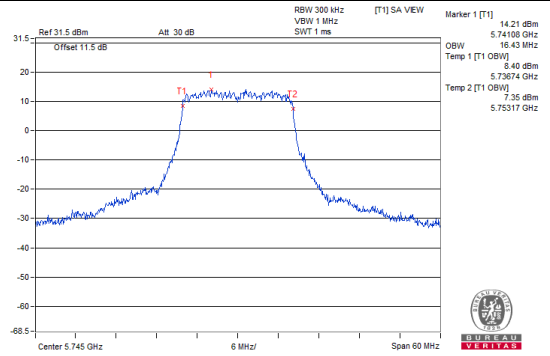

802.11ac (VHT20)

Ch 48 (5240 MHz)

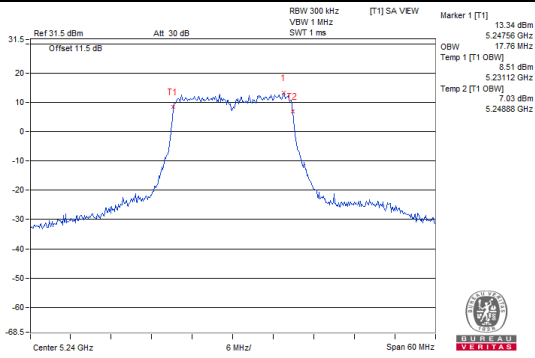

Ch 149 (5745 MHz)

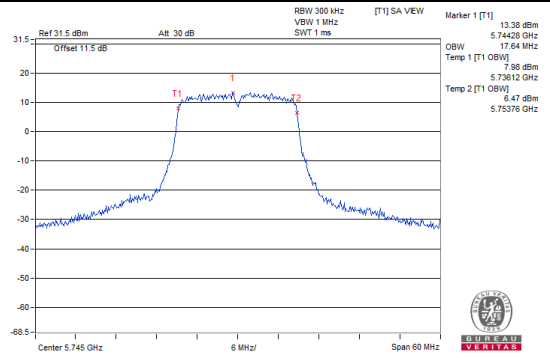

802.11ac (VHT40)

Ch 46 (5230 MHz)

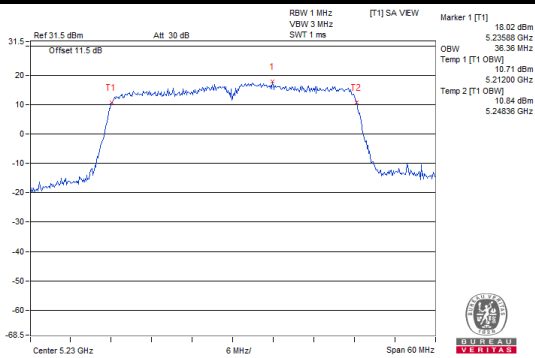

Ch 151 (5755 MHz)

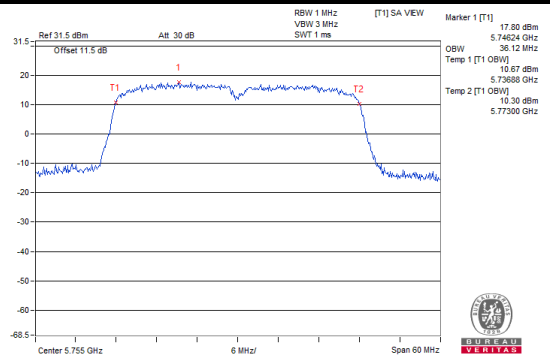

802.11ac (VHT80)

Ch 42 (5210 MHz)

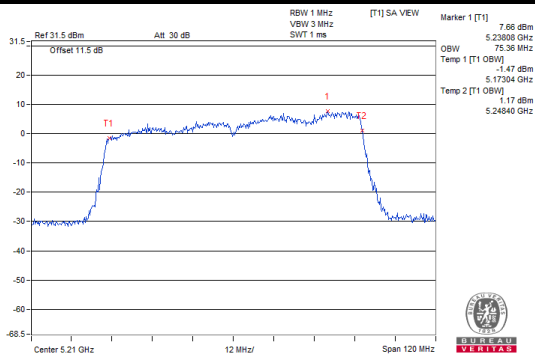

Ch 155 (5775 MHz)

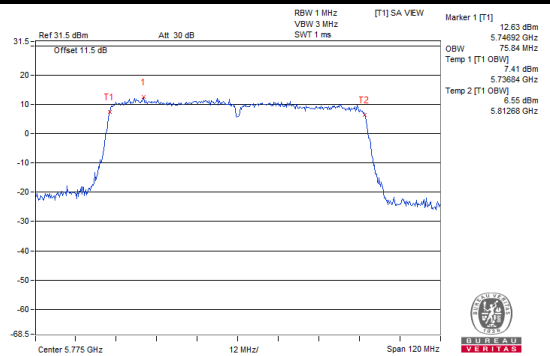

Chain 1

Spectrum Plot for Nearby DFS Band

802.11a

Ch 48 (5240 MHz)

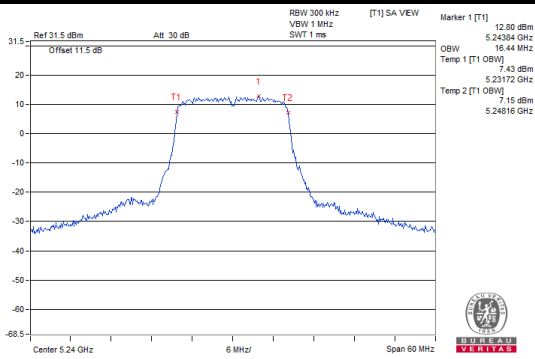

Ch 149 (5745 MHz)

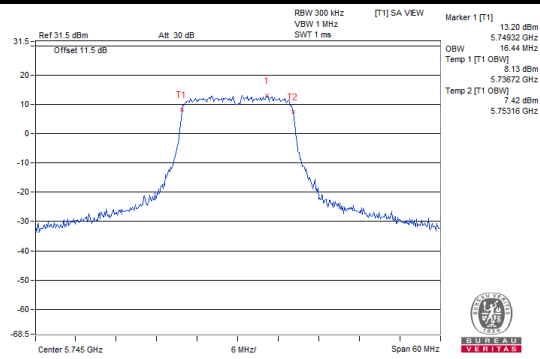

802.11ac (VHT20)

Ch 48 (5240 MHz)

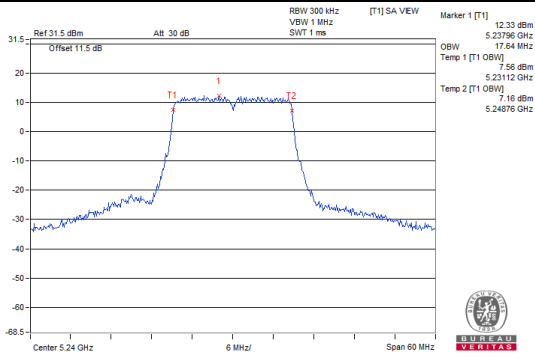

Ch 149 (5745 MHz)

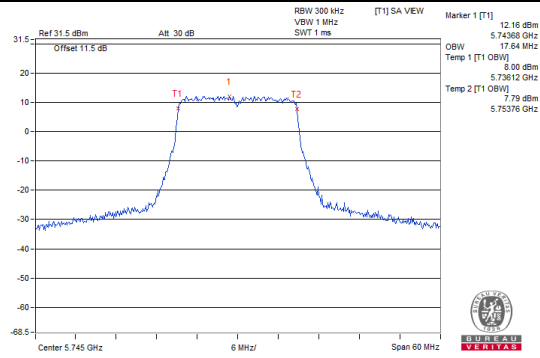

802.11ac (VHT40)

Ch 46 (5230 MHz)

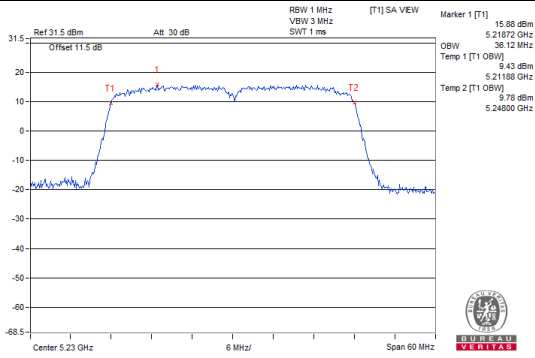

Ch 151 (5755 MHz)

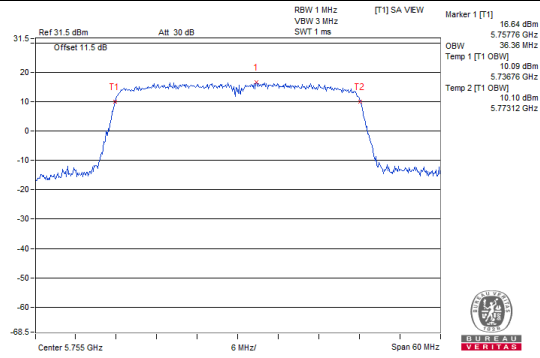

802.11ac (VHT80)

Ch 42 (5210 MHz)

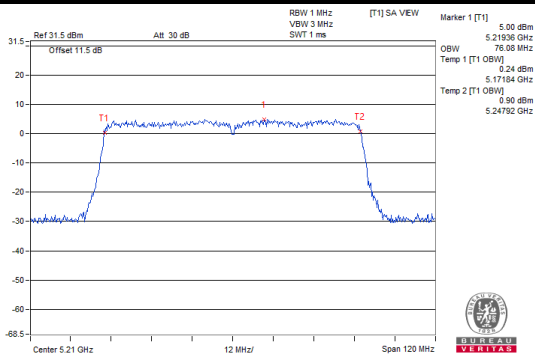

Ch 155 (5775 MHz)

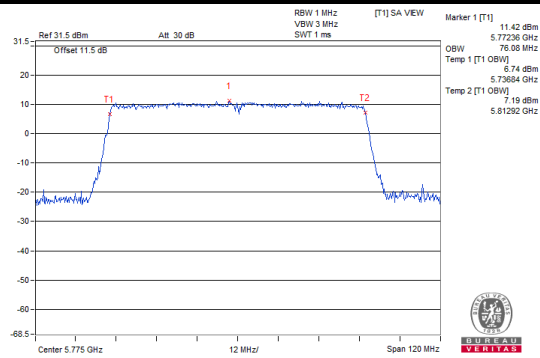

4.5 Peak Power Spectral Density Measurement

4.5.1 Limits of Peak Power Spectral Density Measurement

Operation Band	EUT Category		Limit
U-NII-1		Outdoor Access Point	17 dBm/MHz
		Fixed point-to-point Access Point	
	√	Indoor Access Point	
		Mobile and Portable client device	11 dBm/MHz
U-NII-2A			11 dBm/MHz
U-NII-2C			11 dBm/MHz
U-NII-3		√	30 dBm/500 kHz

4.5.2 Test Setup

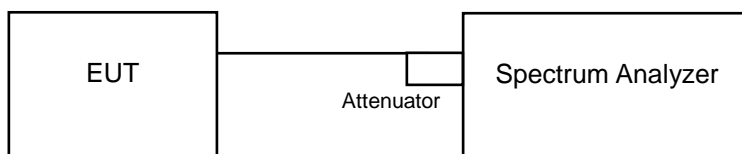

4.5.3 Test Instruments

Refer to section 4.1.3 to get information of above instrument.

4.5.4 Test Procedures

For U-NII-1

Using method SA-2 (DC < 98%) and SA-1 (DC ≥ 98%)

Set span to encompass the entire emission bandwidth (EBW) of the signal.

1. Set RBW = 1 MHz, Set VBW ≥ 3 RBW, Detector = RMS
2. Sweep time = auto, trigger set to "free run".
3. Trace average at least 100 traces in power averaging mode.
4. Record the max value and add 10 log (1/duty cycle) if DC < 98%

※ For U-NII-3:

Set span to encompass the entire emission bandwidth (EBW) of the signal.

1. Set RBW = 300 kHz, Set VBW ≥ 1 RBW, Detector = RMS
2. Use the peak marker function to determine the maximum power level in any 300 kHz band segment within the fundamental EBW.
3. Scale the observed power level to an equivalent value in 500 kHz by adjusting (increasing) the measured power by a bandwidth correction factor (BWCF) where $BWCF = 10\log(500 \text{ kHz} / 300 \text{ kHz})$.
4. Sweep time = auto, trigger set to "free run".
5. Trace average at least 100 traces in power averaging mode.
6. Record the max value and add 10 log (1/duty cycle) if DC < 98%

4.5.5 Deviation from Test Standard

No deviation.

4.5.6 EUT Operating Conditions

The software provided by client to enable the EUT under transmission condition continuously at lowest, middle and highest channel frequencies individually.

4.5.7 Test Results

**For U-NII-1,
802.11a**

Channel	Frequency (MHz)	PSD (dBm/MHz)		Duty Factor (dB)	Total PSD with Duty Factor (dBm/MHz)	Max. Limit (dBm/MHz)	Pass / Fail
		Chain 0	Chain 1				
36	5180	8.37	8.04	0.23	11.45	15.66	Pass
40	5200	9.39	8.45	0.23	12.19	15.66	Pass
48	5240	9.70	8.06	0.23	12.20	15.66	Pass

Note:

- Method E) 2) a) of power density measurement of KDB 662911 is using for calculating total power density. Total power density is summing entire spectra across corresponding frequency bins on the various outputs by computer.
- For U-NII-1:**
The directional gain = 7.34 dBi > 6dBi, so the power density limit shall be reduced to $17-(7.34-6) = 15.66$ dBm/MHz.
- Refer to section 3.3 for duty cycle spectrum plot.

802.11ac (VHT20)

Channel	Frequency (MHz)	PSD (dBm/MHz)		Total PSD with Duty Factor (dBm/MHz)	Max. Limit (dBm/MHz)	Pass / Fail
		Chain 0	Chain 1			
36	5180	7.17	7.67	10.44	15.66	Pass
40	5200	7.90	8.20	11.06	15.66	Pass
48	5240	8.72	7.41	11.12	15.66	Pass

Note:

- Method E) 2) a) of power density measurement of KDB 662911 is using for calculating total power density. Total power density is summing entire spectra across corresponding frequency bins on the various outputs by computer.
- For U-NII-1:**
The directional gain = 7.34 dBi > 6dBi, so the power density limit shall be reduced to $17-(7.34-6) = 15.66$ dBm/MHz.
- Refer to section 3.3 for duty cycle spectrum plot.

802.11ac (VHT40)

Channel	Frequency (MHz)	PSD (dBm/MHz)		Duty Factor (dB)	Total PSD with Duty Factor (dBm/MHz)	Max. Limit (dBm/MHz)	Pass / Fail
		Chain 0	Chain 1				
38	5190	1.42	-0.44	0.12	3.72	15.66	Pass
46	5230	7.32	5.18	0.12	9.51	15.66	Pass

Note:

- Method E) 2) a) of power density measurement of KDB 662911 is using for calculating total power density. Total power density is summing entire spectra across corresponding frequency bins on the various outputs by computer.
- For U-NII-1:**
The directional gain = 7.34 dBi > 6dBi, so the power density limit shall be reduced to $17-(7.34-6) = 15.66$ dBm/MHz.
- Refer to section 3.3 for duty cycle spectrum plot.

802.11ac (VHT80)

Channel	Frequency (MHz)	PSD (dBm/MHz)		Duty Factor (dB)	Total PSD with Duty Factor (dBm/MHz)	Max. Limit (dBm/MHz)	Pass / Fail
		Chain 0	Chain 1				
42	5210	-2.16	-5.30	0.32	-0.12	15.66	Pass

Note:

- Method E) 2) a) of power density measurement of KDB 662911 is using for calculating total power density. Total power density is summing entire spectra across corresponding frequency bins on the various outputs by computer.
- For U-NII-1:**
The directional gain = 7.34 dBi > 6dBi, so the power density limit shall be reduced to $17-(7.34-6) = 15.66$ dBm/MHz.
- Refer to section 3.3 for duty cycle spectrum plot.

Spectrum Plot of Worst Value

802.11a

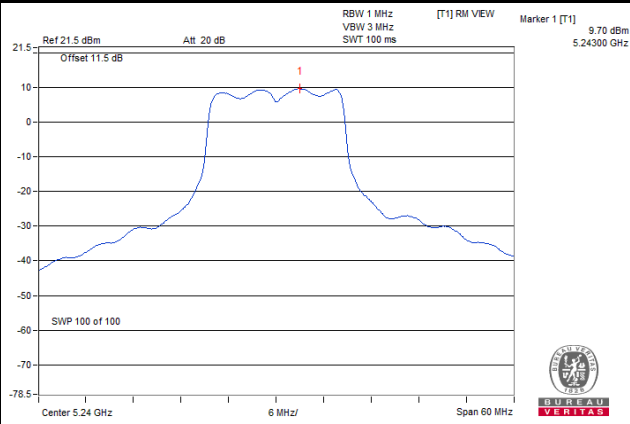

802.11ac (VHT20)

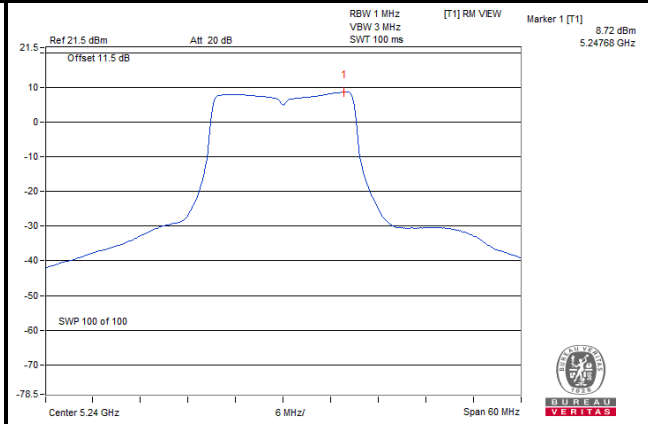

802.11ac (VHT40)

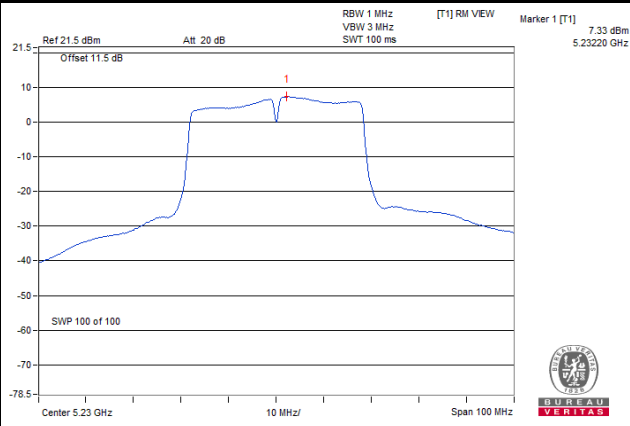

802.11ac (VHT80)

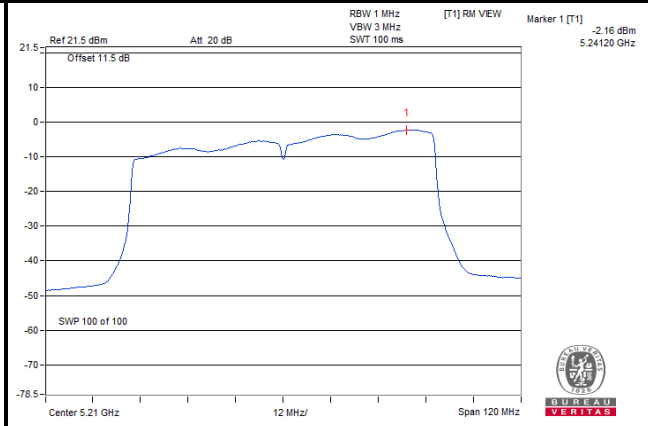

For U-NII-3 Band

802.11a

TX Chain	Channel	Frequency (MHz)	PSD w/o Duty Factor		10 log (N=2) dB	Duty Factor (dB)	Total PSD with Duty Factor (dBm/500 kHz)	Limit (dBm/500 kHz)	Pass / Fail
			(dBm/300 kHz)	(dBm/500 kHz)					
0	149	5745	0.95	3.17	3.01	0.23	6.41	27.25	Pass
	157	5785	1.21	3.43	3.01	0.23	6.67	27.25	Pass
	165	5825	1.06	3.28	3.01	0.23	6.52	27.25	Pass
1	149	5745	0.46	2.68	3.01	0.23	5.92	27.25	Pass
	157	5785	0.61	2.83	3.01	0.23	6.07	27.25	Pass
	165	5825	0.88	3.1	3.01	0.23	6.34	27.25	Pass

Note:

1. Method E) 2) c) of power density measurement of KDB 662911 is using for calculating total power density.
2. Directional gain = 8.75 dBi > 6dBi, so the power density limit shall be reduced to $30-(8.75-6) = 27.25\text{dBm}/500\text{kHz}$.
3. Refer to section 3.3 for duty cycle spectrum plot.

802.11ac (VHT20)

TX Chain	Channel	Frequency (MHz)	PSD		10 log (N=2) dB	Total PSD with Duty Factor (dBm/500 kHz)	Limit (dBm/500 kHz)	Pass / Fail
			(dBm/300 kHz)	(dBm/500 kHz)				
0	149	5745	0.55	2.77	3.01	5.78	27.25	Pass
	157	5785	0.76	2.98	3.01	5.99	27.25	Pass
	165	5825	0.63	2.85	3.01	5.86	27.25	Pass
1	149	5745	-0.3	1.92	3.01	4.93	27.25	Pass
	157	5785	0.23	2.45	3.01	5.46	27.25	Pass
	165	5825	0.13	2.35	3.01	5.36	27.25	Pass

Note:

1. Method E) 2) c) of power density measurement of KDB 662911 is using for calculating total power density.
2. Directional gain = 8.75 dBi > 6dBi, so the power density limit shall be reduced to $30-(8.75-6) = 27.25\text{dBm}/500\text{kHz}$.
3. Refer to section 3.3 for duty cycle spectrum plot.

802.11ac (VHT40)

TX Chain	Channel	Frequency (MHz)	PSD		10 log (N=2) dB	Duty Factor (dB)	Total PSD with Duty Factor (dBm/500 kHz)	Limit (dBm/500 kHz)	Pass / Fail
			(dBm/300 kHz)	(dBm/500 kHz)					
0	151	5755	-1.45	0.77	3.01	0.12	3.9	27.25	Pass
	159	5795	-1.28	0.94	3.01	0.12	4.07	27.25	Pass
1	151	5755	-2.41	-0.19	3.01	0.12	2.94	27.25	Pass
	159	5795	-2.26	-0.04	3.01	0.12	3.09	27.25	Pass

Note:

1. Method E) 2) c) of power density measurement of KDB 662911 is using for calculating total power density.
2. Directional gain = 8.75 dBi > 6dBi, so the power density limit shall be reduced to $30-(8.75-6) = 27.25\text{dBm}/500\text{kHz}$.
3. Refer to section 3.3 for duty cycle spectrum plot.

802.11ac (VHT80)

TX Chain	Channel	Frequency (MHz)	PSD		10 log (N=2) dB	Duty Factor (dB)	Total PSD with Duty Factor (dBm/500 kHz)	Limit (dBm/500 kHz)	Pass / Fail
			(dBm/300 kHz)	(dBm/500 kHz)					
0	155	5775	-7.26	-5.04	3.01	0.32	-1.71	27.25	Pass
1	155	5775	-8.13	-5.91	3.01	0.32	-2.58	27.25	Pass

Note:

1. Method E) 2) c) of power density measurement of KDB 662911 is using for calculating total power density.
2. Directional gain = 8.75 dBi > 6dBi, so the power density limit shall be reduced to $30-(8.75-6) = 27.25\text{dBm}/500\text{kHz}$.
3. Refer to section 3.3 for duty cycle spectrum plot.

Spectrum Plot of Worst Value

802.11a

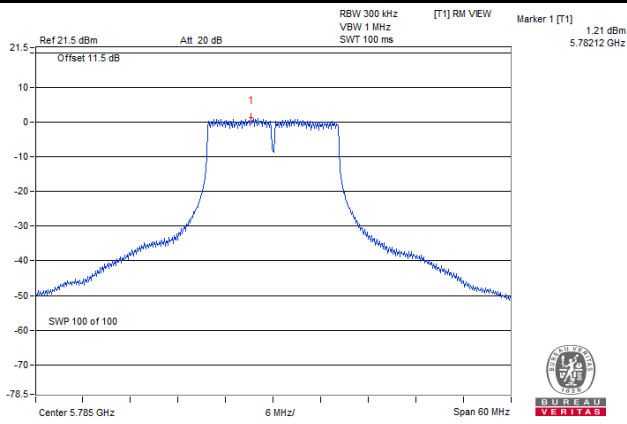

802.11ac (VHT20)

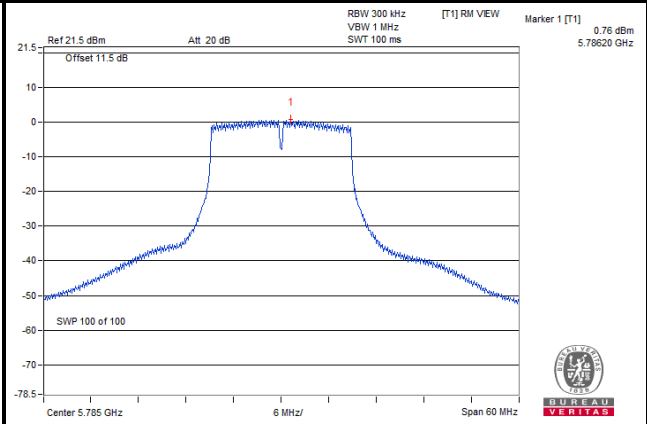

802.11ac (VHT40)

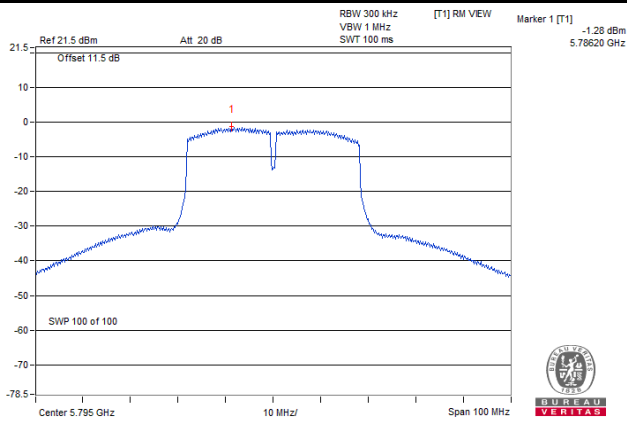

802.11ac (VHT80)

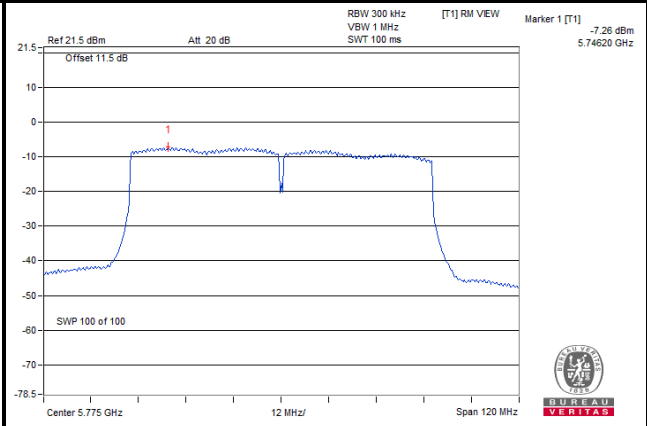

4.6 Frequency Stability

4.6.1 Limit of Frequency Stability Measurement

The frequency of the carrier signal shall be maintained within band of operation.

4.6.2 Test Setup

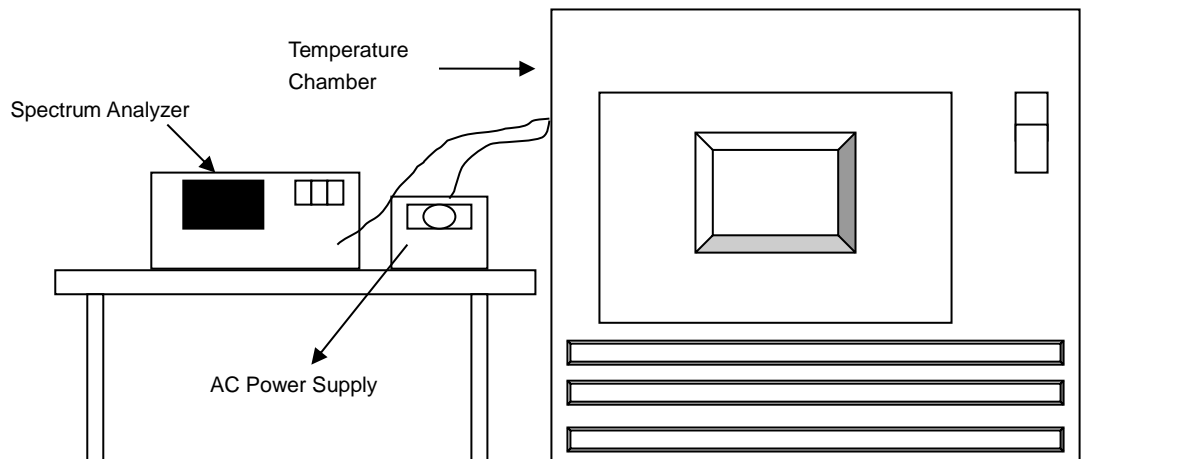

4.6.3 Test Instruments

Refer to section 4.1.3 to get information of above instrument.

4.6.4 Test Procedure

- The EUT was placed inside the environmental test chamber and powered by nominal AC voltage.
- Turn the EUT on and couple its output to a spectrum analyzer.
- Turn the EUT off and set the chamber to the highest temperature specified.
- Allow sufficient time (approximately 30 min) for the temperature of the chamber to stabilize, turn the EUT on and measure the operating frequency after 2, 5, and 10 Minutes.
- Repeat step (d) with the temperature chamber set to the next desired temperature until measurements down to the lowest specified temperature have been completed.
- The test chamber was allowed to stabilize at +20 degree C for a minimum of 30 Minutes. The supply voltage was then adjusted on the EUT from 85% to 115% and the frequency record.

4.6.5 Deviation from Test Standard

No deviation.

4.6.6 EUT Operating Condition

Set the EUT transmit at un-modulation mode to test frequency stability.

4.6.7 Test Results

Frequency Stability Versus Temp.									
Operating Frequency: 5180 MHz									
Temp. (°C)	Power Supply (Vdc)	0 Minute		2 Minute		5 Minute		10 Minute	
		Measured Frequency (MHz)	Result	Measured Frequency (MHz)	Result	Measured Frequency (MHz)	Result	Measured Frequency (MHz)	Result
40	12	5180.0025	PASS	5179.9997	PASS	5180.0021	PASS	5180.0008	PASS
30	12	5180.0168	PASS	5180.0162	PASS	5180.0142	PASS	5180.0153	PASS
20	12	5180.0171	PASS	5180.0124	PASS	5180.0124	PASS	5180.0142	PASS
10	12	5180.0083	PASS	5180.0097	PASS	5180.0078	PASS	5180.009	PASS
0	12	5179.9958	PASS	5179.9918	PASS	5179.9957	PASS	5179.9918	PASS

Frequency Stability Versus Voltage									
Operating Frequency: 5180 MHz									
Temp. (°C)	Power Supply (Vdc)	0 Minute		2 Minute		5 Minute		10 Minute	
		Measured Frequency (MHz)	Result	Measured Frequency (MHz)	Result	Measured Frequency (MHz)	Result	Measured Frequency (MHz)	Result
20	13.8	5180.0179	PASS	5180.0123	PASS	5180.0118	PASS	5180.0143	PASS
	12	5180.0171	PASS	5180.0124	PASS	5180.0124	PASS	5180.0142	PASS
	10.2	5180.0173	PASS	5180.0125	PASS	5180.0131	PASS	5180.0134	PASS

4.7 6 dB Bandwidth Measurement

4.7.1 Limits of 6 dB Bandwidth Measurement

The minimum of 6 dB Bandwidth Measurement is 0.5 MHz.

4.7.2 Test Setup

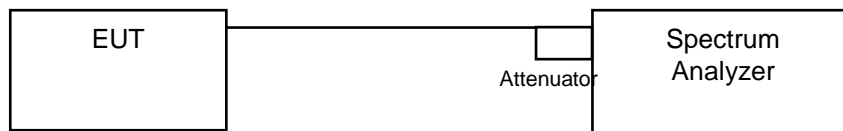

4.7.3 Test Instruments

Refer to section 4.1.3 to get information of above instrument.

4.7.4 Test Procedure

MEASUREMENT PROCEDURE REF

- Set resolution bandwidth (RBW) = 100 kHz
- Set the video bandwidth (VBW) $\geq 3 \times$ RBW, Detector = Peak.
- Trace mode = max hold.
- Sweep = auto couple.
- Measure the maximum width of the emission that is constrained by the frequencies associated with the two amplitude points (upper and lower) that are attenuated by 6 dB relative to the maximum level measured in the fundamental emission

4.7.5 Deviation from Test Standard

No deviation.

4.7.6 EUT Operating Condition

The software provided by client to enable the EUT under transmission condition continuously at lowest, middle and highest channel frequencies individually.

4.7.7 Test Results

802.11a

Channel	Frequency (MHz)	6 dB Bandwidth (MHz)		Minimum Limit (MHz)	Pass / Fail
		Chain 0	Chain 1		
149	5745	16.32	16.37	0.5	Pass
157	5785	16.41	16.37	0.5	Pass
165	5825	16.41	16.40	0.5	Pass

802.11ac (VHT20)

Channel	Frequency (MHz)	6 dB Bandwidth (MHz)		Minimum Limit (MHz)	Pass / Fail
		Chain 0	Chain 1		
149	5745	16.60	17.62	0.5	Pass
157	5785	16.81	17.57	0.5	Pass
165	5825	16.97	17.62	0.5	Pass

802.11ac (VHT40)

Channel	Frequency (MHz)	6 dB Bandwidth (MHz)		Minimum Limit (MHz)	Pass / Fail
		Chain 0	Chain 1		
151	5755	35.25	35.41	0.5	Pass
159	5795	35.19	35.26	0.5	Pass

802.11ac (VHT80)

Channel	Frequency (MHz)	6 dB Bandwidth (MHz)		Minimum Limit (MHz)	Pass / Fail
		Chain 0	Chain 1		
155	5775	75.95	76.44	0.5	Pass

Spectrum Plot of Worst Value

802.11a

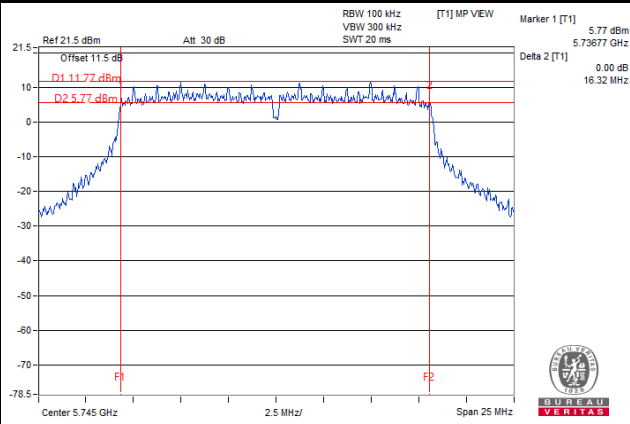

802.11ac (VHT20)

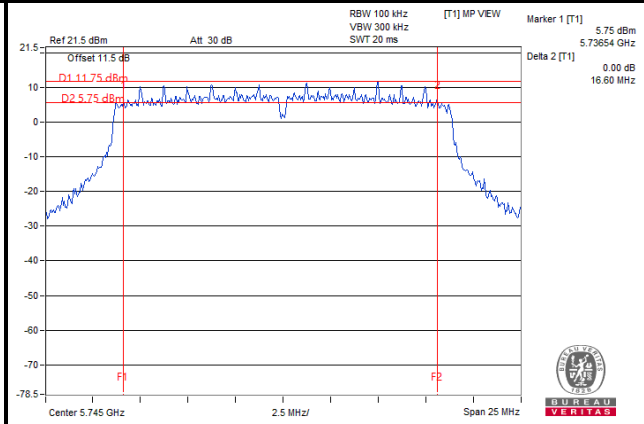

802.11ac (VHT40)

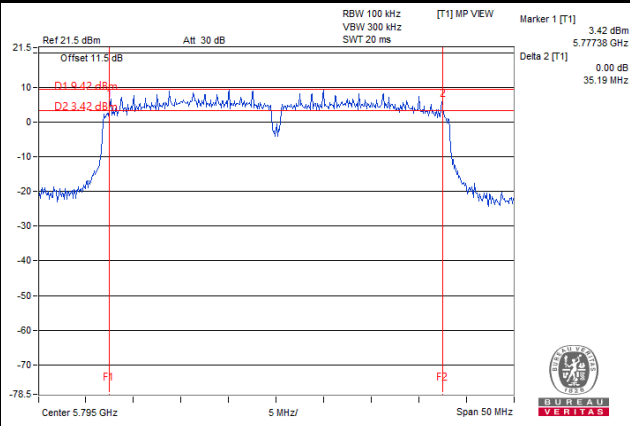

802.11ac (VHT80)

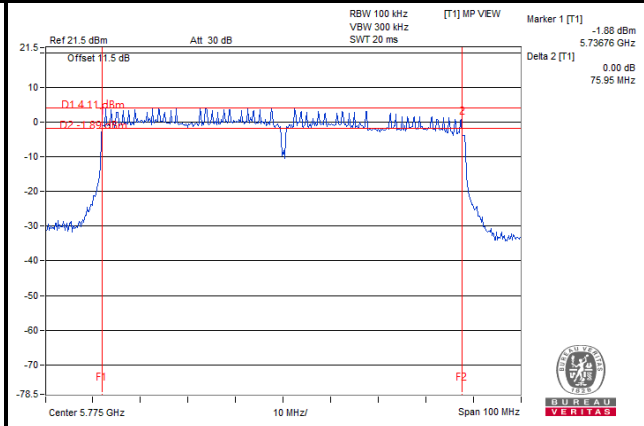

5 Pictures of Test Arrangements

Please refer to the attached file (Test Setup Photo).

Annex A- Radiated Out of Band Emission (OOBE) Measurement (For U-NII-3 band)

802.11a

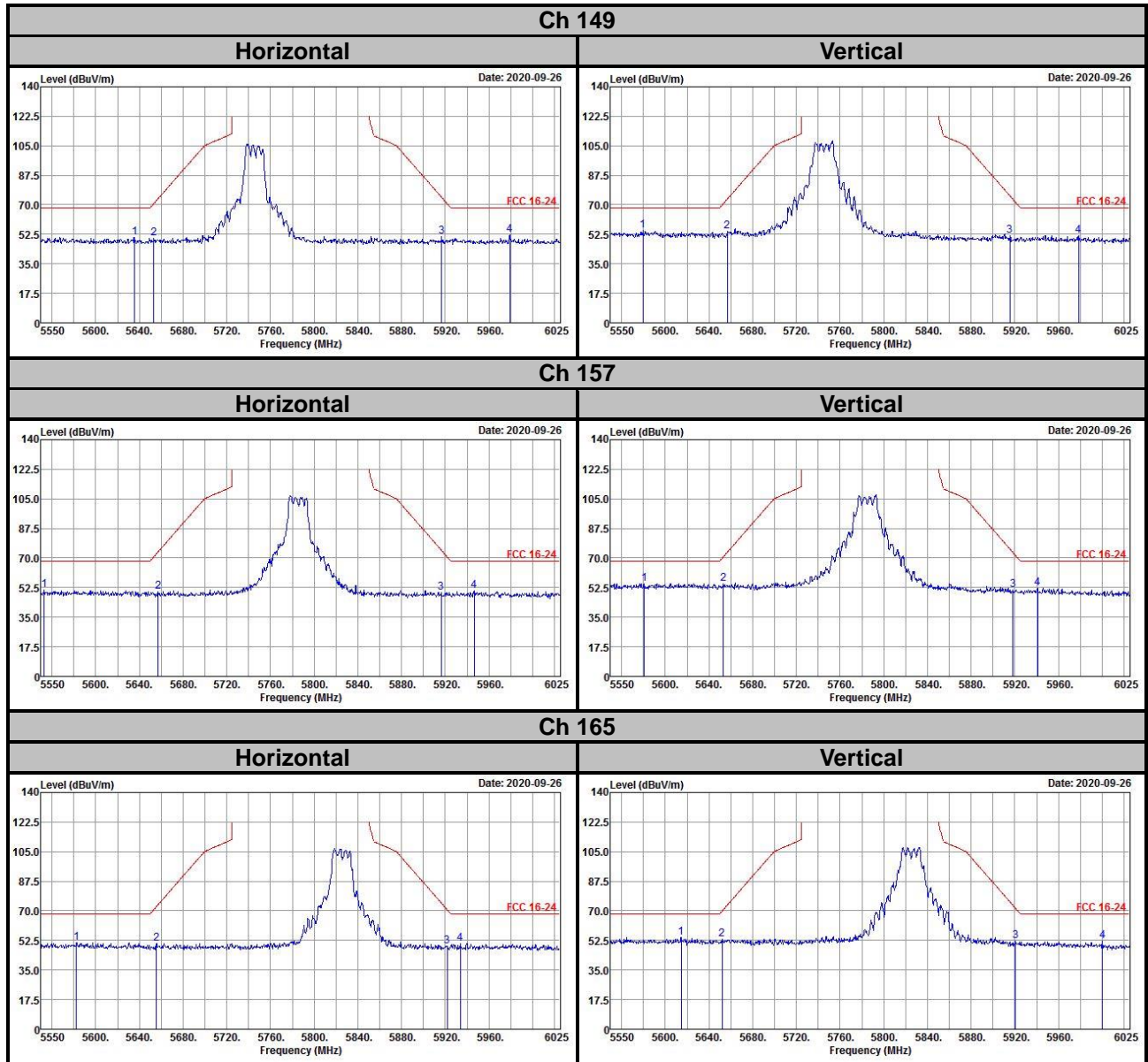

802.11n (HT20)

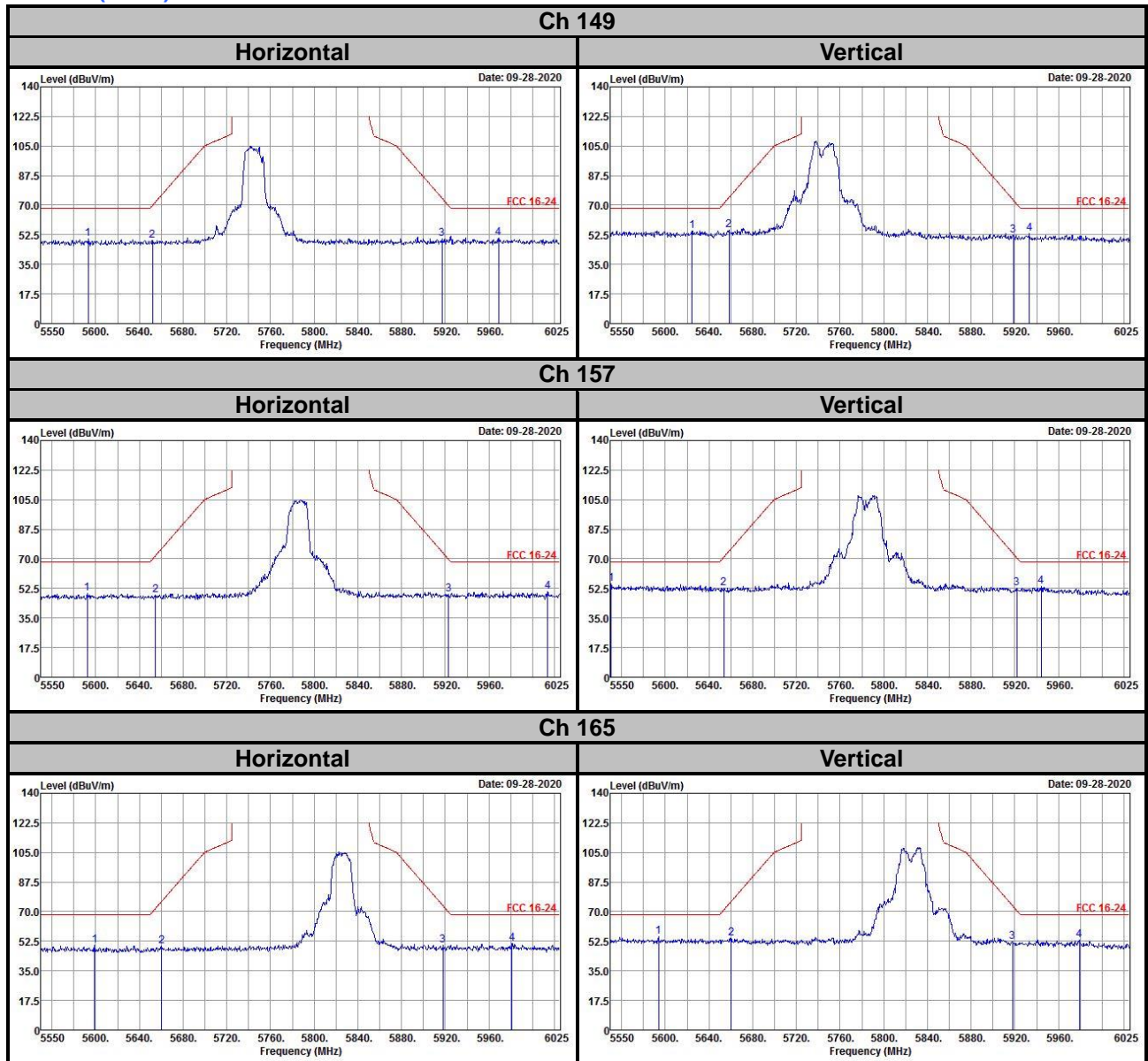

802.11n (HT40)

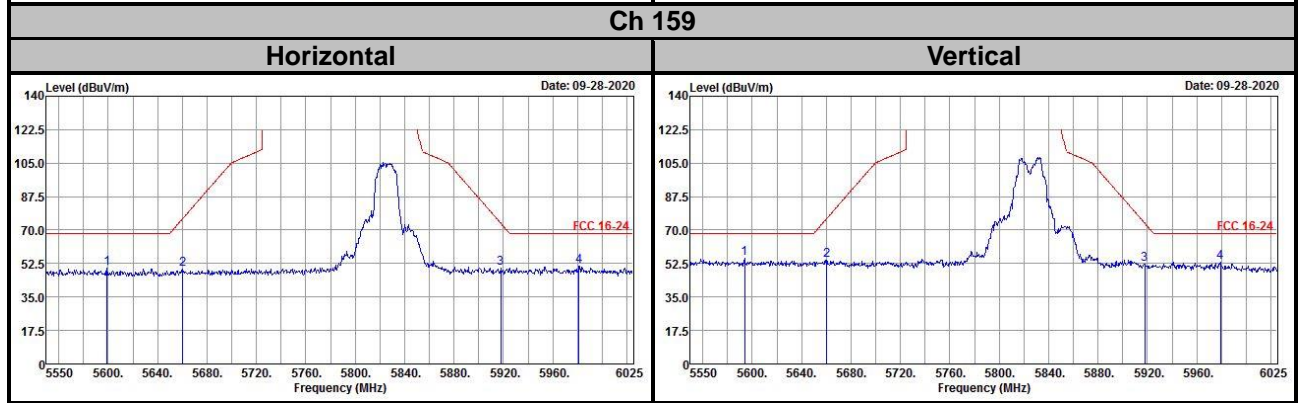
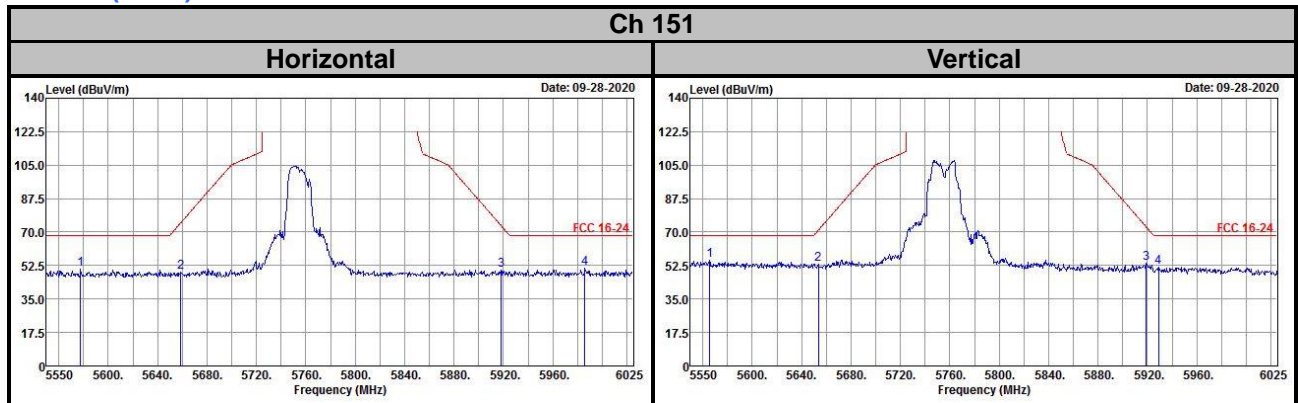

802.11ac (VHT80)

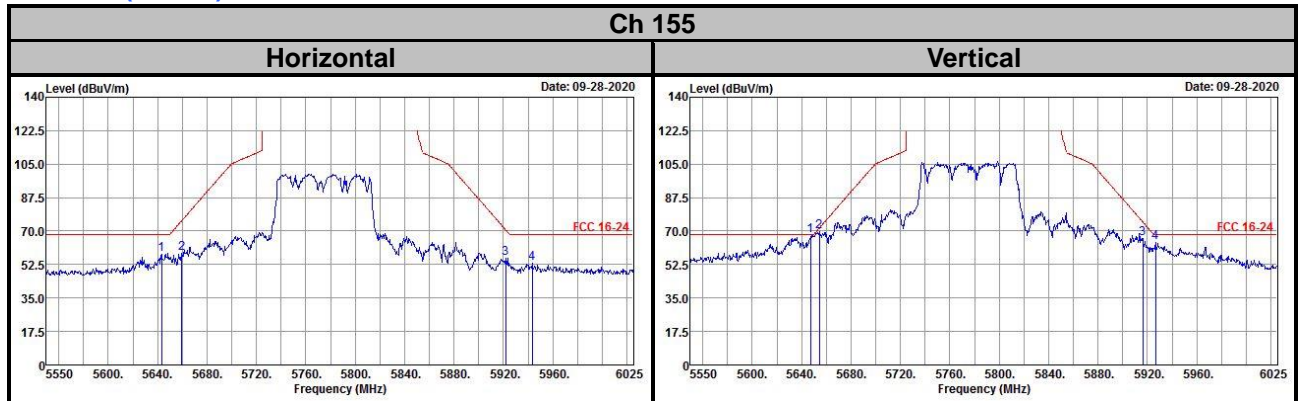

Annex B- Band-edge measurement

802.11a

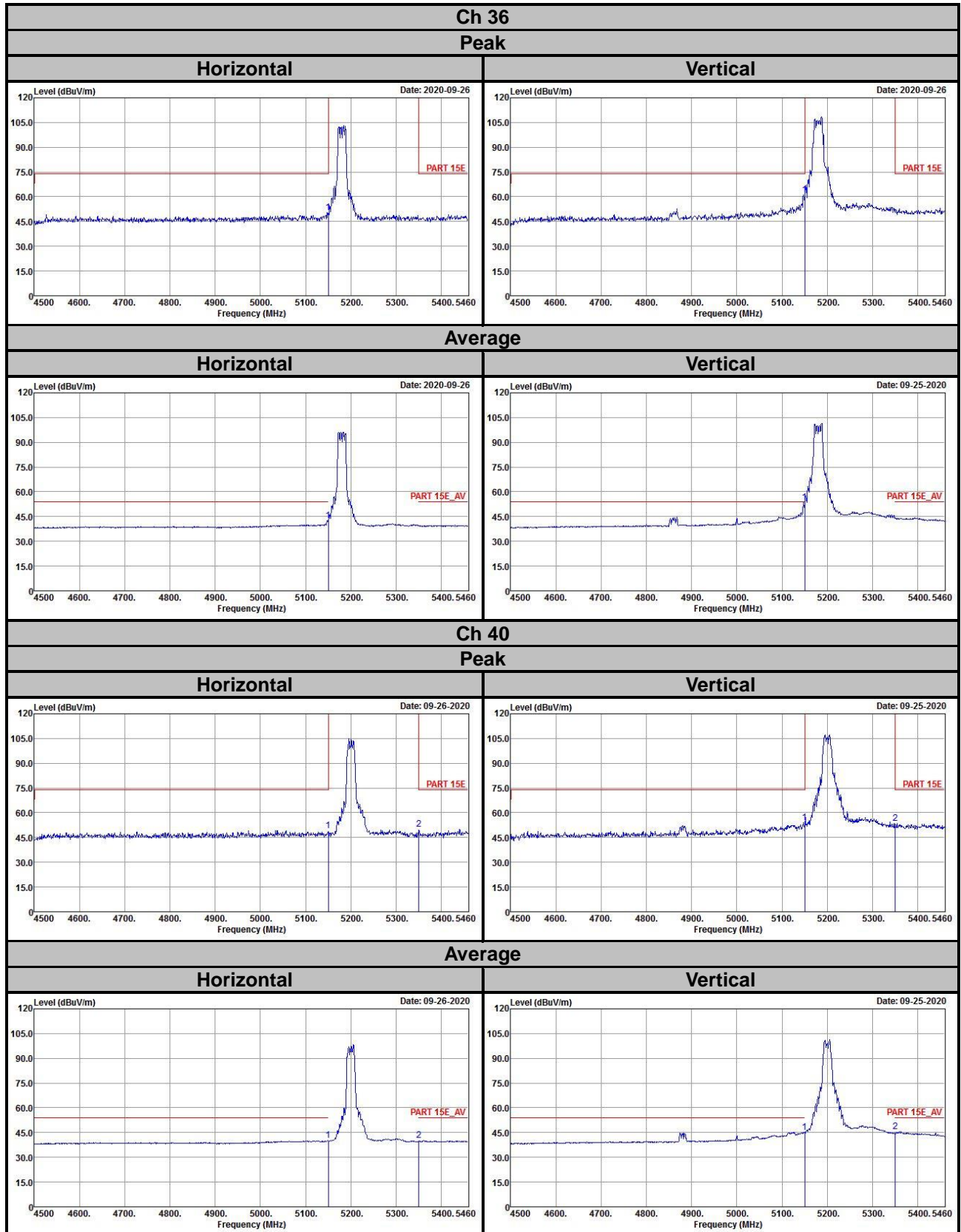

Ch 48

Peak

Horizontal

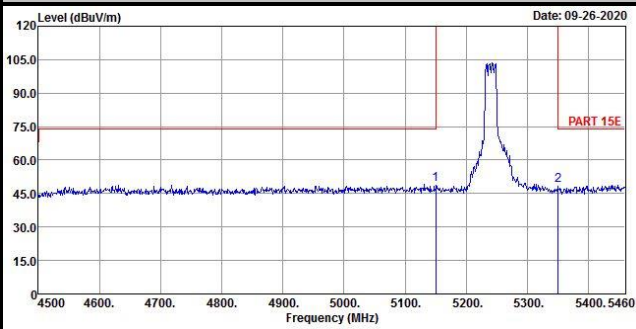

Vertical

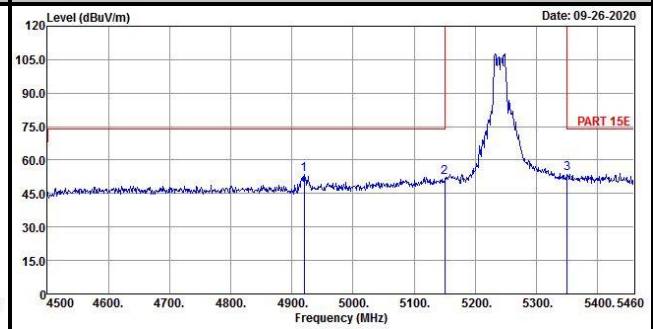

Average

Horizontal

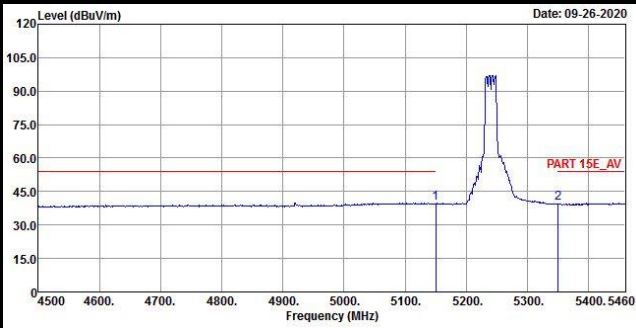

Vertical

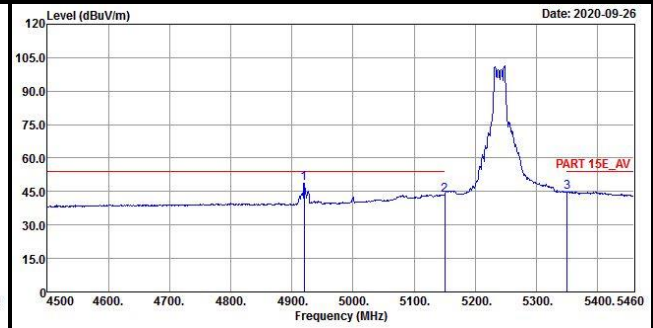

802.11n (HT20)

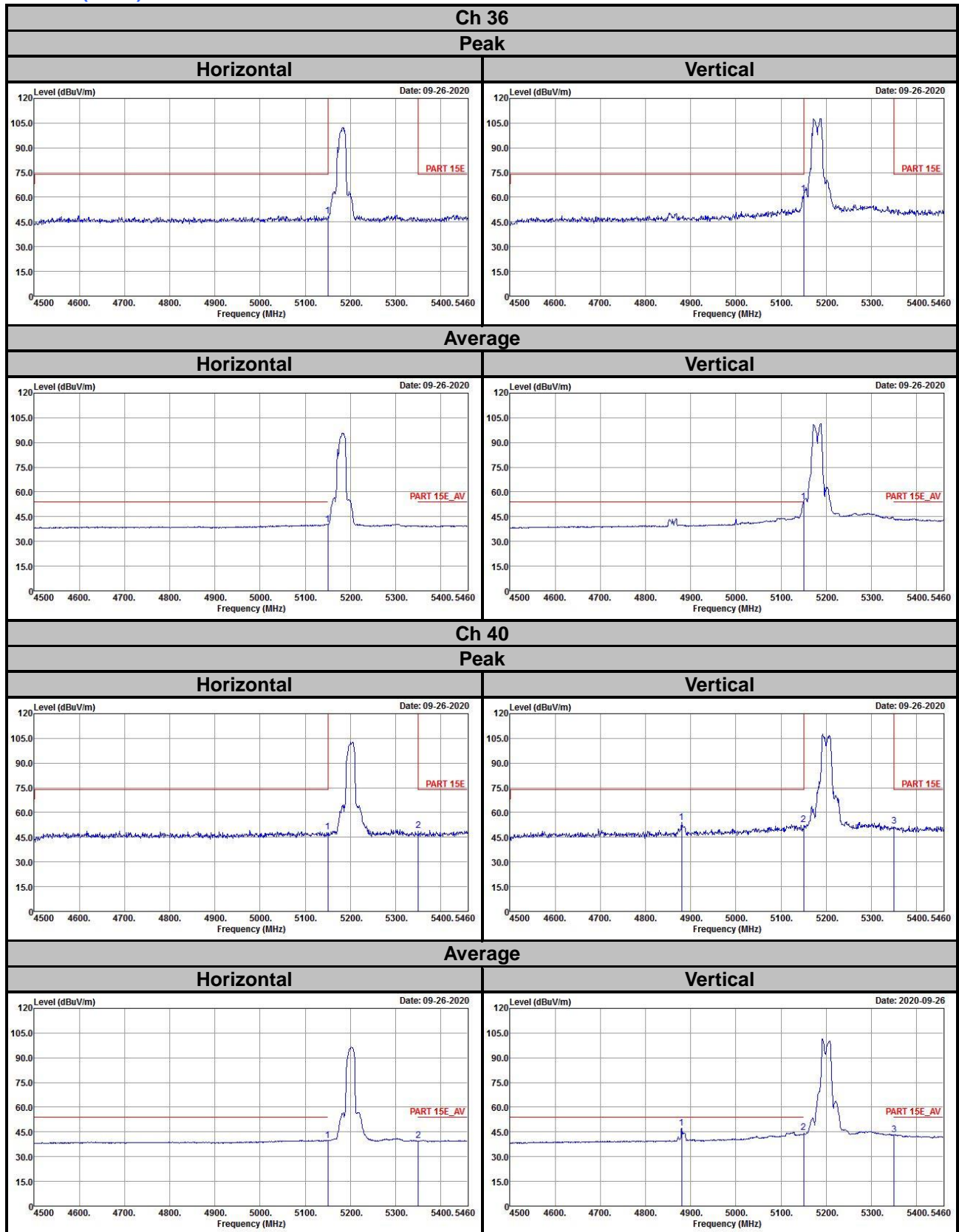

Ch 48

Peak

Horizontal

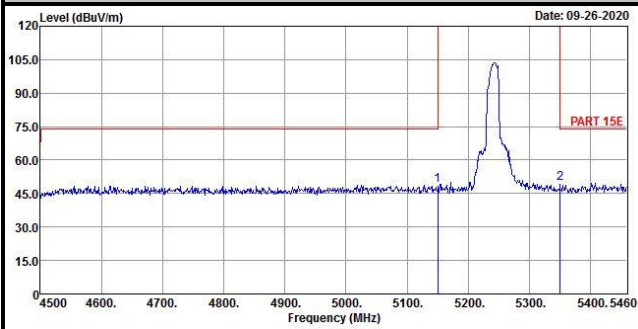

Vertical

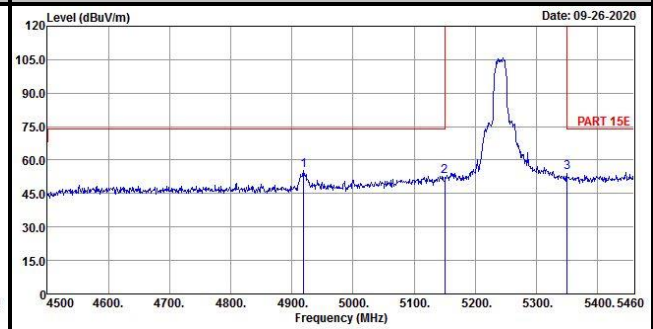

Average

Horizontal

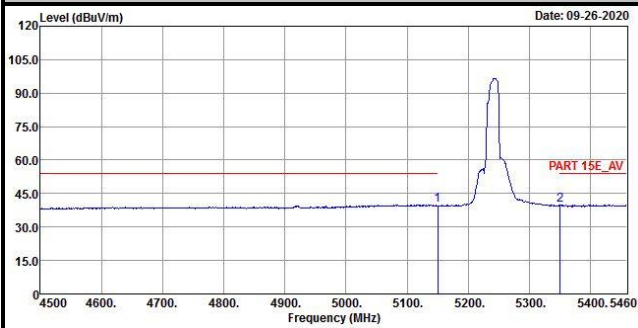

Vertical

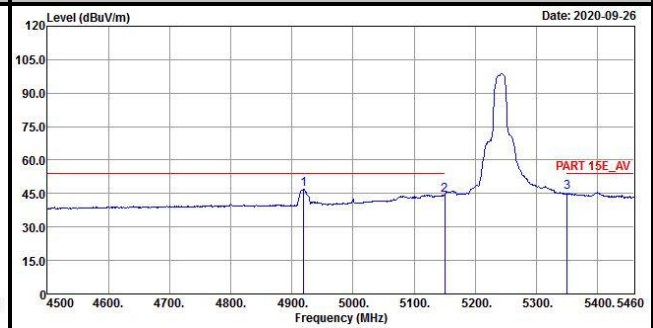

802.11n (HT40)

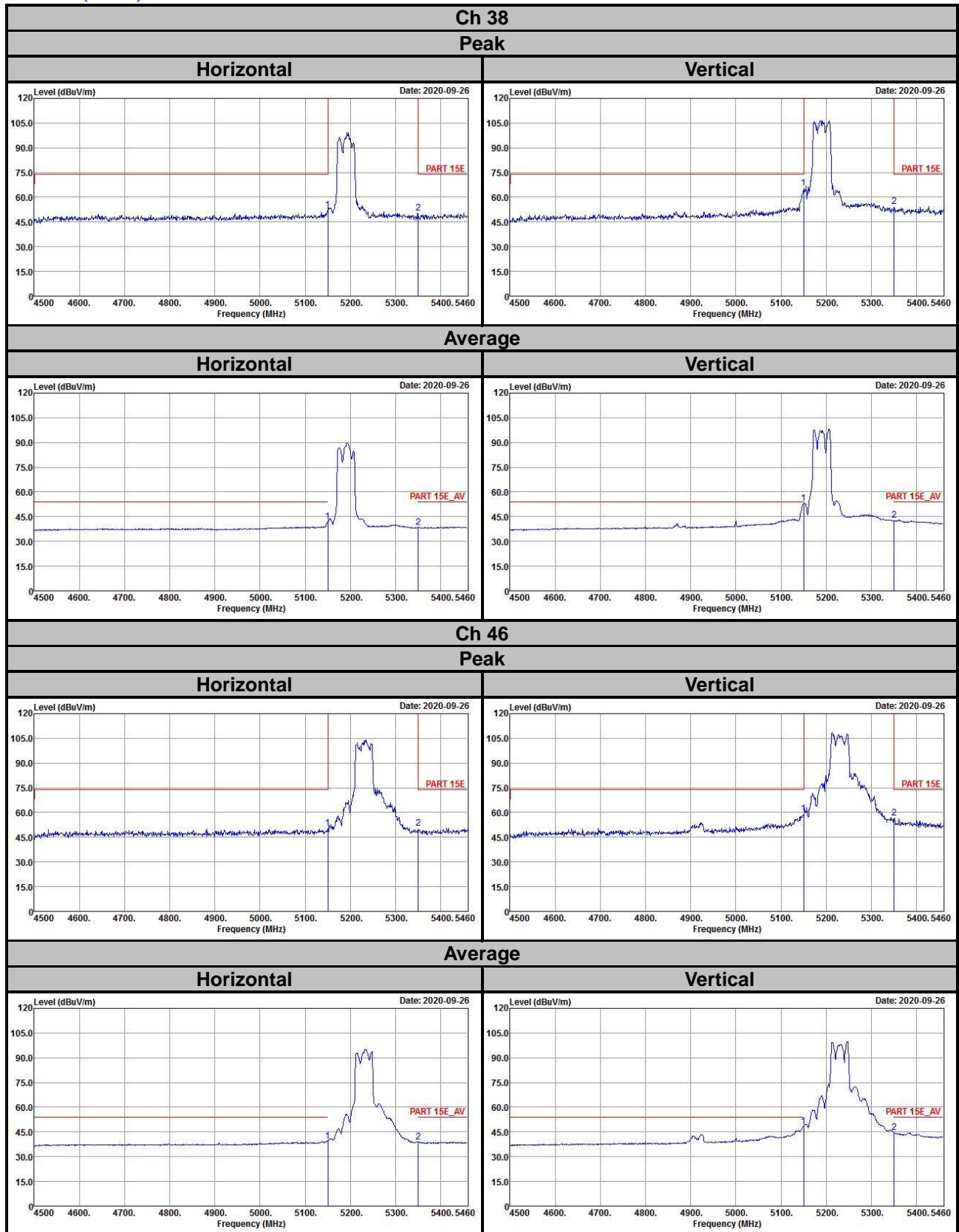

802.11ac (VHT80)

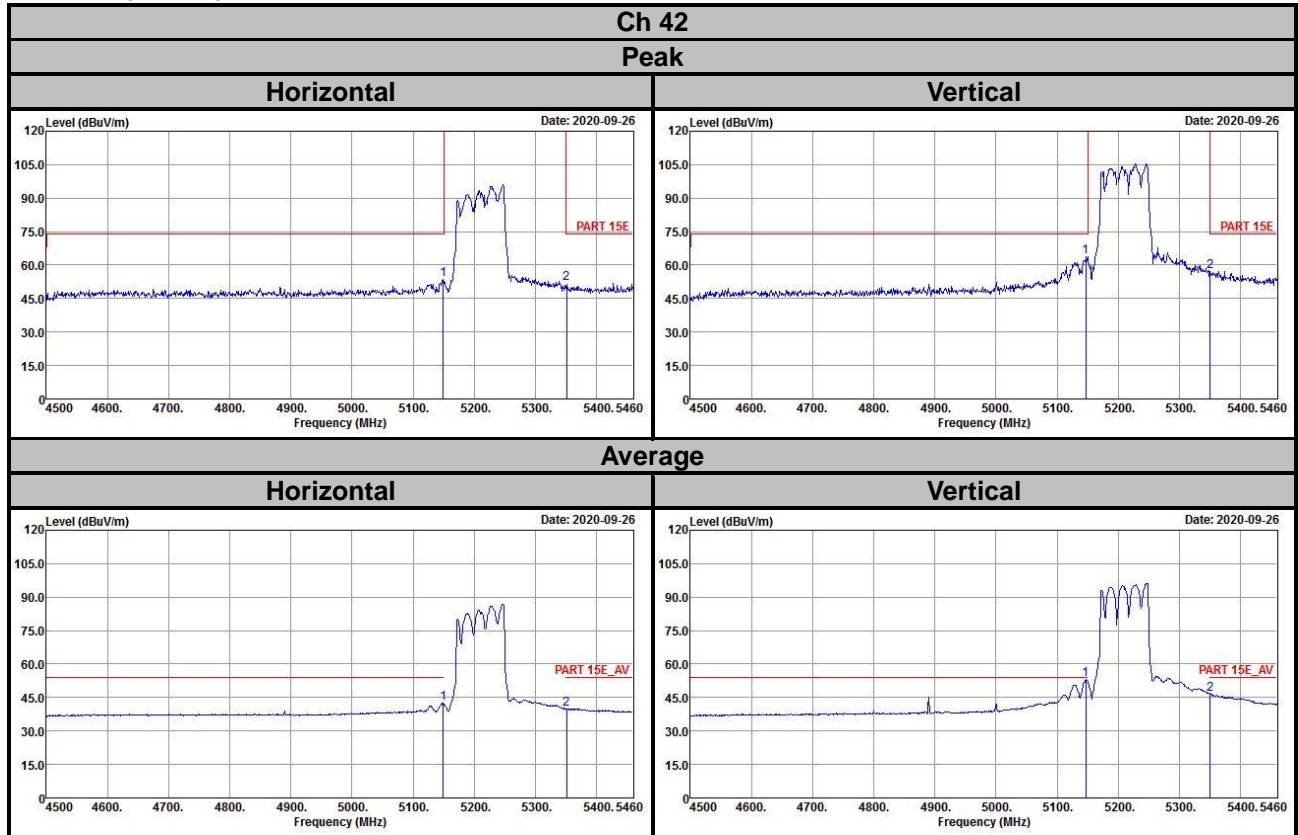

Appendix – Information of the Testing Laboratories

We, Bureau Veritas Consumer Products Services (H.K.) Ltd., Taoyuan Branch, were founded in 1988 to provide our best service in EMC, Radio, Telecom and Safety consultation. Our laboratories are FCC recognized accredited test firms and accredited according to ISO/IEC 17025.

If you have any comments, please feel free to contact us at the following:

Lin Kou EMC/RF Lab

Tel: 886-2-26052180

Fax: 886-2-26051924

Hsin Chu EMC/RF/Telecom Lab

Tel: 886-3-6668565

Fax: 886-3-6668323

Hwa Ya EMC/RF/Safety Lab

Tel: 886-3-3183232

Fax: 886-3-3270892

Email: service.adt@tw.bureauveritas.com

Web Site: www.bureauveritas-adt.com

The address and road map of all our labs can be found in our web site also.

--- END ---