

# FCC Radio Test Report

## FCC ID: KA2IRX5460A1

This report concerns: Original Grant

**Project No.** : 2002H005  
**Equipment** : 1) AX5400 Wi-Fi 6 Router  
2) AX4800 Wi-Fi 6 Router  
**Brand Name** : D-Link  
**Test Model** : DIR-X5460  
**Series Model** : DIR-X4860  
**Applicant** : D-Link Corporation  
**Address** : 17595 Mt. Herrmann, Fountain Valley, California United States 92708  
**Manufacturer** : D-Link Corporation  
**Address** : 17595 Mt. Herrmann, Fountain Valley, California United States 92708  
**Date of Receipt** : Feb. 16, 2020  
**Date of Test** : Feb. 16, 2020~Mar. 28, 2020  
**Issued Date** : Apr. 13, 2020  
**Report Version** : R01  
**Test Sample** : Engineering Sample No. : SH2020021330, SH2020021330-1  
**Standard(s)** : FCC Part15, Subpart E(15.407)  
ANSI C63.10-2013  
FCC KDB 789033 D02 General UNII Test Procedures New Rules v02r01  
FCC KDB 662911 D01 Multiple Transmitter Output v02r01

The above equipment has been tested and found compliance with the requirement of the relative standards by BTL Inc.



Prepared by : Iscaa Min

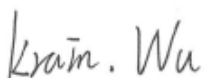

Approved by : Krain Wu



Certificate # 5123.03

Add: No. 29, Jintang Road, Tangzhen Industry Park, Pudong New Area, Shanghai 201210, China

TEL: +86-021-61765666

Web: [www.newbtl.com](http://www.newbtl.com)

**Declaration**

**BTL** represents to the client that testing is done in accordance with standard procedures as applicable and that test instruments used has been calibrated with standards traceable to international standard(s) and/or national standard(s).

**BTL's** reports apply only to the specific samples tested under conditions. It is manufacture's responsibility to ensure that additional production units of this model are manufactured with the identical electrical and mechanical components. **BTL** shall have no liability for any declarations, inferences or generalizations drawn by the client or others from **BTL** issued reports.

The report must not be used by the client to claim product certification, approval, or endorsement by NVLAP, NIST, A2LA, or any agency of the U.S. Government.

This report is the confidential property of the client. As a mutual protection to the clients, the public and ourselves, the test report shall not be reproduced, except in full, without our written approval.

**BTL's** laboratory quality assurance procedures are in compliance with the **ISO/IEC 17025** requirements, and accredited by the conformity assessment authorities listed in this test report.

**BTL** is not responsible for the sampling stage, so the results only apply to the sample as received.

The information, data and test plan are provided by manufacturer which may affect the validity of results, so it is manufacturer's responsibility to ensure that the apparatus meets the essential requirements of applied standards and in all the possible configurations as representative of its intended use.

**Limitation**

For the use of the authority's logo is limited unless the Test Standard(s)/Scope(s)/Item(s) mentioned in this test report is (are) included in the conformity assessment authorities acceptance respective.

<b>Table of Contents</b>	<b>Page</b>
<b>REPORT ISSUED HISTORY</b>	<b>5</b>
<b>1 . SUMMARY OF TEST RESULTS</b>	<b>6</b>
1.1 TEST FACILITY	7
1.2 MEASUREMENT UNCERTAINTY	7
1.3 TEST ENVIRONMENT CONDITIONS	7
<b>2 . GENERAL INFORMATION</b>	<b>8</b>
2.1 GENERAL DESCRIPTION OF EUT	8
2.2 TEST MODES	12
2.3 PARAMETERS OF TEST SOFTWARE	14
2.4 DUTY CYCLE	26
2.5 BLOCK DIAGRAM SHOWING THE CONFIGURATION OF SYSTEM TESTED	27
2.6 SUPPORT UNITS	27
<b>3 . AC POWER LINE CONDUCTED EMISSIONS TEST</b>	<b>28</b>
3.1 LIMIT	28
3.2 TEST PROCEDURE	28
3.3 DEVIATION FROM TEST STANDARD	28
3.4 TEST SETUP	29
3.5 EUT OPERATION CONDITIONS	29
3.6 TEST RESULTS	29
<b>4 . RADIATED EMISSIONS TEST</b>	<b>30</b>
4.1 LIMIT	30
4.2 TEST PROCEDURE	31
4.3 DEVIATION FROM TEST STANDARD	31
4.4 TEST SETUP	32
4.5 EUT OPERATION CONDITIONS	34
4.6 TEST RESULTS – 30 MHz TO 1000 MHz	34
4.7 TEST RESULTS – ABOVE 1000 MHz	34
<b>5 . BANDWIDTH TEST</b>	<b>35</b>
5.1 LIMIT	35
5.2 TEST PROCEDURE	35
5.3 TEST PROCEDURE	35
5.4 TEST SETUP	36
5.5 EUT OPERATION CONDITIONS	36

<b>Table of Contents</b>	<b>Page</b>
5.6 TEST RESULTS	36
<b>6 . MAXIMUM OUTPUT POWER TEST</b>	<b>37</b>
6.1 LIMIT	37
6.2 TEST PROCEDURE	37
6.3 DEVIATION FROM STANDARD	37
6.4 TEST SETUP	37
6.5 EUT OPERATION CONDITIONS	37
6.6 TEST RESULTS	37
<b>7 . POWER SPECTRAL DENSITY TEST</b>	<b>38</b>
7.1 LIMIT	38
7.2 TEST PROCEDURE	38
7.3 DEVIATION FROM STANDARD	38
7.4 TEST SETUP	39
7.5 EUT OPERATION CONDITIONS	39
7.6 TEST RESULTS	39
<b>8 . MEASUREMENT INSTRUMENTS LIST</b>	<b>40</b>
<b>9 . EUT TEST PHOTOS</b>	<b>42</b>
<b>APPENDIX A – AC POWER LINE CONDUCTED EMISSIONS</b>	<b>45</b>
<b>APPENDIX B – RADIATED EMISSION – 30 MHZ TO 1 GHZ</b>	<b>48</b>
<b>APPENDIX C – RADIATED EMISSION – ABOVE 1000 MHZ</b>	<b>51</b>
<b>APPENDIX D – BANDWIDTH</b>	<b>298</b>
<b>APPENDIX E – CONDUCTED OUTPUT POWER</b>	<b>329</b>
<b>APPENDIX F – POWER SPECTRAL DENSITY</b>	<b>438</b>

**REPORT ISSUED HISTORY**

Report Version	Description	Issued Date
R00	Original Issue.	Apr. 02, 2020
R01	Update the type error of Frequency Channel in Appendix F.	Apr. 13, 2020

## 1. SUMMARY OF TEST RESULTS

Test procedures according to the technical standard(s):

FCC Part15, Subpart E(15.407)				
Standard(s) Section	Test Item	Test Result	Judgement	Remark
15.207 15.407(b)	AC Power Line Conducted Emissions	APPENDIX A	PASS	-----
15.407(b) 15.205(a) 15.209(a)	Radiated Emissions	APPENDIX B APPENDIX C APPENDIX D	PASS	-----
15.407(a) 15.407(e)	Spectrum Bandwidth	APPENDIX E	PASS	-----
15.407(a)	Maximum Output Power	APPENDIX F	PASS	-----
15.407(a)	Power Spectral Density	APPENDIX G	PASS	-----
15.407(g)	Frequency Stability	APPENDIX H	PASS	-----
15.203	Antenna Requirements	-----	PASS	-----
15.407(c)	Automatically Discontinue Transmission	-----	PASS	NOTE (2)

Note:

- (1) "N/A" denotes test is not applicable in this test report.
- (2) During no any information transmission, the EUT can automatically discontinue transmission and become standby mode for power saving. the EUT can detect the controlling signal of ACK message transmitting from remote device and verify whether it shall resend or discontinue transmission.
- (3) For UNII-1 this device was functioned as a  
 Access point device     Client device

### 1.1 TEST FACILITY

The test facilities used to collect the test data in this report is at the location of No. 29, Jintang Road, Tangzhen Industry Park, Pudong New Area, Shanghai 201210, China  
 BTL's Test Firm Registration Number for FCC: 476765  
 BTL's Designation Number for FCC: CN1241

### 1.2 MEASUREMENT UNCERTAINTY

ISO/IEC 17025 requires that an estimate of the measurement uncertainties associated with the emissions test results be included in the report. The measurement uncertainties given below are based on a 95% confidence level (based on a coverage factor (k=2))  
 The BTL measurement uncertainty as below table:

#### A. AC power line conducted emissions test:

Test Site	Method	Measurement Frequency Range	U, (dB)
SH-C01	CISPR	150 kHz ~ 30 MHz	± 2.26

#### B. Radiated emissions test:

Test Site	Method	Measurement Frequency Range	Ant. H / V	U, (dB)
SH-CB01	CISPR	9 KHz~30 MHz	V	3.79
		9 KHz~30 MHz	H	3.57
		30 MHz~200 MHz	V	4.04
		30 MHz~200 MHz	H	3.76
		200 MHz~1,000 MHz	V	4.24
		200 MHz~1,000 MHz	H	3.84
		1 GHz~18 GHz	V	4.46
		1 GHz~18 GHz	H	4.40
		18 GHz~40 GHz	V	3.95
		18 GHz~40 GHz	H	3.95

Note: Unless specifically mentioned, the uncertainty of measurement has not been taken into account to declare the compliance or non-compliance to the specification.

### 1.3 TEST ENVIRONMENT CONDITIONS

Test Item	Temperature	Humidity	Test Voltage	Tested By
AC Power Line Conducted Emissions	22°C	53%	AC 120V	Forest Li
Radiated Emissions-9K-30MHz	22°C	55%	AC 120V	Forest Li
Radiated Emissions-30 MHz to 1GHz	22°C	55%	AC 120V	Forest Li
Radiated Emissions-Above 1000 MHz	22°C	55%	AC 120V	Forest Li
Spectrum Bandwidth	20°C	52%	AC 120V	Forest Li
Maximum Output Power	20°C	52%	AC 120V	Forest Li
Power Spectral Density	20°C	52%	AC 120V	Forest Li
Frequency Stability	20°C	52%	AC 120V	Forest Li

## 2. GENERAL INFORMATION

### 2.1 GENERAL DESCRIPTION OF EUT

Equipment	1) AX5400 Wi-Fi 6 Router 2) AX4800 Wi-Fi 6 Router
Brand Name	D-Link
Test Model	DIR-X5460
Series Model	DIR-X4860
Model Difference(s)	Only the model name and the product name are different.
Software Version	1
Hardware Version	A1
Power Source	DC Voltage supplied from AC/DC adapter: Model:S24B72-120A200-0K
Power Rating	I/P: 100-240V ~ 50/60Hz Max. 0.8A O/P: 12V --- 2A
Operation Frequency	UNII-1: 5150 MHz~5250 MHz UNII-2A: 5250 MHz~5350 MHz UNII-2C: 5470 MHz~5725 MHz UNII-3: 5725 MHz~5850 MHz
Modulation Type	OFDM,OFDMA
Bit Rate of Transmitter	Up to 4804Mbps
Maximum Conducted Output Power for UNII-1 (4TX) Non-Beamforming	IEEE 802.11ax (HE20): 24.91 dBm (0.3097 W) IEEE 802.11ax (HE40): 25.46 dBm (0.3516 W) IEEE 802.11ax (HE80): 22.59 dBm (0.1816 W)
Maximum Conducted Output Power for UNII-2A (4TX) Non-Beamforming	IEEE 802.11ax (HE20): 18.94 dBm (0.0783 W) IEEE 802.11ax (HE40): 20.92 dBm (0.1236 W) IEEE 802.11ax (HE80): 20.67 dBm (0.1167 W) IEEE 802.11ax (HE160): 19.98 dBm (0.0995 W)
Maximum Conducted Output Power for UNII-2C (4TX) Non-Beamforming	IEEE 802.11ax (HE20): 17.83 dBm (0.0607 W) IEEE 802.11ax (HE40): 20.91 dBm (0.1233 W) IEEE 802.11ax (HE80): 20.96 dBm (0.1247 W)
Maximum Conducted Output Power for UNII-3 (4TX) Non-Beamforming	IEEE 802.11ax (HE20): 26.95 dBm (0.4955 W) IEEE 802.11ax (HE40): 26.97 dBm (0.4977 W) IEEE 802.11ax (HE80): 26.95 dBm (0.4955 W)
Maximum Conducted Output Power for UNII-1 (4TX) Beamforming	IEEE 802.11ax (HE20): 24.53 dBm (0.2838 W) IEEE 802.11ax (HE40): 25.13 dBm (0.3258 W) IEEE 802.11ax (HE80): 22.24 dBm (0.1675 W)
Maximum Conducted Output Power for UNII-2A (4TX) Beamforming	IEEE 802.11ax (HE20): 18.65 dBm (0.0733 W) IEEE 802.11ax (HE40): 20.58 dBm (0.1143 W) IEEE 802.11ax (HE80): 20.33 dBm (0.1079 W) IEEE 802.11ax (HE160): 19.68 dBm (0.0929 W)
Maximum Conducted Output Power for UNII-2C (4TX) Beamforming	IEEE 802.11ax (HE20): 17.47 dBm (0.0558 W) IEEE 802.11ax (HE40): 20.57 dBm (0.1140 W) IEEE 802.11ax (HE80): 20.73 dBm (0.1183 W)
Maximum Conducted Output Power for UNII-3 (4TX) Beamforming	IEEE 802.11ax (HE20): 26.59 dBm (0.4560 W) IEEE 802.11ax (HE40): 26.72 dBm (0.4699 W) IEEE 802.11ax (HE80): 26.69dBm (0.4667 W)

Note:

- For a more detailed features description, please refer to the manufacturer's specifications or the user's manual.



## 2. Channel List:

IEEE 802.11ax (HE20)		IEEE 802.11ax (HE40)		IEEE 802.11ax (HE80)		IEEE 802.11ax (HE160)	
UNII-1		UNII-1		UNII-1		UNII-1	
Channel	Frequency (MHz)	Channel	Frequency (MHz)	Channel	Frequency (MHz)	Channel	Frequency (MHz)
36	5180	38	5190	42	5210	50	5250
40	5200	46	5230				
44	5220						
48	5240						

IEEE 802.11ax (HE20)		IEEE 802.11ax (HE40)		IEEE 802.11ax (HE80)		IEEE 802.11ax (HE160)	
UNII-2A		UNII-2A		UNII-2A		UNII-1	
Channel	Frequency (MHz)	Channel	Frequency (MHz)	Channel	Frequency (MHz)	Channel	Frequency (MHz)
52	5260	54	5270	58	5290	50	5250
56	5280	62	5310				
60	5300						
64	5320						

IEEE 802.11ax (HE20)		IEEE 802.11ax (HE40)		IEEE 802.11ax (HE80)	
UNII-2C		UNII-2C		UNII-2C	
Channel	Frequency (MHz)	Channel	Frequency (MHz)	Channel	Frequency (MHz)
100	5500	102	5510	106	5530
104	5520	110	5550	122	5610
108	5540	118	5590		
112	5560	126	5630		
116	5580	134	5670		
120	5600				
124	5620				
128	5640				
132	5660				
136	5680				
140	5700				

IEEE 802.11ax (HE20)		IEEE 802.11ax (HE40)		IEEE 802.11ax (HE80)	
UNII-3		UNII-3		UNII-3	
Channel	Frequency (MHz)	Channel	Frequency (MHz)	Channel	Frequency (MHz)
149	5745	151	5755	155	5775
153	5765	159	5795		
157	5785				
161	5805				
165	5825				

## 3. RU configuration

Operating Mode	Resource Unit	52 Tone(4M)
IEEE 802.11ax (HE20)	Specific Resource Unit	37
		38
		39
		40
	Resource Unit	106 Tone(8M)
	Specific Resource Unit	53
		54
	Resource Unit	242 Tone(20M)
Specific Resource Unit	61	
Operating Mode	Resource Unit	106 Tone(8M)
IEEE 802.11ax (HE40)	Specific Resource Unit	53
		54
		55
		56
	Resource Unit	242 Tone(20M)
	Specific Resource Unit	61
		62
	Resource Unit	484 Tone(40M)
Specific Resource Unit	65	
Operating Mode	Resource Unit	242 Tone(20M)
IEEE 802.11ax (HE80)	Specific Resource Unit	61
		62
		63
		64
	Resource Unit	484 Tone(40M)
	Specific Resource Unit	65
		66
	Resource Unit	996 Tone(80M)
Specific Resource Unit	67	
Operating Mode	Resource Unit	242 Tone(20M)
IEEE 802.11ax (HE160)	Specific Resource Unit	61
		64
		S64
	Resource Unit	484 Tone(40M)
	Specific Resource Unit	65
		66
		S66
	Resource Unit	996 Tone(80M)
	Specific Resource Unit	67
		S67
Resource Unit	996*2 Tone(80+80M)	
Specific Resource Unit	S68	

## 4. Antenna Specification:

Ant.	Brand	Model Name	Antenna Type	Connector	Gain (dBi)	Note
1	N/A	N/A	Dipole	IPEX	3	N/A
2	N/A	N/A	Dipole	IPEX	3	N/A
3	N/A	N/A	Dipole	IPEX	3	N/A
4	N/A	N/A	Dipole	IPEX	3	N/A

## Note:

- (1) Antenna Gain=3 dBi. This EUT supports MIMO 4X4, any transmit signals are correlated with each other, so Directional gain =  $G_{Ant.} + 10\log(N)$  dBi, that is Directional gain =  $3 + 10\log(4)$  dBi = 9.02; So, the UNII-1, UNII-3 output power limit is  $30 - 9.02 + 6 = 26.98$ , the UNII-2A, UNII-2C output power limit is  $24 - 9.02 + 6 = 20.98$ . The UNII-1 power spectral density limit is  $17 - 9.02 + 6 = 13.98$ , UNII-2A, UNII-2C power spectral density limit is  $11 - 9.02 + 6 = 7.98$ , the UNII-3 power spectral density limit is  $30 - 9.02 + 6 = 26.98$ .

## 5. Table for Antenna Configuration:

Operating Mode	TX Mode	Ant. 1+2+3+4
IEEE 802.11ax (HE20)		✓
IEEE 802.11ax (HE40)		✓
IEEE 802.11ax (HE80)		✓

## 2.2 TEST MODES

The test system was pre-tested based on the consideration of all possible combinations of EUT operation mode.

Pretest Mode	Description
Mode 1	TX AX (HE20) Mode / CH36, CH40, CH48 (UNII-1)
Mode 2	TX AX (HE40) Mode / CH38, CH46 (UNII-1)
Mode 3	TX AX (HE80) Mode / CH42 (UNII-1)
Mode 4	TX AX (HE20) Mode / CH52, CH60, CH64 (UNII-2A)
Mode 5	TX AX (HE40) Mode / CH54, CH62 (UNII-2A)
Mode 6	TX AX (HE80) Mode / CH58 (UNII-2A)
Mode 7	TX AX (HE160) Mode / CH50 (UNII-2A)
Mode 8	TX AX (HE20) Mode / CH100, CH116, CH140 (UNII-2C)
Mode 9	TX AX (HE40) Mode / CH102, CH110, CH134 (UNII-2C)
Mode 10	TX AX (HE80) Mode / CH106, CH122 (UNII-2C)
Mode 11	TX AX (HE20) Mode / CH149,CH157,CH165 (UNII-3)
Mode 12	TX AX (HE40) Mode / CH151,CH159 (UNII-3)
Mode 13	TX AX (HE80) Mode / CH155 (UNII-3)
Mode 14	TX AX (HE40) Mode / CH159 (UNII-3)

Following mode(s) as (were) found to be the worst case(s) and selected for the final test.

AC power line conducted emissions test	
Final Test Mode	Description
Mode 14	TX AX (HE40) Mode / CH159 (UNII-3)

Radiated emissions test	
Final Test Mode	Description
Mode 1	TX AX (HE20) Mode / CH36, CH40, CH48 (UNII-1)
Mode 2	TX AX (HE40) Mode / CH38, CH46 (UNII-1)
Mode 3	TX AX (HE80) Mode / CH42 (UNII-1)
Mode 4	TX AX (HE20) Mode / CH52, CH60, CH64 (UNII-2A)
Mode 5	TX AX (HE40) Mode / CH54, CH62 (UNII-2A)
Mode 6	TX AX (HE80) Mode / CH58 (UNII-2A)
Mode 7	TX AX (HE160) Mode / CH50 (UNII-2A)
Mode 8	TX AX (HE20) Mode / CH100, CH116, CH140 (UNII-2C)
Mode9	TX AX (HE40) Mode / CH102, CH110, CH134 (UNII-2C)
Mode 10	TX AX (HE80) Mode / CH106, CH122 (UNII-2C)
Mode 11	TX AX (HE20) Mode / CH149,CH157,CH165 (UNII-3)
Mode 12	TX AX (HE40) Mode / CH151,CH159 (UNII-3)
Mode 13	TX AX (HE80) Mode / CH155 (UNII-3)

**Note:**

- (1) For radiated emission below 1 GHz test, the IEEE 802.11AX 40 is found to be the worst case and recorded.
- (2) For radiated emission above 1 GHz test, 1GHz~26.5GHz and 26.5GHz~40GHz have been pre-tested and in this report only recorded the worst case. The remaining spurious points are all below the limit value of 20dB.
- (3) The measurements for RF Output Power were tested during Non-Beamforming and Beamforming, the worst case was Non-Beamforming, only worst case was documented for other test items.
- (4) The low frequency, which started from 9 kHz to 30MHz, was pre-scanned and the result which was 20dB lower than the limit line was not reported.

**2.3 PARAMETERS OF TEST SOFTWARE**
**Non-Beamforming**

4TX				
Test Software	accessMTool			
Operating Mode	Test Frequency (MHz)	Resource Unit	Specific Resource Unit	Parameters of Test Software
IEEE 802.11ax (HE20)	5180	52 Tone	37	54
			38	51
			40	53
		106 Tone	53	60
			54	59
			61	73
	5200	52 Tone	37	52
			38	51
			40	52
		106 Tone	53	60
			54	60
			61	77
	5240	52 Tone	37	53
			38	51
			40	52
		106 Tone	53	60
			54	60
			61	76
	5260	52 Tone	37	23
			38	21
			40	22
		106 Tone	53	32
			54	32
			61	51
5300	52 Tone	37	22	
		38	20	
		40	21	
	106 Tone	53	30	
		54	30	
		61	48	

Operating Mode	Test Frequency (MHz)	Resource Unit	Specific Resource Unit	Parameters of Test Software
IEEE 802.11ax (HE20)	5320	52 Tone	37	22
			38	20
			40	22
		106 Tone	53	30
			54	30
			61	49
	5500	52 Tone	37	22
			38	22
			40	22
		106 Tone	53	31
			54	31
			61	51
	5580	52 Tone	37	22
			38	22
			40	23
		106 Tone	53	32
			54	32
			61	51
	5700	52 Tone	37	20
			38	19
			40	20
		106 Tone	53	30
			54	30
			61	48
5745	52 Tone	37	82	
		38	82	
		40	82	
	106 Tone	53	82	
		54	82	
		61	84	
5785	52 Tone	37	81	
		38	81	
		40	81	
	106 Tone	53	81	
		54	81	
		61	83	

Operating Mode	Test Frequency (MHz)	Resource Unit	Specific Resource Unit	Parameters of Test Software	
IEEE 802.11ax (HE20)	5825	52 Tone	37	81	
			38	81	
			40	81	
		106 Tone	53	79	
			54	79	
			61	82	
IEEE 802.11ax (HE40)	5190	52 Tone	37	54	
			40	51	
			44	54	
		106 Tone	53	66	
			54	60	
			56	62	
		242 Tone	61	73	
			62	73	
			65	68	
		5230	52 Tone	37	54
				40	51
				44	54
	106 Tone		53	67	
			54	62	
			56	62	
	242 Tone		61	76	
			62	74	
			65	70	
	5270		52 Tone	37	26
				40	22
				44	24
		106 Tone	53	39	
			54	33	
			56	34	
242 Tone		61	50		
		62	48		
		65	54		



Operating Mode	Test Frequency (MHz)	Resource Unit	Specific Resource Unit	Parameters of Test Software	
IEEE 802.11ax (HE40)	5310	52 Tone	37	23	
			40	21	
			44	24	
		106 Tone	53	38	
			54	33	
			56	34	
			242 Tone	61	48
				62	48
			484 Tone	65	54
		5510	52 Tone	37	25
				40	22
				44	25
	106 Tone		53	40	
			54	34	
			56	36	
	242 Tone		61	51	
			62	48	
	484 Tone		65	54	
	5550		52 Tone	37	25
				40	22
				44	26
		106 Tone	53	39	
			54	33	
			56	36	
		242 Tone	61	51	
			62	49	
		484 Tone	65	54	
		5670	52 Tone	37	24
				40	22
				44	26
	106 Tone		53	37	
			54	34	
			56	36	
	242 Tone		61	48	
			62	47	
	484 Tone		65	61	

Operating Mode	Test Frequency (MHz)	Resource Unit	Specific Resource Unit	Parameters of Test Software
IEEE 802.11ax (HE40)	5755	52 Tone	37	82
			40	81
			44	82
		106 Tone	53	82
			54	81
			56	82
		242 Tone	61	81
	62		82	
	484 Tone	65	84	
	5795	52 Tone	37	82
			40	81
			44	82
		106 Tone	53	82
			54	80
56			81	
242 Tone		61	80	
	62	80		
484 Tone	65	83		
IEEE 802.11ax (HE80)	5210	106 Tone	53	67
			56	64
			60	67
		242 Tone	61	66
			63	66
			64	66
		484 Tone	65	63
	66		63	
	996 Tone	67	64	
	5290	106 Tone	53	41
			56	36
			60	40
		242 Tone	61	56
			63	52
64			54	
484 Tone		65	58	
	66	58		
996 Tone	67	56		

Operating Mode	Test Frequency (MHz)	Resource Unit	Specific Resource Unit	Parameters of Test Software	
IEEE 802.11ax (HE80)	5530	106 Tone	53	43	
			56	38	
			60	43	
		242 Tone	61	58	
			63	54	
			64	57	
		484 Tone	65	65	
			66	65	
		996 Tone	67	64	
		5610	106 Tone	53	43
				56	38
				60	43
	242 Tone		61	56	
			63	53	
			64	57	
	484 Tone		65	65	
			66	65	
	996 Tone		67	65	
	5775		106 Tone	53	82
				56	82
				60	82
		242 Tone	61	82	
			63	82	
			64	82	
484 Tone		65	82		
		66	82		
996 Tone		67	88		
IEEE 802.11ax (HE160)		5250	242 Tone(20M)	61	22
				64	22
				S64	22
	484 Tone(40M)		65	24	
			66	22	
	996 Tone(80M)		S66	24	
			67	24	
	996*2 Tone(80+80M)		S67	24	
				S68	24

**Beamforming**

4TX				
Test Software	accessMTool			
Operating Mode	Test Frequency (MHz)	Resource Unit	Specific Resource Unit	Parameters of Test Software
IEEE 802.11ax (HE20)	5180	52 Tone	37	54
			38	51
			40	53
		106 Tone	53	60
			54	59
			61	73
	5200	52 Tone	37	52
			38	51
			40	52
		106 Tone	53	60
			54	60
			61	77
	5240	52 Tone	37	53
			38	51
			40	52
		106 Tone	53	60
			54	60
			61	76
	5260	52 Tone	37	23
			38	21
			40	22
		106 Tone	53	32
			54	32
			61	51
5300	52 Tone	37	22	
		38	20	
		40	21	
	106 Tone	53	30	
		54	30	
		61	48	

Operating Mode	Test Frequency (MHz)	Resource Unit	Specific Resource Unit	Parameters of Test Software
IEEE 802.11ax (HE20)	5320	52 Tone	37	22
			38	20
			40	22
		106 Tone	53	30
			54	30
			61	49
	5500	52 Tone	37	22
			38	22
			40	22
		106 Tone	53	31
			54	31
			61	51
	5580	52 Tone	37	22
			38	22
			40	23
		106 Tone	53	32
			54	32
			61	51
	5700	52 Tone	37	20
			38	19
			40	20
		106 Tone	53	30
			54	30
			61	48
5745	52 Tone	37	82	
		38	82	
		40	82	
	106 Tone	53	82	
		54	82	
		61	84	
5785	52 Tone	37	81	
		38	81	
		40	81	
	106 Tone	53	81	
		54	81	
		61	83	

Operating Mode	Test Frequency (MHz)	Resource Unit	Specific Resource Unit	Parameters of Test Software	
IEEE 802.11ax (HE20)	5825	52 Tone	37	81	
			38	81	
			40	81	
		106 Tone	53	79	
			54	79	
		242 Tone	61	82	
IEEE 802.11ax (HE40)	5190	52 Tone	37	54	
			40	51	
			44	54	
		106 Tone	53	66	
			54	60	
			56	62	
		242 Tone	61	73	
			62	73	
			65	68	
		5230	52 Tone	37	54
				40	51
				44	54
	106 Tone		53	67	
			54	62	
			56	62	
	242 Tone		61	76	
			62	74	
			65	70	
	5270		52 Tone	37	26
				40	22
				44	24
		106 Tone	53	39	
			54	33	
			56	34	
242 Tone		61	50		
		62	48		
		65	54		

Operating Mode	Test Frequency (MHz)	Resource Unit	Specific Resource Unit	Parameters of Test Software	
IEEE 802.11ax (HE40)	5310	52 Tone	37	23	
			40	21	
			44	24	
		106 Tone	53	38	
			54	33	
			56	34	
			242 Tone	61	48
				62	48
			484 Tone	65	54
		5510	52 Tone	37	25
				40	22
				44	25
	106 Tone		53	40	
			54	34	
			56	36	
	242 Tone		61	51	
			62	48	
	484 Tone		65	54	
	5550		52 Tone	37	25
				40	22
				44	26
		106 Tone	53	39	
			54	33	
			56	36	
		242 Tone	61	51	
			62	49	
		484 Tone	65	54	
		5670	52 Tone	37	24
				40	22
				44	26
	106 Tone		53	37	
			54	34	
			56	36	
	242 Tone		61	48	
			62	47	
	484 Tone		65	61	

Operating Mode	Test Frequency (MHz)	Resource Unit	Specific Resource Unit	Parameters of Test Software
IEEE 802.11ax (HE40)	5755	52 Tone	37	82
			40	81
			44	82
		106 Tone	53	82
			54	81
			56	82
		242 Tone	61	81
	62		82	
	484 Tone	65	84	
	5795	52 Tone	37	82
			40	81
			44	82
		106 Tone	53	82
			54	80
56			81	
242 Tone		61	80	
	62	80		
484 Tone	65	83		
IEEE 802.11ax (HE80)	5210	106 Tone	53	67
			56	64
			60	67
		242 Tone	61	66
			63	66
			64	66
		484 Tone	65	63
	66		63	
	996 Tone	67	64	
	5290	106 Tone	53	41
			56	36
			60	40
		242 Tone	61	56
			63	52
64			54	
484 Tone		65	58	
	66	58		
996 Tone	67	56		



Operating Mode	Test Frequency (MHz)	Resource Unit	Specific Resource Unit	Parameters of Test Software	
IEEE 802.11ax (HE80)	5530	106 Tone	53	43	
			56	38	
			60	43	
		242 Tone	61	58	
			63	54	
			64	57	
		484 Tone	65	65	
			66	65	
		996 Tone	67	64	
		5610	106 Tone	53	43
				56	38
				60	43
	242 Tone		61	56	
			63	53	
			64	57	
	484 Tone		65	65	
			66	65	
	996 Tone		67	65	
	5775		106 Tone	53	82
				56	82
				60	82
		242 Tone	61	82	
			63	82	
			64	82	
484 Tone		65	82		
		66	82		
996 Tone		67	88		
IEEE 802.11ax (HE160)		5250	242 Tone(20M)	61	22
				64	22
				S64	22
	484 Tone(40M)		65	24	
			66	22	
	996 Tone(80M)		S66	24	
			67	24	
	996*2 Tone(80+80M)		S67	24	
				S68	24

## 2.4 DUTY CYCLE

If duty cycle is  $\geq 98\%$ , duty factor is not required.  
 If duty cycle is  $< 98\%$ , duty factor shall be considered.

### IEEE 802.11ax (HE20)

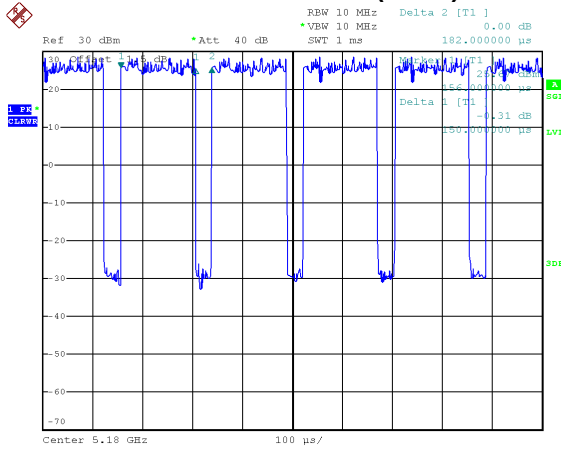

Date: 9.MAR.2020 13:10:39

Duty cycle =  $0.150 \text{ ms} / 0.182 \text{ ms} = 82.42\%$   
 Duty Factor =  $10 * \log(1 / 82.42\%) = 0.84 \text{ dB}$

### IEEE 802.11ax (HE40)

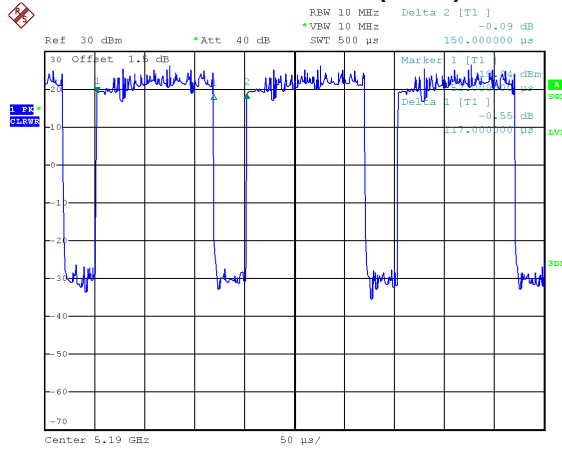

Date: 9.MAR.2020 11:26:44

Duty cycle =  $0.117 \text{ ms} / 0.150 \text{ ms} = 78\%$   
 Duty Factor =  $10 * \log(1 / 78\%) = 1.08 \text{ dB}$

### IEEE 802.11ax (HE80)

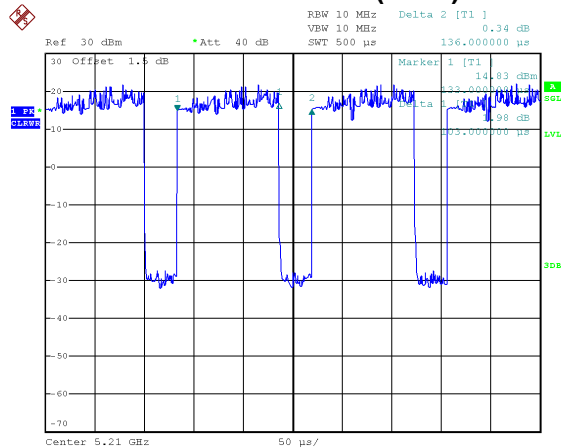

Date: 9.MAR.2020 13:16:41

Duty cycle =  $0.103 \text{ ms} / 0.136 \text{ ms} = 75.74\%$   
 Duty Factor =  $10 * \log(1 / 75.74\%) = 1.21 \text{ dB}$

### IEEE 802.11ax (HE160)

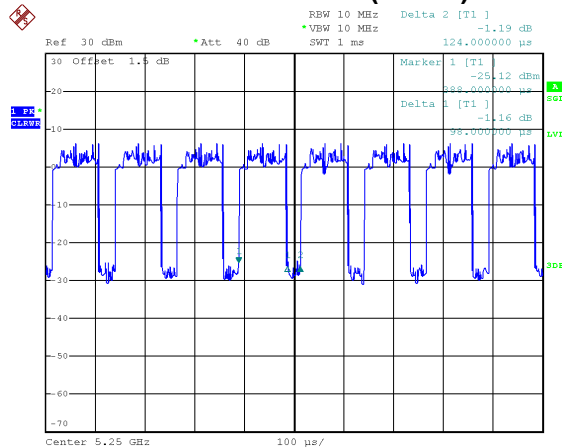

Date: 27.MAR.2020 19:42:37

Duty cycle =  $0.098 \text{ ms} / 0.124 \text{ ms} = 79.03\%$   
 Duty Factor =  $10 * \log(1 / 79.03\%) = 1.02 \text{ dB}$

#### NOTE:

For IEEE 802.11ax (HE20):

For radiated emissions frequency above 1 GHz, the resolution bandwidth of test receiver/spectrum analyzer is 1 MHz and the video bandwidth is 6.67 kHz (Duty cycle  $< 98\%$ ).

For IEEE 802.11ax (HE40):

For radiated emissions frequency above 1 GHz, the resolution bandwidth of test receiver/spectrum analyzer is 1 MHz and the video bandwidth is 8.55 kHz (Duty cycle  $< 98\%$ ).

For IEEE 802.11ax (HE80):

For radiated emissions frequency above 1 GHz, the resolution bandwidth of test receiver/spectrum analyzer is 1 MHz and the video bandwidth is 9.71 kHz (Duty cycle  $< 98\%$ ).

For IEEE 802.11ax (HE160):

For radiated emissions frequency above 1 GHz, the resolution bandwidth of test receiver/spectrum analyzer is 1 MHz and the video bandwidth is 10.21 kHz (Duty cycle  $< 98\%$ ).

## 2.5 BLOCK DIAGRAM SHOWING THE CONFIGURATION OF SYSTEM TESTED

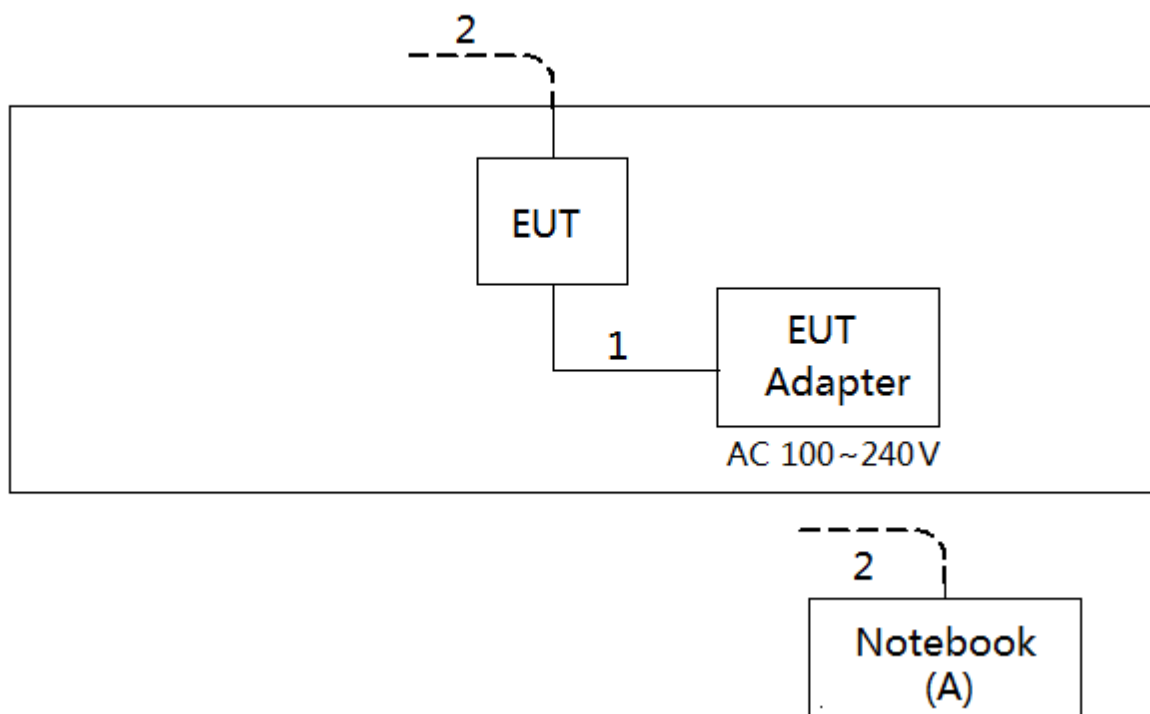

## 2.6 SUPPORT UNITS

Item	Equipment	Mfr/Brand	Model/Type No.	Series No.
A	Notebook	Dell	Inspiron 15-7559	N/A

Item	Cable Type	Shielded Type	Ferrite Core	Length
1	DC Cable	N/A	N/A	1m
2	RJ45 Cable	N/A	N/A	10m

### 3. AC POWER LINE CONDUCTED EMISSIONS TEST

#### 3.1 LIMIT

Frequency (MHz)	Limit (dB $\mu$ V)	
	Quasi-peak	Average
0.15 - 0.5	66 to 56*	56 - 46*
0.50 - 5.0	56	46
5.0 - 30.0	60	50

**NOTE:**

- (1) The tighter limit applies at the band edges.
- (2) The limit of " \* " marked band means the limitation decreases linearly with the logarithm of the frequency in the range.

The following table is the setting of the receiver

Receiver Parameter	Setting
Attenuation	10 dB
Start Frequency	0.15 MHz
Stop Frequency	30 MHz
IF Bandwidth	9 KHz

#### 3.2 TEST PROCEDURE

- a. The EUT was placed 0.8 meters from the horizontal ground plane with EUT being connected to the power mains through a line impedance stabilization network (LISN). All other support equipment powered from additional LISN(s). The LISN provide 50 Ohm/ 50uH of coupling impedance for the measuring instrument.
- b. Interconnecting cables that hang closer than 40 cm to the ground plane shall be folded back and forth in the center forming a bundle 30 to 40 cm long.
- c. I/O cables that are not connected to a peripheral shall be bundled in the center. The end of the cable may be terminated, if required, using the correct terminating impedance. The overall length shall not exceed 1 m.
- d. LISN at least 80 cm from nearest part of EUT chassis.
- e. For the actual test configuration, please refer to the related Item -EUT Test Photos.

#### 3.3 DEVIATION FROM TEST STANDARD

No deviation

### 3.4 TEST SETUP

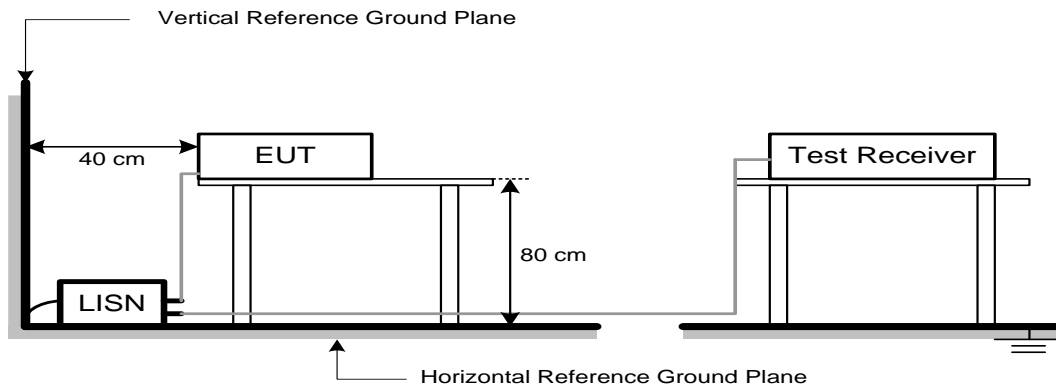

### 3.5 EUT OPERATION CONDITIONS

The EUT was configured for testing in a typical fashion (as a customer would normally use it). The EUT has been programmed to continuously transmit during test. This operating condition was tested and used to collect the included data.

The EUT was programmed to be in continuously transmitting/TX mode.

### 3.6 TEST RESULTS

Please refer to the APPENDIX A.

## 4. RADIATED EMISSIONS TEST

### 4.1 LIMIT

In case the emission fall within the restricted band specified on 15.205(a), then the 15.209(a) limit in the table below has to be followed.

#### LIMITS OF RADIATED EMISSIONS MEASUREMENT (9 kHz to 1000 MHz)

Frequency (MHz)	Field Strength (microvolts/meter)	Measurement Distance (meters)
0.009-0.490	2400/F(kHz)	300
0.490-1.705	24000/F(kHz)	30
1.705-30.0	30	30
30-88	100	3
88-216	150	3
216-960	200	3
Above 960	500	3

#### LIMITS OF UNWANTED EMISSION OUT OF THE RESTRICTED BANDS

Frequency (MHz)	EIRP Limit (dBm/MHz)	Equivalent Field Strength at 3m (dBμV/m)
5150-5250	-27	68.3
5250-5350	-27	68.3
5470-5725	-27	68.3
5725-5850	-27 NOTE (2)	68.3
	10 NOTE (2)	105.3
	15.6 NOTE (2)	110.9
	27 NOTE (2)	122.3

#### NOTE:

(1) The following formula is used to convert the equipment isotropic radiated power (eirp) to field strength:

$$E = \frac{1000000\sqrt{30P}}{3} \mu\text{V/m, where P is the eirp (Watts)}$$

(2) According to 15.407(b)(4)(i), all emissions shall be limited to a level of -27 dBm/MHz at 75 MHz or more above or below the band edge increasing linearly to 10 dBm/MHz at 25 MHz above or below the band edge, and from 25 MHz above or below the band edge increasing linearly to a level of 15.6 dBm/MHz at 5 MHz above or below the band edge, and from 5 MHz above or below the band edge increasing linearly to a level of 27 dBm/MHz at the band edge.

#### 4.2 TEST PROCEDURE

- a. The measuring distance of 3 m shall be used for measurements. The EUT was placed on the top of a rotating table 0.8 meter above the ground at a 3 meter semi-anechoic chamber. The table was rotated 360 degrees to determine the position of the highest radiation.(below 1GHz)
- b. The measuring distance of 3 m shall be used for measurements. The EUT was placed on the top of a rotating table 1.5 meter above the ground at a 3 meter semi-anechoic chamber. The table was rotated 360 degrees to determine the position of the highest radiation.(above 1GHz)
- c. The height of the equipment or of the substitution antenna shall be 0.8m or 1.5m; the height of the test antenna shall vary between 1 m to 4 m. Both horizontal and vertical polarizations of the antenna are set to make the measurement.
- d. For each suspected emission, the EUT was arranged to its worst case and then the antenna was tuned to heights find the maximum reading (used Bore sight function).
- e. The receiver system was set to peak and average detect function and specified bandwidth with maximum hold mode when the test frequency is above 1 GHz.
- f. The initial step in collecting radiated emission data is a receiver peak detector mode pre-scanning the measurement frequency range. Significant peaks are then marked and then Quasi Peak detector mode re-measured.
- g. All readings are Peak unless otherwise stated QP in column of Note. Peak denotes that the Peak reading compliance with the QP Limits and then QP Mode measurement didn't perform.  
(below 1 GHz)
- h. All readings are Peak Mode value unless otherwise stated AVG in column of Note. If the Peak Mode Measured value compliance with the Peak Limits and lower than AVG Limits, the EUT shall be deemed to meet both Peak & AVG Limits and then only Peak Mode was measured, but AVG Mode didn't perform. (above 1 GHz)
- i. For the actual test configuration, please refer to the related Item –EUT Test Photos.

#### 4.3 DEVIATION FROM TEST STANDARD

No deviation

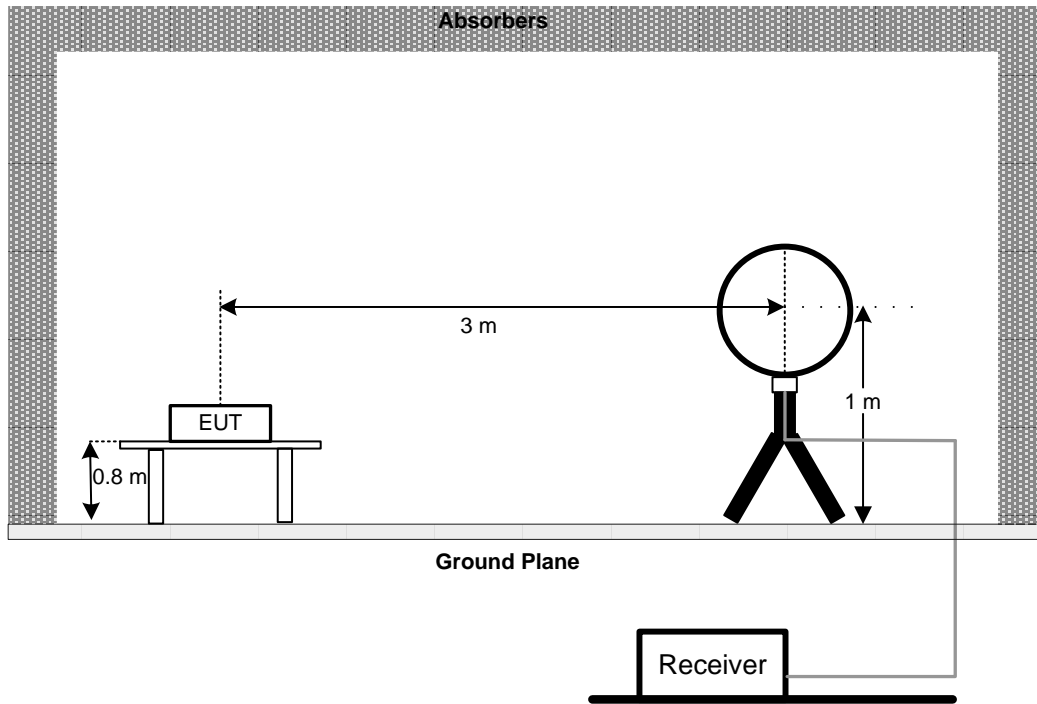
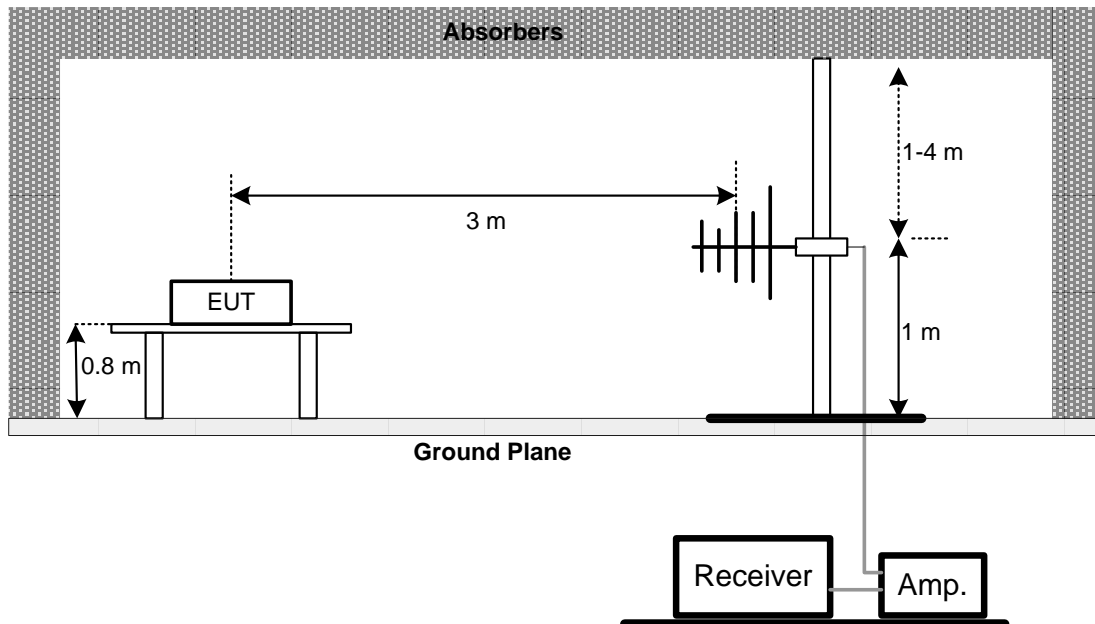
**4.4 TEST SETUP****9 kHz to 30 MHz****30 MHz to 1 GHz**

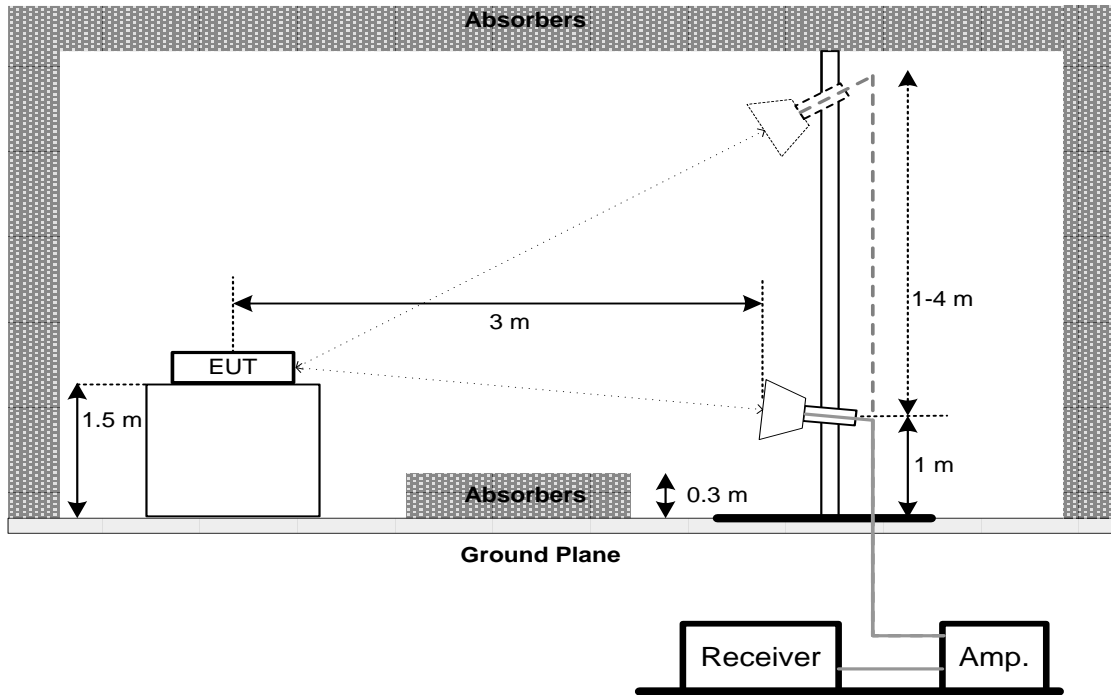
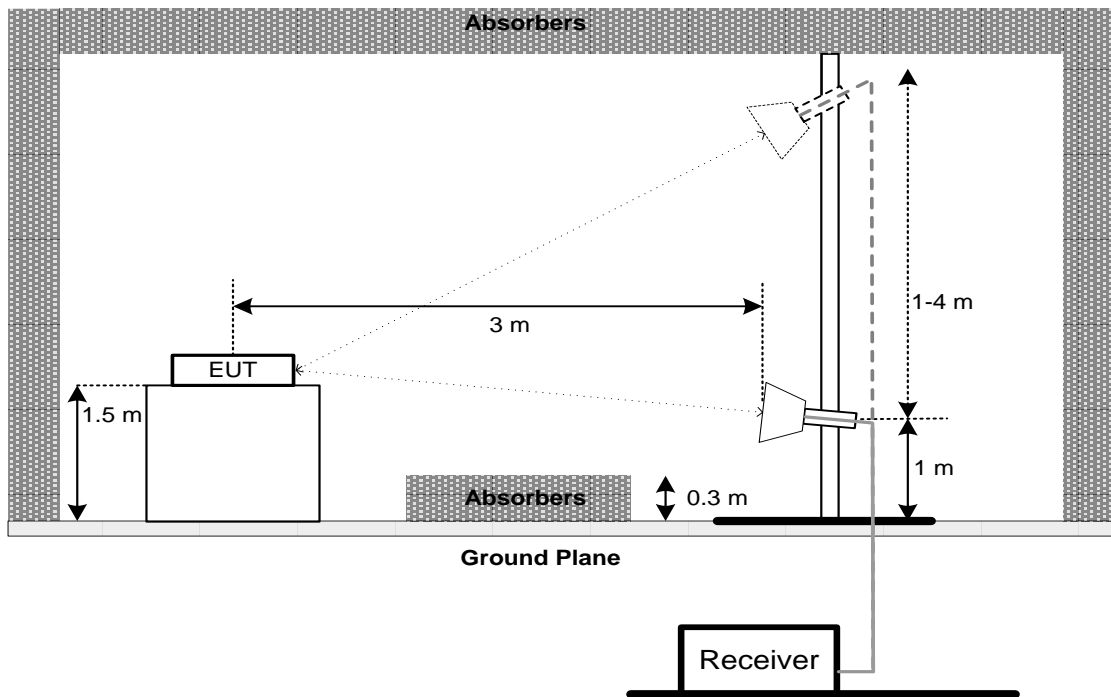

**Above 1 GHz****Above 1 GHz  
Band edge**

**4.5 EUT OPERATION CONDITIONS**

The EUT tested system was configured as the statements of 4.1.5 unless otherwise a special operating condition is specified in the follows during the testing.

**4.6 TEST RESULTS - 30 MHz TO 1000 MHz**

Please refer to the APPENDIX B.

**4.7 TEST RESULTS - ABOVE 1000 MHz**

Please refer to the APPENDIX C.

Remark:

- (1) No limit: This is fundamental signal, the judgment is not applicable.  
For fundamental signal judgment was referred to Peak output test.

## 5. BANDWIDTH TEST

### 5.1 LIMIT

FCC Part15, Subpart E (15.407)			
Section	Test Item	Limit	Frequency Range (MHz)
15.407(a) 15.407(e)	26 dB Bandwidth	-	5150-5250
	26 dB Bandwidth	-	5250-5350
	26 dB Bandwidth	-	5470-5725
	6 dB Bandwidth	Minimum 500 kHz	5725-5850

### 5.2 TEST PROCEDURE

a. The EUT was directly connected to the spectrum analyzer and antenna output port as show in the block diagram below

b. a. Spectrum Setting:

For UNII-1, UNII-2A, UNII-2C:

Spectrum Parameter	Setting
Attenuation	Auto
Span Frequency	> 26 dB Bandwidth
RBW	300 kHz (Bandwidth 20 MHz) 1 MHz (Bandwidth 40 MHz and 80 MHz)
VBW	1 MHz (Bandwidth 20 MHz) 3 MHz (Bandwidth 40 MHz and 80 MHz)
Detector	Peak
Trace	Max Hold
Sweep Time	Auto

For UNII-3:

Spectrum Parameter	Setting
Attenuation	Auto
Span Frequency	6 dB Bandwidth
RBW	100 kHz
VBW	300 kHz
Detector	Peak
Trace	Max Hold
Sweep Time	Auto

c. Measured the spectrum width with power higher than 26 dB below carrier

### 5.3 TEST PROCEDURE

No deviation.

**5.4 TEST SETUP****5.5 EUT OPERATION CONDITIONS**

The EUT was programmed to be in continuously transmitting mode.

**5.6 TEST RESULTS**

Please refer to the APPENDIX D.

## 6. MAXIMUM OUTPUT POWER TEST

### 6.1 LIMIT

FCC Part15, Subpart E (15.407)			
Section	Test Item	Limit	Frequency Range (MHz)
15.407(a)	Conducted Output Power	AP device: 1 Watt (30 dBm) Client device: 250 mW (24 dBm)	5150-5250
		250 mW (24 dBm)	5250-5350
		250 mW (24 dBm)	5470-5725
		1 Watt (30dBm)	5725-5850

Note:

- a. For an indoor access point operating in the band 5.15-5.25 GHz, the maximum conducted output power over the frequency band of operation shall not exceed 1 W provided the maximum antenna gain does not exceed 6 dBi. In addition, the maximum power spectral density shall not exceed 17 dBm in any 1 megahertz band. If transmitting antennas of directional gain greater than 6 dBi are used, both the maximum conducted output power and the maximum power spectral density shall be reduced by the amount in dB that the directional gain of the antenna exceeds 6 dBi.
- b. For the 5.25-5.35 GHz and 5.47-5.725 GHz bands, the maximum conducted output power over the frequency bands of operation shall not exceed the lesser of 250 mW or 11 dBm + 10log B, where B is the 26dB Bandwidth in megahertz.

### 6.2 TEST PROCEDURE

- a. The EUT was directly connected to the power meter and antenna output port as show in the block diagram below.
- b. Test test was performed in accordance with method of FCC KDB 789033 D02 General UNII Test Procedures New Rules v02r01.

### 6.3 DEVIATION FROM STANDARD

No deviation.

### 6.4 TEST SETUP



### 6.5 EUT OPERATION CONDITIONS

The EUT was programmed to be in continuously transmitting mode.

### 6.6 TEST RESULTS

Please refer to the APPENDIX E.

## 7. POWER SPECTRAL DENSITY TEST

### 7.1 LIMIT

FCC Part15, Subpart E (15.407)			
Section	Test Item	Limit	Frequency Range (MHz)
15.407(a)	Power Spectral Density	AP device: 17 dBm/MHz Client device: 11 dBm/MHz	5150-5250
		11 dBm/MHz	5250-5350
		11 dBm/MHz	5470-5725
		30 dBm/500 kHz	5725-5850

### 7.2 TEST PROCEDURE

- a. The EUT was directly connected to the spectrum analyzer and antenna output port as show in the block diagram below.
- b. Spectrum Setting

Spectrum Parameter	Setting
Attenuation	Auto
Span Frequency	Encompass the entire emissions bandwidth (EBW) of the signal
RBW	= 1 MHz.
VBW	≥ 3 MHz.
Detector	RMS
Trace average	100 trace
Sweep Time	Auto

Note:

1. For UNII-3, according to KDB publication 789033 D02 General UNII Test Procedures New Rules v02r01, section II.F.5., it is acceptable to set RBW at 1 MHz and VBW at 3 MHz if the spectrum analyzer does not have 500 kHz RBW.
2. The value measured with RBW=1 MHz is to be added with  $10\log(500 \text{ kHz}/1 \text{ MHz})$  which is -3 dB. For example, if the measured value is +10dBm using RBW=1 MHz (that is +10 dBm/MHz), then the converted value will be +7dBm/500kHz.

### 7.3 DEVIATION FROM STANDARD

No deviation.

**7.4 TEST SETUP****7.5 EUT OPERATION CONDITIONS**

The EUT was programmed to be in continuously transmitting mode.

**7.6 TEST RESULTS**

Please refer to the APPENDIX F.

## 8. MEASUREMENT INSTRUMENTS LIST

AC Power Line Conducted Emissions					
Item	Kind of Equipment	Manufacturer	Type No.	Serial No.	Calibrated until
1	Line Impedance Stabilisation Network	Schwarzbeck	NNLK 8121	8121-822	Mar. 29, 2020
2	TWO-LINE V-NETWORK	R&S	ENV216	101340	Sep. 01, 2020
3	Test Cable	emci	EMCRG400-BM-N M-10000	170628	Apr. 17, 2020
4	EMI Test Receiver	R&S	ESCI	100082	Mar. 29, 2020
5	50Ω Terminator	SHX	TF2-1G-A	17051602	Mar. 29, 2020
6	50Ω coaxial switch	Anritsu	MP59B	6201750902	Mar. 29, 2020
7	Measurement Software	Farad	EZ-EMC Ver.NB-03A1-01	N/A	N/A

Radiated Emissions - 9 kHz to 30 MHz					
Item	Kind of Equipment	Manufacturer	Type No.	Serial No.	Calibrated until
1	Loop Antenna	EMCI	EMCI LPA600	275	Mar. 29, 2020
2	EMI Test Receiver	R&S	ESCI	100082	Mar. 29, 2020
3	Measurement Software	Farad	EZ-EMC Ver.NB-03A1-01	N/A	N/A

Radiated Emissions - 30 MHz to 1 GHz					
Item	Kind of Equipment	Manufacturer	Type No.	Serial No.	Calibrated until
1	TRILOG Broadband Antenna	Schwarzbeck	VULB 9168	719	Mar. 29, 2020
2	Pre-Amplifier	emci	EMC9135	980400	Mar. 29, 2020
3	MXE EMI Receiver	Keysight	N9038A	MY57150106	Mar. 29, 2020
4	Test Cable	emci	EMC104-SM-SM-7000	170330	Apr. 17, 2020
5	Test Cable	emci	EMC104-SM-SM-1000	170331	Apr. 17, 2020
6	Test Cable	emci	EMC104-SM-NM-3500	170621	Apr. 17, 2020
7	Measurement Software	Farad	EZ-EMC Ver.NB-03A1-01	N/A	N/A



Radiated Emissions - Above 1 GHz					
Item	Kind of Equipment	Manufacturer	Type No.	Serial No.	Calibrated until
1	Double-Ridged Waveguide Horn Antenna	ETS-Lindgren	9120D	00206960	Mar. 29, 2020
2	Pre-Amplifier	emci	EMC012645SE	980421	Mar. 29, 2020
3	EXA Spectrum Analyzer	Keysight	N9010A	MY56480545	Mar. 29, 2020
4	Test Cable	emci	EMC104-SM-SM-7000	170330	Apr. 17, 2020
5	Test Cable	emci	EMC104-SM-SM-1000	170331	Apr. 17, 2020
6	Test Cable	emci	EMC104-SM-NM-3500	170621	Apr. 17, 2020
7	Measurement Software	Farad	EZ-EMC Ver.NB-03A1-01	N/A	N/A
8	MXE EMI Receiver	Keysight	N9038A	MY57150106	Mar. 29, 2020

Bandwidth					
Item	Kind of Equipment	Manufacturer	Type No.	Serial No.	Calibrated until
1	Spectrum Analyzer	R&S	FSP40	100626	Mar. 29, 2020

Maximum Output Power					
Item	Kind of Equipment	Manufacturer	Type No.	Serial No.	Calibrated until
1	Power Meter	Keysight	8990B	MY51000507	Mar. 29, 2020
2	Pulse Power Sensor	Keysight	N1923A	MY58310003	Mar. 29, 2020

Antenna Conducted Spurious Emissions					
Item	Kind of Equipment	Manufacturer	Type No.	Serial No.	Calibrated until
1	Spectrum Analyzer	R&S	FSP40	100626	Mar. 29, 2020

Power Spectral Density					
Item	Kind of Equipment	Manufacturer	Type No.	Serial No.	Calibrated until
1	Spectrum Analyzer	R&S	FSP40	100626	Mar. 29, 2020

Remark: "N/A" denotes no model name, serial no. or calibration specified.

All calibration period of equipment list is one year.

## 9. EUT TEST PHOTOS

### Conducted Emissions Test Photos

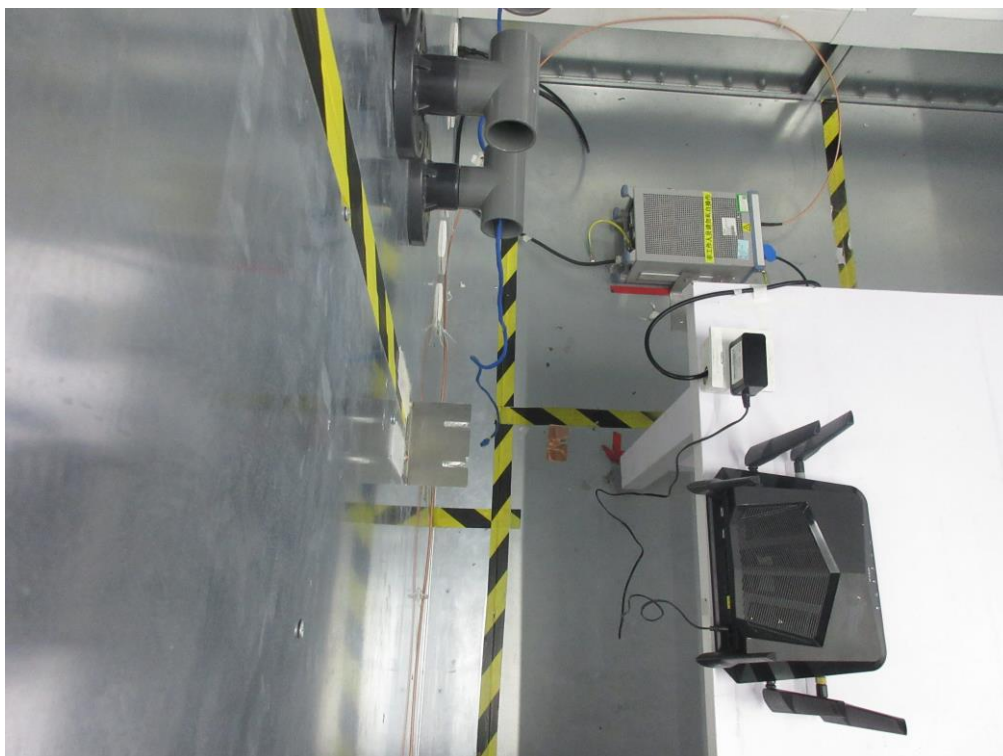

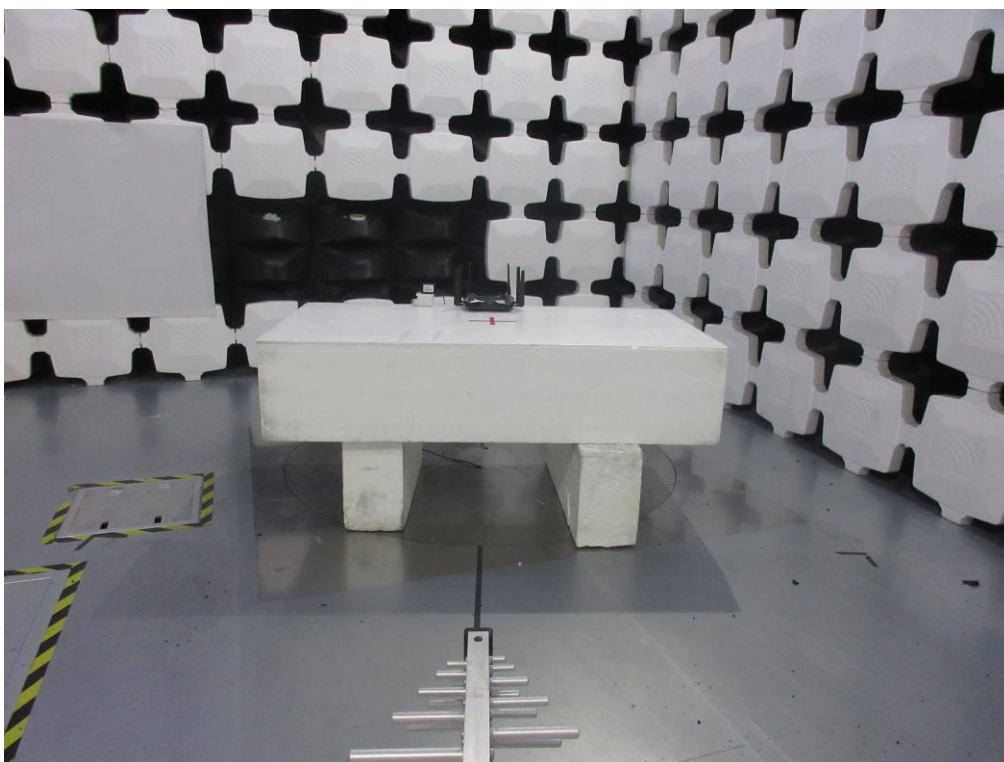
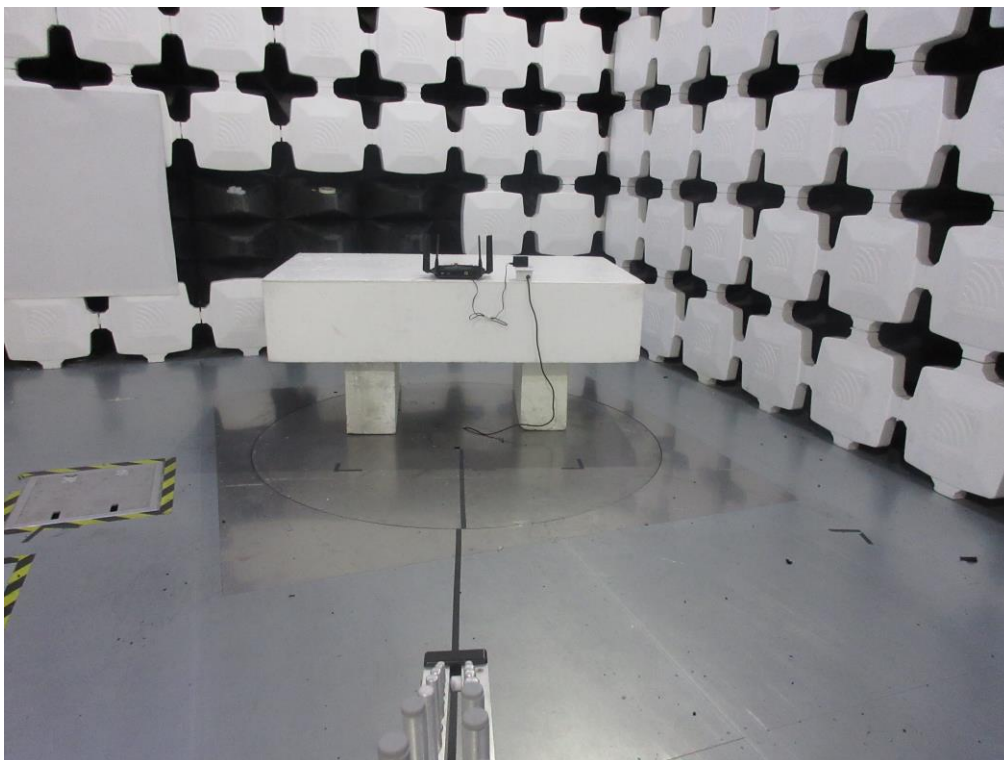
**Radiated Emissions Test Photos****30 MHz to 1 GHz**



**Radiated Emissions Test Photos**

**Above 1 GHz**

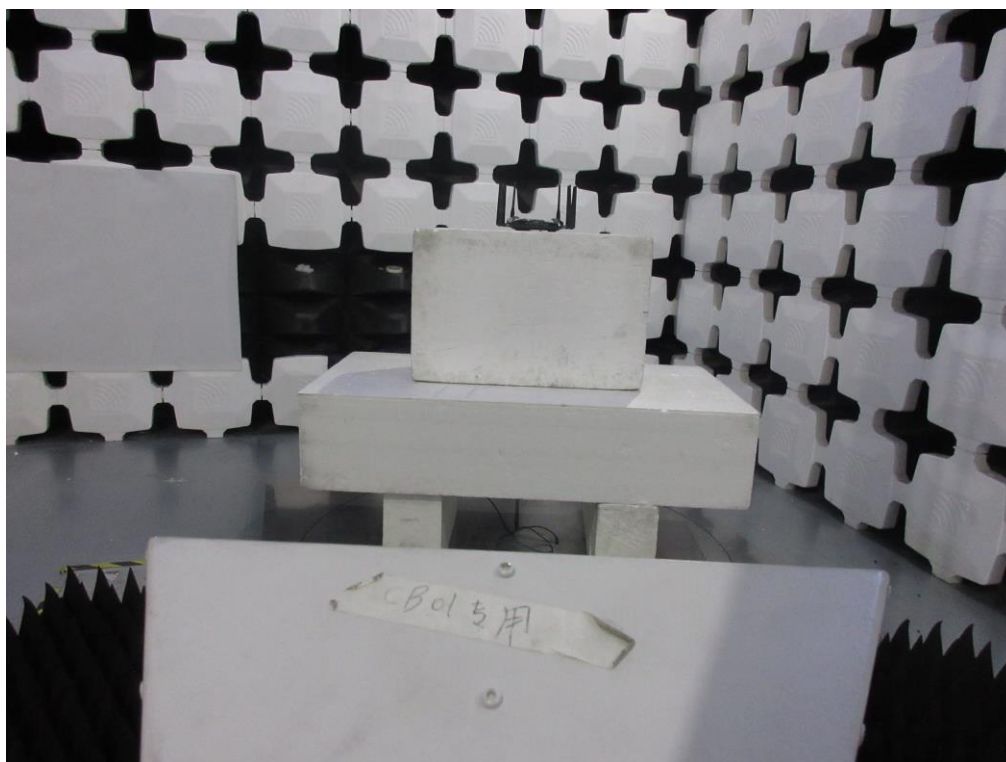
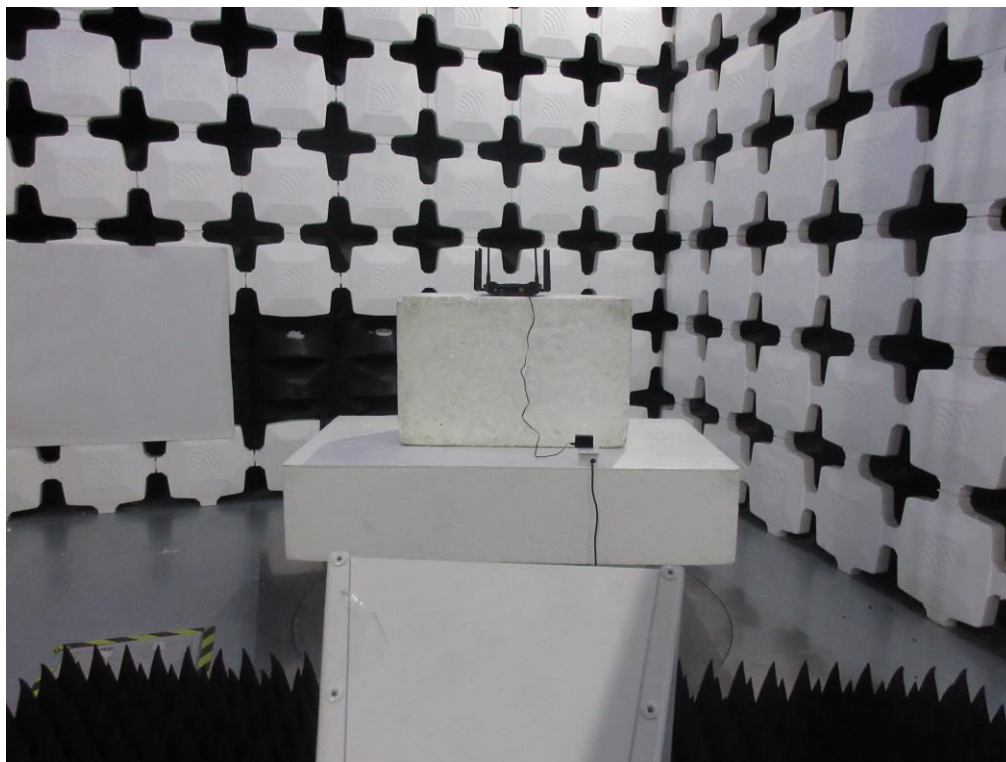

## **APPENDIX A - AC POWER LINE CONDUCTED EMISSIONS**

Test Mode: UNII-3\_TX AX (HE40) Mode 5755 MHz

### Line

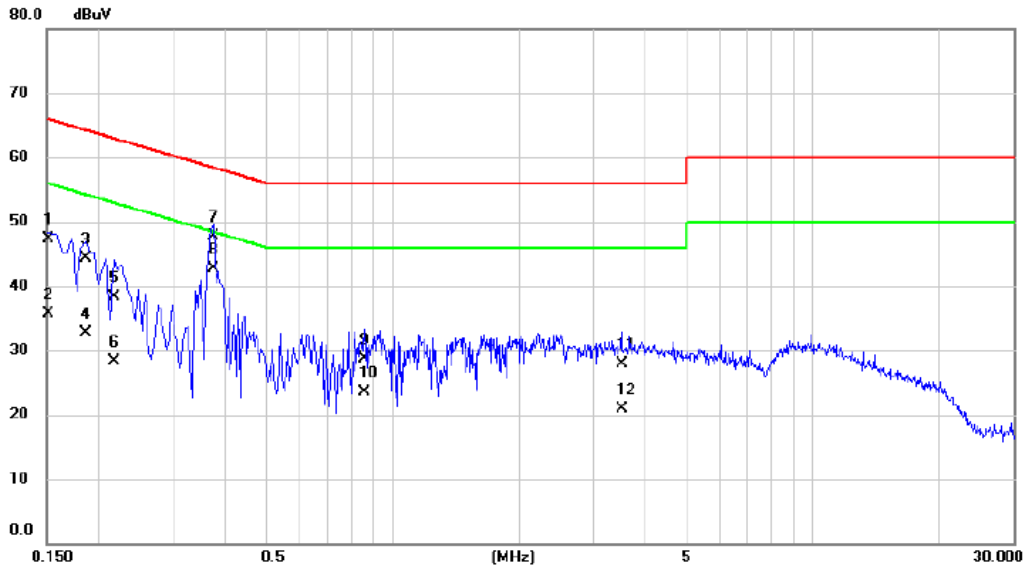

No.	Mk.	Freq. MHz	Reading Level dBuV	Correct Factor dB	Measure- ment dBuV	Limit dBuV	Margin dB	Detector	Comment
1		0.1516	37.60	9.73	47.33	65.91	-18.58	QP	
2		0.1516	26.00	9.73	35.73	55.91	-20.18	AVG	
3		0.1860	34.60	9.77	44.37	64.21	-19.84	QP	
4		0.1860	22.90	9.77	32.67	54.21	-21.54	AVG	
5		0.2175	28.60	9.79	38.39	62.91	-24.52	QP	
6		0.2175	18.60	9.79	28.39	52.91	-24.52	AVG	
7		0.3750	37.80	9.85	47.65	58.39	-10.74	QP	
8	*	0.3750	32.80	9.85	42.65	48.39	-5.74	AVG	
9		0.8565	18.90	9.79	28.69	56.00	-27.31	QP	
10		0.8565	13.80	9.79	23.59	46.00	-22.41	AVG	
11		3.5070	18.10	9.89	27.99	56.00	-28.01	QP	
12		3.5070	11.00	9.89	20.89	46.00	-25.11	AVG	

**REMARKS:**

- (1) Measurement Value = Reading Level + Correct Factor.
- (2) Margin Level = Measurement Value - Limit Value.

Test Mode: UNII-3\_TX AX (HE40) Mode 5795 MHz

### Neutral

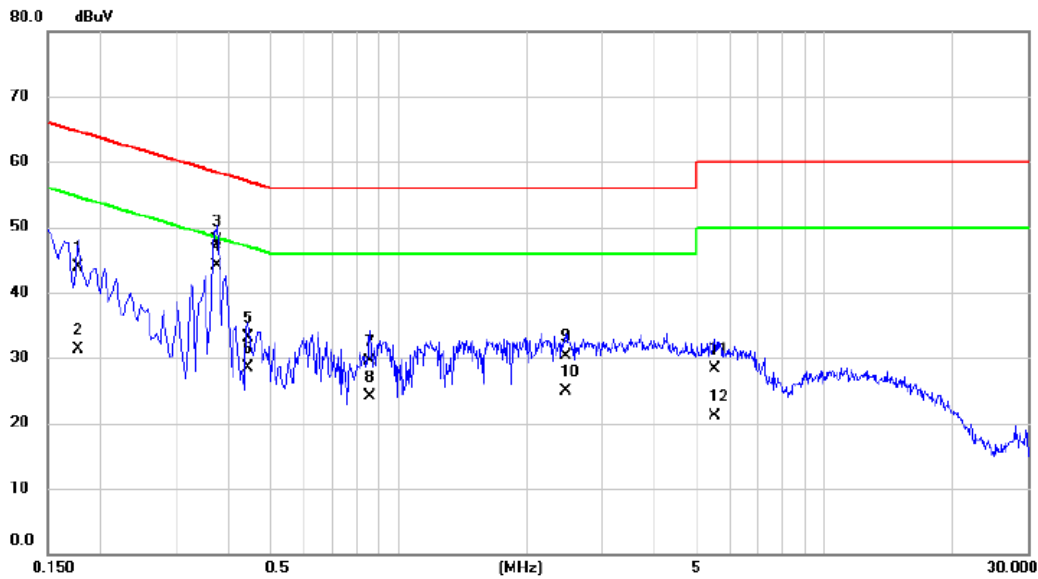

No. Mk.	Freq. MHz	Reading Level dBuV	Correct Factor dB	Measurement dBuV	Limit dBuV	Margin dB	Detector	Comment
1	0.1770	34.20	9.63	43.83	64.63	-20.80	QP	
2	0.1770	21.60	9.63	31.23	54.63	-23.40	AVG	
3	0.3750	38.20	9.67	47.87	58.39	-10.52	QP	
4 *	0.3750	34.50	9.67	44.17	48.39	-4.22	AVG	
5	0.4425	23.40	9.67	33.07	57.01	-23.94	QP	
6	0.4425	18.90	9.67	28.57	47.01	-18.44	AVG	
7	0.8565	19.80	9.72	29.52	56.00	-26.48	QP	
8	0.8565	14.40	9.72	24.12	46.00	-21.88	AVG	
9	2.4630	20.40	9.81	30.21	56.00	-25.79	QP	
10	2.4630	15.10	9.81	24.91	46.00	-21.09	AVG	
11	5.5185	18.30	9.97	28.27	60.00	-31.73	QP	
12	5.5185	11.10	9.97	21.07	50.00	-28.93	AVG	

**REMARKS:**

- (1) Measurement Value = Reading Level + Correct Factor.
- (2) Margin Level = Measurement Value - Limit Value.

**APPENDIX B - RADIATED EMISSION - 30 MHZ TO 1 GHZ**



Test Mode: UNII-3\_TX AX (HE40) Mode 5795 MHz

### Vertical

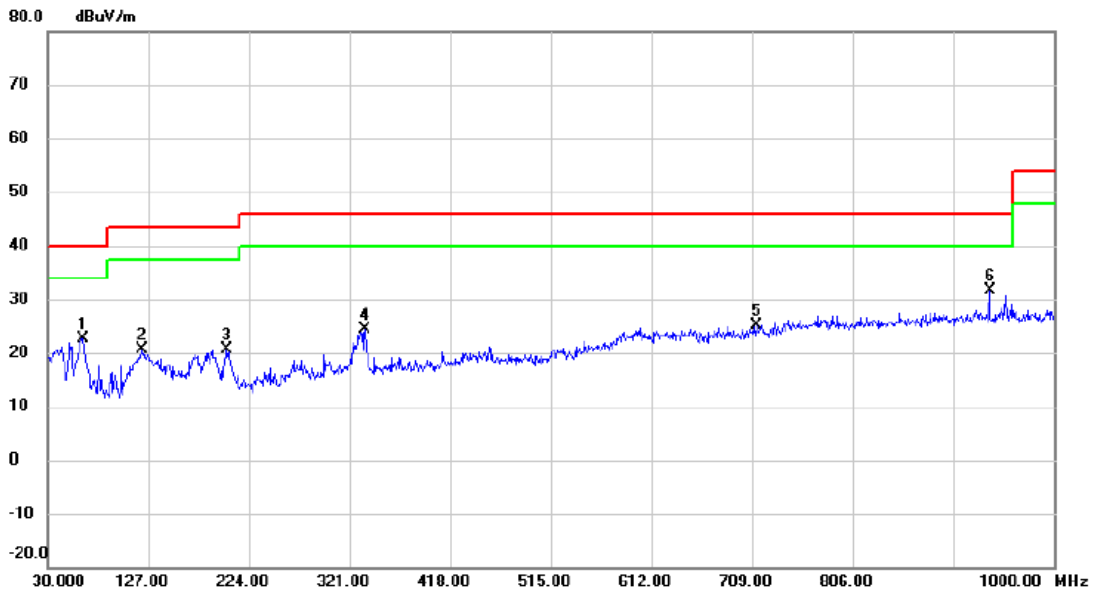

No.	Mk.	Freq. MHz	Reading Level dBuV	Correct Factor dB	Measure- ment dBuV/m	Limit dBuV/m	Margin dB	Detector	Comment
1		63.9500	41.32	-18.60	22.72	40.00	-17.28	peak	
2		121.6650	37.61	-17.05	20.56	43.50	-22.94	peak	
3		202.6600	39.46	-18.77	20.69	43.50	-22.81	peak	
4		335.5500	38.09	-13.82	24.27	46.00	-21.73	peak	
5		712.8800	33.31	-8.08	25.23	46.00	-20.77	peak	
6	*	938.4050	36.88	-5.20	31.68	46.00	-14.32	peak	

**REMARKS:**

- (1) Measurement Value = Reading Level + Correct Factor.
- (2) Margin Level = Measurement Value - Limit Value.

Test Mode: UNII-3\_TX AX (HE40) Mode 5795 MHz

### Horizontal

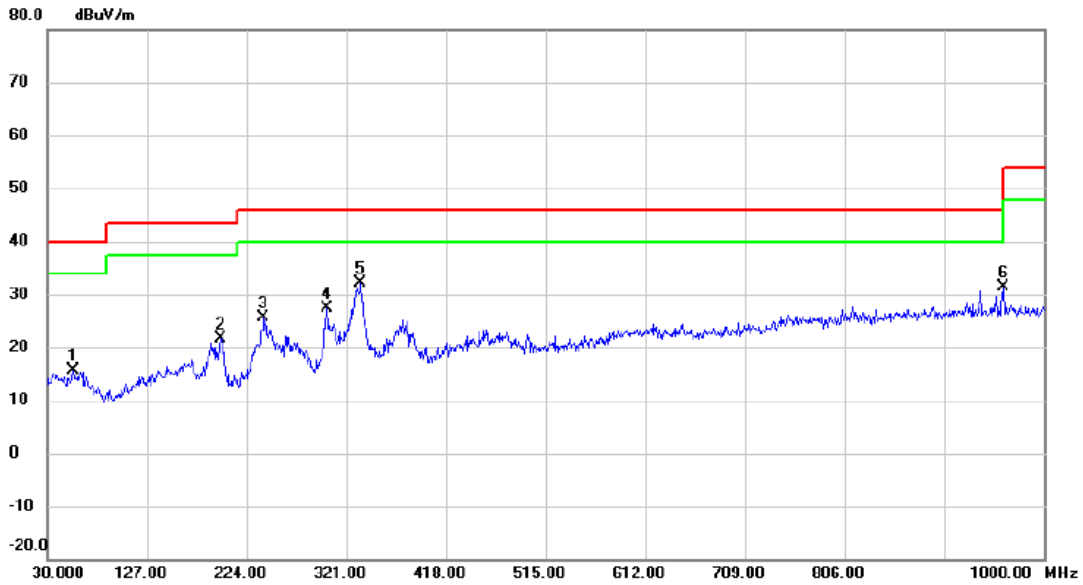

No. Mk.	Freq. MHz	Reading Level dBuV	Correct Factor dB	Measure- ment dBuV/m	Limit dBuV/m	Margin dB	Detector	Comment
1	55.7050	32.93	-17.33	15.60	40.00	-24.40	peak	
2	198.2950	40.47	-18.82	21.65	43.50	-21.85	peak	
3	240.4900	42.57	-16.91	25.66	46.00	-20.34	peak	
4	302.0850	41.76	-14.28	27.48	46.00	-18.52	peak	
5 *	334.5800	46.06	-13.84	32.22	46.00	-13.78	peak	
6	960.2300	36.43	-5.09	31.34	54.00	-22.66	peak	

**REMARKS:**

(1) Measurement Value = Reading Level + Correct Factor.

(2) Margin Level = Measurement Value - Limit Value.

## **APPENDIX C - RADIATED EMISSION - ABOVE 1000 MHZ**

Orthogonal Axis	X		
Test Mode	UNII-1_TX AX (HE20) Mode 5180 MHz	RU configuration	52/37

### Vertical

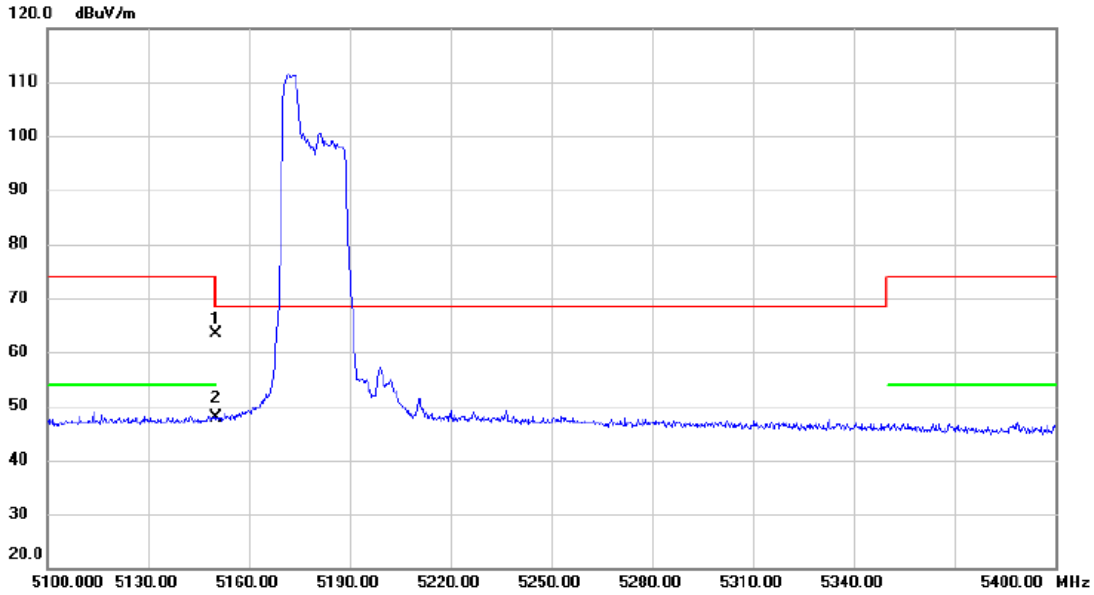

No.	Mk.	Freq. MHz	Reading Level dBuV	Correct Factor dB	Measure- ment dBuV/m	Limit dBuV/m	Margin dB	Detector	Comment
1		5150.000	24.27	39.07	63.34	74.00	-10.66	peak	
2	*	5150.000	8.72	39.07	47.79	54.00	-6.21	AVG	

**REMARKS:**

- (1) Measurement Value = Reading Level + Correct Factor.
- (2) Margin Level = Measurement Value - Limit Value.

Orthogonal Axis	X		
Test Mode	UNII-1_TX AX (HE20) Mode 5180 MHz	RU configuration	52/37

### Horizontal

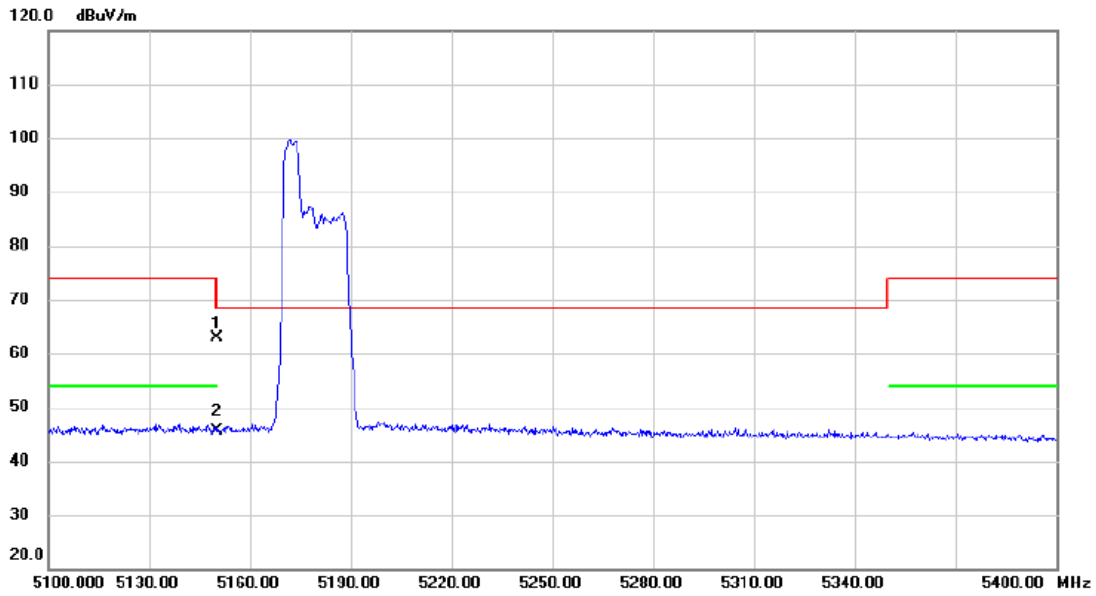

No.	Mk.	Freq.	Reading Level	Correct Factor	Measurement	Limit	Margin	Detector	Comment
		MHz	dBuV	dB	dBuV/m	dBuV/m	dB		
1		5150.000	23.82	39.07	62.89	74.00	-11.11	peak	
2	*	5150.000	6.57	39.07	45.64	54.00	-8.36	AVG	

**REMARKS:**

- (1) Measurement Value = Reading Level + Correct Factor.
- (2) Margin Level = Measurement Value - Limit Value.

Orthogonal Axis	X		
Test Mode	UNII-1_TX AX (HE20) Mode 5180 MHz	RU configuration	106/53

### Vertical

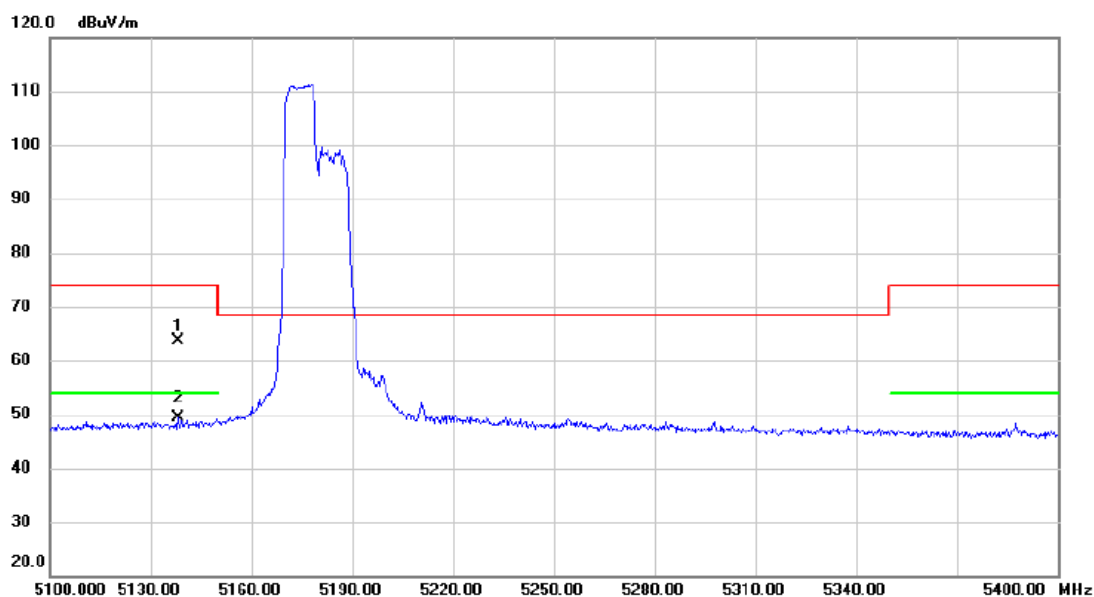

No.	Mk.	Freq. MHz	Reading Level dBuV	Correct Factor dB	Measure- ment dBuV/m	Limit dBuV/m	Margin dB	Detector	Comment
1		5138.250	24.67	39.05	63.72	74.00	-10.28	peak	
2	*	5138.250	10.35	39.05	49.40	54.00	-4.60	AVG	

**REMARKS:**

- (1) Measurement Value = Reading Level + Correct Factor.
- (2) Margin Level = Measurement Value - Limit Value.

Orthogonal Axis	X		
Test Mode	UNII-1_TX AX (HE20) Mode 5180 MHz	RU configuration	106/53

### Horizontal

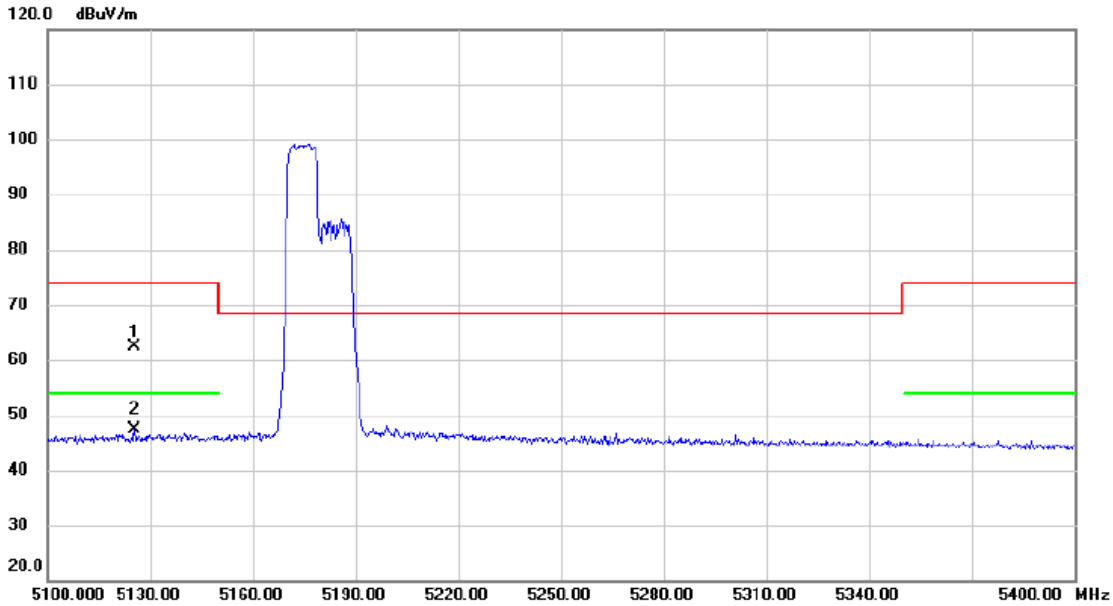

No.	Mk.	Freq. MHz	Reading Level dBuV	Correct Factor dB	Measure- ment dBuV/m	Limit dBuV/m	Margin dB	Detector	Comment
1		5125.500	23.35	39.04	62.39	74.00	-11.61	peak	
2	*	5125.500	8.22	39.04	47.26	54.00	-6.74	AVG	

**REMARKS:**

- (1) Measurement Value = Reading Level + Correct Factor.
- (2) Margin Level = Measurement Value - Limit Value.

Orthogonal Axis	X		
Test Mode	UNII-1_TX AX (HE20) Mode 5180 MHz	RU configuration	242/61

### Vertical

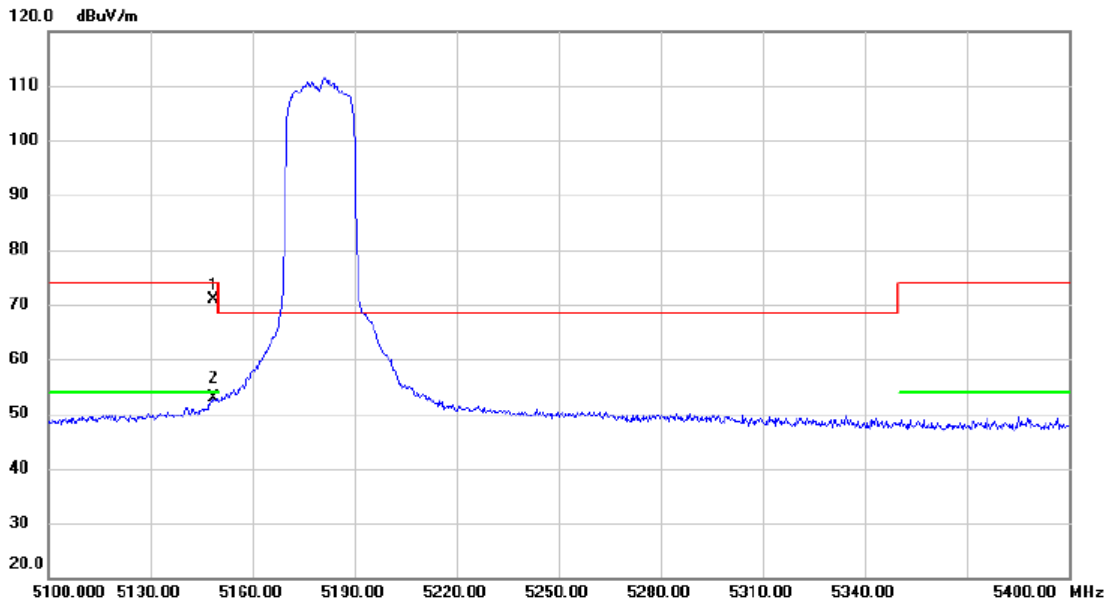

No.	Mk.	Freq. MHz	Reading Level dBuV	Correct Factor dB	Measure- ment dBuV/m	Limit dBuV/m	Margin dB	Detector	Comment
1		5148.750	31.81	39.07	70.88	74.00	-3.12	peak	
2	*	5148.750	13.81	39.07	52.88	54.00	-1.12	AVG	

**REMARKS:**

- (1) Measurement Value = Reading Level + Correct Factor.
- (2) Margin Level = Measurement Value - Limit Value.



Orthogonal Axis	X		
Test Mode	UNII-1_TX AX (HE20) Mode 5180 MHz	RU configuration	242/61

### Horizontal

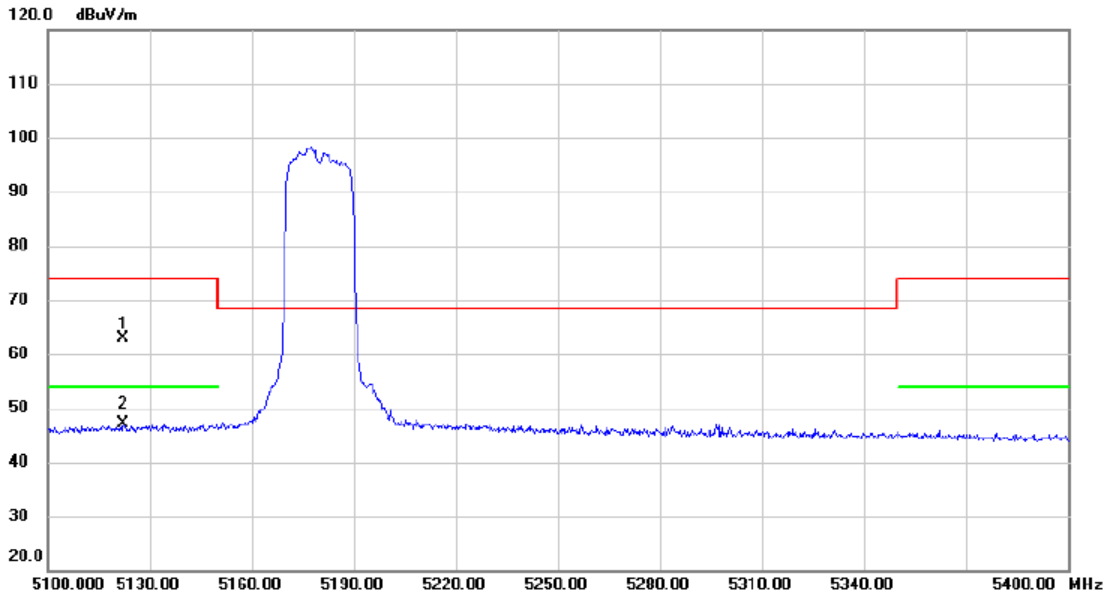

No.	Mk.	Freq. MHz	Reading Level dBuV	Correct Factor dB	Measure- ment dBuV/m	Limit dBuV/m	Margin dB	Detector	Comment
1		5122.350	23.75	39.03	62.78	74.00	-11.22	peak	
2	*	5122.350	8.02	39.03	47.05	54.00	-6.95	AVG	

**REMARKS:**

- (1) Measurement Value = Reading Level + Correct Factor.
- (2) Margin Level = Measurement Value - Limit Value.

Orthogonal Axis	X		
Test Mode	UNII-1_TX AX (HE20) Mode 5180 MHz	RU configuration	242/61

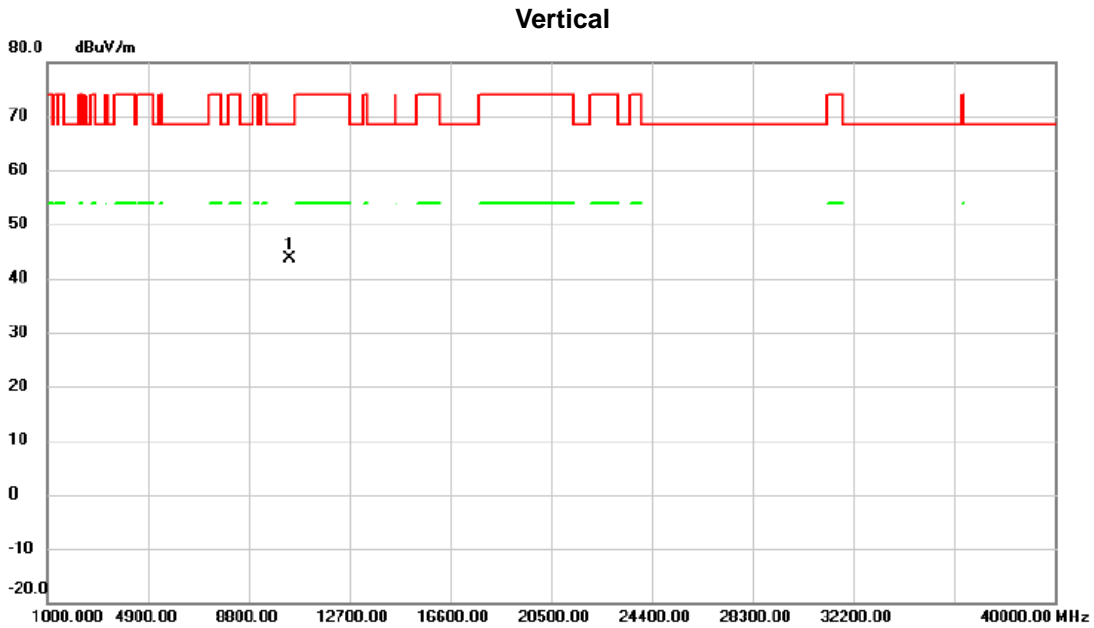

No.	Mk.	Freq.	Reading Level	Correct Factor	Measurement	Limit	Margin	Detector	Comment
		MHz	dBuV	dB	dBuV/m	dBuV/m	dB		
1	*	10360.00	45.04	-1.44	43.60	68.30	-24.70	peak	

**REMARKS:**

- (1) Measurement Value = Reading Level + Correct Factor.
- (2) Margin Level = Measurement Value - Limit Value.

Orthogonal Axis	X		
Test Mode	UNII-1_TX AX (HE20) Mode 5180 MHz	RU configuration	242/61

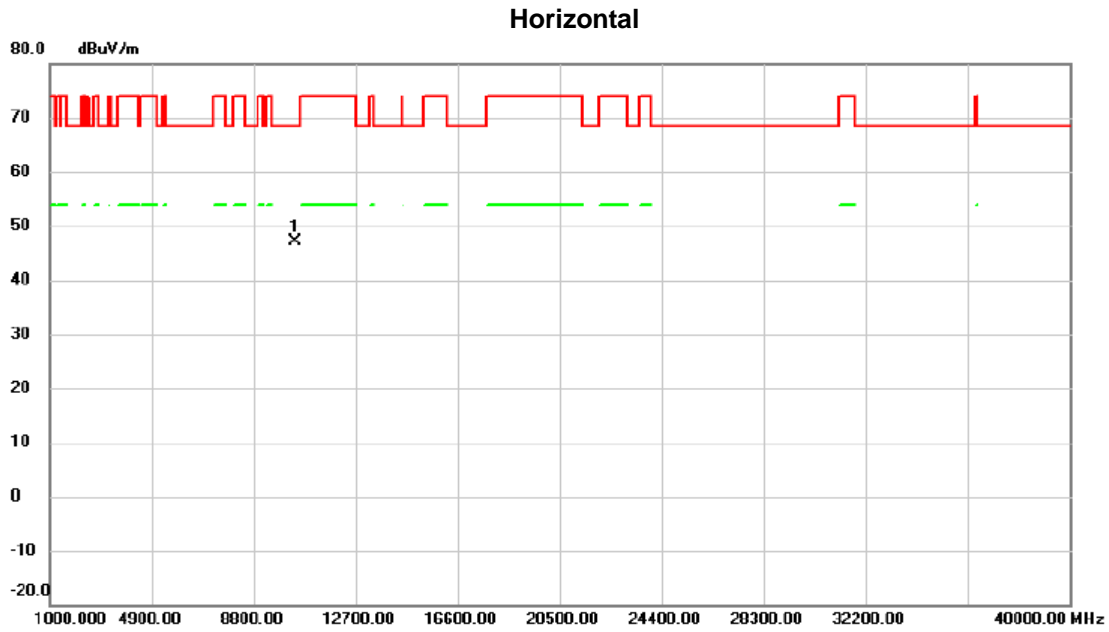

No.	Mk.	Freq. MHz	Reading Level dBuV	Correct Factor dB	Measure- ment dBuV/m	Limit dBuV/m	Margin dB	Detector	Comment
1	*	10360.00	44.67	2.49	47.16	68.30	-21.14	peak	

**REMARKS:**

- (1) Measurement Value = Reading Level + Correct Factor.
- (2) Margin Level = Measurement Value - Limit Value.

Orthogonal Axis	X		
Test Mode	UNII-1_TX AX (HE20) Mode 5200 MHz	RU configuration	52/37

### Vertical

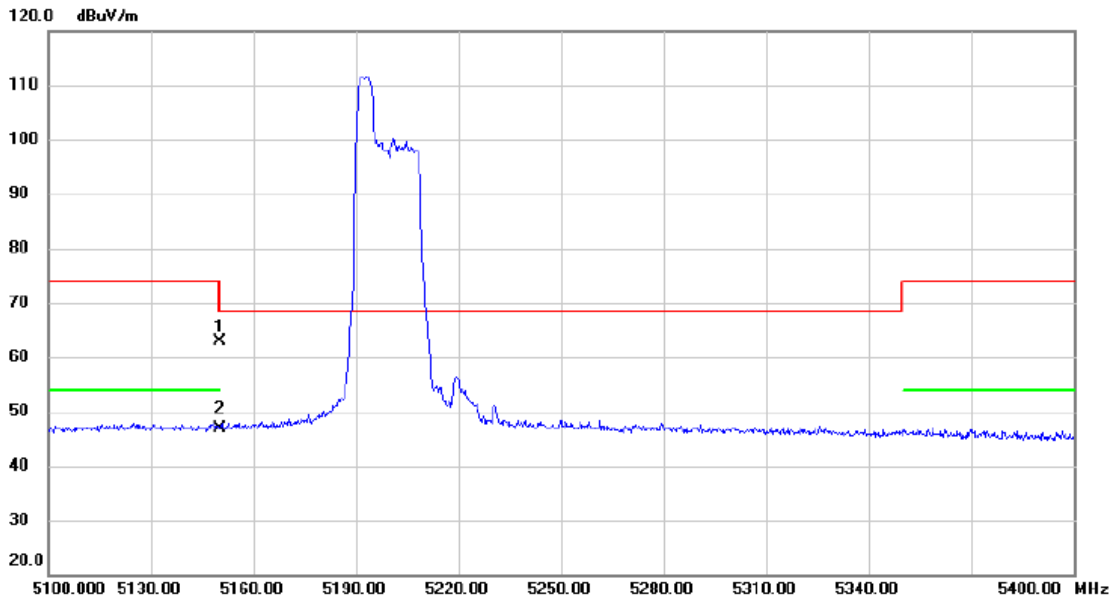

No.	Mk.	Freq. MHz	Reading Level dBuV	Correct Factor dB	Measure- ment dBuV/m	Limit dBuV/m	Margin dB	Detector	Comment
1		5150.000	23.72	39.07	62.79	74.00	-11.21	peak	
2	*	5150.000	7.77	39.07	46.84	54.00	-7.16	AVG	

**REMARKS:**

- (1) Measurement Value = Reading Level + Correct Factor.
- (2) Margin Level = Measurement Value - Limit Value.

Orthogonal Axis	X		
Test Mode	UNII-1_TX AX (HE20) Mode 5200 MHz	RU configuration	52/37

### Horizontal

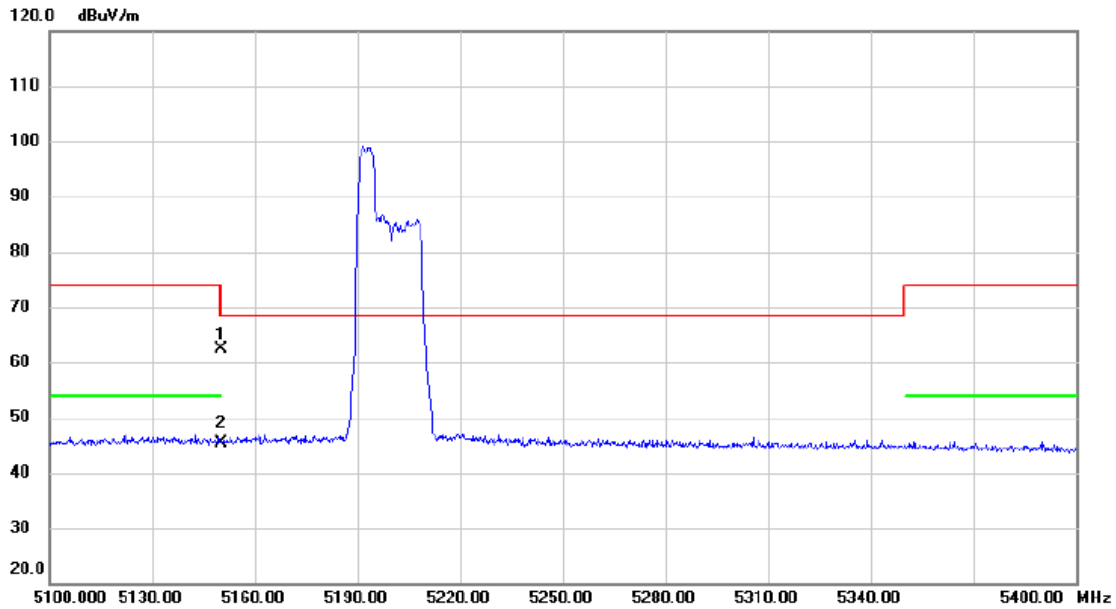

No.	Mk.	Freq. MHz	Reading Level dBuV	Correct Factor dB	Measure- ment dBuV/m	Limit dBuV/m	Margin dB	Detector	Comment
1		5150.000	23.37	39.07	62.44	74.00	-11.56	peak	
2	*	5150.000	6.43	39.07	45.50	54.00	-8.50	AVG	

**REMARKS:**

- (1) Measurement Value = Reading Level + Correct Factor.
- (2) Margin Level = Measurement Value - Limit Value.

Orthogonal Axis	X		
Test Mode	UNII-1_TX AX (HE20) Mode 5200 MHz	RU configuration	106/53

### Vertical

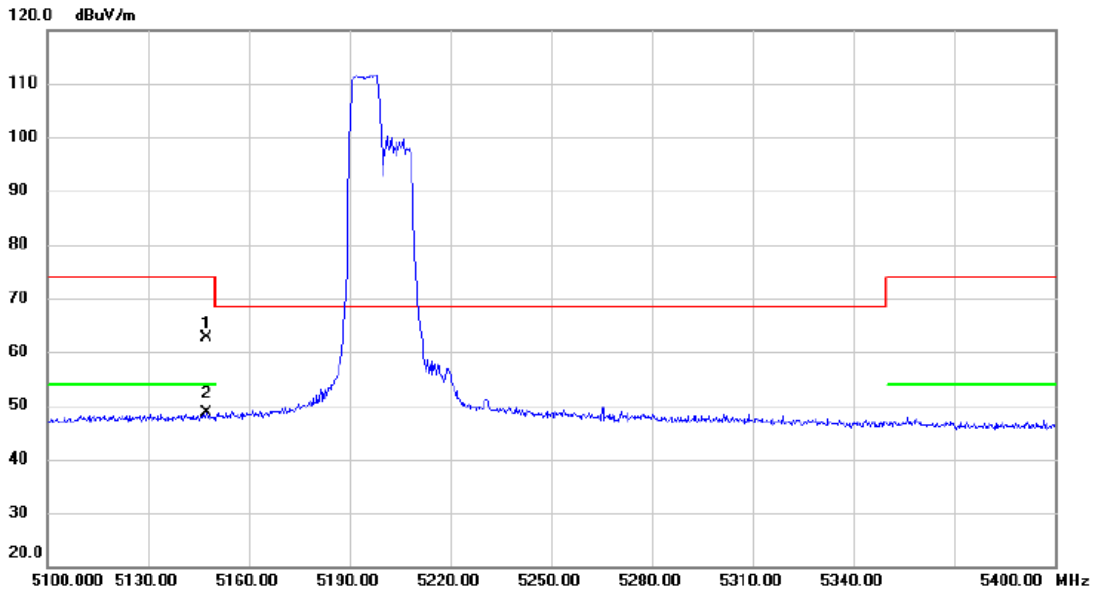

No.	Mk.	Freq. MHz	Reading Level dBuV	Correct Factor dB	Measure- ment dBuV/m	Limit dBuV/m	Margin dB	Detector	Comment
1		5147.400	23.61	39.07	62.68	74.00	-11.32	peak	
2	*	5147.400	9.67	39.07	48.74	54.00	-5.26	AVG	

**REMARKS:**

- (1) Measurement Value = Reading Level + Correct Factor.
- (2) Margin Level = Measurement Value - Limit Value.

Orthogonal Axis	X		
Test Mode	UNII-1_TX AX (HE20) Mode 5200 MHz	RU configuration	106/53

### Horizontal

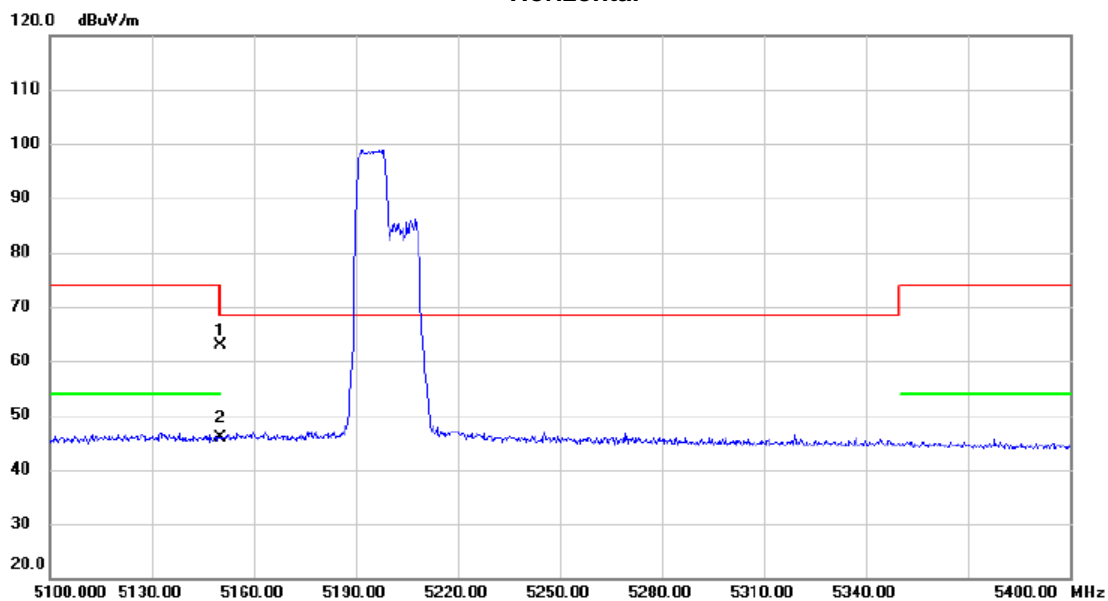

No.	Mk.	Freq. MHz	Reading Level dBuV	Correct Factor dB	Measure- ment dBuV/m	Limit dBuV/m	Margin dB	Detector	Comment
1		5150.000	23.78	39.07	62.85	74.00	-11.15	peak	
2	*	5150.000	6.78	39.07	45.85	54.00	-8.15	AVG	

**REMARKS:**

- (1) Measurement Value = Reading Level + Correct Factor.
- (2) Margin Level = Measurement Value - Limit Value.

Orthogonal Axis	X		
Test Mode	UNII-1_TX AX (HE20) Mode 5200 MHz	RU configuration	242/61

### Vertical

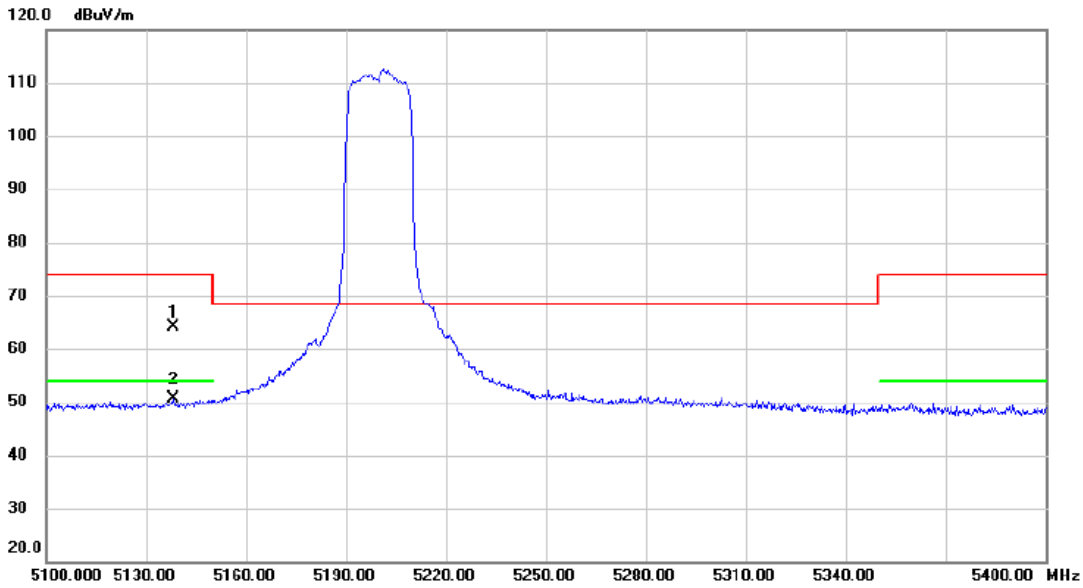

No. Mk.	Freq. MHz	Reading Level dBuV	Correct Factor dB	Measurement dBuV/m	Limit dBuV/m	Margin dB	Detector	Comment
1	5138.250	25.16	39.05	64.21	74.00	-9.79	peak	
2 *	5138.250	11.48	39.05	50.53	54.00	-3.47	AVG	

**REMARKS:**

- (1) Measurement Value = Reading Level + Correct Factor.
- (2) Margin Level = Measurement Value - Limit Value.



Orthogonal Axis	X		
Test Mode	UNII-1_TX AX (HE20) Mode 5200 MHz	RU configuration	242/61

### Horizontal

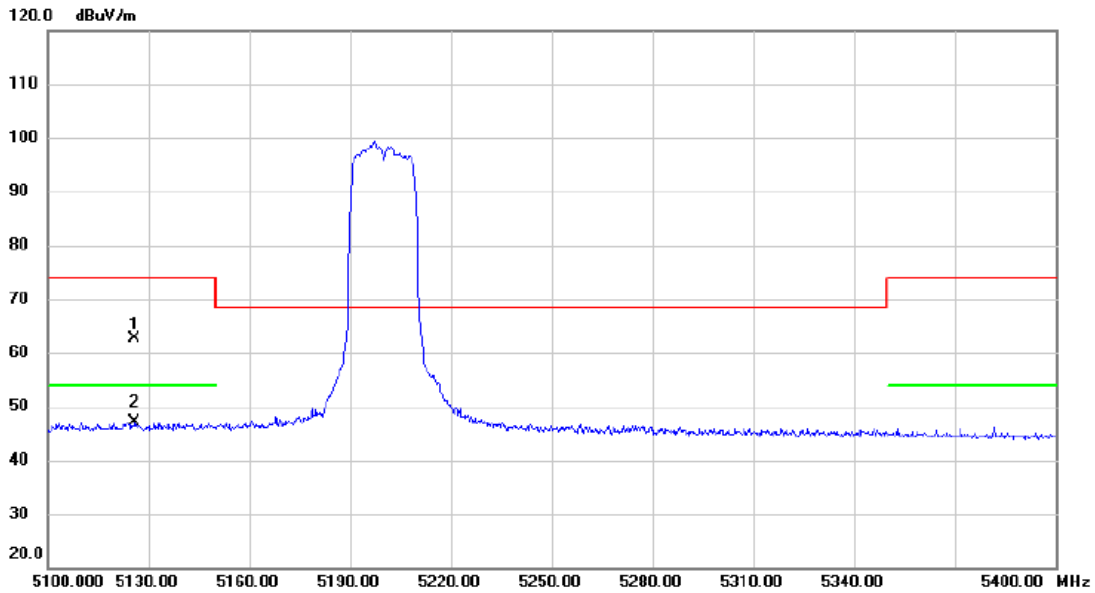

No.	Mk.	Freq. MHz	Reading Level dBuV	Correct Factor dB	Measure- ment dBuV/m	Limit dBuV/m	Margin dB	Detector	Comment
1		5125.800	23.57	39.04	62.61	74.00	-11.39	peak	
2	*	5125.800	8.08	39.04	47.12	54.00	-6.88	AVG	

**REMARKS:**

- (1) Measurement Value = Reading Level + Correct Factor.
- (2) Margin Level = Measurement Value - Limit Value.

Orthogonal Axis	X		
Test Mode	UNII-1_TX AX (HE20) Mode 5200 MHz	RU configuration	242/61

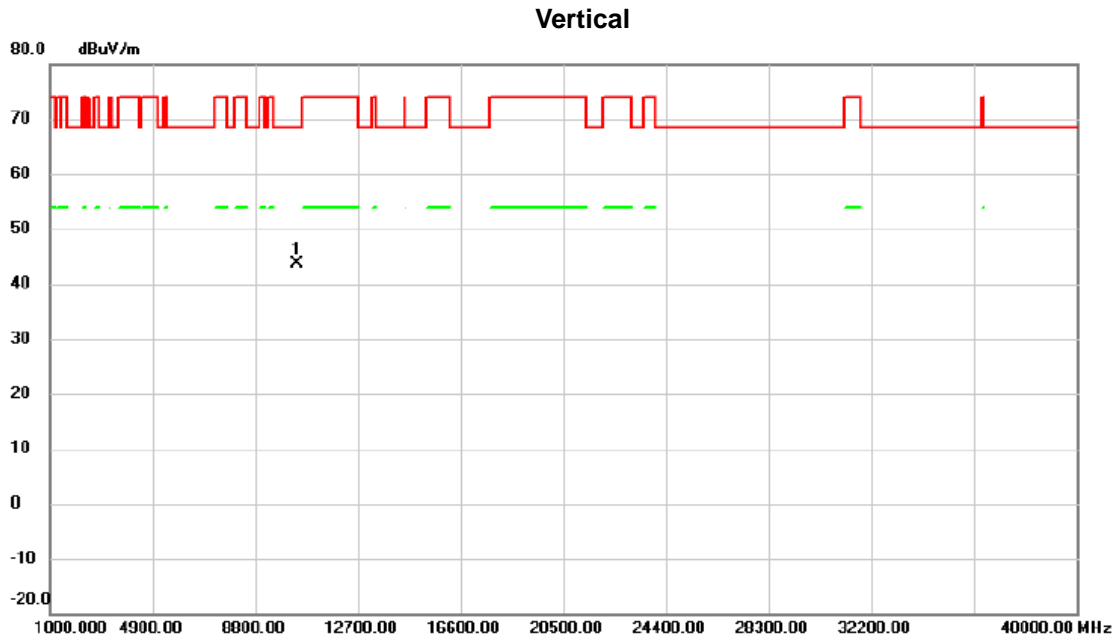

No.	Mk.	Freq.	Reading Level	Correct Factor	Measurement	Limit	Margin	Detector	Comment
		MHz	dBuV	dB	dBuV/m	dBuV/m	dB		
1	*	10400.00	44.97	-1.45	43.52	68.30	-24.78	peak	

**REMARKS:**

- (1) Measurement Value = Reading Level + Correct Factor.
- (2) Margin Level = Measurement Value - Limit Value.

Orthogonal Axis	X		
Test Mode	UNII-1_TX AX (HE20) Mode 5200 MHz	RU configuration	242/61

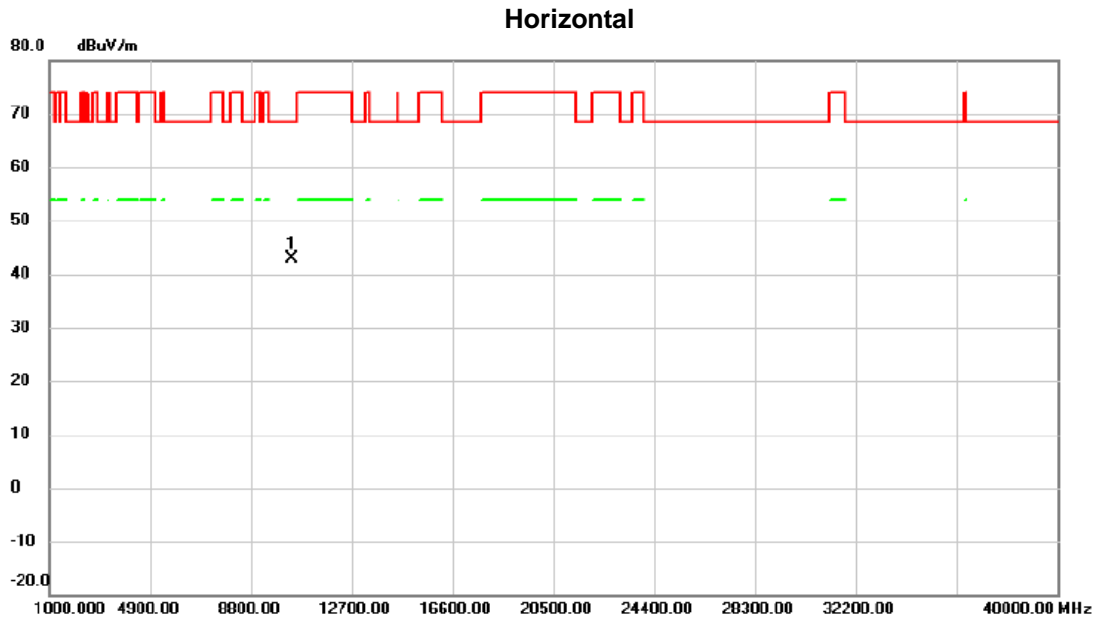

No.	Mk.	Freq.	Reading Level	Correct Factor	Measurement	Limit	Margin	Detector	Comment
		MHz	dBuV	dB	dBuV/m	dBuV/m	dB		
1	*	10400.00	44.34	-1.45	42.89	68.30	-25.41	peak	

**REMARKS:**

- (1) Measurement Value = Reading Level + Correct Factor.
- (2) Margin Level = Measurement Value - Limit Value.

Orthogonal Axis	X		
Test Mode	UNII-1_TX AX (HE20) Mode 5240 MHz	RU configuration	52/37

### Vertical

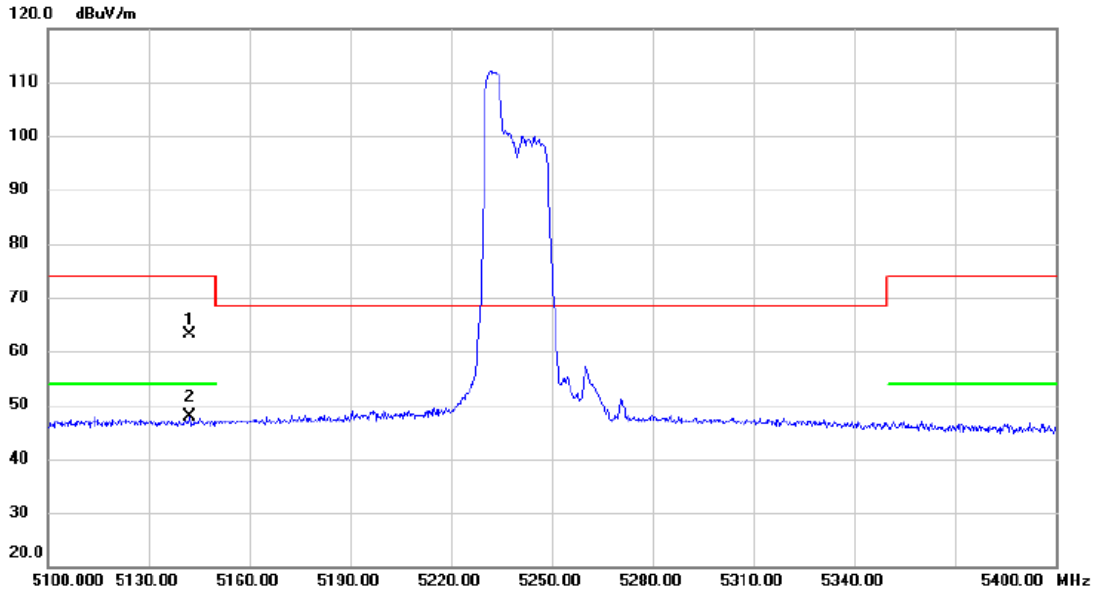

No.	Mk.	Freq.	Reading Level	Correct Factor	Measurement	Limit	Margin	Detector	Comment
		MHz	dBuV	dB	dBuV/m	dBuV/m	dB		
1		5142.150	24.18	39.06	63.24	74.00	-10.76	peak	
2	*	5142.150	8.84	39.06	47.90	54.00	-6.10	AVG	

**REMARKS:**

- (1) Measurement Value = Reading Level + Correct Factor.
- (2) Margin Level = Measurement Value - Limit Value.

Orthogonal Axis	X		
Test Mode	UNII-1_TX AX (HE20) Mode 5240 MHz	RU configuration	52/37

### Horizontal

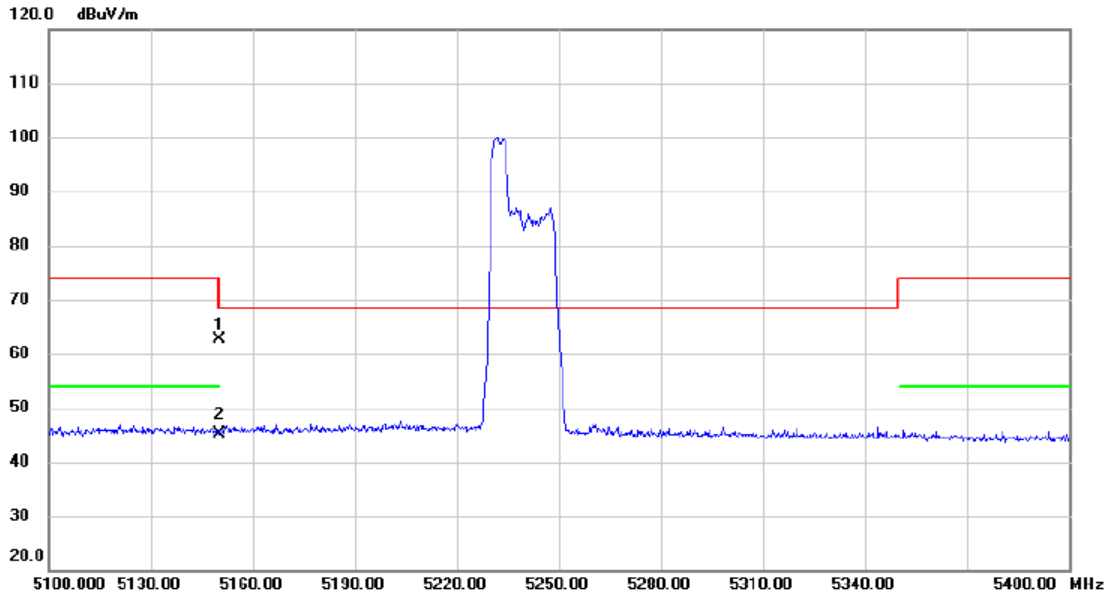

No.	Mk.	Freq.	Reading Level	Correct Factor	Measurement	Limit	Margin	Detector	Comment
		MHz	dBuV	dB	dBuV/m	dBuV/m	dB		
1		5150.000	23.62	39.07	62.69	74.00	-11.31	peak	
2	*	5150.000	6.15	39.07	45.22	54.00	-8.78	AVG	

**REMARKS:**

- (1) Measurement Value = Reading Level + Correct Factor.
- (2) Margin Level = Measurement Value - Limit Value.

Orthogonal Axis	X		
Test Mode	UNII-1_TX AX (HE20) Mode 5240 MHz	RU configuration	106/53

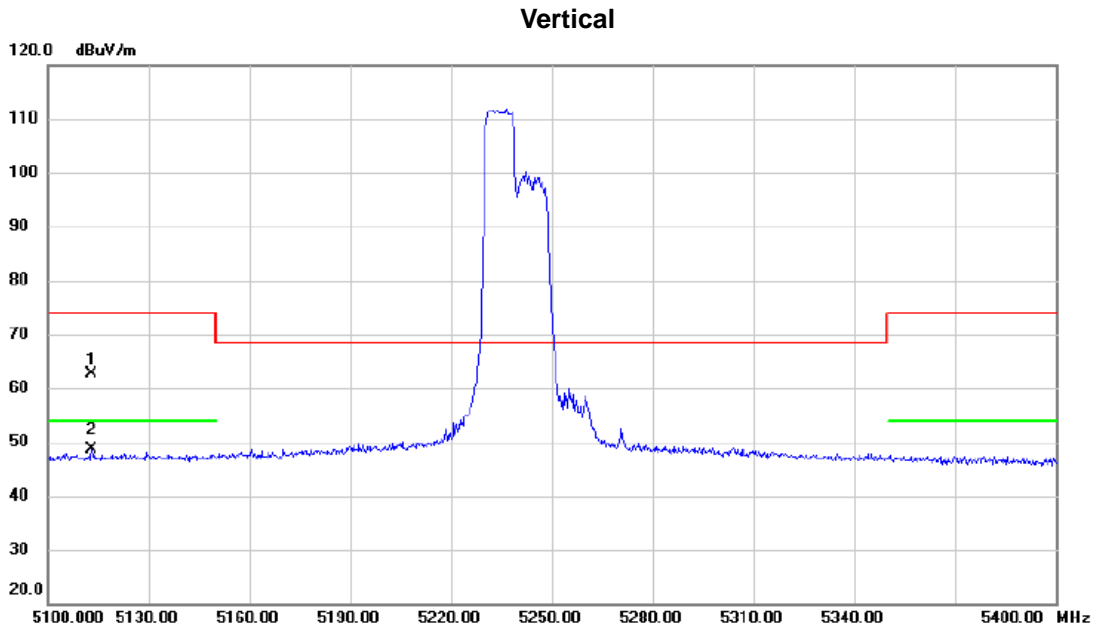

No.	Mk.	Freq. MHz	Reading Level dBuV	Correct Factor dB	Measure- ment dBuV/m	Limit dBuV/m	Margin dB	Detector	Comment
1		5112.900	23.69	39.02	62.71	74.00	-11.29	peak	
2	*	5112.900	9.50	39.02	48.52	54.00	-5.48	AVG	

**REMARKS:**

- (1) Measurement Value = Reading Level + Correct Factor.
- (2) Margin Level = Measurement Value - Limit Value.

Orthogonal Axis	X		
Test Mode	UNII-1_TX AX (HE20) Mode 5240 MHz	RU configuration	106/53

### Horizontal

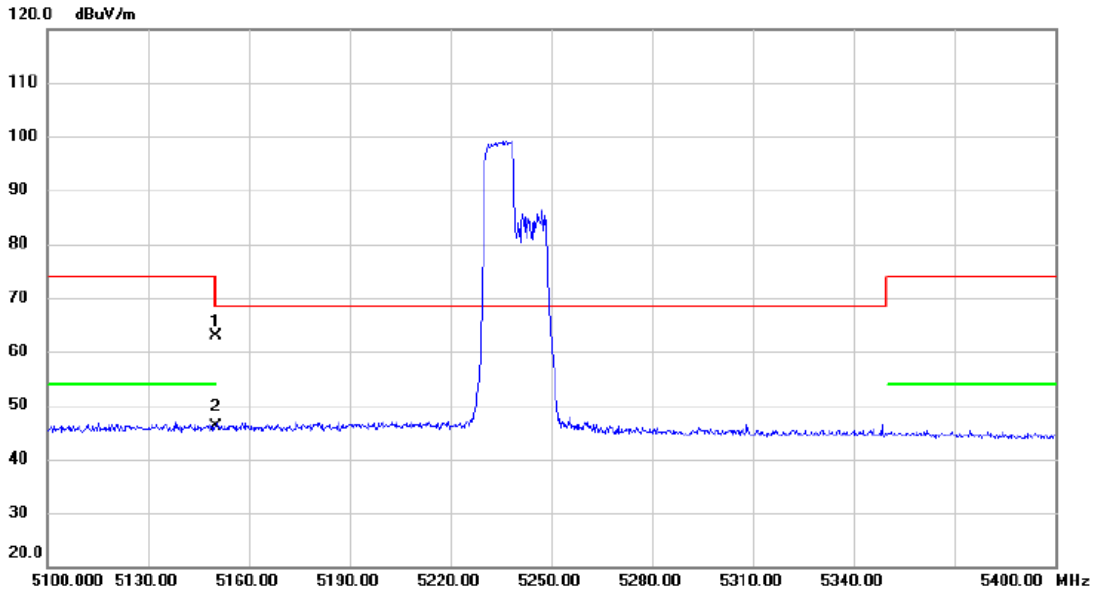

No.	Mk.	Freq. MHz	Reading Level dBuV	Correct Factor dB	Measure- ment dBuV/m	Limit dBuV/m	Margin dB	Detector	Comment
1		5150.000	23.72	39.07	62.79	74.00	-11.21	peak	
2	*	5150.000	7.03	39.07	46.10	54.00	-7.90	AVG	

**REMARKS:**

- (1) Measurement Value = Reading Level + Correct Factor.
- (2) Margin Level = Measurement Value - Limit Value.

Orthogonal Axis	X		
Test Mode	UNII-1_TX AX (HE20) Mode 5240 MHz	RU configuration	242/61

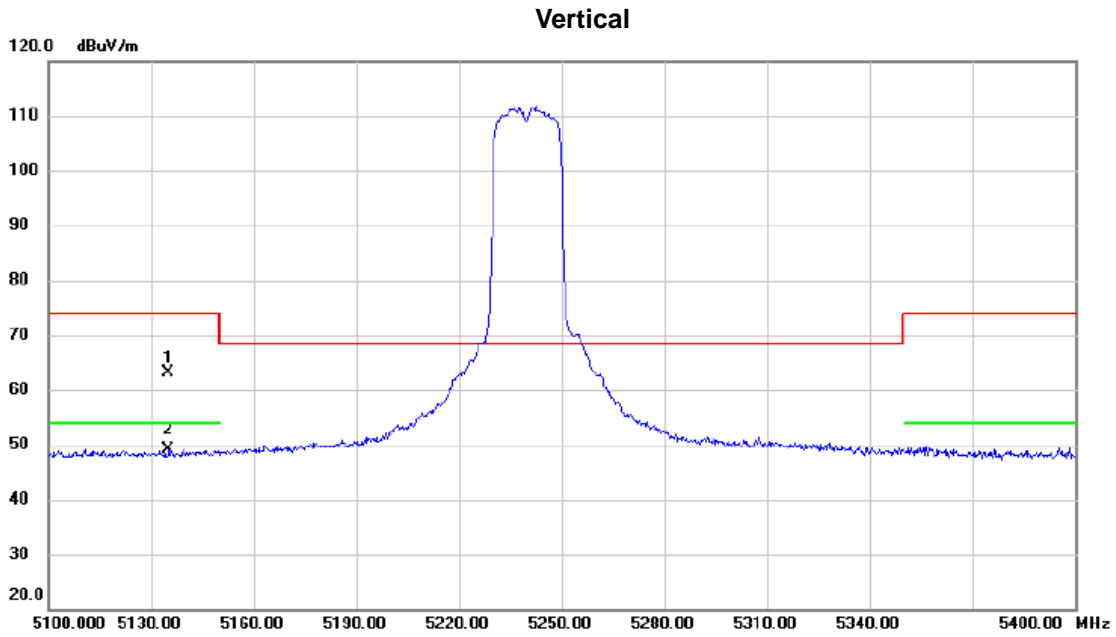

No.	Mk.	Freq. MHz	Reading Level dBuV	Correct Factor dB	Measure- ment dBuV/m	Limit dBuV/m	Margin dB	Detector	Comment
1		5135.100	24.17	39.05	63.22	74.00	-10.78	peak	
2	*	5135.100	10.10	39.05	49.15	54.00	-4.85	AVG	

**REMARKS:**

- (1) Measurement Value = Reading Level + Correct Factor.
- (2) Margin Level = Measurement Value - Limit Value.



Orthogonal Axis	X		
Test Mode	UNII-1_TX AX (HE20) Mode 5240 MHz	RU configuration	242/61

### Horizontal

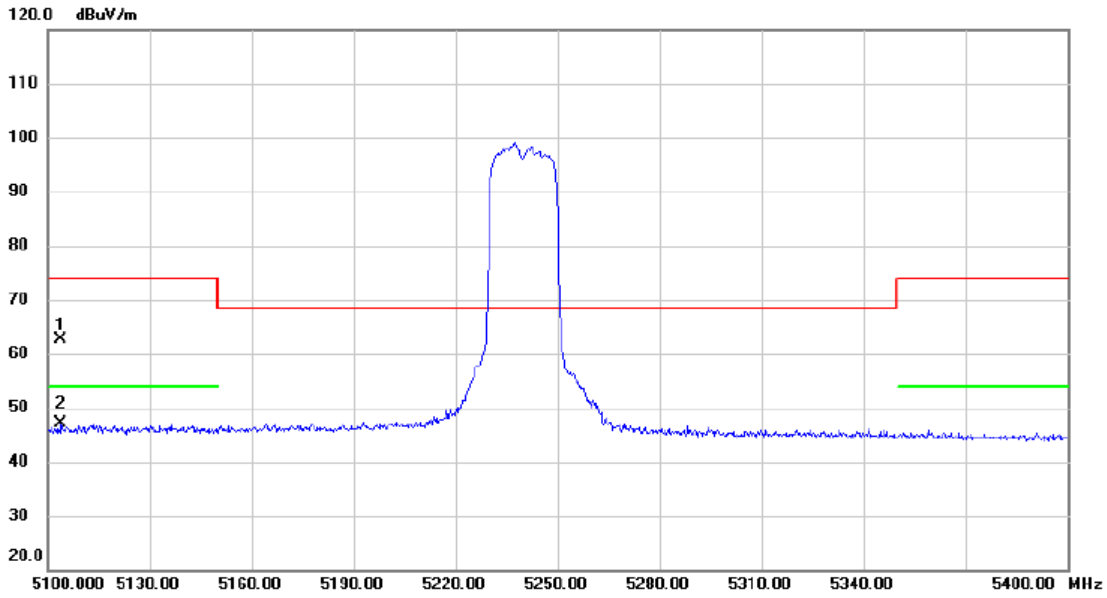

No.	Mk.	Freq. MHz	Reading Level dBuV	Correct Factor dB	Measure- ment dBuV/m	Limit dBuV/m	Margin dB	Detector	Comment
1		5103.900	23.67	39.01	62.68	74.00	-11.32	peak	
2	*	5103.900	8.13	39.01	47.14	54.00	-6.86	AVG	

**REMARKS:**

- (1) Measurement Value = Reading Level + Correct Factor.
- (2) Margin Level = Measurement Value - Limit Value.

Orthogonal Axis	X		
Test Mode	UNII-1_TX AX (HE20) Mode 5240 MHz	RU configuration	242/61

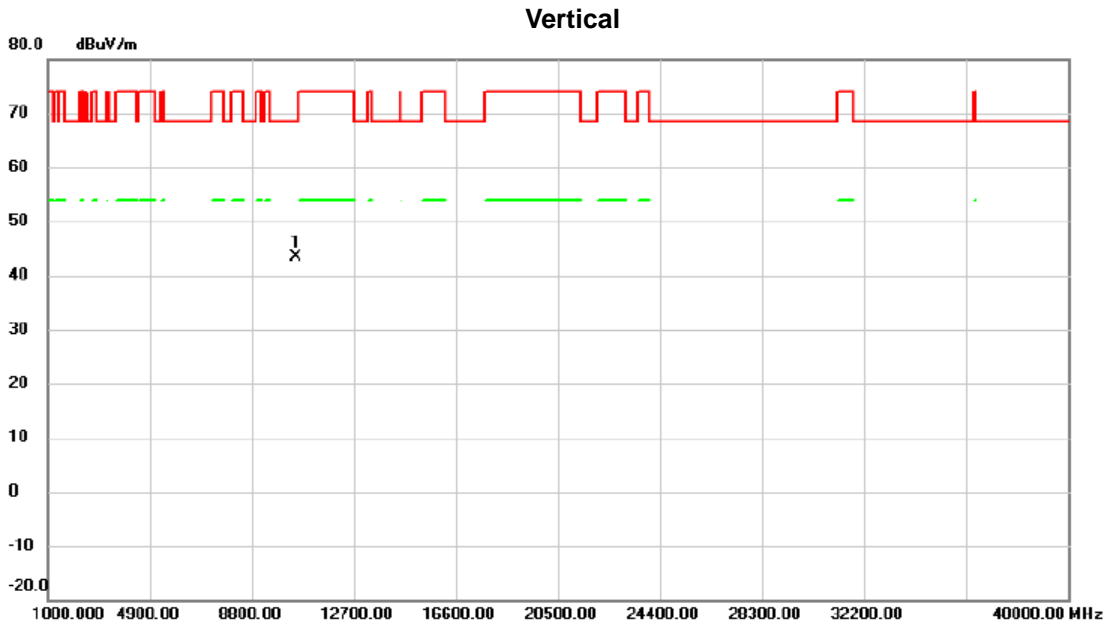

No.	Mk.	Freq.	Reading Level	Correct Factor	Measurement	Limit	Margin	Detector	Comment
		MHz	dBuV	dB	dBuV/m	dBuV/m	dB		
1	*	10480.00	44.89	-1.47	43.42	68.30	-24.88	peak	

**REMARKS:**

- (1) Measurement Value = Reading Level + Correct Factor.
- (2) Margin Level = Measurement Value - Limit Value.

Orthogonal Axis	X		
Test Mode	UNII-1_TX AX (HE20) Mode 5240 MHz	RU configuration	242/61

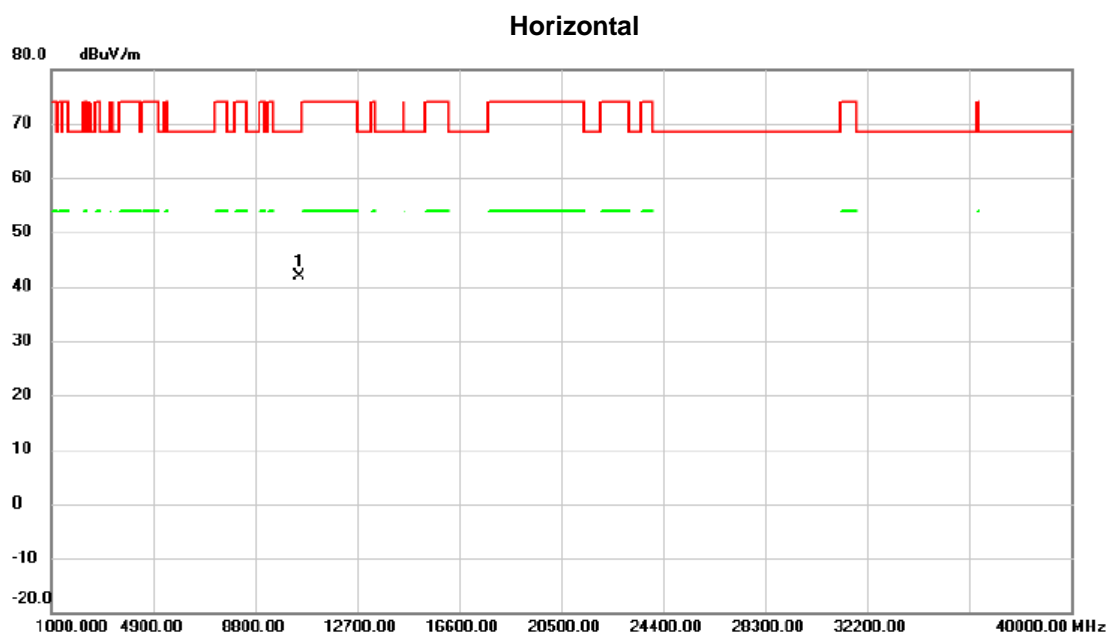

No.	Mk.	Freq. MHz	Reading Level dBuV	Correct Factor dB	Measure- ment dBuV/m	Limit dBuV/m	Margin dB	Detector	Comment
1	*	10480.00	43.34	-1.47	41.87	68.30	-26.43	peak	

**REMARKS:**

- (1) Measurement Value = Reading Level + Correct Factor.
- (2) Margin Level = Measurement Value - Limit Value.

Orthogonal Axis	X		
Test Mode	UNII-2A_TX AX (HE20) Mode 5260 MHz	RU configuration	52/40

### Vertical

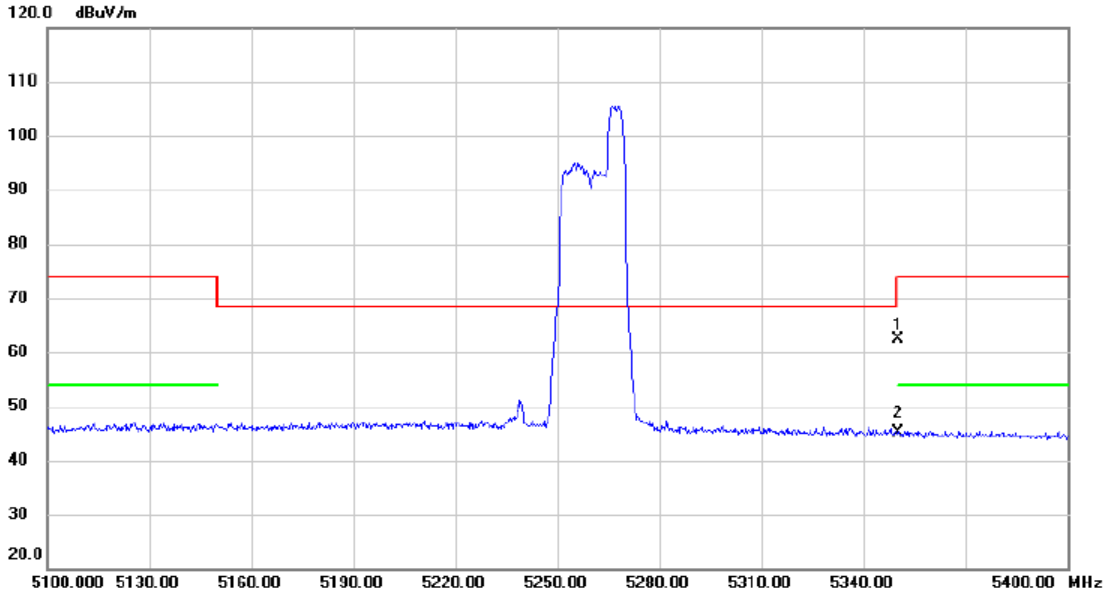

No.	Mk.	Freq. MHz	Reading Level dBuV	Correct Factor dB	Measure- ment dBuV/m	Limit dBuV/m	Margin dB	Detector	Comment
1		5350.000	23.16	39.32	62.48	74.00	-11.52	peak	
2	*	5350.000	5.80	39.32	45.12	54.00	-8.88	AVG	

**REMARKS:**

- (1) Measurement Value = Reading Level + Correct Factor.
- (2) Margin Level = Measurement Value - Limit Value.

Orthogonal Axis	X		
Test Mode	UNII-2A_TX AX (HE20) Mode 5260 MHz	RU configuration	52/40

### Horizontal

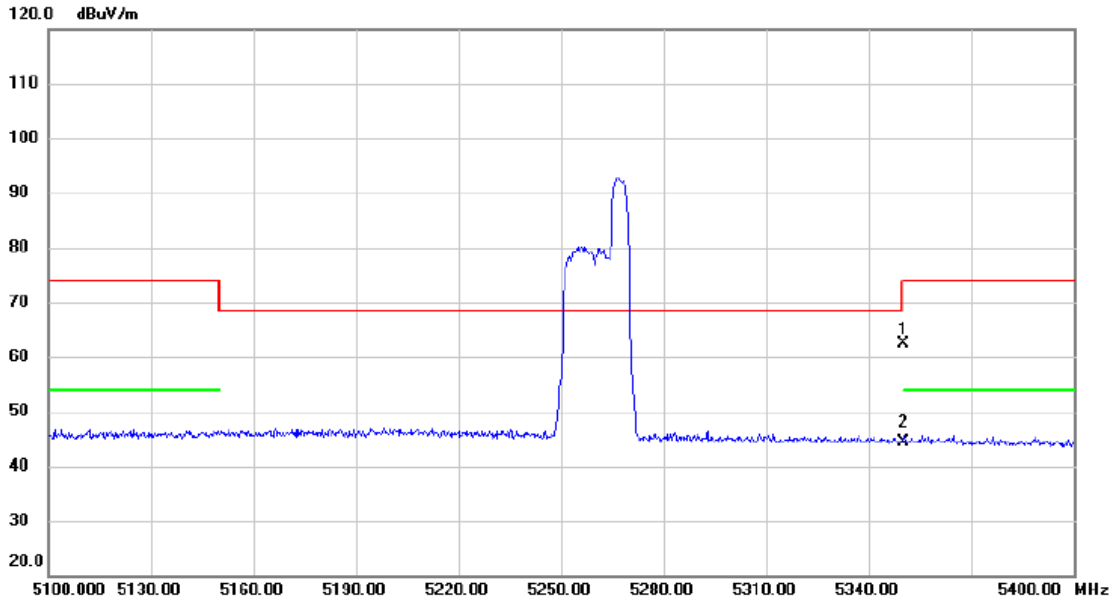

No.	Mk.	Freq. MHz	Reading Level dBuV	Correct Factor dB	Measure- ment dBuV/m	Limit dBuV/m	Margin dB	Detector	Comment
1		5350.000	23.17	39.32	62.49	74.00	-11.51	peak	
2	*	5350.000	5.15	39.32	44.47	54.00	-9.53	AVG	

**REMARKS:**

- (1) Measurement Value = Reading Level + Correct Factor.
- (2) Margin Level = Measurement Value - Limit Value.

Orthogonal Axis	X		
Test Mode	UNII-2A_TX AX (HE20) Mode 5260 MHz	RU configuration	106/54

### Vertical

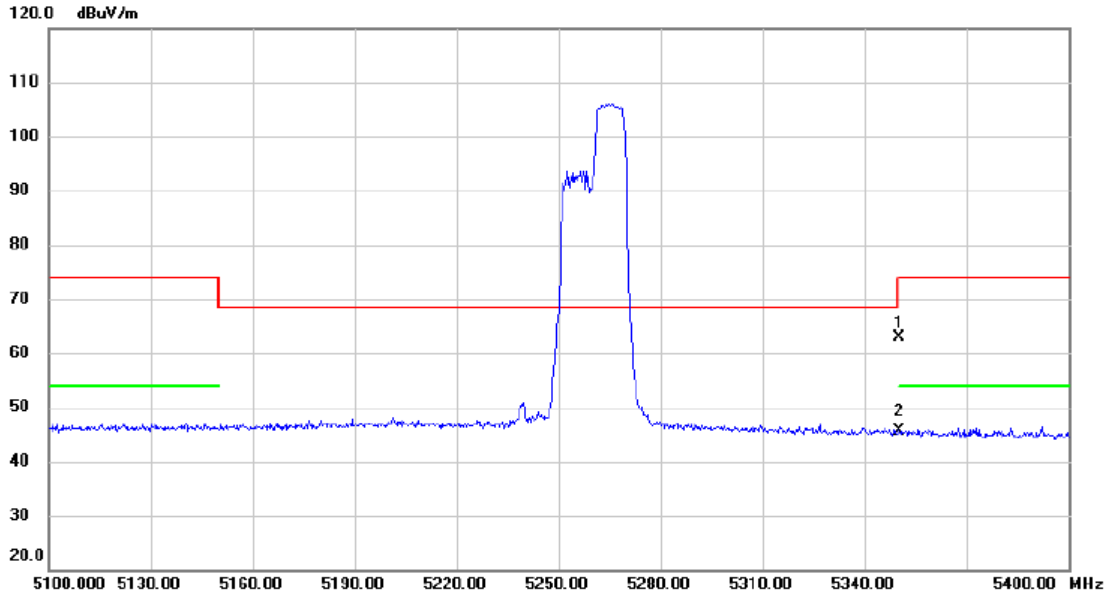

No.	Mk.	Freq. MHz	Reading Level dBuV	Correct Factor dB	Measure- ment dBuV/m	Limit dBuV/m	Margin dB	Detector	Comment
1		5350.000	23.55	39.32	62.87	74.00	-11.13	peak	
2	*	5350.000	6.34	39.32	45.66	54.00	-8.34	AVG	

**REMARKS:**

- (1) Measurement Value = Reading Level + Correct Factor.
- (2) Margin Level = Measurement Value - Limit Value.

Orthogonal Axis	X		
Test Mode	UNII-2A_TX AX (HE20) Mode 5260 MHz	RU configuration	106/54

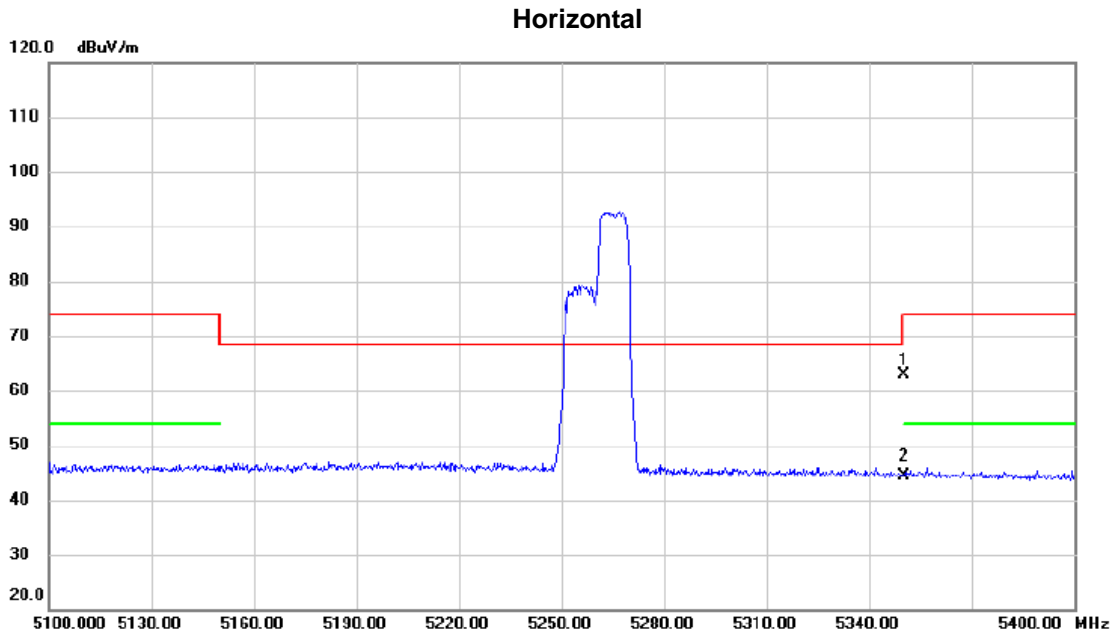

No.	Mk.	Freq. MHz	Reading Level dBuV	Correct Factor dB	Measure- ment dBuV/m	Limit dBuV/m	Margin dB	Detector	Comment
1		5350.000	23.61	39.32	62.93	74.00	-11.07	peak	
2	*	5350.000	5.02	39.32	44.34	54.00	-9.66	AVG	

**REMARKS:**

- (1) Measurement Value = Reading Level + Correct Factor.
- (2) Margin Level = Measurement Value - Limit Value.

Orthogonal Axis	X		
Test Mode	UNII-2A_TX AX (HE20) Mode 5260 MHz	RU configuration	242/61

### Vertical

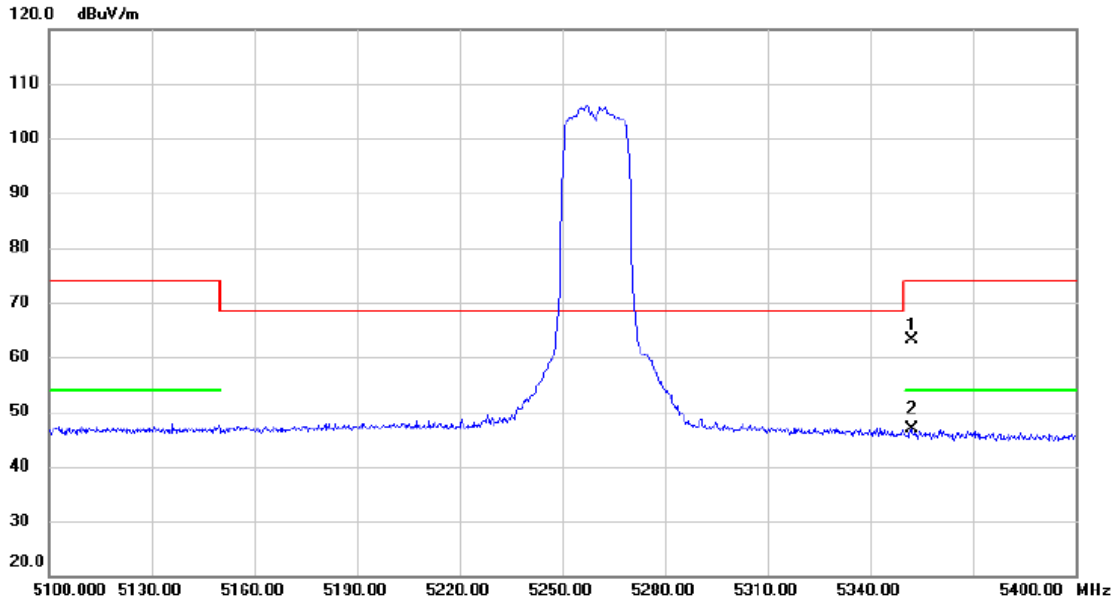

No.	Mk.	Freq. MHz	Reading Level dBuV	Correct Factor dB	Measure- ment dBuV/m	Limit dBuV/m	Margin dB	Detector	Comment
1		5352.000	23.69	39.32	63.01	74.00	-10.99	peak	
2	*	5352.000	7.62	39.32	46.94	54.00	-7.06	AVG	

**REMARKS:**

- (1) Measurement Value = Reading Level + Correct Factor.
- (2) Margin Level = Measurement Value - Limit Value.



Orthogonal Axis	X		
Test Mode	UNII-2A_TX AX (HE20) Mode 5260 MHz	RU configuration	242/61

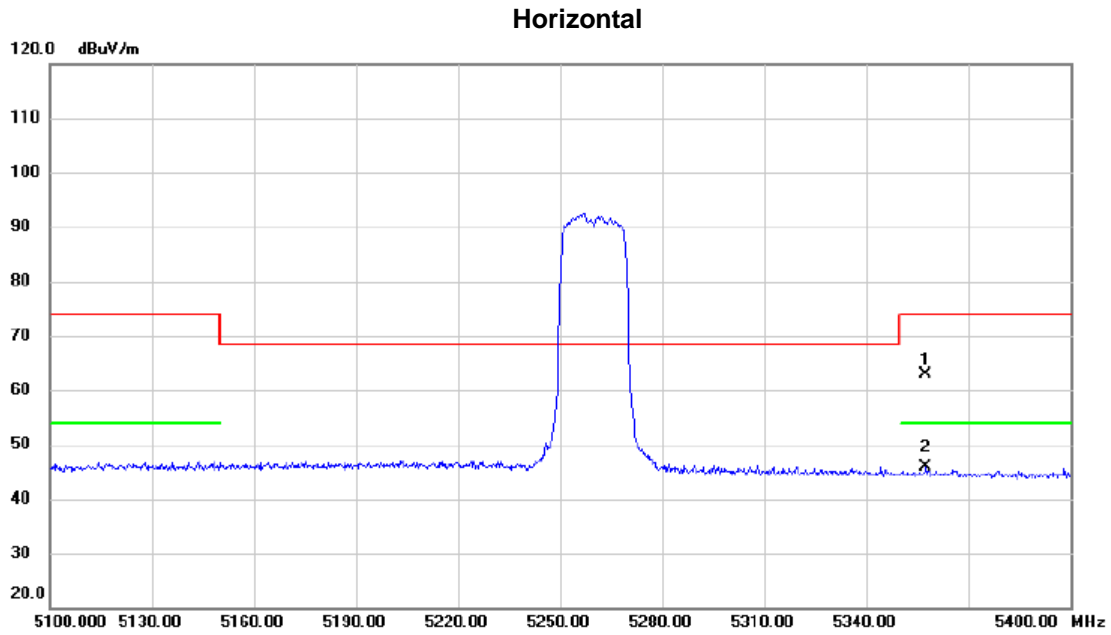

No.	Mk.	Freq. MHz	Reading Level dBuV	Correct Factor dB	Measure- ment dBuV/m	Limit dBuV/m	Margin dB	Detector	Comment
1		5357.550	23.58	39.33	62.91	74.00	-11.09	peak	
2	*	5357.550	6.62	39.33	45.95	54.00	-8.05	AVG	

**REMARKS:**

- (1) Measurement Value = Reading Level + Correct Factor.
- (2) Margin Level = Measurement Value - Limit Value.

Orthogonal Axis	X		
Test Mode	UNII-2A_TX AX (HE20) Mode 5260 MHz	RU configuration	242/61

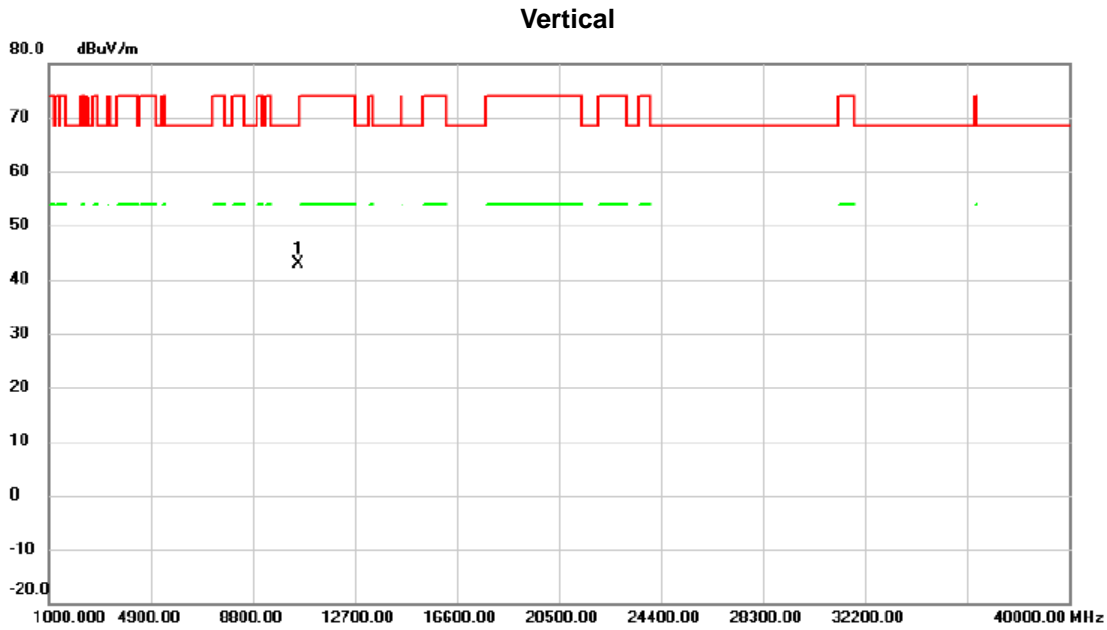

No.	Mk.	Freq.	Reading Level	Correct Factor	Measurement	Limit	Margin	Detector	Comment
		MHz	dBuV	dB	dBuV/m	dBuV/m	dB		
1	*	10520.00	44.19	-1.36	42.83	68.30	-25.47	peak	

**REMARKS:**

- (1) Measurement Value = Reading Level + Correct Factor.
- (2) Margin Level = Measurement Value - Limit Value.

Orthogonal Axis	X		
Test Mode	UNII-2A_TX AX (HE20) Mode 5260 MHz	RU configuration	242/61

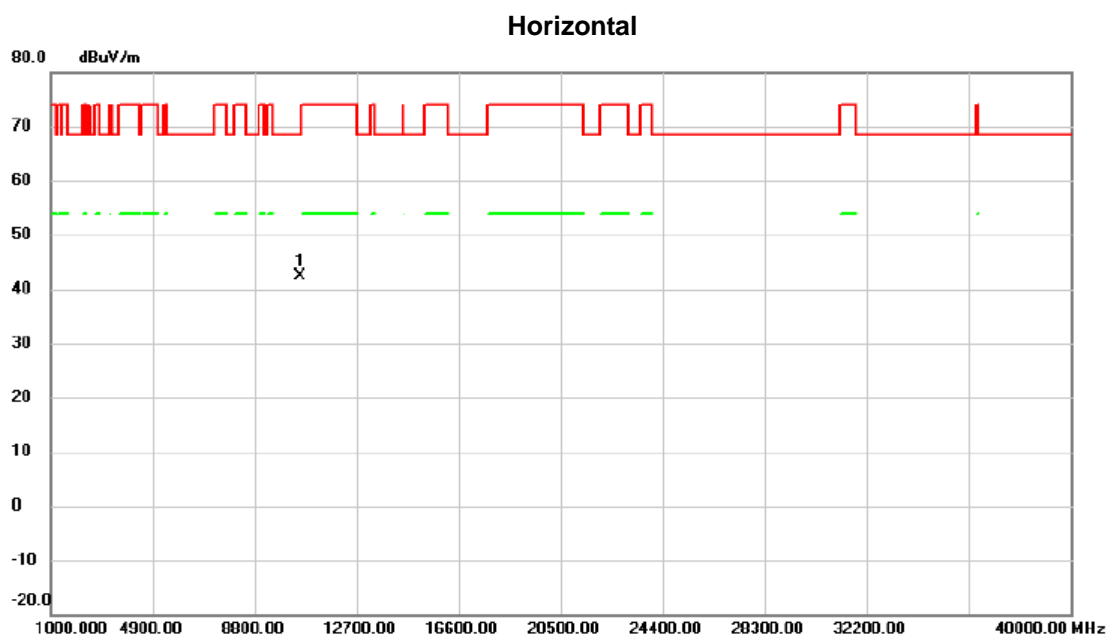

No.	Mk.	Freq. MHz	Reading Level dBuV	Correct Factor dB	Measure- ment dBuV/m	Limit dBuV/m	Margin dB	Detector	Comment
1	*	10520.00	43.81	-1.36	42.45	68.30	-25.85	peak	

**REMARKS:**

- (1) Measurement Value = Reading Level + Correct Factor.
- (2) Margin Level = Measurement Value - Limit Value.

Orthogonal Axis	X		
Test Mode	UNII-2A_TX AX (HE20) Mode 5300 MHz	RU configuration	52/40

### Vertical

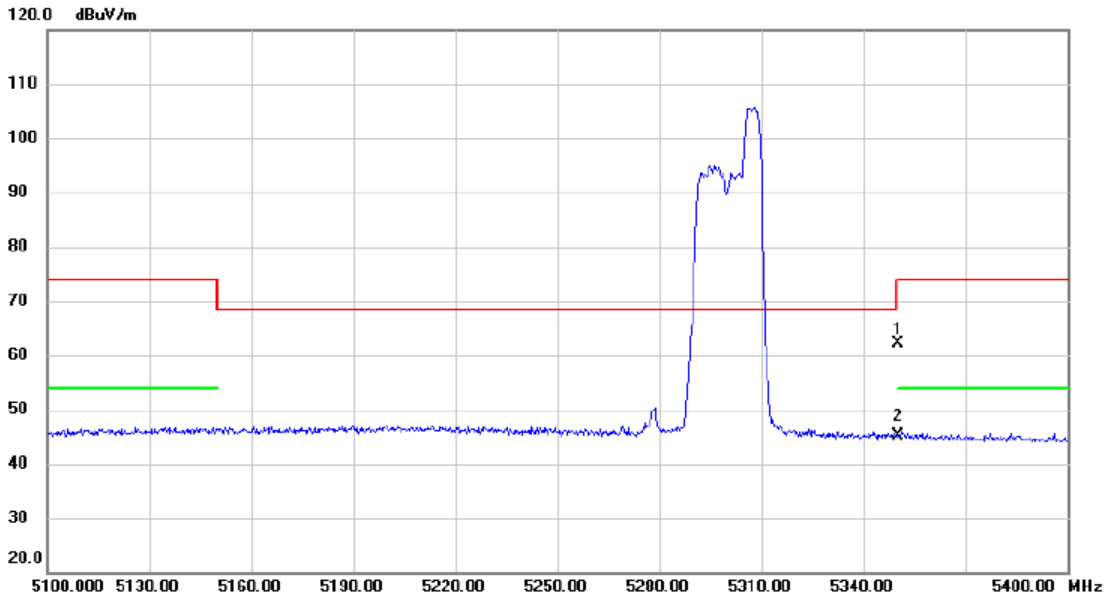

No.	Mk.	Freq. MHz	Reading Level dBuV	Correct Factor dB	Measure- ment dBuV/m	Limit dBuV/m	Margin dB	Detector	Comment
1		5350.000	22.84	39.32	62.16	74.00	-11.84	peak	
2	*	5350.000	5.90	39.32	45.22	54.00	-8.78	AVG	

**REMARKS:**

- (1) Measurement Value = Reading Level + Correct Factor.
- (2) Margin Level = Measurement Value - Limit Value.

Orthogonal Axis	X		
Test Mode	UNII-2A_TX AX (HE20) Mode 5300 MHz	RU configuration	52/40

### Horizontal

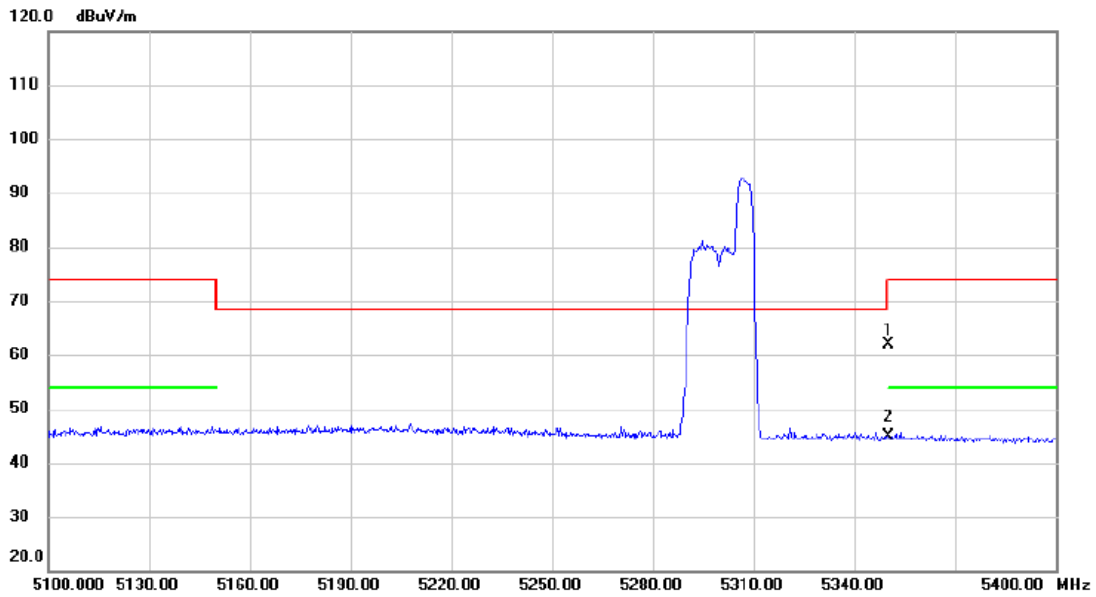

No.	Mk.	Freq. MHz	Reading Level dBuV	Correct Factor dB	Measure- ment dBuV/m	Limit dBuV/m	Margin dB	Detector	Comment
1		5350.000	22.59	39.32	61.91	74.00	-12.09	peak	
2	*	5350.000	5.59	39.32	44.91	54.00	-9.09	AVG	

**REMARKS:**

- (1) Measurement Value = Reading Level + Correct Factor.
- (2) Margin Level = Measurement Value - Limit Value.

Orthogonal Axis	X		
Test Mode	UNII-2A_TX AX (HE20) Mode 5300 MHz	RU configuration	106/54

### Vertical

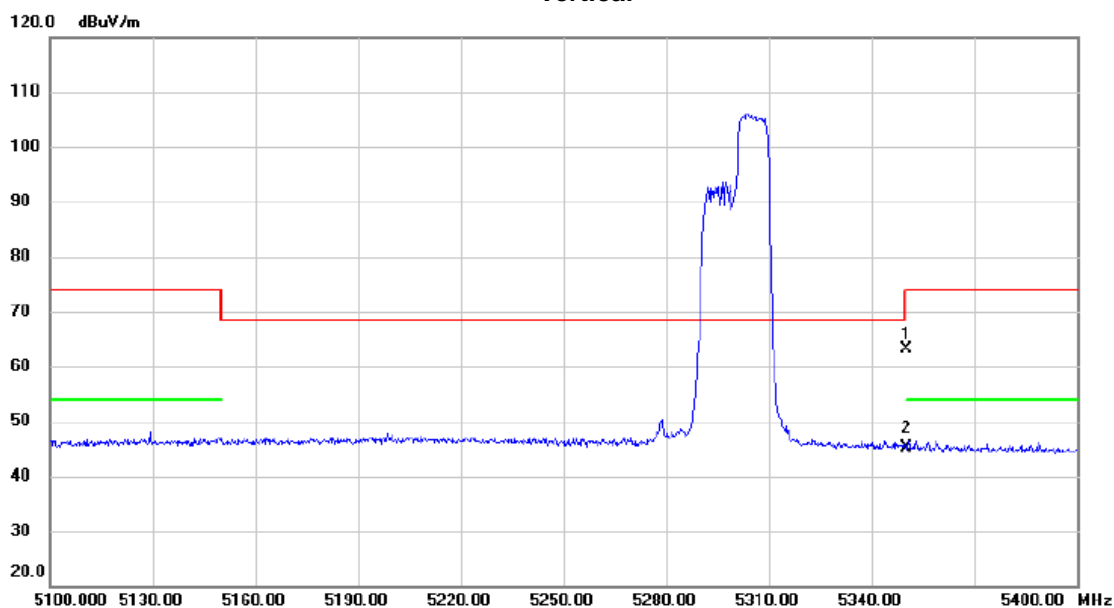

No.	Mk.	Freq. MHz	Reading Level dBuV	Correct Factor dB	Measure- ment dBuV/m	Limit dBuV/m	Margin dB	Detector	Comment
1		5350.000	23.82	39.32	63.14	74.00	-10.86	peak	
2	*	5350.000	5.77	39.32	45.09	54.00	-8.91	AVG	

**REMARKS:**

- (1) Measurement Value = Reading Level + Correct Factor.
- (2) Margin Level = Measurement Value - Limit Value.

Orthogonal Axis	X		
Test Mode	UNII-2A_TX AX (HE20) Mode 5300 MHz	RU configuration	106/54

### Horizontal

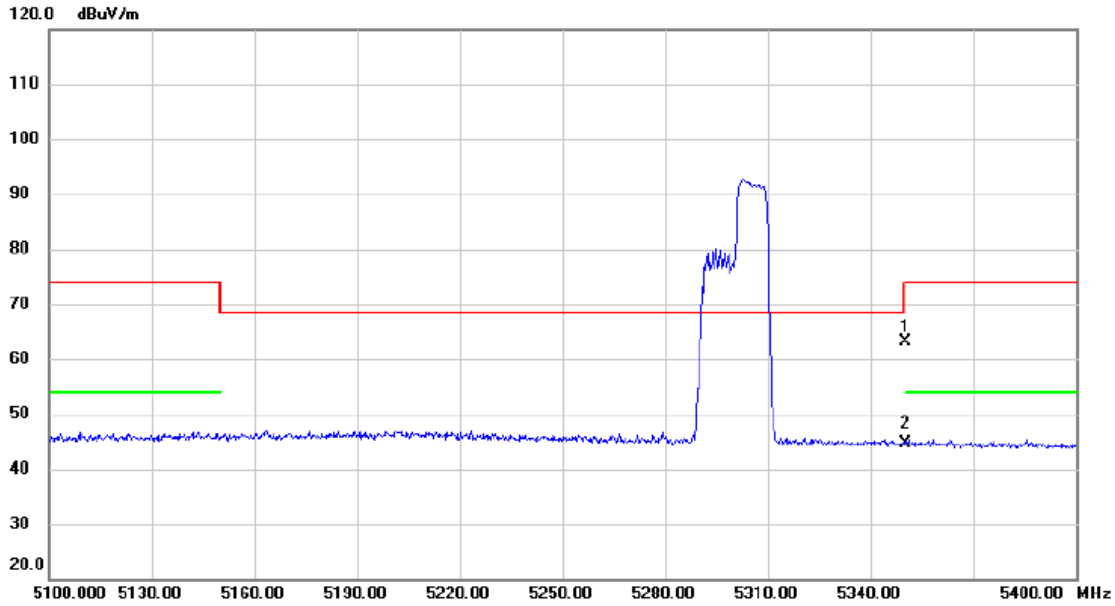

No.	Mk.	Freq. MHz	Reading Level dBuV	Correct Factor dB	Measure- ment dBuV/m	Limit dBuV/m	Margin dB	Detector	Comment
1		5350.000	23.92	39.32	63.24	74.00	-10.76	peak	
2	*	5350.000	5.26	39.32	44.58	54.00	-9.42	AVG	

**REMARKS:**

- (1) Measurement Value = Reading Level + Correct Factor.
- (2) Margin Level = Measurement Value - Limit Value.

Orthogonal Axis	X		
Test Mode	UNII-2A_TX AX (HE20) Mode 5300 MHz	RU configuration	242/61

### Vertical

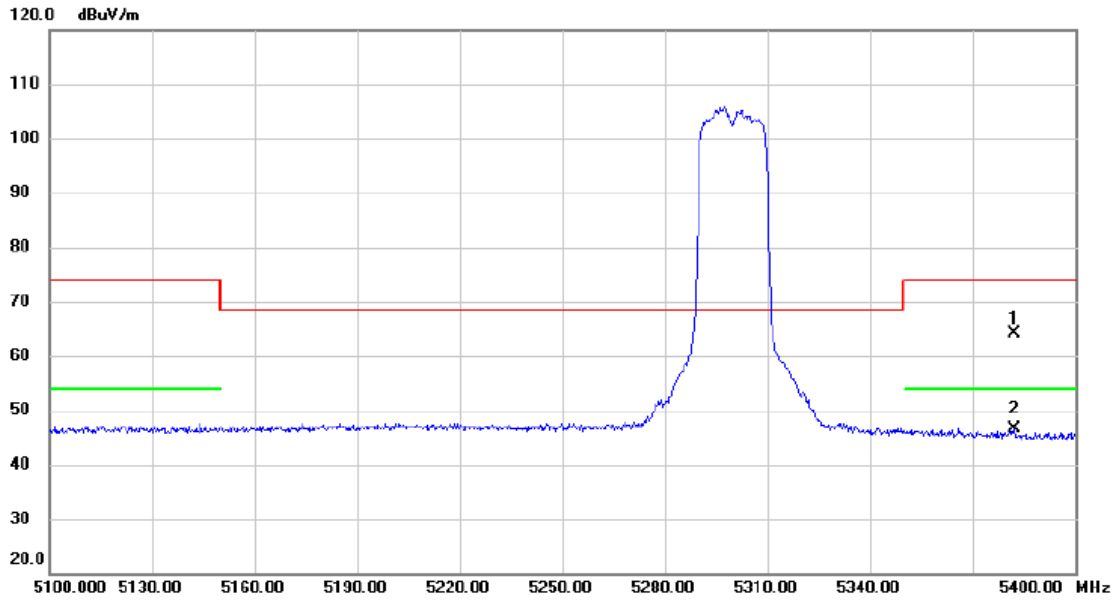

No.	Mk.	Freq.	Reading Level	Correct Factor	Measurement	Limit	Margin	Detector	Comment
		MHz	dBuV	dB	dBuV/m	dBuV/m	dB		
1		5382.000	24.83	39.36	64.19	74.00	-9.81	peak	
2	*	5382.000	7.39	39.36	46.75	54.00	-7.25	AVG	

**REMARKS:**

- (1) Measurement Value = Reading Level + Correct Factor.
- (2) Margin Level = Measurement Value - Limit Value.



Orthogonal Axis	X		
Test Mode	UNII-2A_TX AX (HE20) Mode 5300 MHz	RU configuration	242/61

### Horizontal

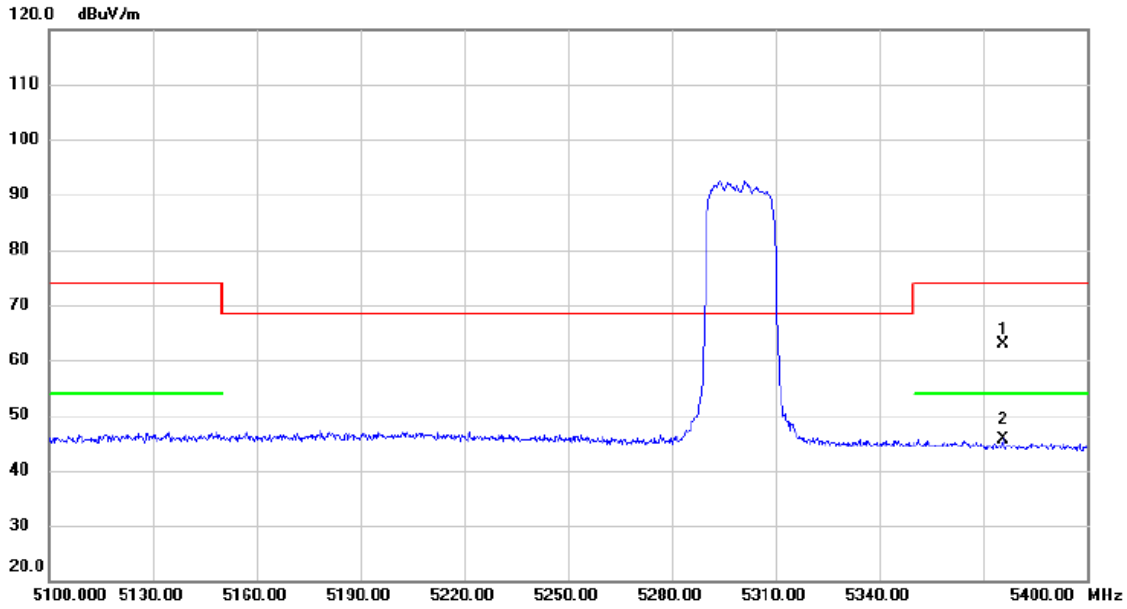

No.	Mk.	Freq. MHz	Reading Level dBuV	Correct Factor dB	Measure- ment dBuV/m	Limit dBuV/m	Margin dB	Detector	Comment
1		5375.700	23.49	39.36	62.85	74.00	-11.15	peak	
2	*	5375.700	6.39	39.36	45.75	54.00	-8.25	AVG	

**REMARKS:**

- (1) Measurement Value = Reading Level + Correct Factor.
- (2) Margin Level = Measurement Value - Limit Value.

Orthogonal Axis	X		
Test Mode	UNII-2A_TX AX (HE20) Mode 5300 MHz	RU configuration	242/61

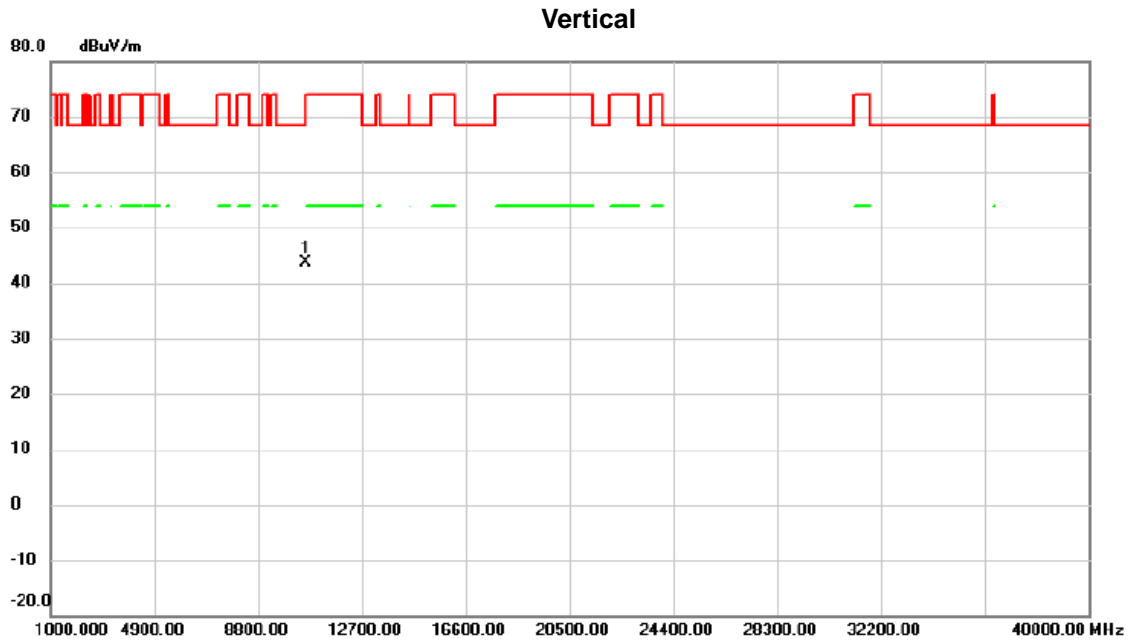

No.	Mk.	Freq. MHz	Reading Level dBuV	Correct Factor dB	Measure- ment dBuV/m	Limit dBuV/m	Margin dB	Detector	Comment
1	*	10600.00	44.50	-0.97	43.53	68.30	-24.77	peak	

**REMARKS:**

- (1) Measurement Value = Reading Level + Correct Factor.
- (2) Margin Level = Measurement Value - Limit Value.

Orthogonal Axis	X		
Test Mode	UNII-2A_TX AX (HE20) Mode 5300 MHz	RU configuration	242/61

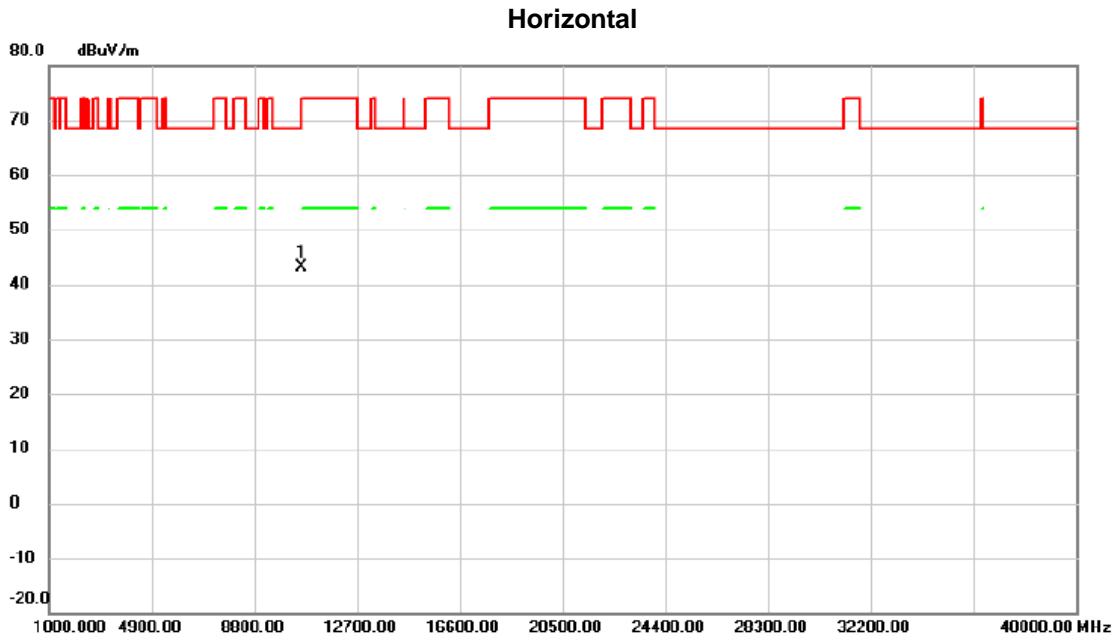

No.	Mk.	Freq. MHz	Reading Level dBuV	Correct Factor dB	Measure- ment dBuV/m	Limit dBuV/m	Margin dB	Detector	Comment
1	*	10600.00	44.15	-0.97	43.18	68.30	-25.12	peak	

**REMARKS:**

- (1) Measurement Value = Reading Level + Correct Factor.
- (2) Margin Level = Measurement Value - Limit Value.

Orthogonal Axis	X		
Test Mode	UNII-2A_TX AX (HE20) Mode 5320 MHz	RU configuration	52/40

### Vertical

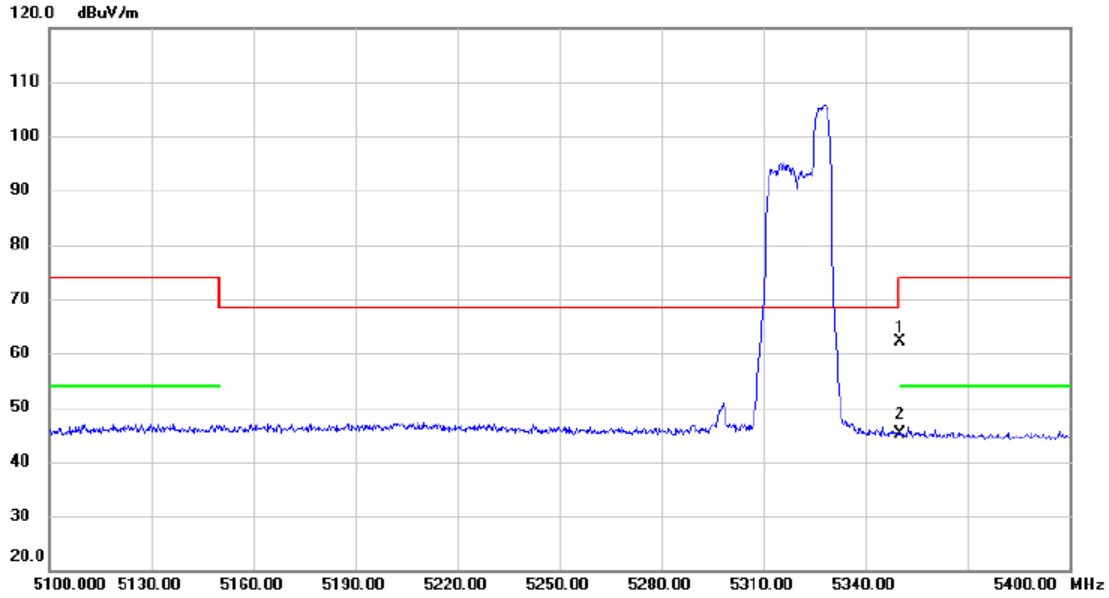

No.	Mk.	Freq. MHz	Reading Level dBuV	Correct Factor dB	Measure- ment dBuV/m	Limit dBuV/m	Margin dB	Detector	Comment
1		5350.000	22.73	39.32	62.05	74.00	-11.95	peak	
2	*	5350.000	5.84	39.32	45.16	54.00	-8.84	AVG	

**REMARKS:**

- (1) Measurement Value = Reading Level + Correct Factor.
- (2) Margin Level = Measurement Value - Limit Value.

Orthogonal Axis	X		
Test Mode	UNII-2A_TX AX (HE20) Mode 5320 MHz	RU configuration	52/40

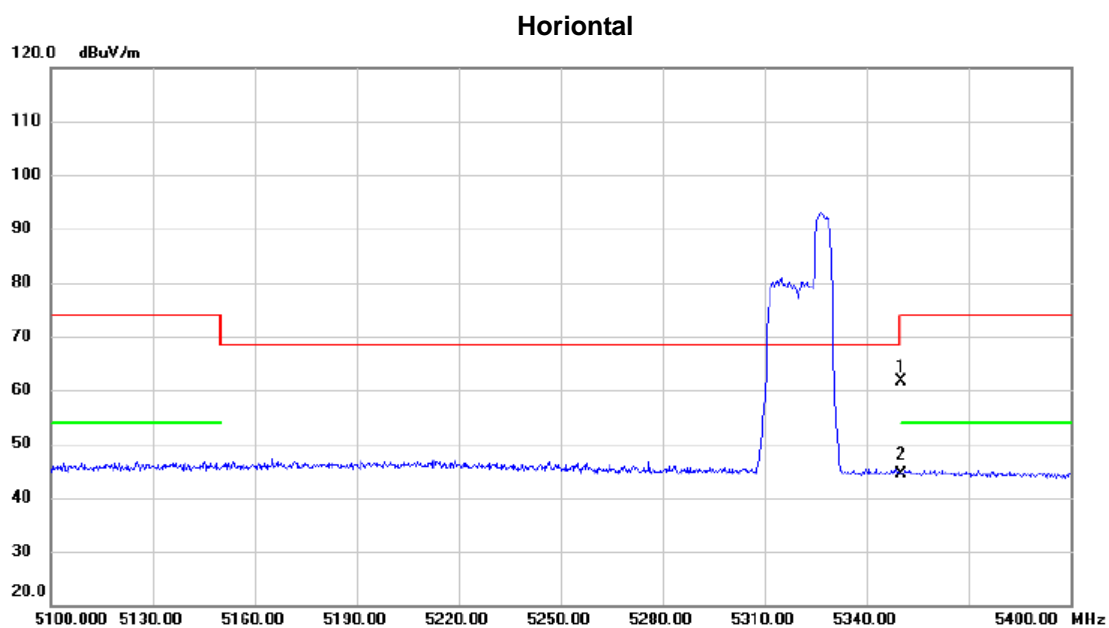

No. Mk.	Freq. MHz	Reading Level dBuV	Correct Factor dB	Measure- ment dBuV/m	Limit dBuV/m	Margin dB	Detector	Comment
1	5350.000	22.35	39.32	61.67	74.00	-12.33	peak	
2 *	5350.000	5.15	39.32	44.47	54.00	-9.53	AVG	

**REMARKS:**

- (1) Measurement Value = Reading Level + Correct Factor.
- (2) Margin Level = Measurement Value - Limit Value.

Orthogonal Axis	X		
Test Mode	UNII-2A_TX AX (HE20) Mode 5320 MHz	RU configuration	106/54

### Vertical

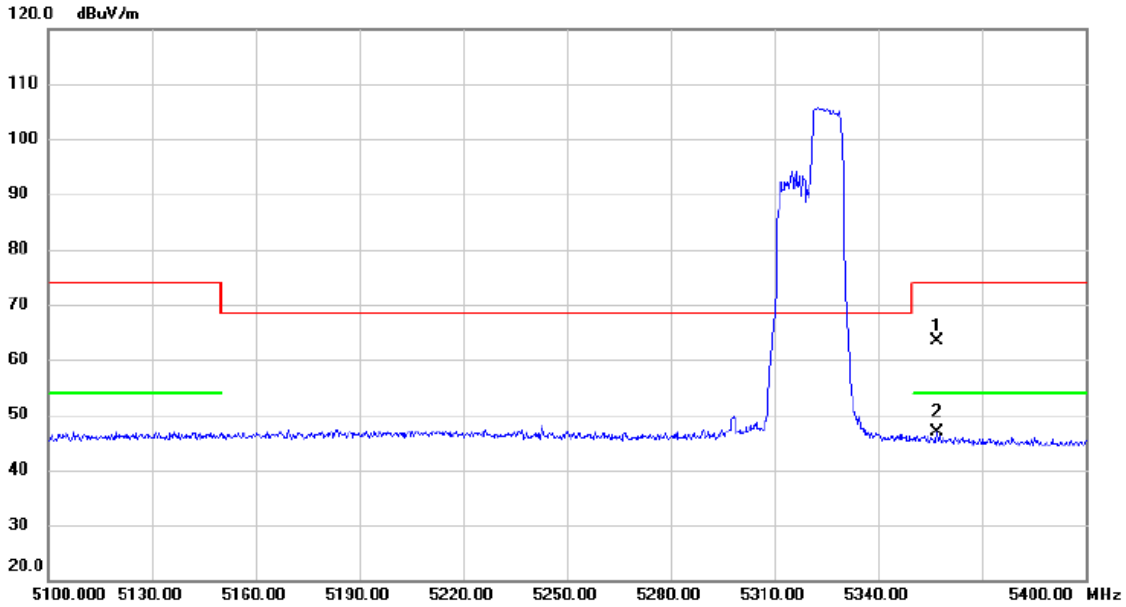

No.	Mk.	Freq. MHz	Reading Level dBuV	Correct Factor dB	Measure- ment dBuV/m	Limit dBuV/m	Margin dB	Detector	Comment
1		5357.100	24.16	39.33	63.49	74.00	-10.51	peak	
2	*	5357.100	7.47	39.33	46.80	54.00	-7.20	AVG	

**REMARKS:**

- (1) Measurement Value = Reading Level + Correct Factor.
- (2) Margin Level = Measurement Value - Limit Value.

Orthogonal Axis	X		
Test Mode	UNII-2A_TX AX (HE20) Mode 5320 MHz	RU configuration	106/54

### Horizontal

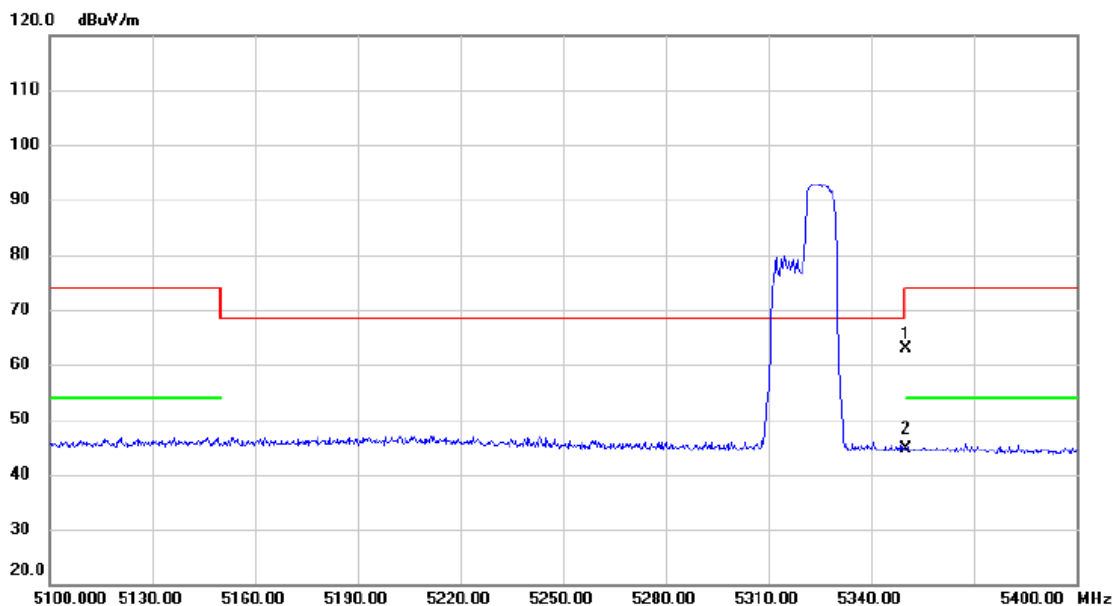

No. Mk.	Freq. MHz	Reading Level dBuV	Correct Factor dB	Measurement dBuV/m	Limit dBuV/m	Margin dB	Detector	Comment
1	5350.000	23.56	39.32	62.88	74.00	-11.12	peak	
2 *	5350.000	5.25	39.32	44.57	54.00	-9.43	AVG	

**REMARKS:**

- (1) Measurement Value = Reading Level + Correct Factor.
- (2) Margin Level = Measurement Value - Limit Value.

Orthogonal Axis	X		
Test Mode	UNII-2A_TX AX (HE20) Mode 5320 MHz	RU configuration	242/61

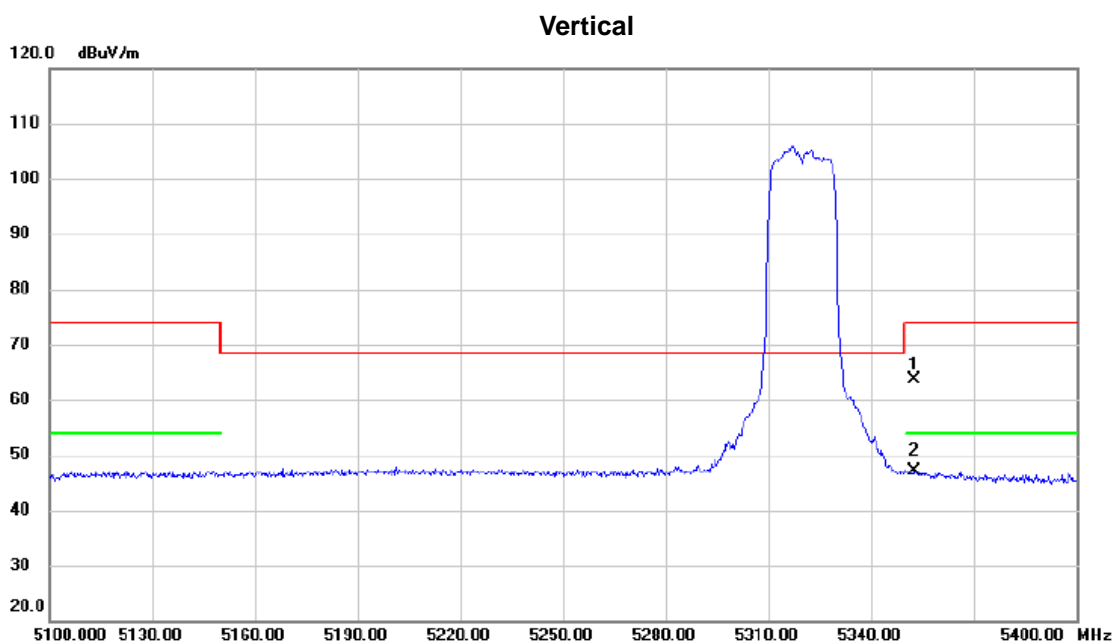

No.	Mk.	Freq. MHz	Reading Level dBuV	Correct Factor dB	Measure- ment dBuV/m	Limit dBuV/m	Margin dB	Detector	Comment
1		5352.750	24.37	39.32	63.69	74.00	-10.31	peak	
2	*	5352.750	7.89	39.32	47.21	54.00	-6.79	AVG	

**REMARKS:**

(1) Measurement Value = Reading Level + Correct Factor.

(2) Margin Level = Measurement Value - Limit Value.



Orthogonal Axis	X		
Test Mode	UNII-2A_TX AX (HE20) Mode 5320 MHz	RU configuration	242/61

### Horizontal

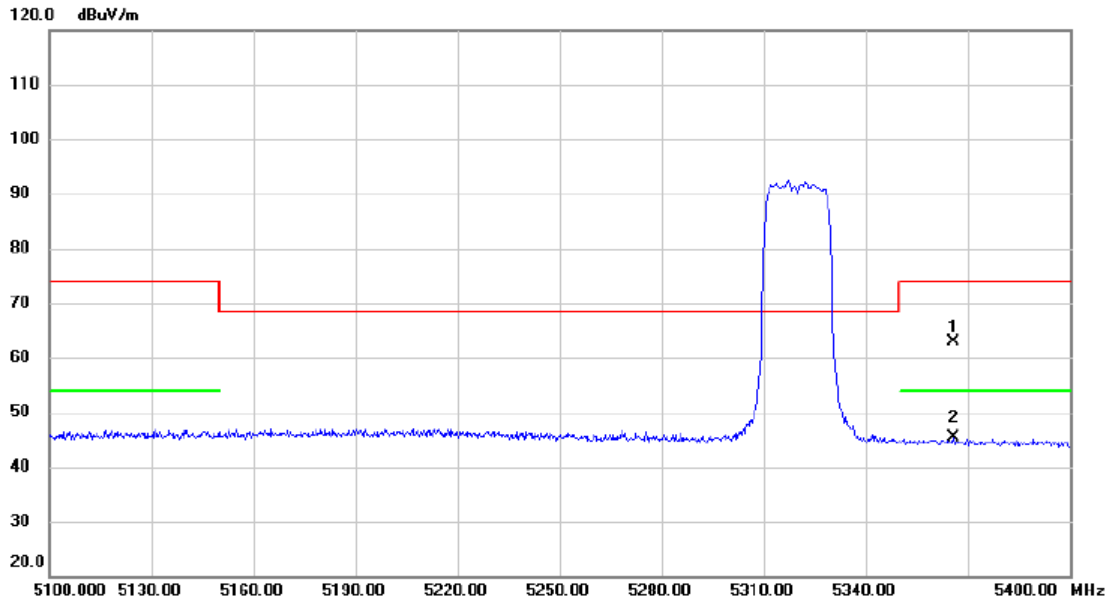

No. Mk.	Freq. MHz	Reading Level dBuV	Correct Factor dB	Measurement dBuV/m	Limit dBuV/m	Margin dB	Detector	Comment
1	5365.650	23.61	39.34	62.95	74.00	-11.05	peak	
2 *	5365.650	6.14	39.34	45.48	54.00	-8.52	AVG	

**REMARKS:**

- (1) Measurement Value = Reading Level + Correct Factor.
- (2) Margin Level = Measurement Value - Limit Value.

Orthogonal Axis	X		
Test Mode	UNII-2A_TX AX (HE20) Mode 5320 MHz	RU configuration	242/61

### Vertical

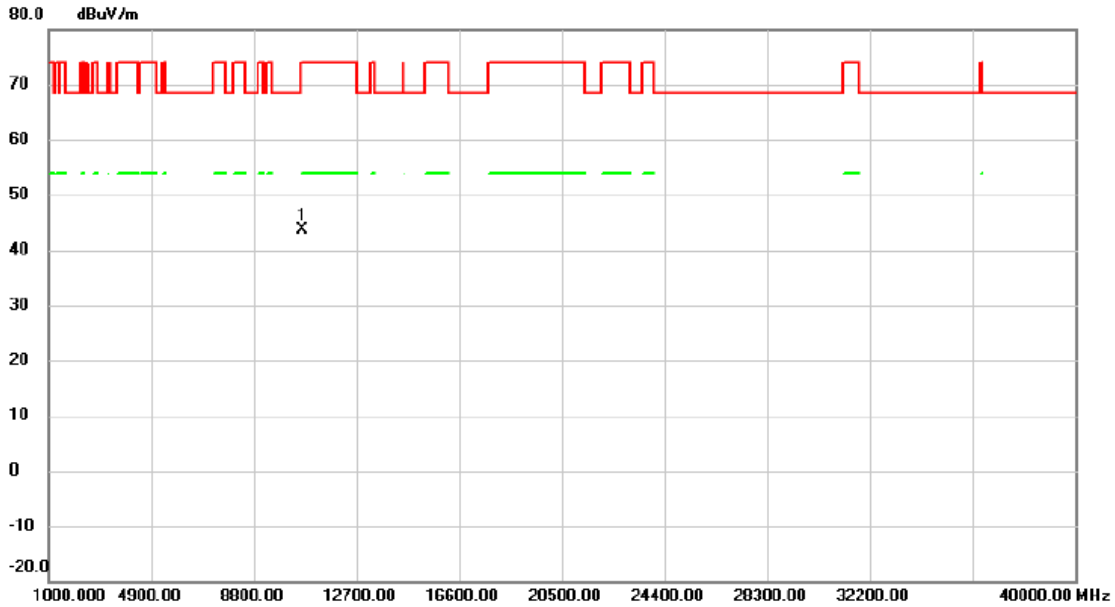

No.	Mk.	Freq.	Reading Level	Correct Factor	Measurement	Limit	Margin	Detector	Comment
		MHz	dBuV	dB	dBuV/m	dBuV/m	dB		
1	*	10640.00	44.47	-0.76	43.71	74.00	-30.29	peak	

**REMARKS:**

- (1) Measurement Value = Reading Level + Correct Factor.
- (2) Margin Level = Measurement Value - Limit Value.

Orthogonal Axis	X		
Test Mode	UNII-2A_TX AX (HE20) Mode 5320 MHz	RU configuration	242/61

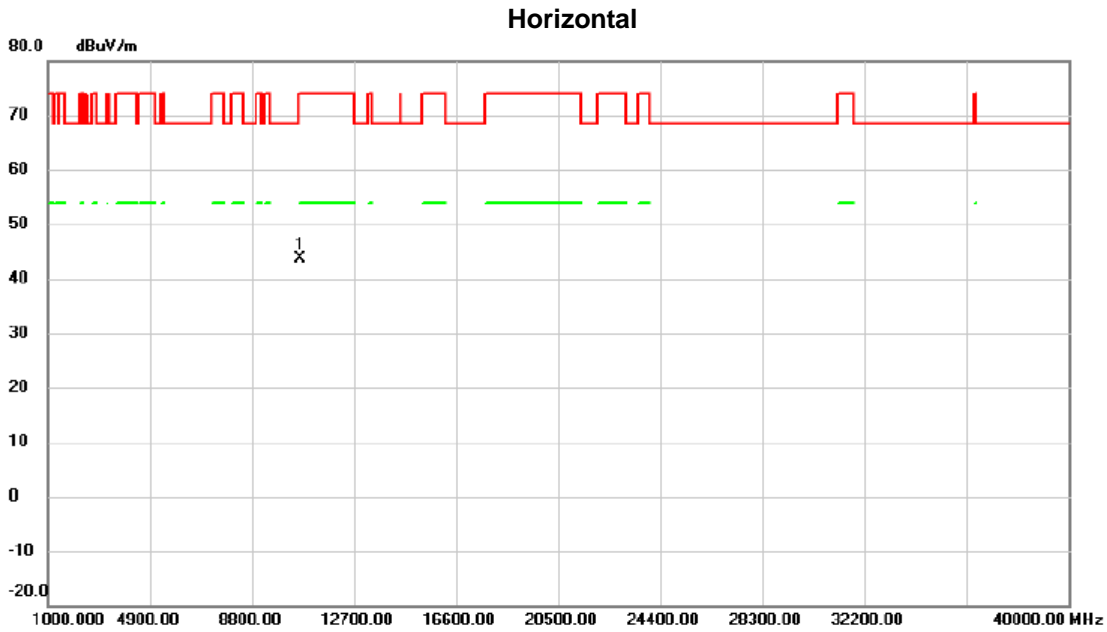

No.	Mk.	Freq. MHz	Reading Level dBuV	Correct Factor dB	Measure- ment dBuV/m	Limit dBuV/m	Margin dB	Detector	Comment
1	*	10640.00	44.47	-0.76	43.71	74.00	-30.29	peak	

**REMARKS:**

(1) Measurement Value = Reading Level + Correct Factor.

(2) Margin Level = Measurement Value - Limit Value.

Orthogonal Axis	X		
Test Mode	UNII-2A_TX AX (HE160) Mode 5250 MHz	RU configuration	242/64

### Vertical

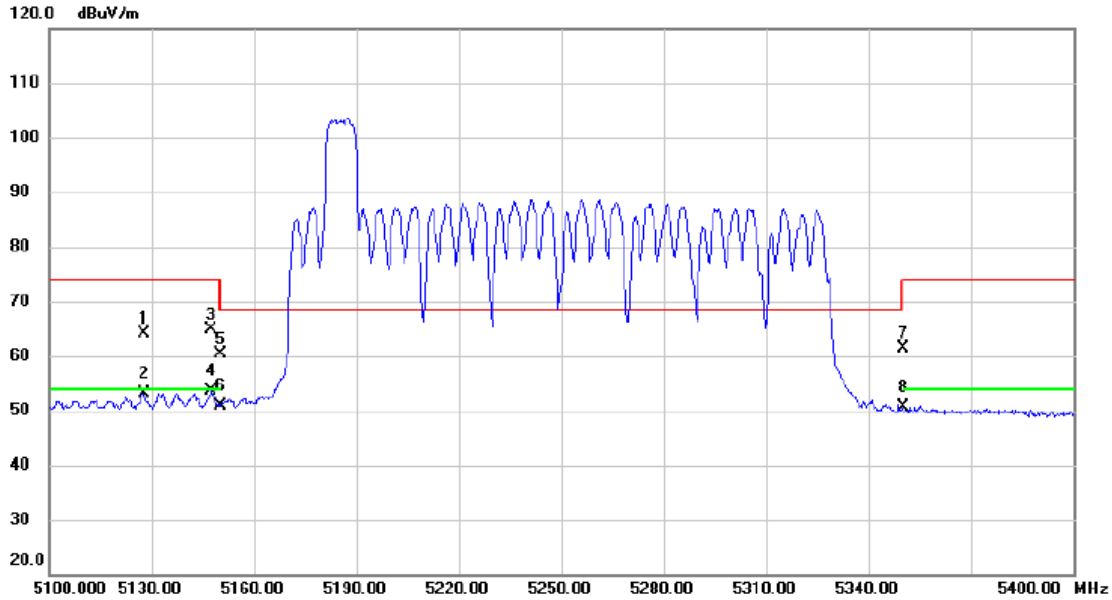

No.	Mk.	Freq. MHz	Reading Level dBuV	Correct Factor dB	Measure- ment dBuV/m	Limit dBuV/m	Margin dB	Detector	Comment
1		5127.600	25.07	39.04	64.11	74.00	-9.89	peak	
2		5127.600	14.20	39.04	53.24	54.00	-0.76	AVG	
3		5147.550	25.78	39.07	64.85	74.00	-9.15	peak	
4	*	5147.550	14.67	39.07	53.74	54.00	-0.26	AVG	
5		5150.000	21.30	39.07	60.37	74.00	-13.63	peak	
6		5150.000	11.80	39.07	50.87	54.00	-3.13	AVG	
7		5350.000	22.08	39.32	61.40	74.00	-12.60	peak	
8		5350.000	11.21	39.32	50.53	54.00	-3.47	AVG	

**REMARKS:**

- (1) Measurement Value = Reading Level + Correct Factor.
- (2) Margin Level = Measurement Value - Limit Value.

Orthogonal Axis	X		
Test Mode	UNII-2A_TX AX (HE160) Mode 5250 MHz	RU configuration	242/64

### Horizontal

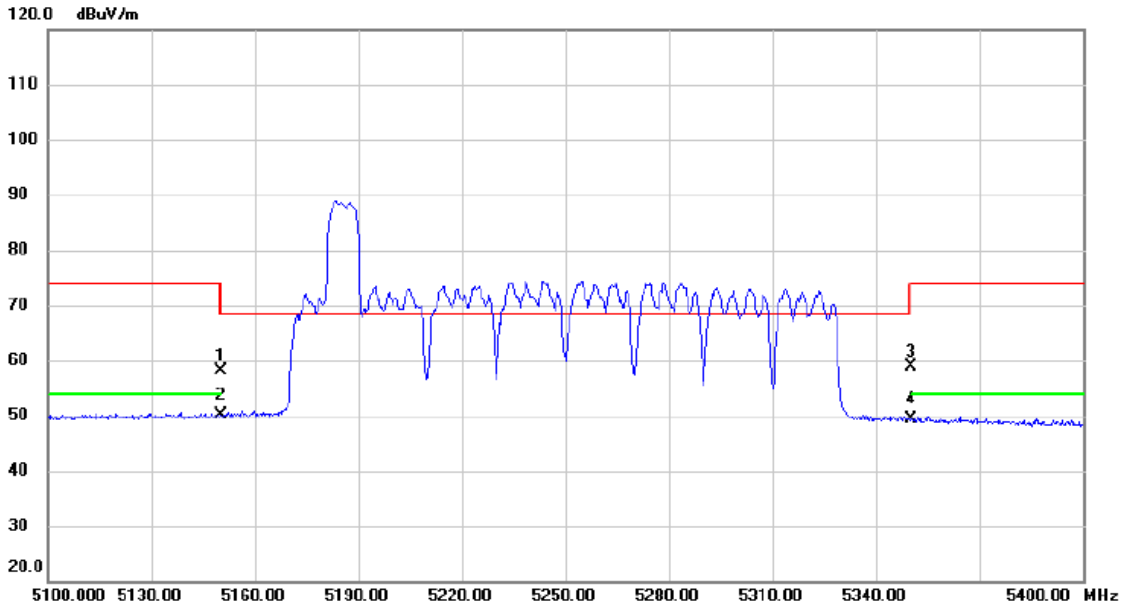

No.	Mk.	Freq. MHz	Reading Level dBuV	Correct Factor dB	Measure- ment dBuV/m	Limit dBuV/m	Margin dB	Detector	Comment
1		5150.000	19.10	39.07	58.17	74.00	-15.83	peak	
2	*	5150.000	10.94	39.07	50.01	54.00	-3.99	AVG	
3		5350.000	19.55	39.32	58.87	74.00	-15.13	peak	
4		5350.000	10.10	39.32	49.42	54.00	-4.58	AVG	

**REMARKS:**

- (1) Measurement Value = Reading Level + Correct Factor.
- (2) Margin Level = Measurement Value - Limit Value.

Orthogonal Axis	X		
Test Mode	UNII-2A_TX AX (HE160) Mode 5250 MHz	RU configuration	484/66

### Vertical

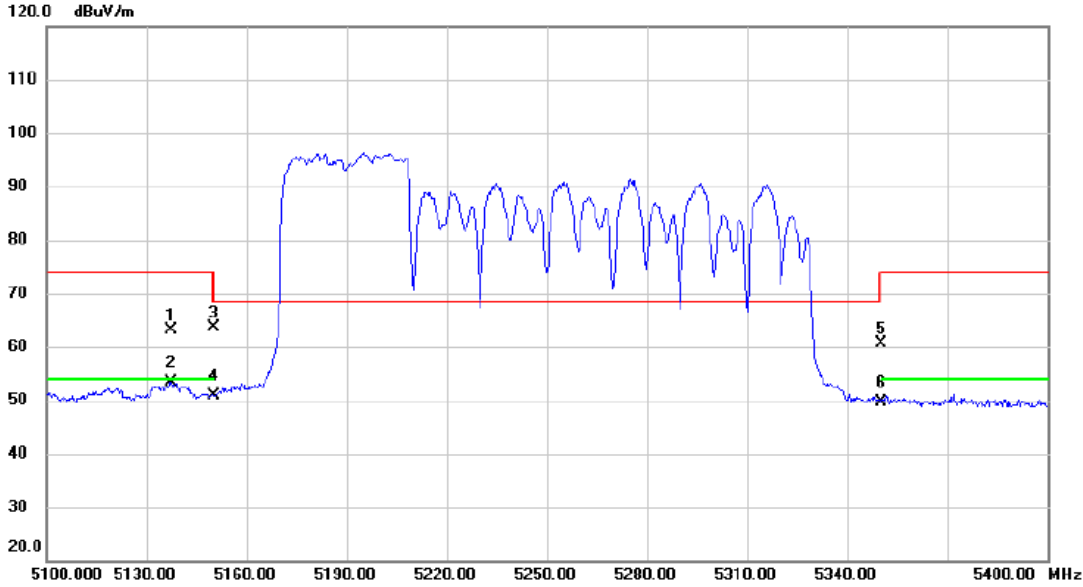

No.	Mk.	Freq. MHz	Reading Level dBuV	Correct Factor dB	Measure- ment dBuV/m	Limit dBuV/m	Margin dB	Detector	Comment
1		5137.500	24.09	39.05	63.14	74.00	-10.86	peak	
2	*	5137.500	14.40	39.05	53.45	54.00	-0.55	AVG	
3		5150.000	24.56	39.07	63.63	74.00	-10.37	peak	
4		5150.000	11.69	39.07	50.76	54.00	-3.24	AVG	
5		5350.000	21.29	39.32	60.61	74.00	-13.39	peak	
6		5350.000	10.37	39.32	49.69	54.00	-4.31	AVG	

**REMARKS:**

- (1) Measurement Value = Reading Level + Correct Factor.
- (2) Margin Level = Measurement Value - Limit Value.

Orthogonal Axis	X		
Test Mode	UNII-2A_TX AX (HE160) Mode 5250 MHz	RU configuration	484/66

### Horizontal

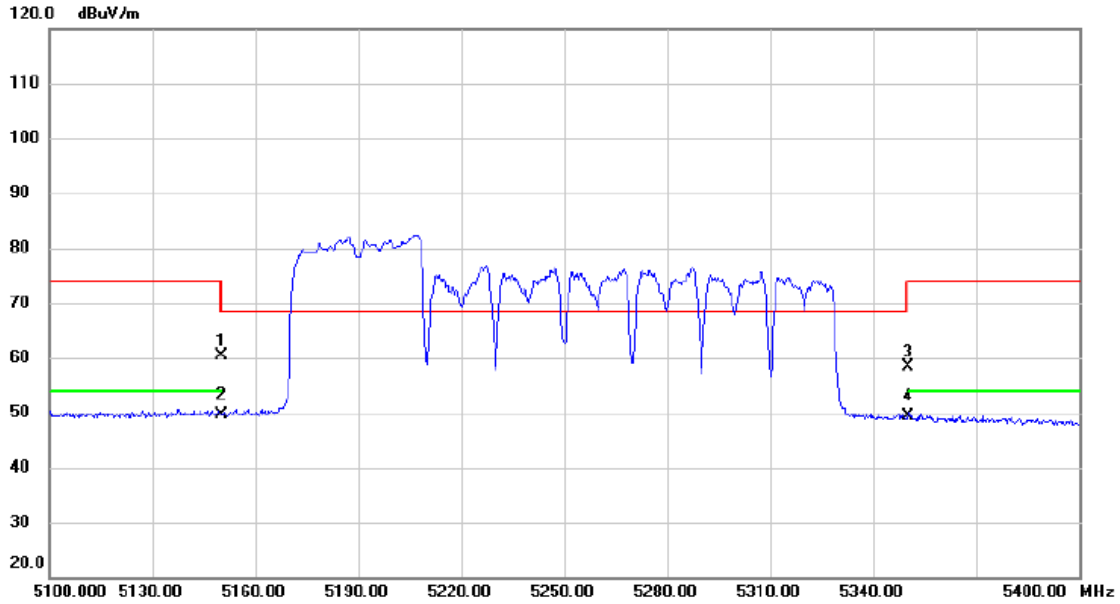

No.	Mk.	Freq. MHz	Reading Level dBuV	Correct Factor dB	Measure- ment dBuV/m	Limit dBuV/m	Margin dB	Detector	Comment
1		5150.000	21.40	39.07	60.47	74.00	-13.53	peak	
2	*	5150.000	10.59	39.07	49.66	54.00	-4.34	AVG	
3		5350.000	18.98	39.32	58.30	74.00	-15.70	peak	
4		5350.000	10.04	39.32	49.36	54.00	-4.64	AVG	

**REMARKS:**

- (1) Measurement Value = Reading Level + Correct Factor.
- (2) Margin Level = Measurement Value - Limit Value.

Orthogonal Axis	X		
Test Mode	UNII-2A_TX AX (HE160) Mode 5250 MHz	RU configuration	996/S67

### Vertical

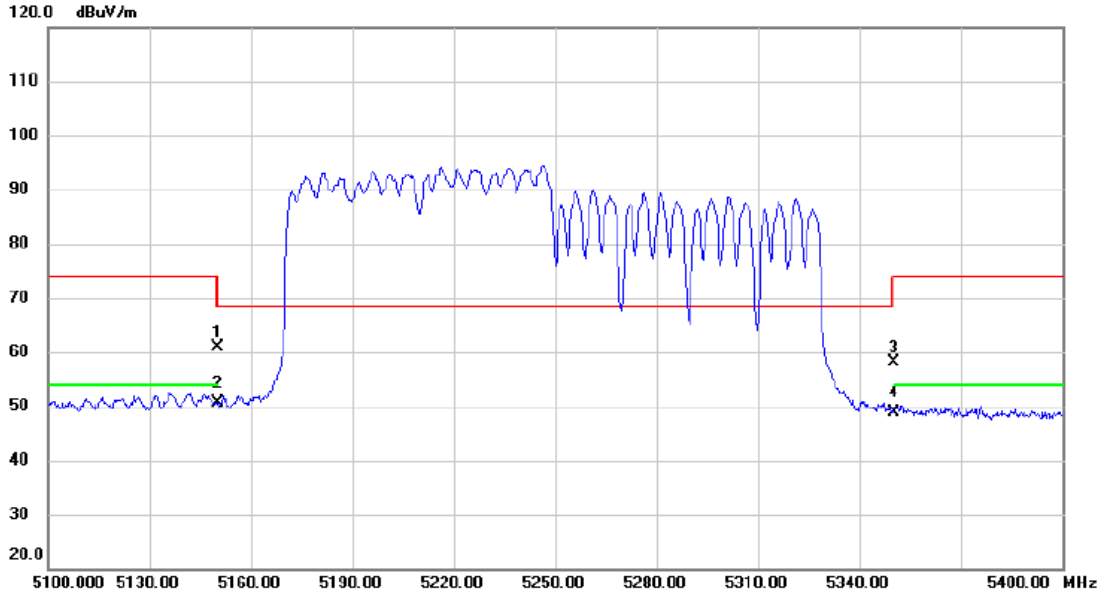

No.	Mk.	Freq. MHz	Reading Level dBuV	Correct Factor dB	Measure- ment dBuV/m	Limit dBuV/m	Margin dB	Detector	Comment
1		5150.000	21.83	39.07	60.90	74.00	-13.10	peak	
2	*	5150.000	11.52	39.07	50.59	54.00	-3.41	AVG	
3		5350.000	18.75	39.32	58.07	74.00	-15.93	peak	
4		5350.000	9.58	39.32	48.90	54.00	-5.10	AVG	

**REMARKS:**

- (1) Measurement Value = Reading Level + Correct Factor.
- (2) Margin Level = Measurement Value - Limit Value.



Orthogonal Axis	X		
Test Mode	UNII-2A_TX AX (HE160) Mode 5250 MHz	RU configuration	996/S67

### Horizontal

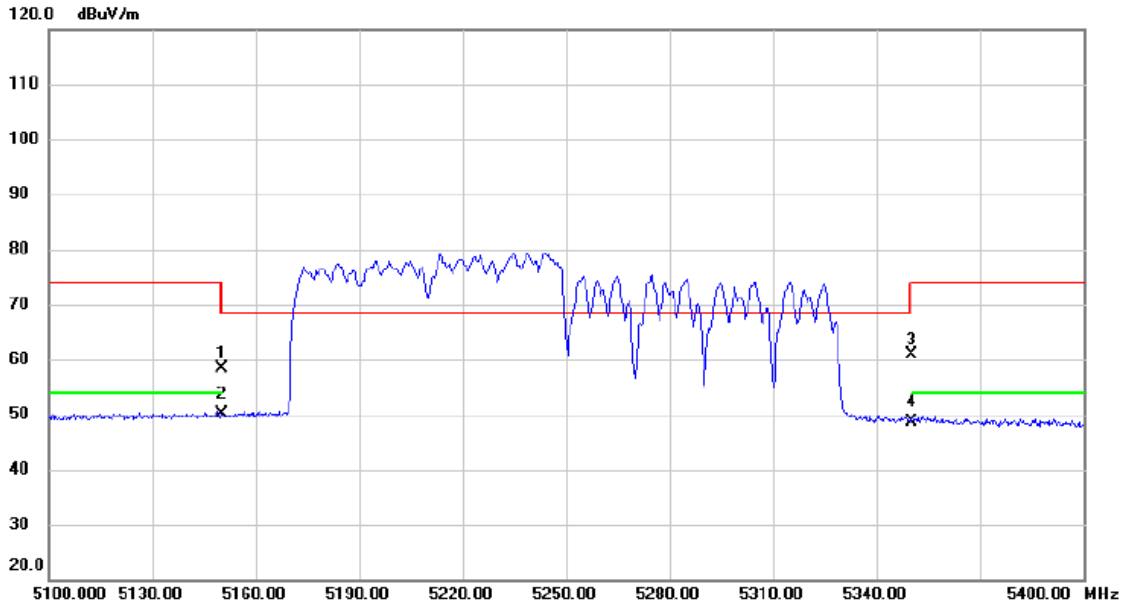

No.	Mk.	Freq. MHz	Reading Level dBuV	Correct Factor dB	Measure- ment dBuV/m	Limit dBuV/m	Margin dB	Detector	Comment
1		5150.000	19.31	39.07	58.38	74.00	-15.62	peak	
2	*	5150.000	11.06	39.07	50.13	54.00	-3.87	AVG	
3		5350.000	21.60	39.32	60.92	74.00	-13.08	peak	
4		5350.000	9.42	39.32	48.74	54.00	-5.26	AVG	

**REMARKS:**

- (1) Measurement Value = Reading Level + Correct Factor.
- (2) Margin Level = Measurement Value - Limit Value.

Orthogonal Axis	X		
Test Mode	UNII-2A_TX AX (HE160) Mode 5250 MHz	RU configuration	996*2/S68

### Vertical

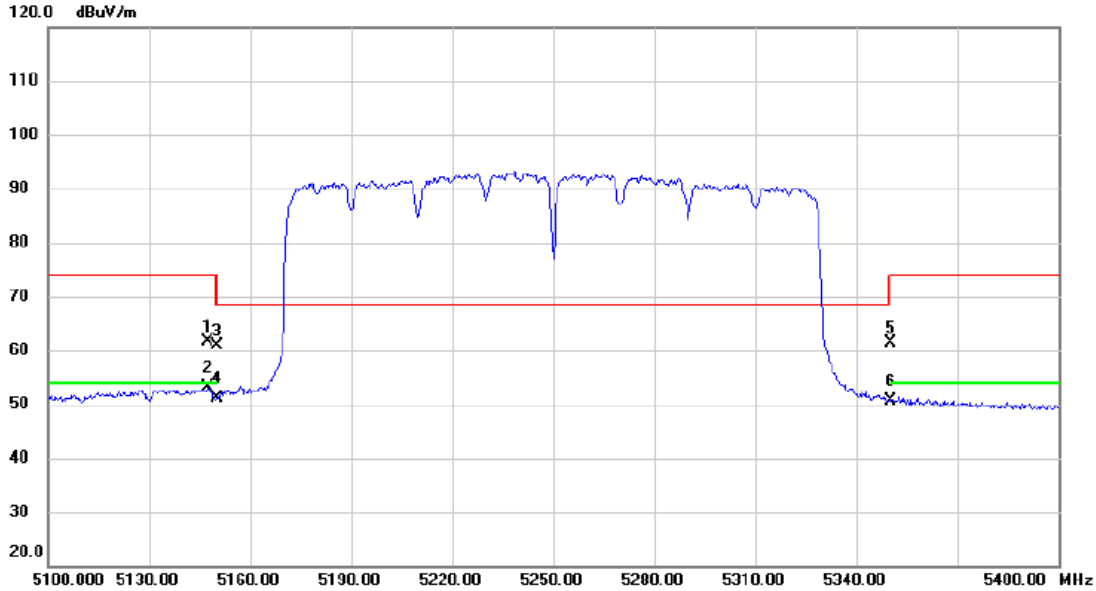

No.	Mk.	Freq. MHz	Reading Level dBuV	Correct Factor dB	Measure- ment dBuV/m	Limit dBuV/m	Margin dB	Detector	Comment
1		5147.400	22.56	39.07	61.63	74.00	-12.37	peak	
2	*	5147.400	14.16	39.07	53.23	54.00	-0.77	AVG	
3		5150.000	21.72	39.07	60.79	74.00	-13.21	peak	
4		5150.000	12.15	39.07	51.22	54.00	-2.78	AVG	
5		5350.000	22.13	39.32	61.45	74.00	-12.55	peak	
6		5350.000	11.33	39.32	50.65	54.00	-3.35	AVG	

**REMARKS:**

- (1) Measurement Value = Reading Level + Correct Factor.
- (2) Margin Level = Measurement Value - Limit Value.

Orthogonal Axis	X		
Test Mode	UNII-2A_TX AX (HE160) Mode 5250 MHz	RU configuration	996*2/S68

### Horizontal

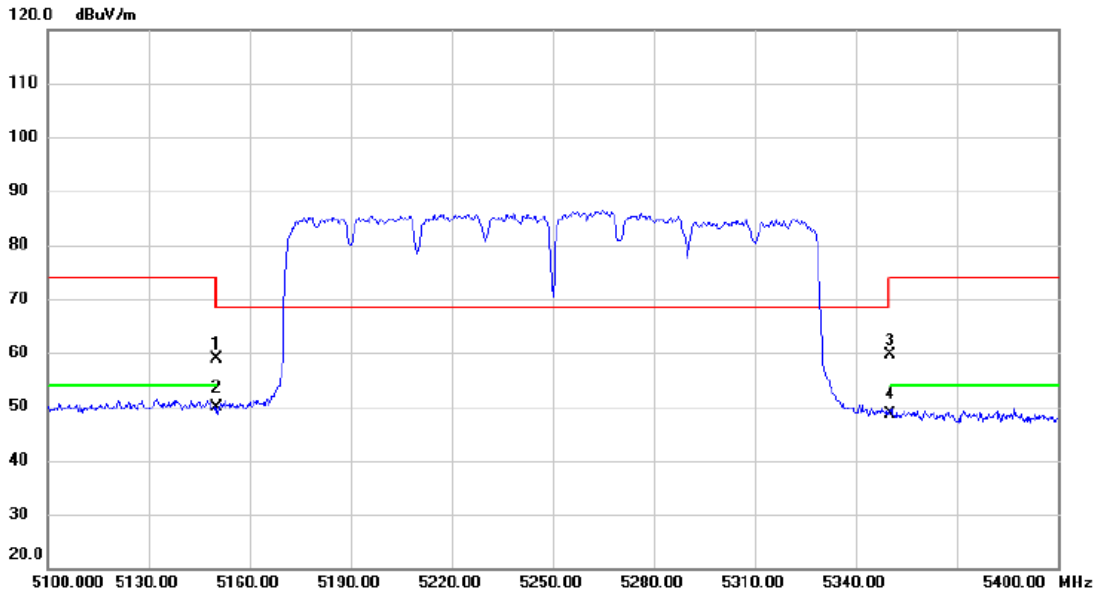

No.	Mk.	Freq. MHz	Reading Level dBuV	Correct Factor dB	Measure- ment dBuV/m	Limit dBuV/m	Margin dB	Detector	Comment
1		5150.000	19.73	39.07	58.80	74.00	-15.20	peak	
2	*	5150.000	10.80	39.07	49.87	54.00	-4.13	AVG	
3		5350.000	20.41	39.32	59.73	74.00	-14.27	peak	
4		5350.000	9.34	39.32	48.66	54.00	-5.34	AVG	

**REMARKS:**

- (1) Measurement Value = Reading Level + Correct Factor.
- (2) Margin Level = Measurement Value - Limit Value.

Orthogonal Axis	X		
Test Mode	UNII-2A_TX AX (HE160) Mode 5250 MHz	RU configuration	996*2/S68

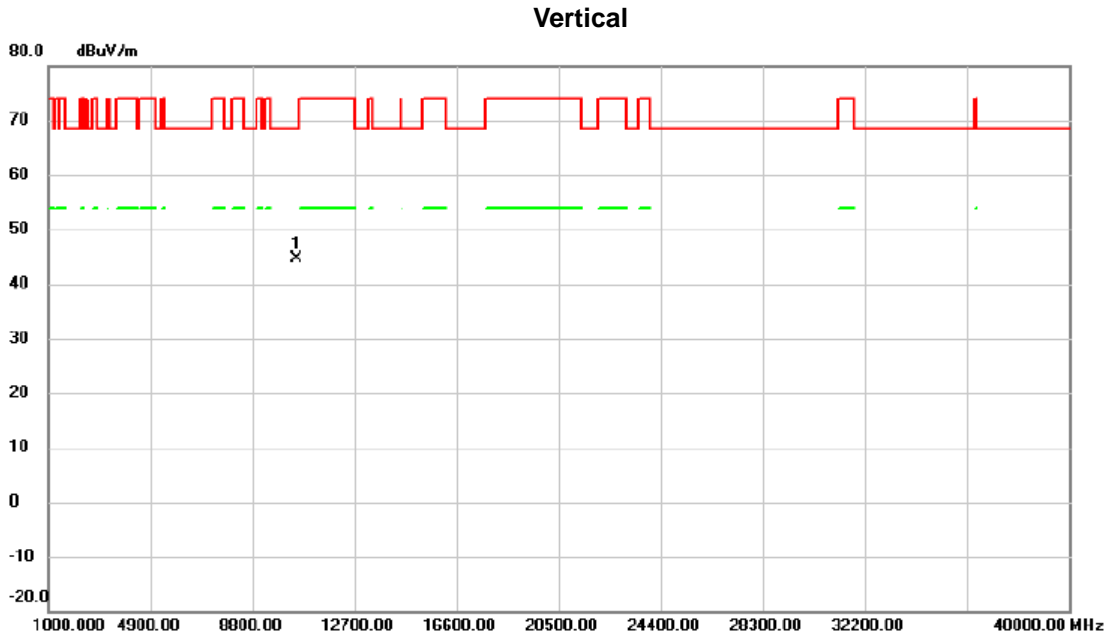

No.	Mk.	Freq.	Reading Level	Correct Factor	Measurement	Limit	Margin	Detector	Comment
		MHz	dBuV	dB	dBuV/m	dBuV/m	dB		
1	*	10500.00	46.24	-1.51	44.73	68.30	-23.57	peak	

**REMARKS:**

- (1) Measurement Value = Reading Level + Correct Factor.
- (2) Margin Level = Measurement Value - Limit Value.

Orthogonal Axis	X		
Test Mode	UNII-2A_TX AX (HE160) Mode 5250 MHz	RU configuration	996*2/S68

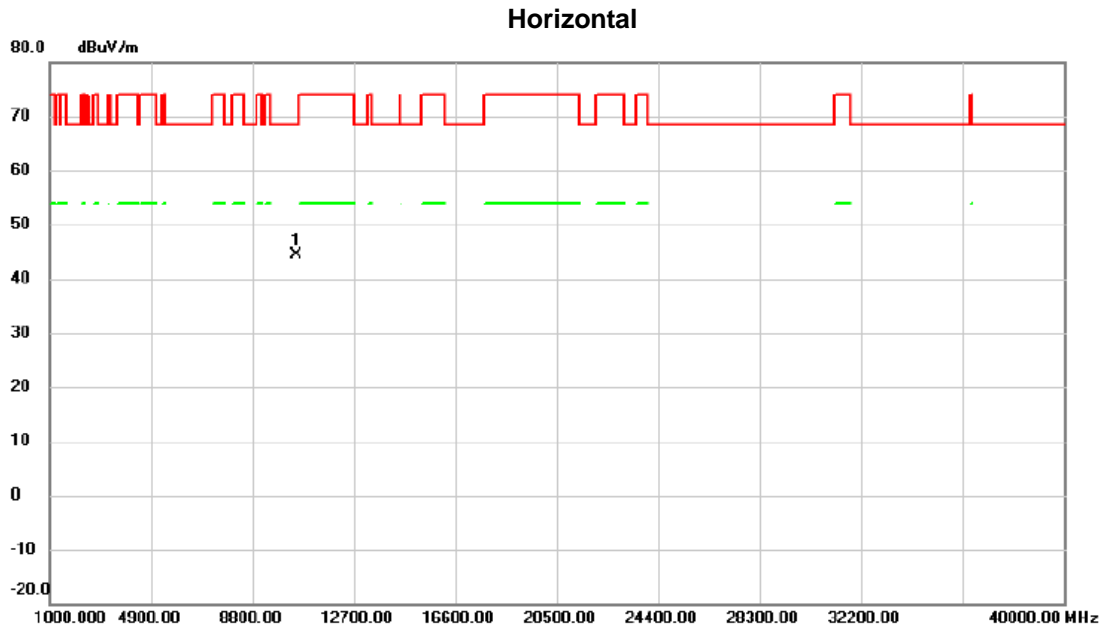

No.	Mk.	Freq.	Reading Level	Correct Factor	Measurement	Limit	Margin	Detector	Comment
		MHz	dBuV	dB	dBuV/m	dBuV/m	dB		
1	*	10500.00	45.97	-1.51	44.46	68.30	-23.84	peak	

**REMARKS:**

- (1) Measurement Value = Reading Level + Correct Factor.
- (2) Margin Level = Measurement Value - Limit Value.

Orthogonal Axis	X		
Test Mode	UNII-2C_TX AX (HE20) Mode 5500 MHz	RU configuration	52/37

### Vertical

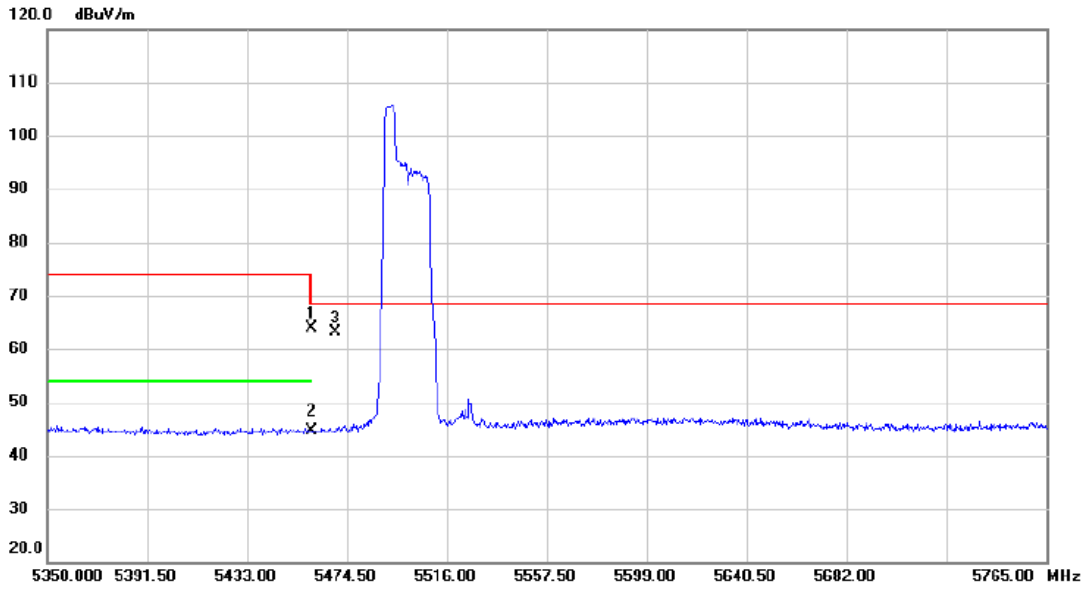

No.	Mk.	Freq. MHz	Reading Level dBuV	Correct Factor dB	Measure- ment dBuV/m	Limit dBuV/m	Margin dB	Detector	Comment
1		5460.000	24.33	39.46	63.79	74.00	-10.21	peak	
2		5460.000	5.25	39.46	44.71	54.00	-9.29	AVG	
3	*	5470.000	23.76	39.47	63.23	68.30	-5.07	peak	

**REMARKS:**

- (1) Measurement Value = Reading Level + Correct Factor.
- (2) Margin Level = Measurement Value - Limit Value.

Orthogonal Axis	X		
Test Mode	UNII-2C_TX AX (HE20) Mode 5500 MHz	RU configuration	52/37

### Horizontal

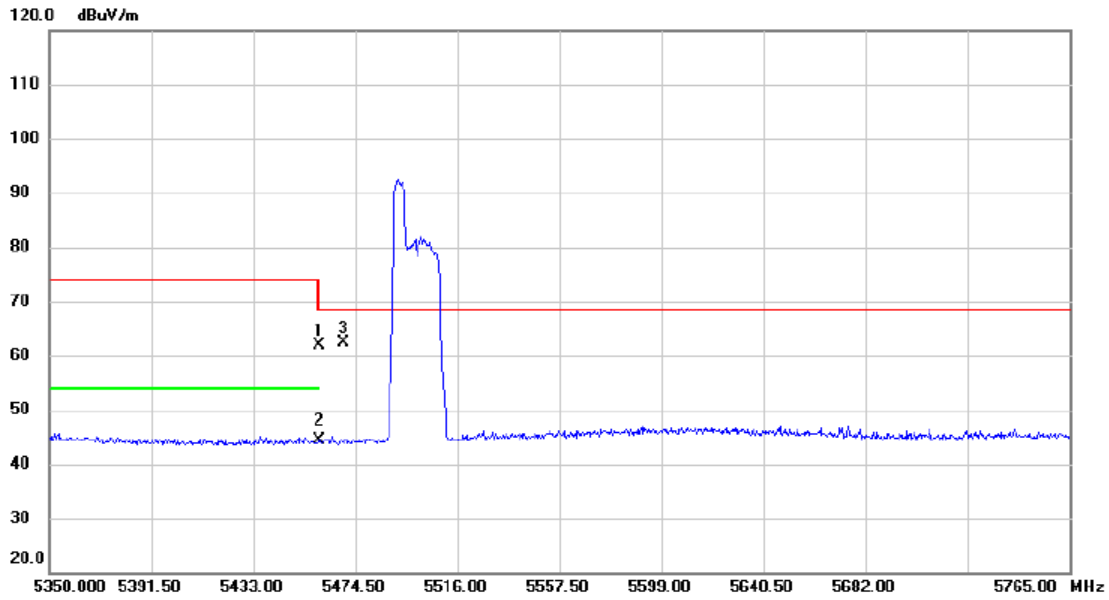

No.	Mk.	Freq. MHz	Reading Level dBuV	Correct Factor dB	Measure- ment dBuV/m	Limit dBuV/m	Margin dB	Detector	Comment
1		5460.000	22.51	39.46	61.97	74.00	-12.03	peak	
2		5460.000	4.91	39.46	44.37	54.00	-9.63	AVG	
3	*	5470.000	22.87	39.47	62.34	68.30	-5.96	peak	

**REMARKS:**

- (1) Measurement Value = Reading Level + Correct Factor.
- (2) Margin Level = Measurement Value - Limit Value.

Orthogonal Axis	X		
Test Mode	UNII-2C_TX AX (HE20) Mode 5500 MHz	RU configuration	106/53

### Vertical

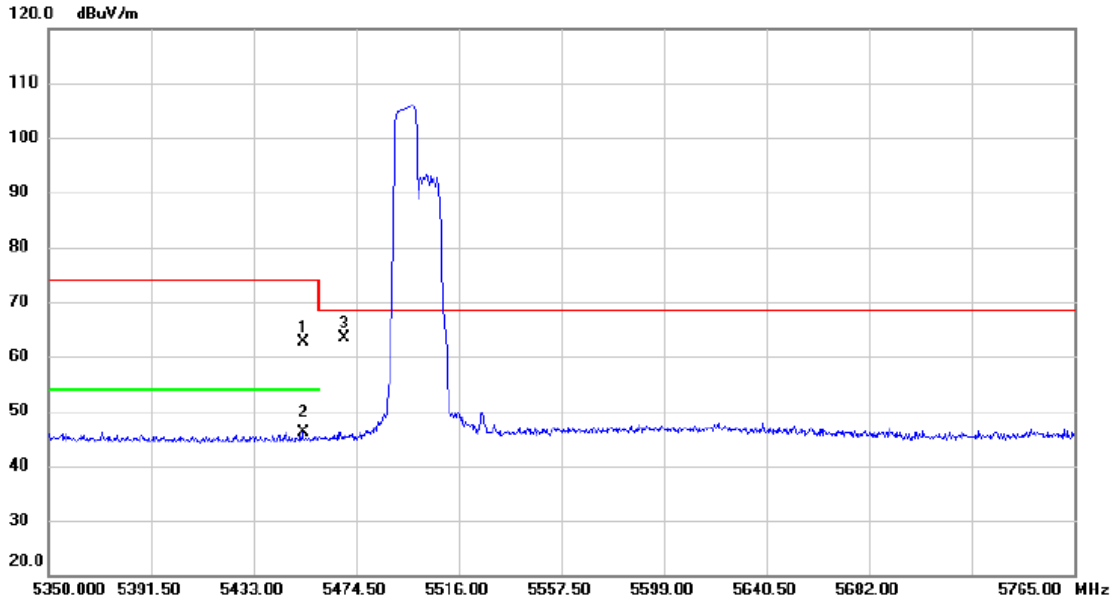

No.	Mk.	Freq. MHz	Reading Level dBuV	Correct Factor dB	Measure- ment dBuV/m	Limit dBuV/m	Margin dB	Detector	Comment
1		5453.127	23.26	39.45	62.71	74.00	-11.29	peak	
2		5453.127	6.71	39.45	46.16	54.00	-7.84	AVG	
3	*	5470.000	23.97	39.47	63.44	68.30	-4.86	peak	

**REMARKS:**

- (1) Measurement Value = Reading Level + Correct Factor.
- (2) Margin Level = Measurement Value - Limit Value.



Orthogonal Axis	X		
Test Mode	UNII-2C_TX AX (HE20) Mode 5500 MHz	RU configuration	106/53

### Horizontal

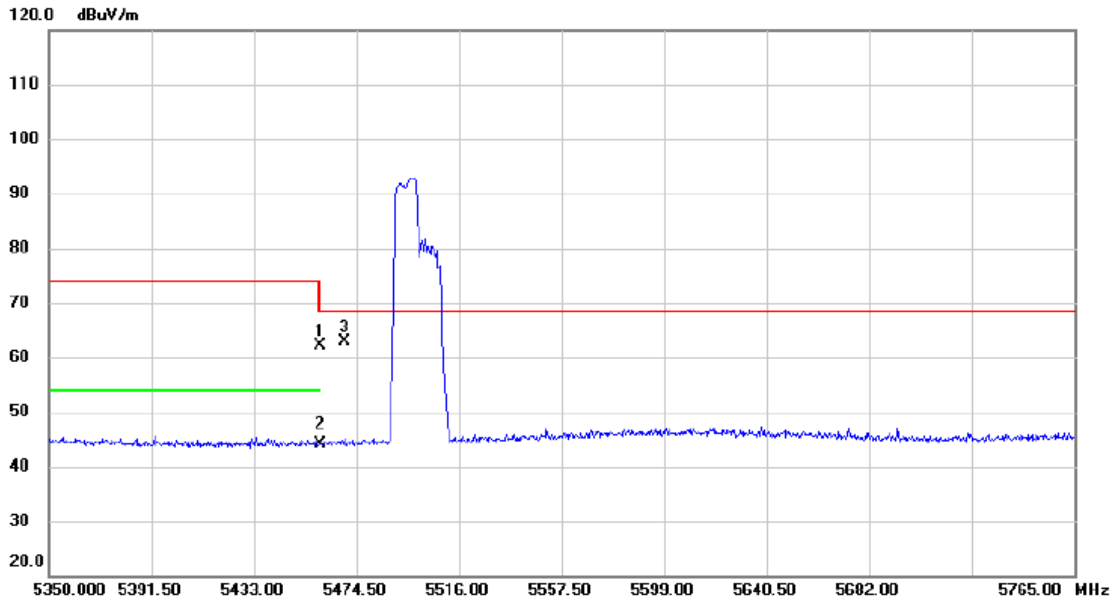

No.	Mk.	Freq. MHz	Reading Level dBuV	Correct Factor dB	Measure- ment dBuV/m	Limit dBuV/m	Margin dB	Detector	Comment
1		5460.000	22.67	39.46	62.13	74.00	-11.87	peak	
2		5460.000	4.69	39.46	44.15	54.00	-9.85	AVG	
3	*	5470.000	23.49	39.47	62.96	68.30	-5.34	peak	

**REMARKS:**

- (1) Measurement Value = Reading Level + Correct Factor.
- (2) Margin Level = Measurement Value - Limit Value.

Orthogonal Axis	X		
Test Mode	UNII-2C_TX AX (HE20) Mode 5500 MHz	RU configuration	242/61

### Vertical

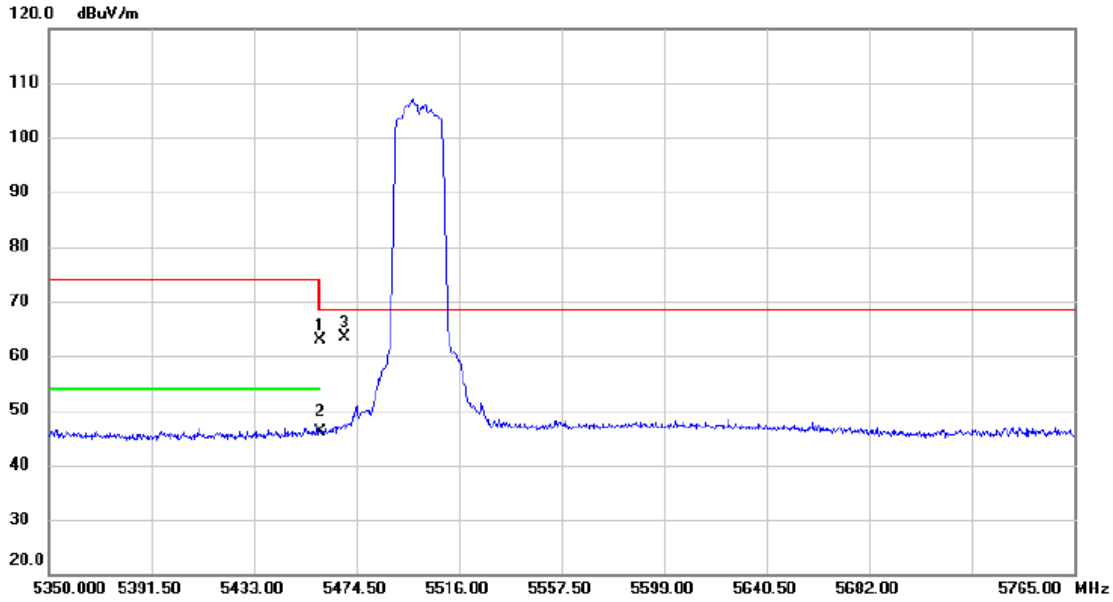

No.	Mk.	Freq. MHz	Reading Level dBuV	Correct Factor dB	Measure- ment dBuV/m	Limit dBuV/m	Margin dB	Detector	Comment
1		5460.000	23.51	39.46	62.97	74.00	-11.03	peak	
2		5460.000	6.74	39.46	46.20	54.00	-7.80	AVG	
3	*	5470.000	23.92	39.47	63.39	68.30	-4.91	peak	

**REMARKS:**

- (1) Measurement Value = Reading Level + Correct Factor.
- (2) Margin Level = Measurement Value - Limit Value.

Orthogonal Axis	X		
Test Mode	UNII-2C_TX AX (HE20) Mode 5500 MHz	RU configuration	242/61

### Horizontal

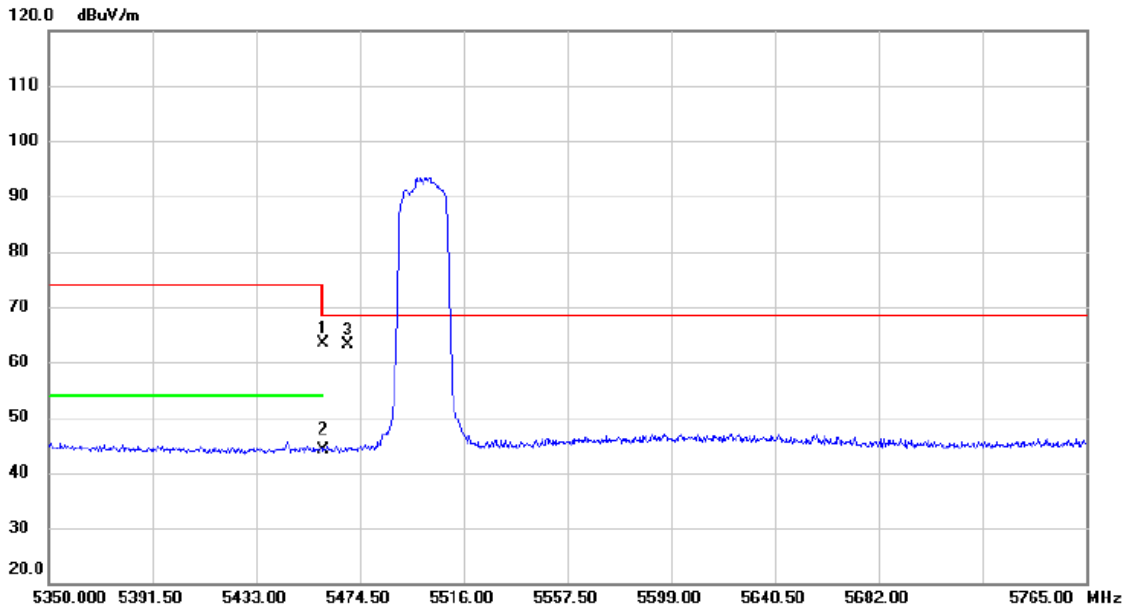

No.	Mk.	Freq. MHz	Reading Level dBuV	Correct Factor dB	Measure- ment dBuV/m	Limit dBuV/m	Margin dB	Detector	Comment
1		5460.000	23.81	39.46	63.27	74.00	-10.73	peak	
2		5460.000	4.74	39.46	44.20	54.00	-9.80	AVG	
3	*	5470.000	23.76	39.47	63.23	68.30	-5.07	peak	

**REMARKS:**

- (1) Measurement Value = Reading Level + Correct Factor.
- (2) Margin Level = Measurement Value - Limit Value.

Orthogonal Axis	X		
Test Mode	UNII-2C_TX AX (HE20) Mode 5500 MHz	RU configuration	242/61

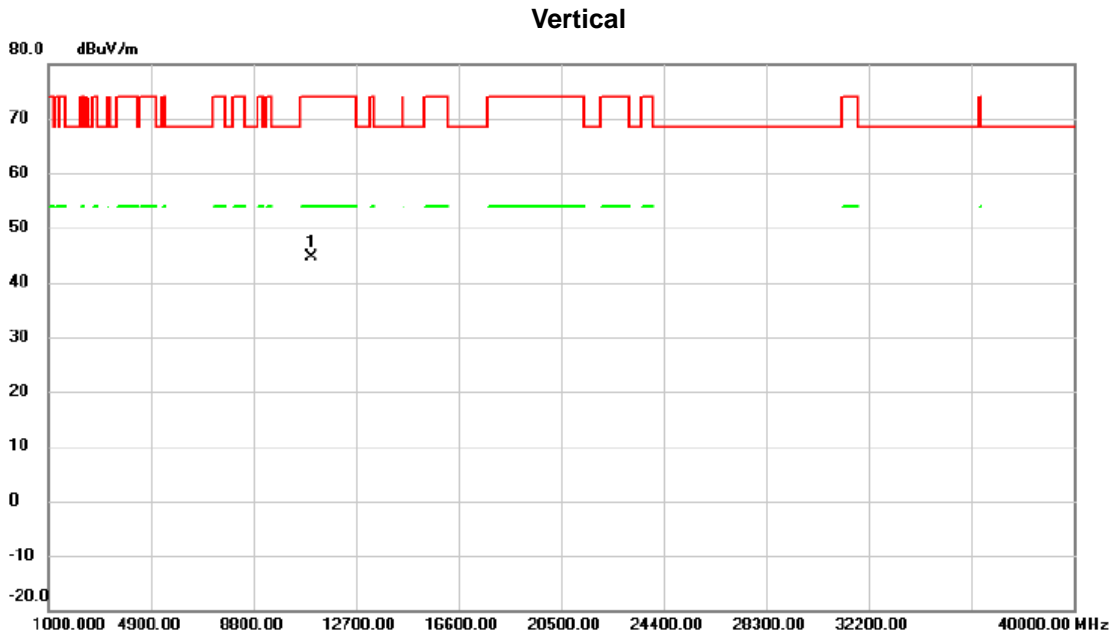

No.	Mk.	Freq. MHz	Reading Level dBuV	Correct Factor dB	Measure- ment dBuV/m	Limit dBuV/m	Margin dB	Detector	Comment
1	*	11000.00	43.53	1.04	44.57	74.00	-29.43	peak	

**REMARKS:**

- (1) Measurement Value = Reading Level + Correct Factor.
- (2) Margin Level = Measurement Value - Limit Value.

Orthogonal Axis	X		
Test Mode	UNII-2C_TX AX (HE20) Mode 5500 MHz	RU configuration	242/61

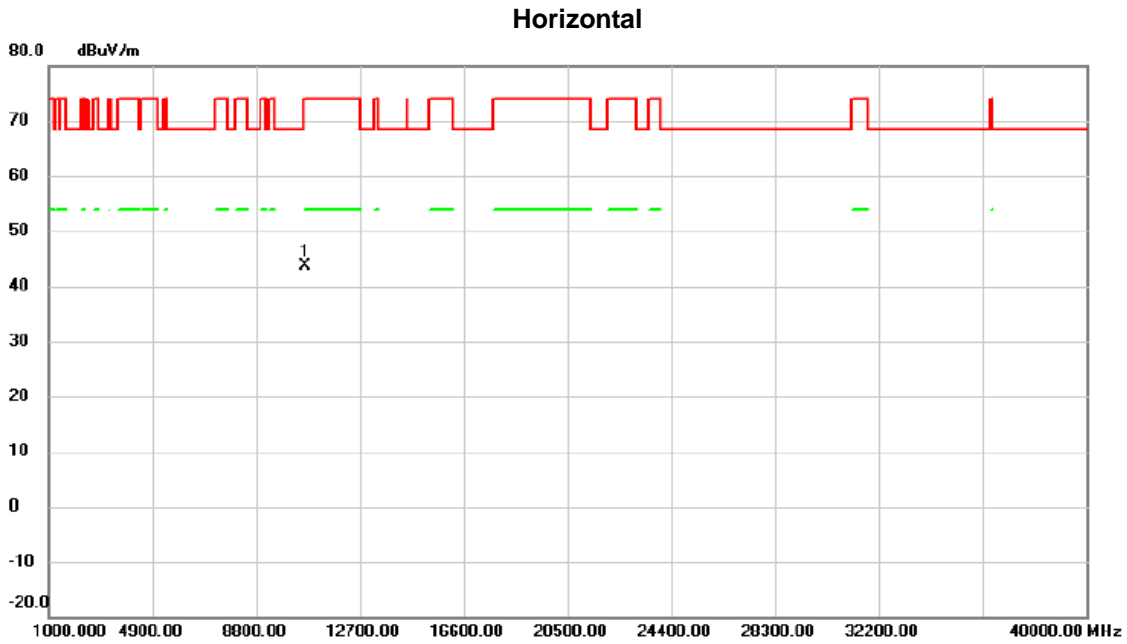

No.	Mk.	Freq.	Reading Level	Correct Factor	Measurement	Limit	Margin	Detector	Comment
		MHz	dBuV	dB	dBuV/m	dBuV/m	dB		
1	*	10640.00	44.47	-0.76	43.71	74.00	-30.29	peak	

**REMARKS:**

- (1) Measurement Value = Reading Level + Correct Factor.
- (2) Margin Level = Measurement Value - Limit Value.

Orthogonal Axis	X		
Test Mode	UNII-2C_TX AX (HE20) Mode 5580 MHz	RU configuration	52/37

### Vertical

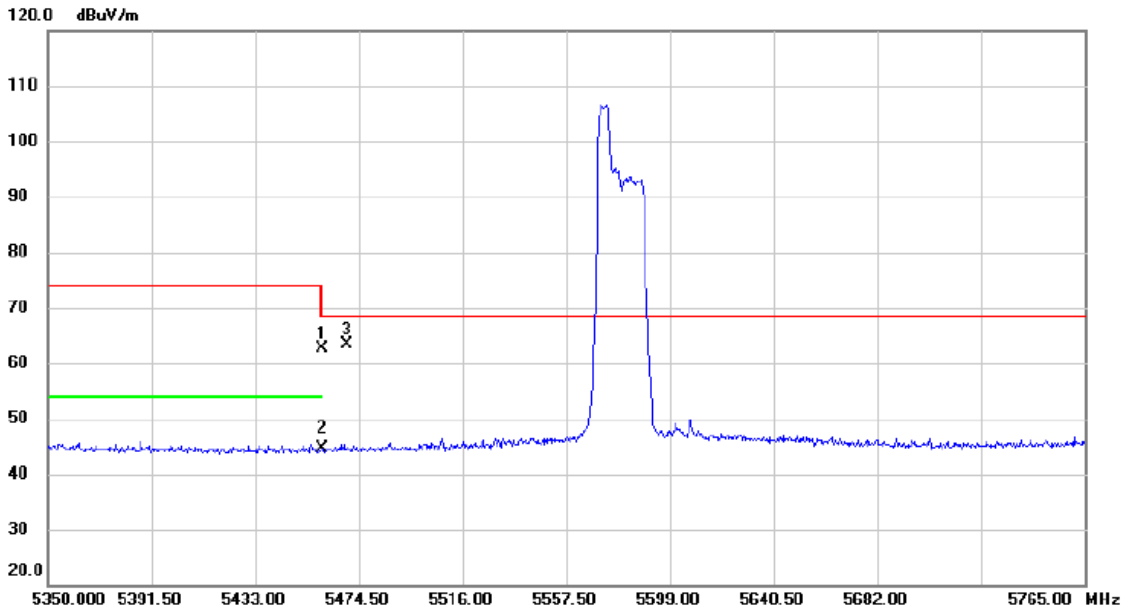

No.	Mk.	Freq. MHz	Reading Level dBuV	Correct Factor dB	Measure- ment dBuV/m	Limit dBuV/m	Margin dB	Detector	Comment
1		5460.000	23.16	39.46	62.62	74.00	-11.38	peak	
2		5460.000	5.29	39.46	44.75	54.00	-9.25	AVG	
3	*	5470.000	23.94	39.47	63.41	68.30	-4.89	peak	

**REMARKS:**

- (1) Measurement Value = Reading Level + Correct Factor.
- (2) Margin Level = Measurement Value - Limit Value.

Orthogonal Axis	X		
Test Mode	UNII-2C_TX AX (HE20) Mode 5580 MHz	RU configuration	52/37

### Horizontal

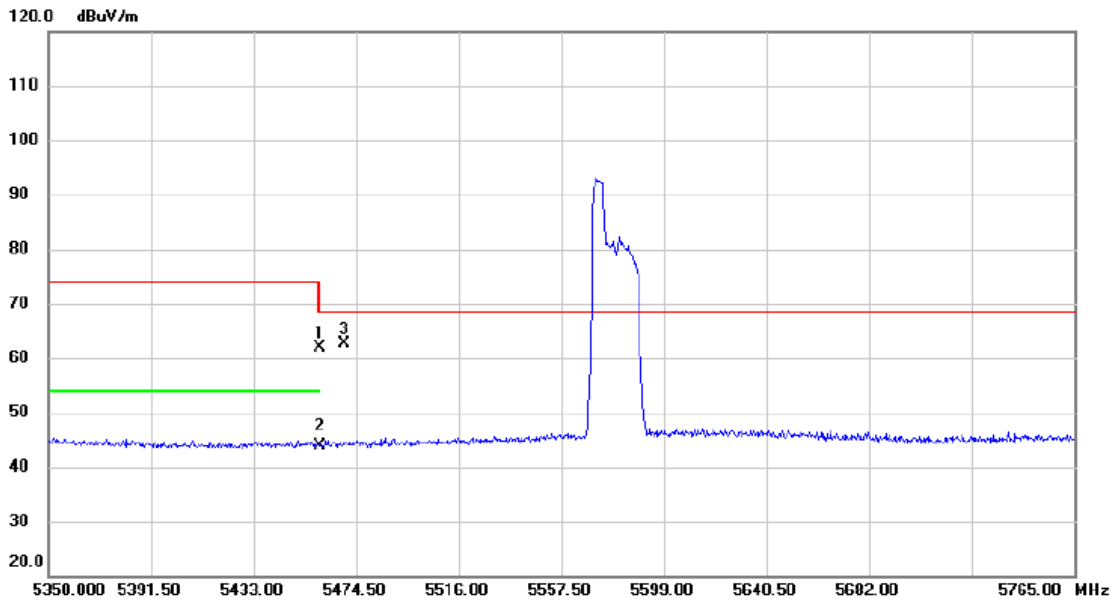

No.	Mk.	Freq. MHz	Reading Level dBuV	Correct Factor dB	Measure- ment dBuV/m	Limit dBuV/m	Margin dB	Detector	Comment
1		5460.000	22.47	39.46	61.93	74.00	-12.07	peak	
2		5460.000	4.40	39.46	43.86	54.00	-10.14	AVG	
3	*	5470.000	23.24	39.47	62.71	68.30	-5.59	peak	

**REMARKS:**

- (1) Measurement Value = Reading Level + Correct Factor.
- (2) Margin Level = Measurement Value - Limit Value.

Orthogonal Axis	X		
Test Mode	UNII-2C_TX AX (HE20) Mode 5580 MHz	RU configuration	106/53

### Vertical

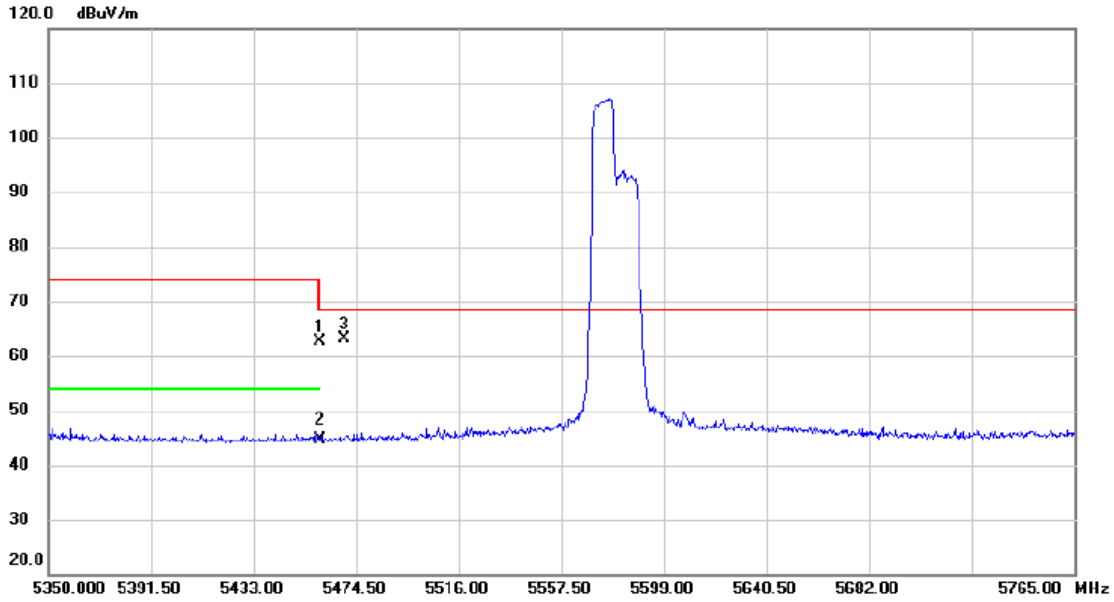

No.	Mk.	Freq. MHz	Reading Level dBuV	Correct Factor dB	Measure- ment dBuV/m	Limit dBuV/m	Margin dB	Detector	Comment
1		5460.000	23.15	39.46	62.61	74.00	-11.39	peak	
2		5460.000	5.05	39.46	44.51	54.00	-9.49	AVG	
3	*	5470.000	23.57	39.47	63.04	68.30	-5.26	peak	

**REMARKS:**

- (1) Measurement Value = Reading Level + Correct Factor.
- (2) Margin Level = Measurement Value - Limit Value.



Orthogonal Axis	X		
Test Mode	UNII-2C_TX AX (HE20) Mode 5580 MHz	RU configuration	106/53

### Horizontal

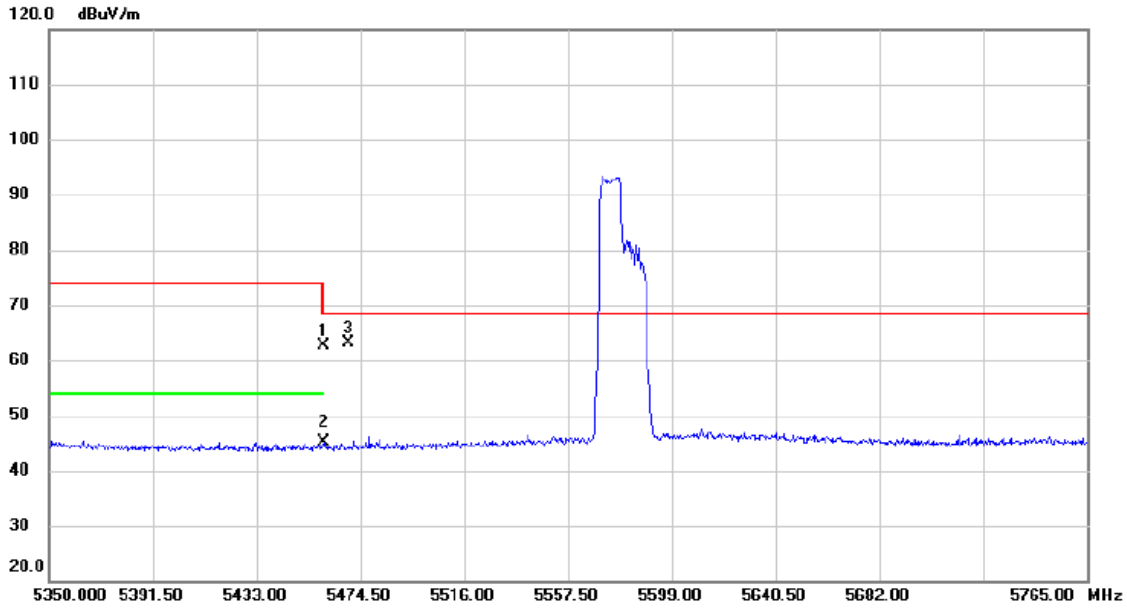

No.	Mk.	Freq. MHz	Reading Level dBuV	Correct Factor dB	Measure- ment dBuV/m	Limit dBuV/m	Margin dB	Detector	Comment
1		5460.000	23.09	39.46	62.55	74.00	-11.45	peak	
2		5460.000	5.60	39.46	45.06	54.00	-8.94	AVG	
3	*	5470.000	23.73	39.47	63.20	68.30	-5.10	peak	

**REMARKS:**

- (1) Measurement Value = Reading Level + Correct Factor.
- (2) Margin Level = Measurement Value - Limit Value.

Orthogonal Axis	X		
Test Mode	UNII-2C_TX AX (HE20) Mode 5580 MHz	RU configuration	242/61

### Vertical

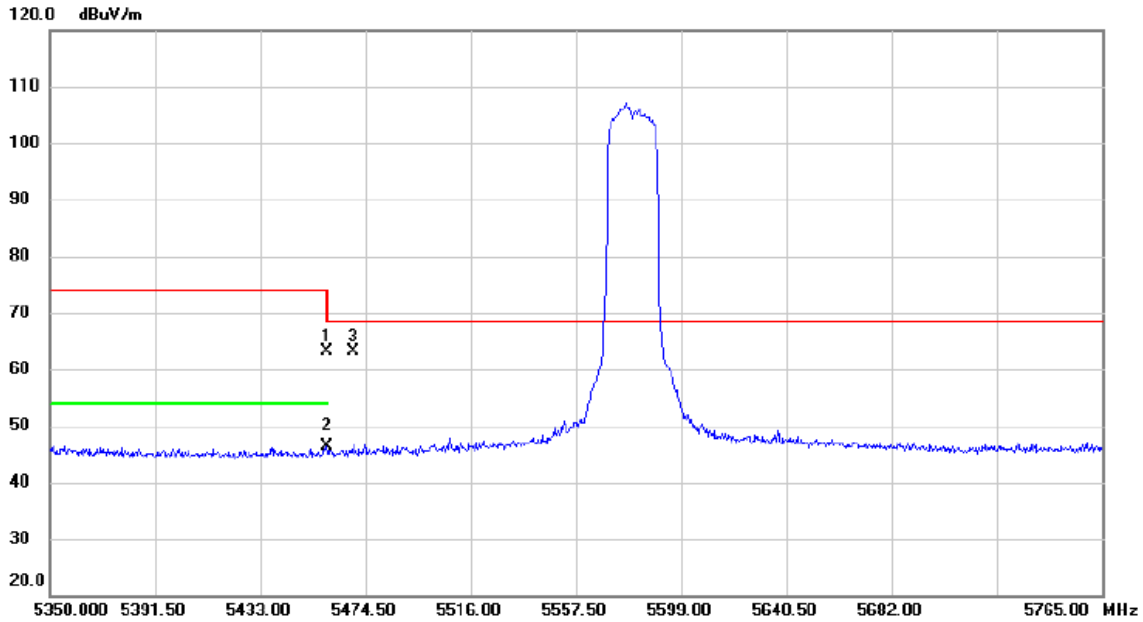

No.	Mk.	Freq. MHz	Reading Level dBuV	Correct Factor dB	Measure- ment dBuV/m	Limit dBuV/m	Margin dB	Detector	Comment
1		5459.145	23.67	39.46	63.13	74.00	-10.87	peak	
2		5459.145	6.86	39.46	46.32	54.00	-7.68	AVG	
3	*	5470.000	23.59	39.47	63.06	68.30	-5.24	peak	

**REMARKS:**

- (1) Measurement Value = Reading Level + Correct Factor.
- (2) Margin Level = Measurement Value - Limit Value.

Orthogonal Axis	X		
Test Mode	UNII-2C_TX AX (HE20) Mode 5580 MHz	RU configuration	242/61

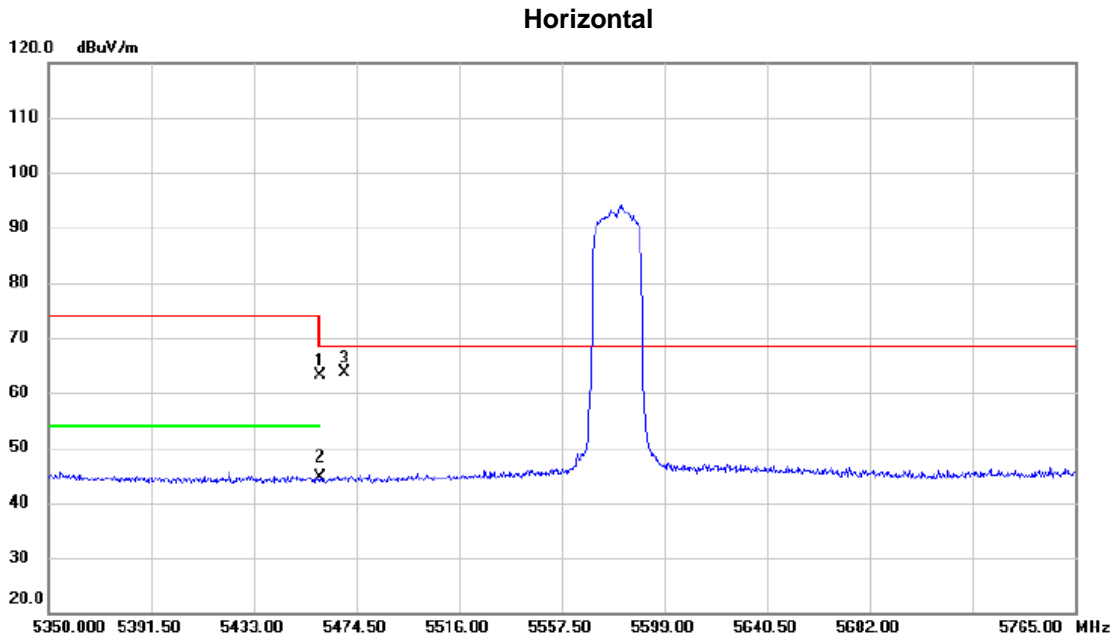

No.	Mk.	Freq. MHz	Reading Level dBuV	Correct Factor dB	Measure- ment dBuV/m	Limit dBuV/m	Margin dB	Detector	Comment
1		5460.000	23.79	39.46	63.25	74.00	-10.75	peak	
2		5460.000	5.09	39.46	44.55	54.00	-9.45	AVG	
3	*	5470.000	24.06	39.47	63.53	68.30	-4.77	peak	

**REMARKS:**

- (1) Measurement Value = Reading Level + Correct Factor.
- (2) Margin Level = Measurement Value - Limit Value.

Orthogonal Axis	X		
Test Mode	UNII-2C_TX AX (HE20) Mode 5580 MHz	RU configuration	242/61

### Vertical

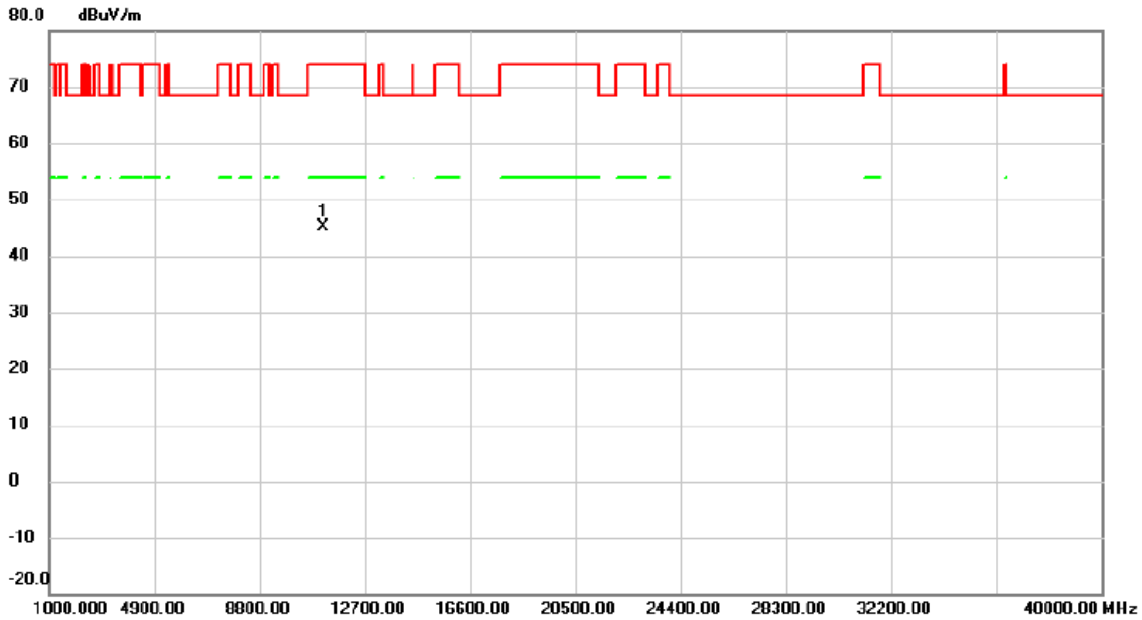

No.	Mk.	Freq. MHz	Reading Level dBuV	Correct Factor dB	Measure- ment dBuV/m	Limit dBuV/m	Margin dB	Detector	Comment
1	*	11160.00	44.39	0.85	45.24	74.00	-28.76	peak	

#### REMARKS:

- (1) Measurement Value = Reading Level + Correct Factor.
- (2) Margin Level = Measurement Value - Limit Value.

Orthogonal Axis	X		
Test Mode	UNII-2C_TX AX (HE20) Mode 5580 MHz	RU configuration	242/61

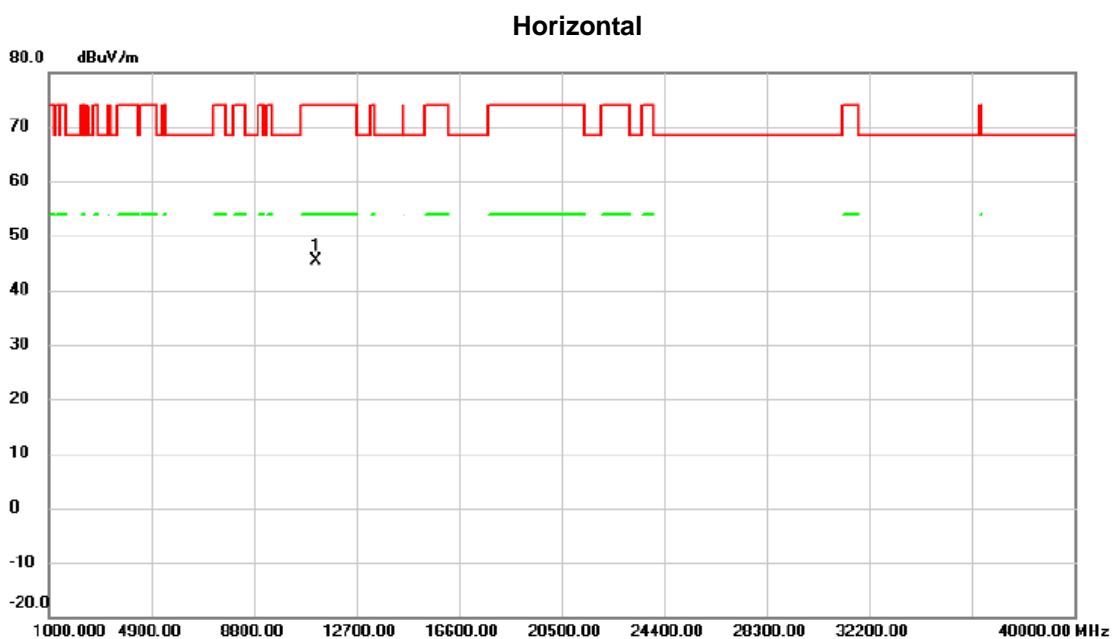

No.	Mk.	Freq. MHz	Reading Level dBuV	Correct Factor dB	Measure- ment dBuV/m	Limit dBuV/m	Margin dB	Detector	Comment
1	*	11160.00	44.48	0.85	45.33	74.00	-28.67	peak	

**REMARKS:**

- (1) Measurement Value = Reading Level + Correct Factor.
- (2) Margin Level = Measurement Value - Limit Value.

Orthogonal Axis	X		
Test Mode	UNII-2C_TX AX (HE20) Mode 5700 MHz	RU configuration	52/40

### Vertical

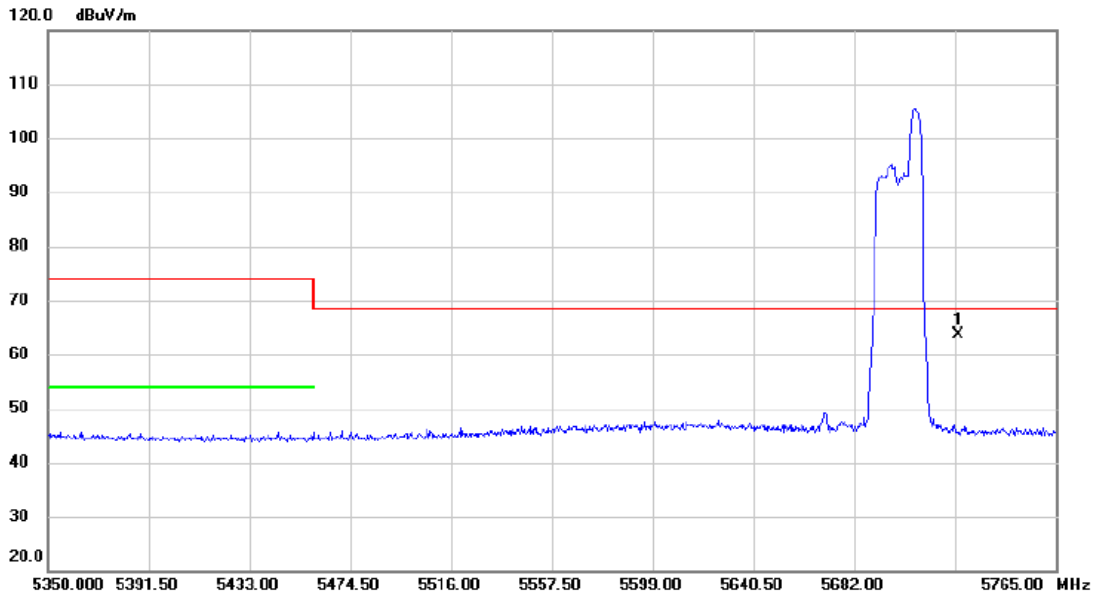

No.	Mk.	Freq.	Reading Level	Correct Factor	Measurement	Limit	Margin	Detector	Comment
		MHz	dBuV	dB	dBuV/m	dBuV/m	dB		
1	*	5725.000	23.66	40.05	63.71	68.30	-4.59	peak	

**REMARKS:**

- (1) Measurement Value = Reading Level + Correct Factor.
- (2) Margin Level = Measurement Value - Limit Value.

Orthogonal Axis	X		
Test Mode	UNII-2C_TX AX (HE20) Mode 5700 MHz	RU configuration	52/40

### Horizontal

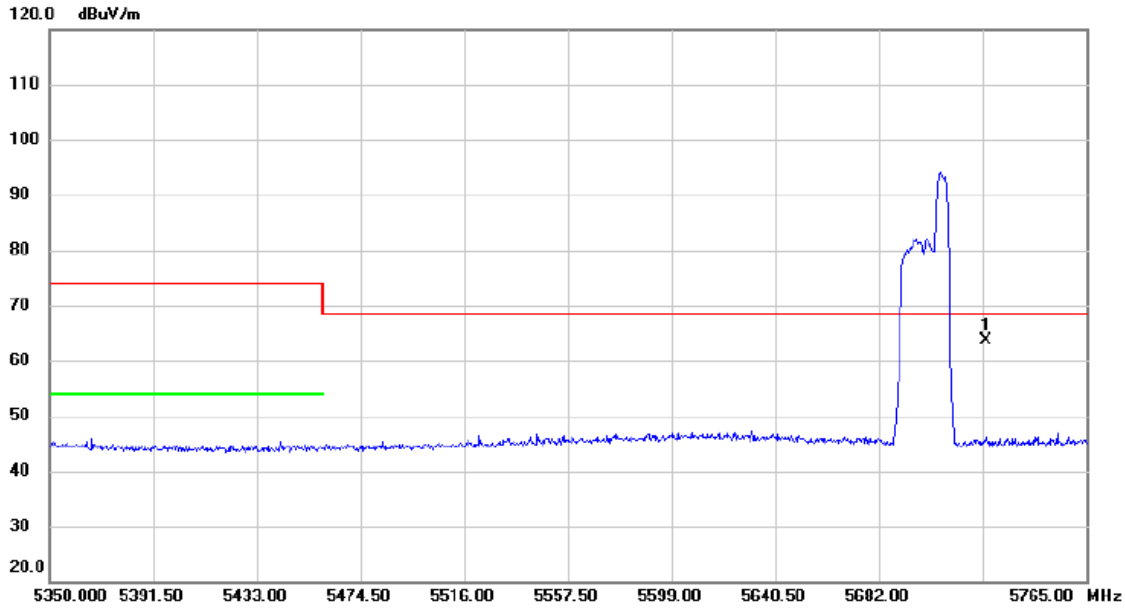

No.	Mk.	Freq.	Reading Level	Correct Factor	Measurement	Limit	Margin	Detector	Comment
		MHz	dBuV	dB	dBuV/m	dBuV/m	dB		
1	*	5725.000	23.46	40.05	63.51	68.30	-4.79	peak	

**REMARKS:**

- (1) Measurement Value = Reading Level + Correct Factor.
- (2) Margin Level = Measurement Value - Limit Value.

Orthogonal Axis	X		
Test Mode	UNII-2C_TX AX (HE20) Mode 5700 MHz	RU configuration	106/54

### Vertical

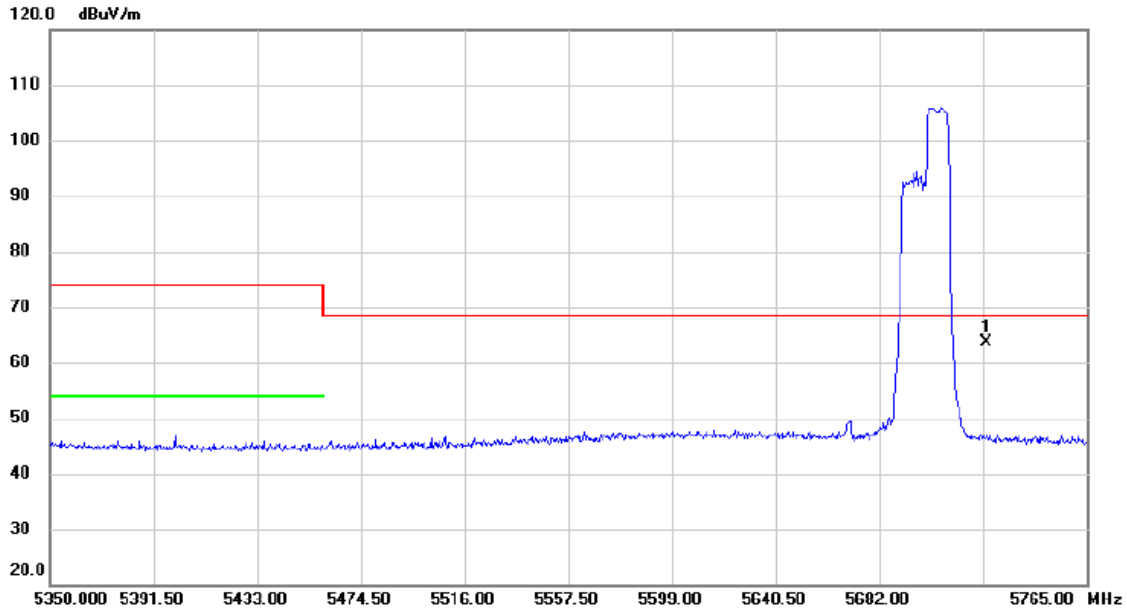

No.	Mk.	Freq.	Reading Level	Correct Factor	Measurement	Limit	Margin	Detector	Comment
		MHz	dBuV	dB	dBuV/m	dBuV/m	dB		
1	*	5725.000	23.57	40.05	63.62	68.30	-4.68	peak	

**REMARKS:**

- (1) Measurement Value = Reading Level + Correct Factor.
- (2) Margin Level = Measurement Value - Limit Value.



Orthogonal Axis	X		
Test Mode	UNII-2C_TX AX (HE20) Mode 5700 MHz	RU configuration	106/54

### Horizontal

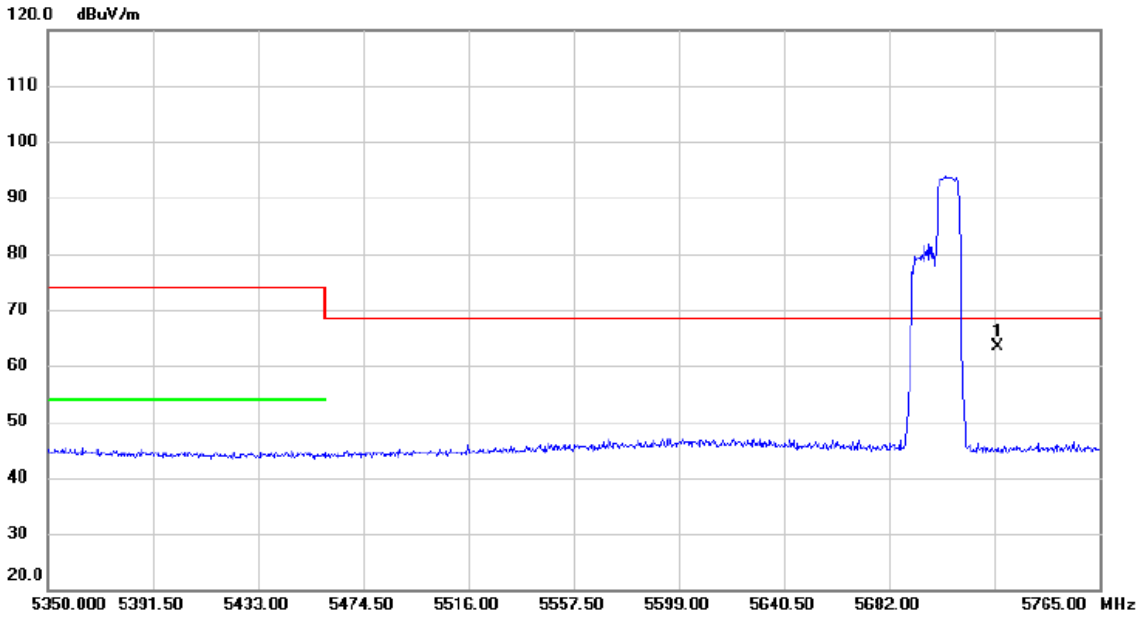

No.	Mk.	Freq. MHz	Reading Level dBuV	Correct Factor dB	Measure- ment dBuV/m	Limit dBuV/m	Margin dB	Detector	Comment
1	*	5725.000	23.43	40.05	63.48	68.30	-4.82	peak	

**REMARKS:**

- (1) Measurement Value = Reading Level + Correct Factor.
- (2) Margin Level = Measurement Value - Limit Value.

Orthogonal Axis	X		
Test Mode	UNII-2C_TX AX (HE20) Mode 5700 MHz	RU configuration	242/61

### Vertical

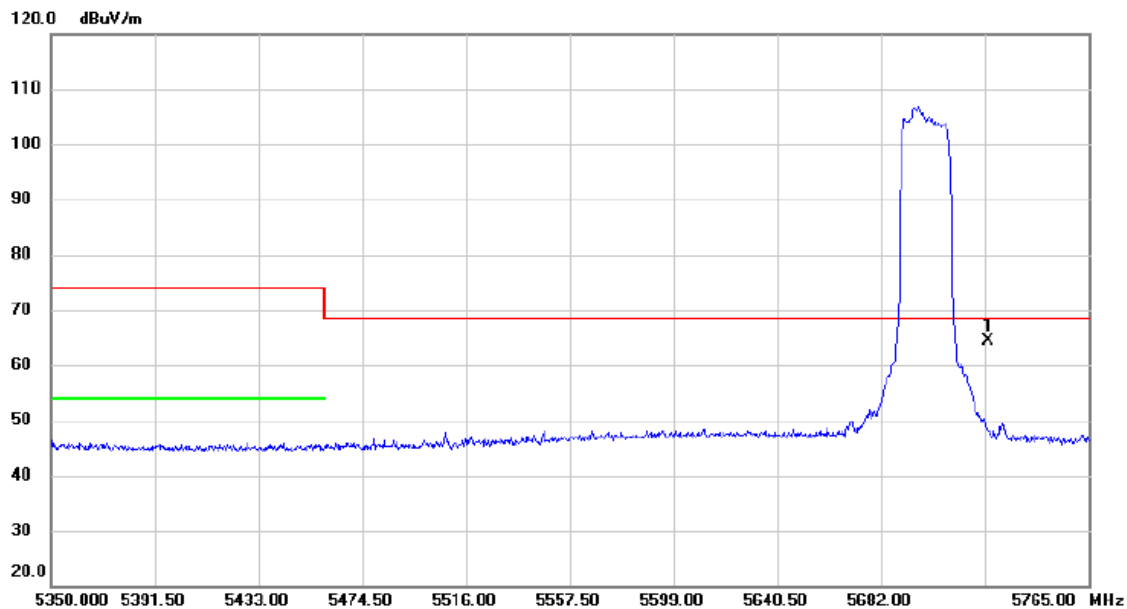

No.	Mk.	Freq. MHz	Reading Level dBuV	Correct Factor dB	Measure- ment dBuV/m	Limit dBuV/m	Margin dB	Detector	Comment
1	*	5725.000	24.33	40.05	64.38	68.30	-3.92	peak	

**REMARKS:**

- (1) Measurement Value = Reading Level + Correct Factor.
- (2) Margin Level = Measurement Value - Limit Value.

Orthogonal Axis	X		
Test Mode	UNII-2C_TX AX (HE20) Mode 5700 MHz	RU configuration	242/61

### Horizontal

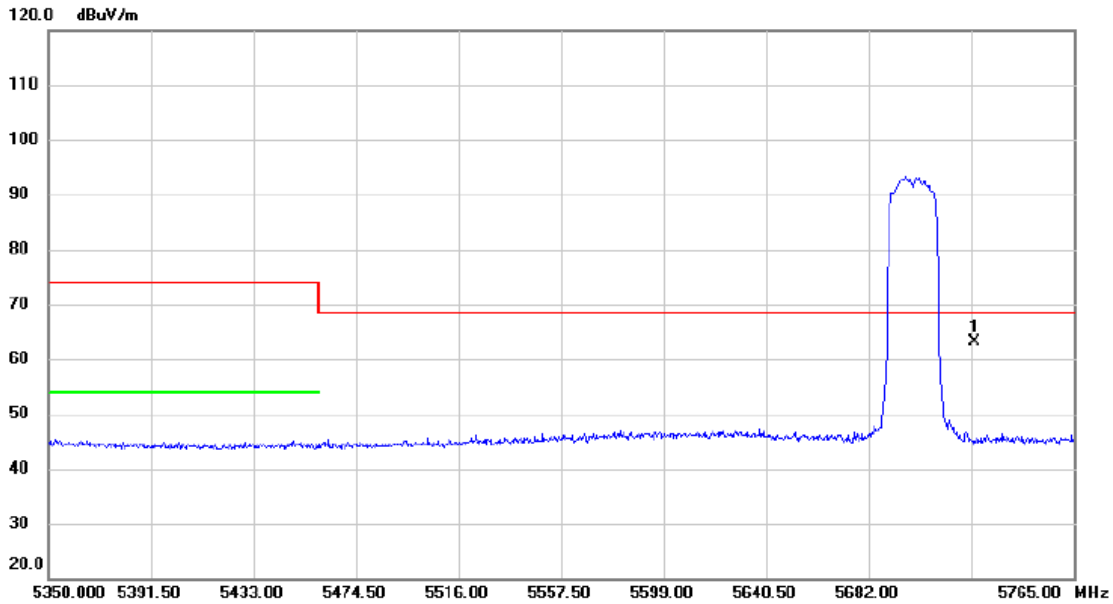

No.	Mk.	Freq. MHz	Reading Level dBuV	Correct Factor dB	Measure- ment dBuV/m	Limit dBuV/m	Margin dB	Detector	Comment
1	*	5725.000	23.13	40.05	63.18	68.30	-5.12	peak	

**REMARKS:**

- (1) Measurement Value = Reading Level + Correct Factor.
- (2) Margin Level = Measurement Value - Limit Value.

Orthogonal Axis	X		
Test Mode	UNII-2C_TX AX (HE20) Mode 5700 MHz	RU configuration	242/61

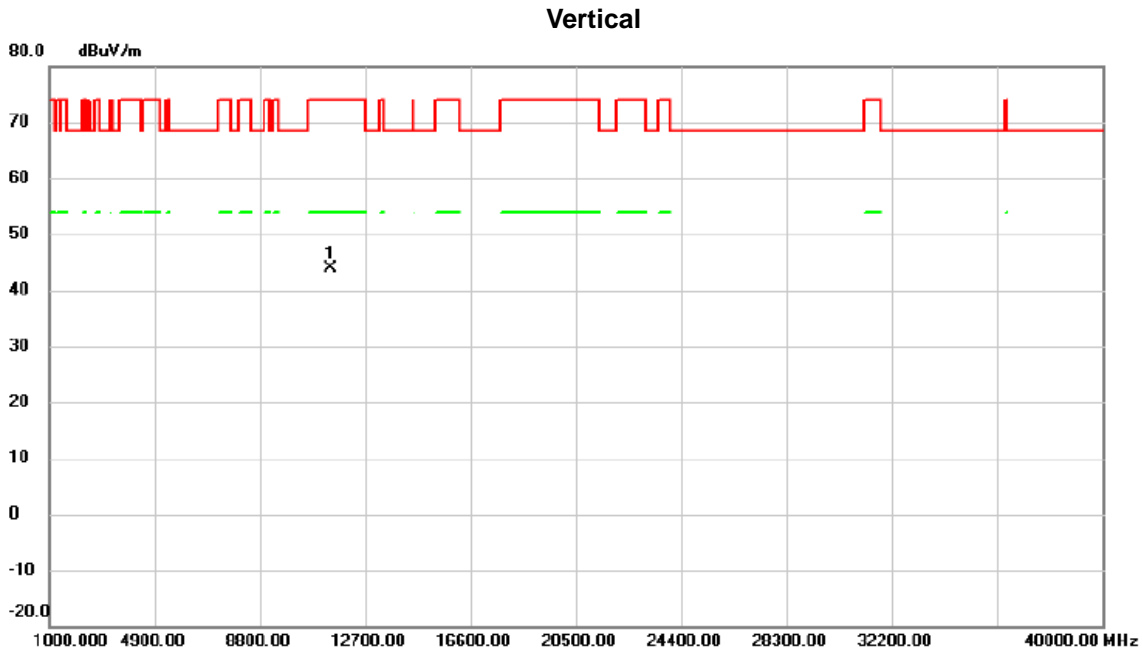

No.	Mk.	Freq. MHz	Reading Level dBuV	Correct Factor dB	Measure- ment dBuV/m	Limit dBuV/m	Margin dB	Detector	Comment
1	*	11400.00	43.31	0.58	43.89	74.00	-30.11	peak	

**REMARKS:**

- (1) Measurement Value = Reading Level + Correct Factor.
- (2) Margin Level = Measurement Value - Limit Value.

Orthogonal Axis	X		
Test Mode	UNII-2C_TX AX (HE20) Mode 5700 MHz	RU configuration	242/61

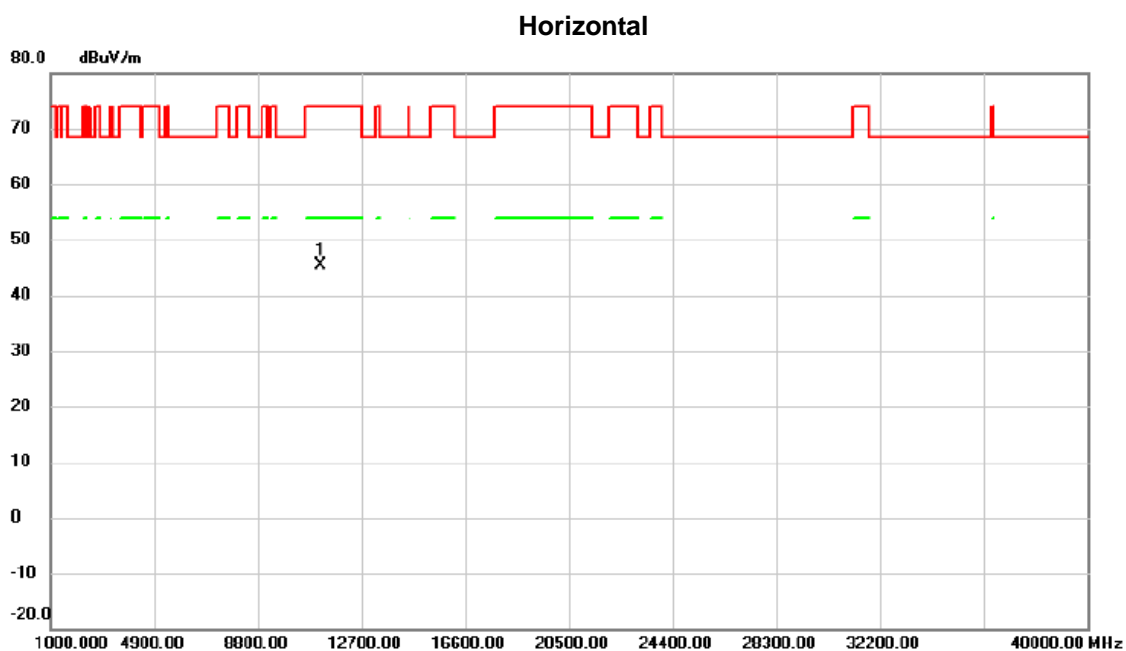

No.	Mk.	Freq. MHz	Reading Level dBuV	Correct Factor dB	Measure- ment dBuV/m	Limit dBuV/m	Margin dB	Detector	Comment
1	*	11160.00	44.48	0.85	45.33	74.00	-28.67	peak	

**REMARKS:**

- (1) Measurement Value = Reading Level + Correct Factor.
- (2) Margin Level = Measurement Value - Limit Value.

Orthogonal Axis	X		
Test Mode	UNII-3_TX AX (HE20) Mode 5745 MHz	RU configuration	52/37

### Vertical

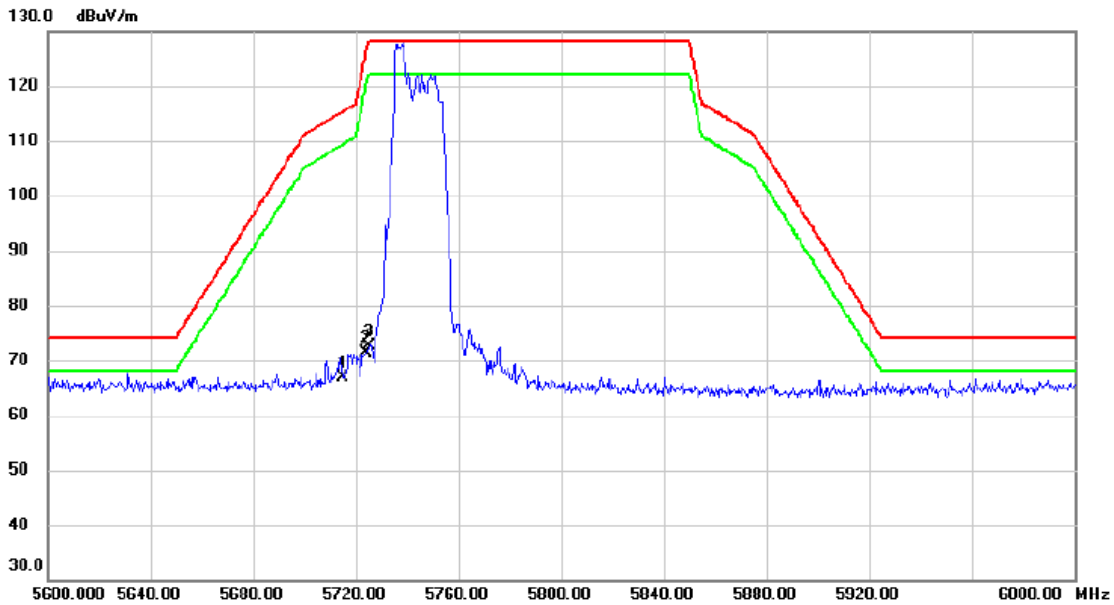

No.	Mk.	Freq. MHz	Reading Level dBuV	Correct Factor dB	Measure- ment dBuV/m	Limit dBuV/m	Margin dB	Detector	Comment
1	*	5715.000	26.98	40.02	67.00	115.40	-48.40	peak	
2		5723.800	31.22	40.04	71.26	125.46	-54.20	peak	
3		5725.000	32.51	40.05	72.56	128.20	-55.64	peak	

**REMARKS:**

- (1) Measurement Value = Reading Level + Correct Factor.
- (2) Margin Level = Measurement Value - Limit Value.

Orthogonal Axis	X		
Test Mode	UNII-3_TX AX (HE20) Mode 5745 MHz	RU configuration	52/37

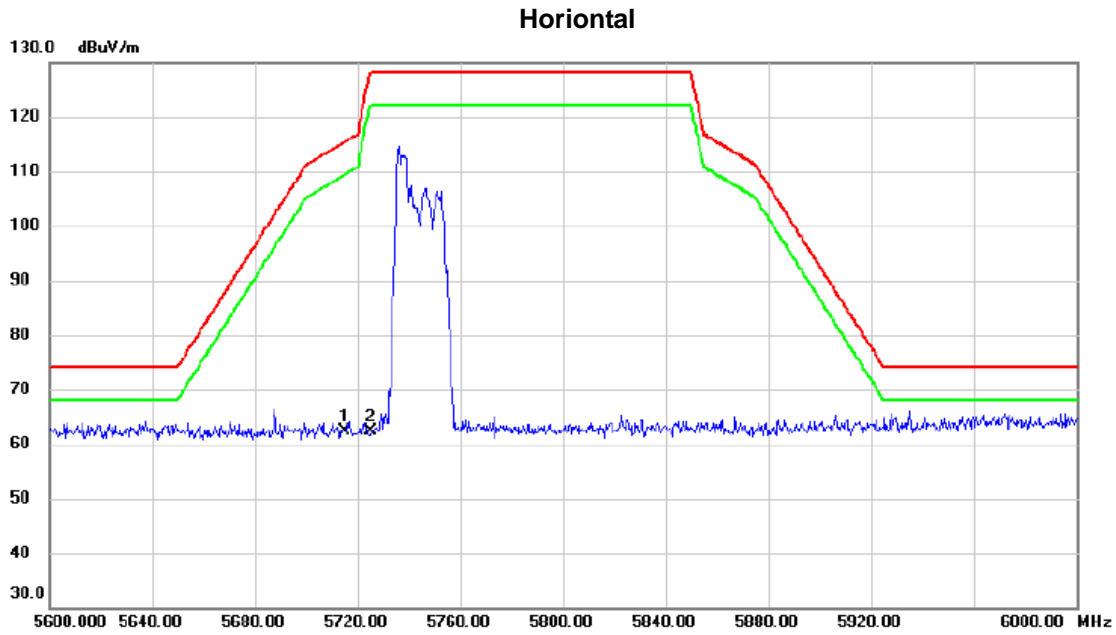

No.	Mk.	Freq. MHz	Reading Level dBuV	Correct Factor dB	Measure- ment dBuV/m	Limit dBuV/m	Margin dB	Detector	Comment
1	*	5715.000	22.44	40.02	62.46	115.40	-52.94	peak	
2		5725.000	22.27	40.05	62.32	128.20	-65.88	peak	

**REMARKS:**

- (1) Measurement Value = Reading Level + Correct Factor.
- (2) Margin Level = Measurement Value - Limit Value.

Orthogonal Axis	X		
Test Mode	UNII-3_TX AX (HE20) Mode 5745 MHz	RU configuration	106/53

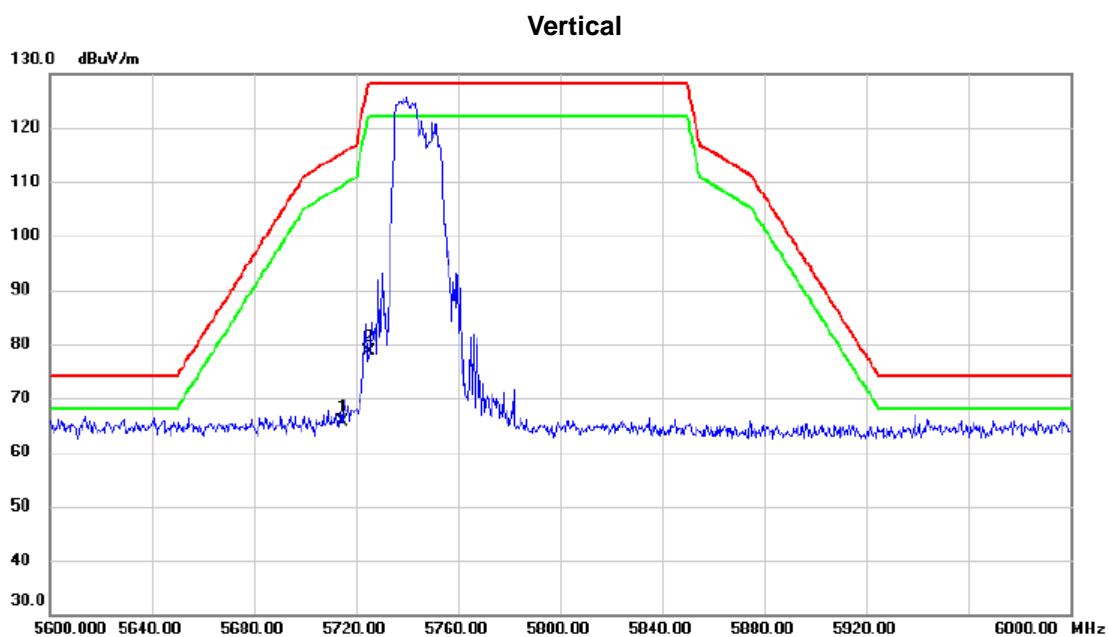

No.	Mk.	Freq. MHz	Reading Level dBuV	Correct Factor dB	Measure- ment dBuV/m	Limit dBuV/m	Margin dB	Detector	Comment
1		5715.000	25.60	40.02	65.62	115.40	-49.78	peak	
2	*	5725.000	38.57	40.05	78.62	128.20	-49.58	peak	

**REMARKS:**

- (1) Measurement Value = Reading Level + Correct Factor.
- (2) Margin Level = Measurement Value - Limit Value.



Orthogonal Axis	X		
Test Mode	UNII-3_TX AX (HE20) Mode 5745 MHz	RU configuration	106/53

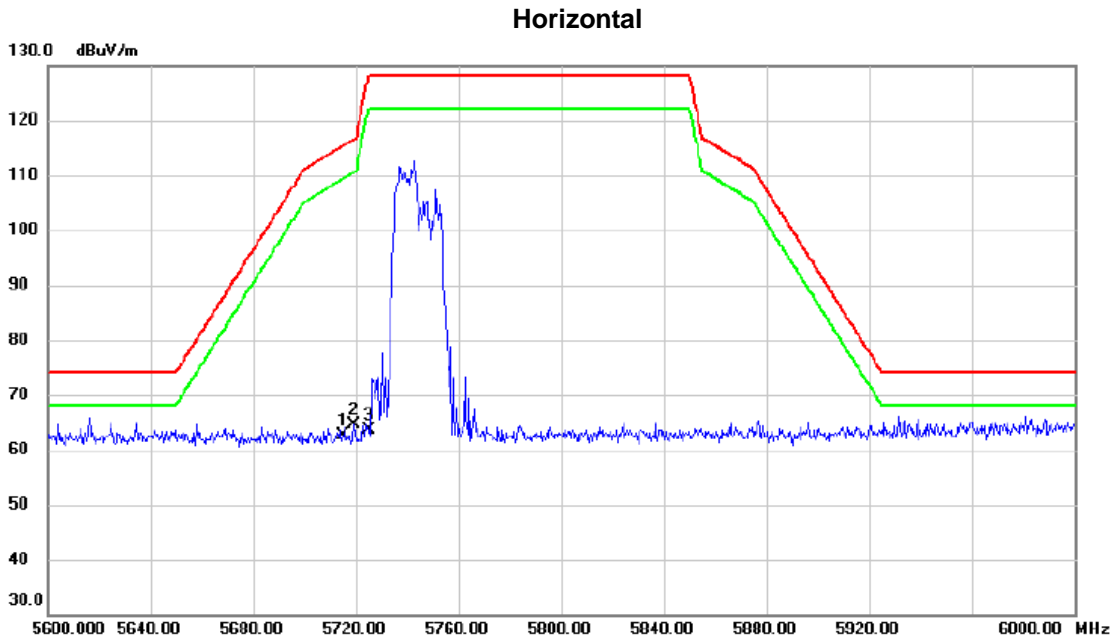

No.	Mk.	Freq. MHz	Reading Level dBuV	Correct Factor dB	Measure- ment dBuV/m	Limit dBuV/m	Margin dB	Detector	Comment
1		5715.000	22.72	40.02	62.74	115.40	-52.66	peak	
2	*	5719.400	24.51	40.03	64.54	116.63	-52.09	peak	
3		5725.000	23.55	40.05	63.60	128.20	-64.60	peak	

**REMARKS:**

- (1) Measurement Value = Reading Level + Correct Factor.
- (2) Margin Level = Measurement Value - Limit Value.

Orthogonal Axis	X		
Test Mode	UNII-3_TX AX (HE20) Mode 5745 MHz	RU configuration	242/61

### Vertical

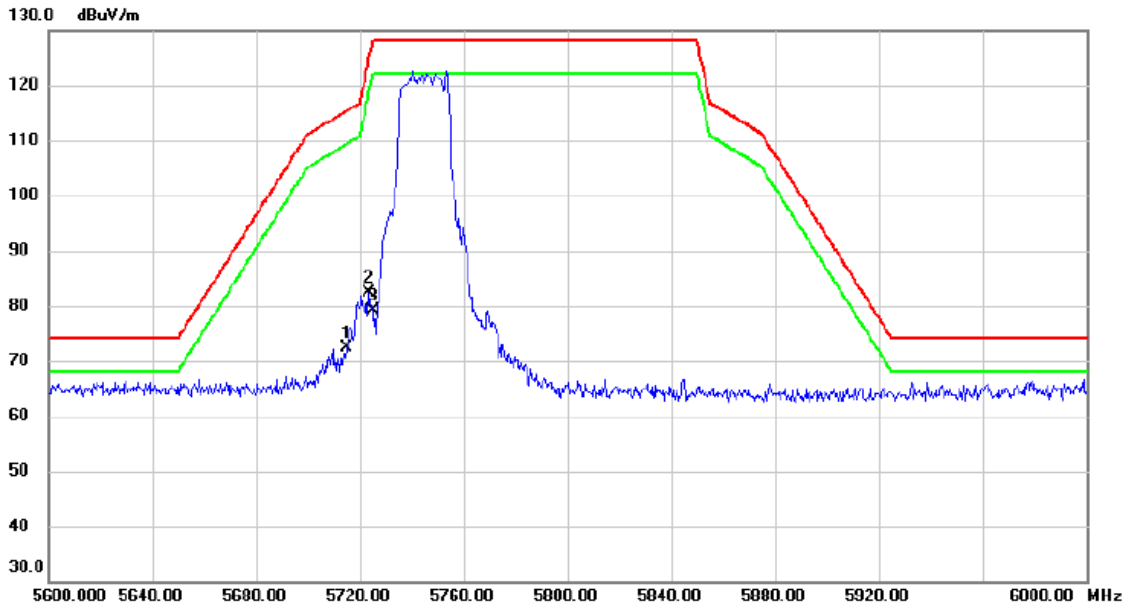

No.	Mk.	Freq. MHz	Reading Level dBuV	Correct Factor dB	Measure- ment dBuV/m	Limit dBuV/m	Margin dB	Detector	Comment
1		5715.000	32.48	40.02	72.50	115.40	-42.90	peak	
2	*	5723.400	42.34	40.04	82.38	124.55	-42.17	peak	
3		5725.000	39.04	40.05	79.09	128.20	-49.11	peak	

**REMARKS:**

- (1) Measurement Value = Reading Level + Correct Factor.
- (2) Margin Level = Measurement Value - Limit Value.

Orthogonal Axis	X		
Test Mode	UNII-3_TX AX (HE20) Mode 5745 MHz	RU configuration	242/61

### Horizontal

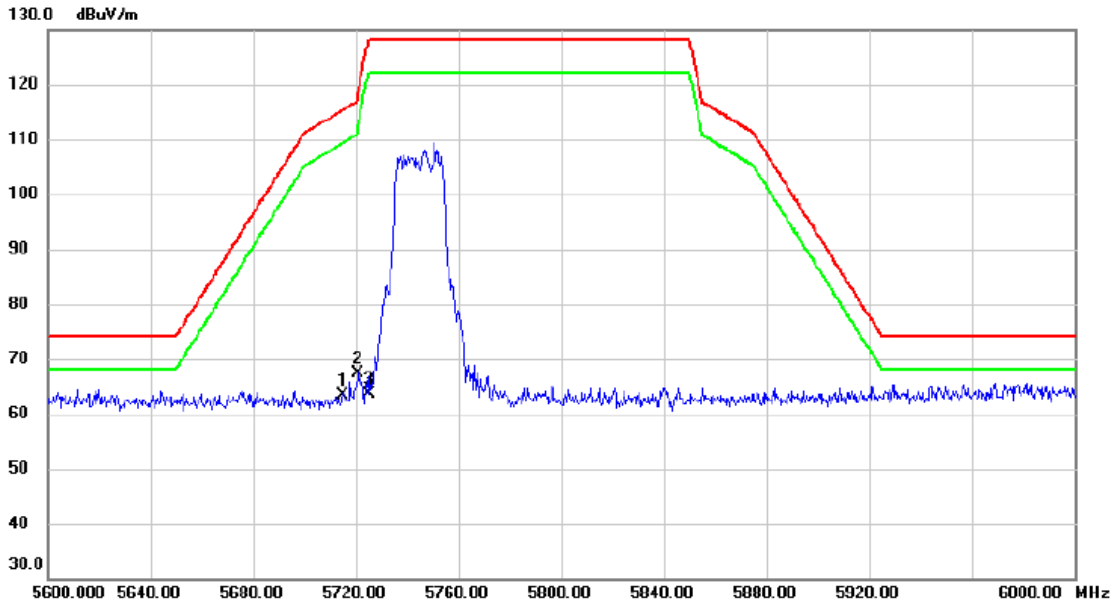

No.	Mk.	Freq. MHz	Reading Level dBuV	Correct Factor dB	Measure- ment dBuV/m	Limit dBuV/m	Margin dB	Detector	Comment
1		5715.000	23.32	40.02	63.34	115.40	-52.06	peak	
2	*	5720.800	27.47	40.03	67.50	118.62	-51.12	peak	
3		5725.000	23.61	40.05	63.66	128.20	-64.54	peak	

**REMARKS:**

- (1) Measurement Value = Reading Level + Correct Factor.
- (2) Margin Level = Measurement Value - Limit Value.

Orthogonal Axis	X		
Test Mode	UNII-3_TX AX (HE20) Mode 5745 MHz	RU configuration	242/61

### Vertical

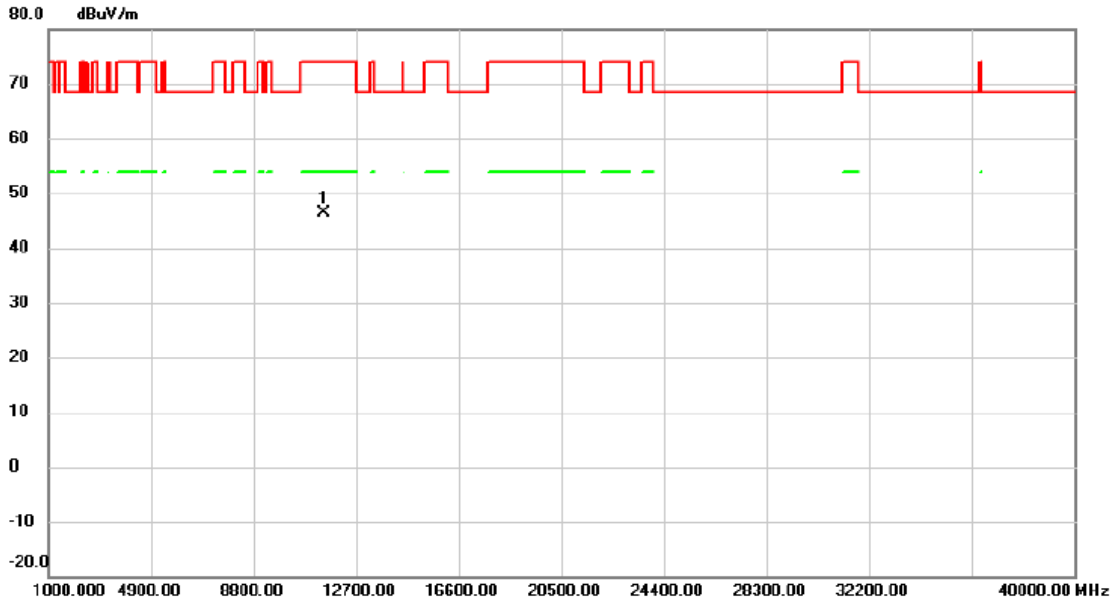

No.	Mk.	Freq. MHz	Reading Level dBuV	Correct Factor dB	Measure- ment dBuV/m	Limit dBuV/m	Margin dB	Detector	Comment
1	*	11490.00	45.98	0.48	46.46	74.00	-27.54	peak	

**REMARKS:**

- (1) Measurement Value = Reading Level + Correct Factor.
- (2) Margin Level = Measurement Value - Limit Value.

Orthogonal Axis	X		
Test Mode	UNII-3_TX AX (HE20) Mode 5745 MHz	RU configuration	242/61

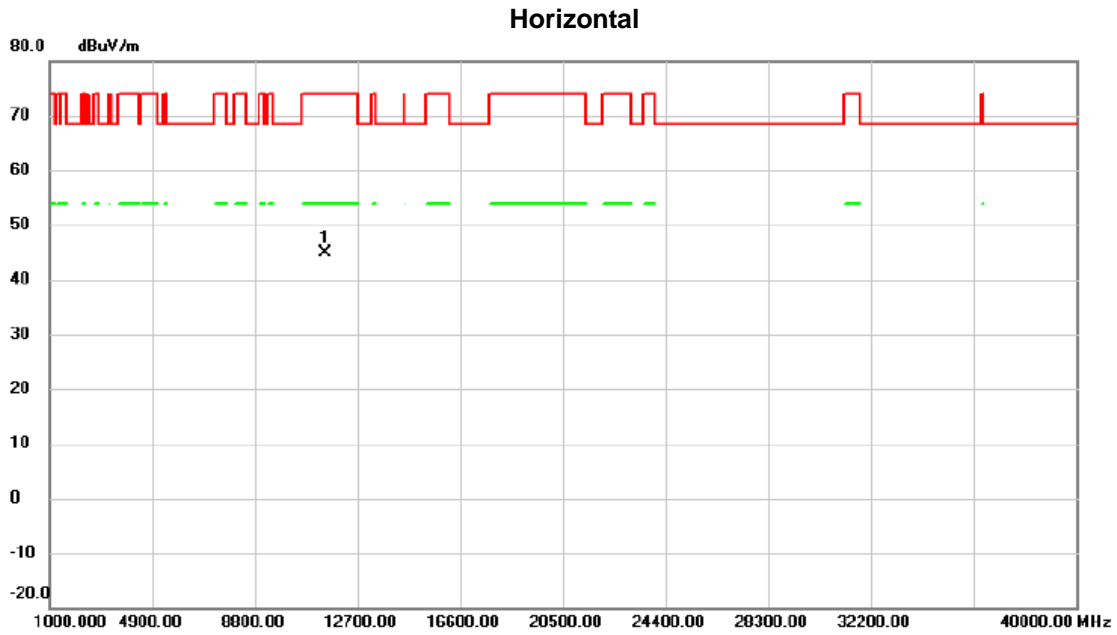

No.	Mk.	Freq.	Reading Level	Correct Factor	Measurement	Limit	Margin		
		MHz	dBuV	dB	dBuV/m	dBuV/m	dB	Detector	Comment
1	*	11490.00	44.35	0.48	44.83	74.00	-29.17	peak	

**REMARKS:**

- (1) Measurement Value = Reading Level + Correct Factor.
- (2) Margin Level = Measurement Value - Limit Value.

Orthogonal Axis	X		
Test Mode	UNII-3_TX AX (HE20) Mode 5785 MHz	RU configuration	52/37

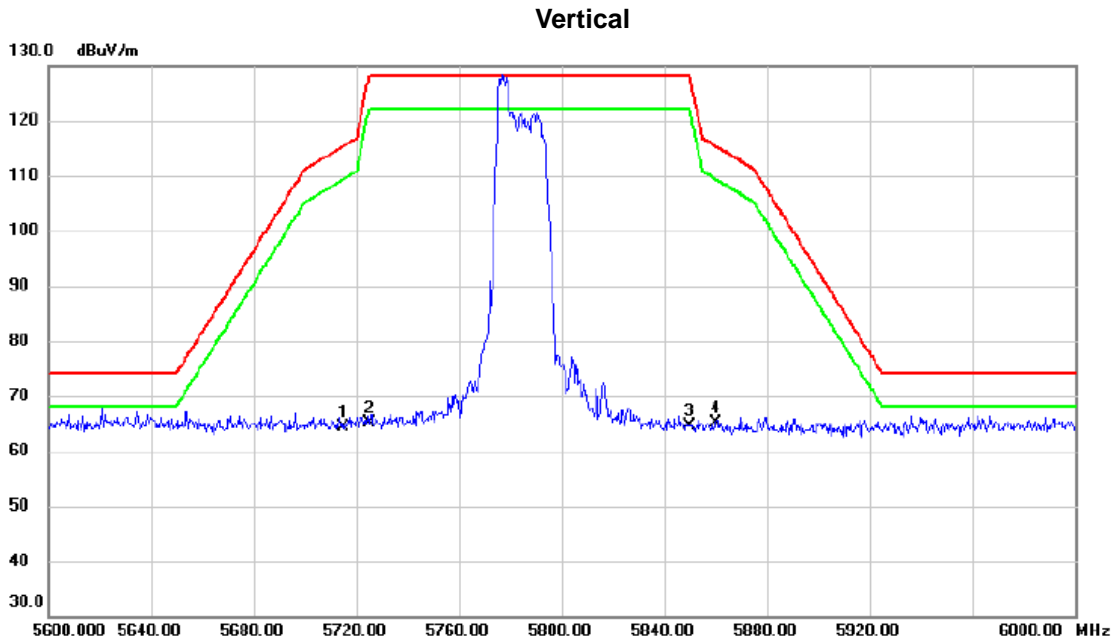

No.	Mk.	Freq. MHz	Reading Level dBuV	Correct Factor dB	Measure- ment dBuV/m	Limit dBuV/m	Margin dB	Detector	Comment
1		5715.000	24.30	40.02	64.32	115.40	-51.08	peak	
2		5725.000	25.03	40.05	65.08	128.20	-63.12	peak	
3		5850.000	24.34	40.34	64.68	128.20	-63.52	peak	
4	*	5860.000	24.71	40.36	65.07	115.40	-50.33	peak	

**REMARKS:**

- (1) Measurement Value = Reading Level + Correct Factor.
- (2) Margin Level = Measurement Value - Limit Value.

Orthogonal Axis	X		
Test Mode	UNII-3_TX AX (HE20) Mode 5785 MHz	RU configuration	52/37

### Horizontal

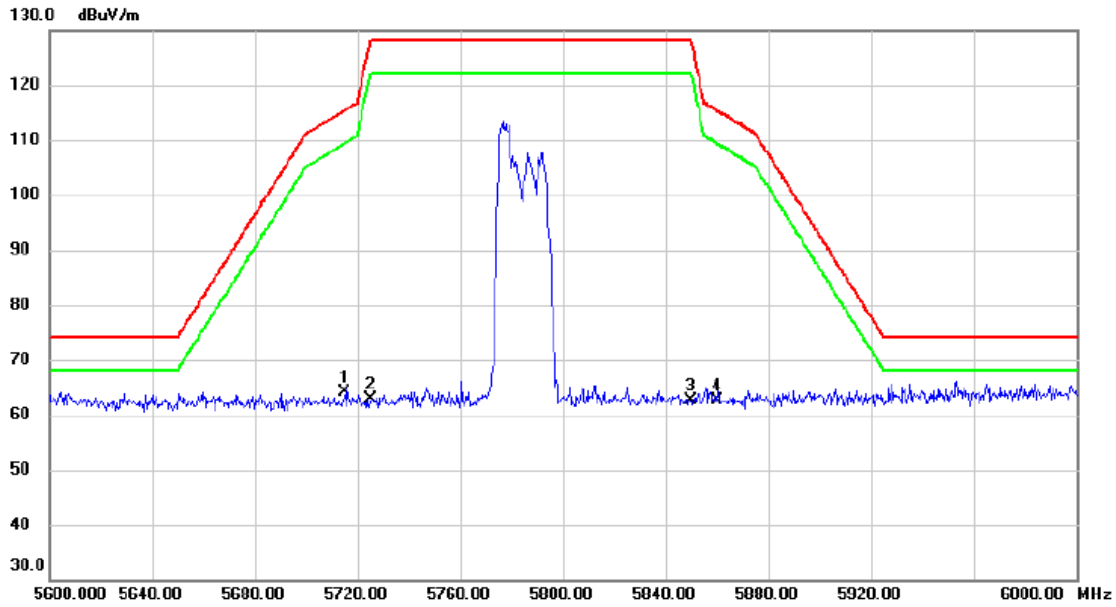

No.	Mk.	Freq.	Reading Level	Correct Factor	Measurement	Limit	Margin	Detector	Comment
		MHz	dBuV	dB	dBuV/m	dBuV/m	dB		
1	*	5715.000	24.04	40.02	64.06	115.40	-51.34	peak	
2		5725.000	22.75	40.05	62.80	128.20	-65.40	peak	
3		5850.000	22.24	40.34	62.58	128.20	-65.62	peak	
4		5860.000	22.35	40.36	62.71	115.40	-52.69	peak	

**REMARKS:**

- (1) Measurement Value = Reading Level + Correct Factor.
- (2) Margin Level = Measurement Value - Limit Value.

Orthogonal Axis	X		
Test Mode	UNII-3_TX AX (HE20) Mode 5785 MHz	RU configuration	106/53

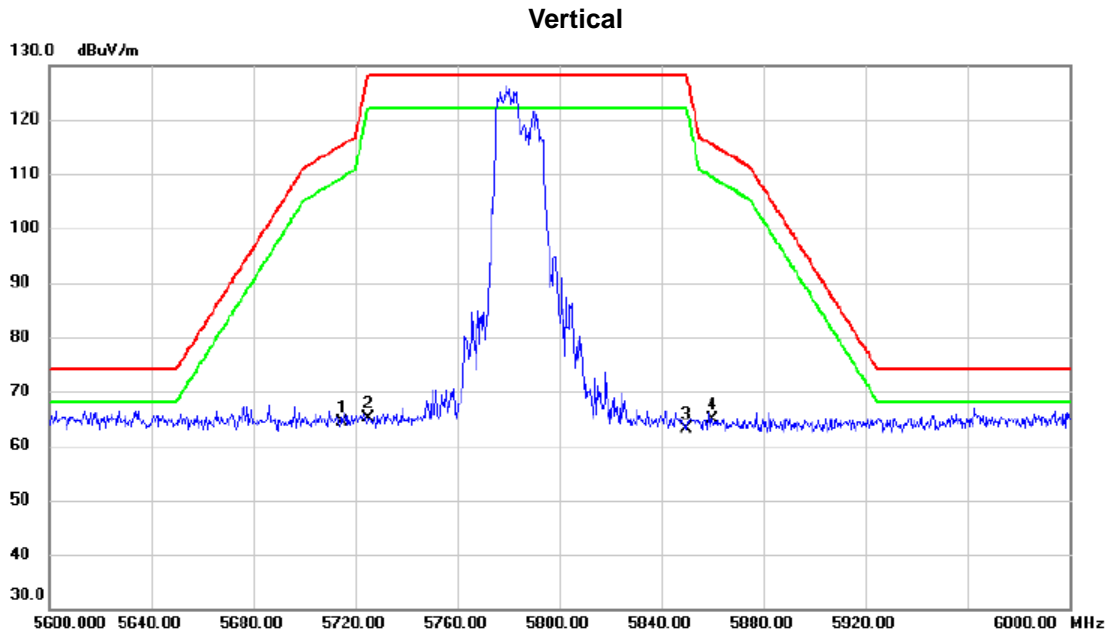

No.	Mk.	Freq. MHz	Reading Level dBuV	Correct Factor dB	Measure- ment dBuV/m	Limit dBuV/m	Margin dB	Detector	Comment
1		5715.000	24.44	40.02	64.46	115.40	-50.94	peak	
2		5725.000	24.99	40.05	65.04	128.20	-63.16	peak	
3		5850.000	22.91	40.34	63.25	128.20	-64.95	peak	
4	*	5860.000	24.58	40.36	64.94	115.40	-50.46	peak	

**REMARKS:**

- (1) Measurement Value = Reading Level + Correct Factor.
- (2) Margin Level = Measurement Value - Limit Value.



Orthogonal Axis	X		
Test Mode	UNII-3_TX AX (HE20) Mode 5785 MHz	RU configuration	106/53

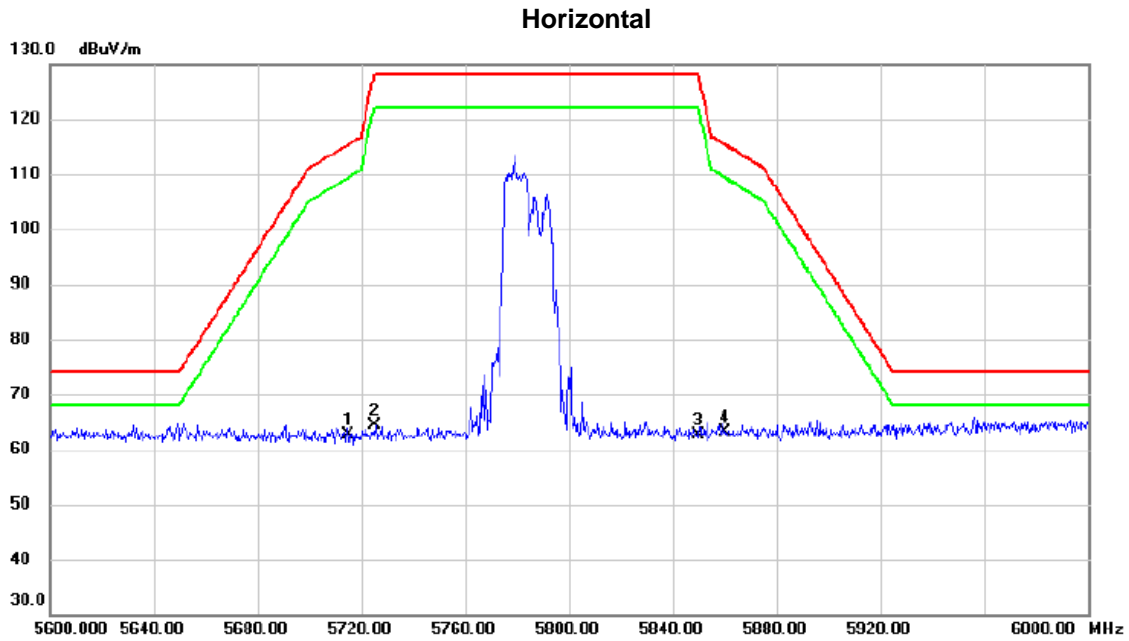

No.	Mk.	Freq.	Reading Level	Correct Factor	Measurement	Limit	Margin	Detector	Comment
		MHz	dBuV	dB	dBuV/m	dBuV/m	dB		
1		5715.000	22.68	40.02	62.70	115.40	-52.70	peak	
2		5725.000	24.39	40.05	64.44	128.20	-63.76	peak	
3		5850.000	22.33	40.34	62.67	128.20	-65.53	peak	
4	*	5860.000	22.73	40.36	63.09	115.40	-52.31	peak	

**REMARKS:**

(1) Measurement Value = Reading Level + Correct Factor.

(2) Margin Level = Measurement Value - Limit Value.

Orthogonal Axis	X		
Test Mode	UNII-3_TX AX (HE20) Mode 5785 MHz	RU configuration	242/61

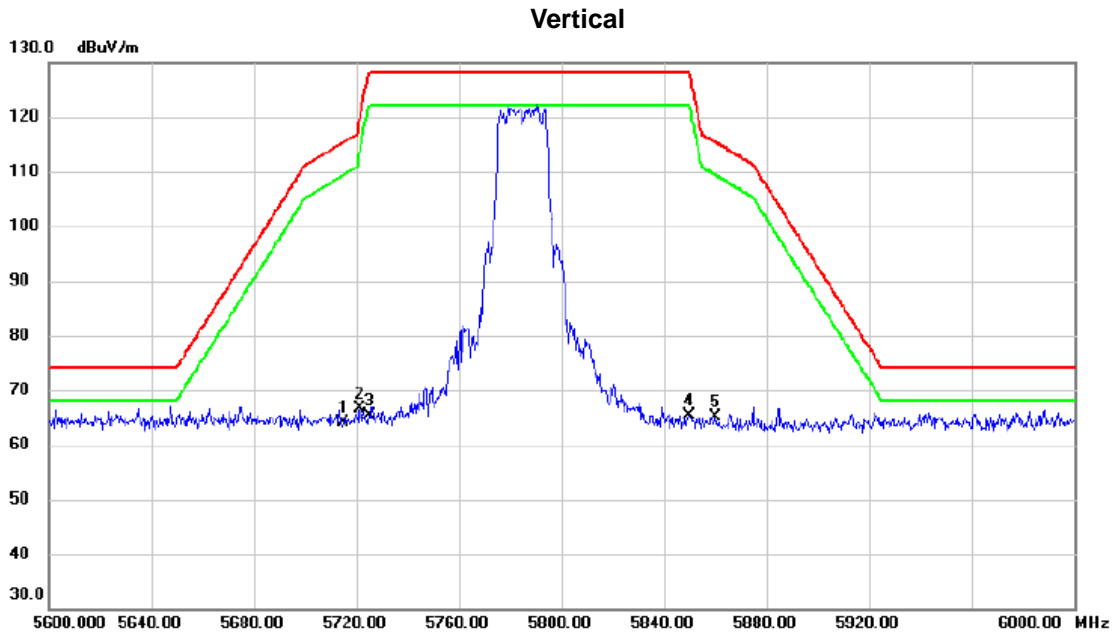

No.	Mk.	Freq. MHz	Reading Level dBuV	Correct Factor dB	Measure- ment dBuV/m	Limit dBuV/m	Margin dB	Detector	Comment
1		5715.000	24.21	40.02	64.23	115.40	-51.17	peak	
2		5721.200	26.48	40.04	66.52	119.54	-53.02	peak	
3		5725.000	25.28	40.05	65.33	128.20	-62.87	peak	
4		5850.000	25.03	40.34	65.37	128.20	-62.83	peak	
5	*	5860.000	24.66	40.36	65.02	115.40	-50.38	peak	

**REMARKS:**

- (1) Measurement Value = Reading Level + Correct Factor.
- (2) Margin Level = Measurement Value - Limit Value.

Orthogonal Axis	X		
Test Mode	UNII-3_TX AX (HE20) Mode 5785 MHz	RU configuration	242/61

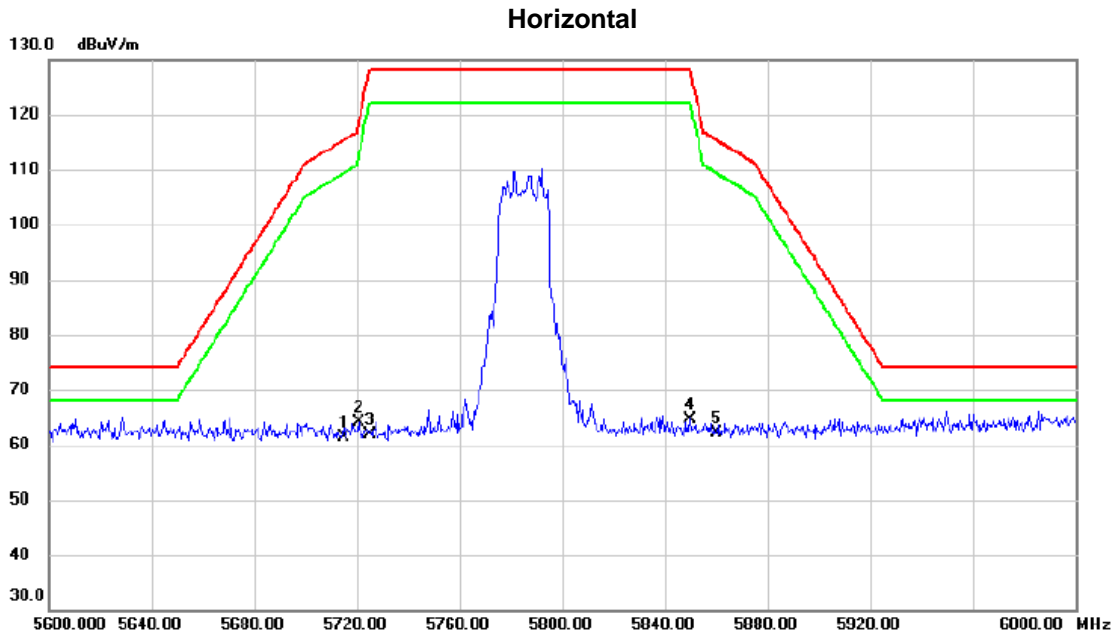

No.	Mk.	Freq. MHz	Reading Level dBuV	Correct Factor dB	Measure- ment dBuV/m	Limit dBuV/m	Margin dB	Detector	Comment
1		5715.000	21.25	40.02	61.27	115.40	-54.13	peak	
2		5721.000	24.10	40.04	64.14	119.08	-54.94	peak	
3		5725.000	21.73	40.05	61.78	128.20	-66.42	peak	
4		5850.000	24.25	40.34	64.59	128.20	-63.61	peak	
5	*	5860.000	21.79	40.36	62.15	115.40	-53.25	peak	

**REMARKS:**

(1) Measurement Value = Reading Level + Correct Factor.

(2) Margin Level = Measurement Value - Limit Value.

Orthogonal Axis	X		
Test Mode	UNII-3_TX AX (HE20) Mode 5785 MHz	RU configuration	242/61

### Vertical

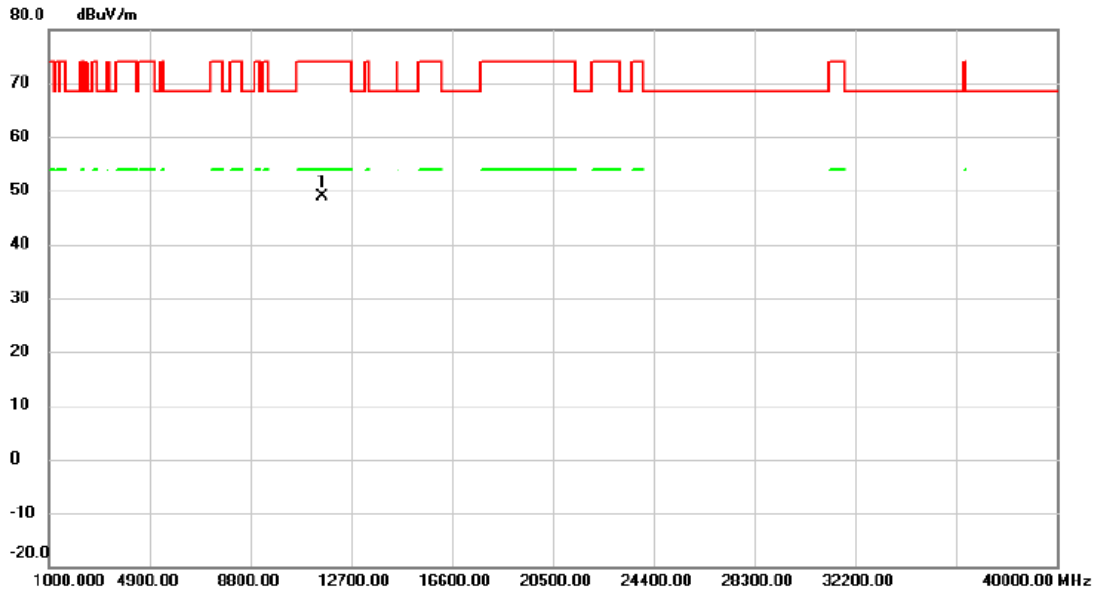

No.	Mk.	Freq.	Reading Level	Correct Factor	Measurement	Limit	Margin	Detector	Comment
		MHz	dBuV	dB	dBuV/m	dBuV/m	dB		
1	*	11570.00	48.30	0.47	48.77	74.00	-25.23	peak	

**REMARKS:**

- (1) Measurement Value = Reading Level + Correct Factor.
- (2) Margin Level = Measurement Value - Limit Value.

Orthogonal Axis	X		
Test Mode	UNII-3_TX AX (HE20) Mode 5785 MHz	RU configuration	242/61

### Horizontal

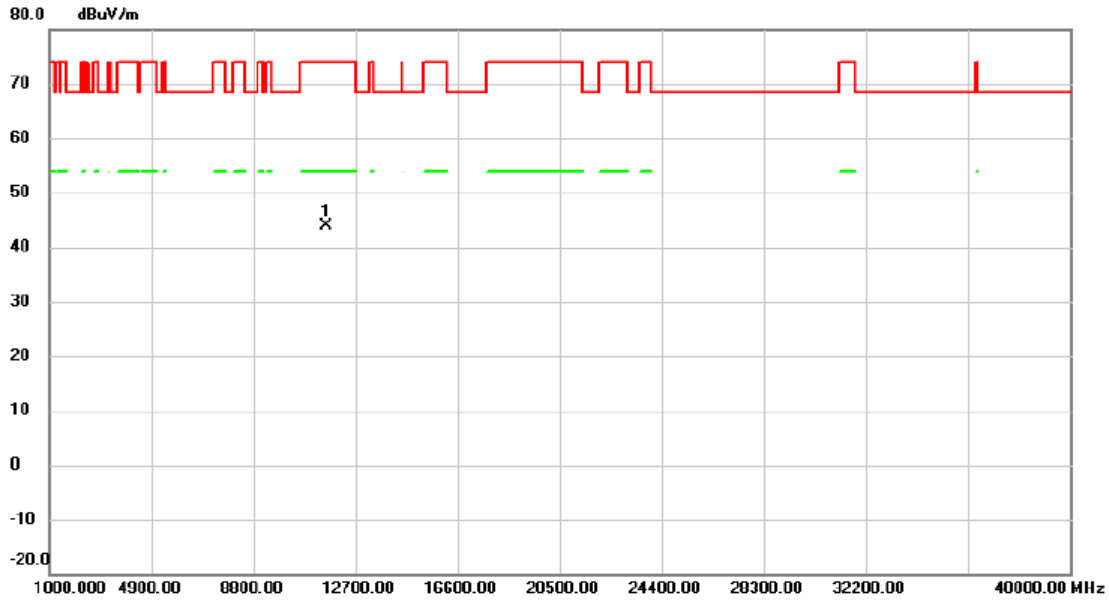

No.	Mk.	Freq.	Reading Level	Correct Factor	Measurement	Limit	Margin	Detector	Comment
		MHz	dBuV	dB	dBuV/m	dBuV/m	dB		
1	*	11570.00	43.45	0.47	43.92	74.00	-30.08	peak	

**REMARKS:**

- (1) Measurement Value = Reading Level + Correct Factor.
- (2) Margin Level = Measurement Value - Limit Value.

Orthogonal Axis	X		
Test Mode	UNII-3_TX AX (HE20) Mode 5825 MHz	RU configuration	52/37

### Vertical

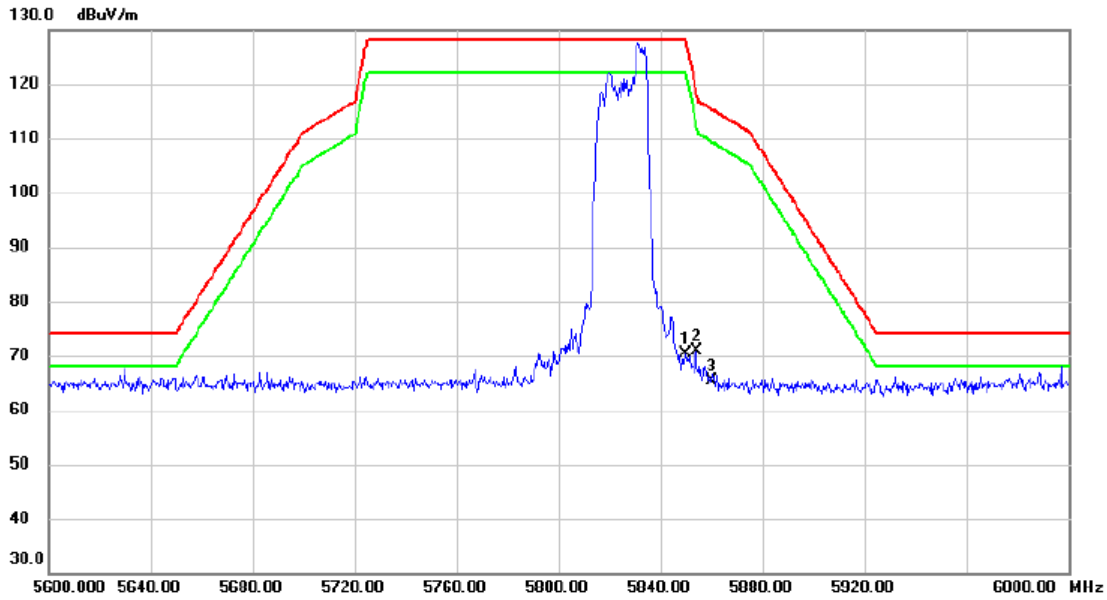

No.	Mk.	Freq. MHz	Reading Level dBuV	Correct Factor dB	Measure- ment dBuV/m	Limit dBuV/m	Margin dB	Detector	Comment
1		5850.000	30.11	40.34	70.45	128.20	-57.75	peak	
2	*	5854.000	30.47	40.35	70.82	119.08	-48.26	peak	
3		5860.000	25.02	40.36	65.38	115.40	-50.02	peak	

**REMARKS:**

- (1) Measurement Value = Reading Level + Correct Factor.
- (2) Margin Level = Measurement Value - Limit Value.

Orthogonal Axis	X		
Test Mode	UNII-3_TX AX (HE20) Mode 5825 MHz	RU configuration	52/37

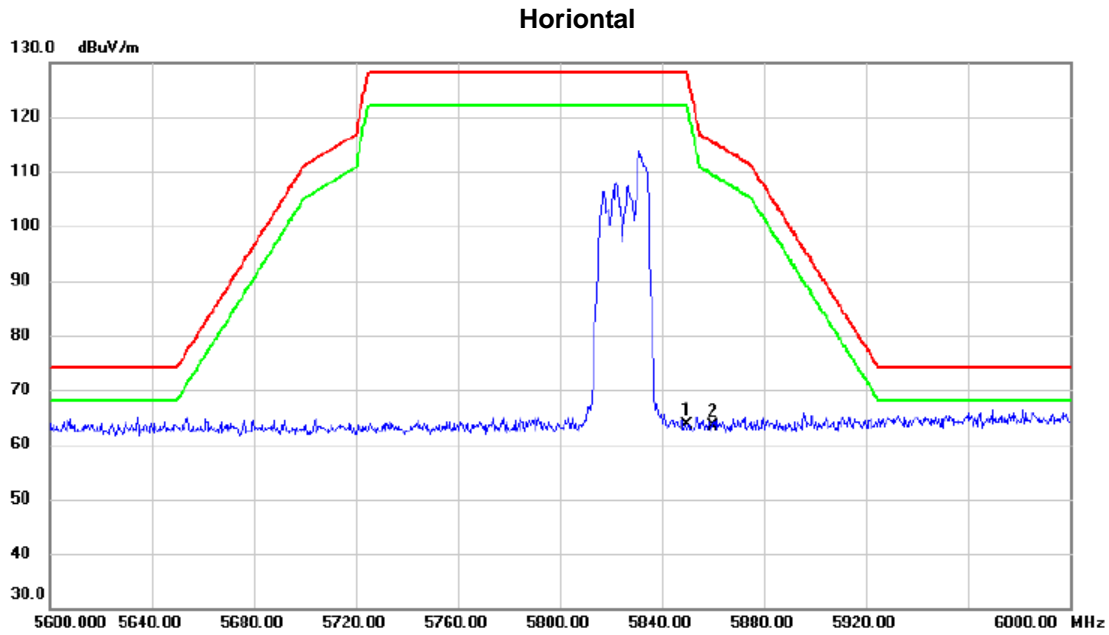

No.	Mk.	Freq. MHz	Reading Level dBuV	Correct Factor dB	Measure- ment dBuV/m	Limit dBuV/m	Margin dB	Detector	Comment
1		5850.000	23.20	40.34	63.54	128.20	-64.66	peak	
2	*	5860.000	22.95	40.36	63.31	115.40	-52.09	peak	

**REMARKS:**

- (1) Measurement Value = Reading Level + Correct Factor.
- (2) Margin Level = Measurement Value - Limit Value.

Orthogonal Axis	X		
Test Mode	UNII-3_TX AX (HE20) Mode 5825 MHz	RU configuration	106/53

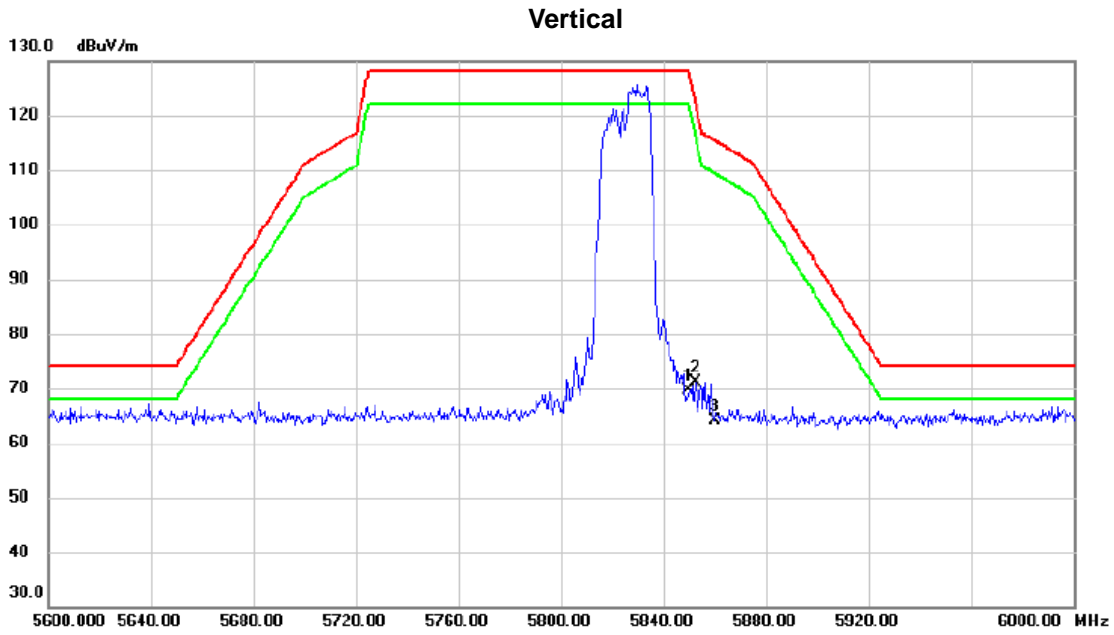

No.	Mk.	Freq. MHz	Reading Level dBuV	Correct Factor dB	Measure- ment dBuV/m	Limit dBuV/m	Margin dB	Detector	Comment
1		5850.000	29.31	40.34	69.65	128.20	-58.55	peak	
2	*	5852.600	30.86	40.35	71.21	122.27	-51.06	peak	
3		5860.000	23.87	40.36	64.23	115.40	-51.17	peak	

**REMARKS:**

- (1) Measurement Value = Reading Level + Correct Factor.
- (2) Margin Level = Measurement Value - Limit Value.



Orthogonal Axis	X		
Test Mode	UNII-3_TX AX (HE20) Mode 5825 MHz	RU configuration	106/53

### Horizontal

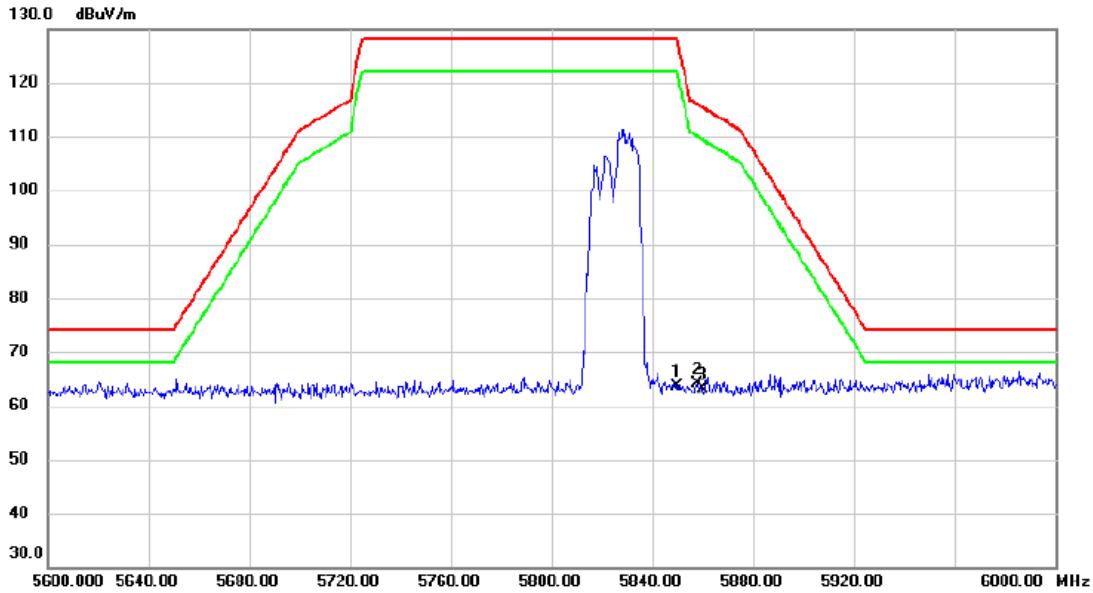

No.	Mk.	Freq. MHz	Reading Level dBuV	Correct Factor dB	Measure- ment dBuV/m	Limit dBuV/m	Margin dB	Detector	Comment
1		5850.000	23.23	40.34	63.57	128.20	-64.63	peak	
2	*	5857.600	23.67	40.36	64.03	116.07	-52.04	peak	
3		5860.000	22.69	40.36	63.05	115.40	-52.35	peak	

**REMARKS:**

- (1) Measurement Value = Reading Level + Correct Factor.
- (2) Margin Level = Measurement Value - Limit Value.

Orthogonal Axis	X		
Test Mode	UNII-3_TX AX (HE20) Mode 5825 MHz	RU configuration	242/61

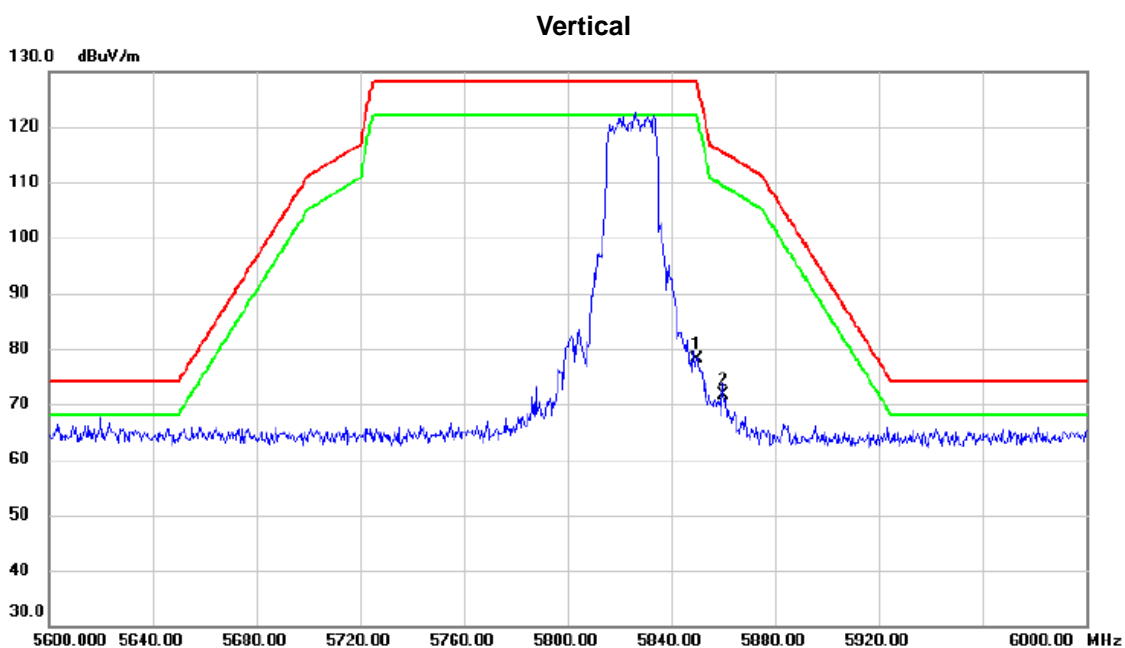

No.	Mk.	Freq. MHz	Reading Level dBuV	Correct Factor dB	Measure- ment dBuV/m	Limit dBuV/m	Margin dB	Detector	Comment
1		5850.000	37.89	40.34	78.23	128.20	-49.97	peak	
2	*	5860.000	31.32	40.36	71.68	115.40	-43.72	peak	

**REMARKS:**

- (1) Measurement Value = Reading Level + Correct Factor.
- (2) Margin Level = Measurement Value - Limit Value.

Orthogonal Axis	X		
Test Mode	UNII-3_TX AX (HE20) Mode 5825 MHz	RU configuration	242/61

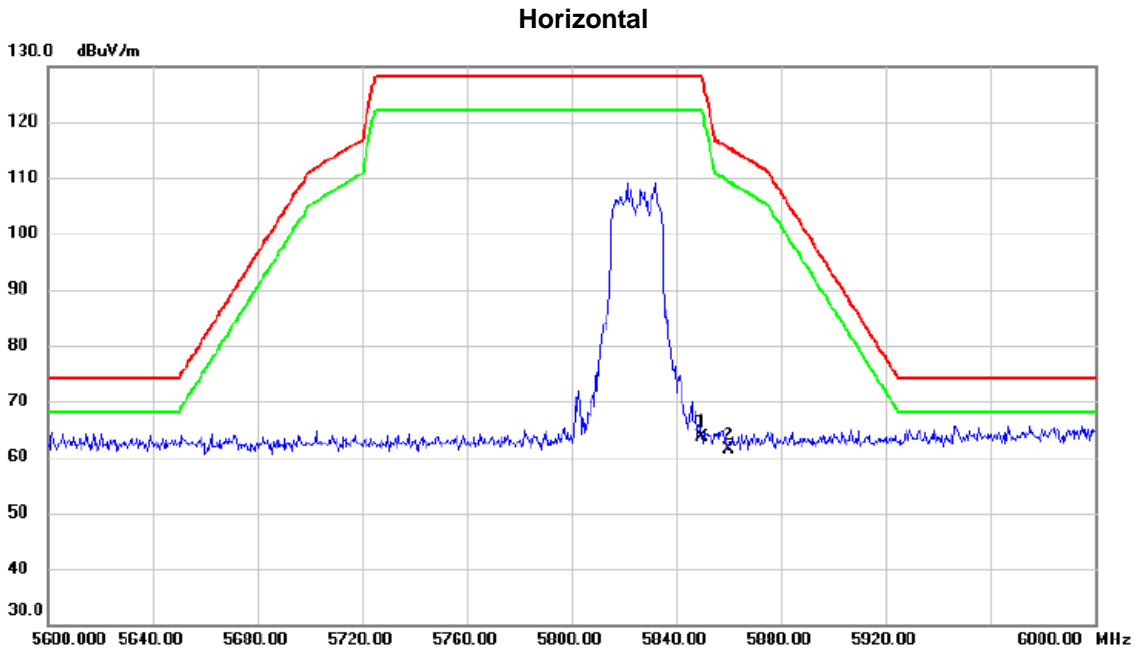

No.	Mk.	Freq. MHz	Reading Level dBuV	Correct Factor dB	Measure- ment dBuV/m	Limit dBuV/m	Margin dB	Detector	Comment
1		5850.000	23.33	40.34	63.67	128.20	-64.53	peak	
2	*	5860.000	21.05	40.36	61.41	115.40	-53.99	peak	

**REMARKS:**

- (1) Measurement Value = Reading Level + Correct Factor.
- (2) Margin Level = Measurement Value - Limit Value.

Orthogonal Axis	X		
Test Mode	UNII-3_TX AX (HE20) Mode 5825 MHz	RU configuration	242/61

### Vertical

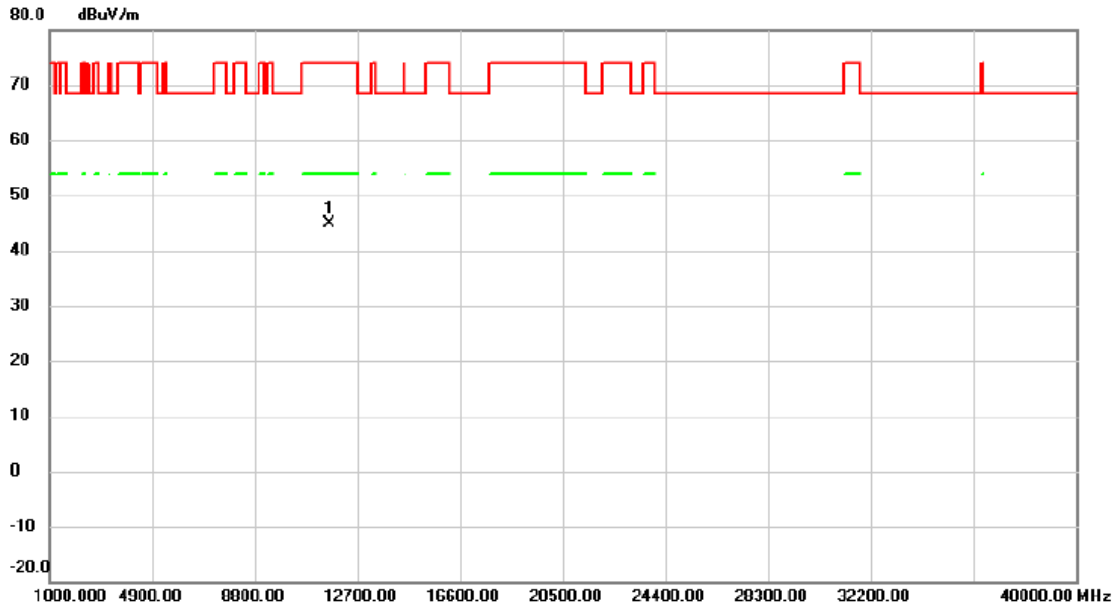

No.	Mk.	Freq. MHz	Reading Level dBuV	Correct Factor dB	Measure- ment dBuV/m	Limit dBuV/m	Margin dB	Detector	Comment
1	*	11650.00	44.47	0.48	44.95	74.00	-29.05	peak	

**REMARKS:**

- (1) Measurement Value = Reading Level + Correct Factor.
- (2) Margin Level = Measurement Value - Limit Value.

Orthogonal Axis	X		
Test Mode	UNII-3_TX AX (HE20) Mode 5825 MHz	RU configuration	242/61

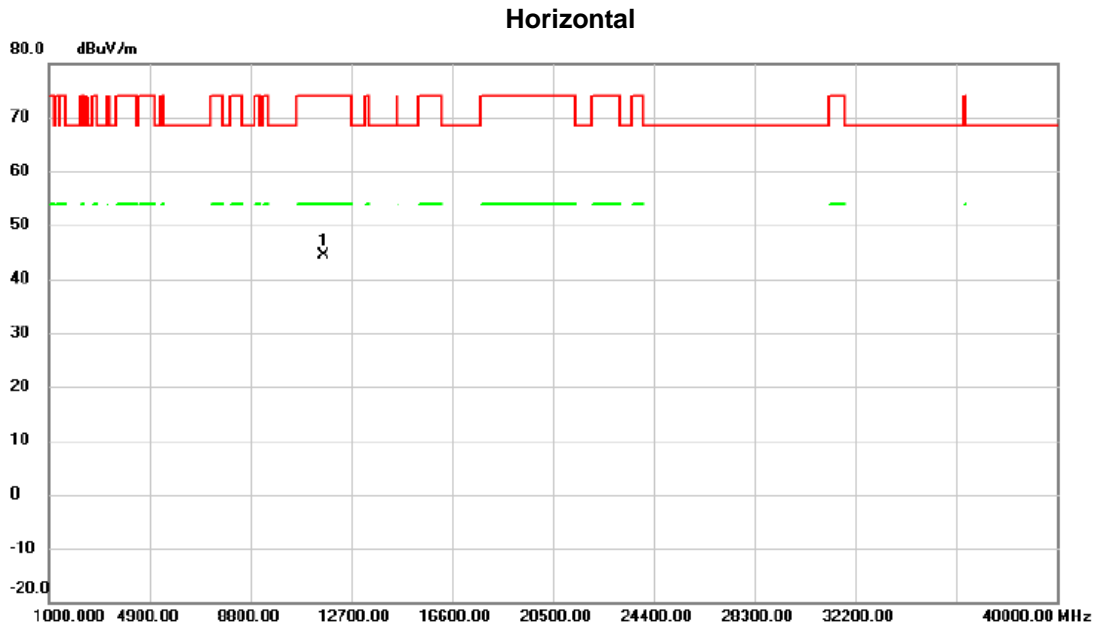

No.	Mk.	Freq. MHz	Reading Level dBuV	Correct Factor dB	Measure- ment dBuV/m	Limit dBuV/m	Margin dB	Detector	Comment
1	*	11650.00	43.84	0.48	44.32	74.00	-29.68	peak	

**REMARKS:**

- (1) Measurement Value = Reading Level + Correct Factor.
- (2) Margin Level = Measurement Value - Limit Value.

Orthogonal Axis	X		
Test Mode	UNII-1_TX AX (HE40) Mode 5190 MHz	RU configuration	52/37

### Vertical

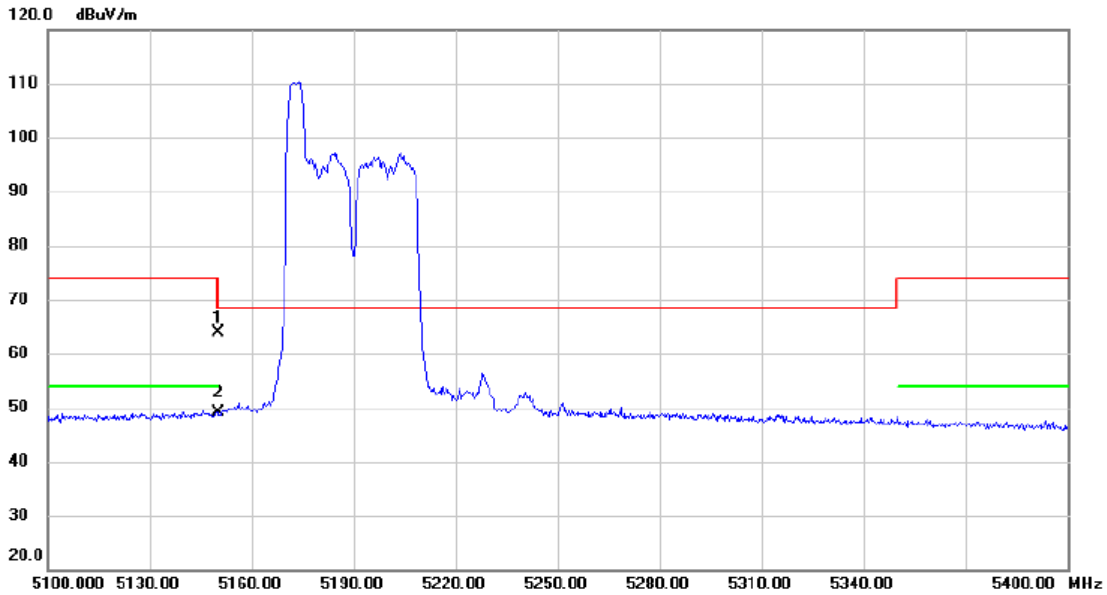

No.	Mk.	Freq. MHz	Reading Level dBuV	Correct Factor dB	Measure- ment dBuV/m	Limit dBuV/m	Margin dB	Detector	Comment
1		5150.000	24.87	39.07	63.94	74.00	-10.06	peak	
2	*	5150.000	10.08	39.07	49.15	54.00	-4.85	AVG	

**REMARKS:**

- (1) Measurement Value = Reading Level + Correct Factor.
- (2) Margin Level = Measurement Value - Limit Value.

Orthogonal Axis	X		
Test Mode	UNII-1_TX AX (HE40) Mode 5190 MHz	RU configuration	52/37

### Horizontal

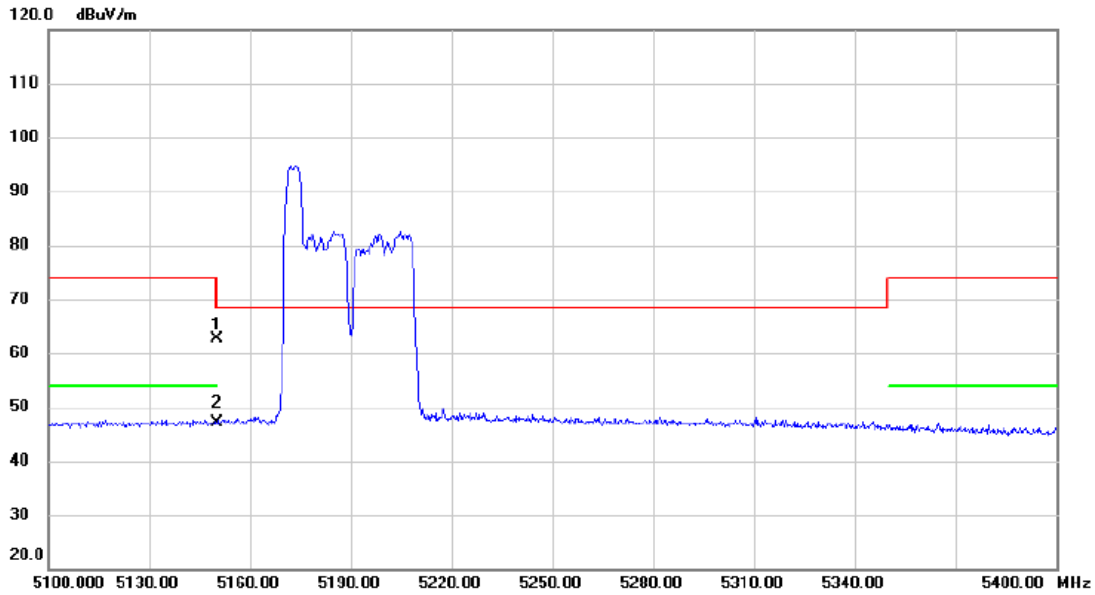

No.	Mk.	Freq. MHz	Reading Level dBuV	Correct Factor dB	Measure- ment dBuV/m	Limit dBuV/m	Margin dB	Detector	Comment
1		5150.000	23.55	39.07	62.62	74.00	-11.38	peak	
2	*	5150.000	7.94	39.07	47.01	54.00	-6.99	AVG	

**REMARKS:**

- (1) Measurement Value = Reading Level + Correct Factor.
- (2) Margin Level = Measurement Value - Limit Value.

Orthogonal Axis	X		
Test Mode	UNII-1_TX AX (HE40) Mode 5190 MHz	RU configuration	106/53

### Vertical

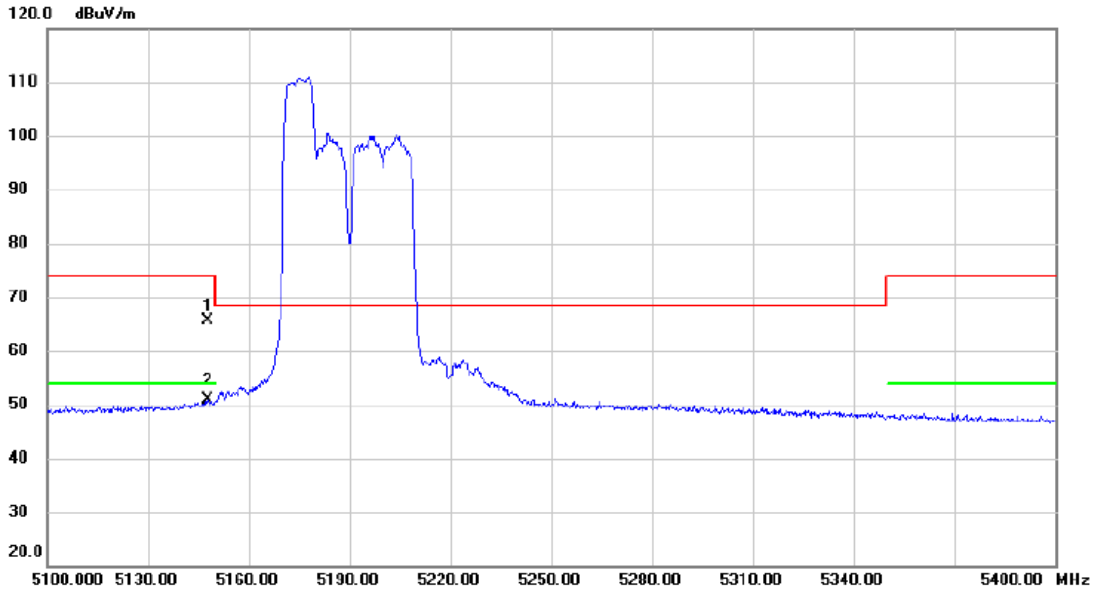

No.	Mk.	Freq. MHz	Reading Level dBuV	Correct Factor dB	Measure- ment dBuV/m	Limit dBuV/m	Margin dB	Detector	Comment
1		5147.700	26.51	39.07	65.58	74.00	-8.42	peak	
2	*	5147.700	11.82	39.07	50.89	54.00	-3.11	AVG	

**REMARKS:**

- (1) Measurement Value = Reading Level + Correct Factor.
- (2) Margin Level = Measurement Value - Limit Value.



Orthogonal Axis	X		
Test Mode	UNII-1_TX AX (HE40) Mode 5190 MHz	RU configuration	106/53

### Horizontal

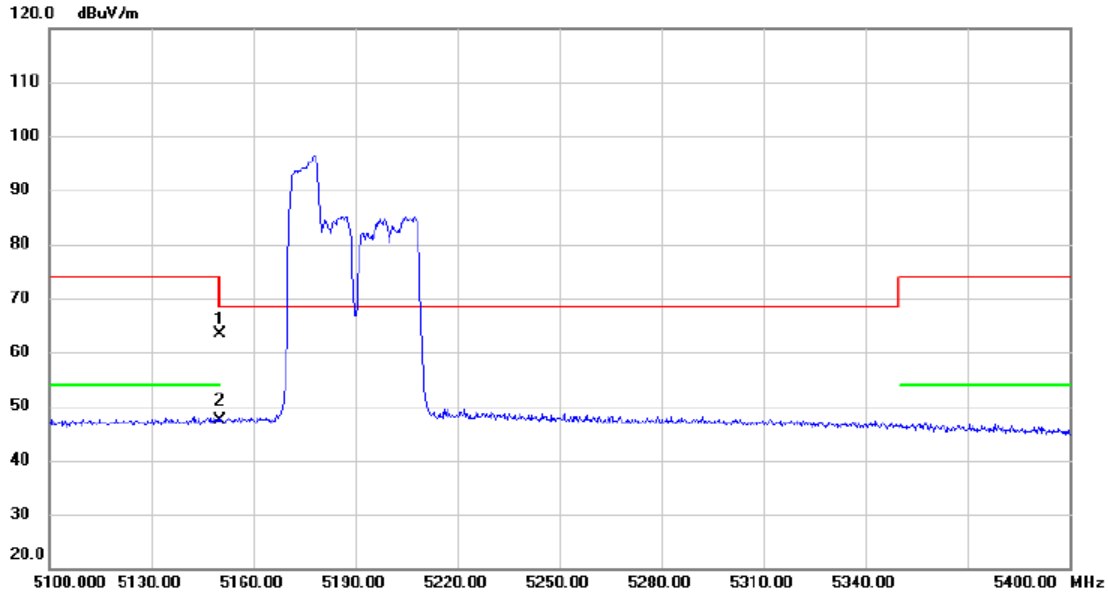

No.	Mk.	Freq. MHz	Reading Level dBuV	Correct Factor dB	Measure- ment dBuV/m	Limit dBuV/m	Margin dB	Detector	Comment
1		5150.000	24.37	39.07	63.44	74.00	-10.56	peak	
2	*	5150.000	8.24	39.07	47.31	54.00	-6.69	AVG	

**REMARKS:**

- (1) Measurement Value = Reading Level + Correct Factor.
- (2) Margin Level = Measurement Value - Limit Value.

Orthogonal Axis	X		
Test Mode	UNII-1_TX AX (HE40) Mode 5190 MHz	RU configuration	242/61

### Vertical

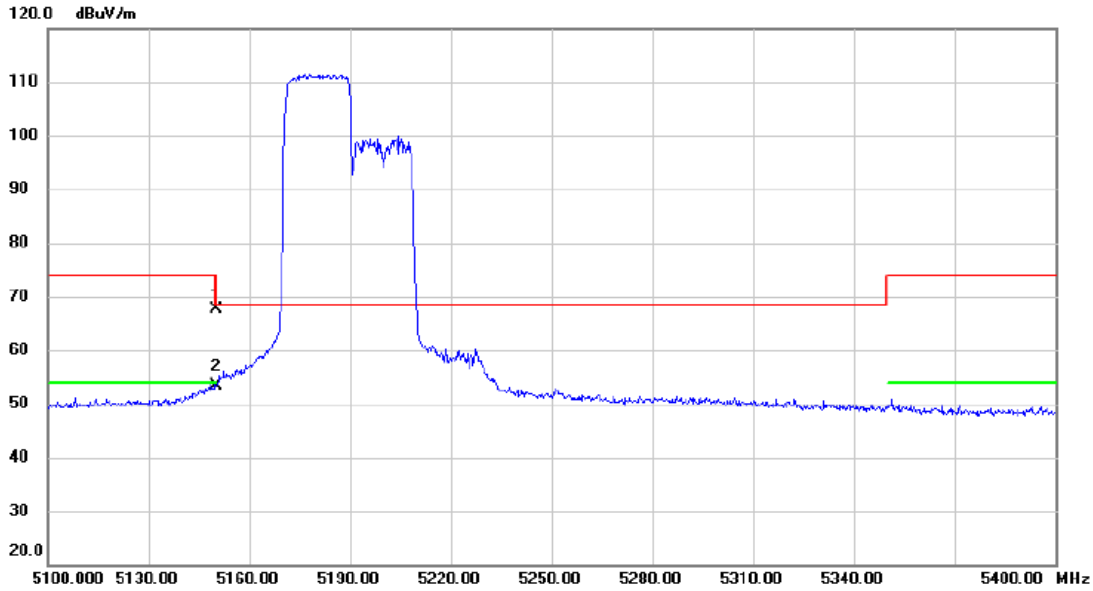

No.	Mk.	Freq. MHz	Reading Level dBuV	Correct Factor dB	Measure- ment dBuV/m	Limit dBuV/m	Margin dB	Detector	Comment
1		5150.000	28.50	39.07	67.57	74.00	-6.43	peak	
2	*	5150.000	14.28	39.07	53.35	54.00	-0.65	AVG	

**REMARKS:**

- (1) Measurement Value = Reading Level + Correct Factor.
- (2) Margin Level = Measurement Value - Limit Value.

Orthogonal Axis	X		
Test Mode	UNII-1_TX AX (HE40) Mode 5190 MHz	RU configuration	242/61

### Horizontal

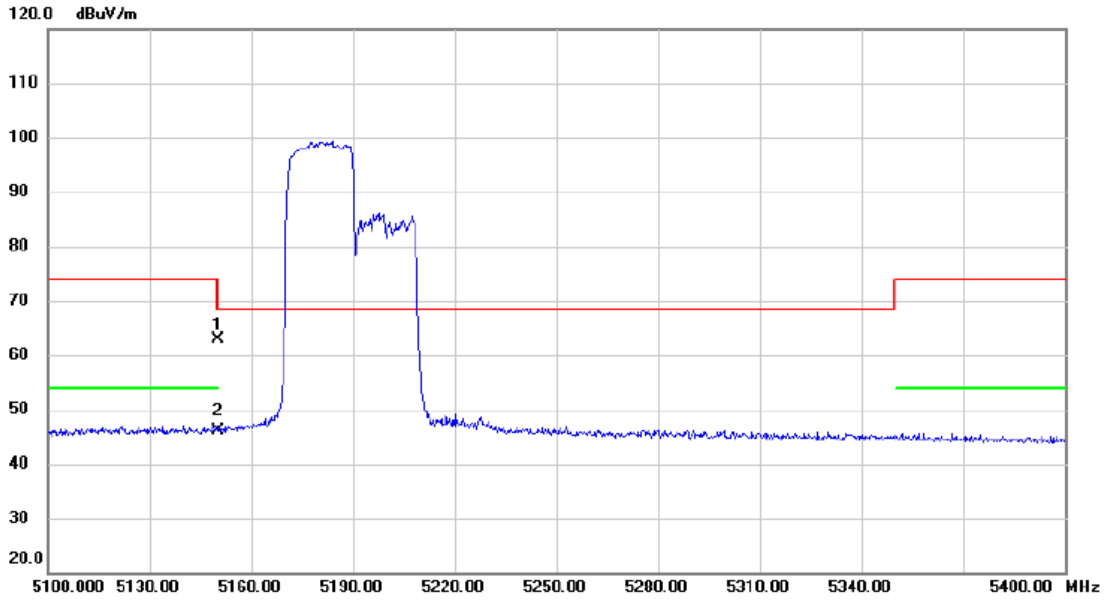

No.	Mk.	Freq. MHz	Reading Level dBuV	Correct Factor dB	Measure- ment dBuV/m	Limit dBuV/m	Margin dB	Detector	Comment
1		5150.000	23.74	39.07	62.81	74.00	-11.19	peak	
2	*	5150.000	6.99	39.07	46.06	54.00	-7.94	AVG	

**REMARKS:**

- (1) Measurement Value = Reading Level + Correct Factor.
- (2) Margin Level = Measurement Value - Limit Value.

Orthogonal Axis	X		
Test Mode	UNII-1_TX AX (HE40) Mode 5190 MHz	RU configuration	484/65

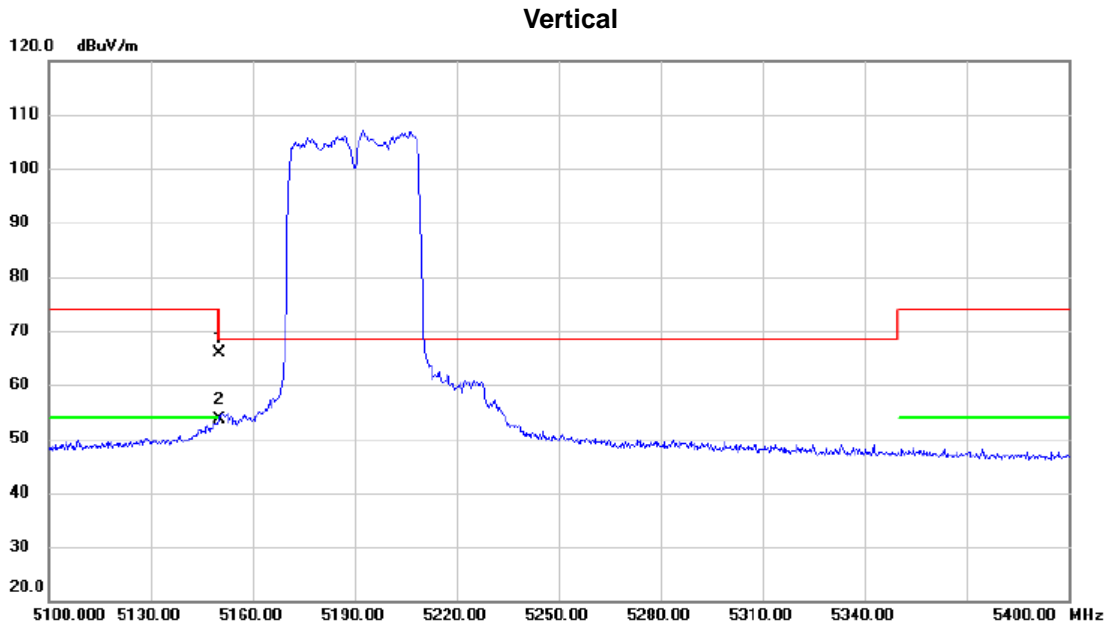

No.	Mk.	Freq. MHz	Reading Level dBuV	Correct Factor dB	Measure- ment dBuV/m	Limit dBuV/m	Margin dB	Detector	Comment
1		5150.000	26.80	39.07	65.87	74.00	-8.13	peak	
2	*	5150.000	14.45	39.07	53.52	54.00	-0.48	AVG	

**REMARKS:**

- (1) Measurement Value = Reading Level + Correct Factor.
- (2) Margin Level = Measurement Value - Limit Value.

Orthogonal Axis	X		
Test Mode	UNII-1_TX AX (HE40) Mode 5190 MHz	RU configuration	484/65

### Horizontal

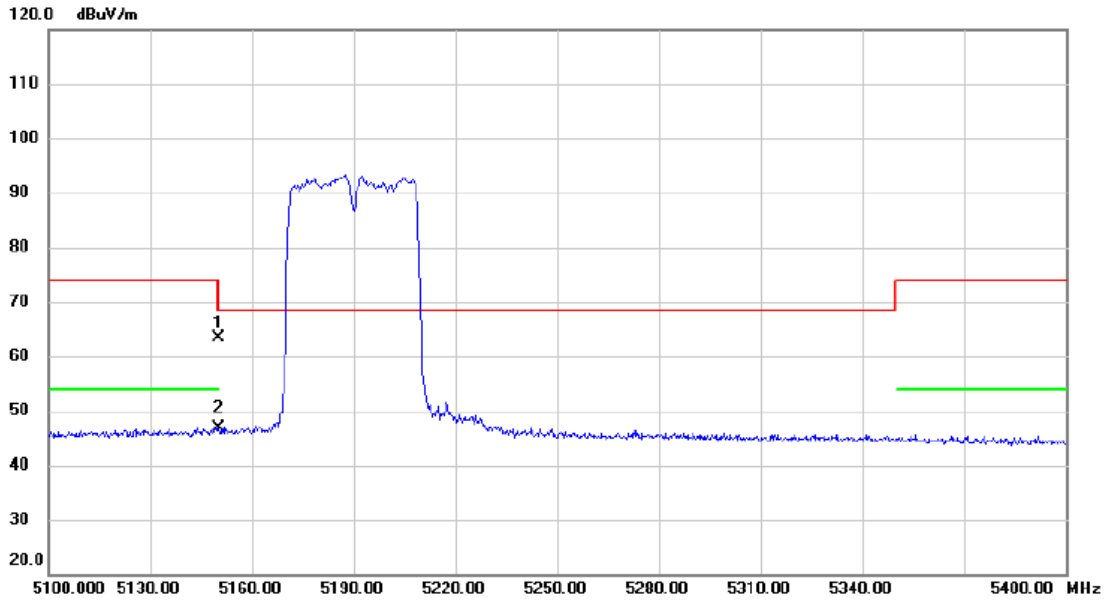

No.	Mk.	Freq. MHz	Reading Level dBuV	Correct Factor dB	Measure- ment dBuV/m	Limit dBuV/m	Margin dB	Detector	Comment
1		5150.000	24.39	39.07	63.46	74.00	-10.54	peak	
2	*	5150.000	7.82	39.07	46.89	54.00	-7.11	AVG	

**REMARKS:**

- (1) Measurement Value = Reading Level + Correct Factor.
- (2) Margin Level = Measurement Value - Limit Value.

Orthogonal Axis	X		
Test Mode	UNII-1_TX AX (HE40) Mode 5190 MHz	RU configuration	484/65

### Vertical

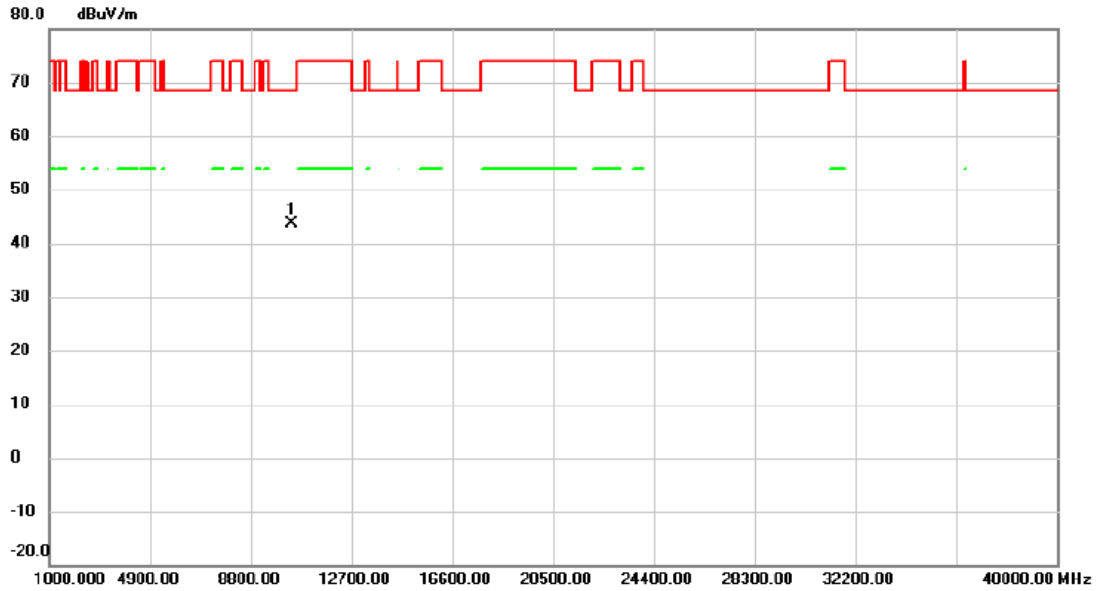

No.	Mk.	Freq. MHz	Reading Level dBuV	Correct Factor dB	Measure- ment dBuV/m	Limit dBuV/m	Margin dB	Detector	Comment
1	*	10380.00	44.99	-1.46	43.53	68.30	-24.77	peak	

**REMARKS:**

- (1) Measurement Value = Reading Level + Correct Factor.
- (2) Margin Level = Measurement Value - Limit Value.

Orthogonal Axis	X		
Test Mode	UNII-1_TX AX (HE40) Mode 5190 MHz	RU configuration	484/65

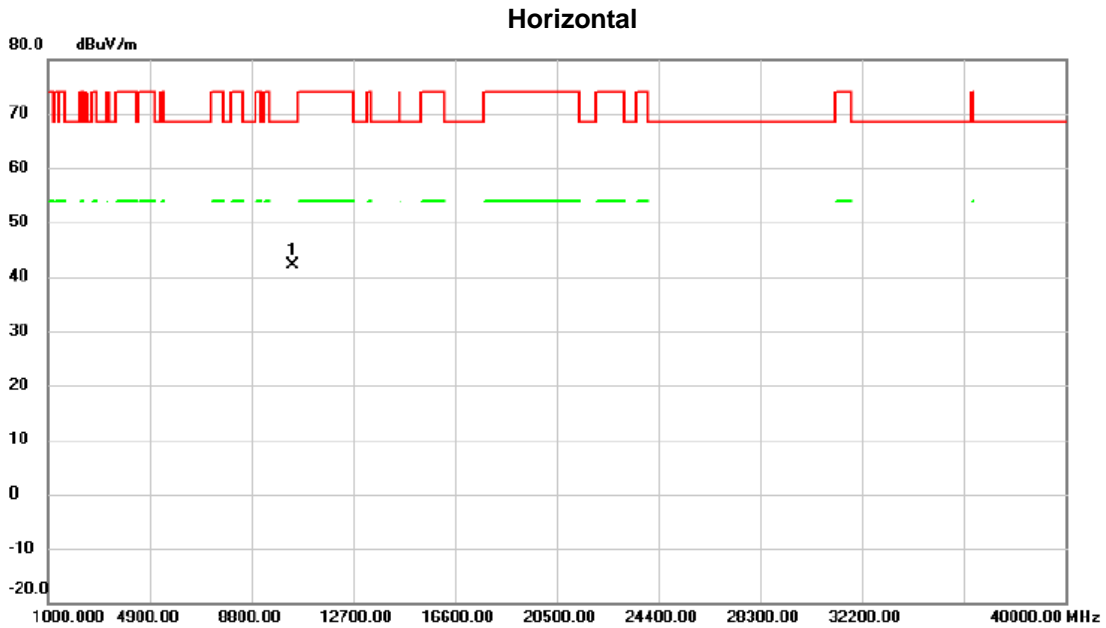

No.	Mk.	Freq. MHz	Reading Level dBuV	Correct Factor dB	Measure- ment dBuV/m	Limit dBuV/m	Margin dB	Detector	Comment
1	*	10380.00	43.47	-1.46	42.01	68.30	-26.29	peak	

**REMARKS:**

- (1) Measurement Value = Reading Level + Correct Factor.
- (2) Margin Level = Measurement Value - Limit Value.

Orthogonal Axis	X		
Test Mode	UNII-1_TX AX (HE40) Mode 5230 MHz	RU configuration	52/37

### Vertical

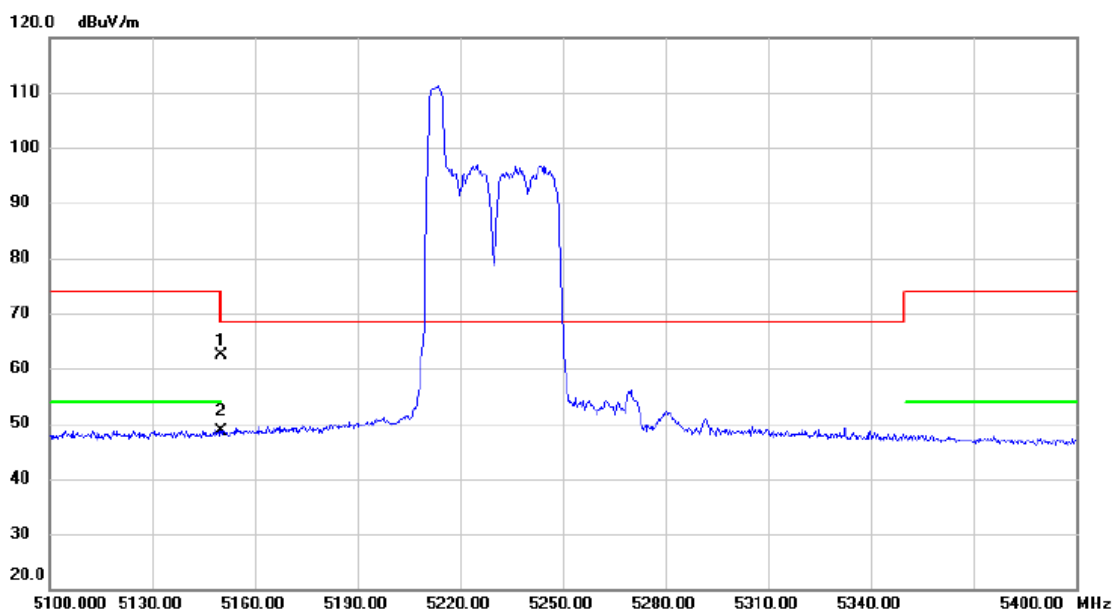

No.	Mk.	Freq. MHz	Reading Level dBuV	Correct Factor dB	Measure- ment dBuV/m	Limit dBuV/m	Margin dB	Detector	Comment
1		5150.000	23.27	39.07	62.34	74.00	-11.66	peak	
2	*	5150.000	9.56	39.07	48.63	54.00	-5.37	AVG	

#### REMARKS:

- (1) Measurement Value = Reading Level + Correct Factor.
- (2) Margin Level = Measurement Value - Limit Value.



Orthogonal Axis	X		
Test Mode	UNII-1_TX AX (HE40) Mode 5230 MHz	RU configuration	52/37

### Horizontal

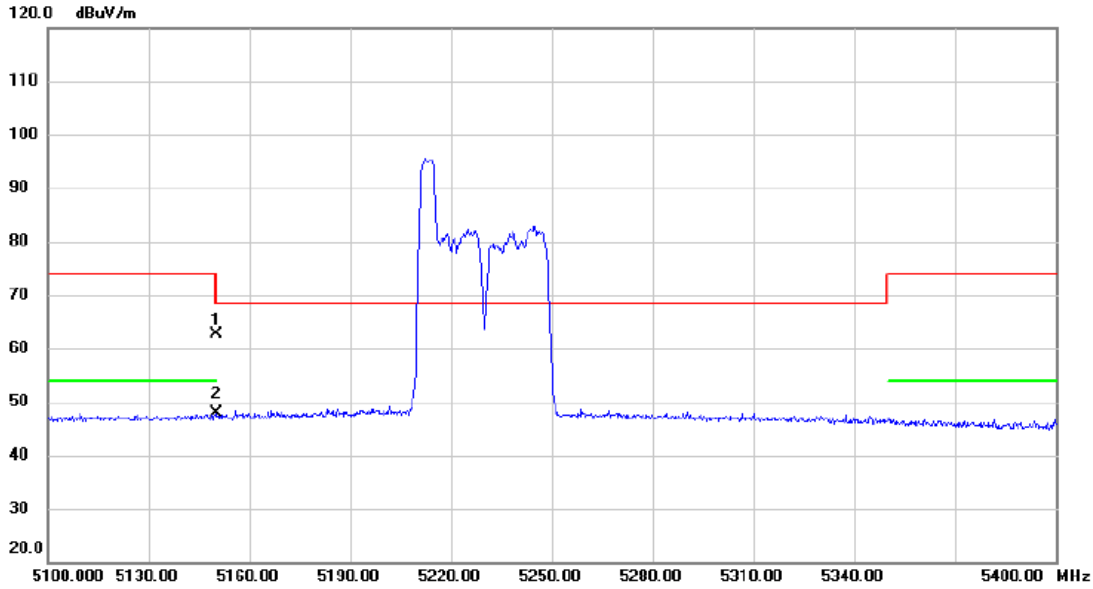

No.	Mk.	Freq. MHz	Reading Level dBuV	Correct Factor dB	Measure- ment dBuV/m	Limit dBuV/m	Margin dB	Detector	Comment
1		5150.000	23.46	39.07	62.53	74.00	-11.47	peak	
2	*	5150.000	8.88	39.07	47.95	54.00	-6.05	AVG	

**REMARKS:**

- (1) Measurement Value = Reading Level + Correct Factor.
- (2) Margin Level = Measurement Value - Limit Value.

Orthogonal Axis	X		
Test Mode	UNII-1_TX AX (HE40) Mode 5230 MHz	RU configuration	106/53

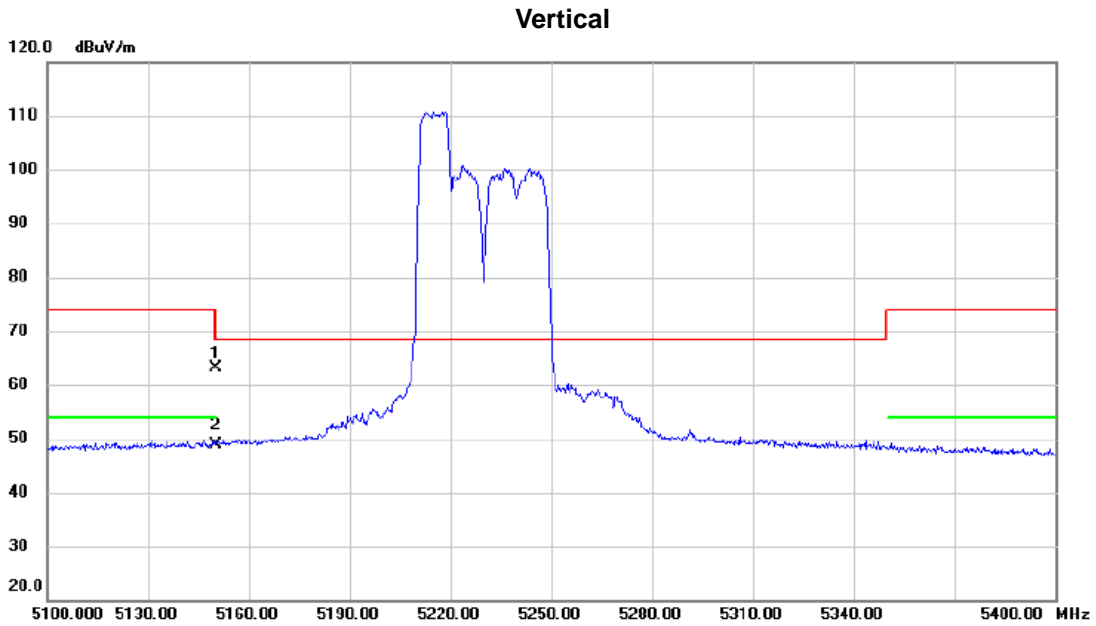

No.	Mk.	Freq. MHz	Reading Level dBuV	Correct Factor dB	Measure- ment dBuV/m	Limit dBuV/m	Margin dB	Detector	Comment
1		5150.000	24.17	39.07	63.24	74.00	-10.76	peak	
2	*	5150.000	9.84	39.07	48.91	54.00	-5.09	AVG	

**REMARKS:**

- (1) Measurement Value = Reading Level + Correct Factor.
- (2) Margin Level = Measurement Value - Limit Value.

Orthogonal Axis	X		
Test Mode	UNII-1_TX AX (HE40) Mode 5230 MHz	RU configuration	106/53

### Horizontal

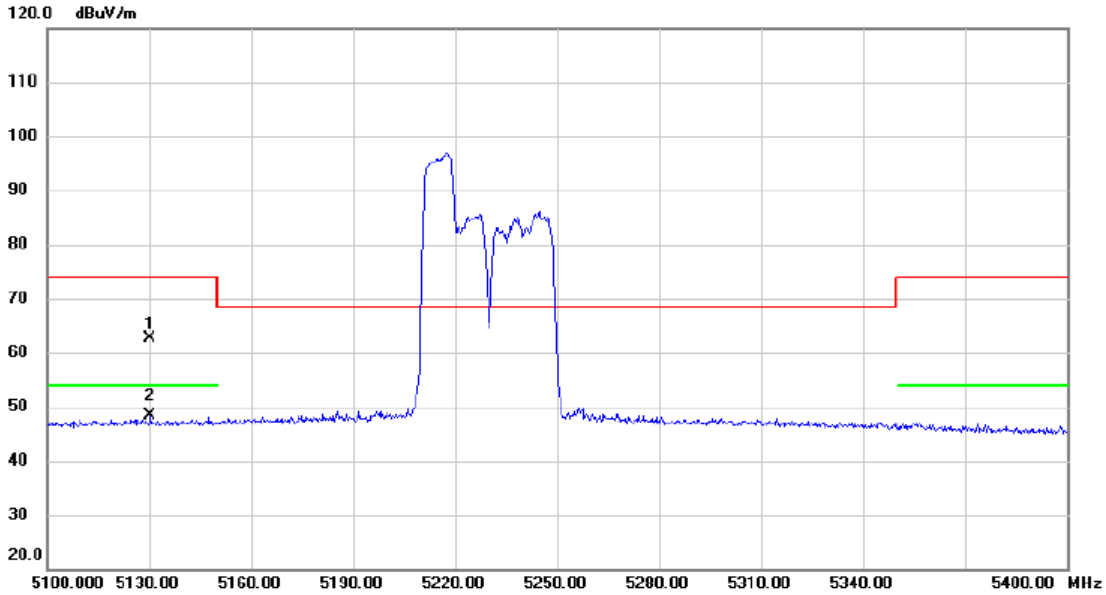

No.	Mk.	Freq. MHz	Reading Level dBuV	Correct Factor dB	Measure- ment dBuV/m	Limit dBuV/m	Margin dB	Detector	Comment
1		5130.300	23.58	39.05	62.63	74.00	-11.37	peak	
2	*	5130.300	9.23	39.05	48.28	54.00	-5.72	AVG	

**REMARKS:**

- (1) Measurement Value = Reading Level + Correct Factor.
- (2) Margin Level = Measurement Value - Limit Value.

Orthogonal Axis	X		
Test Mode	UNII-1_TX AX (HE40) Mode 5230 MHz	RU configuration	242/61

### Vertical

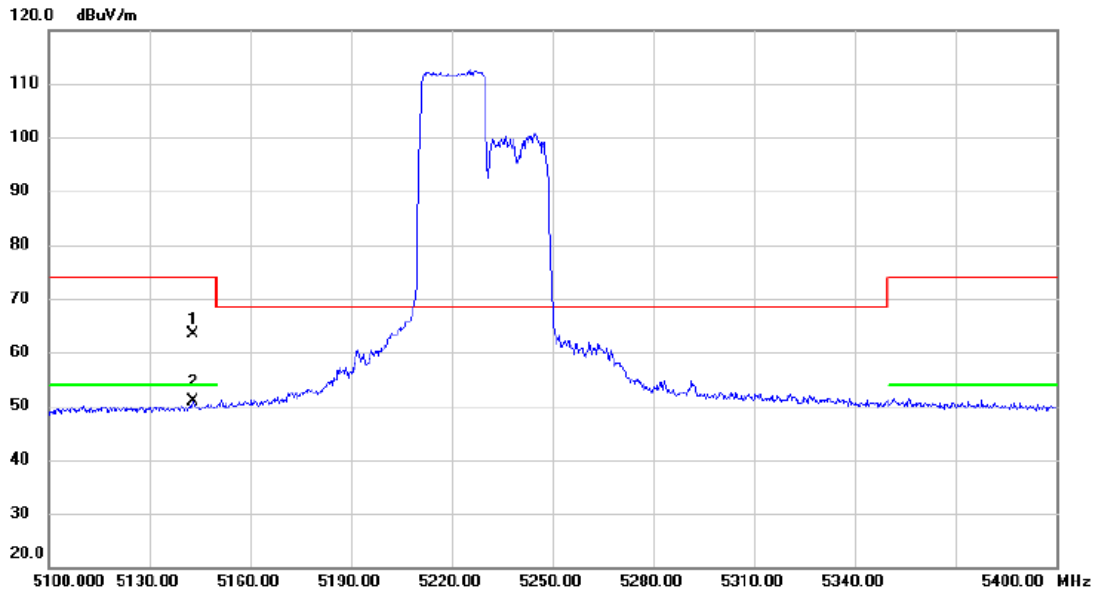

No.	Mk.	Freq. MHz	Reading Level dBuV	Correct Factor dB	Measure- ment dBuV/m	Limit dBuV/m	Margin dB	Detector	Comment
1		5142.900	24.39	39.06	63.45	74.00	-10.55	peak	
2	*	5142.900	11.73	39.06	50.79	54.00	-3.21	AVG	

**REMARKS:**

- (1) Measurement Value = Reading Level + Correct Factor.
- (2) Margin Level = Measurement Value - Limit Value.

Orthogonal Axis	X		
Test Mode	UNII-1_TX AX (HE40) Mode 5230 MHz	RU configuration	242/61

### Horizontal

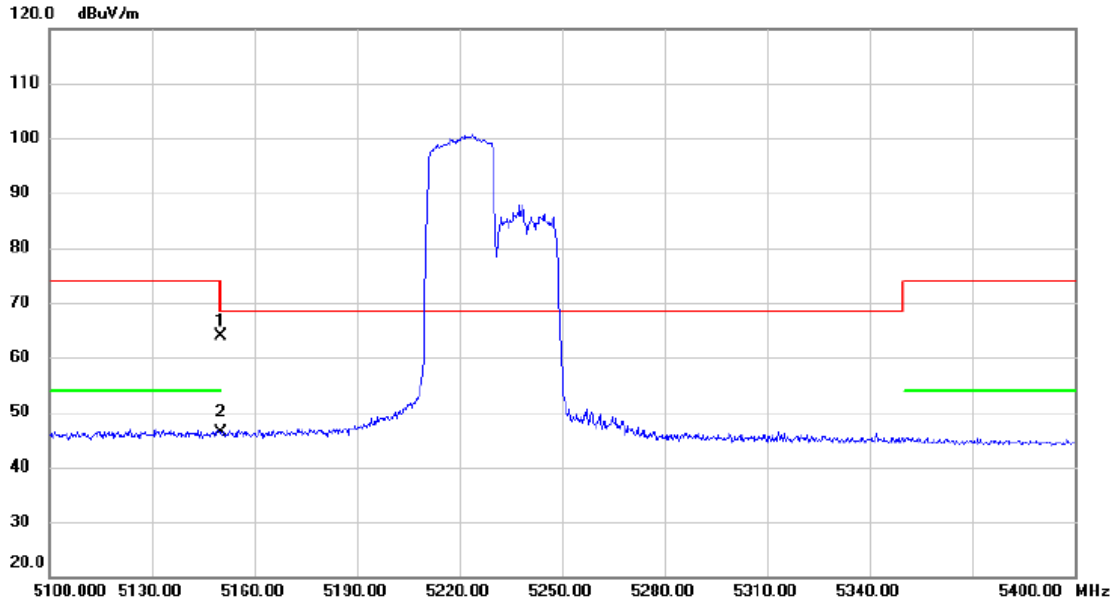

No.	Mk.	Freq. MHz	Reading Level dBuV	Correct Factor dB	Measure- ment dBuV/m	Limit dBuV/m	Margin dB	Detector	Comment
1		5150.000	24.86	39.07	63.93	74.00	-10.07	peak	
2	*	5150.000	7.31	39.07	46.38	54.00	-7.62	AVG	

**REMARKS:**

- (1) Measurement Value = Reading Level + Correct Factor.
- (2) Margin Level = Measurement Value - Limit Value.

Orthogonal Axis	X		
Test Mode	UNII-1_TX AX (HE40) Mode 5230 MHz	RU configuration	484/65

### Vertical

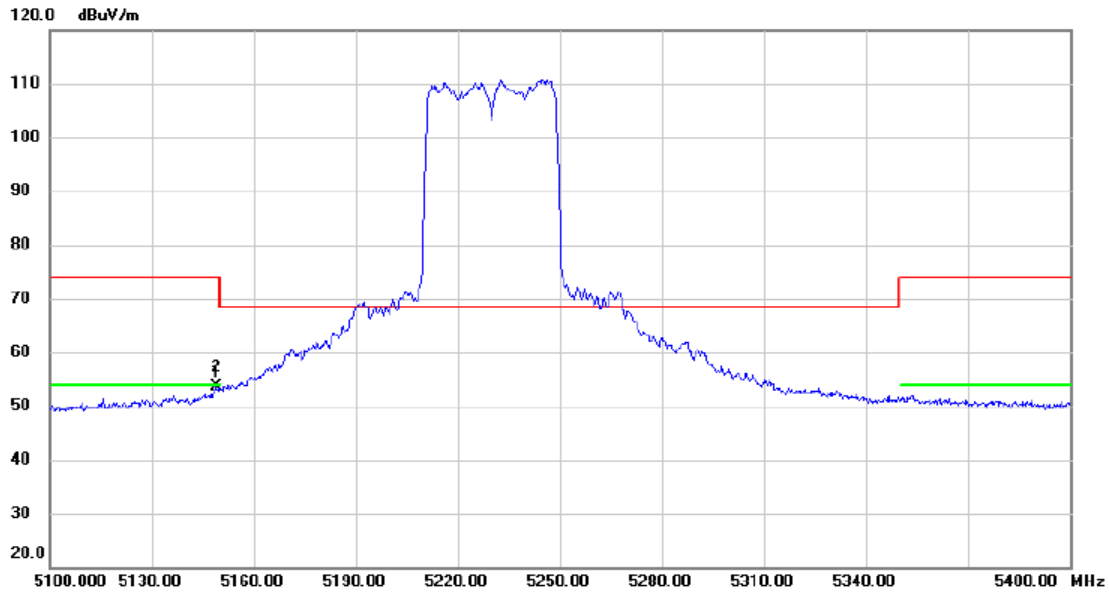

No.	Mk.	Freq. MHz	Reading Level dBuV	Correct Factor dB	Measure- ment dBuV/m	Limit dBuV/m	Margin dB	Detector	Comment
1		5149.050	14.46	39.07	53.53	74.00	-20.47	peak	
2	*	5149.050	14.46	39.07	53.53	54.00	-0.47	AVG	

**REMARKS:**

- (1) Measurement Value = Reading Level + Correct Factor.
- (2) Margin Level = Measurement Value - Limit Value.

Orthogonal Axis	X		
Test Mode	UNII-1_TX AX (HE40) Mode 5230 MHz	RU configuration	484/65

### Horizontal

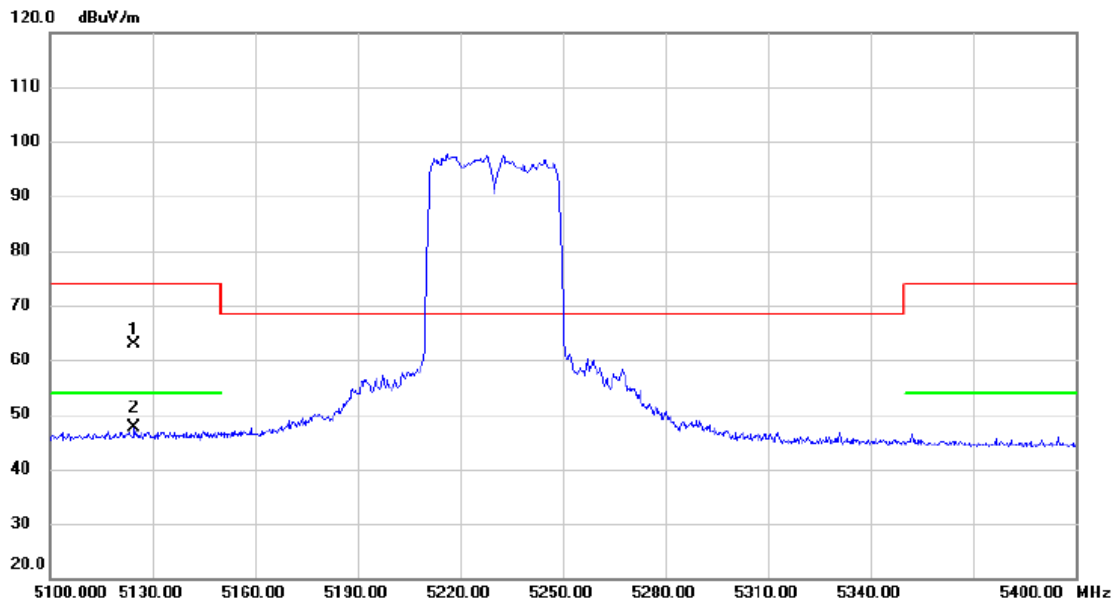

No.	Mk.	Freq. MHz	Reading Level dBuV	Correct Factor dB	Measure- ment dBuV/m	Limit dBuV/m	Margin dB	Detector	Comment
1		5124.600	23.86	39.03	62.89	74.00	-11.11	peak	
2	*	5124.600	8.55	39.03	47.58	54.00	-6.42	AVG	

**REMARKS:**

- (1) Measurement Value = Reading Level + Correct Factor.
- (2) Margin Level = Measurement Value - Limit Value.

Orthogonal Axis	X		
Test Mode	UNII-1_TX AX (HE40) Mode 5230 MHz	RU configuration	484/65

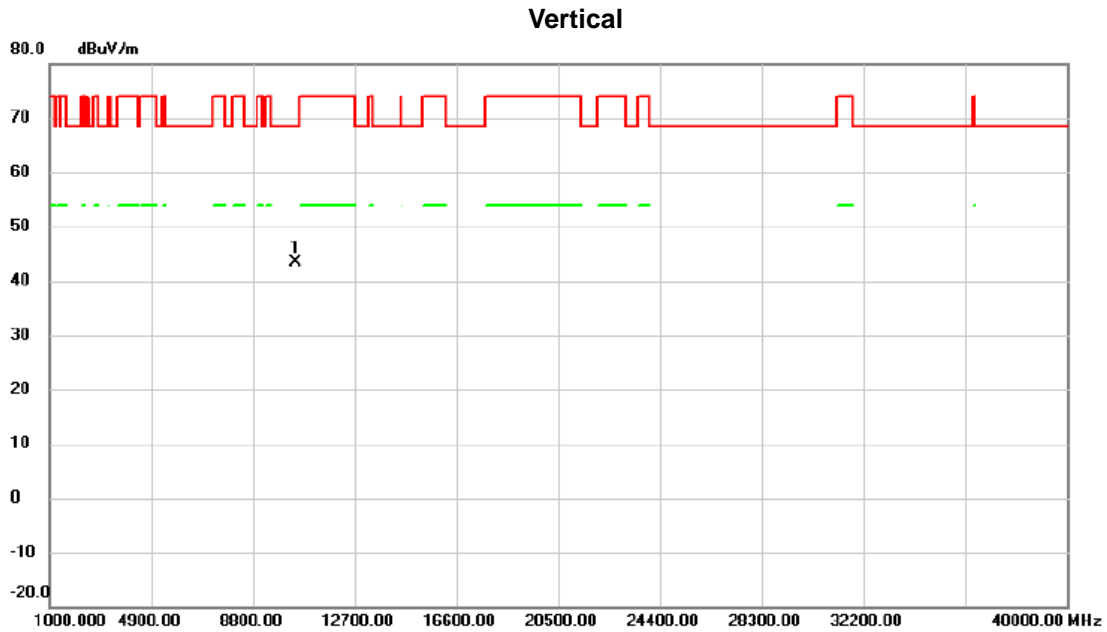

No.	Mk.	Freq. MHz	Reading Level dBuV	Correct Factor dB	Measure- ment dBuV/m	Limit dBuV/m	Margin dB	Detector	Comment
1	*	10460.00	44.79	-1.46	43.33	68.30	-24.97	peak	

**REMARKS:**

- (1) Measurement Value = Reading Level + Correct Factor.
- (2) Margin Level = Measurement Value - Limit Value.



Orthogonal Axis	X		
Test Mode	UNII-1_TX AX (HE40) Mode 5230 MHz	RU configuration	484/65

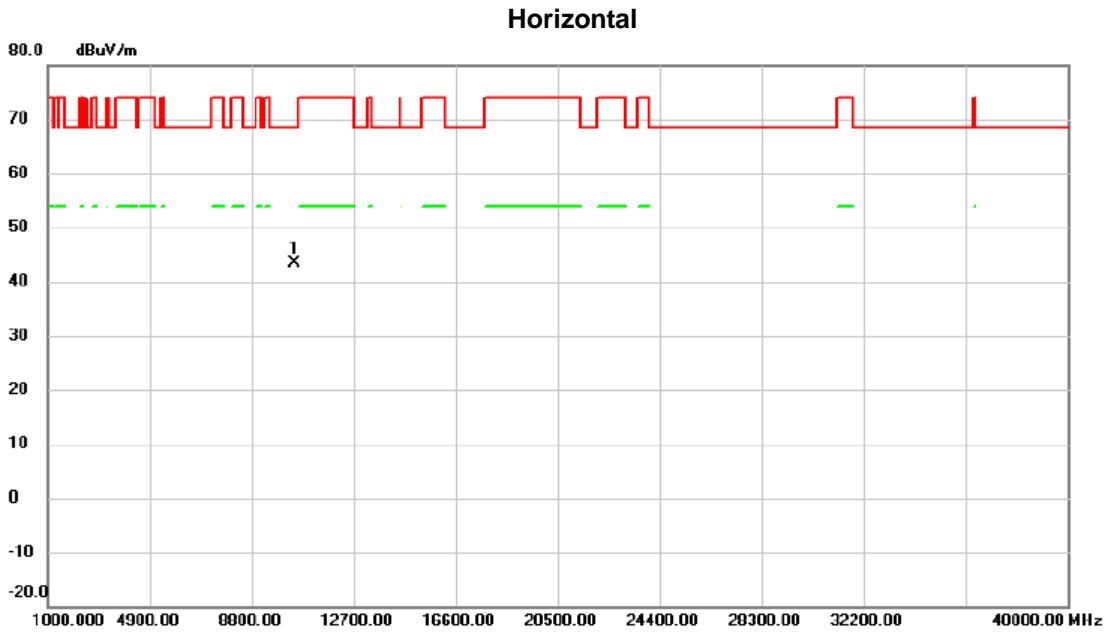

No.	Mk.	Freq. MHz	Reading Level dBuV	Correct Factor dB	Measure- ment dBuV/m	Limit dBuV/m	Margin dB	Detector	Comment
1	*	10460.00	44.74	-1.46	43.28	68.30	-25.02	peak	

**REMARKS:**

- (1) Measurement Value = Reading Level + Correct Factor.
- (2) Margin Level = Measurement Value - Limit Value.

Orthogonal Axis	X		
Test Mode	UNII-2A_TX AX (HE40) Mode 5270 MHz	RU configuration	52/44

### Vertical

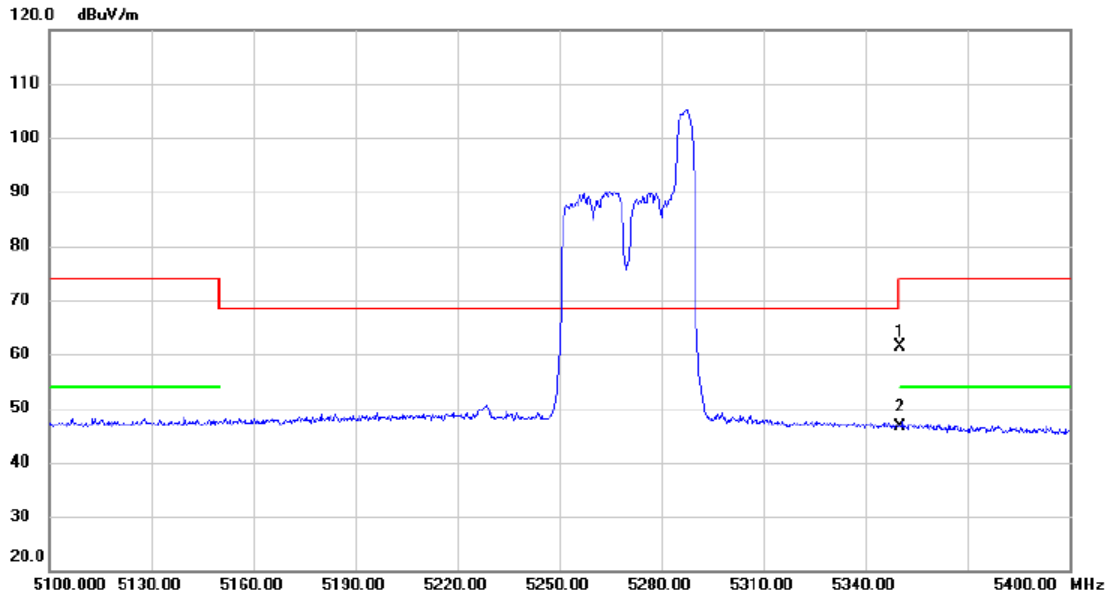

No.	Mk.	Freq. MHz	Reading Level dBuV	Correct Factor dB	Measure- ment dBuV/m	Limit dBuV/m	Margin dB	Detector	Comment
1		5350.000	22.15	39.32	61.47	74.00	-12.53	peak	
2	*	5350.000	7.22	39.32	46.54	54.00	-7.46	AVG	

**REMARKS:**

- (1) Measurement Value = Reading Level + Correct Factor.
- (2) Margin Level = Measurement Value - Limit Value.

Orthogonal Axis	X		
Test Mode	UNII-2A_TX AX (HE40) Mode 5270 MHz	RU configuration	52/44

### Horizontal

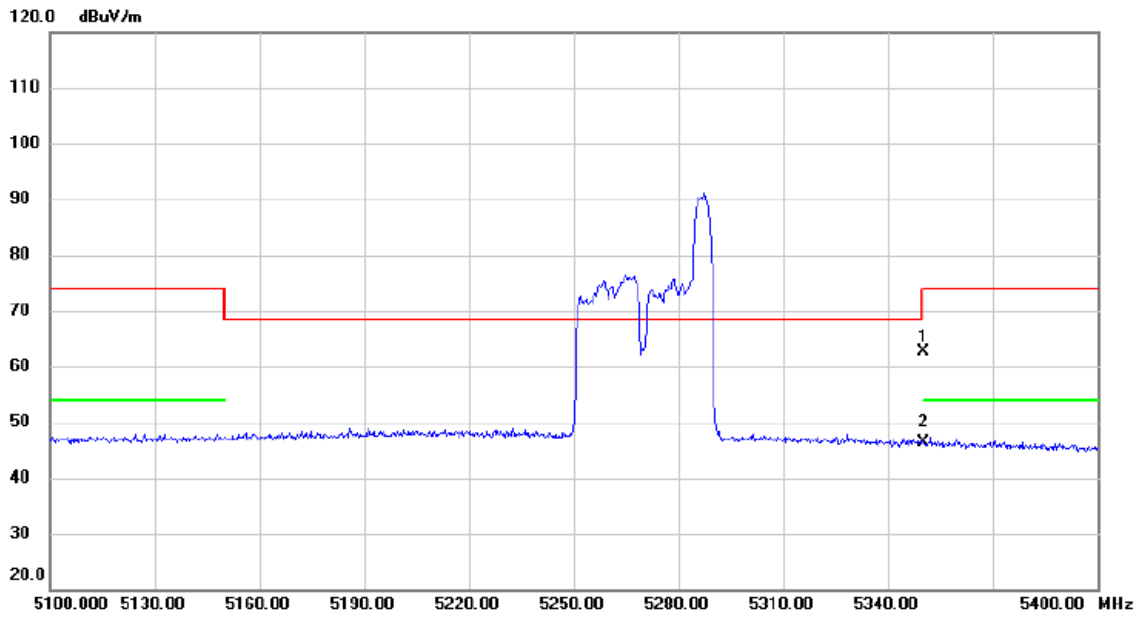

No.	Mk.	Freq. MHz	Reading Level dBuV	Correct Factor dB	Measure- ment dBuV/m	Limit dBuV/m	Margin dB	Detector	Comment
1		5350.000	23.19	39.32	62.51	74.00	-11.49	peak	
2	*	5350.000	6.96	39.32	46.28	54.00	-7.72	AVG	

**REMARKS:**

- (1) Measurement Value = Reading Level + Correct Factor.
- (2) Margin Level = Measurement Value - Limit Value.

Orthogonal Axis	X		
Test Mode	UNII-2A_TX AX (HE40) Mode 5270 MHz	RU configuration	106/56

### Vertical

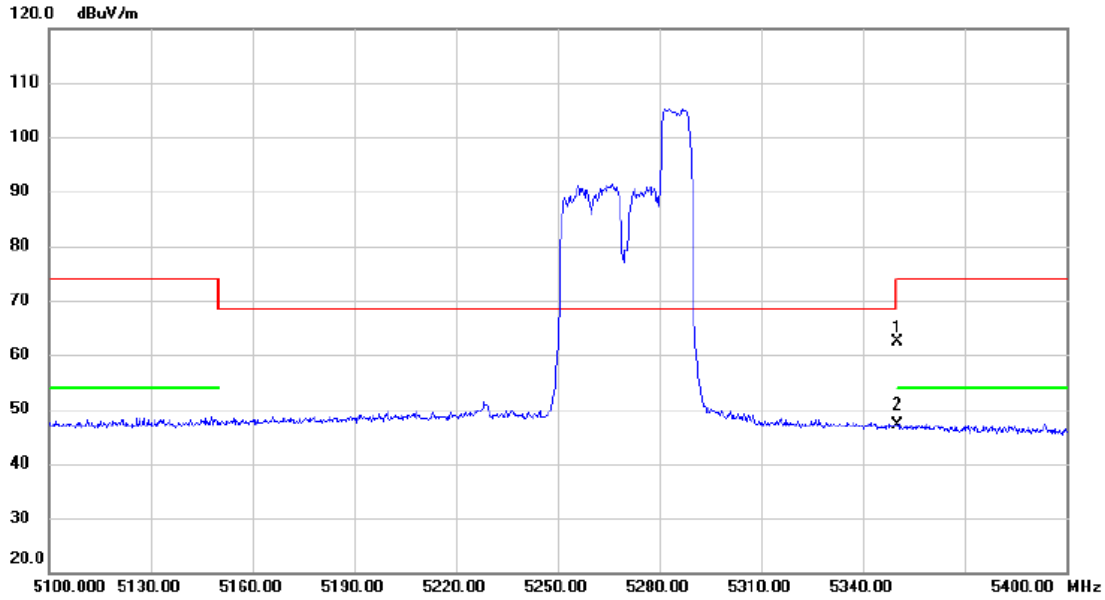

No.	Mk.	Freq. MHz	Reading Level dBuV	Correct Factor dB	Measure- ment dBuV/m	Limit dBuV/m	Margin dB	Detector	Comment
1		5350.000	23.16	39.32	62.48	74.00	-11.52	peak	
2	*	5350.000	7.72	39.32	47.04	54.00	-6.96	AVG	

**REMARKS:**

- (1) Measurement Value = Reading Level + Correct Factor.
- (2) Margin Level = Measurement Value - Limit Value.

Orthogonal Axis	X		
Test Mode	UNII-2A_TX AX (HE40) Mode 5270 MHz	RU configuration	106/56

### Horizontal

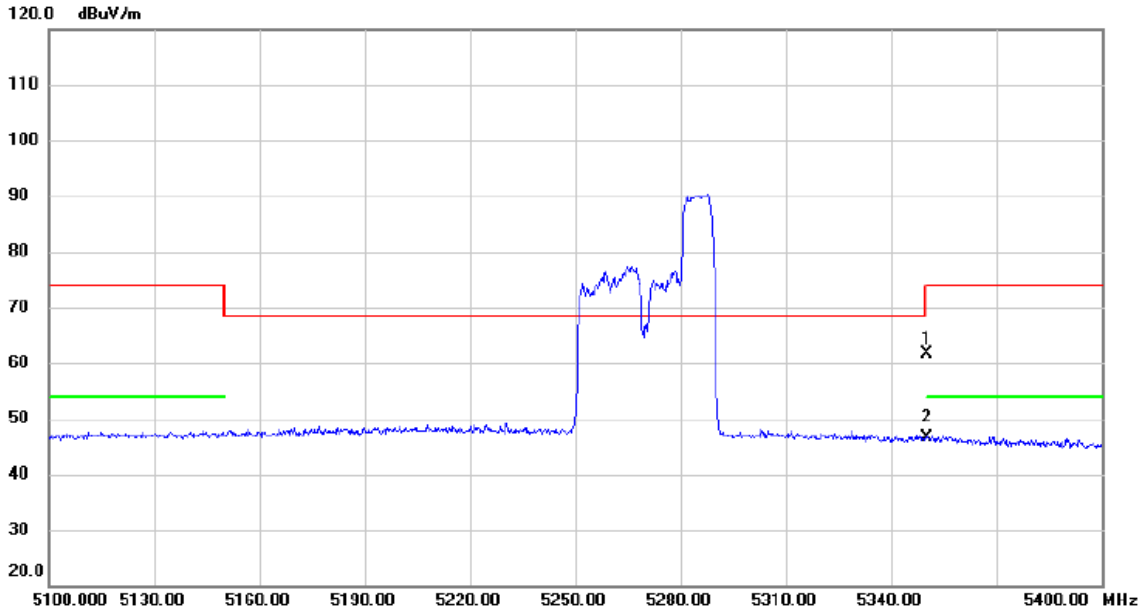

No.	Mk.	Freq. MHz	Reading Level dBuV	Correct Factor dB	Measure- ment dBuV/m	Limit dBuV/m	Margin dB	Detector	Comment
1		5350.000	22.31	39.32	61.63	74.00	-12.37	peak	
2	*	5350.000	7.42	39.32	46.74	54.00	-7.26	AVG	

**REMARKS:**

- (1) Measurement Value = Reading Level + Correct Factor.
- (2) Margin Level = Measurement Value - Limit Value.

Orthogonal Axis	X		
Test Mode	UNII-2A_TX AX (HE40) Mode 5270 MHz	RU configuration	242/61

### Vertical

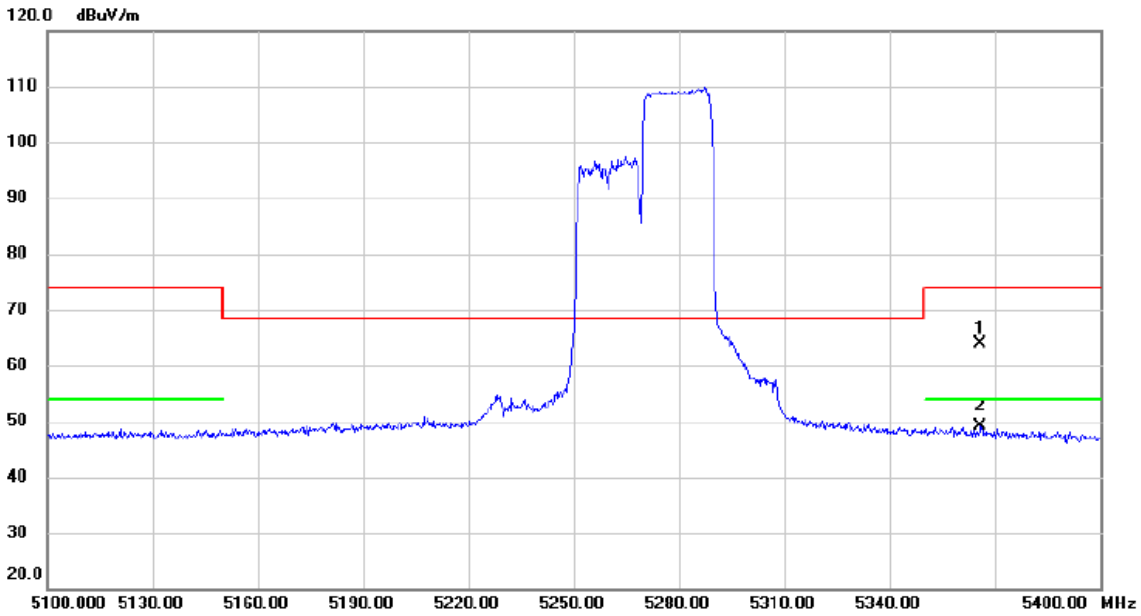

No.	Mk.	Freq. MHz	Reading Level dBuV	Correct Factor dB	Measure- ment dBuV/m	Limit dBuV/m	Margin dB	Detector	Comment
1		5365.800	24.57	39.34	63.91	74.00	-10.09	peak	
2	*	5365.800	9.86	39.34	49.20	54.00	-4.80	AVG	

**REMARKS:**

- (1) Measurement Value = Reading Level + Correct Factor.
- (2) Margin Level = Measurement Value - Limit Value.

Orthogonal Axis	X		
Test Mode	UNII-2A_TX AX (HE40) Mode 5270 MHz	RU configuration	242/61

### Horizontal

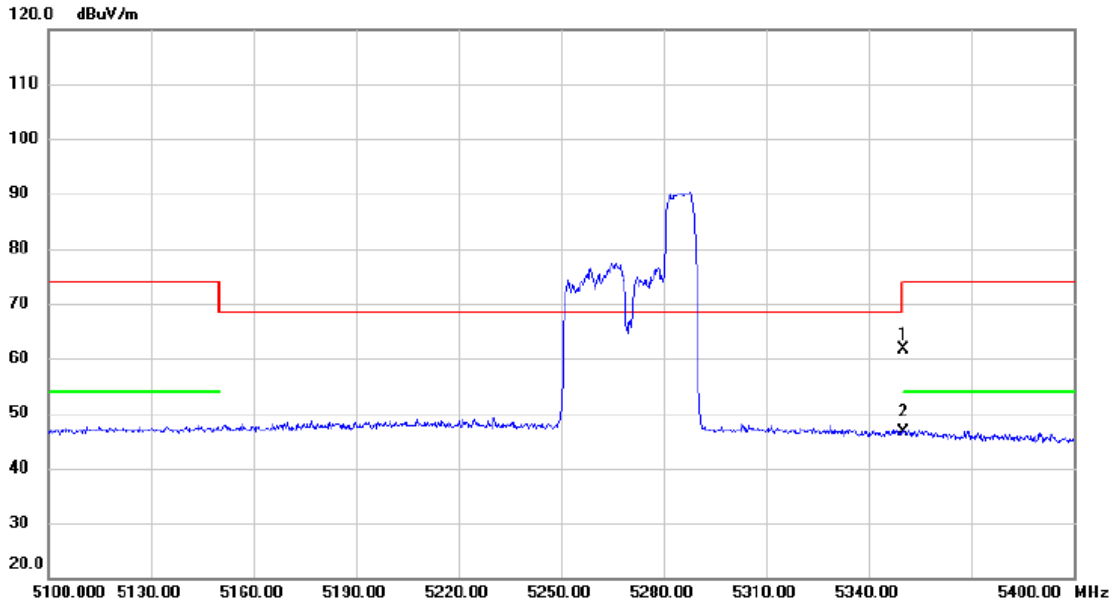

No.	Mk.	Freq. MHz	Reading Level dBuV	Correct Factor dB	Measure- ment dBuV/m	Limit dBuV/m	Margin dB	Detector	Comment
1		5350.000	22.31	39.32	61.63	74.00	-12.37	peak	
2	*	5350.000	7.42	39.32	46.74	54.00	-7.26	AVG	

**REMARKS:**

- (1) Measurement Value = Reading Level + Correct Factor.
- (2) Margin Level = Measurement Value - Limit Value.

Orthogonal Axis	X		
Test Mode	UNII-2A_TX AX (HE40) Mode 5270 MHz	RU configuration	484/65

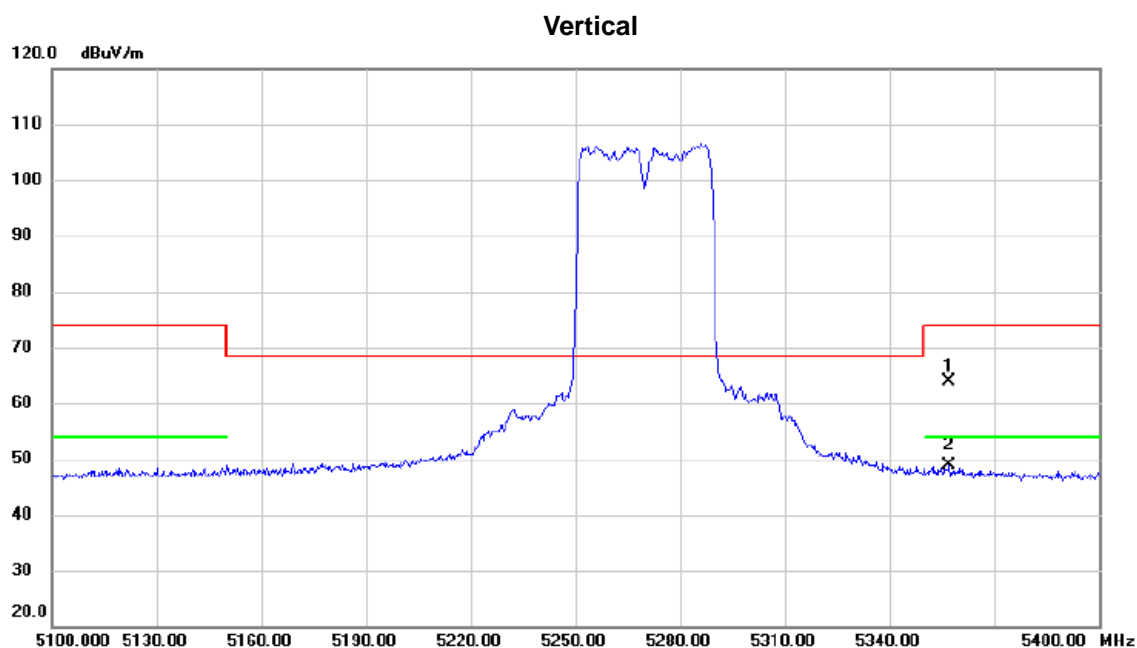

No.	Mk.	Freq. MHz	Reading Level dBuV	Correct Factor dB	Measure- ment dBuV/m	Limit dBuV/m	Margin dB	Detector	Comment
1		5357.100	24.65	39.33	63.98	74.00	-10.02	peak	
2	*	5357.100	9.43	39.33	48.76	54.00	-5.24	AVG	

**REMARKS:**

- (1) Measurement Value = Reading Level + Correct Factor.
- (2) Margin Level = Measurement Value - Limit Value.



Orthogonal Axis	X		
Test Mode	UNII-2A_TX AX (HE40) Mode 5270 MHz	RU configuration	484/65

### Horizontal

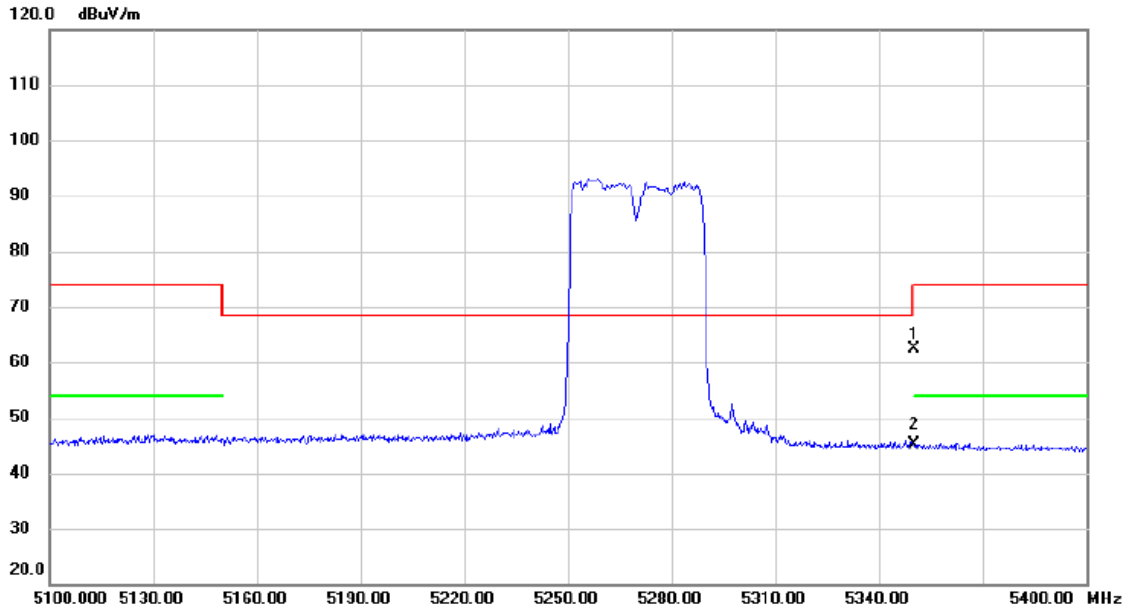

No.	Mk.	Freq. MHz	Reading Level dBuV	Correct Factor dB	Measure- ment dBuV/m	Limit dBuV/m	Margin dB	Detector	Comment
1		5350.000	23.01	39.32	62.33	74.00	-11.67	peak	
2	*	5350.000	5.86	39.32	45.18	54.00	-8.82	AVG	

**REMARKS:**

- (1) Measurement Value = Reading Level + Correct Factor.
- (2) Margin Level = Measurement Value - Limit Value.

Orthogonal Axis	X		
Test Mode	UNII-2A_TX AX (HE40) Mode 5270 MHz	RU configuration	484/65

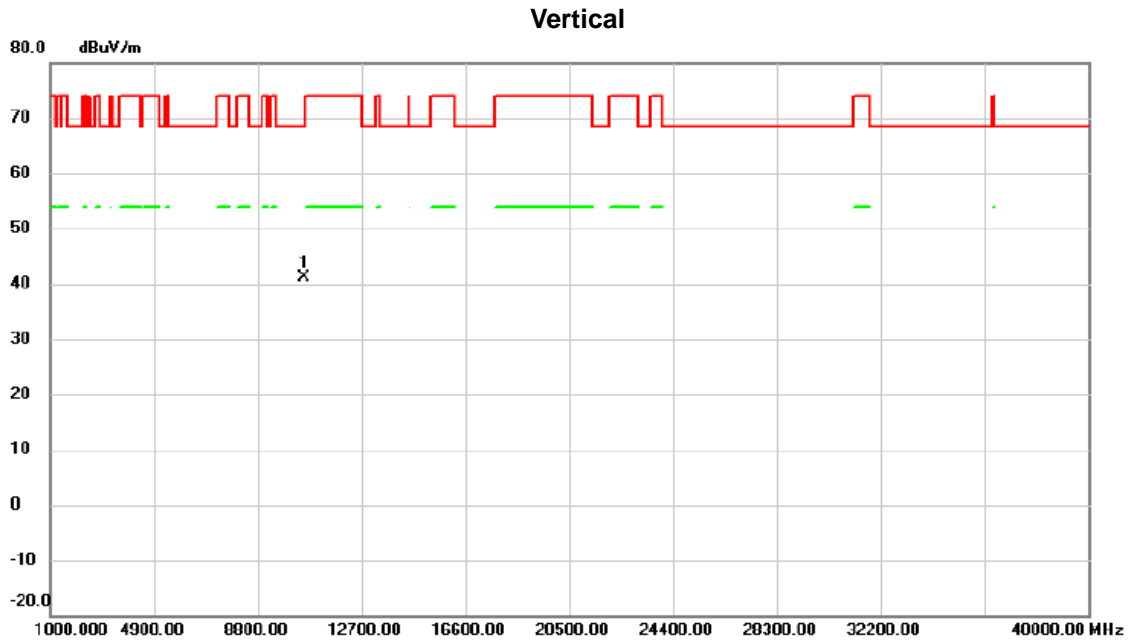

No.	Mk.	Freq.	Reading Level	Correct Factor	Measurement	Limit	Margin		
		MHz	dBuV	dB	dBuV/m	dBuV/m	dB	Detector	Comment
1	*	10520.00	42.45	-1.36	41.09	68.30	-27.21	peak	

**REMARKS:**

- (1) Measurement Value = Reading Level + Correct Factor.
- (2) Margin Level = Measurement Value - Limit Value.

Orthogonal Axis	X		
Test Mode	UNII-2A_TX AX (HE40) Mode 5270 MHz	RU configuration	484/65

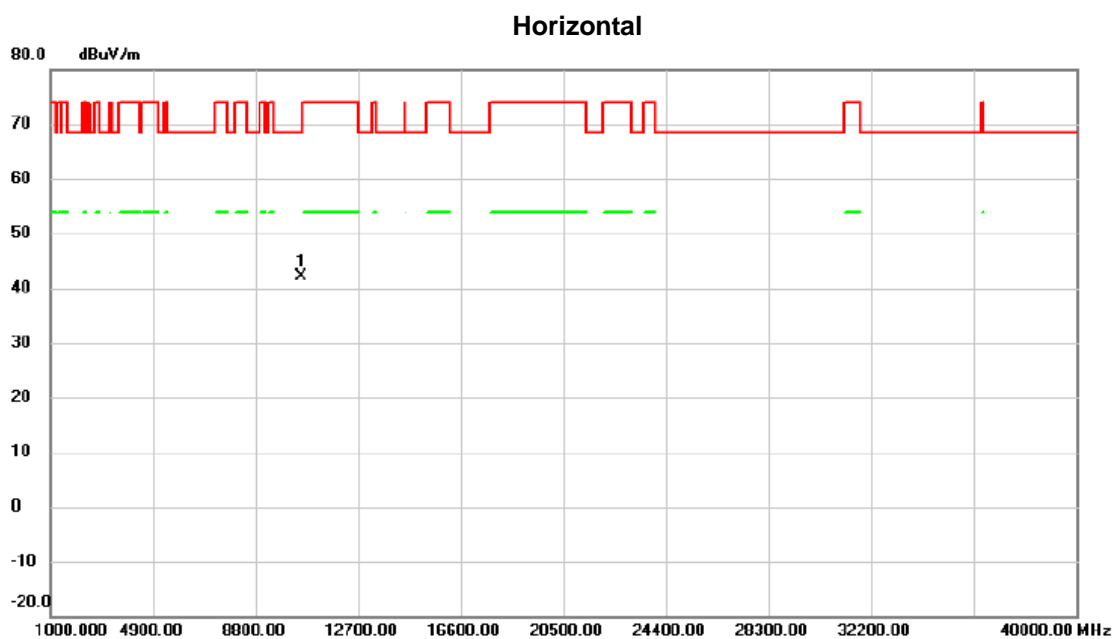

No.	Mk.	Freq.	Reading Level	Correct Factor	Measurement	Limit	Margin	Detector	Comment
		MHz	dBuV	dB	dBuV/m	dBuV/m	dB		
1	*	10520.00	43.38	-1.36	42.02	68.30	-26.28	peak	

**REMARKS:**

- (1) Measurement Value = Reading Level + Correct Factor.
- (2) Margin Level = Measurement Value - Limit Value.

Orthogonal Axis	X		
Test Mode	UNII-2A_TX AX (HE40) Mode 5310 MHz	RU configuration	52/44

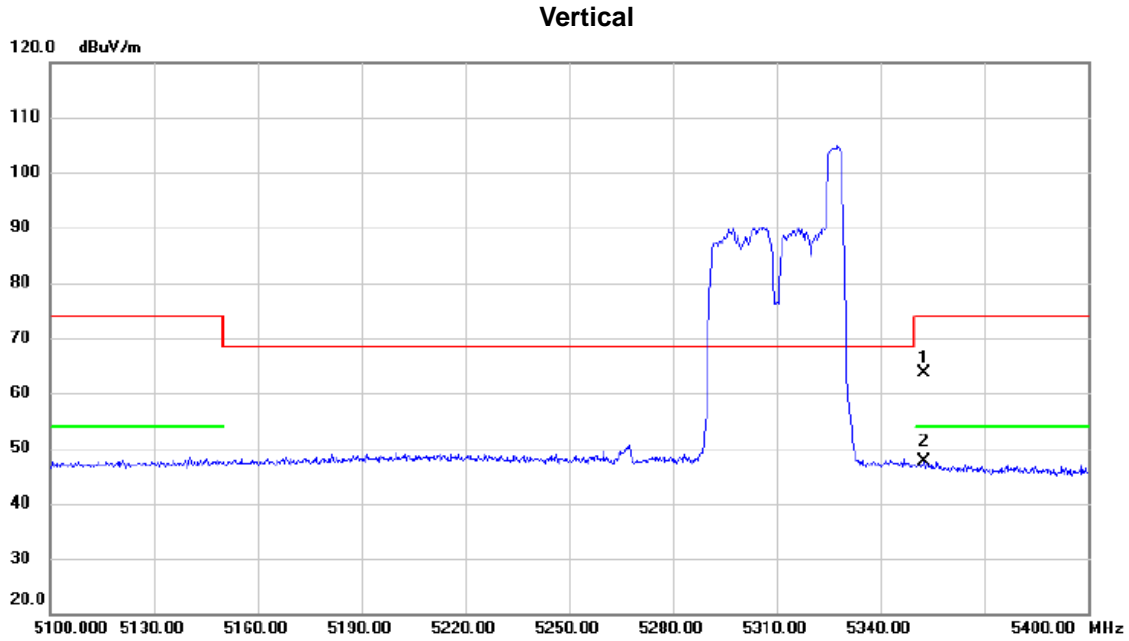

No.	Mk.	Freq. MHz	Reading Level dBuV	Correct Factor dB	Measure- ment dBuV/m	Limit dBuV/m	Margin dB	Detector	Comment
1		5352.600	24.39	39.32	63.71	74.00	-10.29	peak	
2	*	5352.600	8.29	39.32	47.61	54.00	-6.39	AVG	

**REMARKS:**

- (1) Measurement Value = Reading Level + Correct Factor.
- (2) Margin Level = Measurement Value - Limit Value.

Orthogonal Axis	X		
Test Mode	UNII-2A_TX AX (HE40) Mode 5310 MHz	RU configuration	52/44

### Horizontal

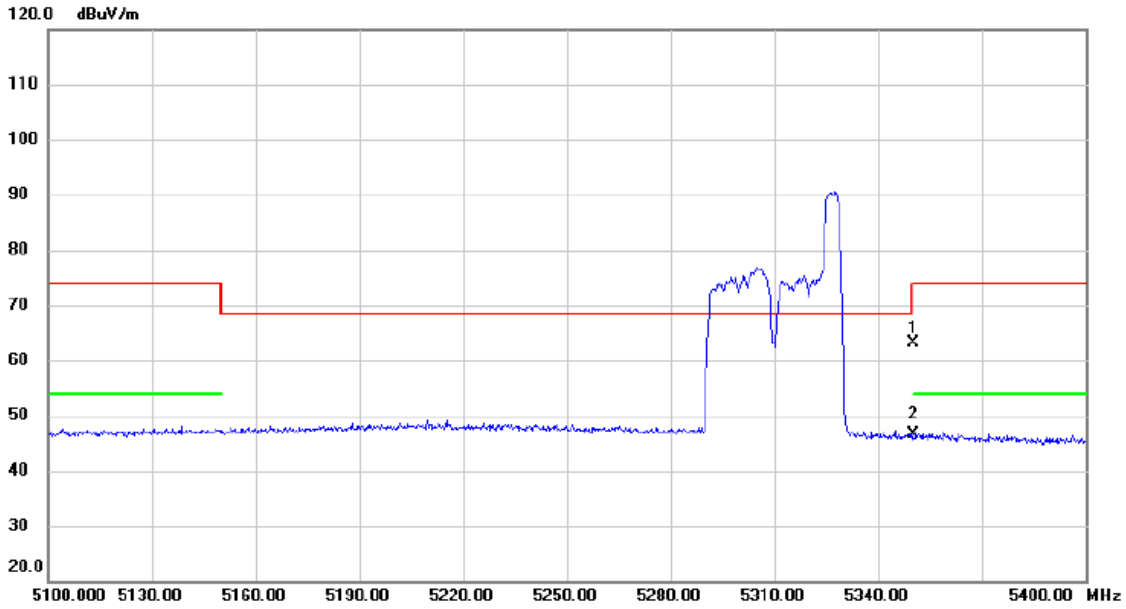

No.	Mk.	Freq. MHz	Reading Level dBuV	Correct Factor dB	Measure- ment dBuV/m	Limit dBuV/m	Margin dB	Detector	Comment
1		5350.000	23.72	39.32	63.04	74.00	-10.96	peak	
2	*	5350.000	7.31	39.32	46.63	54.00	-7.37	AVG	

**REMARKS:**

- (1) Measurement Value = Reading Level + Correct Factor.
- (2) Margin Level = Measurement Value - Limit Value.

Orthogonal Axis	X		
Test Mode	UNII-2A_TX AX (HE40) Mode 5310 MHz	RU configuration	106/56

### Vertical

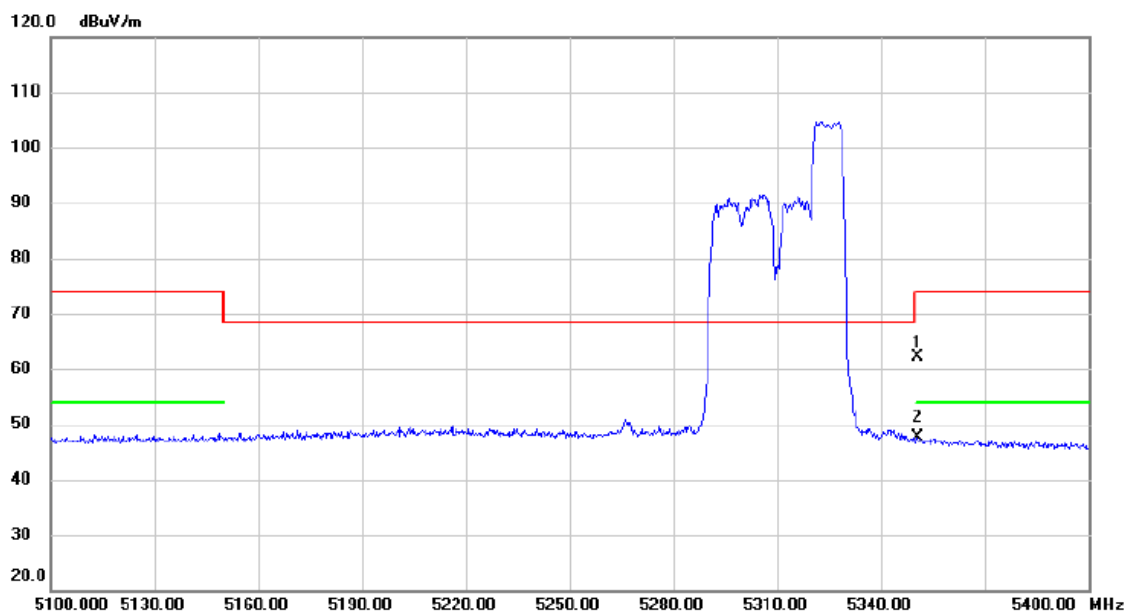

No.	Mk.	Freq. MHz	Reading Level dBuV	Correct Factor dB	Measure- ment dBuV/m	Limit dBuV/m	Margin dB	Detector	Comment
1		5350.650	22.73	39.32	62.05	74.00	-11.95	peak	
2	*	5350.650	8.40	39.32	47.72	54.00	-6.28	AVG	

**REMARKS:**

- (1) Measurement Value = Reading Level + Correct Factor.
- (2) Margin Level = Measurement Value - Limit Value.

Orthogonal Axis	X		
Test Mode	UNII-2A_TX AX (HE40) Mode 5310 MHz	RU configuration	106/56

### Horizontal

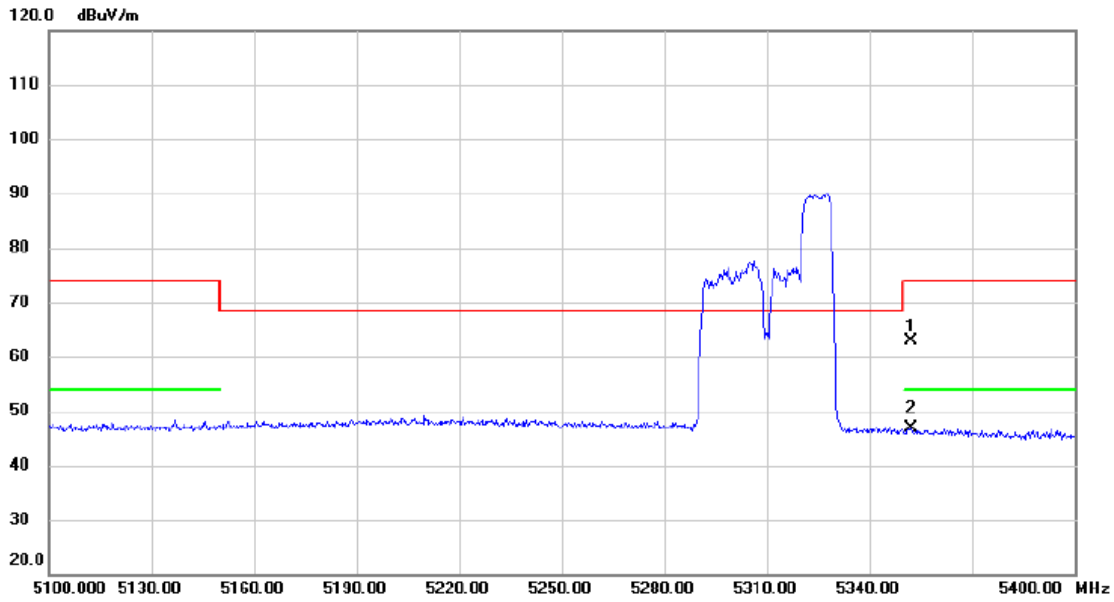

No.	Mk.	Freq. MHz	Reading Level dBuV	Correct Factor dB	Measure- ment dBuV/m	Limit dBuV/m	Margin dB	Detector	Comment
1		5352.000	23.52	39.32	62.84	74.00	-11.16	peak	
2	*	5352.000	7.60	39.32	46.92	54.00	-7.08	AVG	

**REMARKS:**

- (1) Measurement Value = Reading Level + Correct Factor.
- (2) Margin Level = Measurement Value - Limit Value.

Orthogonal Axis	X		
Test Mode	UNII-2A_TX AX (HE40) Mode 5310 MHz	RU configuration	242/62

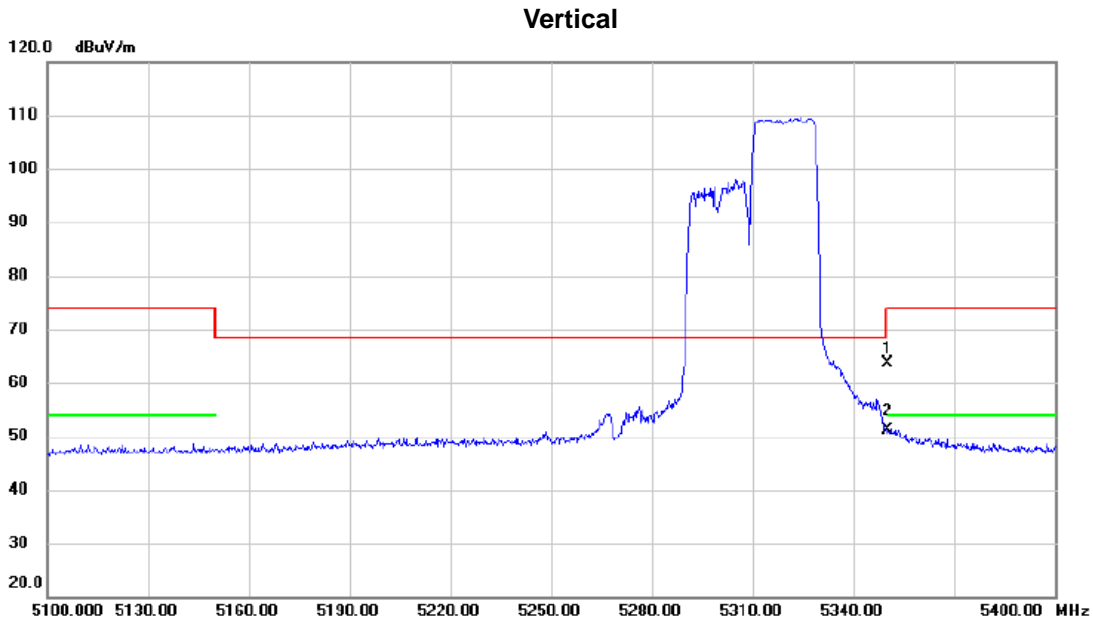

No.	Mk.	Freq. MHz	Reading Level dBuV	Correct Factor dB	Measure- ment dBuV/m	Limit dBuV/m	Margin dB	Detector	Comment
1		5350.000	24.35	39.32	63.67	74.00	-10.33	peak	
2	*	5350.000	11.74	39.32	51.06	54.00	-2.94	AVG	

**REMARKS:**

- (1) Measurement Value = Reading Level + Correct Factor.
- (2) Margin Level = Measurement Value - Limit Value.



Orthogonal Axis	X		
Test Mode	UNII-2A_TX AX (HE40) Mode 5310 MHz	RU configuration	242/62

### Horizontal

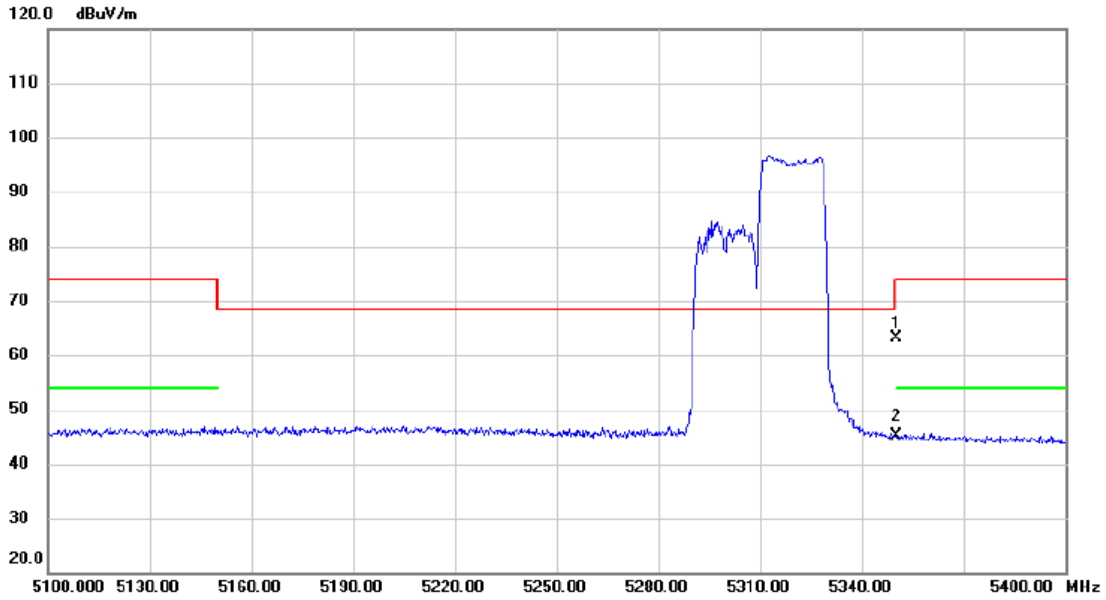

No.	Mk.	Freq. MHz	Reading Level dBuV	Correct Factor dB	Measure- ment dBuV/m	Limit dBuV/m	Margin dB	Detector	Comment
1		5350.000	23.85	39.32	63.17	74.00	-10.83	peak	
2	*	5350.000	5.86	39.32	45.18	54.00	-8.82	AVG	

**REMARKS:**

- (1) Measurement Value = Reading Level + Correct Factor.
- (2) Margin Level = Measurement Value - Limit Value.

Orthogonal Axis	X		
Test Mode	UNII-2A_TX AX (HE40) Mode 5310 MHz	RU configuration	484/65

### Vertical

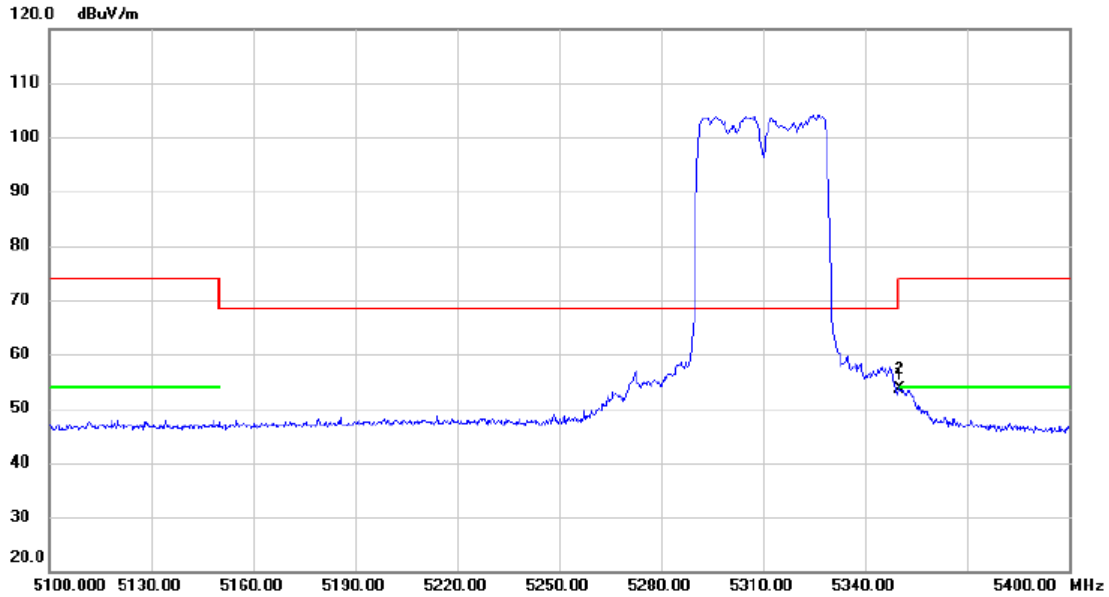

No.	Mk.	Freq. MHz	Reading Level dBuV	Correct Factor dB	Measure- ment dBuV/m	Limit dBuV/m	Margin dB	Detector	Comment
1		5350.000	14.33	39.32	53.65	74.00	-20.35	peak	
2	*	5350.000	14.33	39.32	53.65	54.00	-0.35	AVG	

**REMARKS:**

- (1) Measurement Value = Reading Level + Correct Factor.
- (2) Margin Level = Measurement Value - Limit Value.

Orthogonal Axis	X		
Test Mode	UNII-2A_TX AX (HE40) Mode 5310 MHz	RU configuration	484/65

### Horizontal

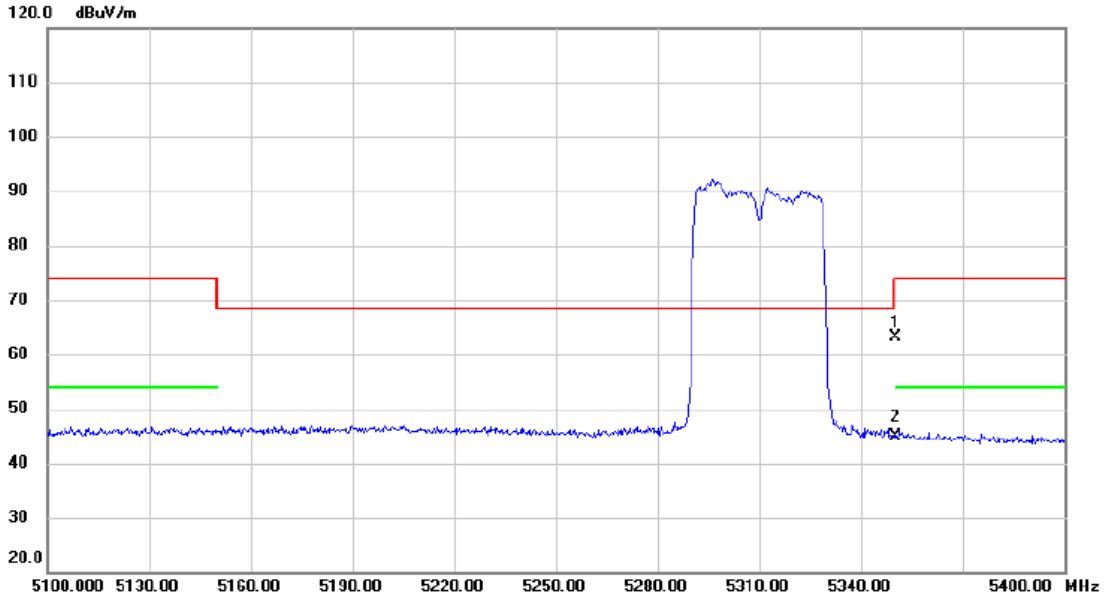

No.	Mk.	Freq. MHz	Reading Level dBuV	Correct Factor dB	Measure- ment dBuV/m	Limit dBuV/m	Margin dB	Detector	Comment
1		5350.000	23.81	39.32	63.13	74.00	-10.87	peak	
2	*	5350.000	5.48	39.32	44.80	54.00	-9.20	AVG	

**REMARKS:**

- (1) Measurement Value = Reading Level + Correct Factor.
- (2) Margin Level = Measurement Value - Limit Value.

Orthogonal Axis	X		
Test Mode	UNII-2A_TX AX (HE40) Mode 5310 MHz	RU configuration	484/65

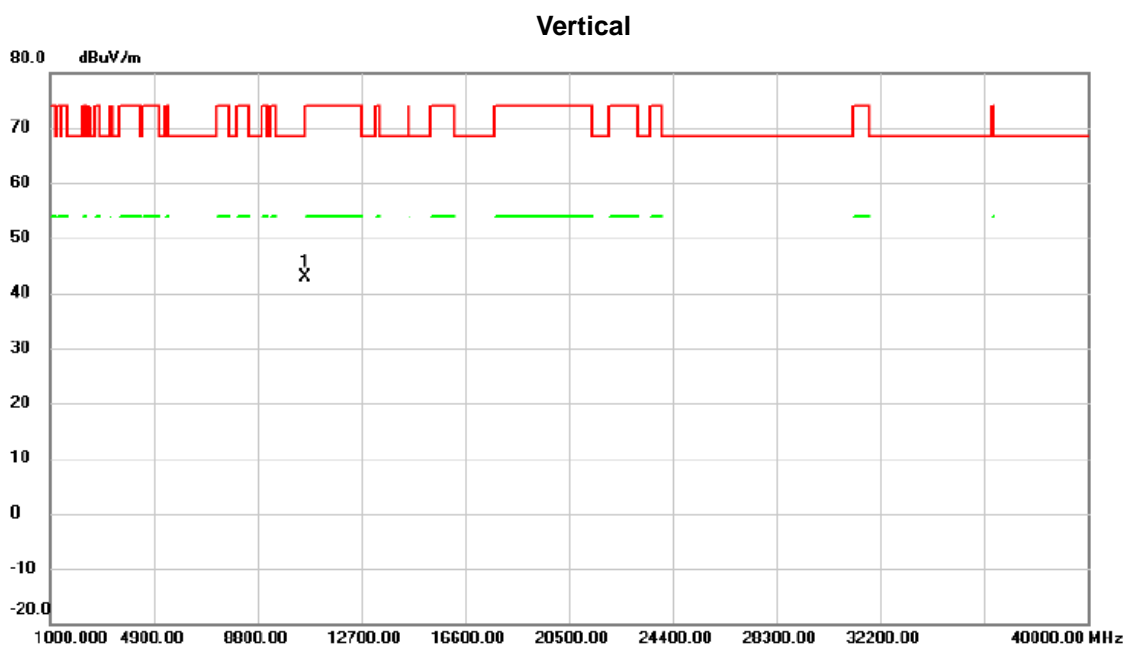

No.	Mk.	Freq. MHz	Reading Level dBuV	Correct Factor dB	Measure- ment dBuV/m	Limit dBuV/m	Margin dB	Detector	Comment
1	*	10600.00	43.80	-0.97	42.83	68.30	-25.47	peak	

**REMARKS:**

- (1) Measurement Value = Reading Level + Correct Factor.
- (2) Margin Level = Measurement Value - Limit Value.

Orthogonal Axis	X		
Test Mode	UNII-2A_TX AX (HE40) Mode 5310 MHz	RU configuration	484/65

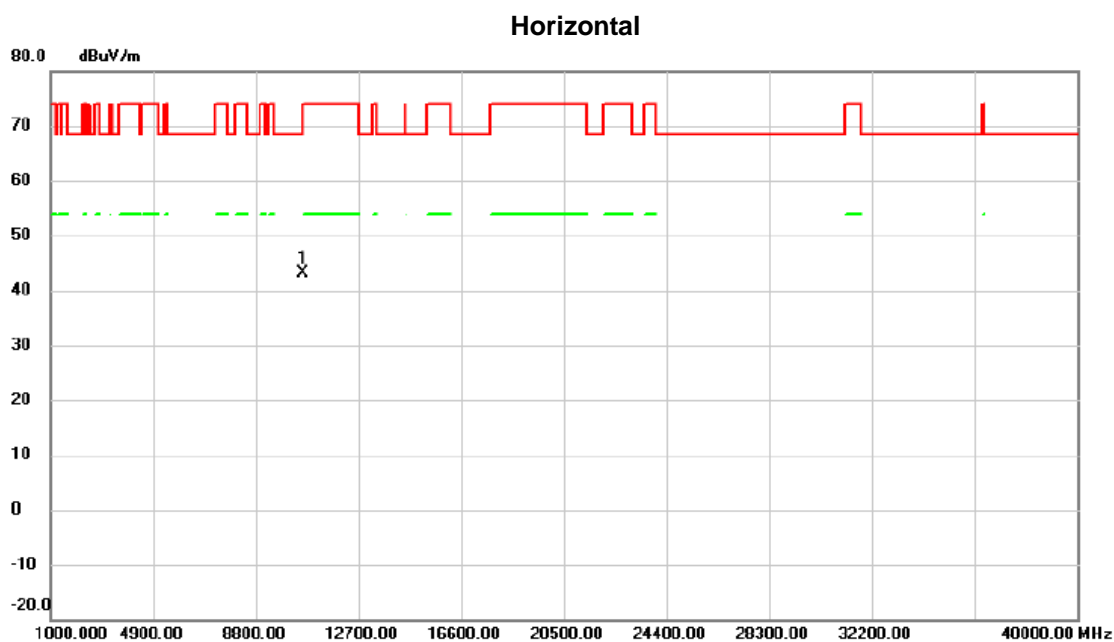

No.	Mk.	Freq. MHz	Reading Level dBuV	Correct Factor dB	Measure- ment dBuV/m	Limit dBuV/m	Margin dB	Detector	Comment
1	*	10600.00	43.99	-0.97	43.02	68.30	-25.28	peak	

**REMARKS:**

- (1) Measurement Value = Reading Level + Correct Factor.
- (2) Margin Level = Measurement Value - Limit Value.

Orthogonal Axis	X		
Test Mode	UNII-2C_TX AX (HE40) Mode 5510 MHz	RU configuration	52/37

### Vertical

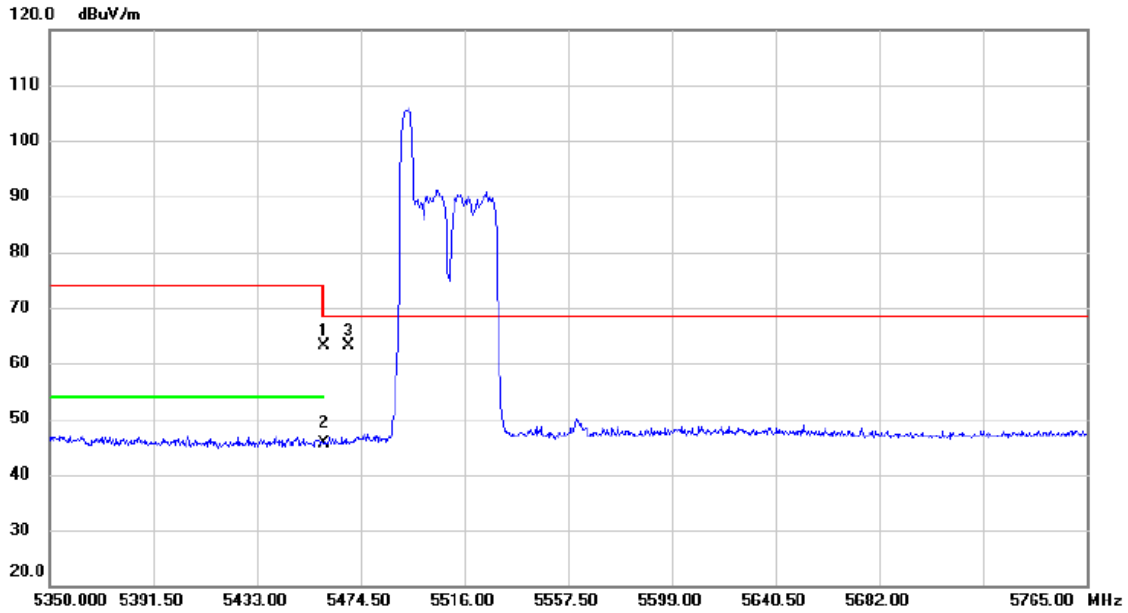

No.	Mk.	Freq. MHz	Reading Level dBuV	Correct Factor dB	Measure- ment dBuV/m	Limit dBuV/m	Margin dB	Detector	Comment
1		5460.000	23.55	39.46	63.01	74.00	-10.99	peak	
2		5460.000	6.14	39.46	45.60	54.00	-8.40	AVG	
3	*	5470.000	23.67	39.47	63.14	68.30	-5.16	peak	

**REMARKS:**

- (1) Measurement Value = Reading Level + Correct Factor.
- (2) Margin Level = Measurement Value - Limit Value.

Orthogonal Axis	X		
Test Mode	UNII-2C_TX AX (HE40) Mode 5510 MHz	RU configuration	52/37

### Horizontal

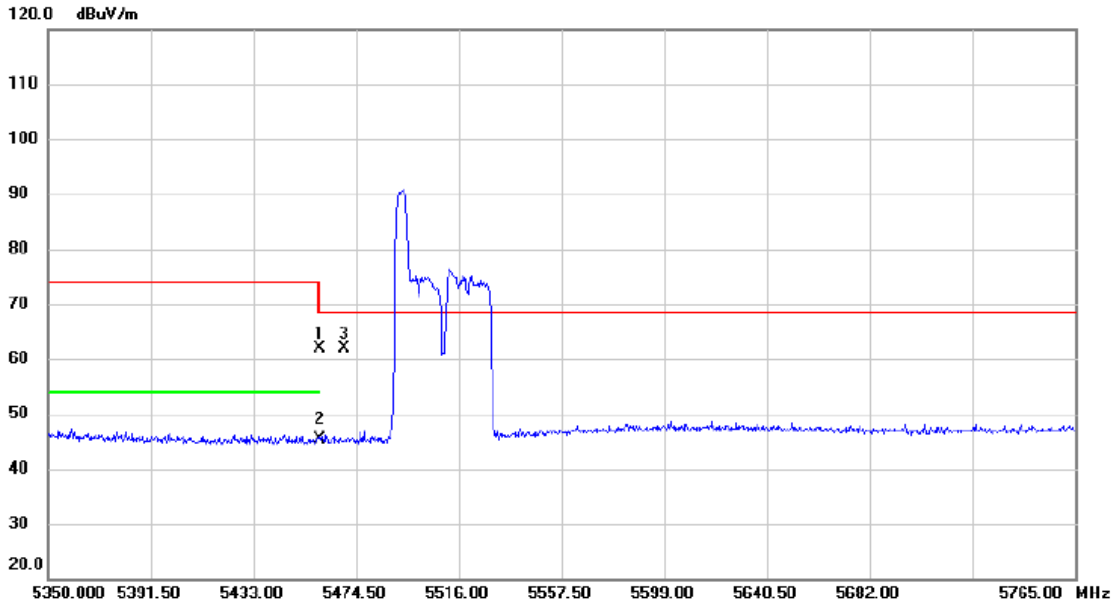

No.	Mk.	Freq. MHz	Reading Level dBuV	Correct Factor dB	Measure- ment dBuV/m	Limit dBuV/m	Margin dB	Detector	Comment
1		5460.000	22.53	39.46	61.99	74.00	-12.01	peak	
2		5460.000	5.95	39.46	45.41	54.00	-8.59	AVG	
3	*	5470.000	22.49	39.47	61.96	68.30	-6.34	peak	

**REMARKS:**

- (1) Measurement Value = Reading Level + Correct Factor.
- (2) Margin Level = Measurement Value - Limit Value.

Orthogonal Axis	X		
Test Mode	UNII-2C_TX AX (HE40) Mode 5510 MHz	RU configuration	106/53

### Vertical

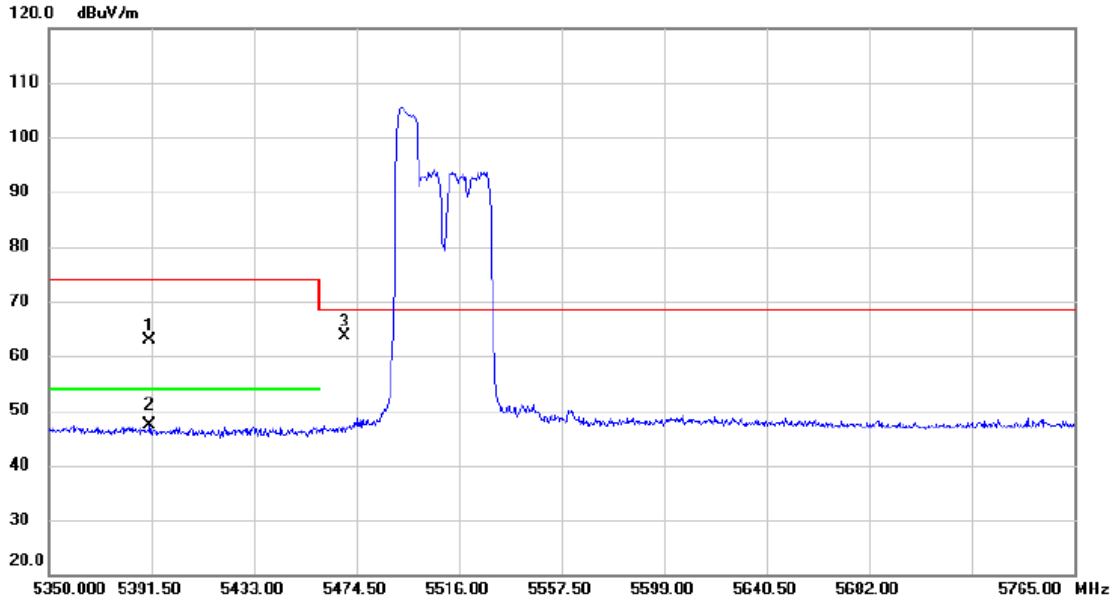

No.	Mk.	Freq. MHz	Reading Level dBuV	Correct Factor dB	Measure- ment dBuV/m	Limit dBuV/m	Margin dB	Detector	Comment
1		5390.670	23.54	39.37	62.91	74.00	-11.09	peak	
2		5390.670	7.96	39.37	47.33	54.00	-6.67	AVG	
3	*	5470.000	24.25	39.47	63.72	68.30	-4.58	peak	

**REMARKS:**

- (1) Measurement Value = Reading Level + Correct Factor.
- (2) Margin Level = Measurement Value - Limit Value.