

# FCC Radio Test Report

## FCC ID: KA2IRX1560A1

This report concerns: **Original Grant**

**Project No.** : 1910H003  
**Equipment** : AX1500 Wi-Fi 6 Router  
**Brand Name** : D-Link  
**Test Model** : DIR-X1560  
**Series Model** : N/A  
**Applicant** : D-Link Corporation  
**Address** : 17595 Mt. Herrmann Fountain Valley, CA92708 USA  
**Manufacturer** : D-Link Corporation  
**Address** : 17595 Mt. Herrmann Fountain Valley, CA92708 USA  
**Date of Receipt** : Oct. 10, 2019  
**Date of Test** : Oct. 10, 2019~Nov. 22, 2019  
**Issued Date** : Nov. 22, 2019  
**Report Version** : R01  
**Test Sample** : Engineering Sample No.: SH201910112  
**Standard(s)** : FCC Part15, Subpart C (15.247)  
ANSI C63.10-2013  
KDB 558074 D01 15.247 Meas Guidance V05r02

The above equipment has been tested and found compliance with the requirement of the relative standards by BTL Inc.

*Krain. Wu*

Prepared by : Krain Wu

*young chai*

Approved by : Young Chai



Certificate # 5123.03

Add: No. 29, Jintang Road, Tangzhen Industry Park, Pudong New Area, Shanghai 201210, China

TEL: +86-021-61765666

Web: [www.newbtl.com](http://www.newbtl.com)

**Declaration**

**BTL** represents to the client that testing is done in accordance with standard procedures as applicable and that test instruments used has been calibrated with standards traceable to international standard(s) and/or national standard(s).

**BTL's** reports apply only to the specific samples tested under conditions. It is manufacture's responsibility to ensure that additional production units of this model are manufactured with the identical electrical and mechanical components. **BTL** shall have no liability for any declarations, inferences or generalizations drawn by the client or others from **BTL** issued reports.

The report must not be used by the client to claim product certification, approval, or endorsement by NVLAP, NIST, A2LA, or any agency of the U.S. Government.

This report is the confidential property of the client. As a mutual protection to the clients, the public and ourselves, the test report shall not be reproduced, except in full, without our written approval.

**BTL's** laboratory quality assurance procedures are in compliance with the **ISO/IEC 17025** requirements, and accredited by the conformity assessment authorities listed in this test report.

**BTL** is not responsible for the sampling stage, so the results only apply to the sample as received.

The information, data and test plan are provided by manufacturer which may affect the validity of results, so it is manufacturer's responsibility to ensure that the apparatus meets the essential requirements of applied standards and in all the possible configurations as representative of its intended use.

**Limitation**

For the use of the authority's logo is limited unless the Test Standard(s)/Scope(s)/Item(s) mentioned in this test report is (are) included in the conformity assessment authorities acceptance respective.

Please note that the measurement uncertainty is provided for informational purpose only and are not use in determining the Pass/Fail results.

<b>Table of Contents</b>	<b>Page</b>
<b>REPORT ISSUED HISTORY</b>	<b>6</b>
<b>1 . SUMMARY OF TEST RESULTS</b>	<b>7</b>
1.1 TEST FACILITY	8
1.2 MEASUREMENT UNCERTAINTY	8
1.3 TEST ENVIRONMENT CONDITIONS	8
<b>2 . GENERAL INFORMATION</b>	<b>9</b>
2.1 GENERAL DESCRIPTION OF EUT	9
2.2 DESCRIPTION OF TEST MODES	11
2.3 PARAMETERS OF TEST SOFTWARE	13
2.4 DUTY CYCLE	14
2.5 BLOCK DIAGRAM SHOWING THE CONFIGURATION OF SYSTEM TESTED	15
2.6 SUPPORT UNITS	15
<b>3 . AC POWER LINE CONDUCTED EMISSIONS TEST</b>	<b>16</b>
3.1 LIMIT	16
3.2 TEST PROCEDURE	16
3.3 DEVIATION FROM TEST STANDARD	16
3.4 TEST SETUP	17
3.5 EUT OPERATION CONDITIONS	17
3.6 TEST RESULTS	17
<b>4 . RADIATED EMISSIONS TEST</b>	<b>18</b>
4.1 LIMIT	18
4.2 TEST PROCEDURE	19
4.3 DEVIATION FROM TEST STANDARD	19
4.4 TEST SETUP	20
4.5 EUT OPERATION CONDITIONS	21
4.6 TEST RESULTS - 9 KHZ TO 30 MHZ	21
4.7 TEST RESULTS - 30 MHZ TO 1000 MHZ	21
4.8 TEST RESULTS - ABOVE 1000 MHZ	21
<b>5 . BANDWIDTH TEST</b>	<b>22</b>
5.1 LIMIT	22
5.2 TEST PROCEDURE	22
5.3 DEVIATION FROM STANDARD	22
5.4 TEST SETUP	22

<b>Table of Contents</b>	<b>Page</b>
5.5 EUT OPERATION CONDITIONS	22
5.6 TEST RESULTS	22
<b>6 . MAXIMUM OUTPUT POWER TEST &amp; E.I.R.P. TEST</b>	<b>23</b>
6.1 LIMIT	23
6.2 TEST PROCEDURE	23
6.3 DEVIATION FROM STANDARD	23
6.4 TEST SETUP	23
6.5 EUT OPERATION CONDITIONS	23
6.6 TEST RESULTS	23
<b>7 . CONDUCTED SPURIOUS EMISSIONS</b>	<b>24</b>
7.1 LIMIT	24
7.2 TEST PROCEDURE	24
7.3 DEVIATION FROM STANDARD	24
7.4 TEST SETUP	24
7.5 EUT OPERATION CONDITIONS	24
7.6 TEST RESULTS	24
<b>8 . POWER SPECTRAL DENSITY TEST</b>	<b>25</b>
8.1 LIMIT	25
8.2 TEST PROCEDURE	25
8.3 DEVIATION FROM STANDARD	25
8.4 TEST SETUP	25
8.5 EUT OPERATION CONDITIONS	25
8.6 TEST RESULTS	25
<b>9 . MEASUREMENT INSTRUMENTS LIST</b>	<b>26</b>
<b>10 . EUT TEST PHOTO</b>	<b>28</b>
<b>APPENDIX A - AC POWER LINE CONDUCTED EMISSIONS</b>	<b>31</b>
<b>APPENDIX B - RADIATED EMISSION - 9 KHZ TO 30 MHZ</b>	<b>34</b>
<b>APPENDIX C - RADIATED EMISSION - 30 MHZ TO 1000 MHZ</b>	<b>39</b>
<b>APPENDIX D - RADIATED EMISSION- ABOVE 1000 MHZ</b>	<b>44</b>
<b>APPENDIX E - BANDWIDTH</b>	<b>95</b>
<b>APPENDIX F - MAXIMUM OUTPUT POWER</b>	<b>100</b>
<b>APPENDIX G - CONDUCTED SPURIOUS EMISSIONS</b>	<b>104</b>

**Table of Contents****Page****APPENDIX H - POWER SPECTRAL DENSITY****111**

**REPORT ISSUED HISTORY**

Report Version	Description	Issued Date
R00	Original Issue.	Nov. 19, 2019
R01	Add the co-located radiated spurious emission data in P43-44 and P94-95	Nov. 22, 2019

## 1. SUMMARY OF TEST RESULTS

Test procedures according to the technical standard(s):

FCC Part15, Subpart C (15.247)				
Standard(s) Section	Test Item	Test Result	Judgment	Remark
15.207	AC Power Line Conducted Emissions	APPENDIX A	PASS	-----
15.247(d) 15.205(a) 15.209(a)	Radiated Emissions	APPENDIX B APPENDIX C APPENDIX D	PASS	-----
15.247(a)(2)	Bandwidth	APPENDIX E	PASS	-----
15.247(b)(3)	Maximum output power	APPENDIX F	PASS	-----
15.247(d)	Conducted Spurious Emissions	APPENDIX G	PASS	-----
15.247(e)	Power Spectral Density	APPENDIX H	PASS	-----
15.203	Antenna Requirement	-----	PASS	-----

Note:

(1) "N/A" denotes test is not applicable in this test report.

### 1.1 TEST FACILITY

The test facilities used to collect the test data in this report is at the location of No. 29, Jintang Road, Tangzhen Industry Park, Pudong New Area, Shanghai 201210, China  
 BTL's Test Firm Registration Number for FCC: 476765  
 BTL's Designation Number for FCC: CN1241

### 1.2 MEASUREMENT UNCERTAINTY

ISO/IEC 17025 requires that an estimate of the measurement uncertainties associated with the emissions test results be included in the report. The measurement uncertainties given below are based on a 95% confidence level (based on a coverage factor (k=2))  
 The BTL measurement uncertainty as below table:

#### A. Radiated emissions test:

Test Site	Method	Measurement Frequency Range	Ant. H / V	U, (dB)
SH-CB01	CISPR	9 KHz~30 MHz	V	3.79
		9 KHz~30 MHz	H	3.57
		30 MHz~200 MHz	V	4.04
		30 MHz~200 MHz	H	3.76
		200 MHz~1,000 MHz	V	4.24
		200 MHz~1,000 MHz	H	3.84
		1 GHz~18 GHz	V	4.46
		1 GHz~18 GHz	H	4.40
		18 GHz~40 GHz	V	3.95
		18 GHz~40 GHz	H	3.95

Note: Unless specifically mentioned, the uncertainty of measurement has not been taken into account to declare the compliance or non-compliance to the specification.

### 1.3 TEST ENVIRONMENT CONDITIONS

Test Item	Temperature	Humidity	Test Voltage	Tested By
AC Power Line Conducted Emissions	22°C	53%	AC 120V	Forest Li
Radiated Emissions-9K-30MHz	22°C	45%	AC 120V	Forest Li
Radiated Emissions-30 MHz to 1GHz	22°C	55%	AC 120V	Forest Li
Radiated Emissions-Above 1000 MHz	22°C	55%	AC 120V	Forest Li
Bandwidth	25°C	48%	AC 120V	Forest Li
Maximum output power & e.i.r.p.	25°C	48%	AC 120V	Forest Li
Conducted Spurious Emissions	25°C	48%	AC 120V	Forest Li
Power Spectral Density	Normal & Extreme	48%	Normal & Extreme	Forest Li



## 2. GENERAL INFORMATION

### 2.1 GENERAL DESCRIPTION OF EUT

Equipment	AX1500 Wi-Fi 6 Router
Brand Name	D-Link
Test Model	DIR-X1560
Series Model	N/A
Model Difference(s)	N/A
Software Version	1
Hardware Version	A1
Power Source	DC Voltage supplied from AC/DC adapter: Brand/Model: Gongjin /S18B22-120A150-CJ
Power Rating	I/P: 100-240V ~ 50/60Hz 0.7A O/P: 12V --- 1.5A
Operation Frequency	2412 MHz ~ 2462 MHz
Modulation Type	IEEE 802.11b: DSSS IEEE 802.11g: OFDM IEEE 802.11n: OFDM
Bit Rate of Transmitter	IEEE 802.11b: 11/5.5/2/1 Mbps IEEE 802.11g: 54/48/36/24/18/12/9/6 Mbps IEEE 802.11n: up to 300 Mbps
Maximum Output Power Non-Beamforming	IEEE 802.11b: 26.59 dBm (0.4560 W) IEEE 802.11g: 26.62 dBm (0.4592 W) IEEE 802.11n (HT20): 29.10 dBm (0.8128 W) IEEE 802.11n (HT40): 28.51 dBm (0.7096 W)

Note:

- For a more detailed features description, please refer to the manufacturer's specifications or the user's manual.
- Channel List:

CH01 - CH11 for IEEE 802.11b, IEEE 802.11g, IEEE 802.11n (HT20) CH03 - CH09 for IEEE 802.11n (HT40)							
Channel	Frequency (MHz)	Channel	Frequency (MHz)	Channel	Frequency (MHz)	Channel	Frequency (MHz)
01	2412	04	2427	07	2442	10	2457
02	2417	05	2432	08	2447	11	2462
03	2422	06	2437	09	2452		

## 3. Antenna Specification:

Ant.	Brand	Model Name	Antenna Type	Connector	Gain (dBi)	Note
1	N/A	N/A	Dipole	N/A	2	N/A
2	N/A	N/A	Dipole	N/A	2	N/A

## Note:

(1) The EUT incorporates a MIMO function. Physically, the EUT provides two completed transmitters and receivers (2T2R), all transmit signals are completely uncorrelated, then, Direction gain = GANT, that is Directional gain for UNII-1=2; for UNII-3=2.

## 4. Table for Antenna Configuration:

Operating Mode	TX Mode	1TX	2TX
IEEE 802.11b		V (Ant. 1 )	-
IEEE 802.11g		V (Ant. 1 )	-
IEEE 802.11n (HT20)		-	V (Ant. 1 + Ant. 2)
IEEE 802.11n (HT40)		-	V (Ant. 1 + Ant. 2)

## 2.2 DESCRIPTION OF TEST MODES

The test system was pre-tested based on the consideration of all possible combinations of EUT operation mode.

Pretest Mode	Description
Mode 1	TX B Mode Channel 01/06/11
Mode 2	TX G Mode Channel 01/06/11
Mode 3	TX N-20 MHz Mode Channel 01/06/11
Mode 4	TX N-40 MHz Mode Channel 03/06/09
Mode 5	TX N20 MODE CHANNEL 06
Mode 6	TX-CO-LOCATION 2437 N20 & 5755 ax 40

Following mode(s) as (were) found to be the worst case(s) and selected for the final test.

<b>AC power line conducted emissions test</b>	
Final Test Mode:	Description
Mode 5	TX N20 MODE CHANNEL 06

<b>Radiated emissions test - Below 1GHz</b>	
Final Test Mode:	Description
Mode 5	TX N20 MODE CHANNEL 06
Mode 6	TX-CO-LOCATION 2437 N20 & 5755 ax 40

<b>Radiated emissions test- Above 1GHz</b>	
Final Test Mode:	Description
Mode 1	TX B Mode Channel 01/06/11
Mode 2	TX G Mode Channel 01/06/11
Mode 3	TX N-20 MHz Mode Channel 01/06/11
Mode 4	TX N-40 MHz Mode Channel 03/06/09
Mode 6	TX-CO-LOCATION 2437 N20 & 5755 ax 40

<b>Conducted test</b>	
<b>Final Test Mode:</b>	<b>Description</b>
Mode 1	TX B Mode Channel 01/06/11
Mode 2	TX G Mode Channel 01/06/11
Mode 3	TX N-20 MHz Mode Channel 01/06/11
Mode 4	TX N-40 MHz Mode Channel 03/06/09

**NOTE:**

- (1) The measurements are performed at the high, middle, low available channels.
- (2) 802.11b mode: CCK (1 Mbps)  
802.11g mode: OFDM (6 Mbps)  
802.11n HT20 mode : BPSK (13 Mbps)  
802.11n HT40 mode : BPSK (27 Mbps)  
For radiated emission tests, the highest output powers were set for final test.
- (3) For radiated emission below 1 GHz test, the IEEE 802.11n20 is found to be the worst case and recorded.
- (4) For radiated emission above 1 GHz test, 1GHz~26.5GHz have been pre-tested and in this report only recorded the worst case. The remaining spurious points are all below the limit value of 20dB.

**2.3 PARAMETERS OF TEST SOFTWARE****Non-Beamforming**

Test Software	accessMTool		
Frequency (MHz)	2412	2437	2462
IEEE 802.11b	81	94	82
IEEE 802.11g	64	84	67
IEEE 802.11n (HT20)	57	70	60
Frequency (MHz)	2422	2437	2452
IEEE 802.11n (HT40)	46	62	54

## 2.4 DUTY CYCLE

If duty cycle is  $\geq 98\%$ , duty factor is not required.  
 If duty cycle is  $< 98\%$ , duty factor shall be considered.  
 The output power = measured power + duty factor.

**IEEE 802.11b**

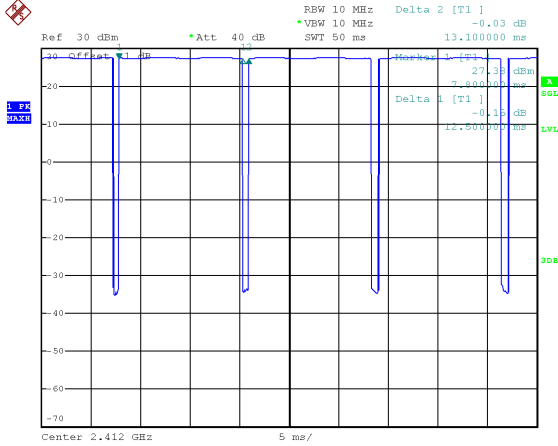

Date: 8.NOV.2019 16:15:53

Duty cycle =  $12.500 \text{ ms} / 13.100 \text{ ms} = 95.42\%$   
 Duty Factor =  $10 \log(1/\text{Duty cycle}) = 0.20$

**IEEE 802.11g**

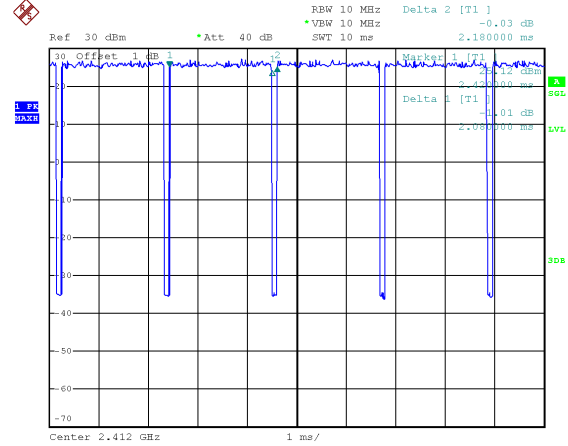

Date: 8.NOV.2019 16:18:09

Duty cycle =  $2.080 \text{ ms} / 2.180 \text{ ms} = 95.41\%$   
 Duty Factor =  $10 \log(1/\text{Duty cycle}) = 0.20$

**IEEE 802.11n (HT20)**

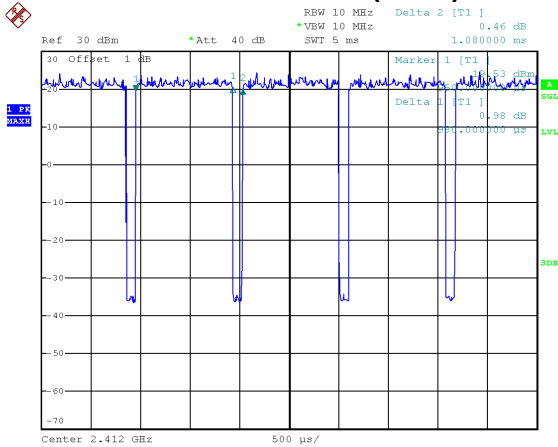

Date: 8.NOV.2019 16:19:41

Duty cycle =  $0.980 \text{ ms} / 1.080 \text{ ms} = 90.74\%$   
 Duty Factor =  $10 \log(1/\text{Duty cycle}) = 0.42$ ,

**IEEE 802.11n (HT40)**

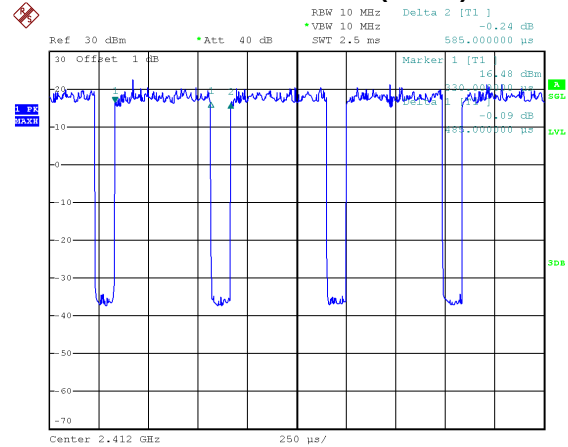

Date: 8.NOV.2019 16:21:06

Duty cycle =  $0.485 \text{ ms} / 0.585 \text{ ms} = 82.91\%$   
 Duty Factor =  $10 \log(1/\text{Duty cycle}) = 0.81$

**NOTE:**

For IEEE 802.11g and IEEE 802.11n (HT20):

For radiated emissions frequency above 1 GHz, the resolution bandwidth of test spectrum analyzer is 1 MHz and the video bandwidth is 1 kHz (Duty cycle  $< 98\%$ ).

For IEEE 802.11n (HT40):

For radiated emissions frequency above 1 GHz, the resolution bandwidth of test spectrum analyzer is 1 MHz and the video bandwidth is 2 kHz (Duty cycle  $< 98\%$ ).

## 2.5 BLOCK DIAGRAM SHOWING THE CONFIGURATION OF SYSTEM TESTED

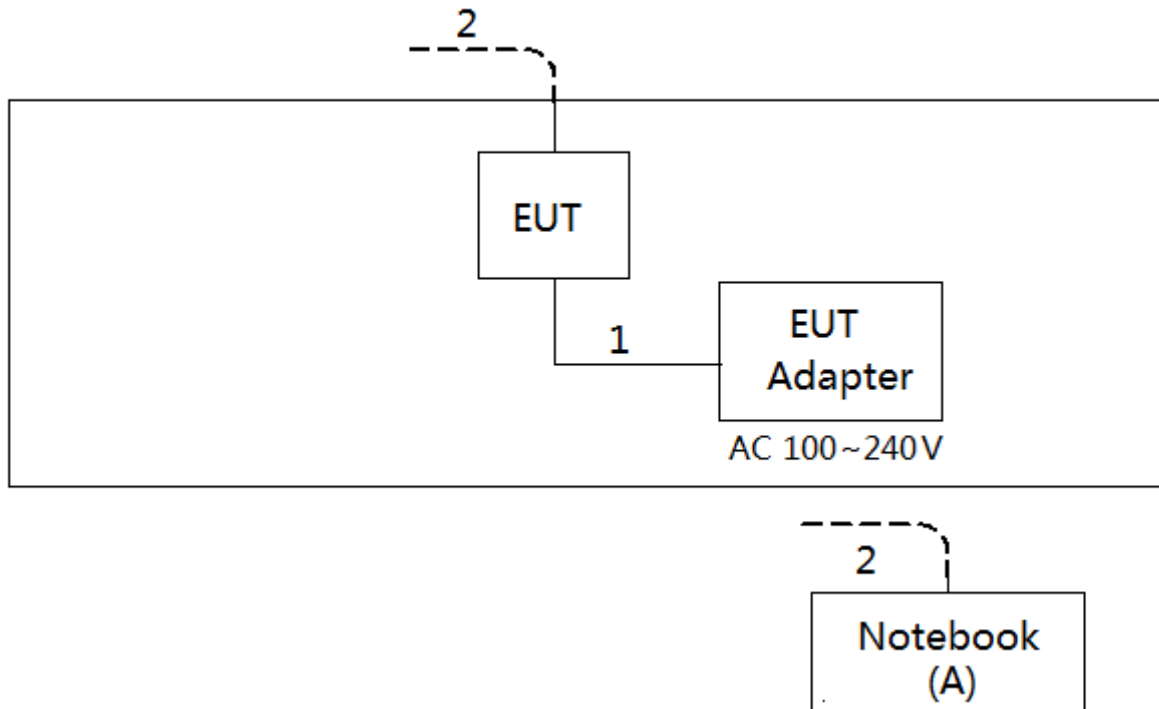

## 2.6 SUPPORT UNITS

Item	Equipment	Mfr/Brand	Model/Type No.	Series No.
A	Notebook	Lenovo	#P152014	N/A

Item	Cable Type	Shielded Type	Ferrite Core	Length
1	DC Cable	N/A	N/A	1.5m
2	RJ45 Cable	N/A	N/A	10m

### 3. AC POWER LINE CONDUCTED EMISSIONS TEST

#### 3.1 LIMIT

Frequency of Emission (MHz)	Limit (dB $\mu$ V)	
	Quasi-peak	Average
0.15 - 0.50	66 to 56*	56 - 46*
0.50 - 5.0	56	46
5.0 - 30.0	60	50

**NOTE:**

- (1) The tighter limit applies at the band edges.
- (2) The limit of " \* " marked band means the limitation decreases linearly with the logarithm of the frequency in the range.

The following table is the setting of the receiver

Receiver Parameters	Setting
Attenuation	10 dB
Start Frequency	0.15 MHz
Stop Frequency	30 MHz
IF Bandwidth	9 kHz

#### 3.2 TEST PROCEDURE

- a. The EUT was placed 0.8 meters from the horizontal ground plane with EUT being connected to the power mains through a line impedance stabilization network (LISN). All other support equipment powered from additional LISN(s). The LISN provide 50 Ohm/ 50uH of coupling impedance for the measuring instrument.
- b. Interconnecting cables that hang closer than 40 cm to the ground plane shall be folded back and forth in the center forming a bundle 30 to 40 cm long.
- c. I/O cables that are not connected to a peripheral shall be bundled in the center. The end of the cable may be terminated, if required, using the correct terminating impedance. The overall length shall not exceed 1 m.
- d. LISN at least 80 cm from nearest part of EUT chassis.
- e. For the actual test configuration, please refer to the related Item -EUT Test Photos.

#### 3.3 DEVIATION FROM TEST STANDARD

No deviation



### 3.4 TEST SETUP

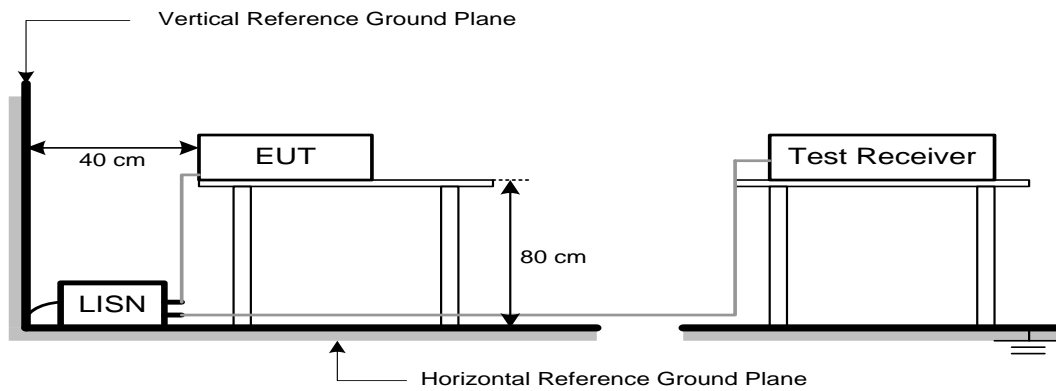

### 3.5 EUT OPERATION CONDITIONS

EUT was programmed to be in continuously transmitting mode.

### 3.6 TEST RESULTS

Please refer to the APPENDIX A.

## 4. RADIATED EMISSIONS TEST

### 4.1 LIMIT

In case the emission fall within the restricted band specified on 15.205(a) and RSS-Gen 8.10, then the 15.209(a) & RSS-Gen 8.9 limit in the table below has to be followed.

LIMITS OF RADIATED EMISSION MEASUREMENT (9 kHz-1000 MHz)

Frequency (MHz)	Field Strength (microvolts/meter)	Measurement Distance (meters)
0.009-0.490	2400/F(kHz)	300
0.490-1.705	24000/F(kHz)	30
1.705-30.0	30	30
30-88	100	3
88-216	150	3
216-960	200	3
Above 960	500	3

LIMITS OF RADIATED EMISSION MEASUREMENT (9 kHz-30 MHz)

Frequency (MHz)	Magnetic field strength (H-Field) ( $\mu\text{A/m}$ )	Measurement Distance (meters)
0.009-0.490	6.37/F(kHz)	300
0.490-1.705	6.37/F(kHz)	30
1.705-30.0	0.08	30

LIMITS OF RADIATED EMISSION MEASUREMENT (30 MHz-1000 MHz)

Frequency (MHz)	Field Strength ( $\mu\text{V/m}$ at 3m)
30-88	100
88-216	150
216-960	200
Above 960	500

LIMITS OF RADIATED EMISSION MEASUREMENT (Above 1000 MHz)

Frequency (MHz)	(dBuV/m at 3 m)	
	Peak	Average
Above 1000	74	54

**NOTE:**

- (1) The limit for radiated test was performed according to FCC PART 15C/RSS-247.
- (2) The tighter limit applies at the band edges.
- (3) Emission level (dBuV/m)=20log Emission level (uV/m).
- (4) The test result calculated as following:  
 Measurement Value = Reading Level + Correct Factor  
 Correct Factor = Antenna Factor + Cable Loss - Amplifier Gain(if use)  
 Margin Level = Measurement Value - Limit Value

Spectrum Parameter	Setting
Attenuation	Auto
Start Frequency	1000 MHz
Stop Frequency	10th carrier harmonic
RBW / VBW (Emission in restricted band)	1 MHz / 3 MHz for Peak, 1 MHz / 1/T for Average

Receiver Parameter	Setting
Attenuation	Auto
Start ~ Stop Frequency	9 kHz~90 kHz for PK/AVG detector
Start ~ Stop Frequency	90 kHz~110 kHz for QP detector
Start ~ Stop Frequency	110 kHz~490 kHz for PK/AVG detector
Start ~ Stop Frequency	490 kHz~30 MHz for QP detector
Start ~ Stop Frequency	30 MHz~1000 MHz for QP detector

#### 4.2 TEST PROCEDURE

- a. The measuring distance of 3 m shall be used for measurements. The EUT was placed on the top of a rotating table 0.8 meter above the ground at a 3 meter semi-anechoic chamber. The table was rotated 360 degrees to determine the position of the highest radiation.(below 1 GHz)
- b. The measuring distance of 3 m shall be used for measurements. The EUT was placed on the top of a rotating table 1.5 meter above the ground at a 3 meter semi-anechoic chamber. The table was rotated 360 degrees to determine the position of the highest radiation.(above 1 GHz)
- c. The height of the equipment or of the substitution antenna shall be 0.8m or 1.5m; the height of the test antenna shall vary between 1 m to 4 m. Both horizontal and vertical polarizations of the antenna are set to make the measurement.
- d. For each suspected emission, the EUT was arranged to its worst case and then the antenna was tuned to heights find the maximum reading (used Bore sight function).
- e. The receiver system was set to peak and average detect function and specified bandwidth with maximum hold mode when the test frequency is above 1 GHz.
- f. The initial step in collecting radiated emission data is a receiver peak detector mode pre-scanning the measurement frequency range. Significant peaks are then marked and then Quasi Peak detector mode re-measured.
- g. All readings are Peak unless otherwise stated QP in column of Note. Peak denotes that the Peak reading compliance with the QP Limits and then QP Mode measurement didn't perform. (below 1 GHz)
- h. All readings are Peak Mode value unless otherwise stated AVG in column of Note. If the Peak Mode Measured value compliance with the Peak Limits and lower than AVG Limits, the EUT shall be deemed to meet both Peak & AVG Limits and then only Peak Mode was measured, but AVG Mode didn't perform. (above 1 GHz)
- i. For the actual test configuration, please refer to the related Item -EUT Test Photos.

#### 4.3 DEVIATION FROM TEST STANDARD

No deviation

**4.4 TEST SETUP**

**9 kHz-30 MHz**

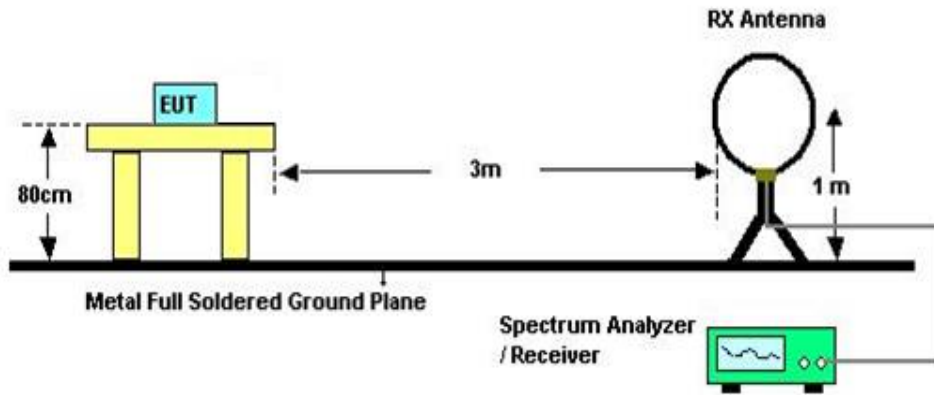

**30 MHz to 1 GHz**

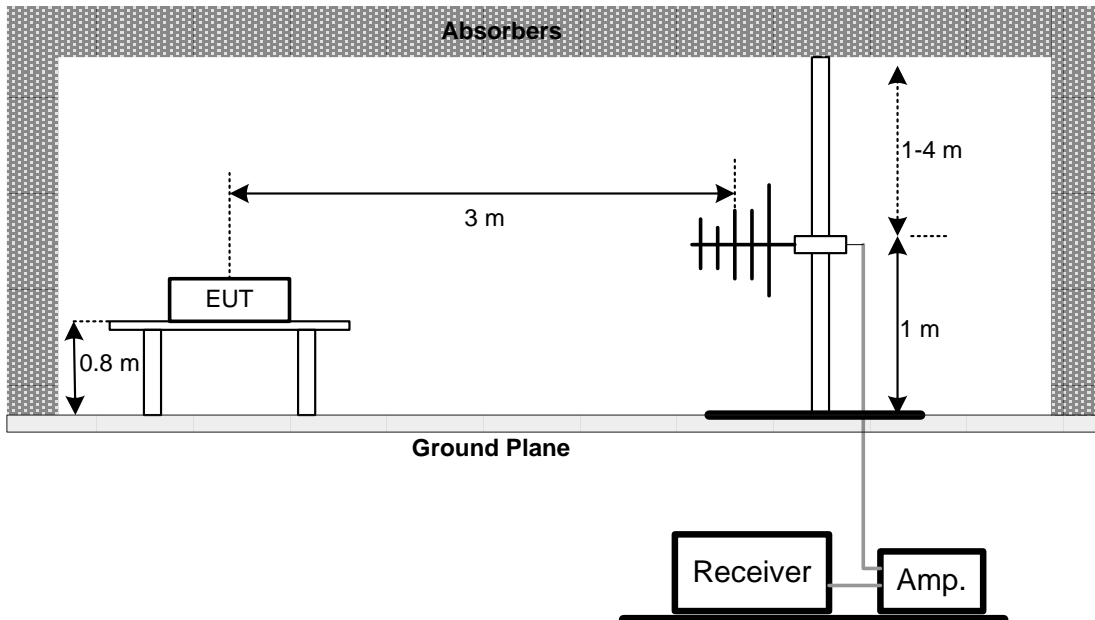

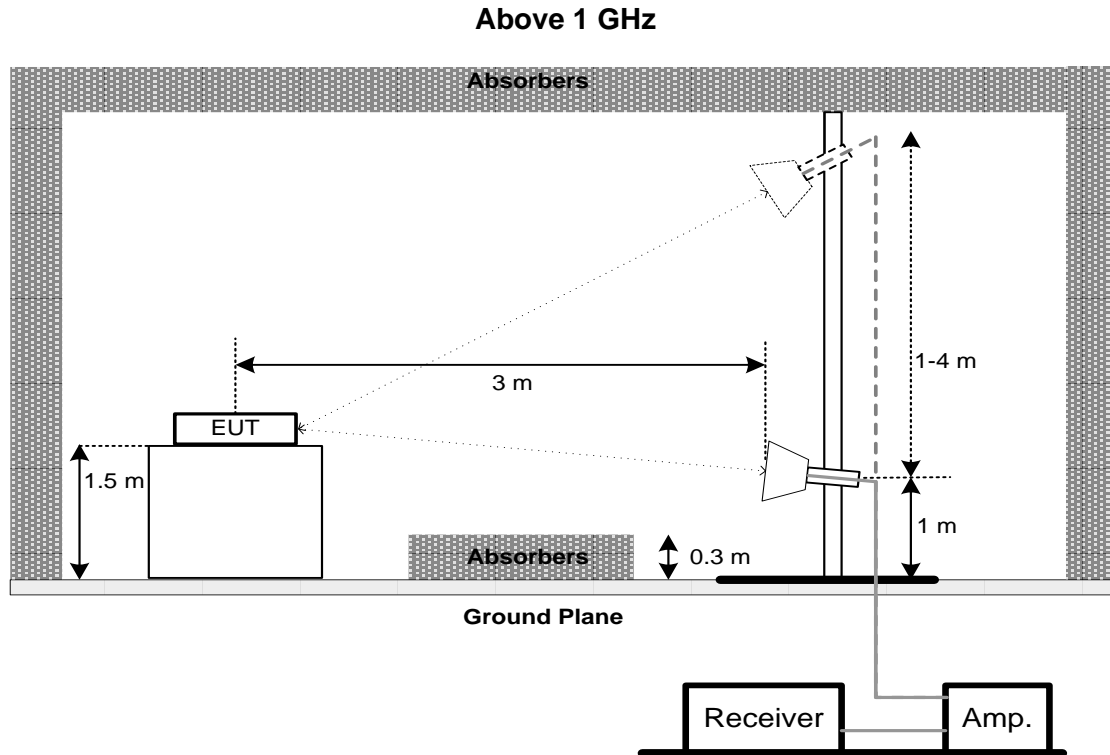

#### 4.5 EUT OPERATION CONDITIONS

The EUT was programmed to be in continuously transmitting mode.

#### 4.6 TEST RESULTS - 9 KHZ TO 30 MHZ

Please refer to the APPENDIX B

Remark:

- (1) Distance extrapolation factor =  $40 \log (\text{specific distance} / \text{test distance})$  (dB).
- (2) Limit line = specific limits (dBuV) + distance extrapolation factor.

#### 4.7 TEST RESULTS - 30 MHZ TO 1000 MHZ

Please refer to the APPENDIX C.

#### 4.8 TEST RESULTS - ABOVE 1000 MHZ

Please refer to the APPENDIX D.

Remark:

- (1) No limit: This is fundamental signal, the judgment is not applicable.  
For fundamental signal judgment was referred to Peak output test.

## 5. BANDWIDTH TEST

### 5.1 LIMIT

FCC Part15, Subpart C (15.247)		
Section	Test Item	Limit
15.247(a)(2)	6 dB Bandwidth	Minimum 500 kHz
	99% Emission Bandwidth	-

### 5.2 TEST PROCEDURE

- The EUT was directly connected to the spectrum analyzer and antenna output port as show in the block diagram below.
- Spectrum Setting: RBW= 100 kHz, VBW=300 kHz, Sweep time = 2.5 ms.
- The bandwidth was performed in accordance with method 11.8.1 of ANSI C63.10-2013.

### 5.3 DEVIATION FROM STANDARD

No deviation.

### 5.4 TEST SETUP



### 5.5 EUT OPERATION CONDITIONS

The EUT was programmed to be in continuously transmitting mode.

### 5.6 TEST RESULTS

Please refer to the APPENDIX E.

**6. MAXIMUM OUTPUT POWER TEST & E.I.R.P. TEST****6.1 LIMIT**

FCC Part15, Subpart C (15.247)		
Section	Test Item	Limit
15.247(b)(3)	Maximum Output Power	1 Watt or 30dBm

**6.2 TEST PROCEDURE**

- The EUT was directly connected to the power meter and antenna output port as show in the block diagram below.
- The maximum conducted output power was performed in accordance with method 11.9.1.3 (for peak power) or 11.9.2.3.1 (for AVG power) of ANSI C63.10-2013.

**6.3 DEVIATION FROM STANDARD**

No deviation.

**6.4 TEST SETUP****6.5 EUT OPERATION CONDITIONS**

The EUT was programmed to be in continuously transmitting mode.

**6.6 TEST RESULTS**

Please refer to the APPENDIX F.

## 7. CONDUCTED SPURIOUS EMISSIONS

### 7.1 LIMIT

In any 100 kHz bandwidth outside the frequency band in which the spread spectrum or digitally modulated intentional radiator is operating, the radio frequency power that is produced by the intentional radiator shall be at least 20 dB below that in the 100 kHz bandwidth within the band that contains the highest level of the desired power, based on either an RF conducted or a radiated measurement, provided the transmitter demonstrates compliance with the peak Output Power limits. If the transmitter complies with the Output Power limits based on the use of RMS averaging over a time interval, as permitted under paragraph (b)(3) of this section, the attenuation required under this paragraph shall be 30 dB instead of 20 dB. Attenuation below the general limits specified in Section 15.209(a) is not required. In addition, radiated emissions which fall in the restricted bands, as defined in Section 15.205(a), must also comply with the radiated emission limits specified in Section 15.209(a) (see Section 15.205(c)).

### 7.2 TEST PROCEDURE

- a. The EUT was directly connected to the spectrum analyzer and antenna output port as show in the block diagram below.
- b. Spectrum Setting: RBW= 100 kHz, VBW=300 kHz, Sweep time = Auto.

### 7.3 DEVIATION FROM STANDARD

No deviation.

### 7.4 TEST SETUP

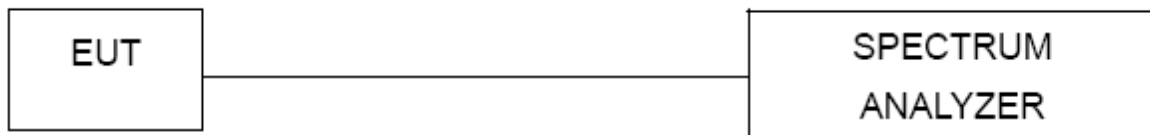

### 7.5 EUT OPERATION CONDITIONS

The EUT was programmed to be in continuously transmitting mode.

### 7.6 TEST RESULTS

Please refer to the APPENDIX G.



## 8. POWER SPECTRAL DENSITY TEST

### 8.1 LIMIT

FCC Part15, Subpart C (15.247)		
Section	Test Item	Limit
15.247(e)	Power Spectral Density	8 dBm (in any 3 kHz)

### 8.2 TEST PROCEDURE

- The EUT was directly connected to the spectrum analyzer and antenna output port as show in the block diagram below.
- Spectrum Setting: RBW=3 kHz, VBW=10 kHz, Sweep time = Auto.
- The Power Spectral Density was performed in accordance with method 11.10.2 of ANSI C63.10-2013.

### 8.3 DEVIATION FROM STANDARD

No deviation.

### 8.4 TEST SETUP



### 8.5 EUT OPERATION CONDITIONS

The EUT was programmed to be in continuously transmitting mode.

### 8.6 TEST RESULTS

Please refer to the APPENDIX H.

## 9. MEASUREMENT INSTRUMENTS LIST

AC Power Line Conducted Emissions					
Item	Kind of Equipment	Manufacturer	Type No.	Serial No.	Calibrated until
1	Line Impedance Stabilisation Network	Schwarzbeck	NNLK 8121	8121-822	Mar. 29, 2020
2	TWO-LINE V-NETWORK	R&S	ENV216	101340	Nov. 20, 2019
3	Test Cable	emci	EMCRG400-BM-NM-10000	170628	Apr. 17, 2020
4	EMI Test Receiver	R&S	ESCI	100082	Mar. 29, 2020
5	50Ω Terminator	SHX	TF2-1G-A	17051602	Mar. 29, 2020
6	50Ω coaxial switch	Anritsu	MP59B	6201750902	Mar. 29, 2020
7	Measurement Software	Farad	EZ-EMC Ver.NB-03A1-01	N/A	N/A

Radiated Emissions - 9 kHz to 30 MHz					
Item	Kind of Equipment	Manufacturer	Type No.	Serial No.	Calibrated until
1	Loop Antenna	EMCI	EMCI LPA600	275	Mar. 29, 2020
2	EMI Test Receiver	R&S	ESCI	100082	Mar. 29, 2020
3	Measurement Software	Farad	EZ-EMC Ver.NB-03A1-01	N/A	N/A

Radiated Emissions - 30 MHz to 1 GHz					
Item	Kind of Equipment	Manufacturer	Type No.	Serial No.	Calibrated until
1	TRILOG Broadband Antenna	Schwarzbeck	VULB 9168	719	Mar. 29, 2020
2	Pre-Amplifier	emci	EMC9135	980400	Mar. 29, 2020
3	MXE EMI Receiver	Keysight	N9038A	MY57150106	Mar. 29, 2020
4	Test Cable	emci	EMC104-SM-SM-7000	170330	Apr. 17, 2020
5	Test Cable	emci	EMC104-SM-SM-1000	170331	Apr. 17, 2020
6	Test Cable	emci	EMC104-SM-NM-3500	170621	Apr. 17, 2020
7	Measurement Software	Farad	EZ-EMC Ver.NB-03A1-01	N/A	N/A

Radiated Emissions - Above 1 GHz					
Item	Kind of Equipment	Manufacturer	Type No.	Serial No.	Calibrated until
1	Double-Ridged Waveguide Horn Antenna	ETS-Lindgren	9120D	00206960	Mar. 29, 2020
2	Pre-Amplifier	emci	EMC012645SE	980421	Mar. 29, 2020
3	EXA Spectrum Analyzer	Keysight	N9010A	MY56480545	Mar. 29, 2020
4	Test Cable	emci	EMC104-SM-SM-7000	170330	Apr. 17, 2020
5	Test Cable	emci	EMC104-SM-SM-1000	170331	Apr. 17, 2020
6	Test Cable	emci	EMC104-SM-NM-3500	170621	Apr. 17, 2020
7	Measurement Software	Farad	EZ-EMC Ver.NB-03A1-01	N/A	N/A
8	MXE EMI Receiver	Keysight	N9038A	MY57150106	Mar. 29, 2020

Bandwidth					
Item	Kind of Equipment	Manufacturer	Type No.	Serial No.	Calibrated until
1	Spectrum Analyzer	R&S	FSP40	100626	Mar. 29, 2020

Maximum Output Power					
Item	Kind of Equipment	Manufacturer	Type No.	Serial No.	Calibrated until
1	Spectrum Analyzer	R&S	FSP40	100626	Mar. 29, 2020
2	Peak Power Analyze	Keysight	8990B	MY51000507	Mar. 29, 2020
3	Wideband Power Sensor	Keysight	N9123A	MY58310003	Mar. 29, 2020

Antenna Conducted Spurious Emissions					
Item	Kind of Equipment	Manufacturer	Type No.	Serial No.	Calibrated until
1	Spectrum Analyzer	R&S	FSP40	100626	Mar. 29, 2020

Power Spectral Density					
Item	Kind of Equipment	Manufacturer	Type No.	Serial No.	Calibrated until
1	Spectrum Analyzer	R&S	FSP40	100626	Mar. 29, 2020

Remark: "N/A" denotes no model name, serial no. or calibration specified.  
 All calibration period of equipment list is one year.

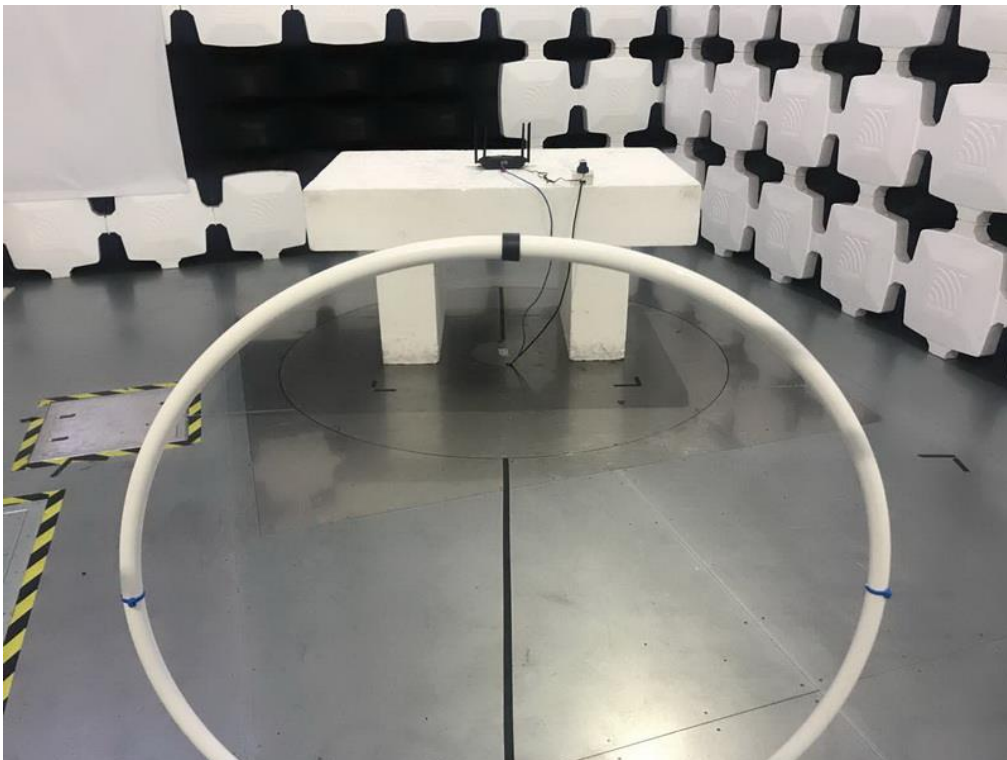
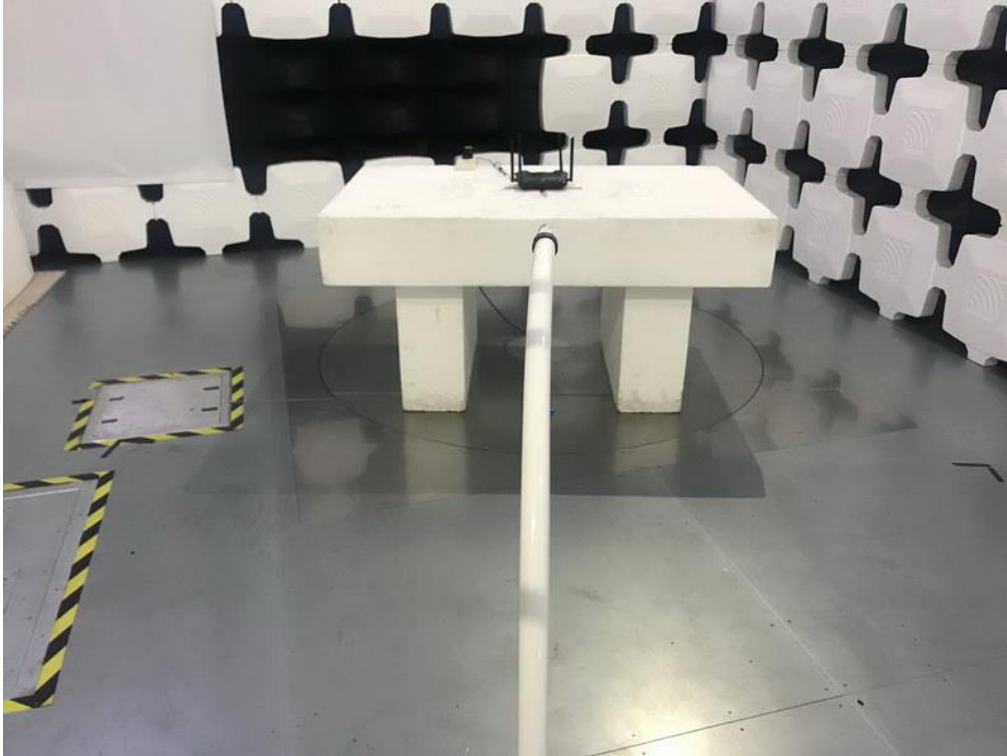
**10. EUT TEST PHOTO****Radiated Emissions Test Photos****9 kHz to 30 MHz**

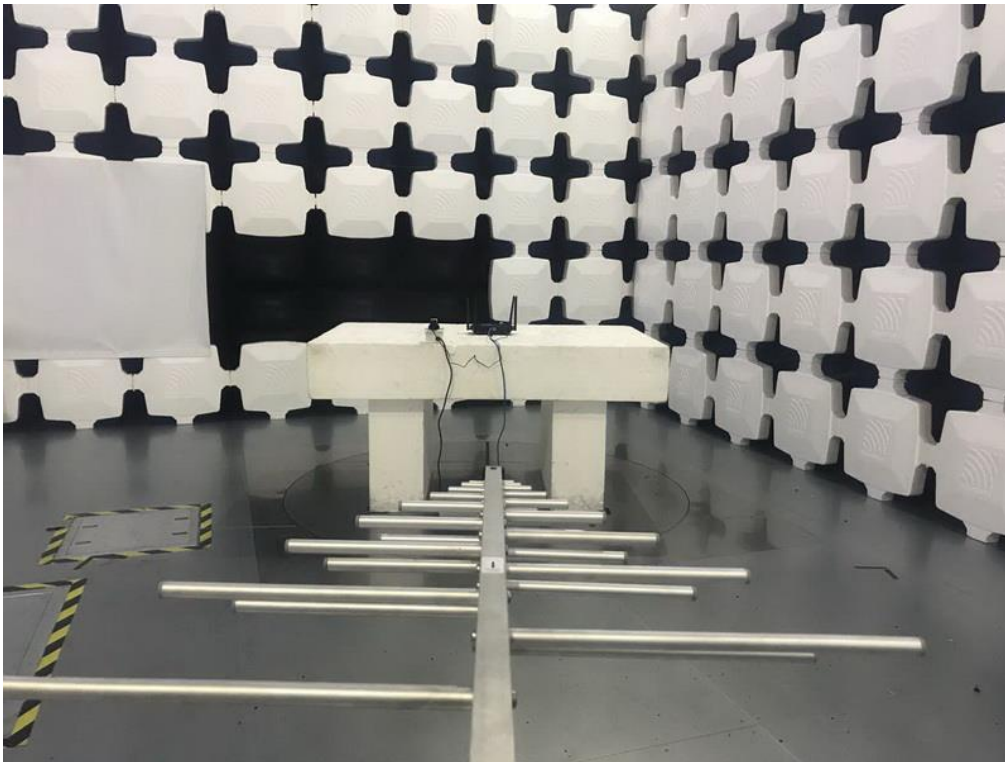
**Radiated Emissions Test Photos****30 MHz to 1 GHz**

**Radiated Emissions Test Photos****Above 1 GHz**

## **APPENDIX A - AC POWER LINE CONDUCTED EMISSIONS**

Test Mode: TX N20 MODE CHANNEL 06

### Line

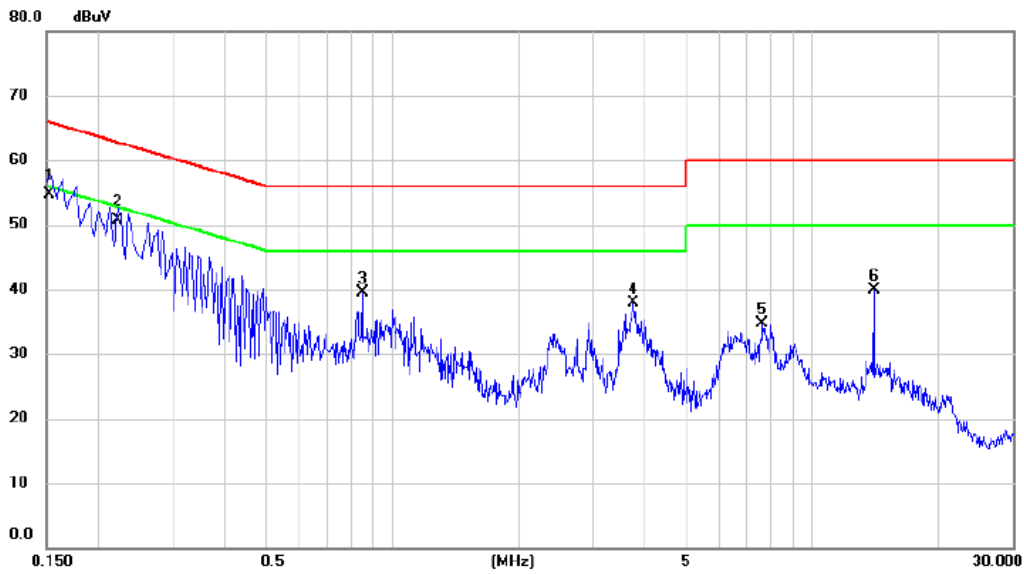

No.	Mk.	Freq. MHz	Reading Level dBuV	Correct Factor dB	Measure- ment dBuV	Limit dBuV	Margin dB	Detector	Comment
1	*	0.1532	44.89	9.76	54.65	65.82	-11.17	QP	
2		0.2220	40.92	9.84	50.76	62.74	-11.98	QP	
3		0.8474	29.76	9.82	39.58	56.00	-16.42	peak	
4		3.7410	27.83	10.04	37.87	56.00	-18.13	peak	
5		7.6154	24.52	10.14	34.66	60.00	-25.34	peak	
6		14.0010	29.79	10.09	39.88	60.00	-20.12	peak	

**REMARKS:**

- (1) Measurement Value = Reading Level + Correct Factor.
- (2) Margin Level = Measurement Value - Limit Value.



Test Mode: TX N20 MODE CHANNEL 06

### Neutral

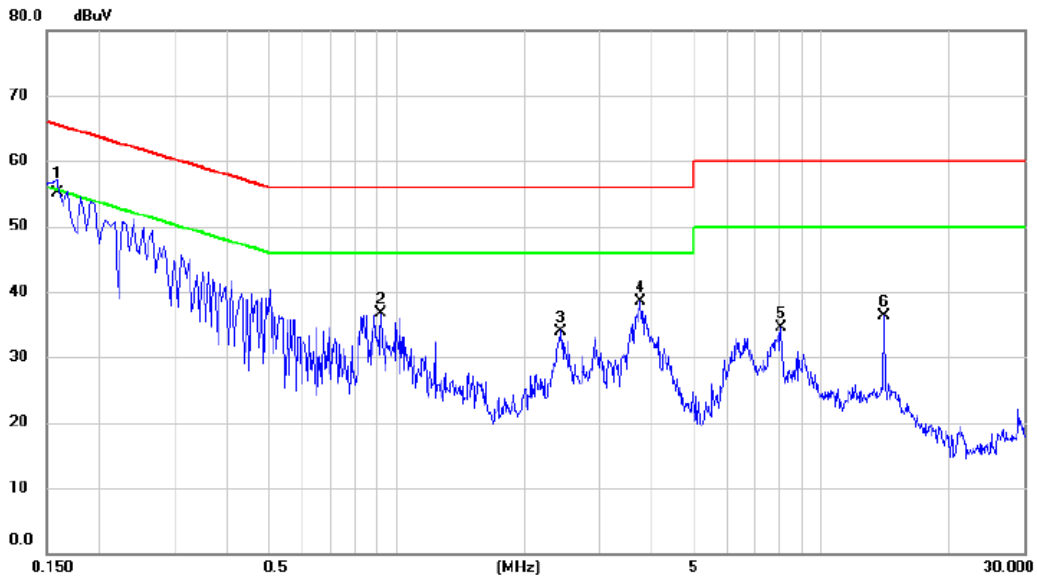

No.	Mk.	Freq. MHz	Reading Level dBuV	Correct Factor dB	Measure- ment dBuV	Limit dBuV	Margin dB	Detector	Comment
1	*	0.1590	45.41	9.60	55.01	65.52	-10.51	QP	
2		0.9193	26.99	9.72	36.71	56.00	-19.29	peak	
3		2.4270	24.02	9.98	34.00	56.00	-22.00	peak	
4		3.7410	28.55	10.02	38.57	56.00	-17.43	peak	
5		8.0520	24.38	10.15	34.53	60.00	-25.47	peak	
6		14.0010	26.14	10.11	36.25	60.00	-23.75	peak	

**REMARKS:**

- (1) Measurement Value = Reading Level + Correct Factor.
- (2) Margin Level = Measurement Value - Limit Value.

**APPENDIX B - RADIATED EMISSION - 9 KHZ TO 30 MHZ**

Test Mode: TX N20 MODE CHANNEL 06

Ant 0°

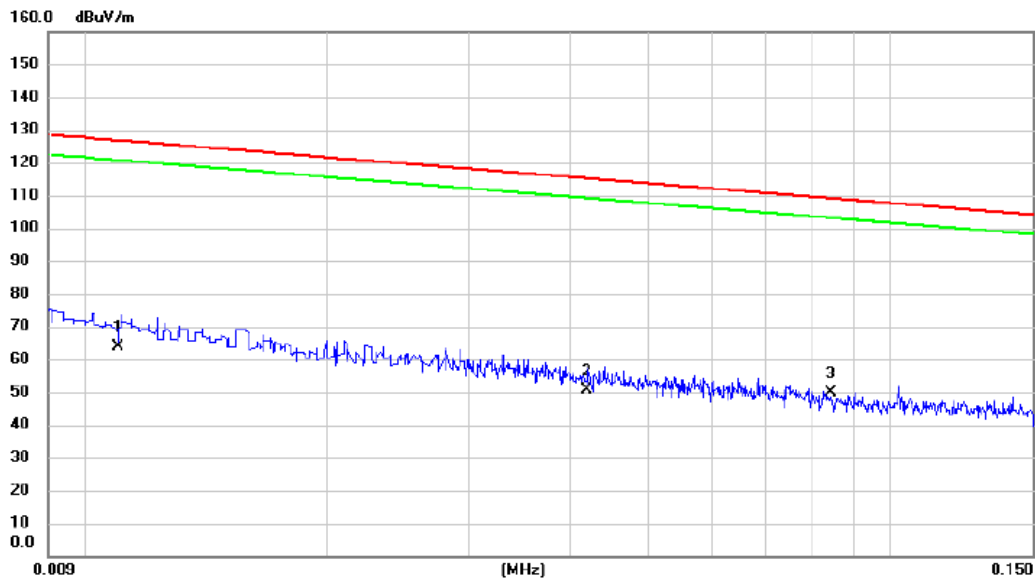

No.	Mk.	Freq. MHz	Reading Level dBuV	Correct Factor dB	Measure- ment dBuV/m	Limit dBuV/m	Margin dB	Detector	Comment
1		0.0110	-14.11	77.79	63.68	126.78	-63.10	AVG	
2		0.0420	-15.45	66.20	50.75	115.14	-64.39	AVG	
3	*	0.0842	-10.10	59.72	49.62	109.10	-59.48	QP	

REMARKS:

- (1) Measurement Value = Reading Level + Correct Factor.
- (2) Margin Level = Measurement Value - Limit Value.

Test Mode: TX N20 MODE CHANNEL 06

Ant 0°

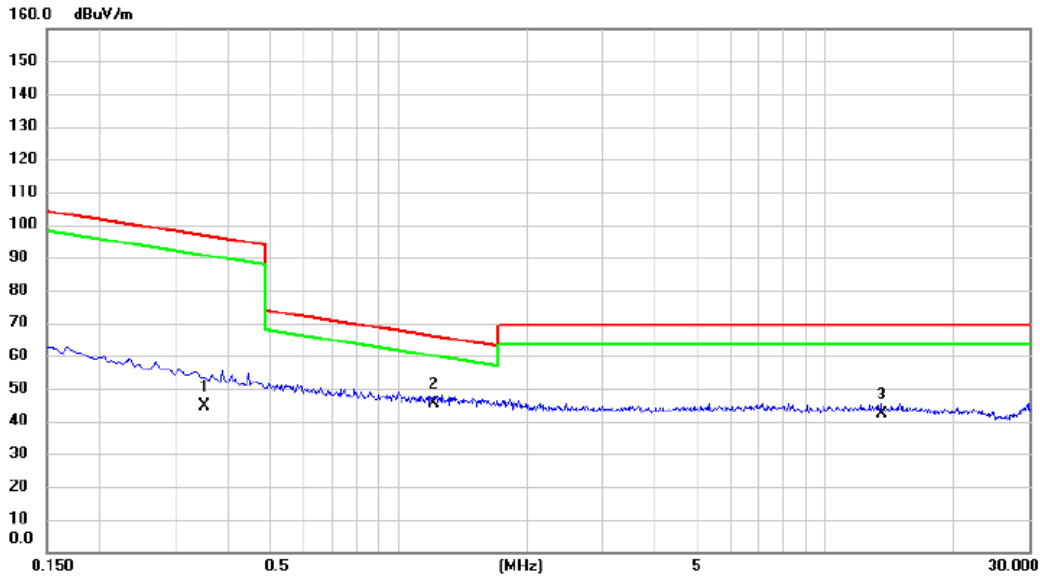

No. Mk.	Freq. MHz	Reading Level dBuV	Correct Factor dB	Measurement dBuV/m	Limit dBuV/m	Margin dB	Detector	Comment
1	0.3505	-3.04	47.59	44.55	96.71	-52.16	AVG	
2 *	1.2090	4.53	40.70	45.23	65.96	-20.73	QP	
3	13.5464	4.18	38.17	42.35	69.54	-27.19	QP	

REMARKS:

- (1) Measurement Value = Reading Level + Correct Factor.
- (2) Margin Level = Measurement Value - Limit Value.

Test Mode: TX N20 MODE CHANNEL 06

### Ant 90°

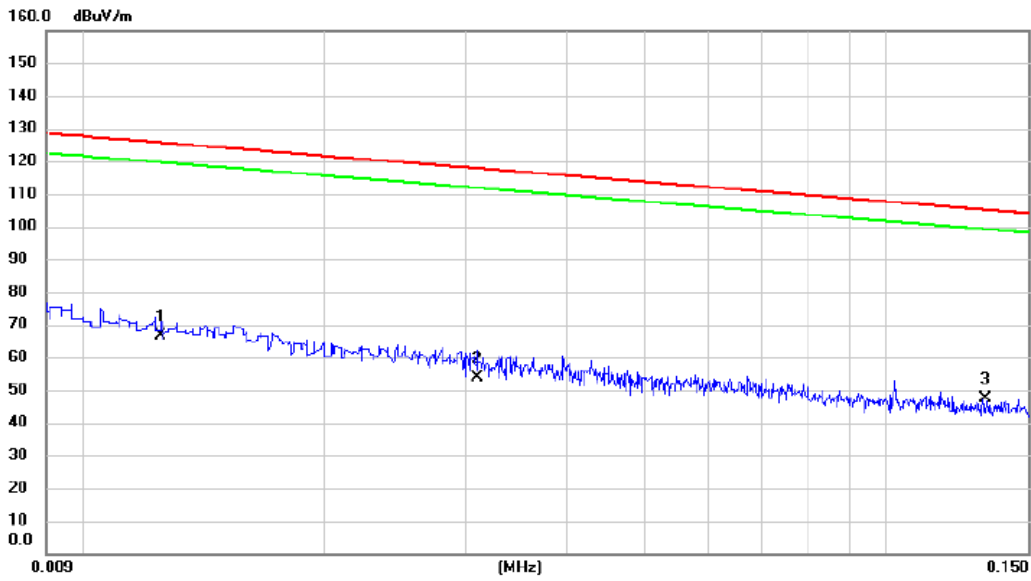

No.	Mk.	Freq. MHz	Reading Level dBuV	Correct Factor dB	Measure- ment dBuV/m	Limit dBuV/m	Margin dB	Detector	Comment
1		0.0125	-10.24	76.88	66.64	125.67	-59.03	AVG	
2		0.0310	-15.60	69.40	53.80	117.78	-63.98	AVG	
3	*	0.1326	-8.87	56.08	47.21	105.16	-57.95	QP	

**REMARKS:**

- (1) Measurement Value = Reading Level + Correct Factor.
- (2) Margin Level = Measurement Value - Limit Value.

Test Mode: TX N20 MODE CHANNEL 06

### Ant 90°

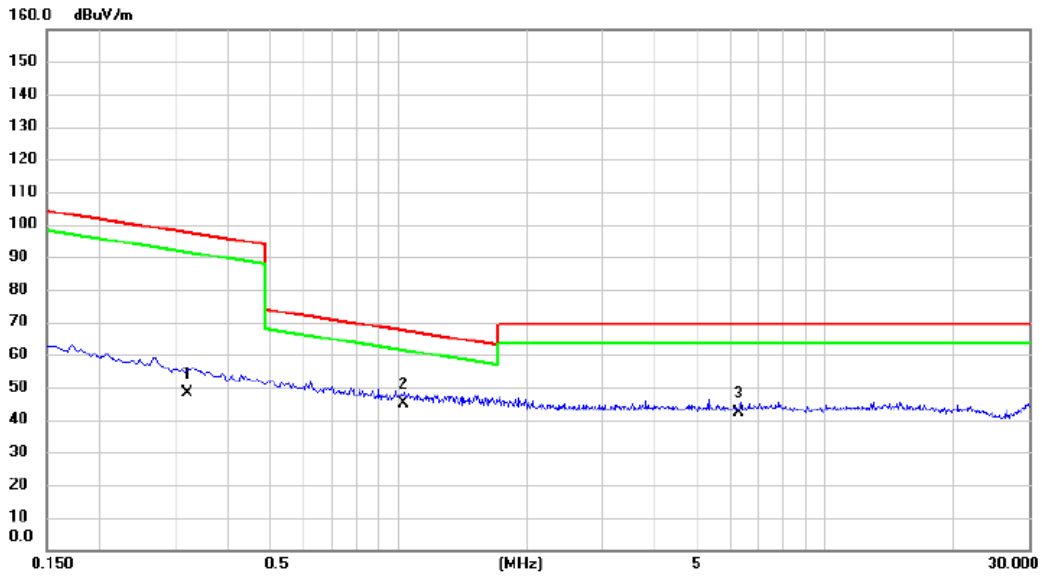

No.	Mk.	Freq. MHz	Reading Level dBuV	Correct Factor dB	Measure- ment dBuV/m	Limit dBuV/m	Margin dB	Detector	Comment
1		0.3200	-0.04	48.26	48.22	97.50	-49.28	AVG	
2	*	1.0294	3.71	41.13	44.84	67.35	-22.51	QP	
3		6.2600	4.33	37.80	42.13	69.54	-27.41	QP	

**REMARKS:**

- (1) Measurement Value = Reading Level + Correct Factor.
- (2) Margin Level = Measurement Value - Limit Value.

**APPENDIX C - RADIATED EMISSION - 30 MHZ TO 1000 MHZ**

Test Mode: TX N20 MODE CHANNEL 06

### Vertical

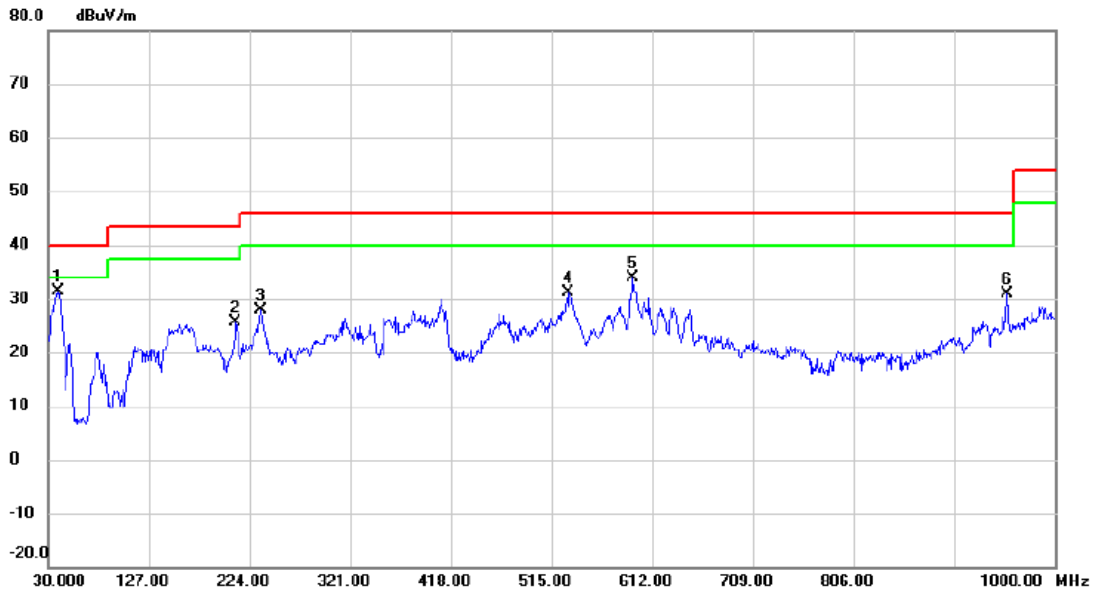

No.	Mk.	Freq. MHz	Reading Level dBuV	Correct Factor dB	Measure- ment dBuV/m	Limit dBuV/m	Margin dB	Detector	Comment
1	*	40.1850	47.59	-16.20	31.39	40.00	-8.61	peak	
2		210.9050	43.97	-18.28	25.69	43.50	-17.81	peak	
3		235.1550	45.00	-17.12	27.88	46.00	-18.12	peak	
4		531.4900	43.00	-11.75	31.25	46.00	-14.75	peak	
5		593.5700	42.90	-8.98	33.92	46.00	-12.08	peak	
6		953.4400	36.06	-5.13	30.93	46.00	-15.07	peak	

**REMARKS:**

- (1) Measurement Value = Reading Level + Correct Factor.
- (2) Margin Level = Measurement Value - Limit Value.



Test Mode: TX N20 MODE CHANNEL 06

### Horizontal

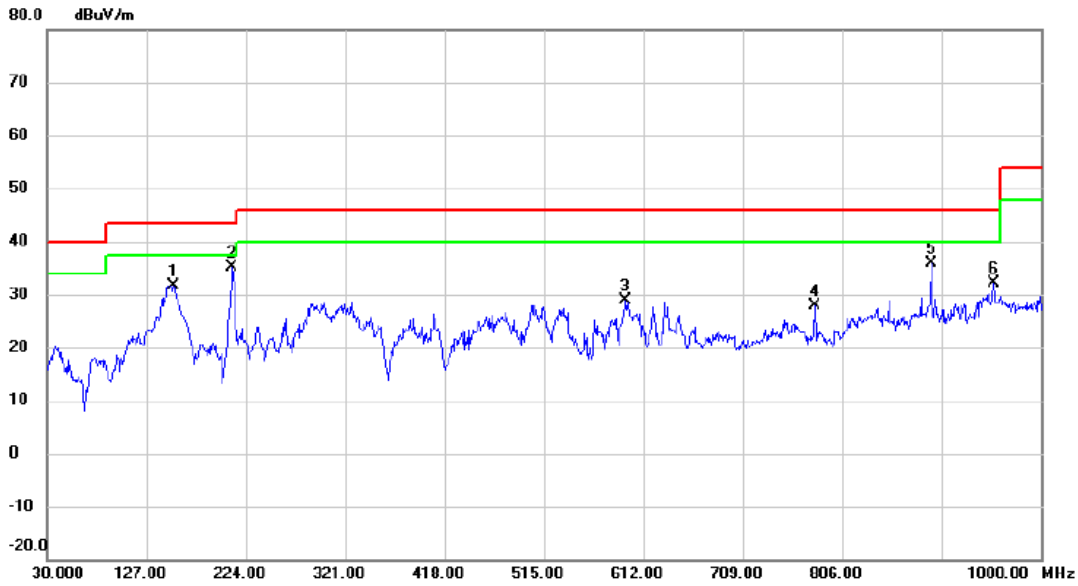

No.	Mk.	Freq. MHz	Reading Level dBuV	Correct Factor dB	Measure- ment dBuV/m	Limit dBuV/m	Margin dB	Detector	Comment
1		153.6750	46.61	-14.99	31.62	43.50	-11.88	peak	
2	*	210.9050	53.45	-18.28	35.17	43.50	-8.33	peak	
3		594.5400	37.82	-8.93	28.89	46.00	-17.11	peak	
4		779.3250	34.47	-6.55	27.92	46.00	-18.08	peak	
5		893.3000	41.30	-5.49	35.81	46.00	-10.19	peak	
6		953.4400	37.26	-5.13	32.13	46.00	-13.87	peak	

**REMARKS:**

- (1) Measurement Value = Reading Level + Correct Factor.
- (2) Margin Level = Measurement Value - Limit Value.

Test Mode: TX-CO-LOCATION 2437 N20 & 5755 ax 40

### Vertical

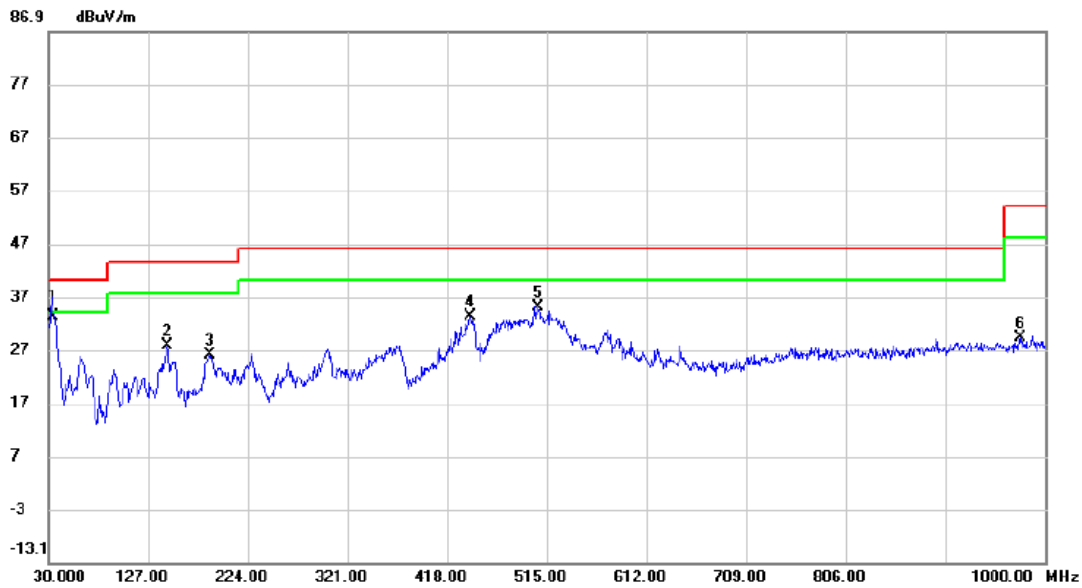

No.	Mk.	Freq. MHz	Reading Level dBuV	Correct Factor dB	Measure- ment dBuV/m	Limit dBuV/m	Margin dB	Detector	Comment
1	*	33.8800	50.45	-17.28	33.17	40.00	-6.83	QP	
2		145.4300	42.90	-15.21	27.69	43.50	-15.81	peak	
3		187.1400	43.94	-18.00	25.94	43.50	-17.56	peak	
4		440.3100	46.17	-12.91	33.26	46.00	-12.74	peak	
5		506.2700	47.52	-12.46	35.06	46.00	-10.94	peak	
6		975.7500	34.19	-5.01	29.18	54.00	-24.82	peak	

**REMARKS:**

- (1) Measurement Value = Reading Level + Correct Factor.
- (2) Margin Level = Measurement Value - Limit Value.

Test Mode: TX-CO-LOCATION 2437 N20 & 5755 ax 40

### Horizontal



No.	Mk.	Freq. MHz	Reading Level dBuV	Correct Factor dB	Measure- ment dBuV/m	Limit dBuV/m	Margin dB	Detector	Comment
1		144.9450	46.75	-15.24	31.51	43.50	-11.99	peak	
2		300.6300	49.79	-14.31	35.48	46.00	-10.52	peak	
3		372.4100	49.61	-13.83	35.78	46.00	-10.22	peak	
4		441.7650	51.43	-12.92	38.51	46.00	-7.49	peak	
5	*	483.9600	52.20	-12.79	39.41	46.00	-6.59	peak	
6		987.8750	35.96	-4.94	31.02	54.00	-22.98	peak	

**REMARKS:**

- (1) Measurement Value = Reading Level + Correct Factor.
- (2) Margin Level = Measurement Value - Limit Value.

**APPENDIX D - RADIATED EMISSION- ABOVE 1000 MHZ**

Test Mode: TX B Mode 2412 MHz

### Vertical

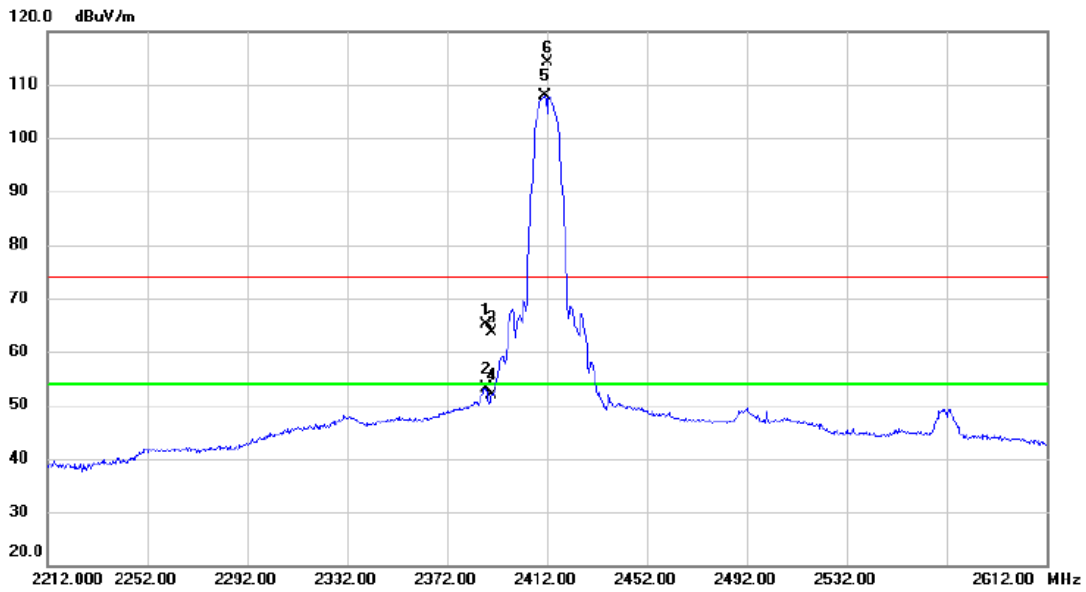

No.	Mk.	Freq. MHz	Reading Level dBuV	Correct Factor dB	Measure- ment dBuV/m	Limit dBuV/m	Margin dB	Detector	Comment
1		2387.600	32.62	32.39	65.01	74.00	-8.99	peak	
2		2387.600	20.73	32.39	53.12	54.00	-0.88	AVG	
3		2390.000	31.24	32.39	63.63	74.00	-10.37	peak	
4		2390.000	19.54	32.39	51.93	54.00	-2.07	AVG	
5	*	2411.200	75.47	32.46	107.93	54.00	53.93	AVG	No limit
6	X	2412.300	81.66	32.46	114.12	74.00	40.12	peak	No limit

**REMARKS:**

- (1) Measurement Value = Reading Level + Correct Factor.
- (2) Margin Level = Measurement Value - Limit Value.

Test Mode: TX B Mode 2412 MHz

### Vertical

80 dBuV/m

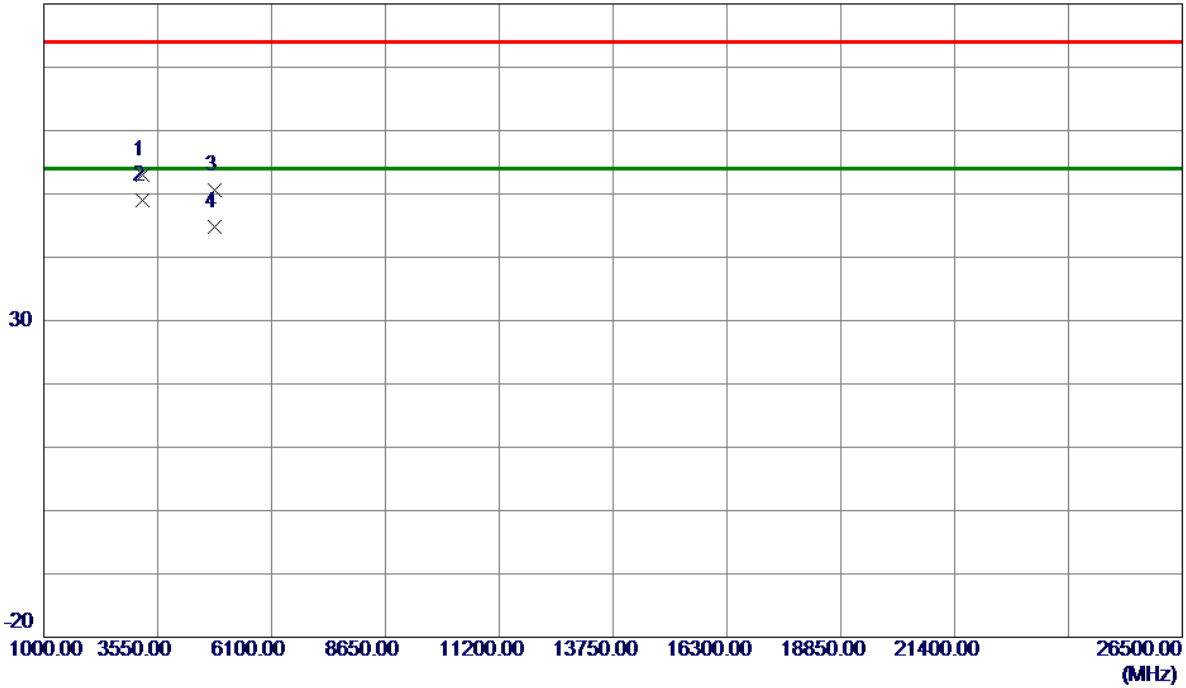

No.	Freq. MHz	Reading Level dBuV/m	Correct Factor dB	Measure ment dBuV/m	Limit dBuV/m	Margin dB	Detector	Comment
1	3215.9200	67.17	-14.26	52.91	74.00	-21.09	Peak	
2 *	3215.9500	63.20	-14.26	48.94	54.00	-5.06	AVG	
3	4823.8200	60.32	-9.69	50.63	74.00	-23.37	Peak	
4	4824.0000	54.42	-9.69	44.73	54.00	-9.27	AVG	

**REMARKS:**

- (1) Measurement Value = Reading Level + Correct Factor.
- (2) Margin Level = Measurement Value - Limit Value.

Test Mode: TX B Mode 2412 MHz

### Horizontal

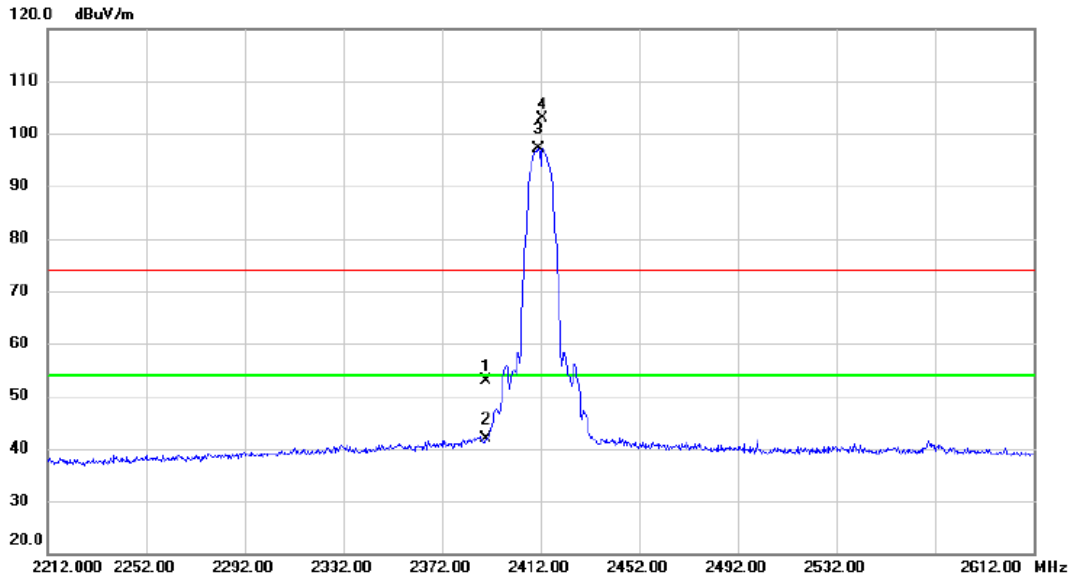

No. Mk.	Freq. MHz	Reading Level dBuV	Correct Factor dB	Measure- ment dBuV/m	Limit dBuV/m	Margin dB	Detector	Comment
1	2390.000	20.60	32.39	52.99	74.00	-21.01	peak	
2	2390.000	9.50	32.39	41.89	54.00	-12.11	AVG	
3 *	2411.200	64.63	32.46	97.09	54.00	43.09	AVG	No limit
4 X	2412.600	70.31	32.46	102.77	74.00	28.77	peak	No limit

**REMARKS:**

- (1) Measurement Value = Reading Level + Correct Factor.
- (2) Margin Level = Measurement Value - Limit Value.

Test Mode: TX B Mode 2412 MHz

### Horizontal

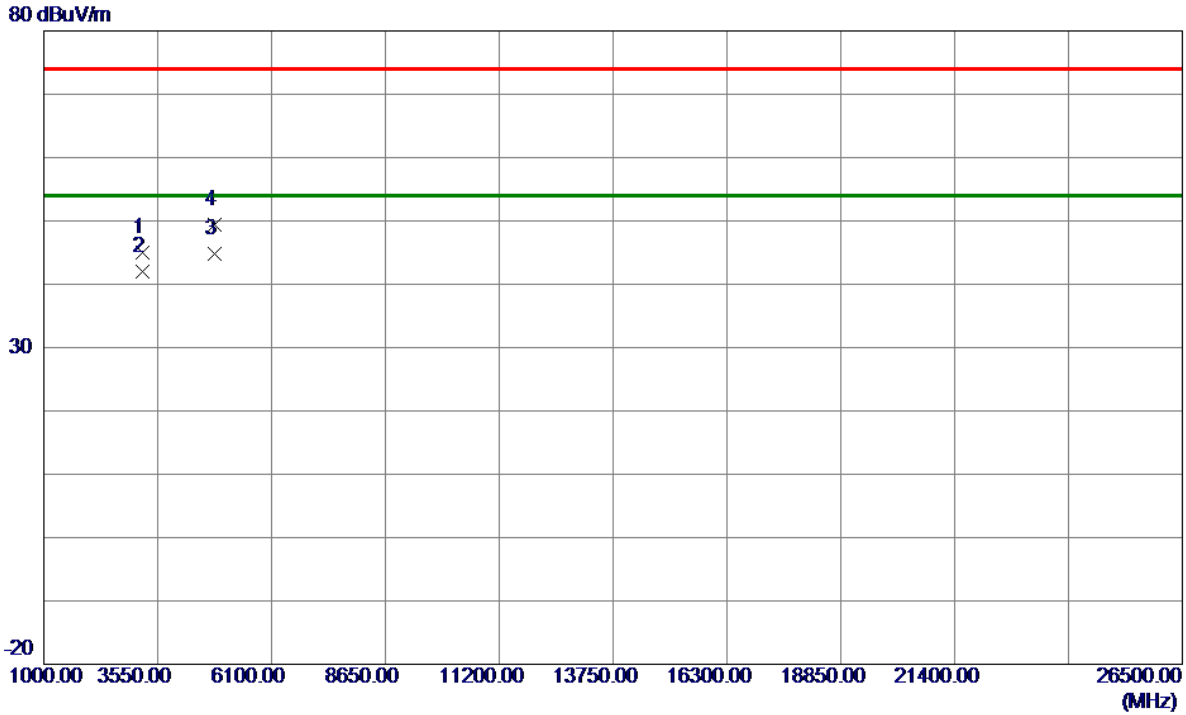

No.	Freq. MHz	Reading Level dBuV/m	Correct Factor dB	Measure ment dBuV/m	Limit dBuV/m	Margin dB	Detector	Comment
1	3215.7350	59.18	-14.26	44.92	74.00	-29.08	Peak	
2	3215.9550	56.30	-14.26	42.04	54.00	-11.96	AVG	
3 *	4824.0000	54.55	-9.69	44.86	54.00	-9.14	AVG	
4	4824.1400	59.17	-9.69	49.48	74.00	-24.52	Peak	

**REMARKS:**

- (1) Measurement Value = Reading Level + Correct Factor.
- (2) Margin Level = Measurement Value - Limit Value.



Test Mode: TX B Mode 2437 MHz

### Vertical

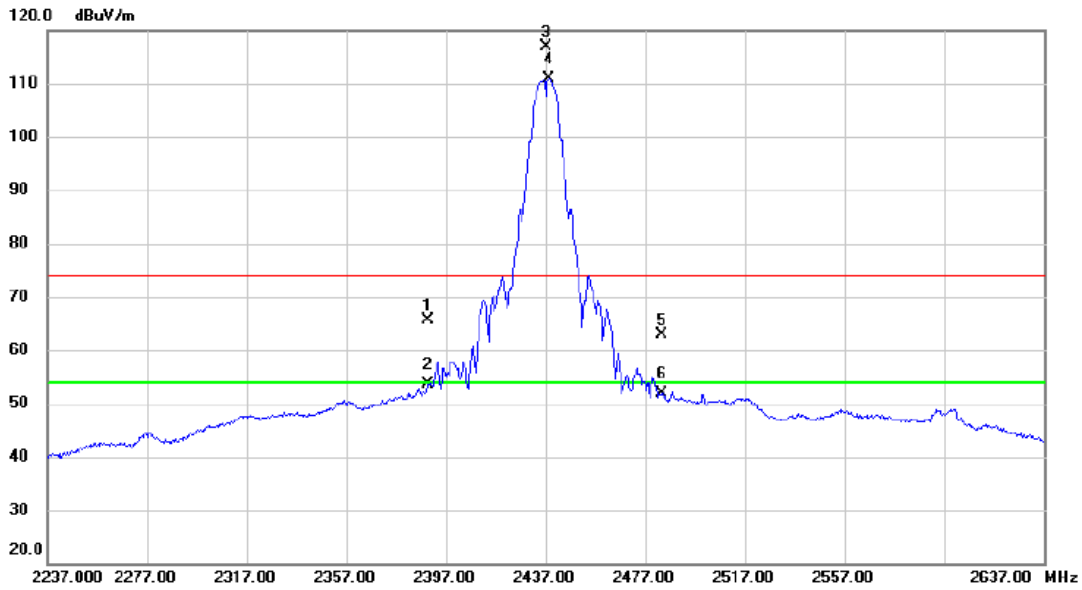

No.	Mk.	Freq. MHz	Reading Level dBuV	Correct Factor dB	Measure- ment dBuV/m	Limit dBuV/m	Margin dB	Detector	Comment
1		2390.000	33.26	32.39	65.65	74.00	-8.35	peak	
2		2390.000	21.26	32.39	53.65	54.00	-0.35	AVG	
3	X	2437.500	84.41	32.53	116.94	74.00	42.94	peak	No limit
4	*	2438.600	78.41	32.53	110.94	54.00	56.94	AVG	No limit
5		2483.500	30.24	32.66	62.90	74.00	-11.10	peak	
6		2483.500	19.24	32.66	51.90	54.00	-2.10	AVG	

**REMARKS:**

- (1) Measurement Value = Reading Level + Correct Factor.
- (2) Margin Level = Measurement Value - Limit Value.

Test Mode: TX B Mode 2437 MHz

### Vertical

80 dBuV/m

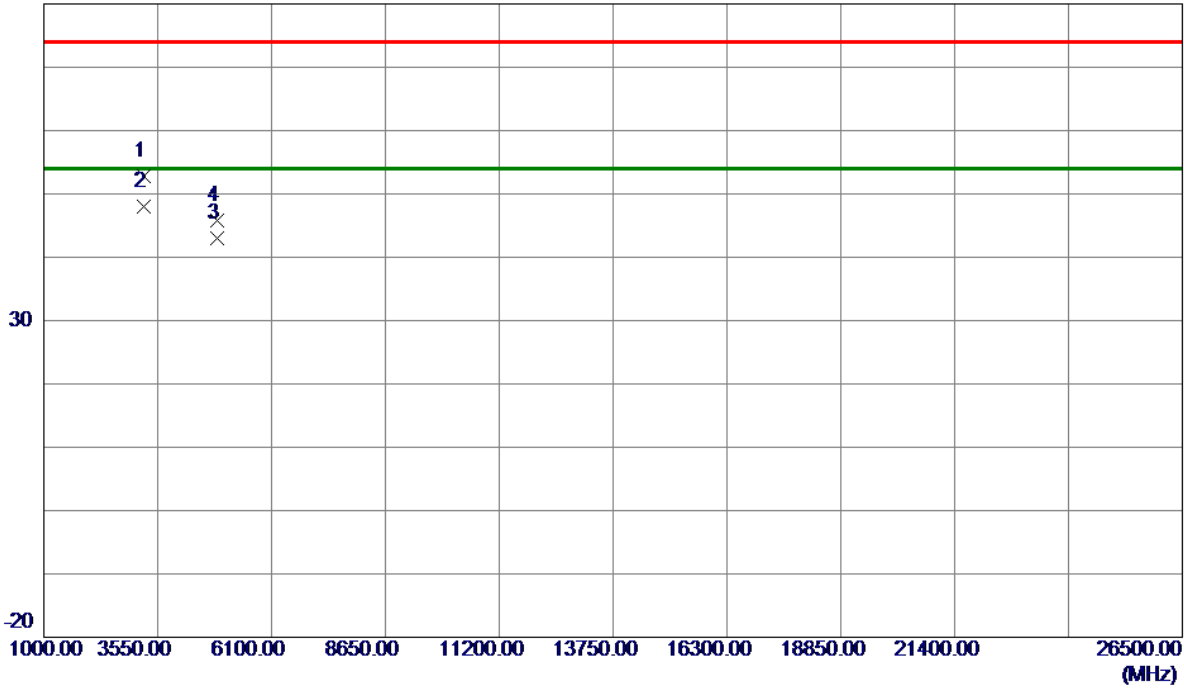

No.	Freq. MHz	Reading Level dBuV/m	Correct Factor dB	Measure ment dBuV/m	Limit dBuV/m	Margin dB	Detector	Comment
1	3249.0730	66.94	-14.22	52.72	74.00	-21.28	Peak	
2 *	3249.3030	62.30	-14.22	48.08	54.00	-5.92	AVG	
3	4873.9400	52.45	-9.50	42.95	54.00	-11.05	AVG	
4	4874.0600	55.28	-9.50	45.78	74.00	-28.22	Peak	

**REMARKS:**

- (1) Measurement Value = Reading Level + Correct Factor.
- (2) Margin Level = Measurement Value - Limit Value.

Test Mode:	TX B Mode 2437 MHz
------------	--------------------

### Horizontal

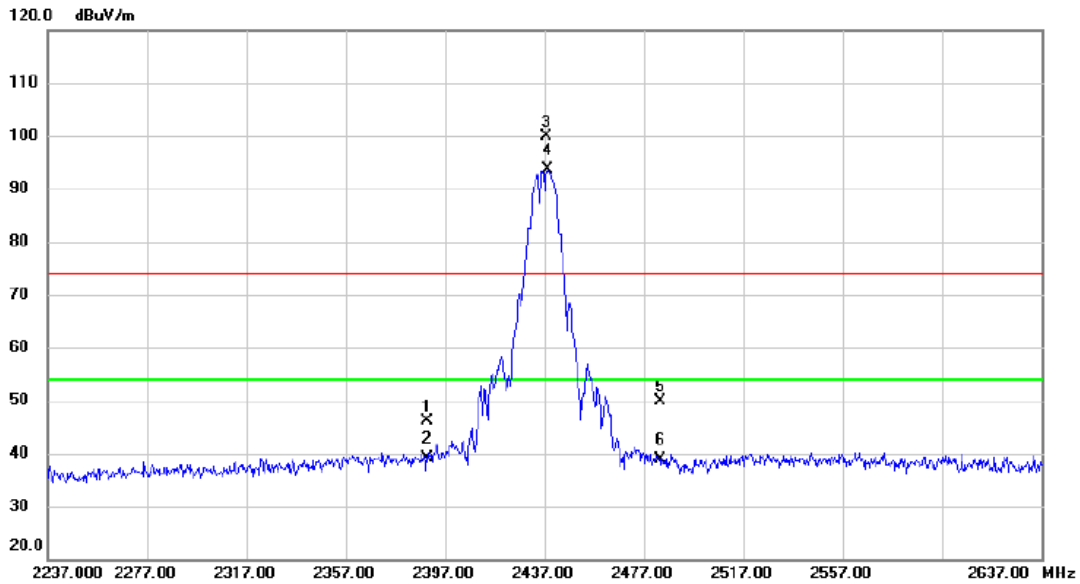

No.	Mk.	Freq. MHz	Reading Level dBuV	Correct Factor dB	Measure- ment dBuV/m	Limit dBuV/m	Margin dB	Detector	Comment
1		2390.000	13.76	32.39	46.15	74.00	-27.85	peak	
2		2390.000	6.74	32.39	39.13	54.00	-14.87	AVG	
3	X	2437.900	67.32	32.53	99.85	74.00	25.85	peak	No limit
4	*	2438.600	61.00	32.53	93.53	54.00	39.53	AVG	No limit
5		2483.500	17.28	32.66	49.94	74.00	-24.06	peak	
6		2483.500	6.31	32.66	38.97	54.00	-15.03	AVG	

**REMARKS:**

- (1) Measurement Value = Reading Level + Correct Factor.
- (2) Margin Level = Measurement Value - Limit Value.

Test Mode: TX B Mode 2437 MHz

### Horizontal

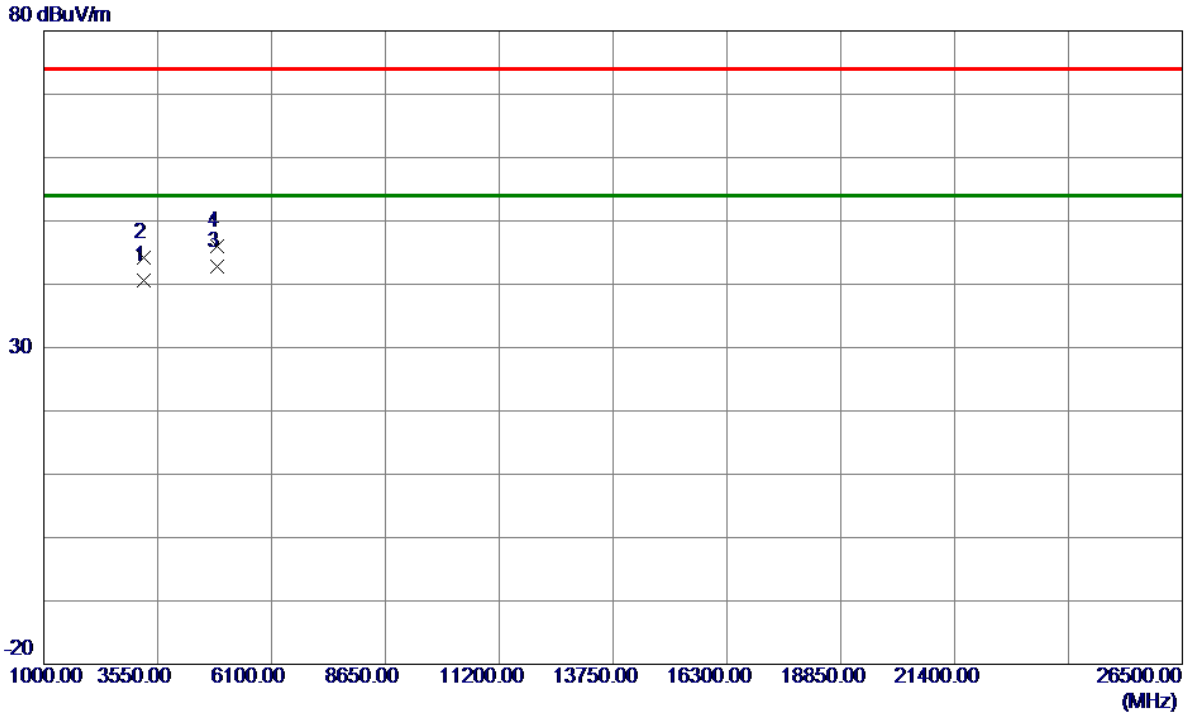

No.	Freq. MHz	Reading Level dBuV/m	Correct Factor dB	Measure ment dBuV/m	Limit dBuV/m	Margin dB	Detector	Comment
1	3249.3230	54.75	-14.22	40.53	54.00	-13.47	AVG	
2	3249.7330	58.35	-14.22	44.13	74.00	-29.87	Peak	
3 *	4873.9200	52.28	-9.50	42.78	54.00	-11.22	AVG	
4	4874.0600	55.56	-9.50	46.06	74.00	-27.94	Peak	

**REMARKS:**

- (1) Measurement Value = Reading Level + Correct Factor.
- (2) Margin Level = Measurement Value - Limit Value.

Test Mode: TX B Mode 2462 MHz

### Vertical

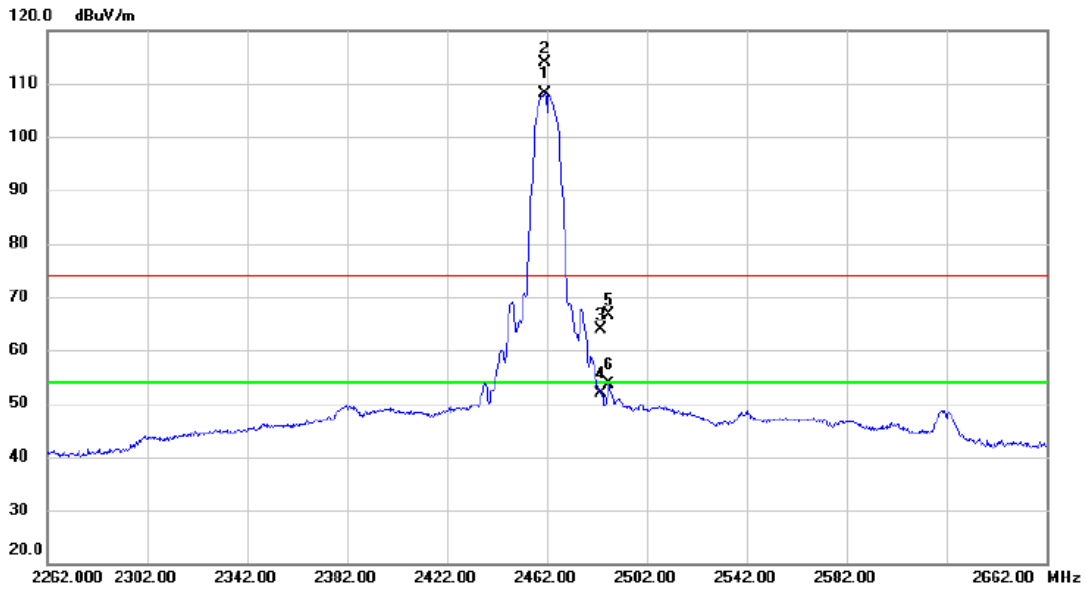

No.	Mk.	Freq. MHz	Reading Level dBuV	Correct Factor dB	Measure- ment dBuV/m	Limit dBuV/m	Margin dB	Detector	Comment
1	*	2461.200	75.45	32.60	108.05	54.00	54.05	AVG	No limit
2	X	2461.400	81.25	32.60	113.85	74.00	39.85	peak	No limit
3		2483.500	31.19	32.66	63.85	74.00	-10.15	peak	
4		2483.500	19.14	32.66	51.80	54.00	-2.20	AVG	
5		2486.800	33.91	32.67	66.58	74.00	-7.42	peak	
6		2486.800	20.91	32.67	53.58	54.00	-0.42	AVG	

**REMARKS:**

- (1) Measurement Value = Reading Level + Correct Factor.
- (2) Margin Level = Measurement Value - Limit Value.

Test Mode: TX B Mode 2462 MHz

### Vertical

80 dBuV/m

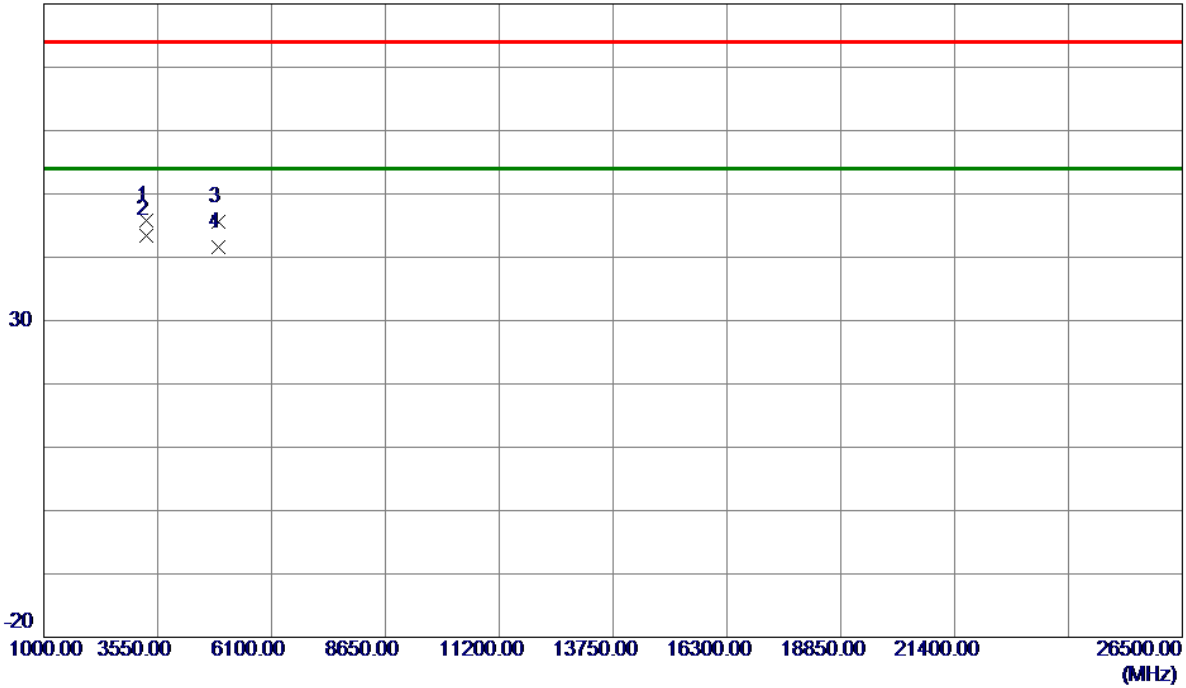

No.	Freq. MHz	Reading Level dBuV/m	Correct Factor dB	Measure ment dBuV/m	Limit dBuV/m	Margin dB	Detector	Comment
1	3282.6500	59.95	-14.19	45.76	74.00	-28.24	Peak	
2 *	3282.6550	57.69	-14.19	43.50	54.00	-10.50	AVG	
3	4923.8800	54.84	-9.31	45.53	74.00	-28.47	Peak	
4	4923.9600	50.91	-9.31	41.60	54.00	-12.40	AVG	

**REMARKS:**

- (1) Measurement Value = Reading Level + Correct Factor.
- (2) Margin Level = Measurement Value - Limit Value.

Test Mode: TX B Mode 2462 MHz

### Horizontal

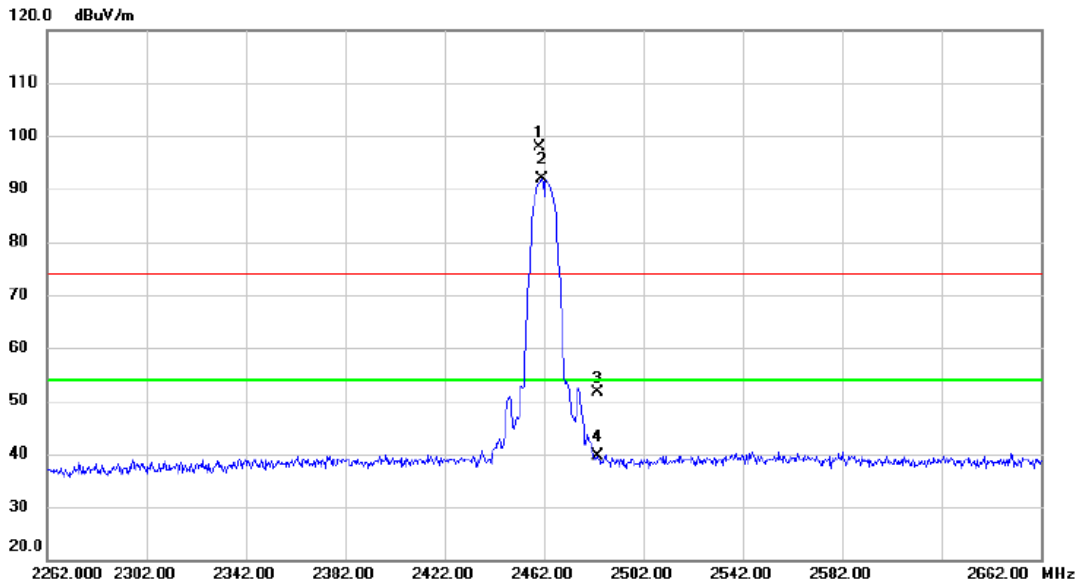

No.	Mk.	Freq. MHz	Reading Level dBuV	Correct Factor dB	Measure- ment dBuV/m	Limit dBuV/m	Margin dB	Detector	Comment
1	X	2460.300	65.38	32.60	97.98	74.00	23.98	peak	No limit
2	*	2461.200	59.21	32.60	91.81	54.00	37.81	AVG	No limit
3		2483.500	18.96	32.66	51.62	74.00	-22.38	peak	
4		2483.500	6.96	32.66	39.62	54.00	-14.38	AVG	

**REMARKS:**

(1) Measurement Value = Reading Level + Correct Factor.

(2) Margin Level = Measurement Value - Limit Value.

Test Mode: TX B Mode 2462 MHz

### Horizontal

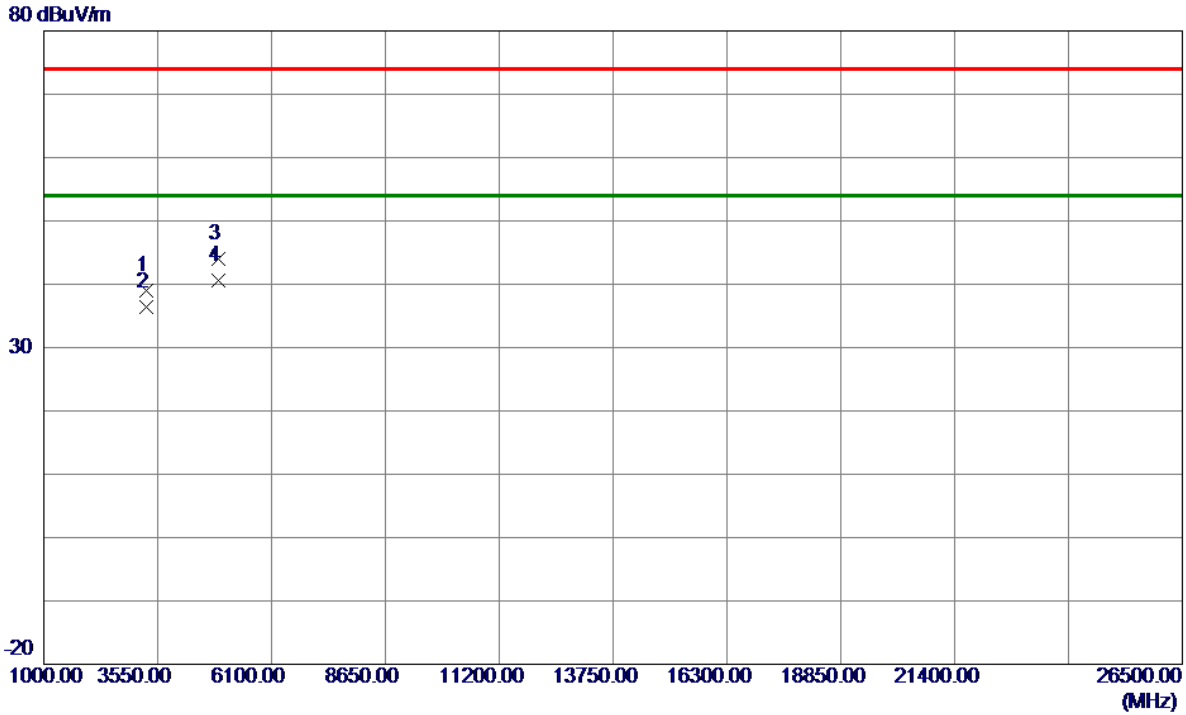

No.	Freq. MHz	Reading Level dBuV/m	Correct Factor dB	Measure ment dBuV/m	Limit dBuV/m	Margin dB	Detector	Comment
1	3282.5550	53.27	-14.19	39.08	74.00	-34.92	Peak	
2	3282.6350	50.55	-14.19	36.36	54.00	-17.64	AVG	
3	4922.6700	53.27	-9.31	43.96	74.00	-30.04	Peak	
4 *	4923.9800	49.99	-9.31	40.68	54.00	-13.32	AVG	

**REMARKS:**

- (1) Measurement Value = Reading Level + Correct Factor.
- (2) Margin Level = Measurement Value - Limit Value.



Test Mode: TX G Mode 2412 MHz

### Vertical

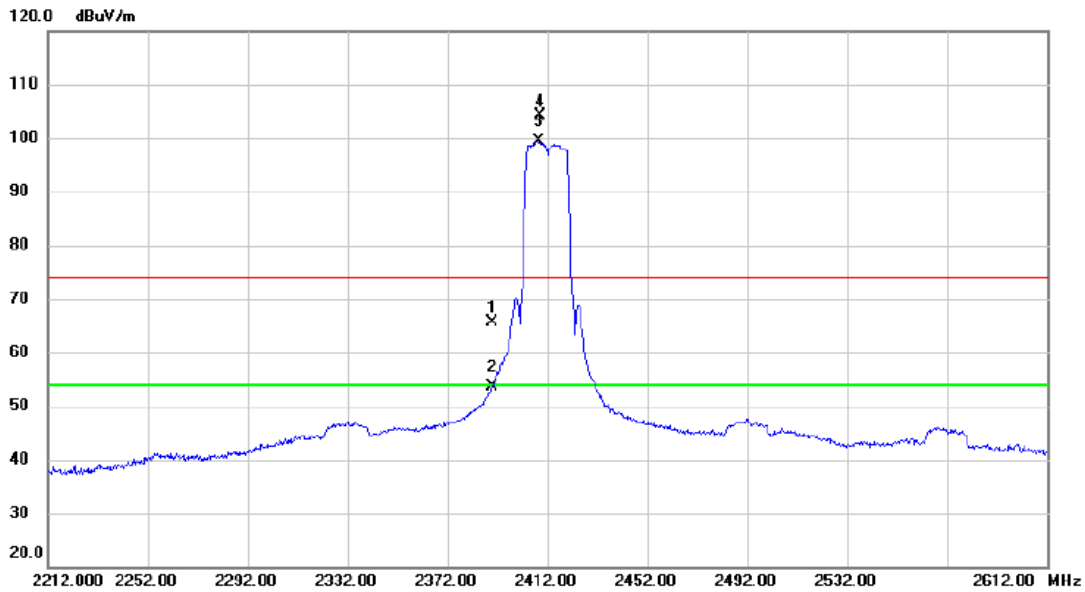

No.	Mk.	Freq. MHz	Reading Level dBuV	Correct Factor dB	Measure- ment dBuV/m	Limit dBuV/m	Margin dB	Detector	Comment
1		2390.000	33.24	32.39	65.63	74.00	-8.37	peak	
2		2390.000	21.36	32.39	53.75	54.00	-0.25	AVG	
3	*	2408.400	66.87	32.44	99.31	54.00	45.31	AVG	No limit
4	X	2409.200	71.63	32.44	104.07	74.00	30.07	peak	No limit

**REMARKS:**

- (1) Measurement Value = Reading Level + Correct Factor.
- (2) Margin Level = Measurement Value - Limit Value.

Test Mode: TX G Mode 2412 MHz

### Vertical

80 dBuV/m

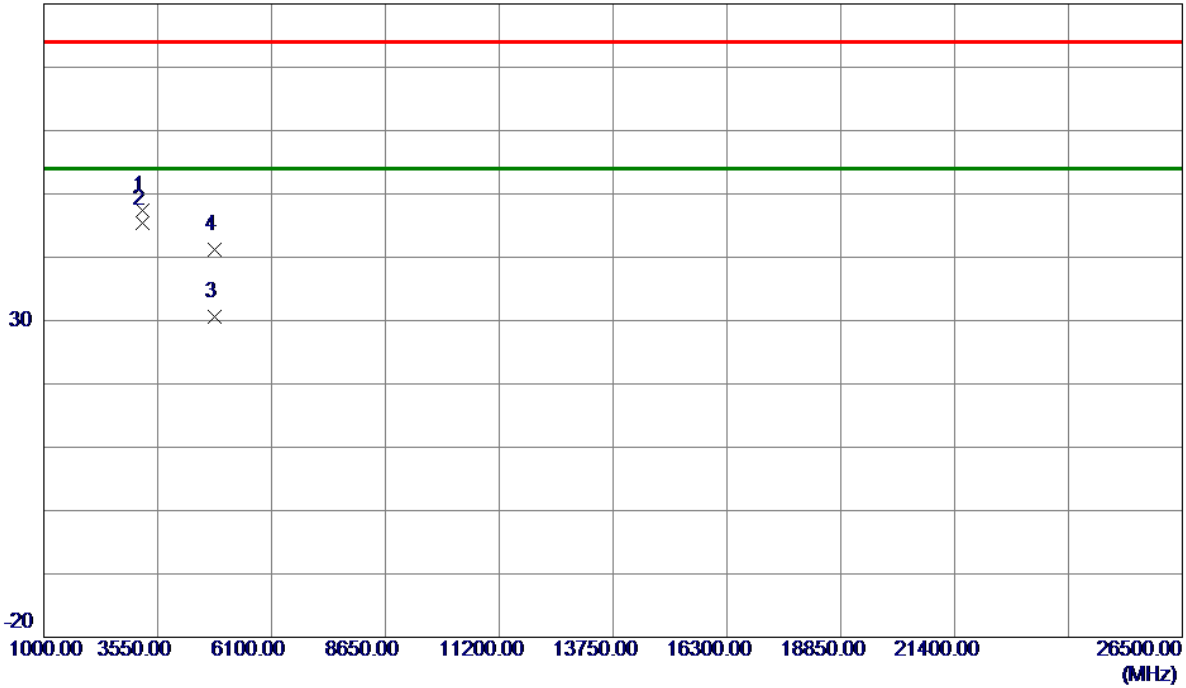

No.	Freq. MHz	Reading Level dBuV/m	Correct Factor dB	Measure ment dBuV/m	Limit dBuV/m	Margin dB	Detector	Comment
1	3215.9550	61.72	-14.26	47.46	74.00	-26.54	Peak	
2 *	3216.0000	59.56	-14.26	45.30	54.00	-8.70	AVG	
3	4823.7500	40.33	-9.69	30.64	54.00	-23.36	AVG	
4	4824.8500	50.95	-9.69	41.26	74.00	-32.74	Peak	

**REMARKS:**

- (1) Measurement Value = Reading Level + Correct Factor.
- (2) Margin Level = Measurement Value - Limit Value.

Test Mode: TX G Mode 2412 MHz

### Horizontal

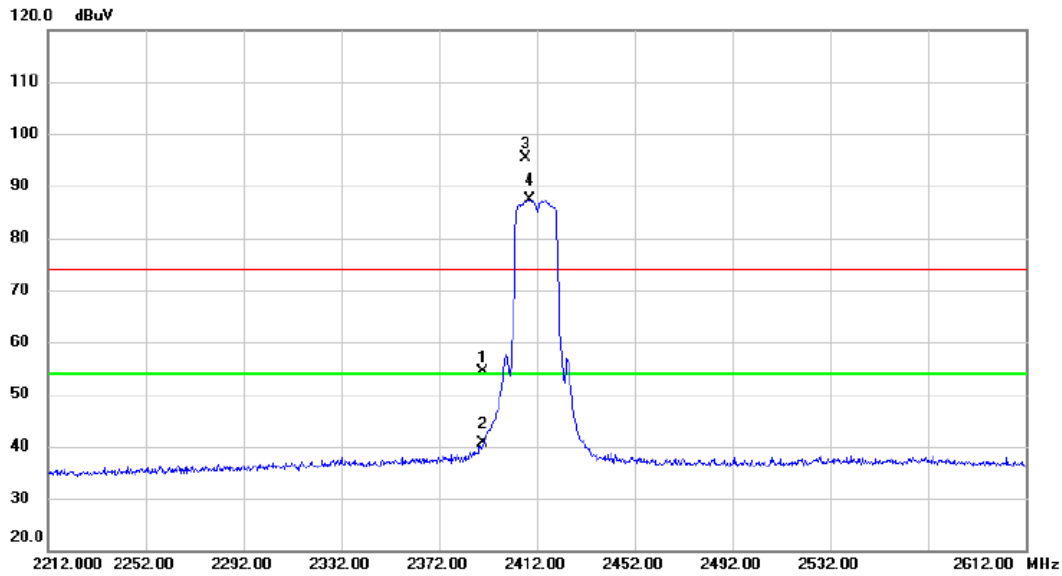

No. Mk.	Freq. MHz	Reading Level dBuV	Correct Factor dB	Measure- ment dBuV	Limit dBuV	Margin dB	Detector	Comment
1	2390.000	22.06	32.39	54.45	74.00	-19.55	peak	
2	2390.000	8.30	32.39	40.69	54.00	-13.31	AVG	
3 X	2407.600	62.83	32.44	95.27	74.00	21.27	peak	No limit
4 *	2408.800	54.86	32.44	87.30	54.00	33.30	AVG	No limit

**REMARKS:**

- (1) Measurement Value = Reading Level + Correct Factor.
- (2) Margin Level = Measurement Value - Limit Value.

Test Mode: TX G Mode 2412 MHz

### Horizontal

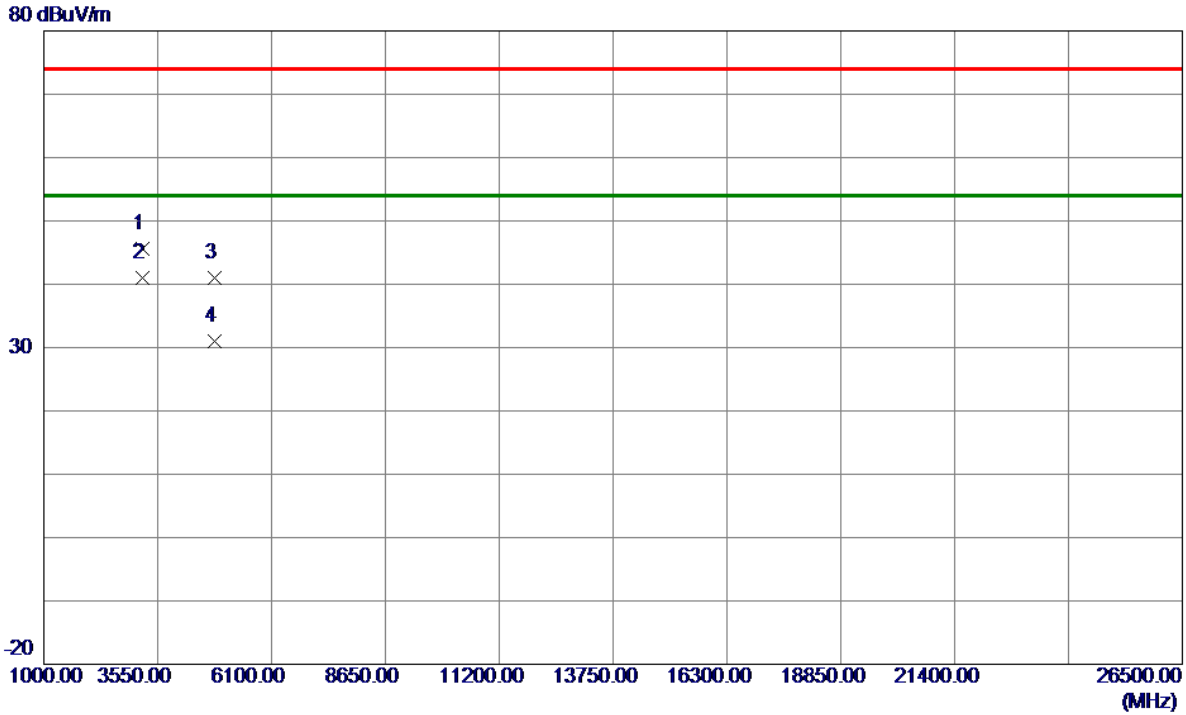

No.	Freq. MHz	Reading Level dBuV/m	Correct Factor dB	Measure ment dBuV/m	Limit dBuV/m	Margin dB	Detector	Comment
1	3208.9200	59.78	-14.26	45.52	74.00	-28.48	Peak	
2 *	3215.9800	55.18	-14.26	40.92	54.00	-13.08	AVG	
3	4819.0600	50.64	-9.71	40.93	74.00	-33.07	Peak	
4	4824.0000	40.69	-9.69	31.00	54.00	-23.00	AVG	

**REMARKS:**

- (1) Measurement Value = Reading Level + Correct Factor.
- (2) Margin Level = Measurement Value - Limit Value.

Test Mode: TX G Mode 2437 MHz

### Vertical

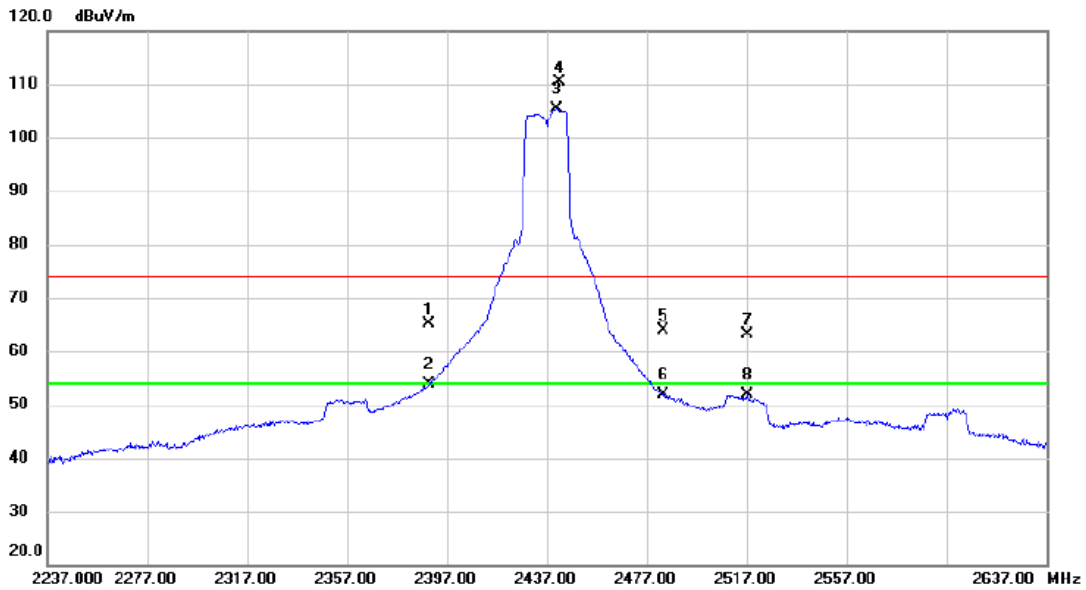

No.	Mk.	Freq. MHz	Reading Level dBuV	Correct Factor dB	Measure- ment dBuV/m	Limit dBuV/m	Margin dB	Detector	Comment
1		2390.000	32.62	32.39	65.01	74.00	-8.99	peak	
2		2390.000	21.41	32.39	53.80	54.00	-0.20	AVG	
3	*	2441.000	72.83	32.54	105.37	54.00	51.37	AVG	No limit
4	X	2441.860	77.82	32.55	110.37	74.00	36.37	peak	No limit
5		2483.500	31.33	32.66	63.99	74.00	-10.01	peak	
6		2483.500	19.12	32.66	51.78	54.00	-2.22	AVG	
7		2517.000	30.28	32.76	63.04	74.00	-10.96	peak	
8		2517.000	19.08	32.76	51.84	54.00	-2.16	AVG	

**REMARKS:**

- (1) Measurement Value = Reading Level + Correct Factor.
- (2) Margin Level = Measurement Value - Limit Value.

Test Mode: TX G Mode 2437 MHz

### Vertical

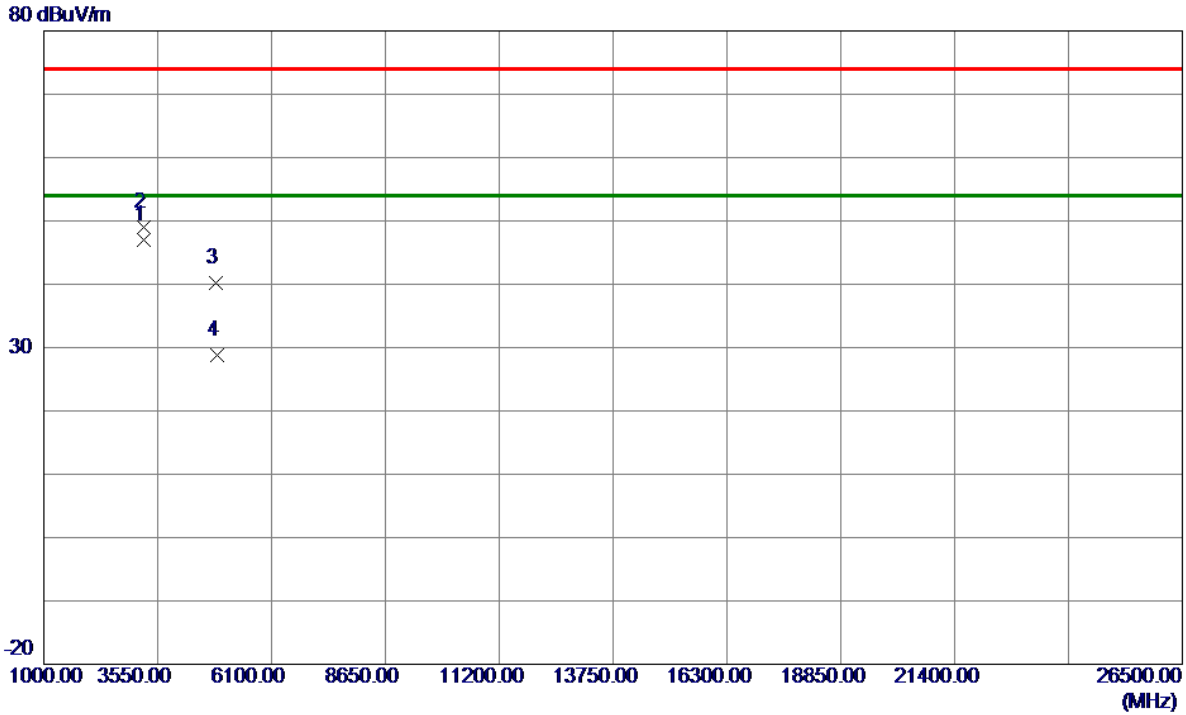

No.	Freq. MHz	Reading Level dBuV/m	Correct Factor dB	Measure ment dBuV/m	Limit dBuV/m	Margin dB	Detector	Comment
1 *	3249.3280	61.26	-14.22	47.04	54.00	-6.96	AVG	
2	3249.3330	63.14	-14.22	48.92	74.00	-25.08	Peak	
3	4865.8800	49.76	-9.53	40.23	74.00	-33.77	Peak	
4	4880.5000	38.24	-9.47	28.77	54.00	-25.23	AVG	

**REMARKS:**

- (1) Measurement Value = Reading Level + Correct Factor.
- (2) Margin Level = Measurement Value - Limit Value.

Test Mode: TX G Mode 2437 MHz

### Horizontal

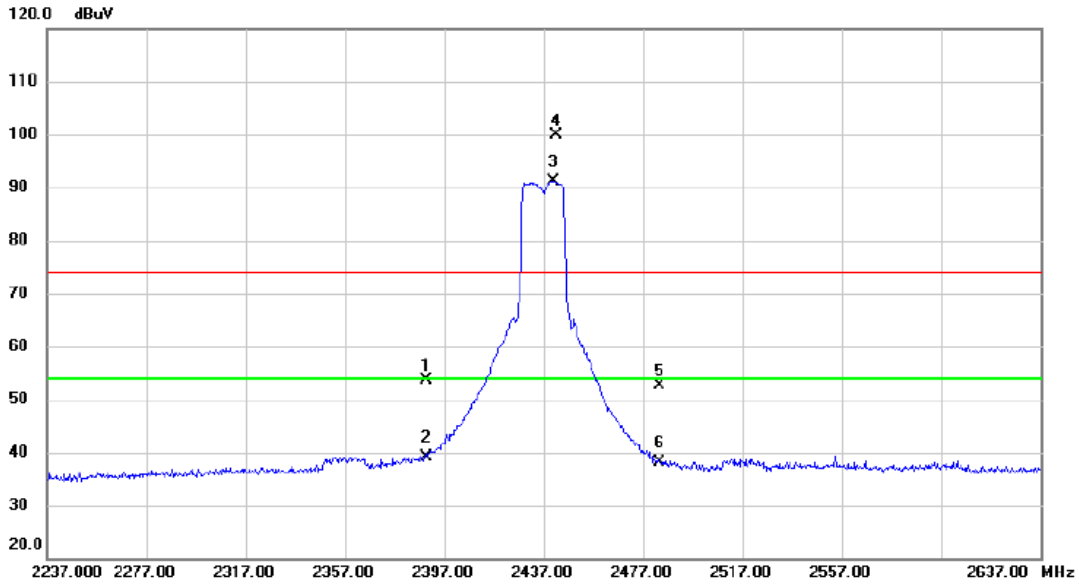

No.	Mk.	Freq. MHz	Reading Level dBuV	Correct Factor dB	Measure- ment dBuV	Limit dBuV	Margin dB	Detector	Comment
1		2390.000	21.16	32.39	53.55	74.00	-20.45	peak	
2		2390.000	6.72	32.39	39.11	54.00	-14.89	AVG	
3	*	2440.800	58.62	32.54	91.16	54.00	37.16	AVG	No limit
4	X	2442.000	67.22	32.55	99.77	74.00	25.77	peak	No limit
5		2483.500	19.98	32.66	52.64	74.00	-21.36	peak	
6		2483.500	5.36	32.66	38.02	54.00	-15.98	AVG	

**REMARKS:**

- (1) Measurement Value = Reading Level + Correct Factor.
- (2) Margin Level = Measurement Value - Limit Value.

Test Mode: TX G Mode 2437 MHz

### Horizontal

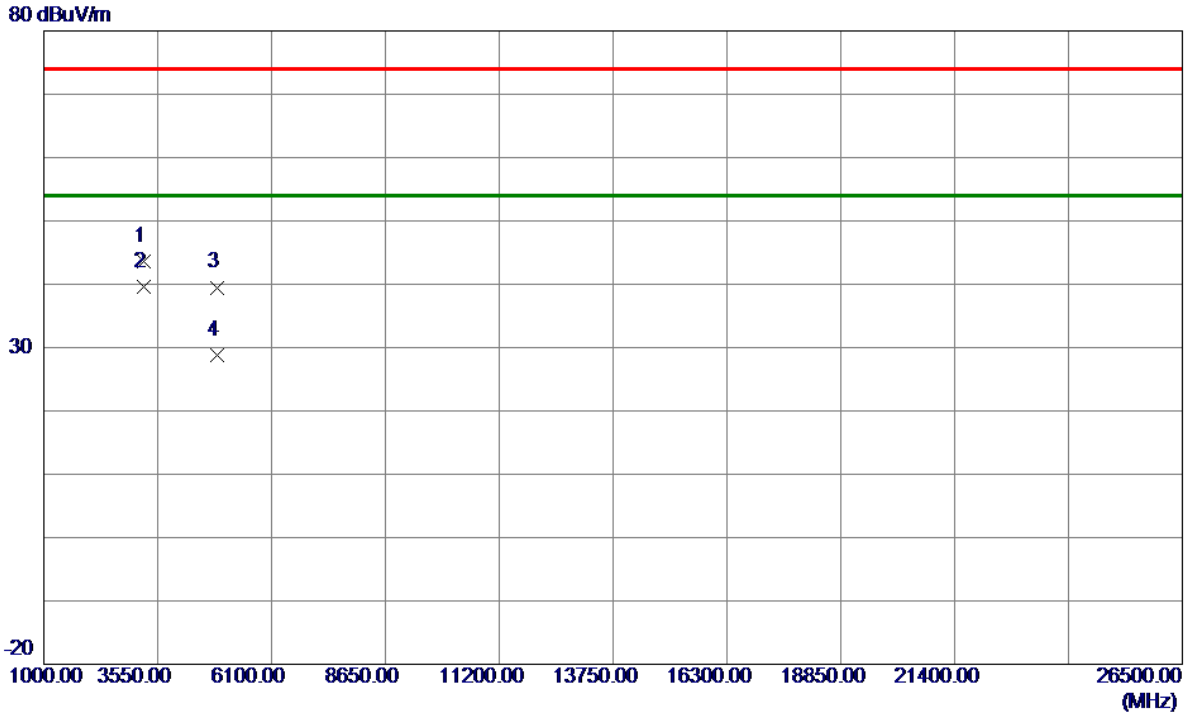

No.	Freq. MHz	Reading Level dBuV/m	Correct Factor dB	Measure ment dBuV/m	Limit dBuV/m	Margin dB	Detector	Comment
1	3249.1730	57.79	-14.22	43.57	74.00	-30.43	Peak	
2 *	3249.3530	53.89	-14.22	39.67	54.00	-14.33	AVG	
3	4871.1400	49.01	-9.51	39.50	74.00	-34.50	Peak	
4	4874.7000	38.24	-9.50	28.74	54.00	-25.26	AVG	

**REMARKS:**

- (1) Measurement Value = Reading Level + Correct Factor.
- (2) Margin Level = Measurement Value - Limit Value.



Test Mode: TX G Mode 2462 MHz

### Vertical

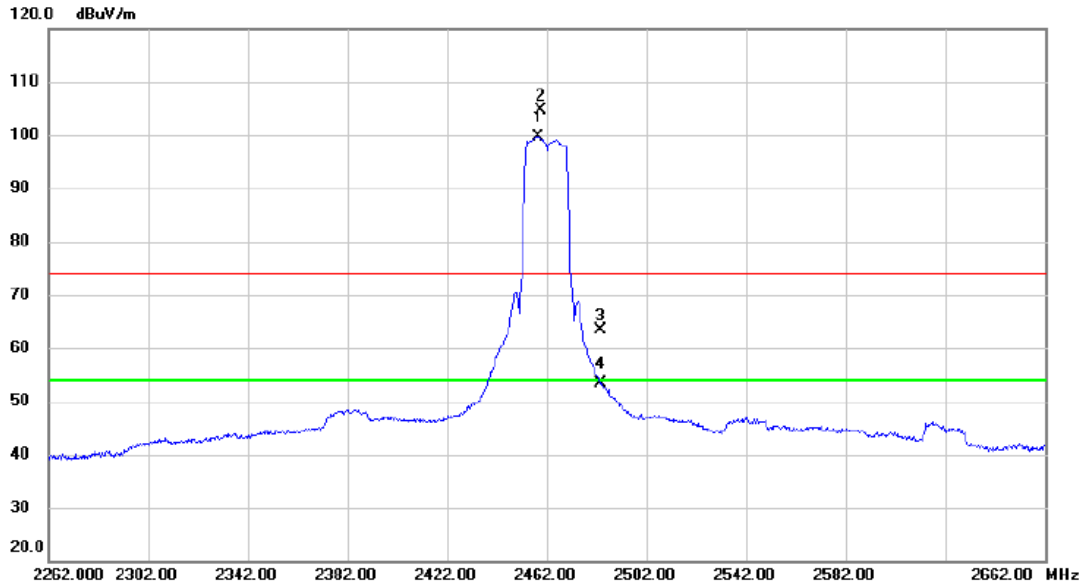

No.	Mk.	Freq. MHz	Reading Level dBuV	Correct Factor dB	Measure- ment dBuV/m	Limit dBuV/m	Margin dB	Detector	Comment
1	*	2458.400	67.07	32.59	99.66	54.00	45.66	AVG	No limit
2	X	2459.600	72.06	32.60	104.66	74.00	30.66	peak	No limit
3		2483.500	30.71	32.66	63.37	74.00	-10.63	peak	
4		2483.500	20.81	32.66	53.47	54.00	-0.53	AVG	

**REMARKS:**

- (1) Measurement Value = Reading Level + Correct Factor.
- (2) Margin Level = Measurement Value - Limit Value.

Test Mode: TX G Mode 2462 MHz

### Vertical

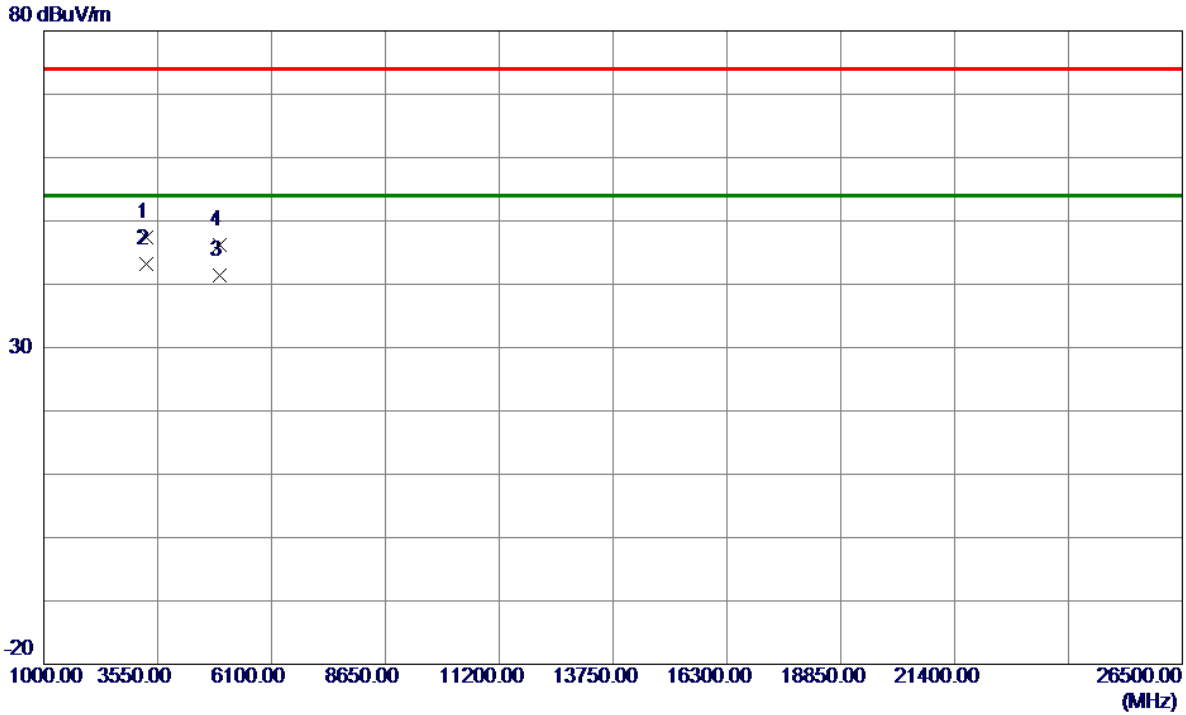

No.	Freq. MHz	Reading Level dBuV/m	Correct Factor dB	Measure ment dBuV/m	Limit dBuV/m	Margin dB	Detector	Comment
1	3282.3400	61.64	-14.19	47.45	74.00	-26.55	Peak	
2 *	3282.6750	57.47	-14.19	43.28	54.00	-10.72	AVG	
3	4924.8600	50.79	-9.31	41.48	54.00	-12.52	AVG	
4	4929.2599	55.40	-9.29	46.11	74.00	-27.89	Peak	

**REMARKS:**

- (1) Measurement Value = Reading Level + Correct Factor.
- (2) Margin Level = Measurement Value - Limit Value.

Test Mode: TX G Mode 2462 MHz

### Horizontal

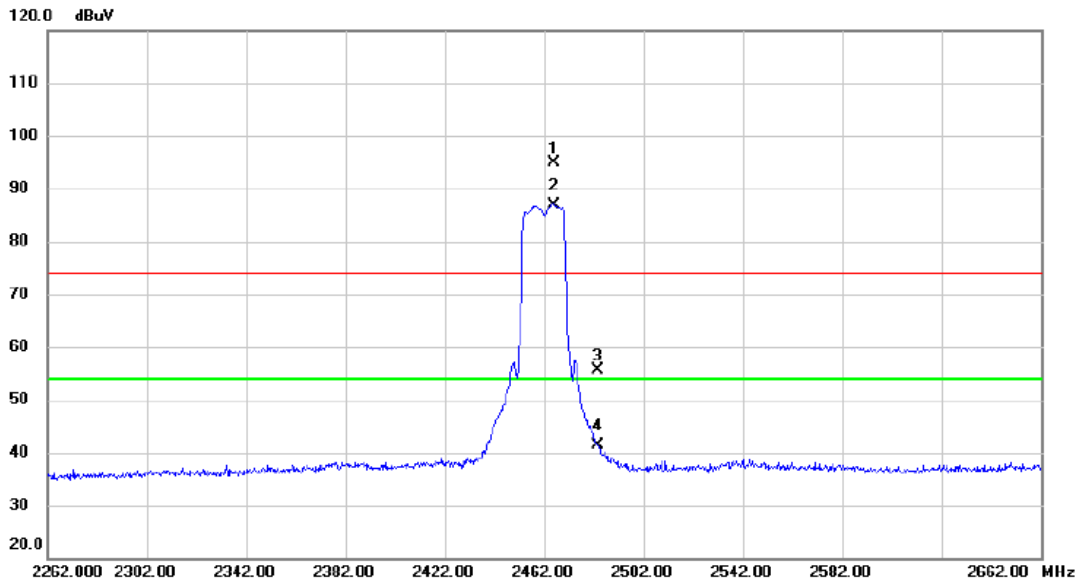

No.	Mk.	Freq. MHz	Reading Level dBuV	Correct Factor dB	Measure- ment dBuV	Limit dBuV	Margin dB	Detector	Comment
1	X	2465.800	62.20	32.62	94.82	74.00	20.82	peak	No limit
2	*	2465.800	54.38	32.62	87.00	54.00	33.00	AVG	No limit
3		2483.500	23.03	32.66	55.69	74.00	-18.31	peak	
4		2483.500	8.73	32.66	41.39	54.00	-12.61	AVG	

**REMARKS:**

- (1) Measurement Value = Reading Level + Correct Factor.
- (2) Margin Level = Measurement Value - Limit Value.

Test Mode: TX G Mode 2462 MHz

### Horizontal

80 dBuV/m

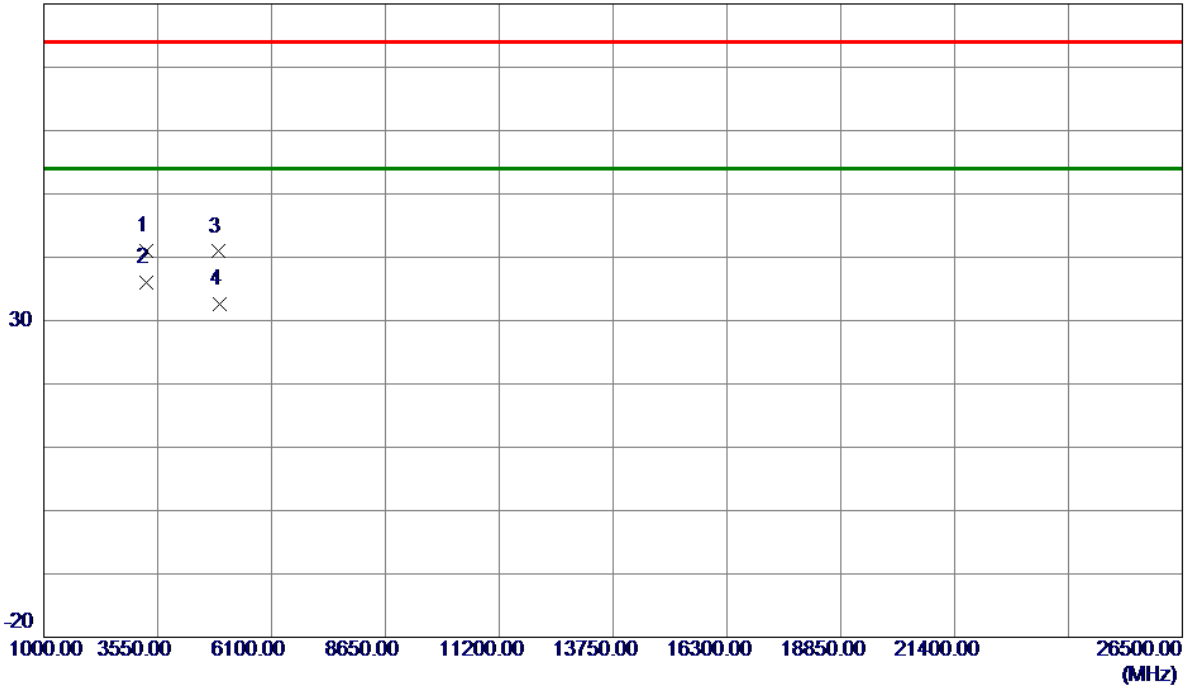

No.	Freq. MHz	Reading Level dBuV/m	Correct Factor dB	Measure ment dBuV/m	Limit dBuV/m	Margin dB	Detector	Comment
1	3282.5149	55.28	-14.19	41.09	74.00	-32.91	Peak	
2 *	3282.6450	50.15	-14.19	35.96	54.00	-18.04	AVG	
3	4914.3000	50.25	-9.35	40.90	74.00	-33.10	Peak	
4	4924.4600	42.00	-9.31	32.69	54.00	-21.31	AVG	

**REMARKS:**

- (1) Measurement Value = Reading Level + Correct Factor.
- (2) Margin Level = Measurement Value - Limit Value.

Test Mode: TX N-20M Mode 2412 MHz

### Vertical

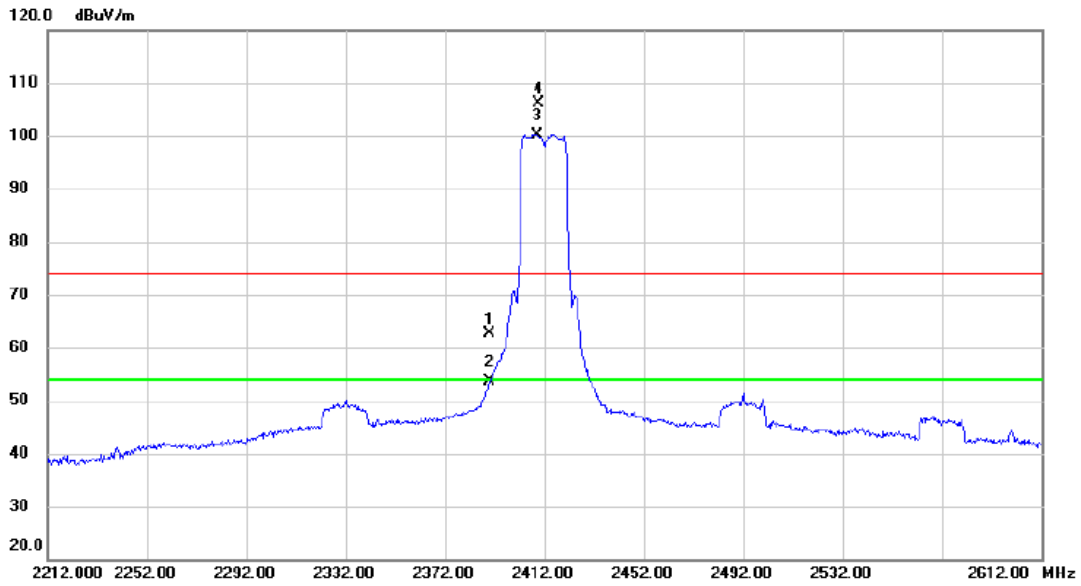

No.	Mk.	Freq. MHz	Reading Level dBuV	Correct Factor dB	Measure- ment dBuV/m	Limit dBuV/m	Margin dB	Detector	Comment
1		2390.000	30.17	32.39	62.56	74.00	-11.44	peak	
2		2390.000	21.28	32.39	53.67	54.00	-0.33	AVG	
3	*	2409.200	67.72	32.44	100.16	54.00	46.16	AVG	No limit
4	X	2409.760	73.71	32.45	106.16	74.00	32.16	peak	No limit

**REMARKS:**

(1) Measurement Value = Reading Level + Correct Factor.

(2) Margin Level = Measurement Value - Limit Value.

Test Mode: TX N-20M Mode 2412 MHz

### Vertical

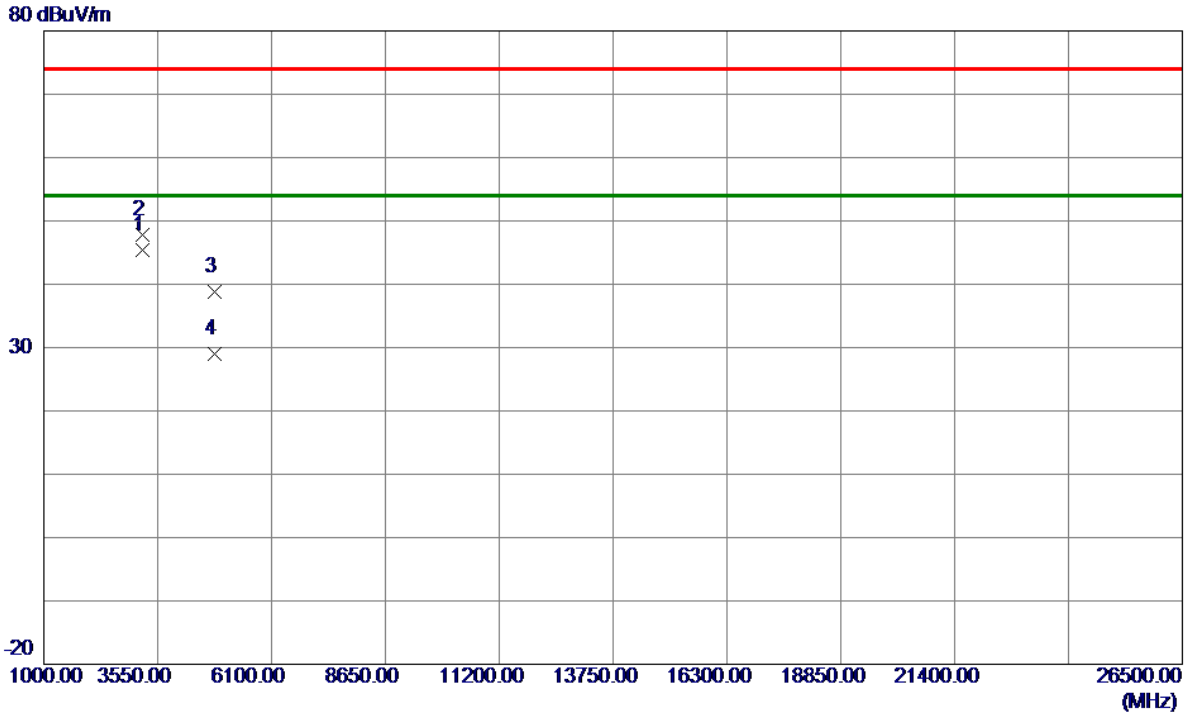

No.	Freq. MHz	Reading Level dBuV/m	Correct Factor dB	Measure ment dBuV/m	Limit dBuV/m	Margin dB	Detector	Comment
1 *	3215.9650	59.59	-14.26	45.33	54.00	-8.67	AVG	
2	3216.0450	61.98	-14.26	47.72	74.00	-26.28	Peak	
3	4824.1600	48.52	-9.69	38.83	74.00	-35.17	Peak	
4	4824.1600	38.70	-9.69	29.01	54.00	-24.99	AVG	

**REMARKS:**

- (1) Measurement Value = Reading Level + Correct Factor.
- (2) Margin Level = Measurement Value - Limit Value.

Test Mode: TX N-20M Mode 2412 MHz

### Horizontal

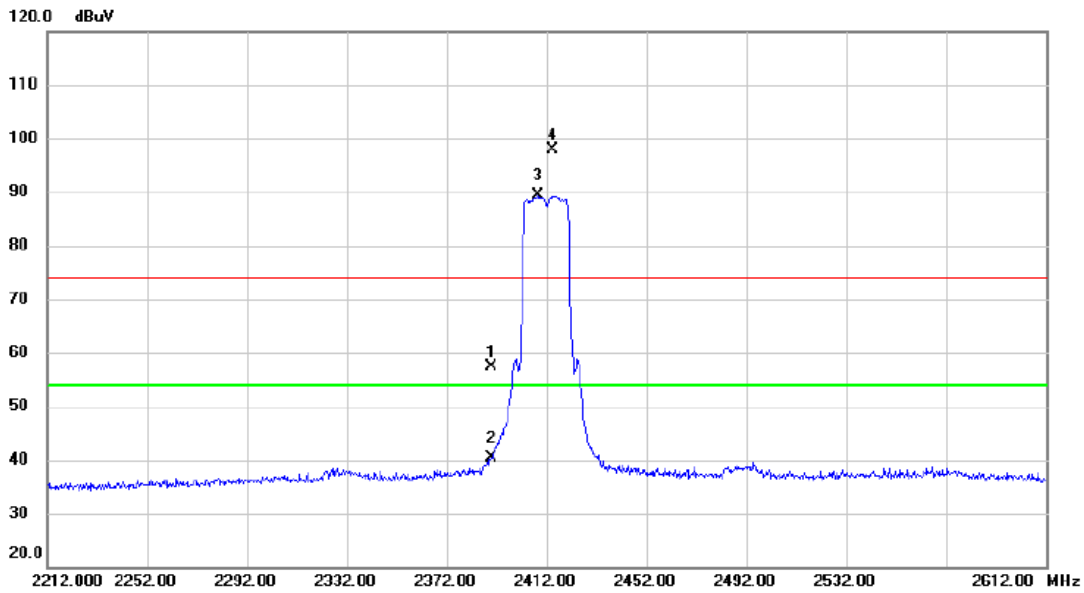

No.	Mk.	Freq. MHz	Reading Level dBuV	Correct Factor dB	Measure- ment dBuV	Limit dBuV	Margin dB	Detector	Comment
1		2390.000	24.97	32.39	57.36	74.00	-16.64	peak	
2		2390.000	7.94	32.39	40.33	54.00	-13.67	AVG	
3	*	2408.400	56.88	32.44	89.32	54.00	35.32	AVG	No limit
4	X	2414.400	65.48	32.46	97.94	74.00	23.94	peak	No limit

**REMARKS:**

- (1) Measurement Value = Reading Level + Correct Factor.
- (2) Margin Level = Measurement Value - Limit Value.

Test Mode: TX N-20M Mode 2412 MHz

### Horizontal

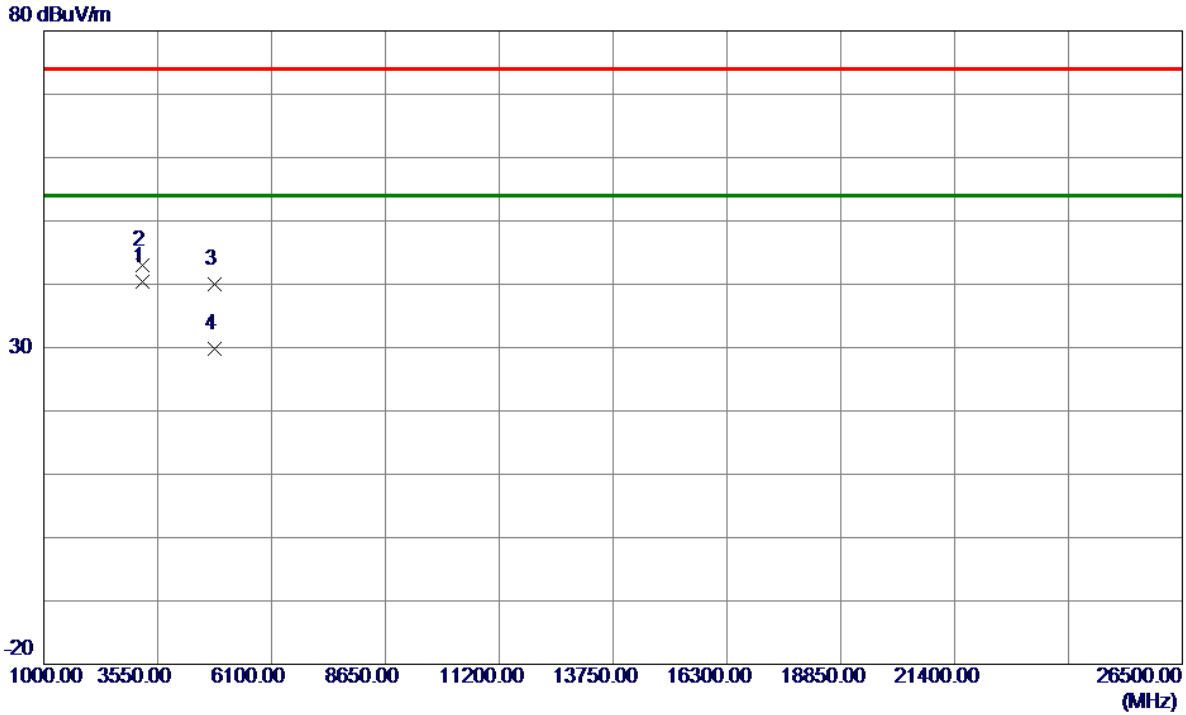

No.	Freq. MHz	Reading Level dBuV/m	Correct Factor dB	Measure ment dBuV/m	Limit dBuV/m	Margin dB	Detector	Comment
1 *	3215.9750	54.71	-14.26	40.45	54.00	-13.55	AVG	
2	3216.3600	57.21	-14.26	42.95	74.00	-31.05	Peak	
3	4819.4500	49.72	-9.71	40.01	74.00	-33.99	Peak	
4	4824.0500	39.51	-9.69	29.82	54.00	-24.18	AVG	

**REMARKS:**

- (1) Measurement Value = Reading Level + Correct Factor.
- (2) Margin Level = Measurement Value - Limit Value.



Test Mode: TX N-20M Mode 2437 MHz

### Vertical

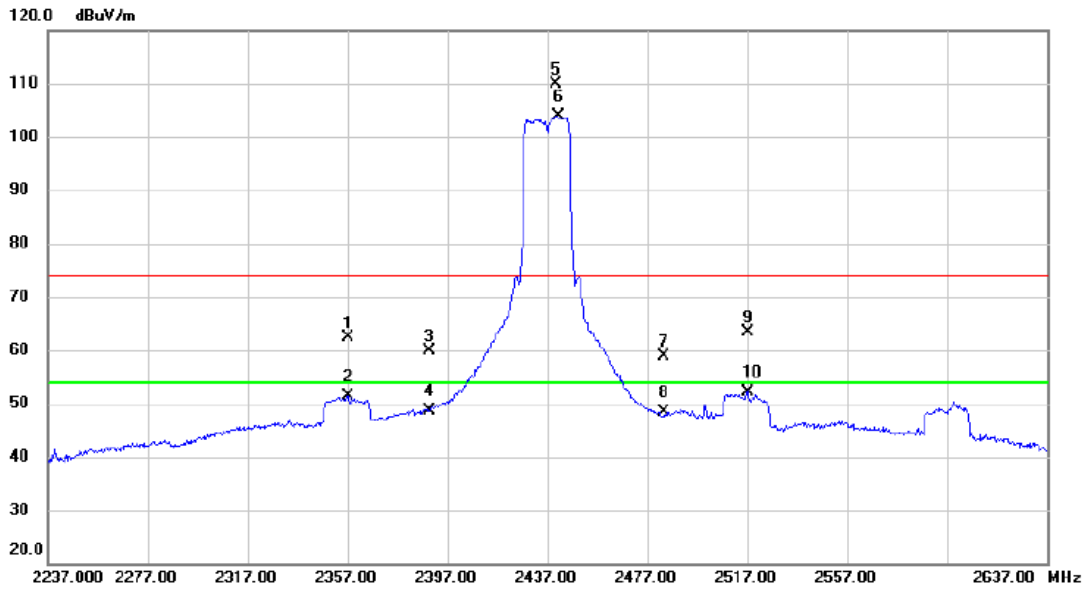

No.	Mk.	Freq. MHz	Reading Level dBuV	Correct Factor dB	Measure- ment dBuV/m	Limit dBuV/m	Margin dB	Detector	Comment
1		2357.000	30.00	32.30	62.30	74.00	-11.70	peak	
2		2357.000	19.07	32.30	51.37	54.00	-2.63	AVG	
3		2390.000	27.38	32.39	59.77	74.00	-14.23	peak	
4		2390.000	16.27	32.39	48.66	54.00	-5.34	AVG	
5	X	2440.600	77.39	32.53	109.92	74.00	35.92	peak	No limit
6	*	2441.500	71.37	32.55	103.92	54.00	49.92	AVG	No limit
7		2483.500	26.32	32.66	58.98	74.00	-15.02	peak	
8		2483.500	15.61	32.66	48.27	54.00	-5.73	AVG	
9		2517.000	30.60	32.76	63.36	74.00	-10.64	peak	
10		2517.000	19.31	32.76	52.07	54.00	-1.93	AVG	

**REMARKS:**

- (1) Measurement Value = Reading Level + Correct Factor.
- (2) Margin Level = Measurement Value - Limit Value.

Test Mode: TX N-20M Mode 2437 MHz

### Vertical

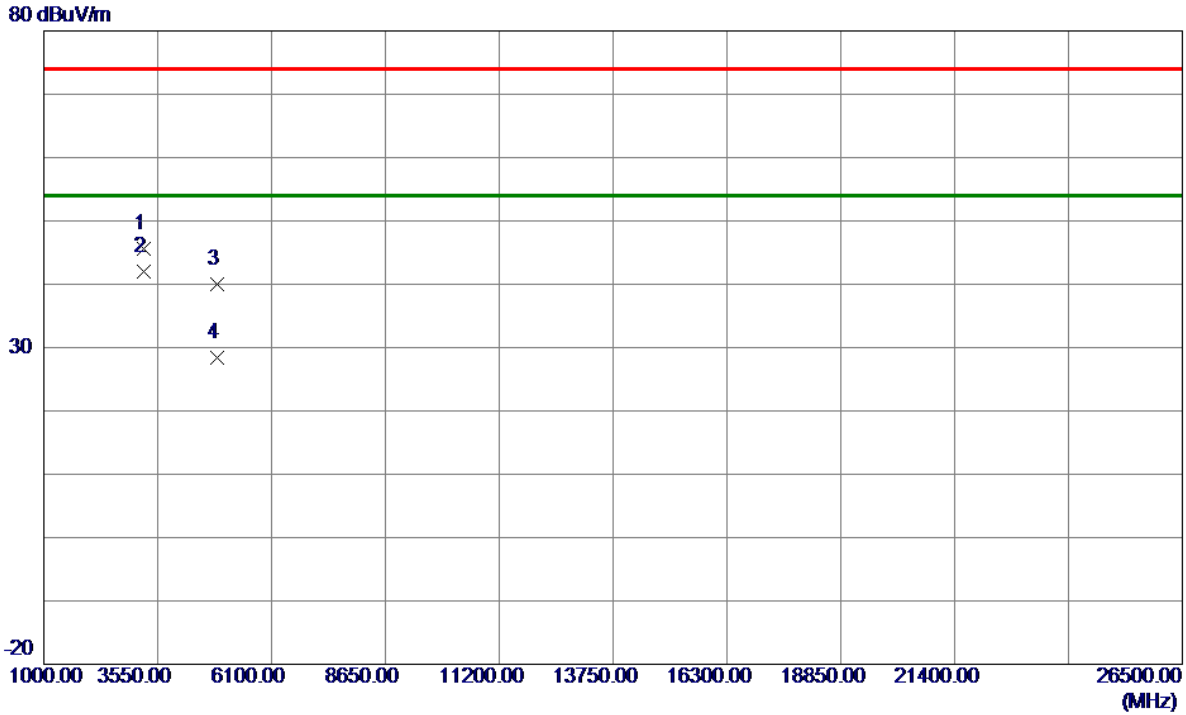

No.	Freq. MHz	Reading Level dBuV/m	Correct Factor dB	Measure ment dBuV/m	Limit dBuV/m	Margin dB	Detector	Comment
1	3249.3580	59.73	-14.22	45.51	74.00	-28.49	Peak	
2 *	3249.3580	56.25	-14.22	42.03	54.00	-11.97	AVG	
3	4883.1400	49.49	-9.46	40.03	74.00	-33.97	Peak	
4	4883.8600	37.92	-9.46	28.46	54.00	-25.54	AVG	

**REMARKS:**

- (1) Measurement Value = Reading Level + Correct Factor.
- (2) Margin Level = Measurement Value - Limit Value.

Test Mode: TX N-20M Mode 2437 MHz

### Horizontal

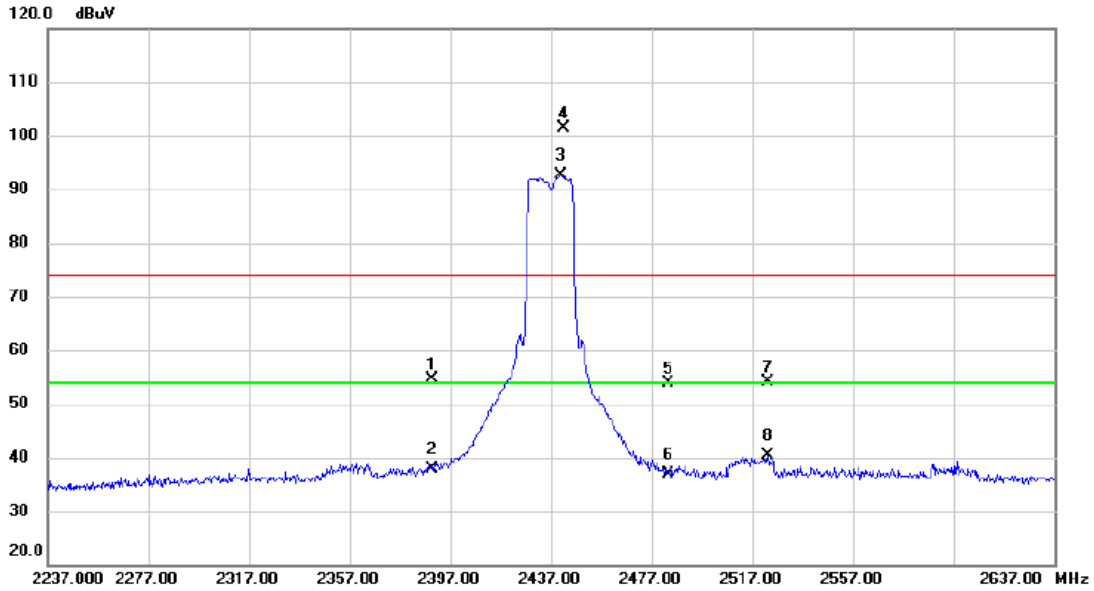

No.	Mk.	Freq. MHz	Reading Level dBuV	Correct Factor dB	Measure- ment dBuV	Limit dBuV	Margin dB	Detector	Comment
1		2390.000	22.18	32.39	54.57	74.00	-19.43	peak	
2		2390.000	5.38	32.39	37.77	54.00	-16.23	AVG	
3	*	2440.800	60.19	32.54	92.73	54.00	38.73	AVG	No limit
4	X	2442.000	68.91	32.55	101.46	74.00	27.46	peak	No limit
5		2483.500	21.16	32.66	53.82	74.00	-20.18	peak	
6		2483.500	4.17	32.66	36.83	54.00	-17.17	AVG	
7		2523.200	21.27	32.78	54.05	74.00	-19.95	peak	
8		2523.200	7.51	32.78	40.29	54.00	-13.71	AVG	

**REMARKS:**

(1) Measurement Value = Reading Level + Correct Factor.

(2) Margin Level = Measurement Value - Limit Value.

Test Mode: TX N-20M Mode 2437 MHz

### Horizontal

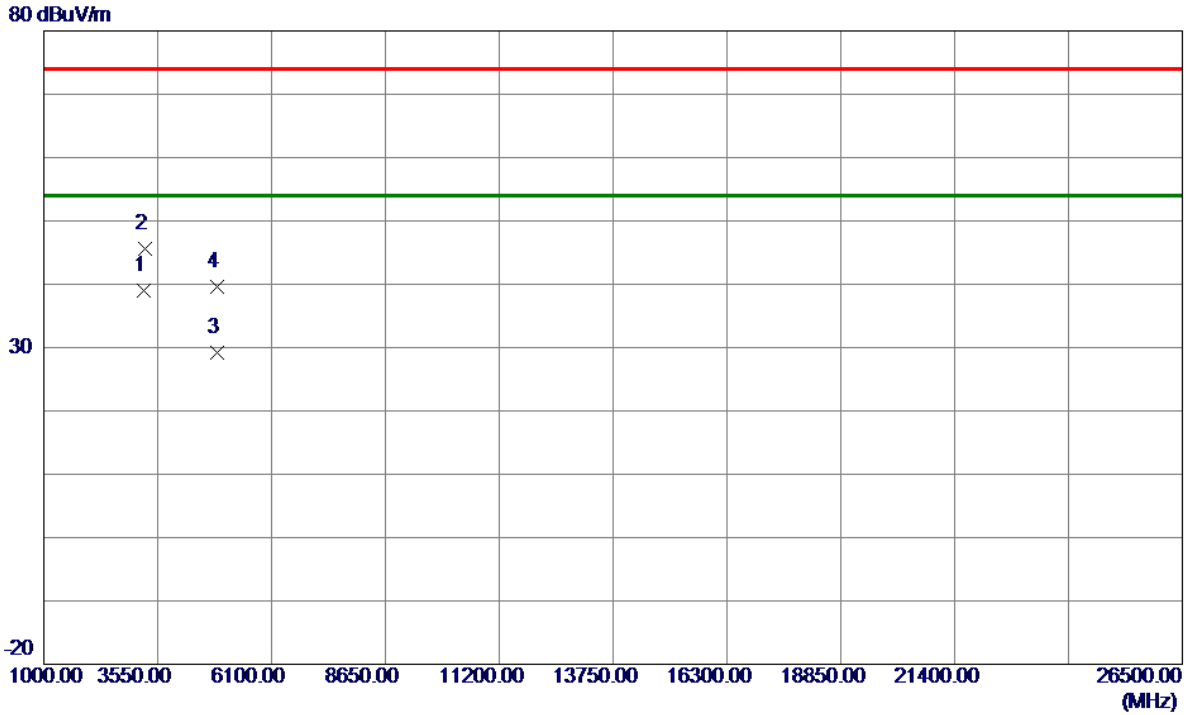

No.	Freq. MHz	Reading Level dBuV/m	Correct Factor dB	Measure ment dBuV/m	Limit dBuV/m	Margin dB	Detector	Comment
1 *	3249.3580	53.24	-14.22	39.02	54.00	-14.98	AVG	
2	3253.5580	59.80	-14.22	45.58	74.00	-28.42	Peak	
3	4873.8400	38.65	-9.50	29.15	54.00	-24.85	AVG	
4	4881.8800	49.09	-9.47	39.62	74.00	-34.38	Peak	

**REMARKS:**

- (1) Measurement Value = Reading Level + Correct Factor.
- (2) Margin Level = Measurement Value - Limit Value.

Test Mode: TX N-20M Mode 2462 MHz

### Vertical

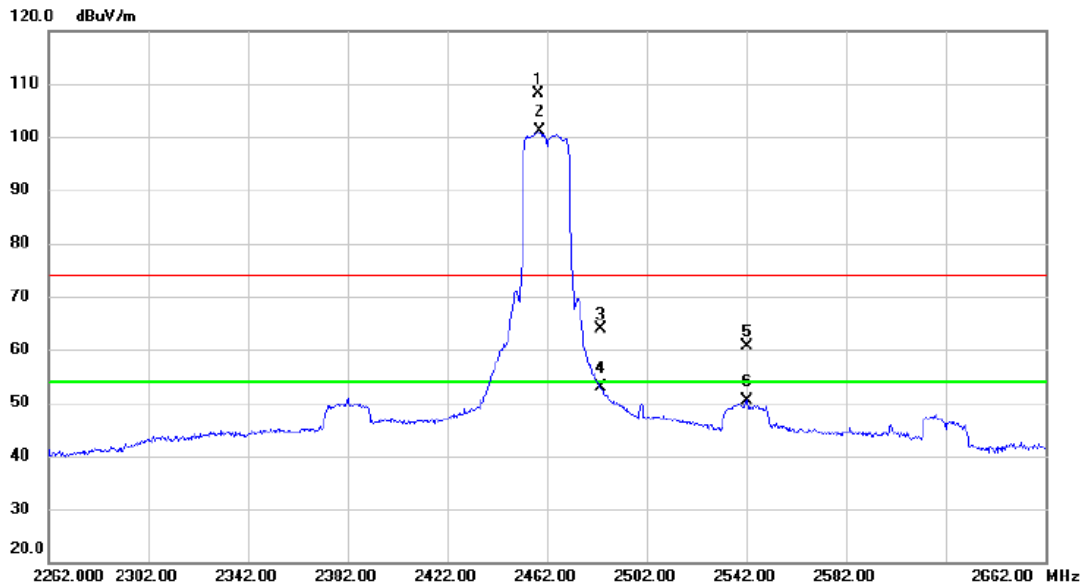

No.	Mk.	Freq. MHz	Reading Level dBuV	Correct Factor dB	Measure- ment dBuV/m	Limit dBuV/m	Margin dB	Detector	Comment
1	X	2458.400	75.57	32.59	108.16	74.00	34.16	peak	No limit
2	*	2459.200	68.57	32.59	101.16	54.00	47.16	AVG	No limit
3		2483.500	31.11	32.66	63.77	74.00	-10.23	peak	
4		2483.500	20.20	32.66	52.86	54.00	-1.14	AVG	
5		2542.000	27.86	32.83	60.69	74.00	-13.31	peak	
6		2542.000	17.67	32.83	50.50	54.00	-3.50	AVG	

**REMARKS:**

- (1) Measurement Value = Reading Level + Correct Factor.
- (2) Margin Level = Measurement Value - Limit Value.

Test Mode: TX N-20M Mode 2462 MHz

### Vertical

80 dBuV/m

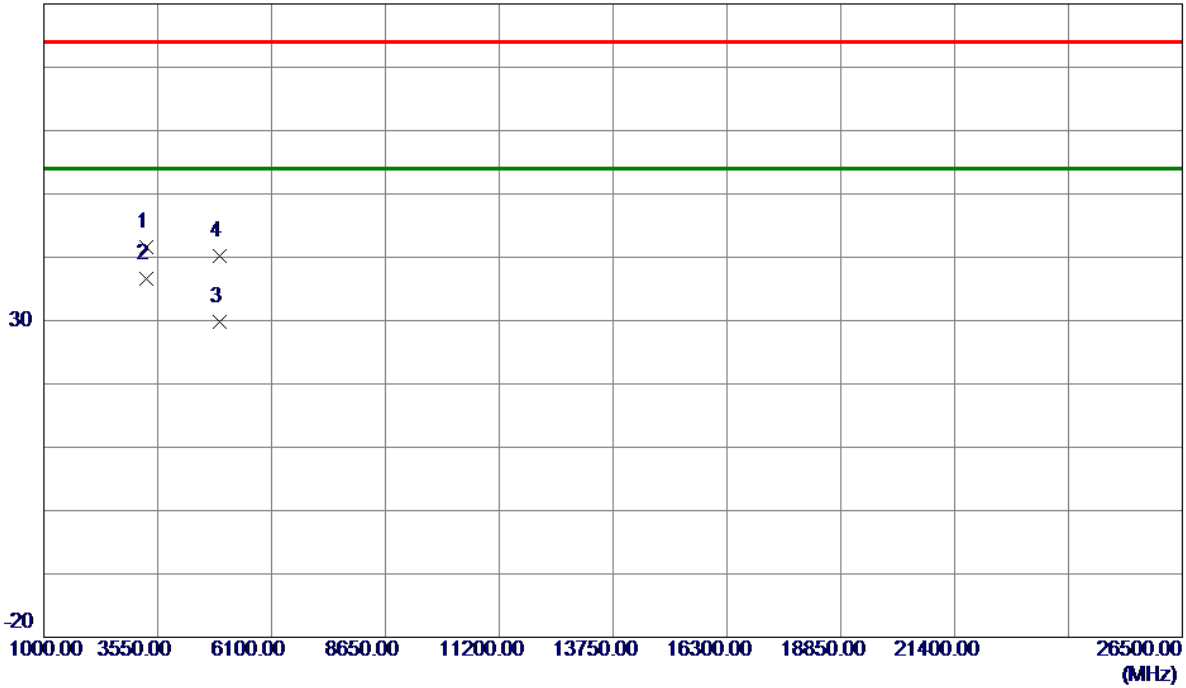

No.	Freq. MHz	Reading Level dBuV/m	Correct Factor dB	Measure ment dBuV/m	Limit dBuV/m	Margin dB	Detector	Comment
1	3282.4950	55.85	-14.19	41.66	74.00	-32.34	Peak	
2 *	3282.7300	50.77	-14.19	36.58	54.00	-17.42	AVG	
3	4924.4000	39.12	-9.31	29.81	54.00	-24.19	AVG	
4	4928.1800	49.47	-9.29	40.18	74.00	-33.82	Peak	

**REMARKS:**

- (1) Measurement Value = Reading Level + Correct Factor.
- (2) Margin Level = Measurement Value - Limit Value.

Test Mode: TX N-20M Mode 2462 MHz

### Horizontal

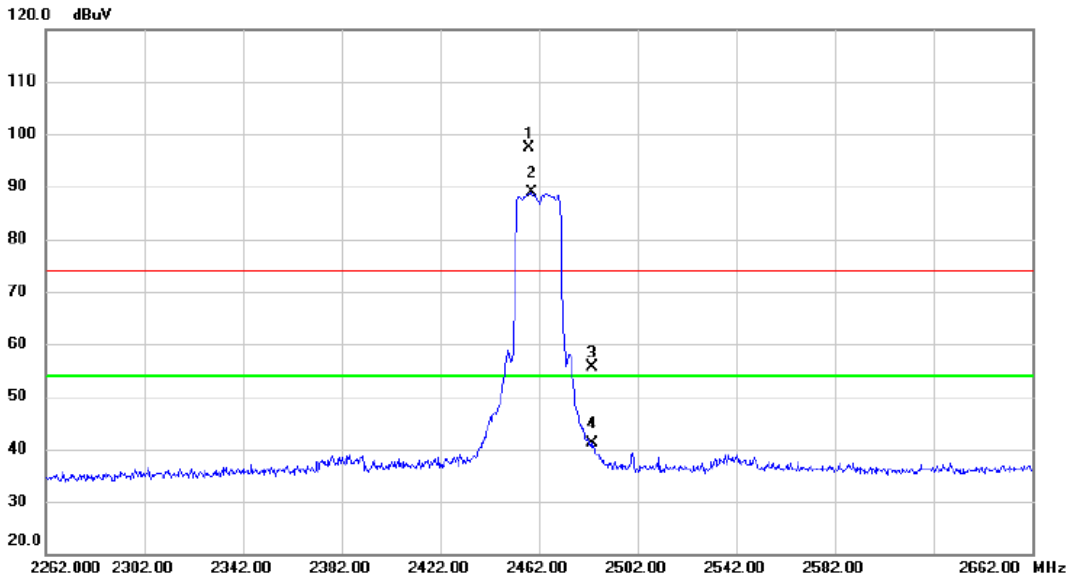

No.	Mk.	Freq. MHz	Reading Level dBuV	Correct Factor dB	Measure- ment dBuV	Limit dBuV	Margin dB	Detector	Comment
1	X	2458.000	64.76	32.59	97.35	74.00	23.35	peak	No limit
2	*	2458.800	56.31	32.59	88.90	54.00	34.90	AVG	No limit
3		2483.500	22.90	32.66	55.56	74.00	-18.44	peak	
4		2483.500	8.51	32.66	41.17	54.00	-12.83	AVG	

**REMARKS:**

- (1) Measurement Value = Reading Level + Correct Factor.
- (2) Margin Level = Measurement Value - Limit Value.

Test Mode: TX N-20M Mode 2462 MHz

### Horizontal

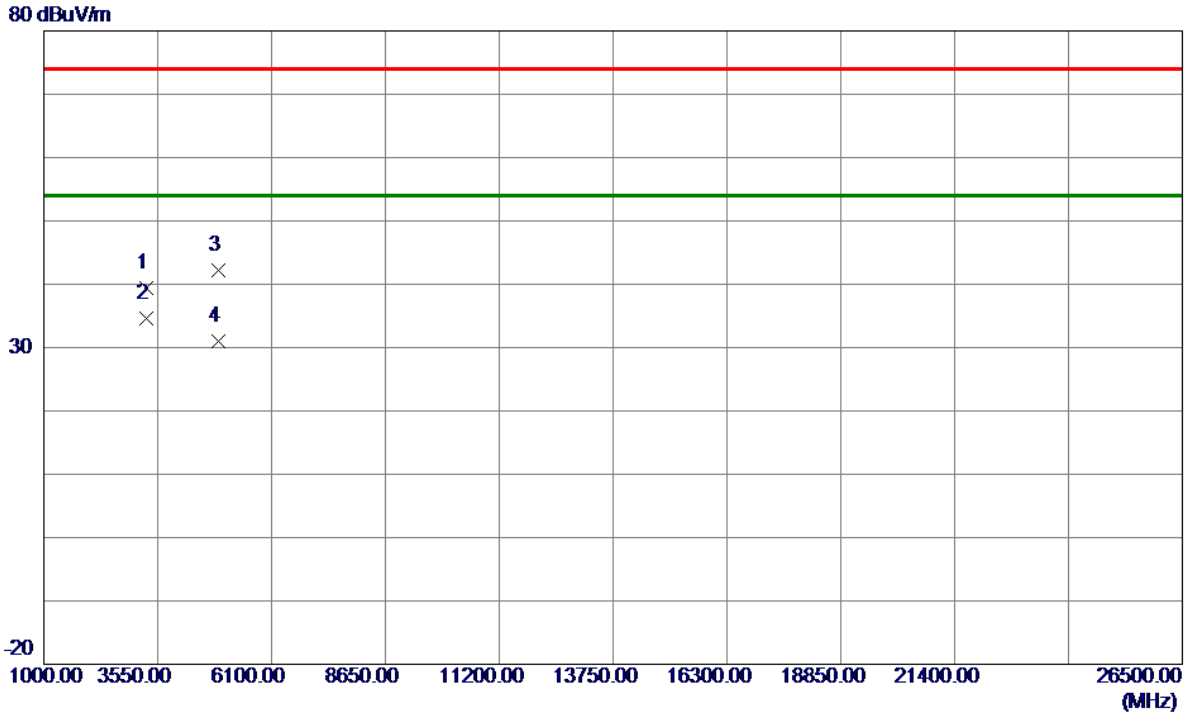

No.	Freq. MHz	Reading Level dBuV/m	Correct Factor dB	Measure ment dBuV/m	Limit dBuV/m	Margin dB	Detector	Comment
1	3282.6150	53.66	-14.19	39.47	74.00	-34.53	Peak	
2 *	3282.6350	48.75	-14.19	34.56	54.00	-19.44	AVG	
3	4919.4000	51.55	-9.33	42.22	74.00	-31.78	Peak	
4	4923.8000	40.22	-9.31	30.91	54.00	-23.09	AVG	

**REMARKS:**

- (1) Measurement Value = Reading Level + Correct Factor.
- (2) Margin Level = Measurement Value - Limit Value.



Test Mode: TX N-40M Mode 2422MHz

### Vertical

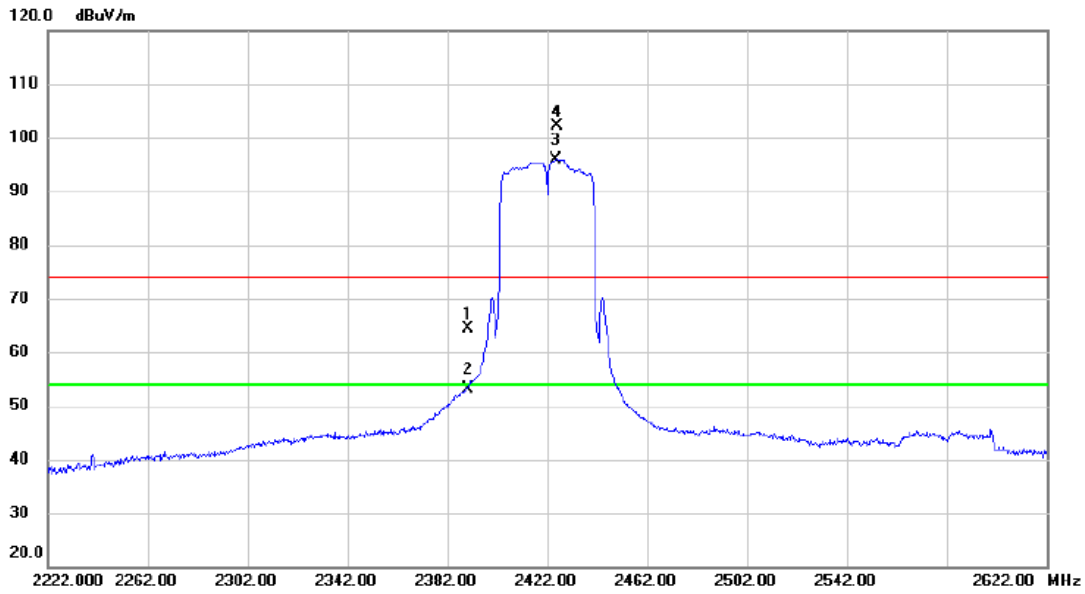

No.	Mk.	Freq. MHz	Reading Level dBuV	Correct Factor dB	Measure- ment dBuV/m	Limit dBuV/m	Margin dB	Detector	Comment
1		2390.000	31.89	32.39	64.28	74.00	-9.72	peak	
2		2390.000	20.73	32.39	53.12	54.00	-0.88	AVG	
3	*	2425.410	63.48	32.49	95.97	54.00	41.97	AVG	No limit
4	X	2426.000	69.57	32.50	102.07	74.00	28.07	peak	No limit

**REMARKS:**

- (1) Measurement Value = Reading Level + Correct Factor.
- (2) Margin Level = Measurement Value - Limit Value.

Test Mode: TX N-40M Mode 2422MHz

### Vertical

80 dBuV/m

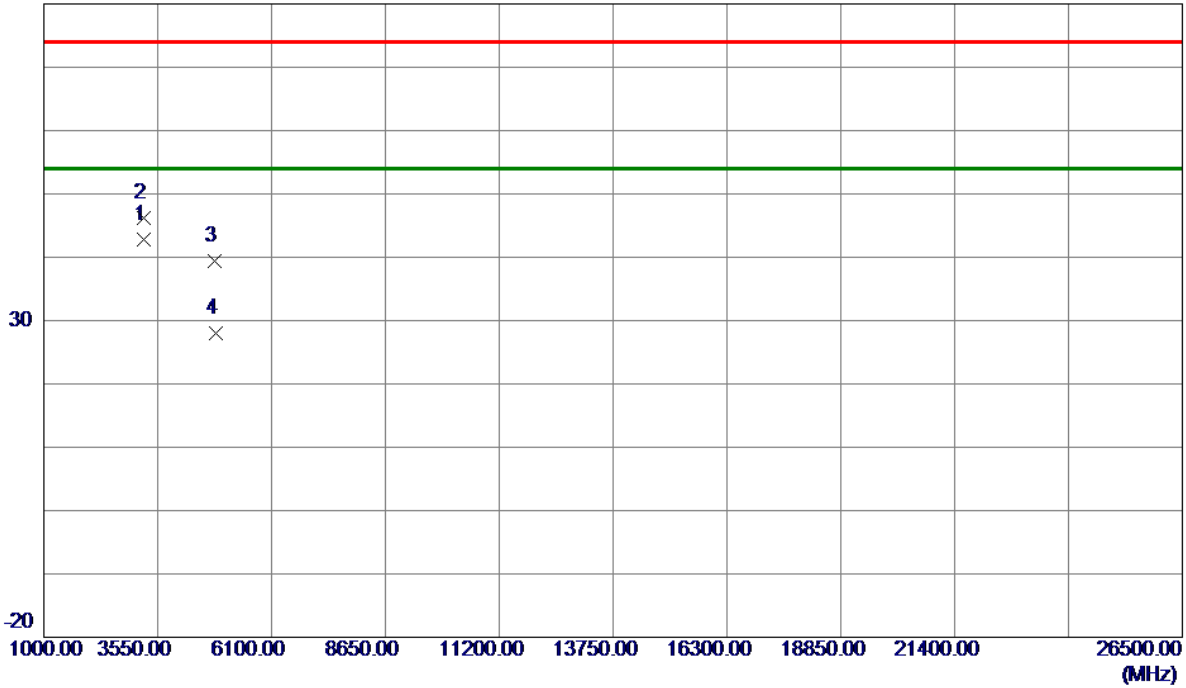

No.	Freq. MHz	Reading Level dBuV/m	Correct Factor dB	Measure ment dBuV/m	Limit dBuV/m	Margin dB	Detector	Comment
1 *	3229.3130	57.11	-14.24	42.87	54.00	-11.13	AVG	
2	3229.4030	60.35	-14.24	46.11	74.00	-27.89	Peak	
3	4835.4000	49.11	-9.65	39.46	74.00	-34.54	Peak	
4	4843.7799	37.63	-9.61	28.02	54.00	-25.98	AVG	

**REMARKS:**

- (1) Measurement Value = Reading Level + Correct Factor.
- (2) Margin Level = Measurement Value - Limit Value.

Test Mode: TX N-40M Mode 2422MHz

### Horizontal

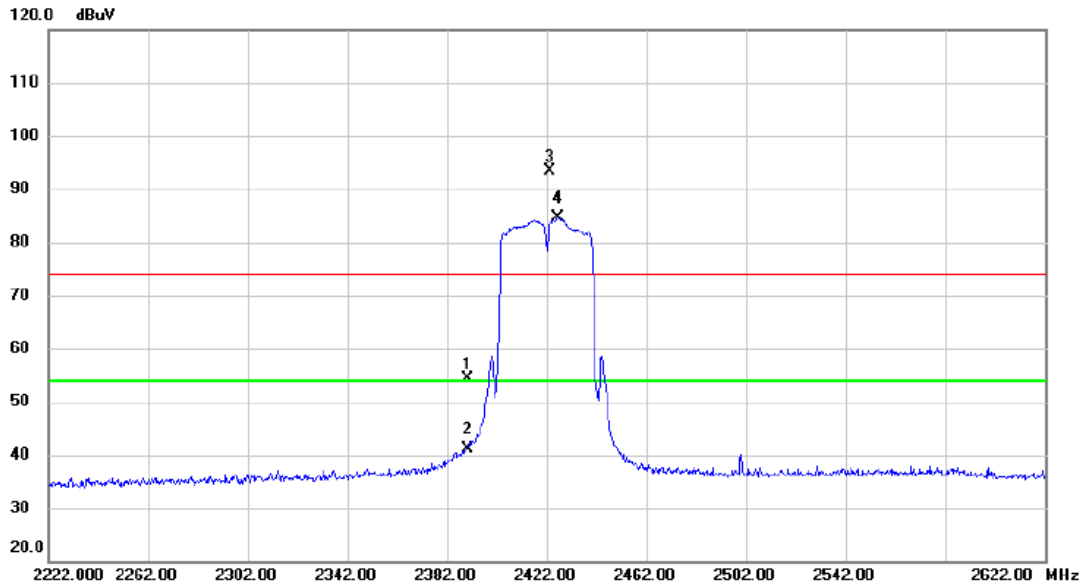

No. Mk.	Freq. MHz	Reading Level dBuV	Correct Factor dB	Measure- ment dBuV	Limit dBuV	Margin dB	Detector	Comment
1	2390.000	21.99	32.39	54.38	74.00	-19.62	peak	
2	2390.000	8.62	32.39	41.01	54.00	-12.99	AVG	
3 X	2423.600	60.87	32.49	93.36	74.00	19.36	peak	No limit
4 *	2426.400	52.01	32.50	84.51	54.00	30.51	AVG	No limit

**REMARKS:**

- (1) Measurement Value = Reading Level + Correct Factor.
- (2) Margin Level = Measurement Value - Limit Value.

Test Mode: TX N-40M Mode 2422MHz

### Horizontal

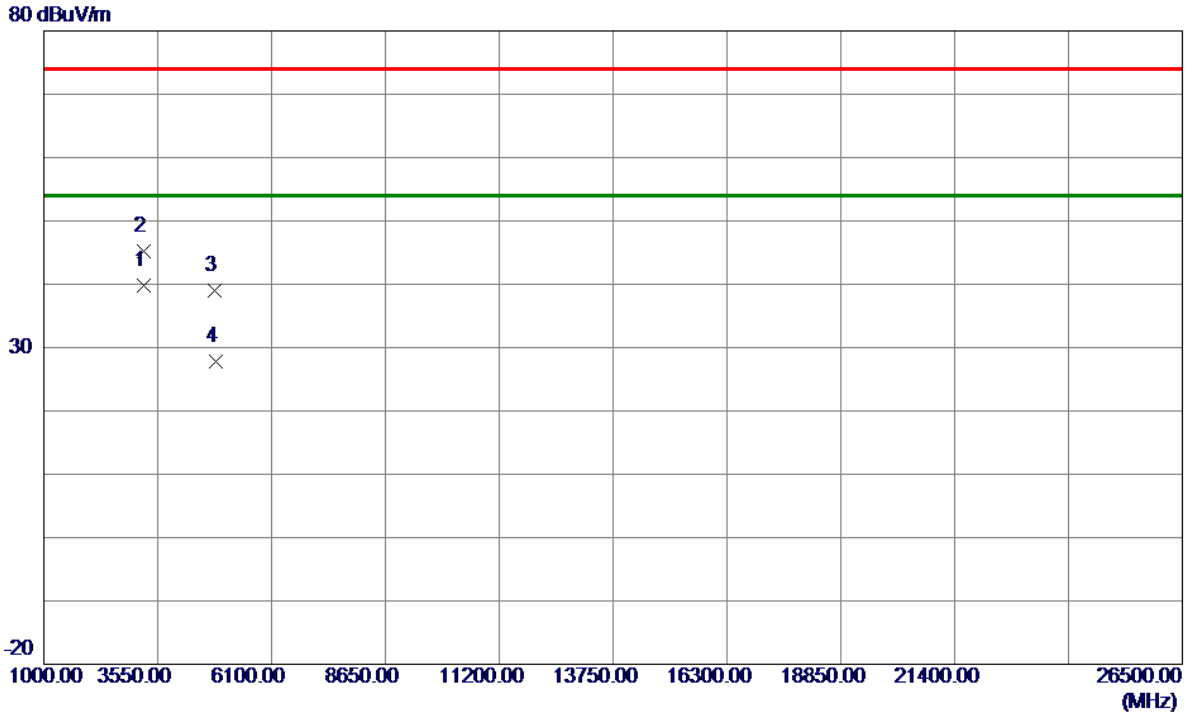

No.	Freq. MHz	Reading Level dBuV/m	Correct Factor dB	Measure ment dBuV/m	Limit dBuV/m	Margin dB	Detector	Comment
1 *	3229.2830	53.98	-14.24	39.74	54.00	-14.26	AVG	
2	3229.4730	59.45	-14.24	45.21	74.00	-28.79	Peak	
3	4835.1200	48.63	-9.65	38.98	74.00	-35.02	Peak	
4	4843.5200	37.32	-9.61	27.71	54.00	-26.29	AVG	

**REMARKS:**

- (1) Measurement Value = Reading Level + Correct Factor.
- (2) Margin Level = Measurement Value - Limit Value.

Test Mode: TX N-40M Mode 2437 MHz

### Vertical

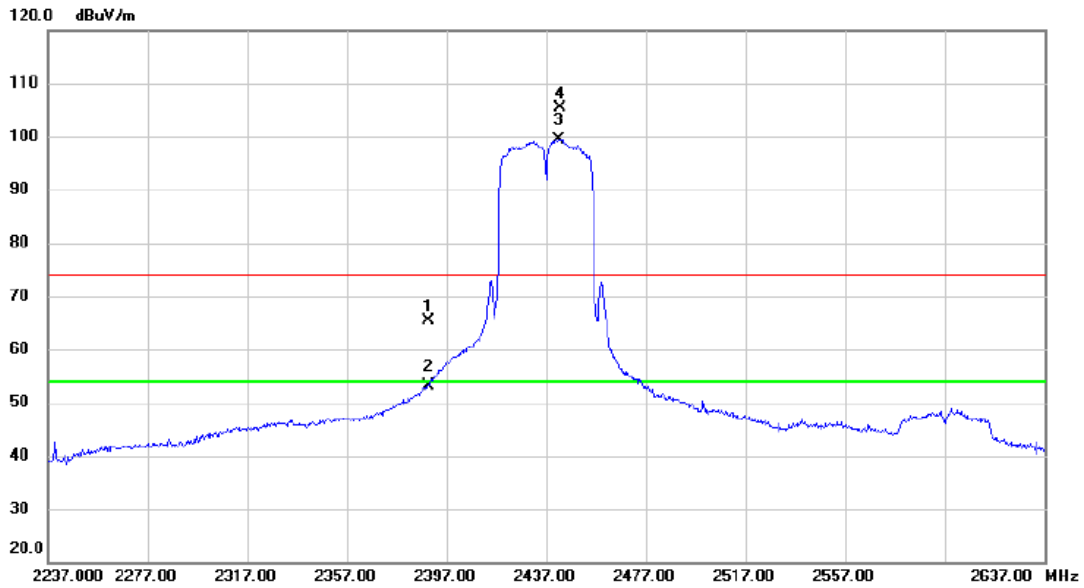

No.	Mk.	Freq. MHz	Reading Level dBuV	Correct Factor dB	Measure- ment dBuV/m	Limit dBuV/m	Margin dB	Detector	Comment
1		2390.000	32.88	32.39	65.27	74.00	-8.73	peak	
2		2390.000	20.76	32.39	53.15	54.00	-0.85	AVG	
3	*	2442.110	66.81	32.55	99.36	54.00	45.36	AVG	No limit
4	X	2442.600	72.81	32.55	105.36	74.00	31.36	peak	No limit

**REMARKS:**

- (1) Measurement Value = Reading Level + Correct Factor.
- (2) Margin Level = Measurement Value - Limit Value.

Test Mode: TX N-40M Mode 2437 MHz

### Vertical

80 dBuV/m

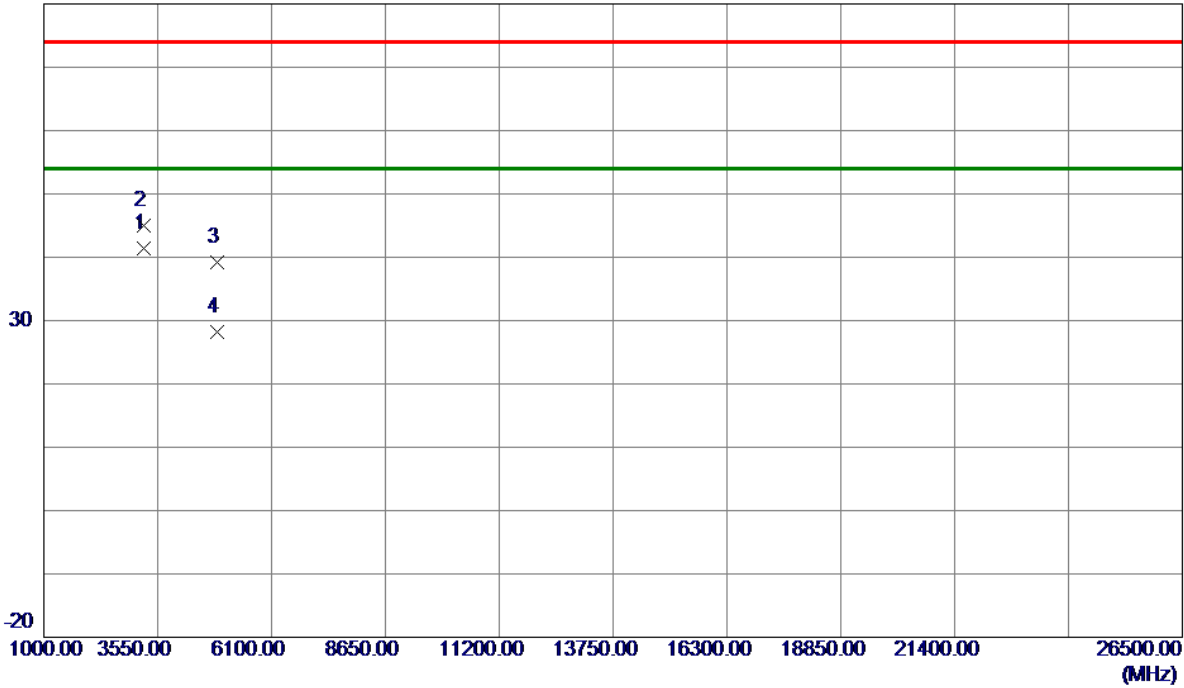

No.	Freq. MHz	Reading Level dBuV/m	Correct Factor dB	Measure ment dBuV/m	Limit dBuV/m	Margin dB	Detector	Comment
1 *	3249.3530	55.64	-14.22	41.42	54.00	-12.58	AVG	
2	3249.4580	59.17	-14.22	44.95	74.00	-29.05	Peak	
3	4880.3200	48.76	-9.47	39.29	74.00	-34.71	Peak	
4	4882.3600	37.58	-9.47	28.11	54.00	-25.89	AVG	

**REMARKS:**

- (1) Measurement Value = Reading Level + Correct Factor.
- (2) Margin Level = Measurement Value - Limit Value.

Test Mode: TX N-40M Mode 2437 MHz

### Horizontal

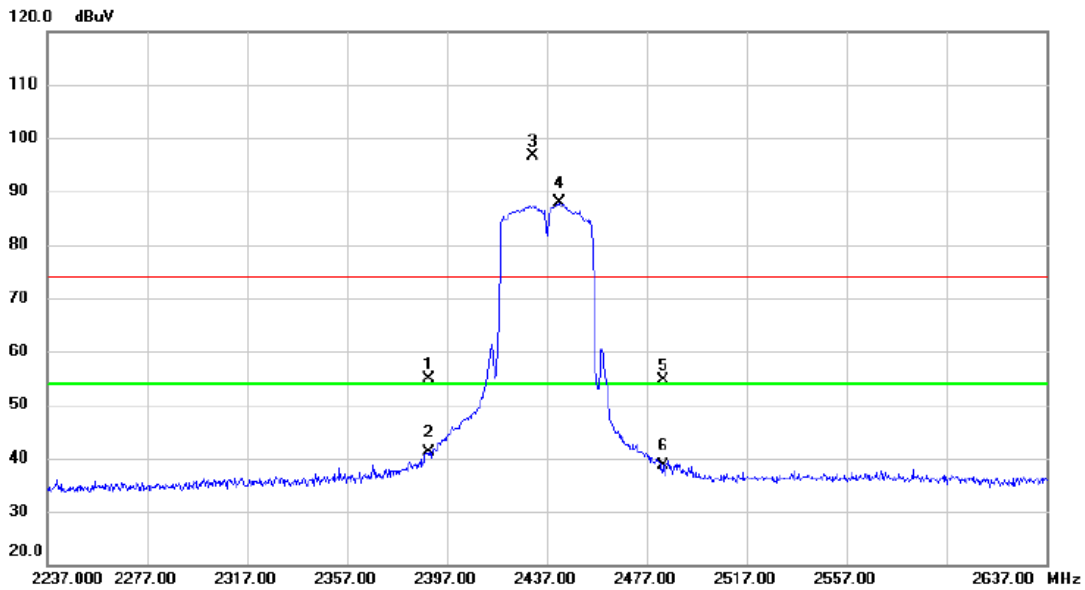

No.	Mk.	Freq. MHz	Reading Level dBuV	Correct Factor dB	Measure- ment dBuV	Limit dBuV	Margin dB	Detector	Comment
1		2390.000	22.44	32.39	54.83	74.00	-19.17	peak	
2		2390.000	8.81	32.39	41.20	54.00	-12.80	AVG	
3	X	2431.200	64.11	32.51	96.62	74.00	22.62	peak	No limit
4	*	2442.200	55.25	32.55	87.80	54.00	33.80	AVG	No limit
5		2483.500	22.04	32.66	54.70	74.00	-19.30	peak	
6		2483.500	6.00	32.66	38.66	54.00	-15.34	AVG	

**REMARKS:**

- (1) Measurement Value = Reading Level + Correct Factor.
- (2) Margin Level = Measurement Value - Limit Value.

Test Mode: TX N-40M Mode 2437 MHz

### Horizontal

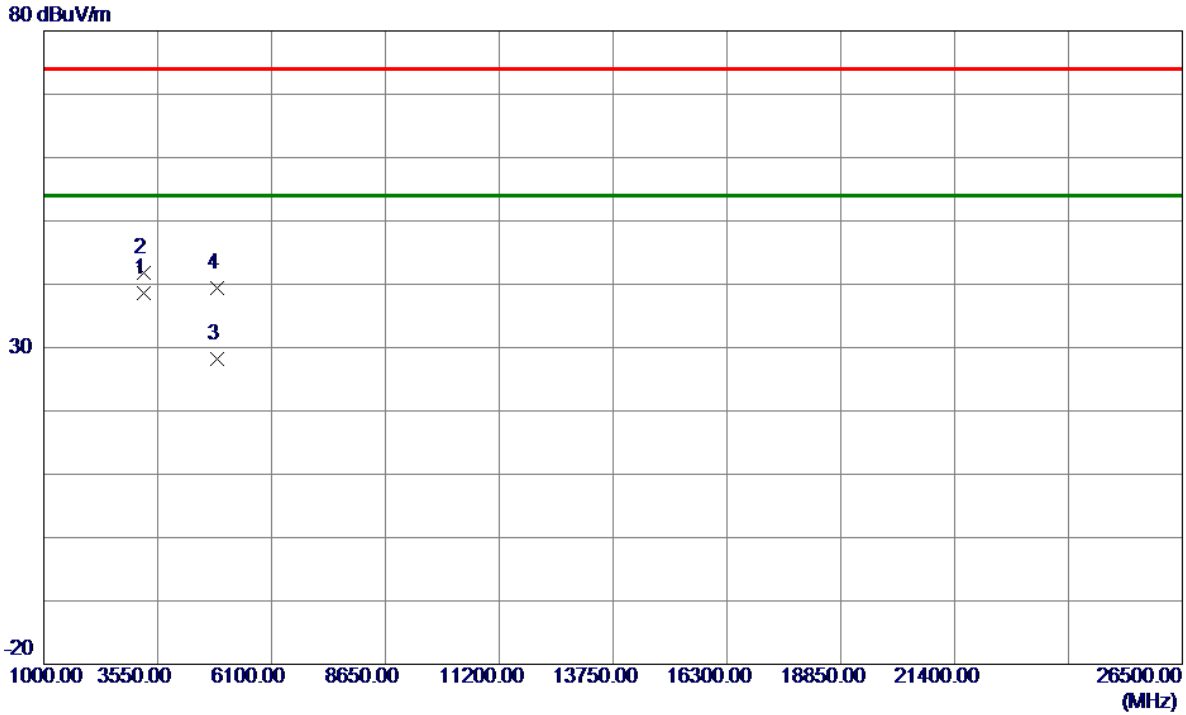

No.	Freq. MHz	Reading Level dBuV/m	Correct Factor dB	Measure ment dBuV/m	Limit dBuV/m	Margin dB	Detector	Comment
1 *	3249.3130	52.74	-14.22	38.52	54.00	-15.48	AVG	
2	3249.9930	56.07	-14.22	41.85	74.00	-32.15	Peak	
3	4883.0400	37.67	-9.46	28.21	54.00	-25.79	AVG	
4	4883.8000	48.84	-9.46	39.38	74.00	-34.62	Peak	

**REMARKS:**

- (1) Measurement Value = Reading Level + Correct Factor.
- (2) Margin Level = Measurement Value - Limit Value.



Test Mode: TX N-40M Mode 2452 MHz

### Vertical

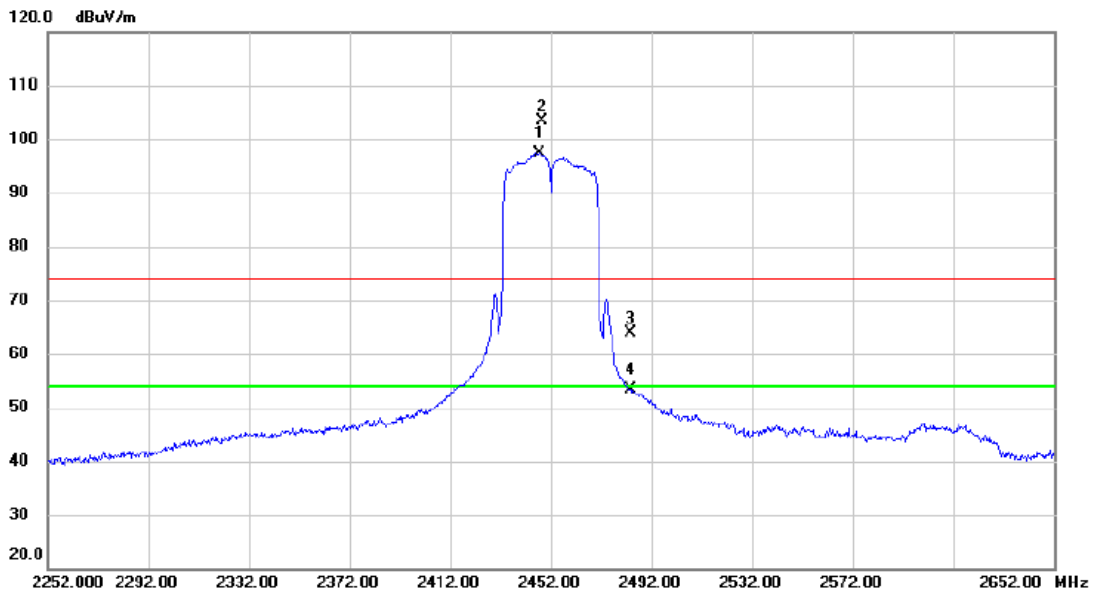

No.	Mk.	Freq. MHz	Reading Level dBuV	Correct Factor dB	Measure- ment dBuV/m	Limit dBuV/m	Margin dB	Detector	Comment
1	*	2447.600	64.74	32.56	97.30	54.00	43.30	AVG	No limit
2	X	2448.300	70.74	32.56	103.30	74.00	29.30	peak	No limit
3		2483.500	31.24	32.66	63.90	74.00	-10.10	peak	
4		2483.500	20.64	32.66	53.30	54.00	-0.70	AVG	

**REMARKS:**

- (1) Measurement Value = Reading Level + Correct Factor.
- (2) Margin Level = Measurement Value - Limit Value.

Test Mode: TX N-40M Mode 2452 MHz

### Vertical

80 dBuV/m

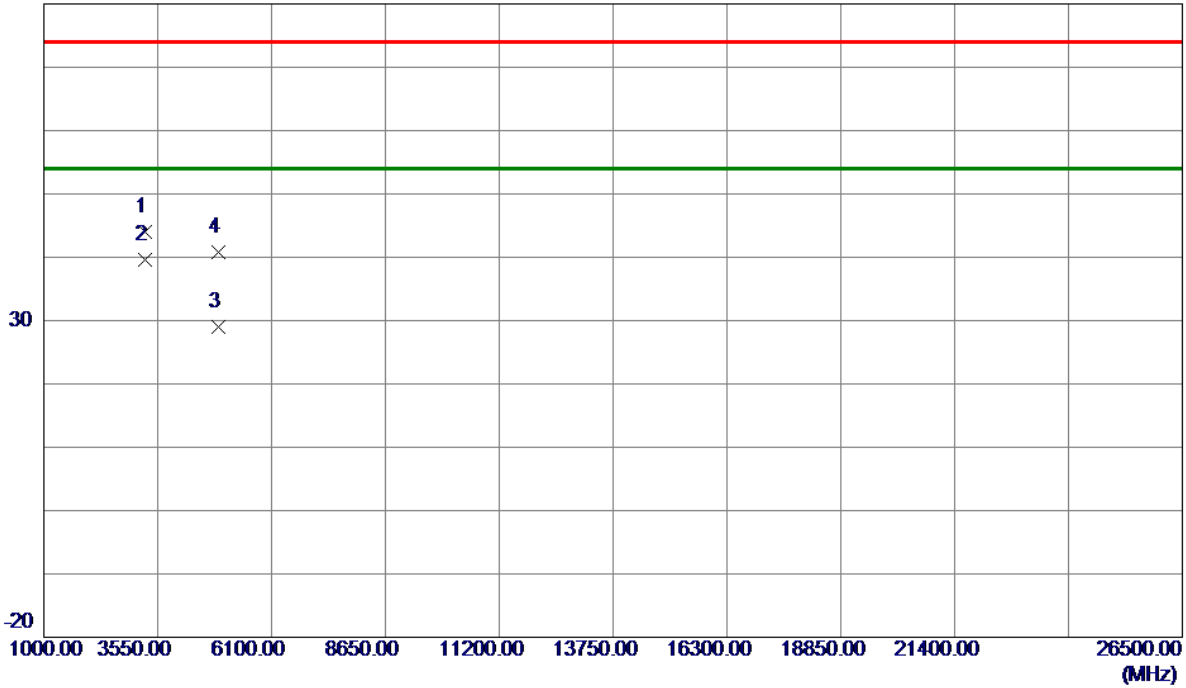

No.	Freq. MHz	Reading Level dBuV/m	Correct Factor dB	Measure ment dBuV/m	Limit dBuV/m	Margin dB	Detector	Comment
1	3269.2950	58.18	-14.20	43.98	74.00	-30.02	Peak	
2 *	3269.2950	53.85	-14.20	39.65	54.00	-14.35	AVG	
3	4903.8550	38.30	-9.39	28.91	54.00	-25.09	AVG	
4	4904.1750	50.11	-9.38	40.73	74.00	-33.27	Peak	

**REMARKS:**

- (1) Measurement Value = Reading Level + Correct Factor.
- (2) Margin Level = Measurement Value - Limit Value.

Test Mode: TX N-40M Mode 2452 MHz

### Horizontal

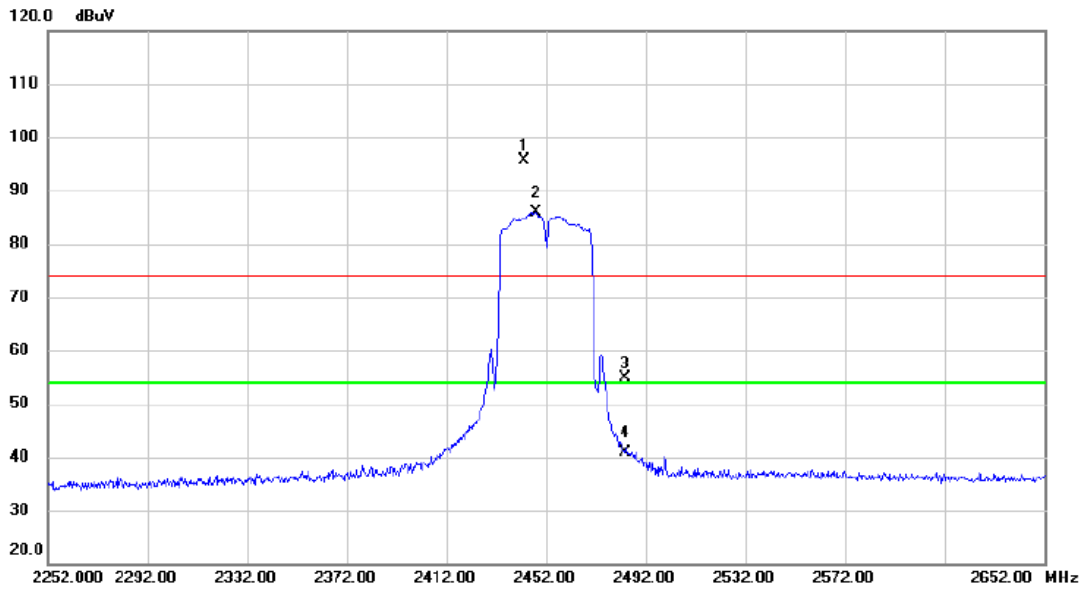

No.	Mk.	Freq. MHz	Reading Level dBuV	Correct Factor dB	Measure- ment dBuV	Limit dBuV	Margin dB	Detector	Comment
1	X	2443.000	63.19	32.55	95.74	74.00	21.74	peak	No limit
2	*	2447.800	53.29	32.56	85.85	54.00	31.85	AVG	No limit
3		2483.500	22.22	32.66	54.88	74.00	-19.12	peak	
4		2483.500	8.31	32.66	40.97	54.00	-13.03	AVG	

**REMARKS:**

(1) Measurement Value = Reading Level + Correct Factor.

(2) Margin Level = Measurement Value - Limit Value.

Test Mode: TX N-40M Mode 2452 MHz

### Horizontal

80 dBuV/m

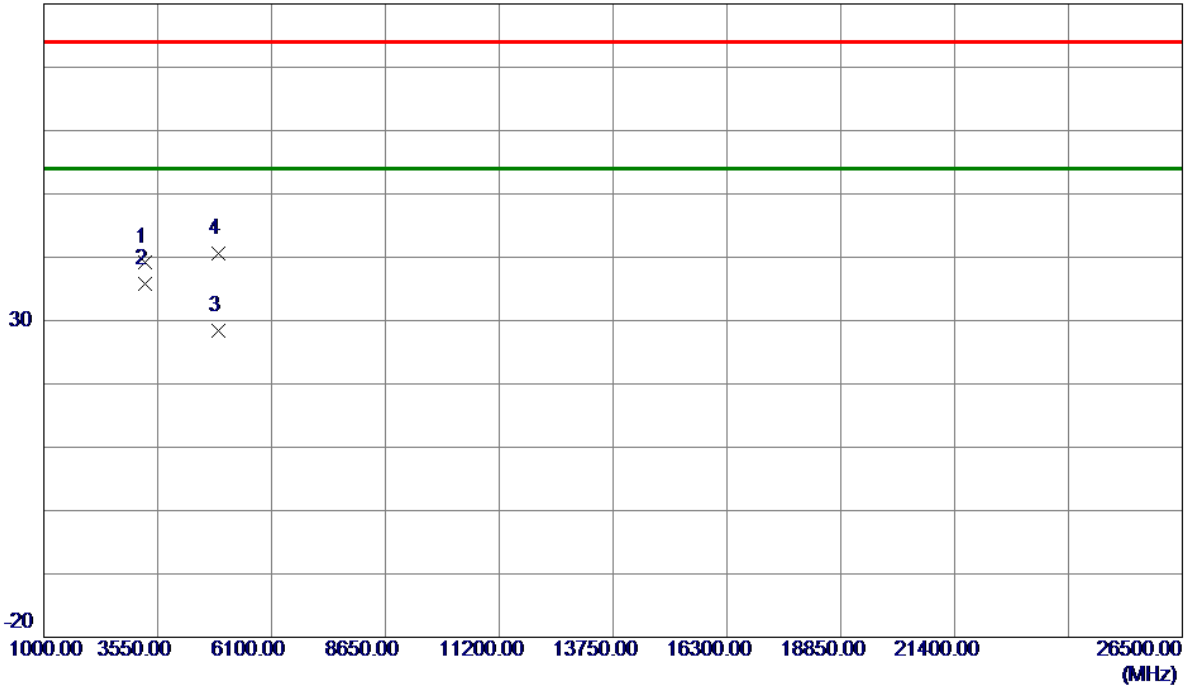

No.	Freq. MHz	Reading Level dBuV/m	Correct Factor dB	Measure ment dBuV/m	Limit dBuV/m	Margin dB	Detector	Comment
1	3269.2900	53.47	-14.20	39.27	74.00	-34.73	Peak	
2 *	3269.4100	49.94	-14.20	35.74	54.00	-18.26	AVG	
3	4903.8150	37.81	-9.39	28.42	54.00	-25.58	AVG	
4	4913.2950	49.91	-9.35	40.56	74.00	-33.44	Peak	

**REMARKS:**

- (1) Measurement Value = Reading Level + Correct Factor.
- (2) Margin Level = Measurement Value - Limit Value.