

# FCC Radio Test Report

## FCC ID: KA2IRLX1870A2

This report concerns: **Original Grant**

**Project No.** : 2005H044A  
**Equipment** : 1) AX1800 Whole Home Mesh Wi-Fi 6 Router  
2) AX1800 Whole Home Mesh Wi-Fi 6 System  
**Brand Name** : D-Link  
**Test Model** : COVR-X1870  
**Series Model** : COVR-X1872, COVR-X1873, DIR-LX1870, DIR-LX1872, DIR-LX1873  
**Applicant** : D-Link Corporation  
**Address** : 17595 Mt. Herrmann, Fountain Valley, California United State 92708  
**Manufacturer** : D-Link Corporation  
**Address** : 17595 Mt. Herrmann, Fountain Valley, California United State 92708  
**Issued Date** : Oct. 26, 2020  
**Report Version** : R01  
**Test Sample** : Engineering Sample No.: SH2020052550 for EUT; SH2020052550-1/  
SH20200609295-2 for adapter.  
**Standard(s)** : FCC Part 15, Subpart E (Section 15.407) / FCC 06-96  
FCC KDB 789033 D02 General U-NII Test Procedures New Rules v02r01  
FCC KDB 905462 D02 UNII DFS Compliance Procedures New Rules v02  
FCC KDB 905462 D03 UNII Clients Without Radar Detection New Rules v01r02

The above equipment has been tested and found compliance with the requirement of the relative standards by BTL Inc.

*Allen Wei*

Prepared by : Allen Wei

*Ryan Wang*

Approved by : Ryan Wang



Certificate # 5123.03

Add: No. 29, Jintang Road, Tangzhen Industry Park, Pudong New Area, Shanghai 201210, China

TEL: +86-021-61765666

Web: www.newbtl.com

**Declaration**

**BTL** represents to the client that testing is done in accordance with standard procedures as applicable and that test instruments used has been calibrated with standards traceable to international standard(s) and/or national standard(s).

**BTL's** reports apply only to the specific samples tested under conditions. It is manufacture's responsibility to ensure that additional production units of this model are manufactured with the identical electrical and mechanical components. **BTL** shall have no liability for any declarations, inferences or generalizations drawn by the client or others from **BTL** issued reports.

The report must not be used by the client to claim product certification, approval, or endorsement by NVLAP, NIST, A2LA, or any agency of the U.S. Government.

This report is the confidential property of the client. As a mutual protection to the clients, the public and ourselves, the test report shall not be reproduced, except in full, without our written approval.

**BTL's** laboratory quality assurance procedures are in compliance with the **ISO/IEC 17025** requirements, and accredited by the conformity assessment authorities listed in this test report.

**BTL** is not responsible for the sampling stage, so the results only apply to the sample as received.

The information, data and test plan are provided by manufacturer which may affect the validity of results, so it is manufacturer's responsibility to ensure that the apparatus meets the essential requirements of applied standards and in all the possible configurations as representative of its intended use.

**Limitation**

For the use of the authority's logo is limited unless the Test Standard(s)/Scope(s)/Item(s) mentioned in this test report is (are) included in the conformity assessment authorities acceptance respective.

Please note that the measurement uncertainty is provided for informational purpose only and are not use in determining the Pass/Fail results.

<b>Table of Contents</b>	<b>page</b>
<b>REPORT ISSUED HISTORY</b>	<b>4</b>
<b>1 . EUT INFORMATION</b>	<b>5</b>
1.1 EUT SPECIFICATION TABLE	5
1.2 TEST FACILITY	7
1.3 CONDUCTED OUTPUT POWER AND EIRP	7
<b>2 . U-NII DFS RULE REQUIREMENTS</b>	<b>9</b>
2.1 WORKING MODES AND REQUIRED TEST ITEMS	9
2.2 TEST LIMITS AND RADAR SIGNAL PARAMETERS	10
<b>3 . TEST INSTRUMENTS</b>	<b>13</b>
<b>4 . DYNAMIC FREQUENCY SELECTION (DFS) TEST</b>	<b>14</b>
4.1 DFS MEASUREMENT SYSTEM	14
4.2 CALIBRATION OF DFS DETECTION THRESHOLD LEVEL	18
4.3 DEVIATION FROM TEST STANDARD	18
<b>5 . TEST RESULTS</b>	<b>19</b>
5.1 SUMMARY OF TEST RESULT	19
5.2 TEST MODE: DEVICE OPERATING IN MASTER MODE.	20
5.3 DFS DETECTION THRESHOLD	20
5.4 CHANNEL AVAILABILITY CHECK TIME	97
5.5 CHANNEL CLOSING TRANSMISSION AND CHANNEL MOVE TIME WLAN TRAFFIC	115
5.6 STATISTICAL PERFORMANCE CHECK	120
5.7 NON- OCCUPANCY PERIOD	136
5.8 UNIFORM SPREADING	139
5.9 U-NII DETECTION BANDWIDTH	139
<b>6 . EUT TEST PHOTO</b>	<b>147</b>

**REPORT ISSUED HISTORY**

Report Version	Description	Issued Date
R00	Original Issue.	Sep.28, 2020
R01	Add the title" Statistical Performance check" in page120.	Oct. 26, 2020

## 1. EUT INFORMATION

### 1.1 EUT SPECIFICATION TABLE

Table 1: Specification of EUT

<b>Product Name</b>	1) AX1800 Whole Home Mesh Wi-Fi 6 Router 2) AX1800 Whole Home Mesh Wi-Fi 6 System
<b>Brand Name</b>	D-Link
<b>Test Model</b>	COVR-X1870
<b>Series Model</b>	COVR-X1872, COVR-X1873, DIR-LX1870, DIR-LX1872, DIR-LX1873
<b>Model Difference(s)</b>	Only the name is different, the number of packaging is different.
<b>Software Version</b>	1
<b>Hardware Version</b>	A1
<b>Operational Mode</b>	Master
<b>Operating Frequency Range</b>	UNII-2A: 5250 MHz~5350 MHz UNII-2C: 5470 MHz~5725 MHz
<b>Modulation</b>	OFDM, OFDMA

**Note:** This device was functioned as a

Master     Slave device without radar detection     Slave device with radar detection

Note:

- For a more detailed features description, please refer to the manufacturer's specifications or the user's manual.

## 2. Channel List:

IEEE 802.11a IEEE 802.11n (HT20) IEEE 802.11ac (VHT20) IEEE 802.11ax (HE20)		IEEE 802.11n (HT40) IEEE 802.11ac (VHT40) IEEE 802.11ax (HE40)		IEEE 802.11ac (VHT80) IEEE 802.11ax (HE80)	
UNII-2A		UNII-2A		UNII-2A	
Channel	Frequency (MHz)	Channel	Frequency (MHz)	Channel	Frequency (MHz)
52	5260	54	5270	58	5290
56	5280	62	5310		
60	5300				
64	5320				

IEEE 802.11a IEEE 802.11n (HT20) IEEE 802.11ac (VHT20) IEEE 802.11ax (HE20)		IEEE 802.11n (HT40) IEEE 802.11ac (VHT40) IEEE 802.11ax (HE40)		IEEE 802.11ac (VHT80) IEEE 802.11ax (HE80)	
UNII-2C		UNII-2C		UNII-2C	
Channel	Frequency (MHz)	Channel	Frequency (MHz)	Channel	Frequency (MHz)
100	5500	102	5510	106	5530
104	5520	110	5550	122	5610
108	5540	118	5590		
112	5560	126	5630		
116	5580	134	5670		
120	5600				
124	5620				
128	5640				
132	5660				
136	5680				
140	5700				

## 3. Antenna Specification:

Ant.	Brand	Model Name	Antenna Type	Connector	Gain (dBi)	Note
1	N/A	N/A	PCB	IPEX	3	N/A
2	N/A	N/A	PCB	IPEX	3	N/A

## Note:

## (1) Beamforming:

All antennas have the same gain, Directional gain =  $G_{ANT} + 10 \log(N_{ANT})$  dBi,

that is Directional gain =  $3 + 10 \log(2)$  dBi = 6.01;

So output power limit is  $24 - 6.01 + 6 = 23.99$ , the UNII-2A power density limit is

$11 - (6.01 - 6) = 10.99$ . the UNII-2C power density limit is  $24 - 6.01 + 6 = 23.99$ .

## (2) Non-Beamforming:

All antennas have the same gain, Directional gain =  $G_{ANT} + \text{Array Gain}$ ,

For power spectral density measurements,  $N_{ANT} = 2$ ,  $NSS = 1$ . So Directional gain =  $G_{ANT} +$

Array Gain =  $10 \log(N_{ANT} / NSS)$  dB =  $3 + 10 \log(2/1)$  dBi = 6.01. Then, the UNII-2A power

density limit is  $11 - (6.01 - 6) = 10.99$ . the UNII-2C power density limit is  $24 - 6.01 + 6 = 23.99$

For power measurements, Array Gain = 0 dB ( $N_{ANT} \leq 4$ ), so the Directional gain = 3.

## 1.2 TEST FACILITY

The test facilities used to collect the test data in this report is at the location of No. 29, Jintang Road, Tangzhen Industry Park, Pudong New Area, Shanghai 201210, China  
 BTL's Test Firm Registration Number for FCC: 476765  
 BTL's Designation Number for FCC: CN1241

## 1.3 CONDUCTED OUTPUT POWER AND EIRP

Table 2: The Conducted Output Power and EIRP List

Mode: TX (11a) Non- Beamforming				
Frequency Band (MHz)	Max Couducted Output Power (dBm)	Antenna Gain	Max EIRP (dBm)	Max EIRP (mW)
5250~5350	21.91	3.00	24.91	310
5470~5725	21.82	3.00	24.82	303

Mode: TX (11n 40MHz) Non- Beamforming				
Frequency Band (MHz)	Max Couducted Output Power (dBm)	Antenna Gain	Max EIRP (dBm)	Max EIRP (mW)
5250~5350	23.80	3.00	26.80	479
5470~5725	23.76	3.00	26.76	474

Mode: TX (11ac 80 MHz) Non- Beamforming				
Frequency Band (MHz)	Max Couducted Output Power (dBm)	Antenna Gain	Max EIRP (dBm)	Max EIRP (mW)
5250~5350	21.99	3.00	24.99	316
5470~5725	20.90	3.00	23.9	245

Mode: TX (11ax 20) Non- Beamforming				
Frequency Band (MHz)	Max Couducted Output Power (dBm)	Antenna Gain	Max EIRP (dBm)	Max EIRP (mW)
5250~5350	22.94	3.00	25.94	393
5470~5725	21.09	3.00	24.09	256

Mode: TX (11ax 40MHz) Non- Beamforming				
Frequency Band (MHz)	Max Couducted Output Power (dBm)	Antenna Gain	Max EIRP (dBm)	Max EIRP (mW)
5250~5350	23.78	3.00	26.78	476
5470~5725	23.16	3.00	26.16	413

Mode: TX (11ax 80 MHz) Non- Beamforming				
Frequency Band (MHz)	Max Couducted Output Power (dBm)	Antenna Gain	Max EIRP (dBm)	Max EIRP (mW)
5250~5350	22.89	3.00	25.89	388
5470~5725	21.92	3.00	24.92	310

Mode: TX (11n 20MHz) Beamforming				
Frequency Band (MHz)	Max Couducted Output Power (dBm)	Antenna Gain	Max EIRP (dBm)	Max EIRP (mW)
5250~5350	22.44	6.01	28.45	700
5470~5725	22.81	6.01	28.82	762

Mode: TX (11n 40MHz) Beamforming				
Frequency Band (MHz)	Max Couducted Output Power (dBm)	Antenna Gain	Max EIRP (dBm)	Max EIRP (mW)
5250~5350	23.38	6.01	29.39	869
5470~5725	23.62	6.01	29.63	918

Mode: TX (11ac 80 MHz) Beamforming				
Frequency Band (MHz)	Max Couducted Output Power (dBm)	Antenna Gain	Max EIRP (dBm)	Max EIRP (mW)
5250~5350	21.84	6.01	27.85	610
5470~5725	20.80	6.01	26.81	480

Mode: TX (11ax 20) Beamforming				
Frequency Band (MHz)	Max Couducted Output Power (dBm)	Antenna Gain	Max EIRP (dBm)	Max EIRP (mW)
5250~5350	22.80	6.01	28.81	760
5470~5725	21.08	6.01	27.09	512

Mode: TX (11ax 40MHz) Beamforming				
Frequency Band (MHz)	Max Couducted Output Power (dBm)	Antenna Gain	Max EIRP (dBm)	Max EIRP (mW)
5250~5350	23.66	6.01	29.67	927
5470~5725	22.99	6.01	29.00	794

Mode: TX (11ax 80 MHz) Beamforming				
Frequency Band (MHz)	Max Couducted Output Power (dBm)	Antenna Gain	Max EIRP (dBm)	Max EIRP (mW)
5250~5350	22.85	6.01	28.86	769
5470~5725	21.90	6.01	27.91	618



## 2.U-NII DFS RULE REQUIREMENTS

### 2.1 WORKING MODES AND REQUIRED TEST ITEMS

The manufacturer shall state whether the UUT is capable of operating as a Master and/or a Client. If the UUT is capable of operating in more than one operating mode then each operating mode shall be tested separately. See tables 3 and 4 for the applicability of DFS requirements for each of the operational modes.

Table 3: Applicability of DFS requirements prior to use a channel

Requirement	Operational Mode		
	Master	Client without radar detection	Client with radar detection
Non-Occupancy Period	✓	Not required	✓
DFS Detection Threshold	✓	Not required	✓
Channel Availability Check Time	✓	Not required	✓
Uniform Spreading	✓	Not required	Not required
U-NII Detection Bandwidth	✓	Not required	✓

Table 4: Applicability of DFS requirements during normal operation.

Requirement	Operational Mode		
	Master	Client without radar detection	Client with radar detection
DFS Detection Threshold	✓	Not required	✓
Channel Closing Transmission Time	✓	✓	✓
Channel Move Time	✓	✓	✓
U-NII Detection Bandwidth	✓	Not required	✓

## 2.2 TEST LIMITS AND RADAR SIGNAL PARAMETERS

### DETECTION THRESHOLD VALUES

Table 5: DFS Detection Thresholds for Master Devices and Client Devices With Radar Detection.

Maximum Transmit Power	Value (See Notes 1 and 2)
EIRP $\geq$ 200 milliwatt	-64 dBm
EIRP < 200 milliwatt and power spectral density < 10 dBm/MHz	-62 dBm
EIRP < 200 milliwatt that do not meet the power spectral density requirement	-64 dBm

**Note 1:** This is the level at the input of the receiver assuming a 0 dBi receive antenna.

**Note 2:** Throughout these test procedures an additional 1 dB has been added to the amplitude of the test transmission waveforms to account for variations in measurement equipment. This will ensure that the test signal is at or above the detection threshold level to trigger a DFS response.

**Note3:** EIRP is based on the highest antenna gain. For MIMO devices refer to KDB Publication 662911 D01.

Table 6: DFS Response Requirement Values

Parameter	Value
Non-occupancy period	Minimum 30 minutes
Channel Availability Check Time	60 seconds
Channel Move Time	10 seconds See Note 1.
Channel Closing Transmission Time	200 milliseconds + an aggregate of 60 milliseconds over remaining 10 second period. See Notes 1 and 2.
U-NII Detection Bandwidth	Minimum 100% of the UNII 99% transmission power bandwidth. See Note 3.

**Note 1:** Channel Move Time and the Channel Closing Transmission Time should be performed with Radar Type 0. The measurement timing begins at the end of the Radar Type 0 burst.

**Note 2:** The Channel Closing Transmission Time is comprised of 200 milliseconds starting at the beginning of the Channel Move Time plus any additional intermittent control signals required to facilitate a Channel move (an aggregate of 60 milliseconds) during the remainder of the 10 second period. The aggregate duration of control signals will not count quiet periods in between transmissions.

**Note 3:** During the U-NII Detection Bandwidth detection test, radar type 0 should be used. For each frequency step the minimum percentage of detection is 90 percent. Measurements are performed with no data traffic.

### PARAMETERS OF DFS TEST SIGNALS

Step intervals of 0.1 microsecond for Pulse Width, 1 microsecond for PRI, 1 MHz for chirp width and 1 for the number of pulses will be utilized for the random determination of specific test waveforms.

Table 7: Short Pulse Radar Test Waveforms.

Radar Type	Pulse Width (μsec)	PRI (μsec)	Number of Pulses	Minimum Percentage of Successful Detection	Minimum Number of Trials
0	1	1428	18	See Note 1	See Note 1
1	1	Test A: 15 unique PRI values randomly selected from the list of 23 PRI values in Table 5a	Roundup $\left\{ \left( \frac{1}{360} \right) \cdot \left( \frac{19 \cdot 10^6}{PRI_{\mu sec}} \right) \right\}$	60%	30
		Test B: 15 unique PRI values randomly selected within the range of 518-3066 μsec, with a minimum increment of 1 μsec, excluding PRI values selected in Test A			
2	1-5	150-230	23-29	60%	30
3	6-10	200-500	16-18	60%	30
4	11-20	200-500	12-16	60%	30
Aggregate (Radar Types 1-4)				80%	120
<b>Note 1:</b> Short Pulse Radar Type 0 should be used for the detection bandwidth test, channel move time, and channel closing time tests.					

A minimum of 30 unique waveforms are required for each of the Short Pulse Radar Types 2 through 4. If more than 30 waveforms are used for Short Pulse Radar Types 2 through 4, then each additional waveform must also be unique and not repeated from the previous waveforms. If more than 30 waveforms are used for Short Pulse Radar Type 1, then each additional waveform is generated with Test B and must also be unique and not repeated from the previous waveforms in Tests A or B.

Table 8: Long Pulse Radar Test Waveform

Radar Type	Pulse Width (μsec)	Chirp Width (MHz)	PRI (μsec)	Number of Pulses per Burst	Number of Bursts	Minimum Percentage of Successful Detection	Minimum Number of Trials
5	50-100	5-20	1000-2000	1-3	8-20	80%	30

The parameters for this waveform are randomly chosen (The center frequency for each of the 30 trials of the Bin 5 radar shall be randomly selected within 80% of the Occupied Bandwidth.) Thirty unique waveforms are required for the Long Pulse Radar Type waveforms. If more than 30 waveforms are used for the Long Pulse Radar Type waveforms, then each additional waveform must also be unique and not repeated from the previous waveforms.

Table 9: Frequency Hopping Radar Test Waveform

Radar Type	Pulse Width (μsec)	Chirp Width (MHz)	PRI (μsec)	Number of Pulses per Burst	Number of Bursts	Minimum Percentage of Successful Detection	Minimum Number of Trials
6	1	333	9	0.333	300	70%	30

### 3. TEST INSTRUMENTS

Table 10: Test instruments list.

Kind of Equipment	Manufacturer	Type No.	Serial No.	Calibrated until
EXA Spectrum Analyzer	Keysight	N9010A	MY56480561	Mar. 21, 2021
MXG X-Series RF Vector Signal Generator	Keysight	N5182B	MY56200484	Mar. 21, 2021
Power Divider	JUK	PD-2SF-2060	N/A	N/A
Power Divider	JUK	PD-2SF-2060	N/A	N/A
Attenuator	Solvang Technology	5.8GHz 0-65dB	STI02-0203-01	Aug. 23, 2021

Note: Calibration interval of instruments listed above is one year.

## 4. DYNAMIC FREQUENCY SELECTION (DFS) TEST

### 4.1 DFS MEASUREMENT SYSTEM

#### Test Procedure

1. Master device and client device are set up by conduction method as the following configuration.
2. The client device is connected to notebook and to access a IP address on wireless connection with the master device.
3. Then the master device is connected to another notebook to access a IP address.
4. Finally, let the two IP addresses run traffic with each other through the Run flow software "Lan test" to reach 17% channel loading as below.

#### Setup

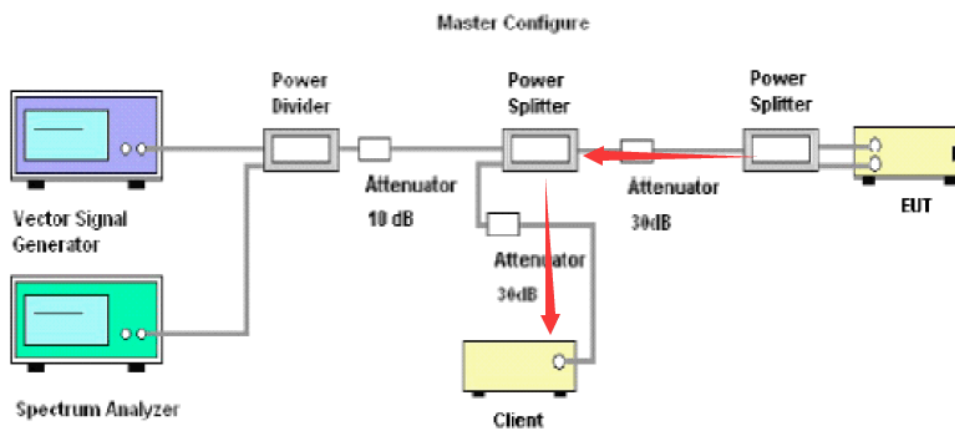

## Channel Loading

### 11ac20 MHz Mode

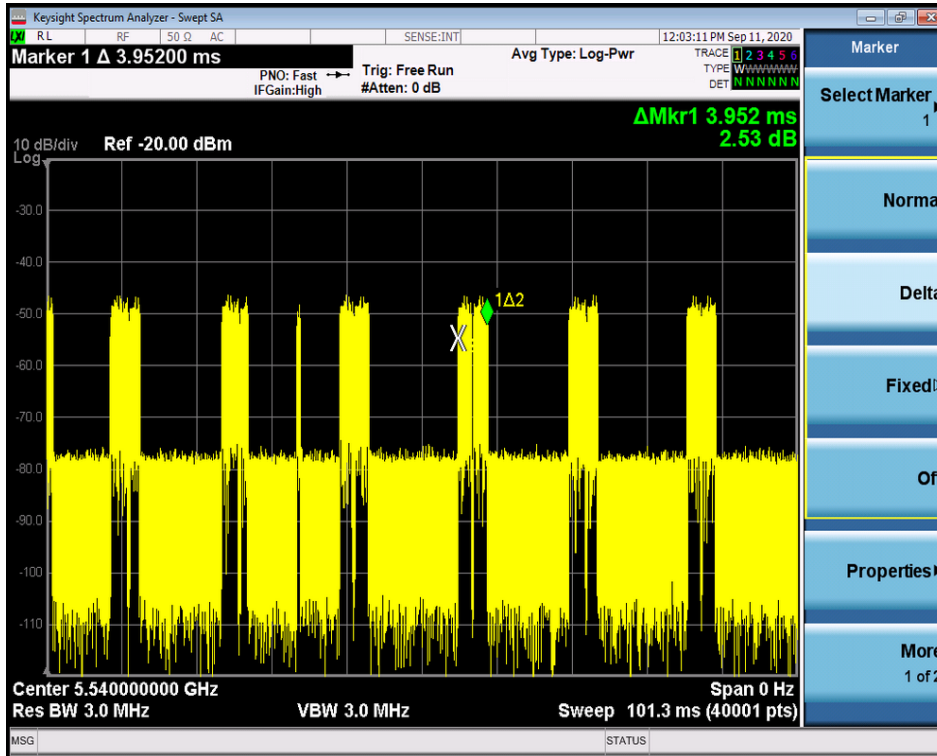

### 11ac 40MHz Mode

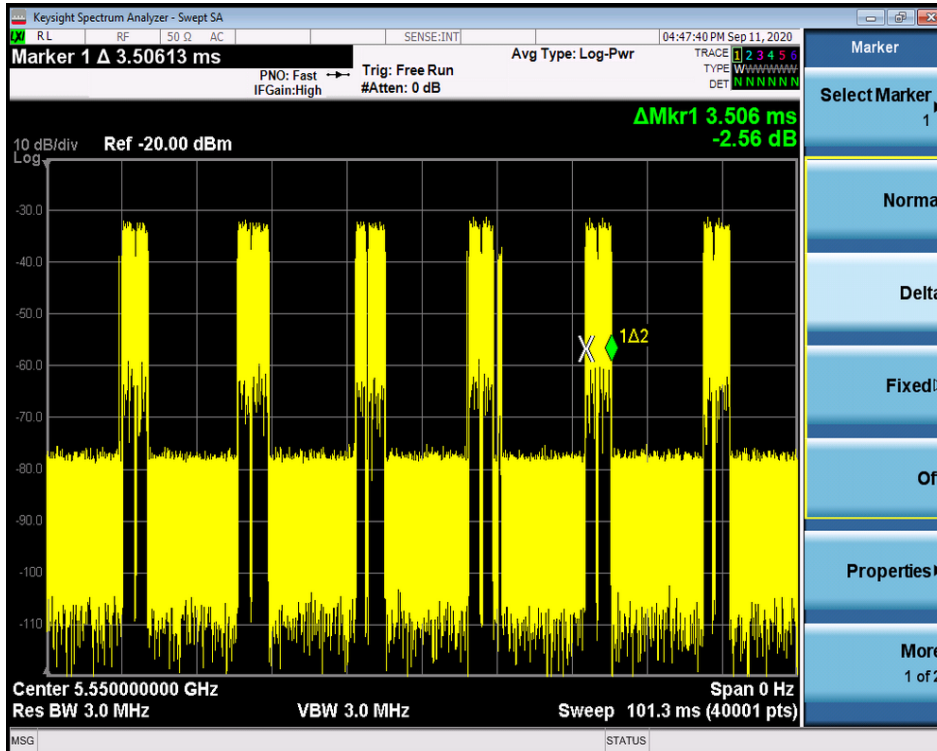

### 11ac 80MHz Mode

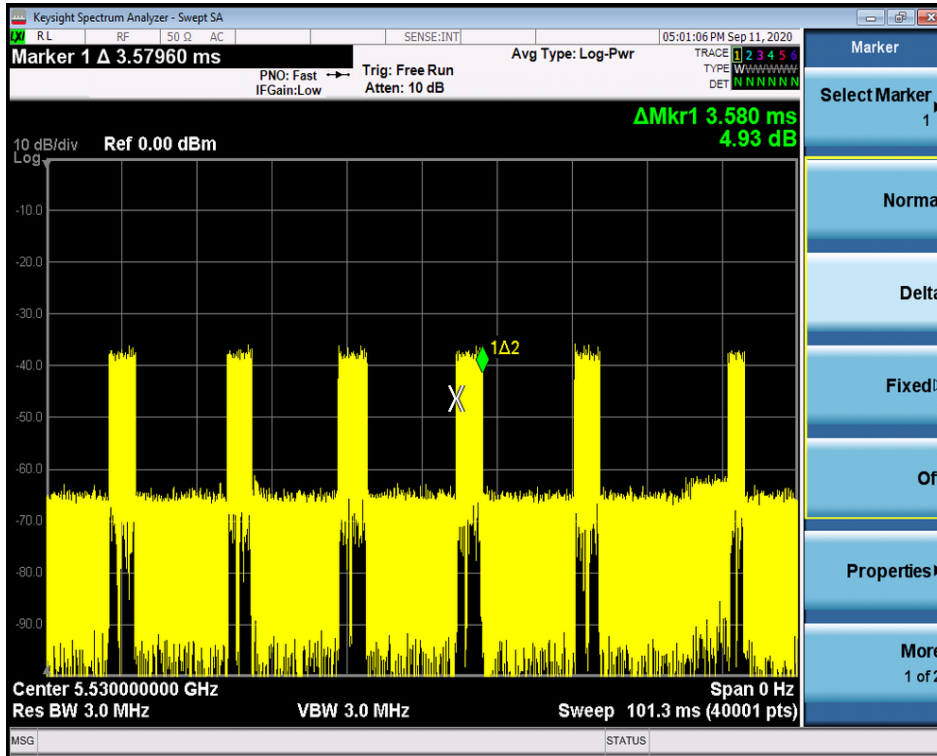

### 11ax 80MHz Mode

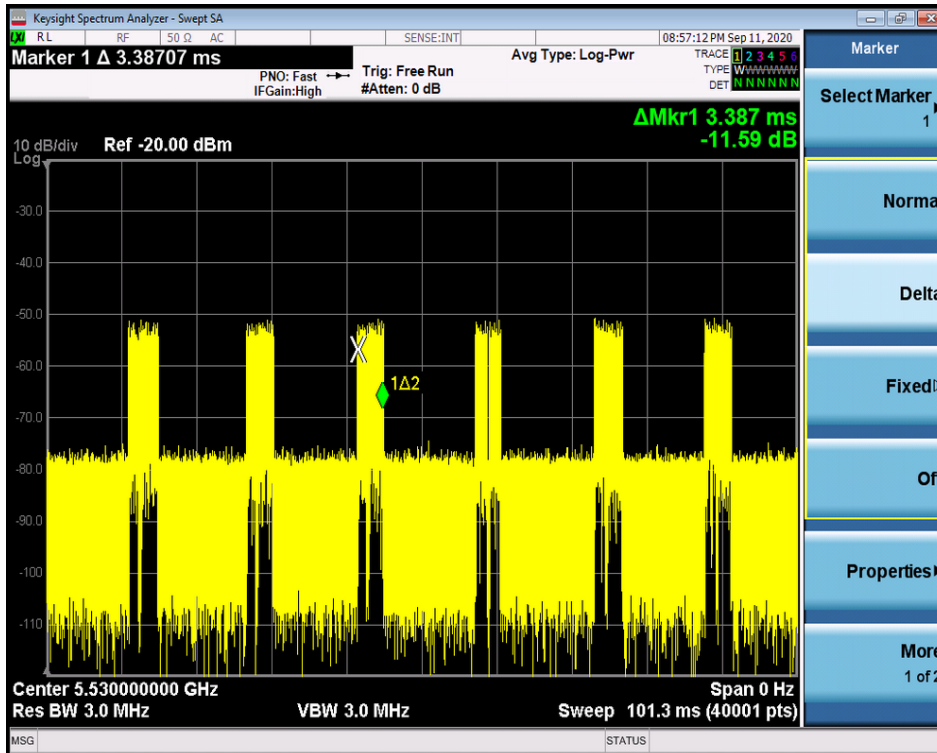

Frequency (MHz)	Marker Delta (ms)	Number	On Time (ms)	Total Time (ms)	Duty cycle (%)	Limit (%)
5540	3.952	6	23.712	101.3	23.41%	17.00
5550	3.506	6	21.036	101.3	20.77%	17.00
5530	3.58	6	21.48	101.3	21.20%	17.00



The hopping type 6 pulse parameters are fixed while the hopping sequence is based on the August 2005 NTIA Hopping Frequency List. The initial starting point randomized at run-time and each subsequent starting point is incremented by 475. Each frequency in the 100-length segment is compared to the boundaries of the EUT Detection Bandwidth and the software creates a hopping burst pattern in accordance with Section 7.4.1.3 Method #2 Simulated Frequency Hopping Radar Waveform Generating Subsystem of FCC 06-96. The frequency of the signal generator is incremented in 1 MHz steps from FL to FH for each successive trial. This incremental sequence is repeated as required to generate a minimum of 30 total trials and to maintain a uniform frequency distribution over the entire Detection Bandwidth.

The signal monitoring equipment consists of a spectrum analyzer set to display 8001 bins on the horizontal axis. The time-domain resolution is 2 msec / bin with a 16 second sweep time, meeting the 10 second short pulse reporting criteria. The aggregate ON time is calculated by multiplying the number of bins above a threshold during a particular observation period by the dwell time per bin, with the analyzer set to peak detection and max hold.

Should multiple RF ports be utilized for the Master and/or Slave devices (for example, for diversity or MIMO implementations), additional combiner/dividers are inserted between the Master Combiner/Divider and the pad connected to the Master Device (and/or between the Slave Combiner/Divider and the pad connected to the Slave Device). Additional pads are utilized such that there is one pad at each RF port on each EUT.

#### 4.2 CALIBRATION OF DFS DETECTION THRESHOLD LEVEL

A 50 ohm load is connected in place of the spectrum analyzer, and the spectrum analyzer is connected in place of the master device and the signal generator is set to CW mode. The amplitude of the signal generator is adjusted to yield a level of  $-64\text{dBm}$  as measured on the spectrum analyzer.

Without changing any of the instrument settings, the spectrum analyzer is reconnected to the Common port of the Spectrum Analyzer Combiner/Divider. Measure the amplitude and calculate the difference from  $-64\text{ dBm}$ . Adjust the Reference Level Offset of the spectrum analyzer to this difference.

The spectrum analyzer displays the level of the signal generator as received at the antenna ports of the Master Device. The interference detection threshold may be varied from the calibrated value of  $-64\text{ dBm}$  and the spectrum analyzer will still indicate the level as received by the Master Device.

Set the signal generator to produce a radar waveform, trigger a burst manually and measure the level on the spectrum analyzer. Readjust the amplitude of the signal generator as required so that the peak level of the waveform is at a displayed level equal to the required or desired interference detection threshold. Separate signal generator amplitude settings are determined as required for each radar type.

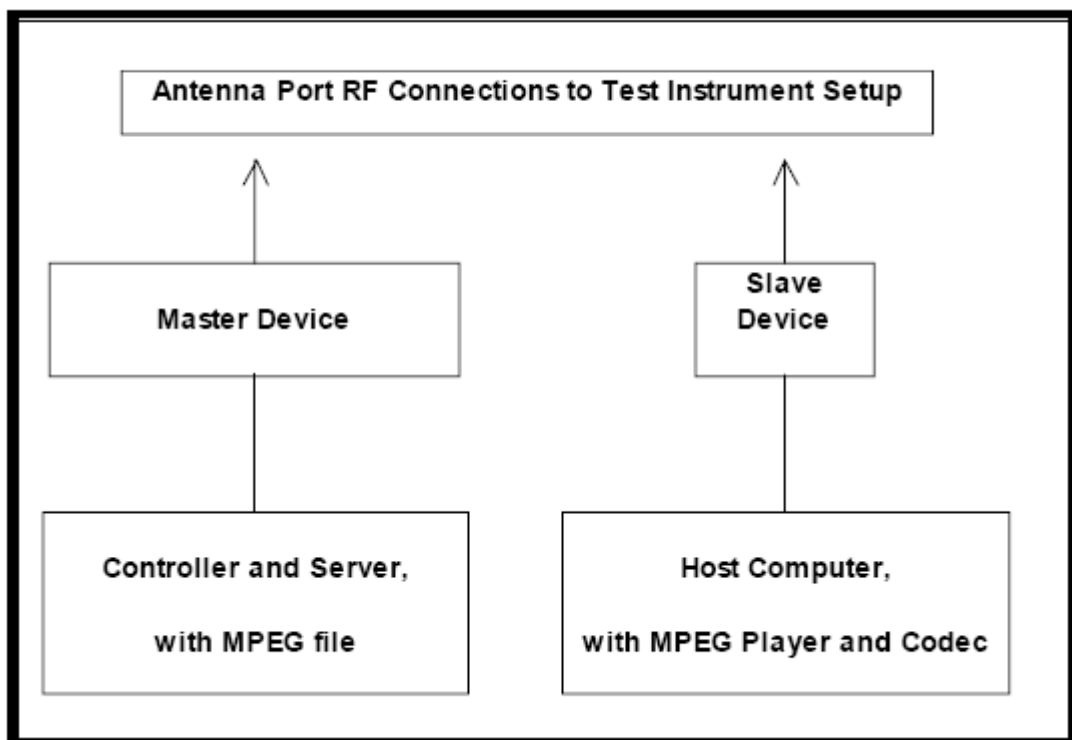

#### 4.3 DEVIATION FROM TEST STANDARD

No deviation.

## 5. TEST RESULTS

### 5.1 SUMMARY OF TEST RESULT

Clause	Test Parameter	Test Mode and Channel	Remarks	Pass/Fail
15.407	DFS Detection Threshold	11a 5540MHz	Applicable	Pass
		11n 40MHz 5550MHz		
		11ac 80MHz 5530MHz		
		11ax 20MHz 5540MHz		
		11ax 40MHz 5550MHz		
		11ax 80MHz 5530MHz		
		11ax 160MHz 5250MHz		
15.407	Channel Availability Check Time	11a 5540MHz	Applicable	Pass
		11n 40MHz 5550MHz		
		11ac 80MHz 5530MHz		
		11ax 20MHz 5540MHz		
		11ax 40MHz 5550MHz		
		11ax 80MHz 5530MHz		
		11ax 160MHz 5250MHz		
15.407	Channel Move Time	11a 5540MHz	Applicable	Pass
		11n 40MHz 5550MHz		
		11ac 80MHz 5530MHz		
		11ax 20MHz 5540MHz		
		11ax 40MHz 5550MHz		
		11ax 80MHz 5530MHz		
		11ax 160MHz 5250MHz		
15.407	Channel Closing Transmission Time	11a 5540MHz	Applicable	Pass
		11n 40MHz 5550MHz		
		11ac 80MHz 5530MHz		
		11ax 20MHz 5540MHz		
		11ax 40MHz 5550MHz		
		11ax 80MHz 5530MHz		
		11ax 160MHz 5250MHz		

15.407	Non- Occupancy Period	11a 5540MHz	Applicable	Pass
		11n 40MHz 5550MHz		
		11ac 80MHz 5530MHz		
		11ax 20MHz 5540MHz		
		11ax 40MHz 5550MHz		
		11ax 80MHz 5530MHz		
		11ax 160MHz 5250MHz		
15.407	Uniform Spreading	11a 5540MHz	Applicable	Pass
		11n 40MHz 5550MHz		
		11ac 80MHz 5530MHz		
		11ax 20MHz 5540MHz		
		11ax 40MHz 5550MHz		
		11ax 80MHz 5530MHz		
		11ax 160MHz 5250MHz		
15.407	U-NII Detection Bandwidth	11a 5540MHz	Applicable	Pass
		11n 40MHz 5550MHz		
		11ac 80MHz 5530MHz		
		11ax 20MHz 5540MHz		
		11ax 40MHz 5550MHz		
		11ax 80MHz 5530MHz		
		11ax 160MHz 5250MHz		

### 5.2 TEST MODE: DEVICE OPERATING IN MASTER MODE.

Master with injection at the Master. (Radar Test Waveforms are injected into the Master)

### 5.3 DFS DETECTION THRESHOLD

Calibration:

For a detection threshold level of -64dBm and the Master antenna gain is 3 dBi, required detection threshold is -61 dBm (= -64+3).

Note: Maximum Transmit Power is more than 200 milliwatt in this report, so detection threshold level is -64dBm (please refer to Table 5 [page 9]).

### Radarsignal 0

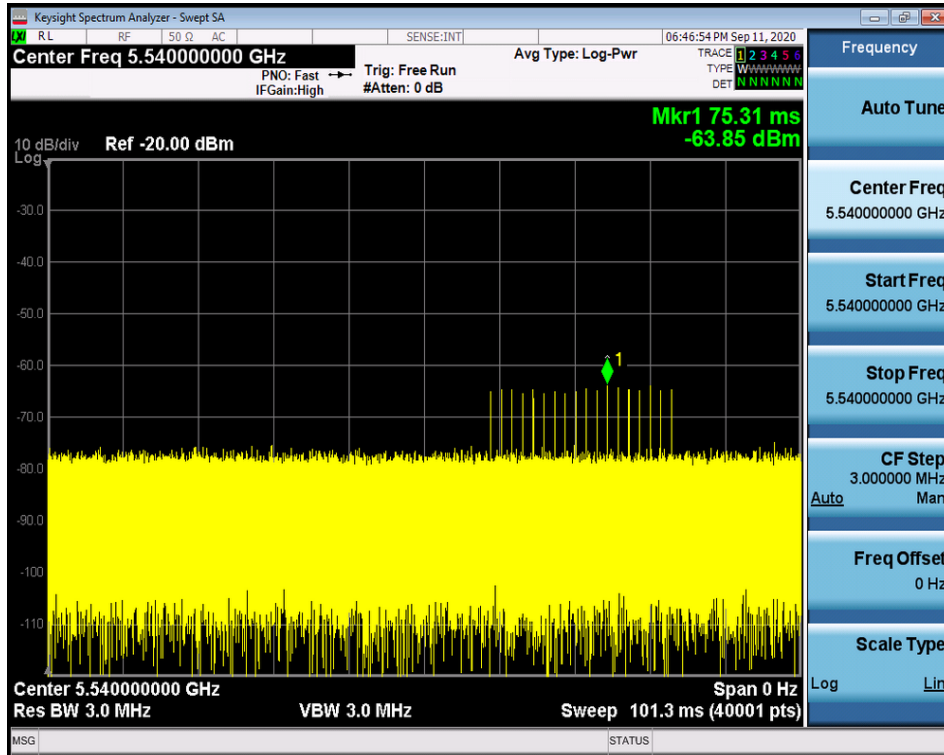

### Radarsignal 1

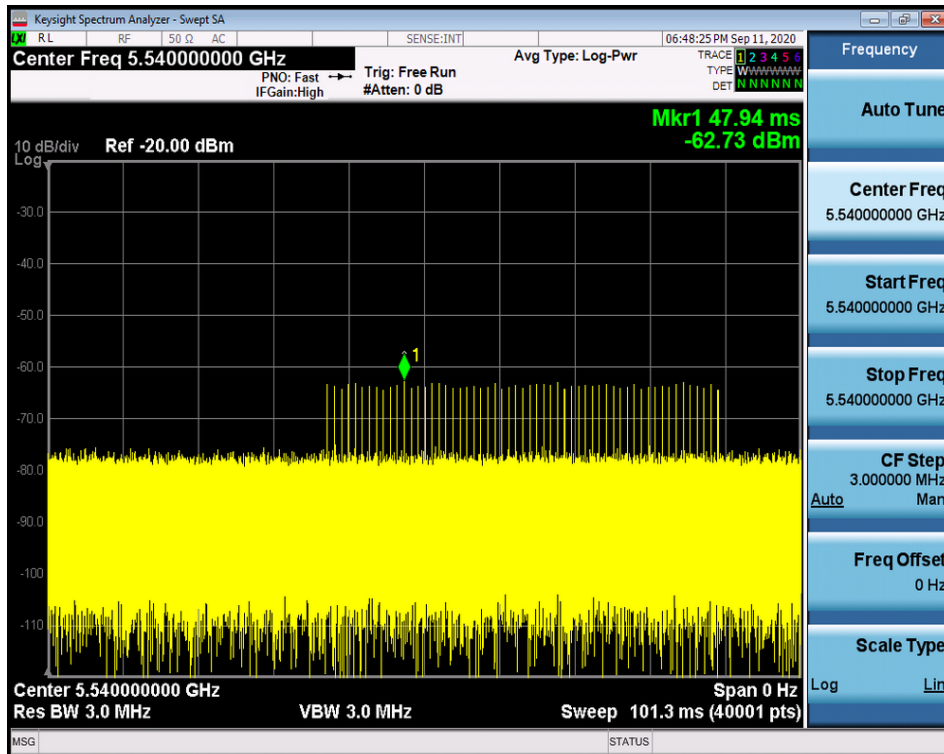

### Radarsignal 2

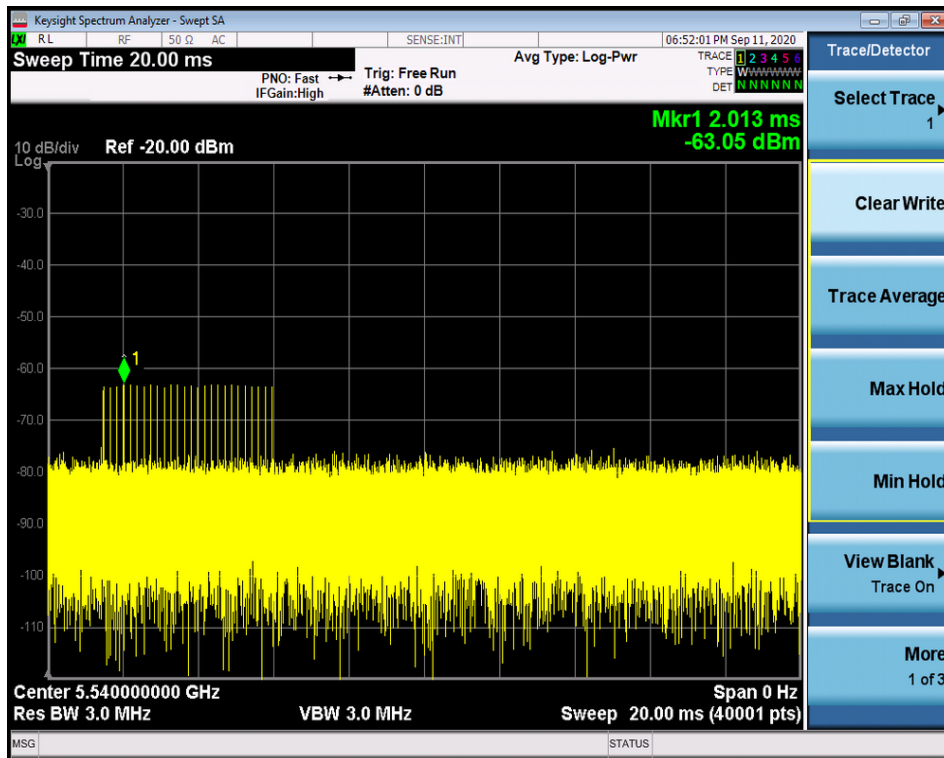

### Radarsignal 3

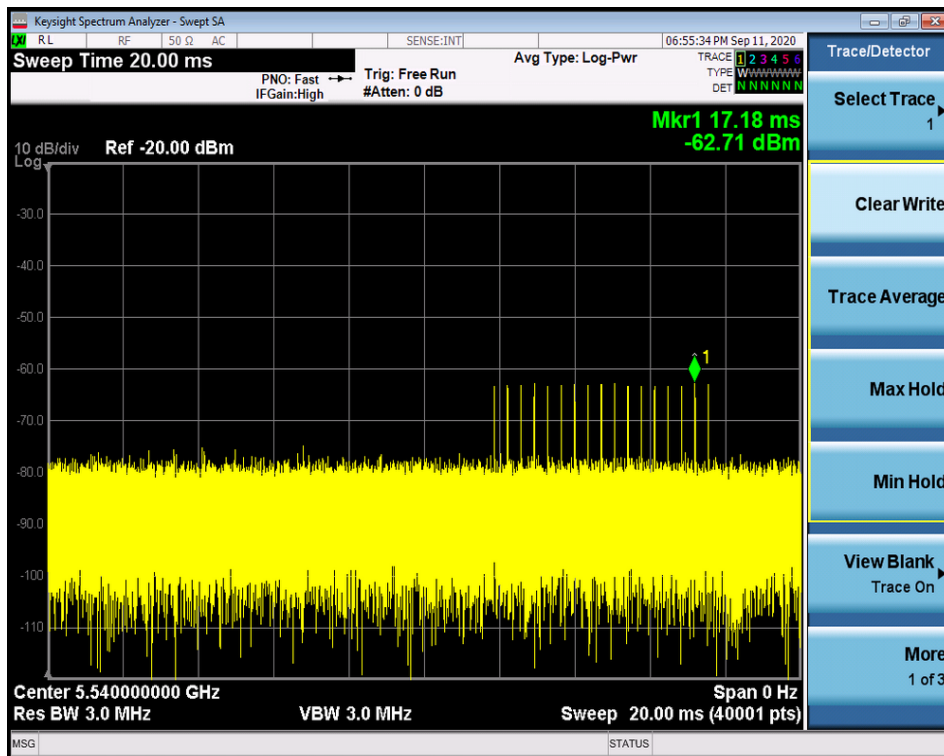

### Radarsignal 4

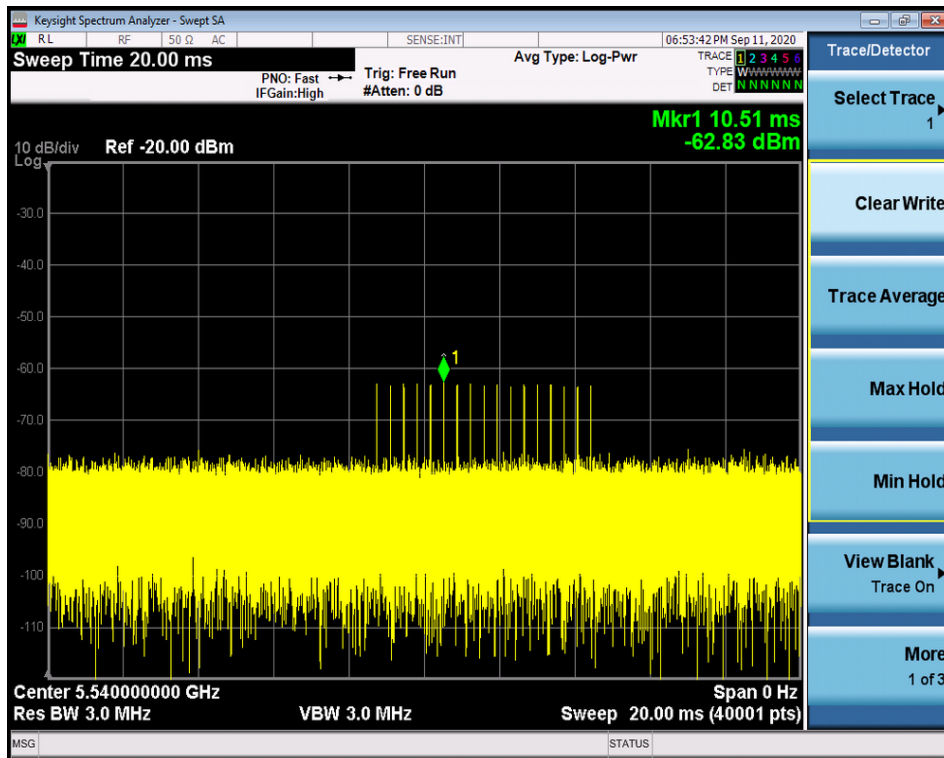

### Radarsignal 5

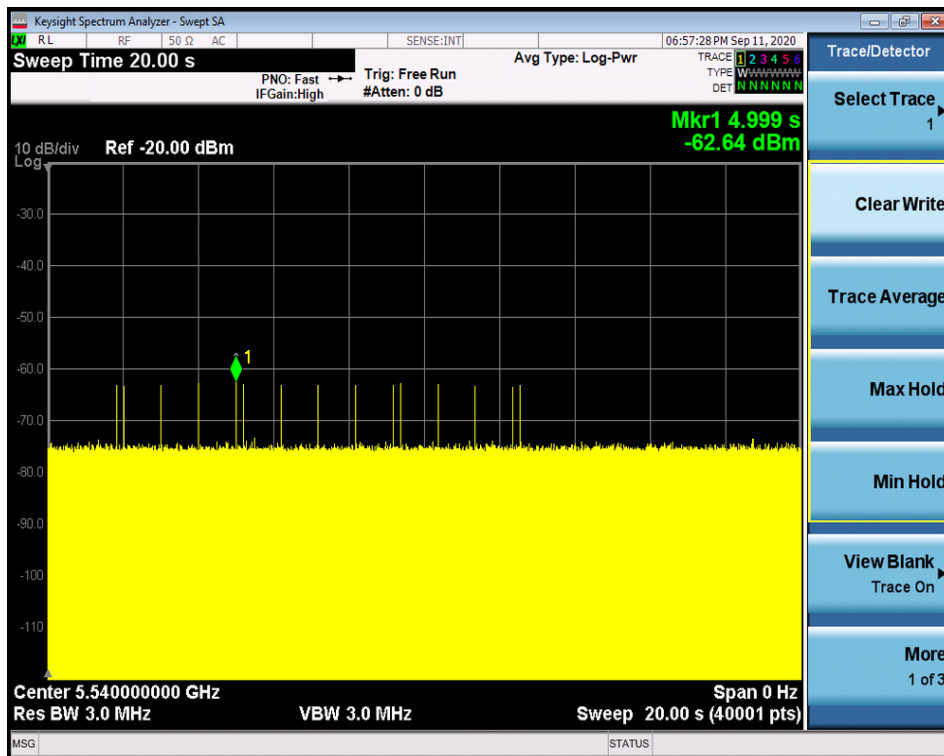

## Radarsignal 6

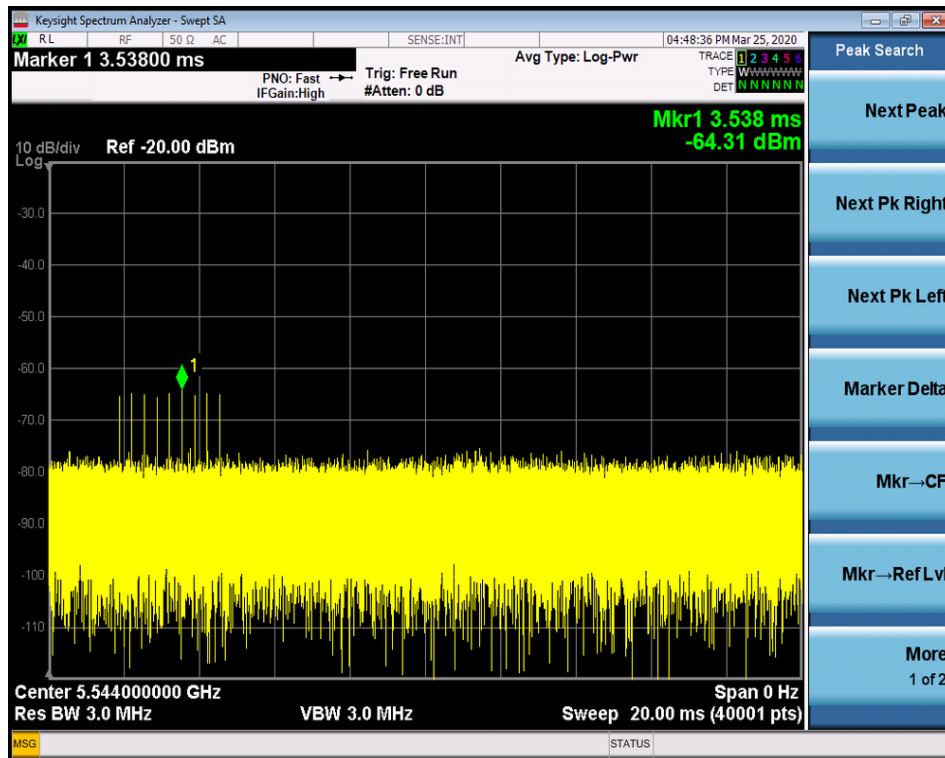



**Radar Signal 0**

Trial ID	Radar Type	Pulse Width (us)	PRI (us)	Number of Pulses	Waveform Length (us)
0	Type 0	1	1428	18	25704
1	Type 0	1	1428	18	25704
2	Type 0	1	1428	18	25704
3	Type 0	1	1428	18	25704
4	Type 0	1	1428	18	25704
5	Type 0	1	1428	18	25704
6	Type 0	1	1428	18	25704
7	Type 0	1	1428	18	25704
8	Type 0	1	1428	18	25704
9	Type 0	1	1428	18	25704
10	Type 0	1	1428	18	25704
11	Type 0	1	1428	18	25704
12	Type 0	1	1428	18	25704
13	Type 0	1	1428	18	25704
14	Type 0	1	1428	18	25704
15	Type 0	1	1428	18	25704
16	Type 0	1	1428	18	25704
17	Type 0	1	1428	18	25704
18	Type 0	1	1428	18	25704
19	Type 0	1	1428	18	25704
20	Type 0	1	1428	18	25704
21	Type 0	1	1428	18	25704
22	Type 0	1	1428	18	25704
23	Type 0	1	1428	18	25704
24	Type 0	1	1428	18	25704
25	Type 0	1	1428	18	25704
26	Type 0	1	1428	18	25704
27	Type 0	1	1428	18	25704
28	Type 0	1	1428	18	25704
29	Type 0	1	1428	18	25704

**Radar Signal 1**

Trial ID	Radar Type	Pulse Width (us)	PRI (us)	Number of Pulses	Waveform Length (us)	Pulse Repetition Frequency (Pulses Per Second)	Pulse Repetition Interval (Microseconds)
0	Type A	1	938	57	53466	1066.1	938
1	Type A	1	698	76	53048	1432.7	698
2	Type A	1	618	86	53148	1618.1	618
3	Type A	1	538	99	53262	1858.7	538
4	Type A	1	878	61	53558	1139	878
5	Type A	1	3066	18	55188	326.2	326.2
6	Type A	1	638	83	52954	1567.4	1567.4
7	Type A	1	918	58	53244	1089.3	1089.3
8	Type A	1	838	63	52794	1193.3	1193.3
9	Type A	1	858	62	53196	1165.6	1165.6
10	Type A	1	798	67	53466	1253.1	1253.1
11	Type A	1	718	74	53132	1392.8	1392.8
12	Type A	1	578	92	53176	1730.1	1730.1
13	Type A	1	598	89	53222	1672.2	1672.2
14	Type A	1	558	95	53010	1792.1	1792.1
15	Type B	1	2536	21	53256	-	-
16	Type B	1	966	55	53130	-	-
17	Type B	1	827	64	52928	-	-
18	Type B	1	2501	22	55022	-	-
19	Type B	1	2595	21	54495	-	-
20	Type B	1	1114	48	53472	-	-
21	Type B	1	1302	41	53382	-	-
22	Type B	1	3045	18	54810	-	-
23	Type B	1	1624	33	53592	-	-
24	Type B	1	2878	19	54682	-	-
25	Type B	1	1027	52	53404	-	-
26	Type B	1	2485	22	54670	-	-
27	Type B	1	1600	33	52800	-	-
28	Type B	1	1172	46	53912	-	-
29	Type B	1	1177	45	52965	-	-

**Radar Signal 2**

Trial ID	Radar Type	Pulse Width (us)	PRI (us)	Number of Pulses	Waveform Length (us)
0	Type 2	3.2	179	26	4654
1	Type 2	1.1	207	23	4761
2	Type 2	2.1	230	24	5520
3	Type 2	4.8	200	29	5800
4	Type 2	3.9	214	28	5992
5	Type 2	2.9	222	26	5772
6	Type 2	3.2	204	26	5304
7	Type 2	2.5	192	25	4800
8	Type 2	3.1	164	26	4264
9	Type 2	1.2	156	23	3588
10	Type 2	3.9	210	27	5670
11	Type 2	4.6	201	29	5829
12	Type 2	3.2	162	26	4212
13	Type 2	2.2	197	25	4925
14	Type 2	4.5	163	29	4727
15	Type 2	3	203	26	5278
16	Type 2	5	168	29	4872
17	Type 2	2.4	217	25	5425
18	Type 2	2.9	191	26	4966
19	Type 2	2.3	166	25	4150
20	Type 2	3.7	150	27	4050
21	Type 2	2.2	176	25	4400
22	Type 2	4.9	195	29	5655
23	Type 2	2.9	202	26	5252
24	Type 2	2.5	178	25	4450
25	Type 2	1.1	206	23	4738
26	Type 2	3.8	155	27	4185
27	Type 2	4.7	157	29	4553
28	Type 2	2.4	224	25	5600
29	Type 2	4.2	159	28	4452

### Radar Signal 3

Trial ID	Radar Type	Pulse Width (us)	PRI (us)	Number of Pulses	Waveform Length (us)
0	Type 3	8.2	355	17	6035
1	Type 3	6.1	487	16	7792
2	Type 3	7.1	344	16	5504
3	Type 3	9.8	288	18	5184
4	Type 3	8.9	230	18	4140
5	Type 3	7.9	432	17	7344
6	Type 3	8.2	207	17	3519
7	Type 3	7.5	443	17	7531
8	Type 3	8.1	439	17	7463
9	Type 3	6.2	223	16	3568
10	Type 3	8.9	208	18	3744
11	Type 3	9.6	463	18	8334
12	Type 3	8.2	441	17	7497
13	Type 3	7.2	323	16	5168
14	Type 3	9.5	297	18	5346
15	Type 3	8	412	17	7004
16	Type 3	10	324	18	5832
17	Type 3	7.4	271	17	4607
18	Type 3	7.9	349	17	5933
19	Type 3	7.3	409	16	6544
20	Type 3	8.7	373	18	6714
21	Type 3	7.2	254	16	4064
22	Type 3	9.9	274	18	4932
23	Type 3	7.9	278	17	4726
24	Type 3	7.5	317	17	5389
25	Type 3	6.1	260	16	4160
26	Type 3	8.8	211	18	3798
27	Type 3	9.7	272	18	4896
28	Type 3	7.4	264	17	4488
29	Type 3	9.2	284	18	5112

### Radar Signal 4

Trial ID	Radar Type	Pulse Width (us)	PRI (us)	Number of Pulses	Waveform Length (us)
0	Type 4	16	355	14	4970
1	Type 4	11.3	487	12	5844
2	Type 4	13.5	344	13	4472
3	Type 4	19.4	288	16	4608
4	Type 4	17.5	230	15	3450
5	Type 4	15.3	432	14	6048
6	Type 4	15.9	207	14	2898
7	Type 4	14.3	443	13	5759
8	Type 4	15.8	439	14	6146
9	Type 4	11.5	223	12	2676
10	Type 4	17.4	208	15	3120
11	Type 4	19	463	16	7408
12	Type 4	16	441	14	6174
13	Type 4	13.8	323	13	4199
14	Type 4	18.9	297	16	4752
15	Type 4	15.5	412	14	5768
16	Type 4	19.9	324	16	5184
17	Type 4	14.1	271	13	3523
18	Type 4	15.2	349	14	4886
19	Type 4	13.8	409	13	5317
20	Type 4	17.1	373	15	5595
21	Type 4	13.8	254	13	3302
22	Type 4	19.8	274	16	4384
23	Type 4	15.3	278	14	3892
24	Type 4	14.5	317	13	4121
25	Type 4	11.3	260	12	3120
26	Type 4	17.3	211	15	3165
27	Type 4	19.2	272	16	4352
28	Type 4	14.2	264	13	3432
29	Type 4	18.2	284	15	4260

**Radar Signal 5\_530 MHz**

Trial ID	Radar Type	Number of Bursts	Burst Period(s)	Wave from Length (s)	Center Frequency(GHz)	-		
0	Type 5	15	0.8	12	5.5	-		
	Burst ID	Pulse Width (us)	PRI (us)	Chirp Width(MHz)	Number of Pulses per Burst	PRI-1 (us)	PRI-2 (us)	PRI-3 (us)
	0	636185	77.8	13	2	1665	1477	-
	1	32674	51.9	13	1	1074	-	-
	2	226294	63.8	13	1	1584	-	-
	3	417976	96.6	13	3	1682	1786	1843
	4	611152	85.9	13	3	1795	1215	1729
	5	8789	73.7	13	2	1198	1549	-
	6	201917	77.2	13	2	1837	1819	-
	7	395530	68.4	13	2	1587	1114	-
	8	588564	76.7	13	2	2000	1155	-
	9	783794	53.2	13	1	1147	-	-
	10	177933	85.7	13	3	1433	1695	1394
	11	370624	94.3	13	3	1670	1426	1935
	12	564893	77.6	13	2	1294	1671	-
	13	759583	65.7	13	1	1512	-	-
	14	154262	93.5	13	3	1444	1130	1468
1	Type 5	8	1.5	12	5.5			
	Burst ID	Burst Offset (us)	Pulse Width (us)	Chirp Width (MHz)	Number of Pulses per Burst	PRI-1 (us)	PRI-2 (us)	PRI-3 (us)
	0	653020	75	5	2	1880	1527	-
	1	1015643	99.4	5	3	1401	1262	1257
	2	1379398	67.4	5	2	1531	1403	-
	3	245489	73.6	5	2	1449	1041	-
	4	609113	65.9	5	1	1432	-	-
	5	970852	83.8	5	3	1356	1292	1419
	6	1335913	65.5	5	1	1543	-	-
	7	200406	98.6	5	3	1548	1796	1728

Trial ID	Radar Type	Number of Bursts	Burst Period(s)	Wave from Length (s)	Center Frequency(GHz)	-		
2	Type 5	11	1.090909	12	5.5			
	Burst ID	Burst Offset (us)	Pulse Width (us)	Chirp Width (MHz)	Number of Pulses per Burst	PRI-1 (us)	PRI-2 (us)	PRI-3 (us)
	0	409565	73.8	9	2	1806	1538	-
	1	673692	69.5	9	2	1117	1649	-
	2	938562	51.9	9	1	1651	-	-
	3	113209	84.6	9	3	1976	1032	1271
	4	376726	95.4	9	3	1060	1903	1388
	5	641212	68	9	2	1368	1351	-
	6	903714	89.6	9	3	1338	1514	1573
	7	80863	81.9	9	2	1022	1689	-
	8	344067	88.3	9	3	1810	1330	1838
	9	609331	53.7	9	1	1597	-	-
	10	871542	91.3	9	3	1961	1106	1001
3	Type 5	20	0.6	12	5.5			
	Burst ID	Burst Offset (us)	Pulse Width (us)	Chirp Width (MHz)	Number of Pulses per Burst	PRI-1 (us)	PRI-2 (us)	PRI-3 (us)
	0	26541	68.1	19	2	1339	1355	-
	1	171821	58.7	19	1	1251	-	-
	2	316229	75.3	19	2	1136	1640	-
	3	461864	56.4	19	1	1753	-	-
	4	8677	99.7	19	3	1196	1708	1159
	5	153995	57.7	19	1	1013	-	-
	6	299238	59.5	19	1	1072	-	-
	7	443177	80	19	2	1482	1369	-
	8	587671	82	19	2	1993	1197	-
	9	135674	82.8	19	2	1883	1005	-
	10	279928	88	19	3	1061	1928	1101
	11	424279	93.2	19	3	1207	1907	1223
	12	570132	70.4	19	2	1526	1360	-
	13	117439	95.3	19	3	1171	1955	1775
	14	262502	81.9	19	2	1690	1545	-
	15	406573	98.5	19	3	1975	1169	1062
	16	553328	65	19	1	1767	-	-
	17	99799	85.4	19	3	1011	1637	1425
	18	244095	91.6	19	3	1878	1445	1325
	19	390012	67.3	19	2	1091	1218	-

Trial ID	Radar Type	Number of Bursts	Burst Period(s)	Wave from Length (s)	Center Frequency(GHz)	-		
4	Type 5	17	0.705882	12	5.5			
	Burst ID	Burst Offset (us)	Pulse Width (us)	Chirp Width (MHz)	Number of Pulses per Burst	PRI-1 (us)	PRI-2 (us)	PRI-3 (us)
	0	629614	67.9	16	2	1320	1133	-
	1	96856	62.3	16	1	1957	-	-
	2	267719	53.3	16	1	1592	-	-
	3	436784	90	16	3	1900	1153	1346
	4	608289	77.1	16	2	1166	1646	-
	5	75610	83.9	16	3	1278	1232	1459
	6	245638	89.1	16	3	1240	1384	1939
	7	416355	81.8	16	2	1833	1676	-
	8	588736	50.3	16	1	1075	-	-
	9	54571	87.1	16	3	1116	1996	1756
	10	225175	71.3	16	2	1225	1815	-
	11	394825	97.5	16	3	1884	1465	1132
	12	565361	90.6	16	3	1561	1040	1354
	13	33643	86.3	16	3	1596	1183	1792
	14	203957	97.6	16	3	1365	1073	1361
	15	373812	84.7	16	3	1021	1718	1854
	16	544060	99.7	16	3	1150	1244	1988



Trial ID	Radar Type	Number of Bursts	Burst Period(s)	Wave from Length (s)	Center Frequency(GHz)	-		
5	Type 5	14	0.857143	12	5.5			
	Burst ID	Burst Offset (us)	Pulse Width (us)	Chirp Width (MHz)	Number of Pulses per Burst	PRI-1 (us)	PRI-2 (us)	PRI-3 (us)
	0	15438	92.9	12	3	1085	1564	1407
	1	222486	67.7	12	2	1744	1747	-
	2	430731	65.8	12	1	1092	-	-
	3	637784	56.3	12	1	1851	-	-
	4	845342	53.7	12	1	1727	-	-
	5	196720	83.5	12	3	1679	1930	1025
	6	404955	65.8	12	1	1519	-	-
	7	610711	85.9	12	3	1134	1034	1808
	8	818057	76.3	12	2	1606	1926	-
	9	171459	81.5	12	2	1891	1714	-
	10	377969	89.4	12	3	1310	1594	1827
	11	586875	63.4	12	1	1568	-	-
	12	792834	69.6	12	2	1307	1925	-
	13	146044	74.5	12	2	1264	1846	-

Trial ID	Radar Type	Number of Bursts	Burst Period(s)	Wave from Length (s)	Center Frequency(GHz)	-		
6	Type 5	15	0.8	12	5.5			
	Burst ID	Burst Offset (us)	Pulse Width (us)	Chirp Width (MHz)	Number of Pulses per Burst	PRI-1 (us)	PRI-2 (us)	PRI-3 (us)
	0	329022	96.6	13	3	1182	1609	1581
	1	521718	96.7	13	3	1829	1799	1154
	2	714222	86.5	13	3	1923	1396	1865
	3	112450	73.3	13	2	1908	1318	-
	4	306283	55.8	13	1	1688	-	-
	5	500239	55.4	13	1	1145	-	-
	6	690932	85.3	13	3	1336	1504	1820
	7	88645	79.4	13	2	1344	1893	-
	8	282508	65.7	13	1	1476	-	-
	9	475842	68.6	13	2	1008	1028	-
	10	667887	77.7	13	2	1972	1835	-
	11	64845	79.6	13	2	1882	1331	-
	12	257755	94.9	13	3	1830	1070	1349
	13	452335	61.4	13	1	1451	-	-
	14	643395	90.6	13	3	1233	1562	1887
7	Type 5	12	1	12	5.5			
	Burst ID	Burst Offset (us)	Pulse Width (us)	Chirp Width (MHz)	Number of Pulses per Burst	PRI-1 (us)	PRI-2 (us)	PRI-3 (us)
	0	51446	52.6	10	1	1210	-	-
	1	292696	84.1	10	3	1314	1725	1529
	2	533989	97.7	10	3	1139	1868	1805
	3	775564	97.3	10	3	1341	1446	1755
	4	21542	98.8	10	3	1544	1386	1302
	5	263385	72.2	10	2	1771	1184	-
	6	505581	67.6	10	2	1175	1027	-
	7	747058	75.7	10	2	1026	1871	-
	8	989976	60.9	10	1	1798	-	-
	9	234024	64.2	10	1	1138	-	-
	10	475207	78.8	10	2	1784	1604	-
	11	715825	87.5	10	3	1511	1712	1683

Trial ID	Radar Type	Number of Bursts	Burst Period(s)	Wave from Length (s)	Center Frequency(GHz)	-		
8	Type 5	14	0.857143	12	5.5			
	Burst ID	Burst Offset (us)	Pulse Width (us)	Chirp Width (MHz)	Number of Pulses per Burst	PRI-1 (us)	PRI-2 (us)	PRI-3 (us)
	0	823112	54.1	13	1	1415	-	-
	1	174965	50.7	13	1	1221	-	-
	2	382216	52.3	13	1	1974	-	-
	3	587395	99.8	13	3	1558	1696	1949
	4	796897	68.4	13	2	1014	1099	-
	5	149042	80.8	13	2	1736	1505	-
	6	356750	62.5	13	1	1778	-	-
	7	563824	74.8	13	2	1149	1204	-
	8	772314	50.8	13	1	1049	-	-
	9	123796	54	13	1	1417	-	-
	10	331215	63	13	1	1730	-	-
	11	537402	91.8	13	3	1143	1270	1347
	12	744805	79.3	13	2	1274	1992	-
	13	98172	64.3	13	1	1937	-	-
9	Type 5	8	1.5	12	5.5			
	Burst ID	Burst Offset (us)	Pulse Width (us)	Chirp Width (MHz)	Number of Pulses per Burst	PRI-1 (us)	PRI-2 (us)	PRI-3 (us)
	0	535615	63.4	6	1	1043	-	-
	1	898668	52	6	1	1863	-	-
	2	1259235	97.2	6	3	1973	1605	1583
	3	127106	78.7	6	2	1466	1743	-
	4	490358	74.2	6	2	1280	1219	-
	5	852409	88.7	6	3	1293	1934	1273
	6	1217152	54.3	6	1	1991	-	-
	7	82296	95.4	6	3	1580	1555	1791

Trial ID	Radar Type	Number of Bursts	Burst Period(s)	Wave from Length (s)	Center Frequency(GHz)	-		
10	Type 5	17	0.705882	12	5.5039			
	Burst ID	Burst Offset (us)	Pulse Width (us)	Chirp Width (MHz)	Number of Pulses per Burst	PRI-1 (us)	PRI-2 (us)	PRI-3 (us)
	0	209249	73.7	16	2	1208	1497	-
	1	378386	97.4	16	3	1942	1754	1613
	2	548411	91.7	16	3	1999	1702	1462
	3	17733	66.2	16	1	1393	-	-
	4	187952	70.8	16	2	1968	1821	-
	5	359277	52.3	16	1	1740	-	-
	6	528886	78.9	16	2	1308	1984	-
	7	700166	70.9	16	2	1050	1358	-
	8	167197	75.6	16	2	1437	1430	-
	9	338262	59.1	16	1	1697	-	-
	10	508324	77	16	2	1397	1304	-
	11	678689	67.9	16	2	1803	1083	-
	12	146031	81.2	16	2	1720	1932	-
	13	316923	78.7	16	2	1247	1121	-
	14	488056	63.3	16	1	1634	-	-
	15	657326	68.9	16	2	1849	1423	-
	16	125509	59.3	16	1	1093	-	-