

FCC Radio Test Report

FCC ID: KA2IRLX1870A2

This report concerns: Original Grant

Project No. : 2005H044A
Equipment : 1) AX1800 Whole Home Mesh Wi-Fi 6 Router
2) AX1800 Whole Home Mesh Wi-Fi 6 System
Brand Name : D-Link
Test Model : COVR-X1870
Series Model : COVR-X1872, COVR-X1873, DIR-LX1870, DIR-LX1872, DIR-LX1873
Applicant : D-Link Corporation
Address : 17595 Mt. Herrmann, Fountain Valley, California United State 92708
Manufacturer : D-Link Corporation
Address : 17595 Mt. Herrmann, Fountain Valley, California United State 92708
Date of Receipt : Jul. 31, 2020
Date of Test : Jul. 31, 2020~Sep. 4, 2020
Issued Date : Sep.28, 2020
Report Version : R00
Test Sample : Engineering Sample No.: SH2020052550,
SH2020052550-1, SH20200609295-2
Standard(s) : FCC Part15, Subpart E(15.407)
ANSI C63.10-2013
FCC KDB 789033 D02 General UNII Test Procedures New Rules
v02r01
FCC KDB 662911 D01 Multiple Transmitter Output v02r01

The above equipment has been tested and found compliance with the requirement of the relative standards by BTL Inc.

Allen Wei

Prepared by : Allen Wei

Ryan Wang

Approved by : Ryan Wang



Certificate # 5123. 03

Add: No. 29, Jintang Road, Tangzhen Industry Park, Pudong New Area, Shanghai 201210, China

TEL: +86-021-61765666

Web: www.newbtl.com

Declaration

BTL represents to the client that testing is done in accordance with standard procedures as applicable and that test instruments used has been calibrated with standards traceable to international standard(s) and/or national standard(s).

BTL's reports apply only to the specific samples tested under conditions. It is manufacture's responsibility to ensure that additional production units of this model are manufactured with the identical electrical and mechanical components. **BTL** shall have no liability for any declarations, inferences or generalizations drawn by the client or others from **BTL** issued reports.

The report must not be used by the client to claim product certification, approval, or endorsement by NVLAP, NIST, A2LA, or any agency of the U.S. Government.

This report is the confidential property of the client. As a mutual protection to the clients, the public and ourselves, the test report shall not be reproduced, except in full, without our written approval.

BTL's laboratory quality assurance procedures are in compliance with the **ISO/IEC 17025** requirements, and accredited by the conformity assessment authorities listed in this test report.

BTL is not responsible for the sampling stage, so the results only apply to the sample as received.

The information, data and test plan are provided by manufacturer which may affect the validity of results, so it is manufacturer's responsibility to ensure that the apparatus meets the essential requirements of applied standards and in all the possible configurations as representative of its intended use.

Limitation

For the use of the authority's logo is limited unless the Test Standard(s)/Scope(s)/Item(s) mentioned in this test report is (are) included in the conformity assessment authorities acceptance respective.

Table of Contents	Page
REPORT ISSUED HISTORY	5
1 . SUMMARY OF TEST RESULTS	6
1.1 TEST FACILITY	7
1.2 MEASUREMENT UNCERTAINTY	7
1.3 TEST ENVIRONMENT CONDITIONS	7
2 . GENERAL INFORMATION	8
2.1 GENERAL DESCRIPTION OF EUT	8
2.2 TEST MODES	11
2.3 PARAMETERS OF TEST SOFTWARE	12
2.4 DUTY CYCLE	20
2.5 BLOCK DIAGRAM SHOWING THE CONFIGURATION OF SYSTEM TESTED	21
2.6 SUPPORT UNITS	21
3 . AC POWER LINE CONDUCTED EMISSIONS TEST	22
3.1 LIMIT	22
3.2 TEST PROCEDURE	22
3.3 DEVIATION FROM TEST STANDARD	22
3.4 TEST SETUP	23
3.5 EUT OPERATION CONDITIONS	23
3.6 TEST RESULTS	23
4 . RADIATED EMISSIONS TEST	24
4.1 LIMIT	24
4.2 TEST PROCEDURE	25
4.3 DEVIATION FROM TEST STANDARD	25
4.4 TEST SETUP	26
4.5 EUT OPERATION CONDITIONS	28
4.6 TEST RESULTS - 30 MHz TO 1000 MHz	28
4.7 TEST RESULTS - ABOVE 1000 MHz	28
5 . BANDWIDTH TEST	29
5.1 LIMIT	29
5.2 TEST PROCEDURE	29
5.3 TEST PROCEDURE	29
5.4 TEST SETUP	30
5.5 EUT OPERATION CONDITIONS	30

Table of Contents	Page
5.6 TEST RESULTS	30
6 . MAXIMUM OUTPUT POWER TEST	31
6.1 LIMIT	31
6.2 TEST PROCEDURE	31
6.3 DEVIATION FROM STANDARD	31
6.4 TEST SETUP	31
6.5 EUT OPERATION CONDITIONS	31
6.6 TEST RESULTS	31
7 . POWER SPECTRAL DENSITY TEST	32
7.1 LIMIT	32
7.2 TEST PROCEDURE	32
7.3 DEVIATION FROM STANDARD	32
7.4 TEST SETUP	33
7.5 EUT OPERATION CONDITIONS	33
7.6 TEST RESULTS	33
8 . MEASUREMENT INSTRUMENTS LIST	34
9 . EUT TEST PHOTOS	36
APPENDIX A - AC POWER LINE CONDUCTED EMISSIONS	39
APPENDIX B - RADIATED EMISSION - 30 MHZ TO 1 GHZ	42
APPENDIX C - RADIATED EMISSION - ABOVE 1000 MHZ	45
APPENDIX D - BANDWIDTH	174
APPENDIX E - CONDUCTED OUTPUT POWER	197
APPENDIX F - POWER SPECTRAL DENSITY	230

REPORT ISSUED HISTORY

Report Version	Description	Issued Date
R00	Original Issue.	Sep.28, 2020

1. SUMMARY OF TEST RESULTS

Test procedures according to the technical standard(s):

FCC Part15, Subpart E(15.407)				
Standard(s) Section	Test Item	Test Result	Judgement	Remark
15.207 15.407(b)	AC Power Line Conducted Emissions	APPENDIX A	PASS	-----
15.407(b) 15.205(a) 15.209(a)	Radiated Emissions	APPENDIX B APPENDIX C APPENDIX D	PASS	-----
15.407(a) 15.407(e)	Spectrum Bandwidth	APPENDIX E	PASS	-----
15.407(a)	Maximum Output Power	APPENDIX F	PASS	-----
15.407(a)	Power Spectral Density	APPENDIX G	PASS	-----
15.407(g)	Frequency Stability	APPENDIX H	PASS	-----
15.203	Antenna Requirements	-----	PASS	-----
15.407(c)	Automatically Discontinue Transmission	-----	PASS	NOTE (2)

Note:

- (1) "N/A" denotes test is not applicable in this test report.
- (2) During no any information transmission, the EUT can automatically discontinue transmission and become standby mode for power saving. the EUT can detect the controlling signal of ACK message transmitting from remote device and verify whether it shall resend or discontinue transmission.

1.1 TEST FACILITY

The test facilities used to collect the test data in this report is at the location of No. 29, Jintang Road, Tangzhen Industry Park, Pudong New Area, Shanghai 201210, China
 BTL's Test Firm Registration Number for FCC: 476765
 BTL's Designation Number for FCC: CN1241

1.2 MEASUREMENT UNCERTAINTY

ISO/IEC 17025 requires that an estimate of the measurement uncertainties associated with the emissions test results be included in the report. The measurement uncertainties given below are based on a 95% confidence level (based on a coverage factor (k=2))
 The BTL measurement uncertainty as below table:

A. AC power line conducted emissions test:

Test Site	Method	Measurement Frequency Range	U, (dB)
SH-C01	CISPR	150 kHz ~ 30 MHz	± 2.26

B. Radiated emissions test:

Test Site	Method	Measurement Frequency Range	Ant. H / V	U, (dB)
SH-CB01	CISPR	9 KHz~30 MHz	V	3.79
		9 KHz~30 MHz	H	3.57
		30 MHz~200 MHz	V	4.04
		30 MHz~200 MHz	H	3.76
		200 MHz~1,000 MHz	V	4.24
		200 MHz~1,000 MHz	H	3.84
		1 GHz~18 GHz	V	4.46
		1 GHz~18 GHz	H	4.40
		18 GHz~40 GHz	V	3.95
		18 GHz~40 GHz	H	3.95

Note: Unless specifically mentioned, the uncertainty of measurement has not been taken into account to declare the compliance or non-compliance to the specification.

1.3 TEST ENVIRONMENT CONDITIONS

Test Item	Temperature	Humidity	Test Voltage	Tested By
AC Power Line Conducted Emissions	21°C	40%	AC 120V/60Hz	Forest
Radiated Emissions-30 MHz to 1GHz	21°C	40%	AC 120V/60Hz	Forest
Radiated Emissions-Above 1000 MHz	21°C	40%	AC 120V/60Hz	Forest
Spectrum Bandwidth	24°C	56%	AC 120V/60Hz	Forest
Maximum Output Power	24°C	56%	AC 120V/60Hz	Forest
Power Spectral Density	24°C	56%	AC 120V/60Hz	Forest

2. GENERAL INFORMATION

2.1 GENERAL DESCRIPTION OF EUT

Equipment	1) AX1800 Whole Home Mesh Wi-Fi 6 Router 2) AX1800 Whole Home Mesh Wi-Fi 6 System
Brand Name	D-Link
Test Model	COVR-X1870
Series Model	COVR-X1872, COVR-X1873, DIR-LX1870, DIR-LX1872, DIR-LX1873
Model Difference(s)	Only the name is different, the number of packaging is different.
Software Version	1
Hardware Version	A1
Power Source	DC voltage supplied from AC/DC adapter. 1# Brand/Model: Gongjin/S12A12-120A100-CJ 2# Brand/Model: Gongjin/WB-12G12R
Power Rating	1# I/P: 100-240V~50/60Hz max 0.5A O/P:12V $\overline{\text{---}}$ 1A 2# I/P: 100-240V~50-60Hz 0.3A Max. O/P:12.0V $\overline{\text{---}}$ 1.0A 12.0W
Operation Frequency	UNII-2A: 5250 MHz~5350 MHz UNII-2C: 5470 MHz~5725 MHz
Modulation Type	OFDM,OFDMA
Bit Rate of Transmitter	Up to 1201Mbps
Maximum Conducted Output Power for UNII-2A (2TX) Non-Beamforming	IEEE 802.11ax (HE20): 22.94 dBm (0.1968 W) IEEE 802.11ax (HE40): 23.78 dBm (0.2388 W) IEEE 802.11ax (HE80): 22.89 dBm (0.1945 W)
Maximum Conducted Output Power for UNII-2C (2TX) Non-Beamforming	IEEE 802.11ax (HE20): 21.09 dBm (0.1285 W) IEEE 802.11ax (HE40): 23.16 dBm (0.2070 W) IEEE 802.11ax (HE80): 21.92 dBm (0.1556 W)
Maximum Conducted Output Power for UNII-2A (2TX) Beamforming	IEEE 802.11ax (HE20): 22.80 dBm (0.1905 W) IEEE 802.11ax (HE40): 23.66 dBm (0.2323 W) IEEE 802.11ax (HE80): 22.85 dBm (0.1928 W)
Maximum Conducted Output Power for UNII-2C (2TX) Beamforming	IEEE 802.11ax (HE20): 21.08 dBm (0.1282 W) IEEE 802.11ax (HE40): 22.99 dBm (0.1991 W) IEEE 802.11ax (HE80): 21.90 dBm (0.1549 W)

Note:

1. For a more detailed features description, please refer to the manufacturer's specifications or the user's manual.

2. Channel List:

IEEE 802.11ax (HE20)		IEEE 802.11ax (HE40)		IEEE 802.11ax (HE80)	
UNII-2A		UNII-2A		UNII-2A	
Channel	Frequency (MHz)	Channel	Frequency (MHz)	Channel	Frequency (MHz)
52	5260	54	5270	58	5290
56	5280	62	5310		
60	5300				
64	5320				

IEEE 802.11ax (HE20)		IEEE 802.11ax (HE40)		IEEE 802.11ax (HE80)	
UNII-2C		UNII-2C		UNII-2C	
Channel	Frequency (MHz)	Channel	Frequency (MHz)	Channel	Frequency (MHz)
100	5500	102	5510	106	5530
104	5520	110	5550	122	5610
108	5540	118	5590		
112	5560	126	5630		
116	5580	134	5670		
120	5600				
124	5620				
128	5640				
132	5660				
136	5680				
140	5700				

3. Antenna Specification:

Ant.	Brand	Model Name	Antenna Type	Connector	Gain (dBi)	Note
1	N/A	N/A	PCB	IPEX	3	N/A
2	N/A	N/A	PCB	IPEX	3	N/A

Note:

(1) Beamforming:

All antennas have the same gain, Directional gain = $G_{ANT} + 10 \log(N_{ANT})$ dBi,

that is Directional gain = $3 + 10 \log(2)$ dBi = 6.01;

So output power limit is $24 - 6.01 + 6 = 23.99$, the power density limit is $11 - (6.01 - 6) = 10.99$.

(2) Non-Beamforming:

All antennas have the same gain, Directional gain = $G_{ANT} + \text{Array Gain}$,

For power spectral density measurements, $N_{ANT} = 2$, $N_{SS} = 1$. So Directional gain = $G_{ANT} +$

Array Gain = $10 \log(N_{ANT} / N_{SS})$ dB = $3 + 10 \log(2/1)$ dBi = 6.01. Then, the power density limit is

$11 - (6.01 - 6) = 10.99$.

4. Table for Antenna Configuration:

Operating Mode TX Mode	Ant. 1	Ant. 2	Ant. 1 + Ant. 2
IEEE 802.11ax (HE20)	✓	✓	✓
IEEE 802.11ax (HE40)	✓	✓	✓
IEEE 802.11ax (HE80)	✓	✓	✓

2.2 TEST MODES

The test system was pre-tested based on the consideration of all possible combinations of EUT operation mode.

Pretest Mode	Description
Mode 1	TX AX (HE20) Mode / CH36, CH40, CH48 (UNII-2A)
Mode 2	TX AX (HE40) Mode / CH38, CH46 (UNII-2A)
Mode 3	TX AX (HE80) Mode / CH42 (UNII-2A)
Mode 4	TX AX (HE20) Mode / CH149,CH157,CH165 (UNII-2C)
Mode 5	TX AX (HE40) Mode / CH151,CH159 (UNII-2C))
Mode 6	TX AX (HE80) Mode / CH155 (UNII-2C)

Following mode(s) as (were) found to be the worst case(s) and selected for the final test.

AC power line conducted emissions test	
Final Test Mode	Description
Mode 6	TX AX (HE40) Mode / CH54 (UNII-2A)

Radiated emissions test	
Final Test Mode	Description
Mode 1	TX AX (HE20) Mode / CH36, CH40, CH48 (UNII-2A)
Mode 2	TX AX (HE40) Mode / CH38, CH46(UNII-2A)
Mode 3	TX AX (HE80) Mode / CH42 (UNII-2A)
Mode 4	TX AX (HE20) Mode / CH149,CH157,CH165 (UNII-2C)
Mode 5	TX AX (HE40) Mode / CH151,CH159 (UNII-2C)
Mode 6	TX AX (HE80) Mode / CH155 (UNII-2C)

Note:

- (1) For conducted emissions and radiated emission below 1 GHz test, two power adapter has been pre-tested, but only the worst case recorded in this report.
- (2) The measurements for RF Output Power were tested during Non-Beamforming and Beamforming, the worst case was Non-Beamforming, only worst case was documented for other test items.
- (3) The low frequency, which started from 9 kHz to 30MHz, was pre-scanned and the result which was 20dB lower than the limit line was not reported.

2.3 PARAMETERS OF TEST SOFTWARE
Non-Beamforming

2TX				
Test Software	accessMTool			
Operating Mode	Test Frequency (MHz)	Resource Unit	Specific Resource Unit	Parameters of Test Software
IEEE 802.11ax (HE20)	5260	52 Tone	37	60
			38	58
			40	59
		106 Tone	53	69
			54	69
			61	83
	5300	52 Tone	37	60
			38	58
			40	59
		106 Tone	53	68
			54	68
			61	83
	5320	52 Tone	37	58
			38	56
			40	58
		106 Tone	53	68
			54	68
			61	82

Operating Mode	Test Frequency (MHz)	Resource Unit	Specific Resource Unit	Parameters of Test Software
IEEE 802.11ax (HE20)	5500	52 Tone	37	54
			38	52
			40	53
		106 Tone	53	54
			54	52
	242 Tone	61	53	
	5580	52 Tone	37	54
			38	52
			40	53
		106 Tone	53	63
			54	63
	242 Tone	61	77	
	5700	52 Tone	37	54
			38	52
			40	53
106 Tone		53	63	
		54	63	
242 Tone	61	77		
IEEE 802.11ax (HE40)	5270	52 Tone	37	61
			40	57
			44	59
		106 Tone	53	73
			54	68
			56	70
		242 Tone	61	80
	62		81	
	484 Tone	65	82	
	5310	52 Tone	37	58
			40	55
			44	58
		106 Tone	53	70
			54	67
			56	69
242 Tone		61	78	
	62	78		
484 Tone	65	76		

Operating Mode	Test Frequency (MHz)	Resource Unit	Specific Resource Unit	Parameters of Test Software	
IEEE 802.11ax (HE40)	5510	52 Tone	37	55	
			40	51	
			44	52	
		106 Tone	53	68	
			54	64	
			56	66	
			61	76	
			62	76	
			65	70	
		5550	52 Tone	37	68
				40	53
				44	66
	106 Tone		53	68	
			54	53	
			56	66	
			61	80	
			62	82	
			65	82	
	5670		52 Tone	37	55
				40	51
				44	52
		106 Tone	53	68	
			54	63	
			56	66	
61			80		
62			80		
65			80		

Operating Mode	Test Frequency (MHz)	Resource Unit	Specific Resource Unit	Parameters of Test Software
IEEE 802.11ax (HE80)	5290	106 Tone	37	76
			38	76
			40	76
		242 Tone	61	76
			63	76
			64	78
			65	76
			66	76
			67	78
	5530	106 Tone	37	70
			40	70
			44	70
		242 Tone	61	76
			63	76
			64	76
			65	74
			66	74
			67	76
	5610	106 Tone	37	80
			40	80
			44	80
		242 Tone	61	80
			63	80
			64	80
65			80	
66			80	
67			80	

Beamforming

2TX				
Test Software	accessMTool			
Operating Mode	Test Frequency (MHz)	Resource Unit	Specific Resource Unit	Parameters of Test Software
IEEE 802.11ax (HE20)	5260	52 Tone	37	60
			38	58
			40	59
		106 Tone	53	69
			54	69
			61	83
	5300	52 Tone	37	60
			38	58
			40	59
		106 Tone	53	68
			54	68
			61	83
	5320	52 Tone	37	58
			38	56
			40	58
		106 Tone	53	68
			54	68
			61	82

Operating Mode	Test Frequency (MHz)	Resource Unit	Specific Resource Unit	Parameters of Test Software
IEEE 802.11ax (HE20)	5500	52 Tone	37	54
			38	52
			40	53
		106 Tone	53	63
			54	63
	242 Tone	61	78	
	5580	52 Tone	37	54
			38	52
			40	53
		106 Tone	53	63
			54	63
	242 Tone	61	77	
	5700	52 Tone	37	54
			38	52
			40	53
106 Tone		53	63	
		54	63	
242 Tone	61	77		
IEEE 802.11ax (HE40)	5270	52 Tone	37	61
			40	57
			44	59
		106 Tone	53	73
			54	68
			56	70
		242 Tone	61	80
	62		81	
	484 Tone	65	82	
	5310	52 Tone	37	58
			40	55
			44	58
		106 Tone	53	70
			54	67
			56	69
242 Tone		61	78	
	62	78		
484 Tone	65	76		

Operating Mode	Test Frequency (MHz)	Resource Unit	Specific Resource Unit	Parameters of Test Software
IEEE 802.11ax (HE40)	5510	52 Tone	37	55
			40	51
			44	52
		106 Tone	53	68
			54	64
			56	66
			61	76
			62	76
			65	70
	5550	52 Tone	37	54
			40	50
			44	52
		106 Tone	53	68
			54	53
			56	66
			61	80
			62	82
			65	82
	5670	52 Tone	37	55
			40	51
			44	52
		106 Tone	53	68
			54	63
			56	66
61			80	
62			80	
65			80	

Operating Mode	Test Frequency (MHz)	Resource Unit	Specific Resource Unit	Parameters of Test Software
IEEE 802.11ax (HE80)	5290	106 Tone	37	76
			40	76
			44	76
		242 Tone	61	78
			63	78
			64	78
			65	76
			66	76
			67	78
	5530	106 Tone	37	70
			40	70
			44	70
		242 Tone	61	76
			63	76
			64	76
			65	74
			66	74
			67	76
	5610	106 Tone	37	80
			40	80
			44	80
		242 Tone	61	80
			63	80
			64	80
65			80	
66			80	
67			80	

2.4 DUTY CYCLE

If duty cycle is $\geq 98\%$, duty factor is not required.
 If duty cycle is $< 98\%$, duty factor shall be considered.

IEEE 802.11ax (HE20)

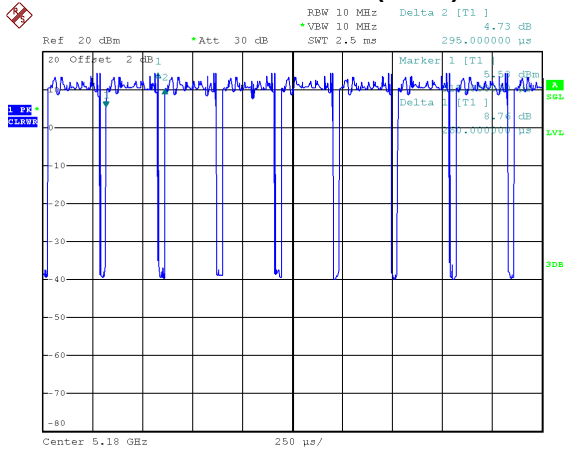

Date: 2.JUN.2020 10:34:51

Duty cycle = $0.260 \text{ ms} / 0.295 \text{ ms} = 88.14\%$
 Duty Factor = $10 * \log(1 / 88.14\%) = 0.55 \text{ dB}$

IEEE 802.11ax (HE40)

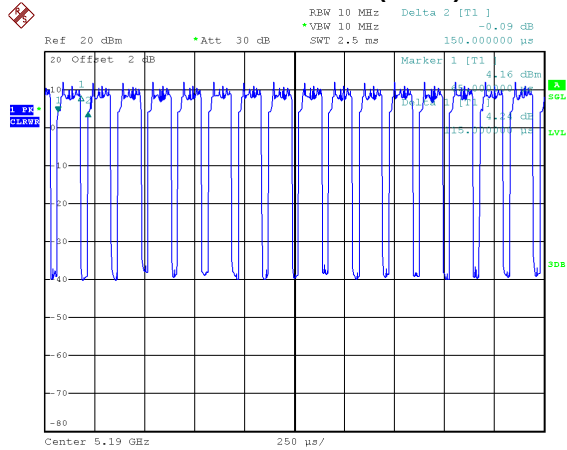

Date: 2.JUN.2020 10:37:43

Duty cycle = $0.115 \text{ ms} / 0.150 \text{ ms} = 76.67\%$
 Duty Factor = $10 * \log(1 / 76.67\%) = 1.15 \text{ dB}$

IEEE 802.11ax (HE80)

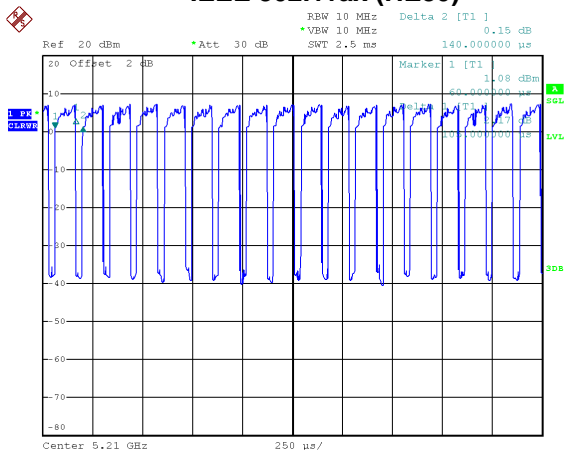

Date: 2.JUN.2020 10:39:48

Duty cycle = $0.105 \text{ ms} / 0.140 \text{ ms} = 75.00\%$
 Duty Factor = $10 * \log(1 / 75.00\%) = 1.25 \text{ dB}$

NOTE:

For IEEE 802.11ax (HE20):

For radiated emissions frequency above 1 GHz, the resolution bandwidth of test receiver/spectrum analyzer is 1 MHz and the video bandwidth is 4 kHz (Duty cycle $< 98\%$).

For IEEE 802.11ax (HE40):

For radiated emissions frequency above 1 GHz, the resolution bandwidth of test receiver/spectrum analyzer is 1 MHz and the video bandwidth is 9 kHz (Duty cycle $< 98\%$).

For IEEE 802.11ax (HE80):

For radiated emissions frequency above 1 GHz, the resolution bandwidth of test receiver/spectrum analyzer is 1 MHz and the video bandwidth is 10 kHz (Duty cycle $< 98\%$).

2.5 BLOCK DIAGRAM SHOWING THE CONFIGURATION OF SYSTEM TESTED

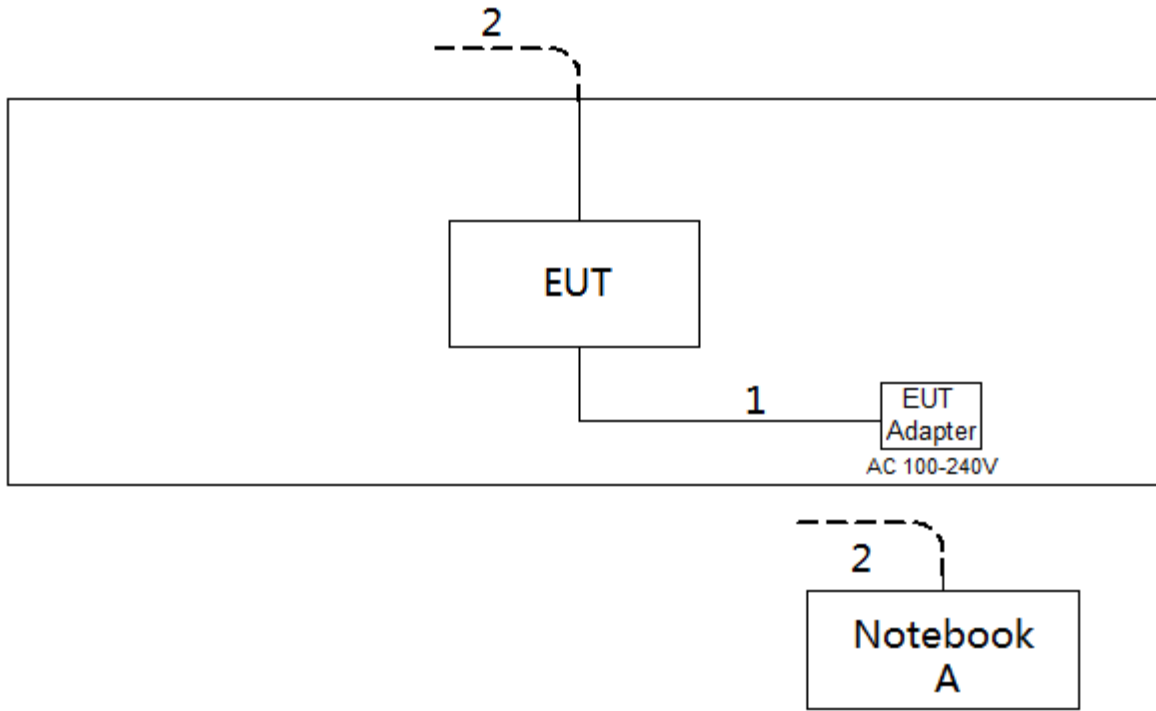

2.6 SUPPORT UNITS

Item	Equipment	Mfr/Brand	Model/Type No.	Series No.
A	Notebook	Lenovo	#P152014	N/A

Item	Cable Type	Shielded Type	Ferrite Core	Length
1	DC Cable	NO	NO	1.5m
2	RJ45 Cable	NO	NO	10m

3. AC POWER LINE CONDUCTED EMISSIONS TEST

3.1 LIMIT

Frequency (MHz)	Limit (dB μ V)	
	Quasi-peak	Average
0.15 - 0.5	66 to 56*	56 - 46*
0.50 - 5.0	56	46
5.0 - 30.0	60	50

NOTE:

- (1) The tighter limit applies at the band edges.
- (2) The limit of " * " marked band means the limitation decreases linearly with the logarithm of the frequency in the range.

The following table is the setting of the receiver

Receiver Parameter	Setting
Attenuation	10 dB
Start Frequency	0.15 MHz
Stop Frequency	30 MHz
IF Bandwidth	9 KHz

3.2 TEST PROCEDURE

- a. The EUT was placed 0.8 meters from the horizontal ground plane with EUT being connected to the power mains through a line impedance stabilization network (LISN). All other support equipment powered from additional LISN(s). The LISN provide 50 Ohm/ 50uH of coupling impedance for the measuring instrument.
- b. Interconnecting cables that hang closer than 40 cm to the ground plane shall be folded back and forth in the center forming a bundle 30 to 40 cm long.
- c. I/O cables that are not connected to a peripheral shall be bundled in the center. The end of the cable may be terminated, if required, using the correct terminating impedance. The overall length shall not exceed 1 m.
- d. LISN at least 80 cm from nearest part of EUT chassis.
- e. For the actual test configuration, please refer to the related Item -EUT Test Photos.

3.3 DEVIATION FROM TEST STANDARD

No deviation

3.4 TEST SETUP

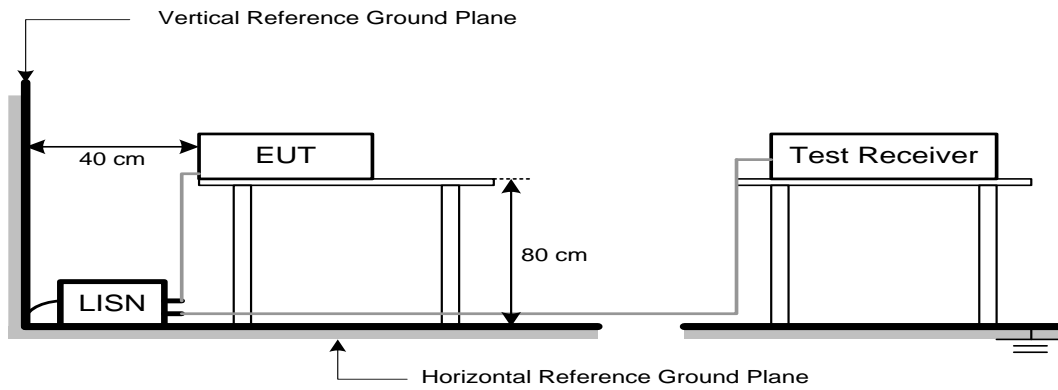

3.5 EUT OPERATION CONDITIONS

The EUT was configured for testing in a typical fashion (as a customer would normally use it). The EUT has been programmed to continuously transmit during test. This operating condition was tested and used to collect the included data.

The EUT was programmed to be in continuously transmitting/TX mode.

3.6 TEST RESULTS

Please refer to the APPENDIX A.

4. RADIATED EMISSIONS TEST

4.1 LIMIT

In case the emission fall within the restricted band specified on 15.205(a), then the 15.209(a) limit in the table below has to be followed.

LIMITS OF RADIATED EMISSIONS MEASUREMENT (9 kHz to 1000 MHz)

Frequency (MHz)	Field Strength (microvolts/meter)	Measurement Distance (meters)
0.009-0.490	2400/F(kHz)	300
0.490-1.705	24000/F(kHz)	30
1.705-30.0	30	30
30-88	100	3
88-216	150	3
216-960	200	3
Above 960	500	3

LIMITS OF UNWANTED EMISSION OUT OF THE RESTRICTED BANDS

Frequency (MHz)	EIRP Limit (dBm/MHz)	Equivalent Field Strength at 3m (dBμV/m)
5150-5250	-27	68.3
5250-5350	-27	68.3
5470-5725	-27	68.3
5725-5850	-27 NOTE (2)	68.3
	10 NOTE (2)	105.3
	15.6 NOTE (2)	110.9
	27 NOTE (2)	122.3

NOTE:

(1) The following formula is used to convert the equipment isotropic radiated power (eirp) to field strength:

$$E = \frac{1000000\sqrt{30P}}{3} \mu\text{V/m, where P is the eirp (Watts)}$$

(2) According to 15.407(b)(4)(i), all emissions shall be limited to a level of -27 dBm/MHz at 75 MHz or more above or below the band edge increasing linearly to 10 dBm/MHz at 25 MHz above or below the band edge, and from 25 MHz above or below the band edge increasing linearly to a level of 15.6 dBm/MHz at 5 MHz above or below the band edge, and from 5 MHz above or below the band edge increasing linearly to a level of 27 dBm/MHz at the band edge.

4.2 TEST PROCEDURE

- a. The measuring distance of 3 m shall be used for measurements. The EUT was placed on the top of a rotating table 0.8 meter above the ground at a 3 meter semi-anechoic chamber. The table was rotated 360 degrees to determine the position of the highest radiation.(below 1GHz)
- b. The measuring distance of 3 m shall be used for measurements. The EUT was placed on the top of a rotating table 1.5 meter above the ground at a 3 meter semi-anechoic chamber. The table was rotated 360 degrees to determine the position of the highest radiation.(above 1GHz)
- c. The height of the equipment or of the substitution antenna shall be 0.8m or 1.5m; the height of the test antenna shall vary between 1 m to 4 m. Both horizontal and vertical polarizations of the antenna are set to make the measurement.
- d. For each suspected emission, the EUT was arranged to its worst case and then the antenna was tuned to heights find the maximum reading (used Bore sight function).
- e. The receiver system was set to peak and average detect function and specified bandwidth with maximum hold mode when the test frequency is above 1 GHz.
- f. The initial step in collecting radiated emission data is a receiver peak detector mode pre-scanning the measurement frequency range. Significant peaks are then marked and then Quasi Peak detector mode re-measured.
- g. All readings are Peak unless otherwise stated QP in column of Note. Peak denotes that the Peak reading compliance with the QP Limits and then QP Mode measurement didn't perform.
(below 1 GHz)
- h. All readings are Peak Mode value unless otherwise stated AVG in column of Note. If the Peak Mode Measured value compliance with the Peak Limits and lower than AVG Limits, the EUT shall be deemed to meet both Peak & AVG Limits and then only Peak Mode was measured, but AVG Mode didn't perform. (above 1 GHz)
- i. For the actual test configuration, please refer to the related Item –EUT Test Photos.

4.3 DEVIATION FROM TEST STANDARD

No deviation

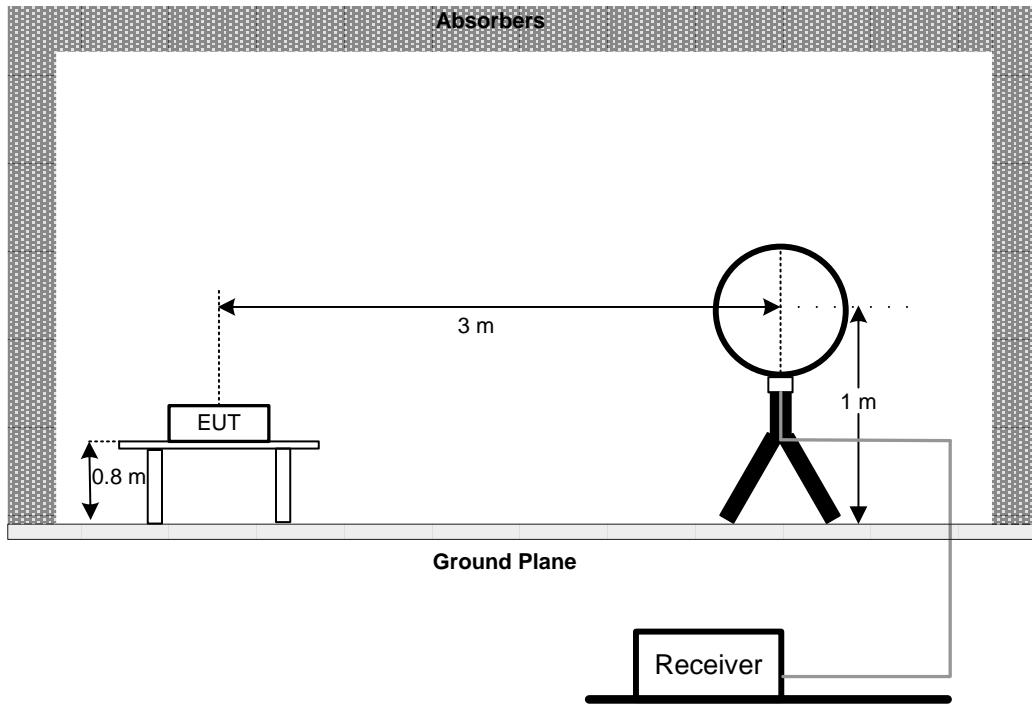
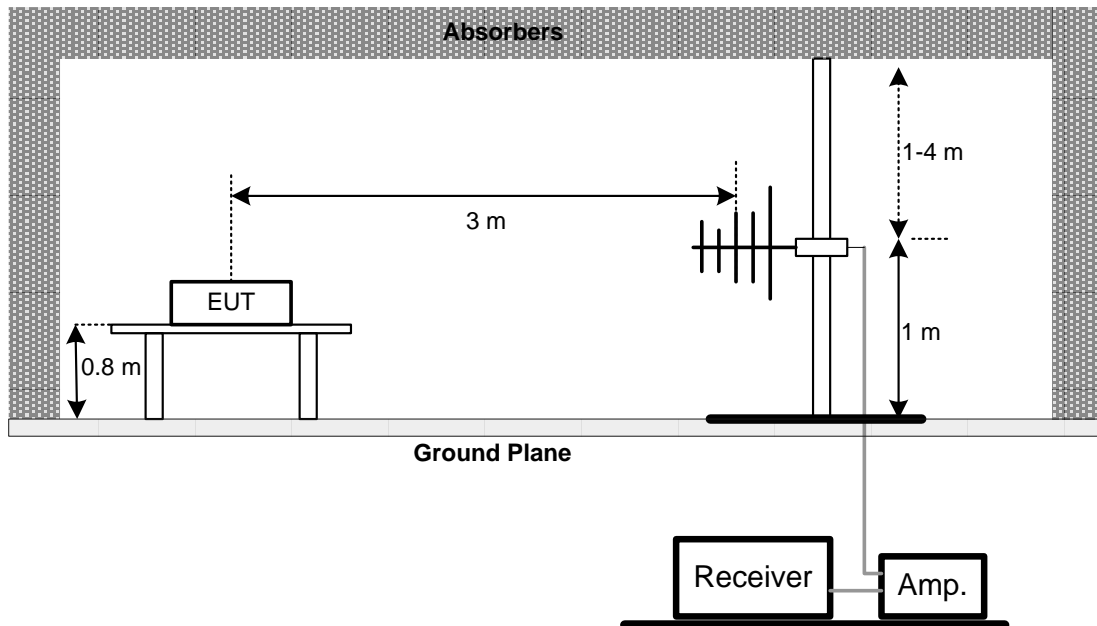
4.4 TEST SETUP**9 kHz to 30 MHz****30 MHz to 1 GHz**

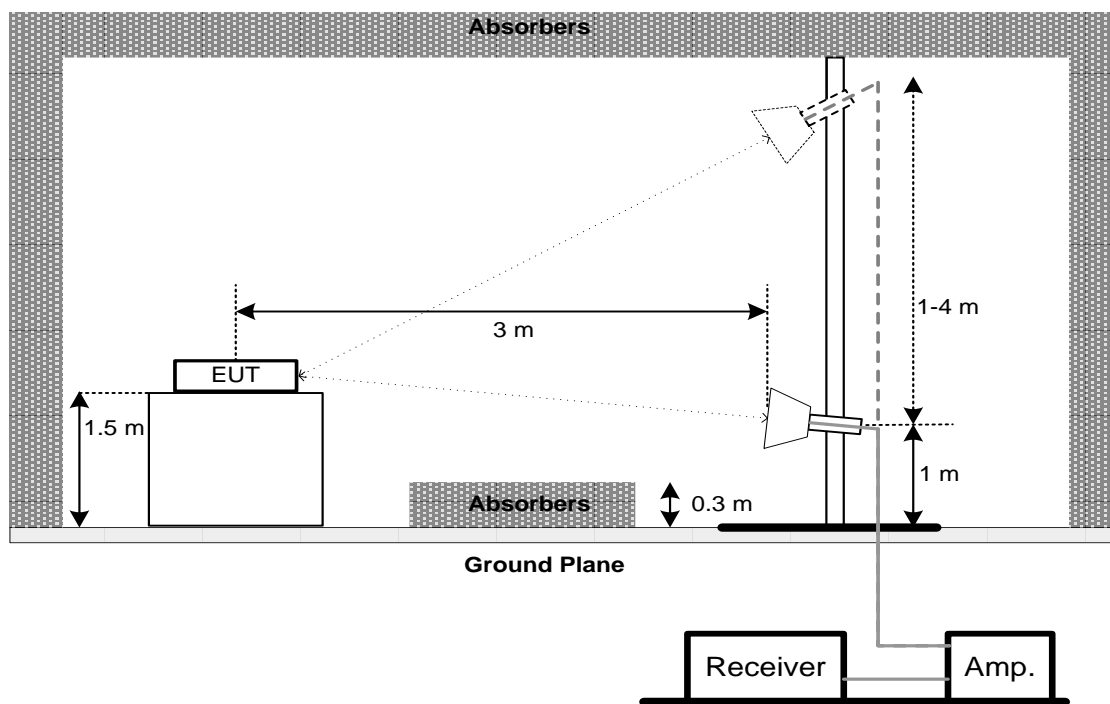
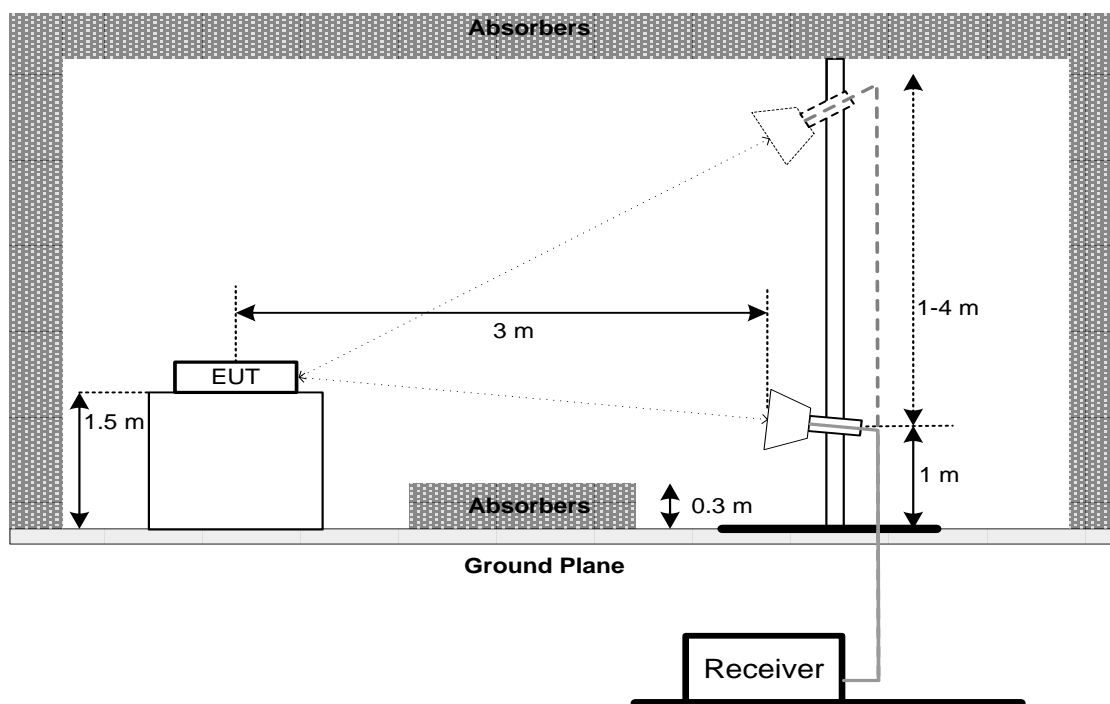
Above 1 GHz**Above 1 GHz
Band edge**

4.5 EUT OPERATION CONDITIONS

The EUT tested system was configured as the statements of 4.1.5 unless otherwise a special operating condition is specified in the follows during the testing.

4.6 TEST RESULTS - 30 MHz TO 1000 MHz

Please refer to the APPENDIX B.

4.7 TEST RESULTS - ABOVE 1000 MHz

Please refer to the APPENDIX C.

Remark:

- (1) No limit: This is fundamental signal, the judgment is not applicable.
For fundamental signal judgment was referred to Peak output test.

5. BANDWIDTH TEST

5.1 LIMIT

FCC Part15, Subpart E (15.407)			
Section	Test Item	Limit	Frequency Range (MHz)
15.407(a) 15.407(e)	26 dB Bandwidth	-	5150-5250
	26 dB Bandwidth	-	5250-5350
	26 dB Bandwidth	-	5470-5725
	6 dB Bandwidth	Minimum 500 kHz	5725-5850

5.2 TEST PROCEDURE

a. The EUT was directly connected to the spectrum analyzer and antenna output port as show in the block diagram below

b. a. Spectrum Setting:

For UNII-1,UNII-2A, UNII-2C:

Spectrum Parameter	Setting
Attenuation	Auto
Span Frequency	> 26 dB Bandwidth
RBW	300 kHz (Bandwidth 20 MHz) 1 MHz (Bandwidth 40 MHz and 80 MHz)
VBW	1 MHz (Bandwidth 20 MHz) 3 MHz (Bandwidth 40 MHz and 80 MHz)
Detector	Peak
Trace	Max Hold
Sweep Time	Auto

For UNII-3:

Spectrum Parameter	Setting
Attenuation	Auto
Span Frequency	6 dB Bandwidth
RBW	100 kHz
VBW	300 kHz
Detector	Peak
Trace	Max Hold
Sweep Time	Auto

c. Measured the spectrum width with power higher than 26 dB below carrier

5.3 TEST PROCEDURE

No deviation.

5.4 TEST SETUP**5.5 EUT OPERATION CONDITIONS**

The EUT was programmed to be in continuously transmitting mode.

5.6 TEST RESULTS

Please refer to the APPENDIX D.

6. MAXIMUM OUTPUT POWER TEST

6.1 LIMIT

FCC Part15, Subpart E (15.407)			
Section	Test Item	Limit	Frequency Range (MHz)
15.407(a)	Conducted Output Power	AP device: 1 Watt (30 dBm) Client device: 250 mW (24 dBm)	5150-5250
		250 mW (24 dBm)	5250-5350
		250 mW (24 dBm)	5470-5725
		1 Watt (30dBm)	5725-5850

Note:

- a. For an indoor access point operating in the band 5.15-5.25 GHz, the maximum conducted output power over the frequency band of operation shall not exceed 1 W provided the maximum antenna gain does not exceed 6 dBi. In addition, the maximum power spectral density shall not exceed 17 dBm in any 1 megahertz band. If transmitting antennas of directional gain greater than 6 dBi are used, both the maximum conducted output power and the maximum power spectral density shall be reduced by the amount in dB that the directional gain of the antenna exceeds 6 dBi.
- b. For the 5.25-5.35 GHz and 5.47-5.725 GHz bands, the maximum conducted output power over the frequency bands of operation shall not exceed the lesser of 250 mW or 11 dBm + 10log B, where B is the 26dB Bandwidth in megahertz.

6.2 TEST PROCEDURE

- a. The EUT was directly connected to the power meter and antenna output port as show in the block diagram below.
- b. Test test was performed in accordance with method of FCC KDB 789033 D02 General UNII Test Procedures New Rules v02r01.

6.3 DEVIATION FROM STANDARD

No deviation.

6.4 TEST SETUP

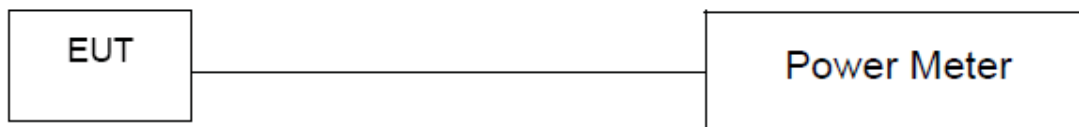

6.5 EUT OPERATION CONDITIONS

The EUT was programmed to be in continuously transmitting mode.

6.6 TEST RESULTS

Please refer to the APPENDIX E.

7. POWER SPECTRAL DENSITY TEST

7.1 LIMIT

FCC Part15, Subpart E (15.407)			
Section	Test Item	Limit	Frequency Range (MHz)
15.407(a)	Power Spectral Density	AP device: 17 dBm/MHz Client device: 11 dBm/MHz	5150-5250
		11 dBm/MHz	5250-5350
		11 dBm/MHz	5470-5725
		30 dBm/500 kHz	5725-5850

7.2 TEST PROCEDURE

- a. The EUT was directly connected to the spectrum analyzer and antenna output port as show in the block diagram below.
- b. Spectrum Setting

Spectrum Parameter	Setting
Attenuation	Auto
Span Frequency	Encompass the entire emissions bandwidth (EBW) of the signal
RBW	= 1 MHz.
VBW	≥ 3 MHz.
Detector	RMS
Trace average	100 trace
Sweep Time	Auto

Note:

1. For UNII-2C, according to KDB publication 789033 D02 General UNII Test Procedures New Rules v02r01, section II.F.5., it is acceptable to set RBW at 1 MHz and VBW at 3 MHz if the spectrum analyzer does not have 500 kHz RBW.
2. The value measured with RBW=1 MHz is to be added with $10\log(500 \text{ kHz}/1 \text{ MHz})$ which is -3 dB. For example, if the measured value is +10dBm using RBW=1 MHz (that is +10 dBm/MHz), then the converted value will be +7dBm/500kHz.

7.3 DEVIATION FROM STANDARD

No deviation.

7.4 TEST SETUP**7.5 EUT OPERATION CONDITIONS**

The EUT was programmed to be in continuously transmitting mode.

7.6 TEST RESULTS

Please refer to the APPENDIX F.

8. MEASUREMENT INSTRUMENTS LIST

AC Power Line Conducted Emissions					
Item	Kind of Equipment	Manufacturer	Type No.	Serial No.	Calibrated until
1	Line Impedance Stabilisation Network	Schwarzbeck	NNLK 8121	8121-822	Mar. 21, 2021
2	TWO-LINE V-NETWORK	R&S	ENV216	101340	Aug. 23, 2021
3	EMI Test Receiver	R&S	ESCI	100082	Mar. 21, 2021
4	50Ω coaxial switch	Anritsu	MP59B	6201750902	Mar. 21, 2021
5	Cable	10m	EMCRG400-BM-N M-10000	170628	Jul. 15, 2021
6	Measurement Software	Farad	EZ-EMC Ver.NB-03A1-01	N/A	N/A

Radiated Emissions - 9 kHz to 30 MHz					
Item	Kind of Equipment	Manufacturer	Type No.	Serial No.	Calibrated until
1	Loop Antenna	EMCI	EMCI LPA600	275	Apr. 02, 2021
2	Cable	N/A	EMCRG400-BM-N M-10000	170628	Jul. 15, 2021
3	MXE EMI Receiver	Keysight	N9038A	MY57150106	May. 06, 2021
4	Measurement Software	Farad	EZ-EMC Ver.BTL-2ANT-1	N/A	N/A

Radiated Emissions - 30 MHz to 1 GHz					
Item	Kind of Equipment	Manufacturer	Type No.	Serial No.	Calibrated until
1	TRILOG Broadband Antenna	Schwarzbeck	VULB 9168	719	Apr. 02, 2021
2	Pre-Amplifier	emci	EMC9135	980400	Mar. 21, 2021
3	MXE EMI Receiver	Keysight	N9038A	MY57150106	May. 06, 2021
4	Attenuator	emci	EMCI-N-6-06	AT-N0644	Mar. 21, 2021
5	Cable	7m	EMC104-SM-SM-7000	170330	Apr. 13, 2021
6	Cable	1m	EMC104-SM-SM-1000	170331	Apr. 13, 2021
7	Cable	3.5m	EMC104-SM-NM-3500	170621	Apr. 13, 2021
8	Measurement Software	Farad	EZ-EMC Ver.BTL-2ANT-1	N/A	N/A

Radiated Emissions - Above 1 GHz					
Item	Kind of Equipment	Manufacturer	Type No.	Serial No.	Calibrated until
1	Double-Ridged Waveguide Horn Antenna	Schwarzbeck	BBHA 9120D	9120D-1787	Mar. 21, 2021
2	Double-Ridged Waveguide Horn Antenna	ETS-Lindgren	3116C	00203919	Mar. 21, 2021
3	Pre-Amplifier	emci	EMC012645SE	980421	May. 11, 2021
4	Pre-Amplifier	emci	EMC184045SE	980409	Mar. 21, 2021
5	EXA Spectrum Analyzer	Keysight	N9010A	MY56480559	Mar. 21, 2021
6	MXE EMI Receiver	Keysight	N9038A	MY56400088	Mar. 21, 2021
7	Cable	7m	EMC104-SM-SM-700 0	170330	Apr. 13, 2021
8	Cable	1m	EMC104-SM-SM-100 0	170331	Apr. 13, 2021
9	Cable	3.5m	EMC104-SM-NM-350 0	170621	Apr. 13, 2021
10	Cable	0.8m	EMC102-SM-SM-800	170335	Apr. 13, 2021
11	Cable	6m	EMC102-SM-SM-600 0	170336	Apr. 13, 2021
12	Measurement Software	Farad	EZ-EMC Ver.NB-03A1-01	N/A	N/A

Bandwidth					
Item	Kind of Equipment	Manufacturer	Type No.	Serial No.	Calibrated until
1	Spectrum Analyzer	R&S	FSP40	100626	May. 06, 2021

Maximum Output Power					
Item	Kind of Equipment	Manufacturer	Type No.	Serial No.	Calibrated until
1	Power Meter	Keysight	8990B	MY51000507	Mar. 21, 2021
2	Pulse Power Sensor	Keysight	N1923A	MY58310003	Mar. 21, 2021

Antenna Conducted Spurious Emissions					
Item	Kind of Equipment	Manufacturer	Type No.	Serial No.	Calibrated until
1	Spectrum Analyzer	R&S	FSP40	100626	May. 06, 2021

Power Spectral Density					
Item	Kind of Equipment	Manufacturer	Type No.	Serial No.	Calibrated until
1	Spectrum Analyzer	R&S	FSP40	100626	May. 06, 2021

Remark: "N/A" denotes no model name, serial no. or calibration specified.

All calibration period of equipment list is one year.

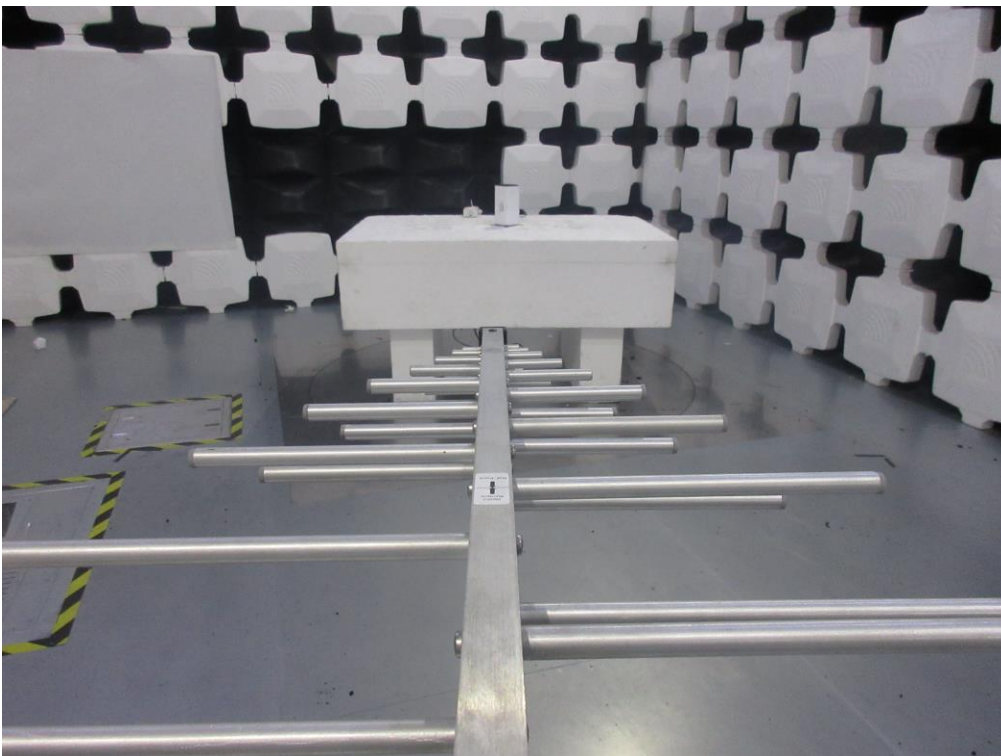
9. EUT TEST PHOTOS**Conducted Emissions Test Photos**

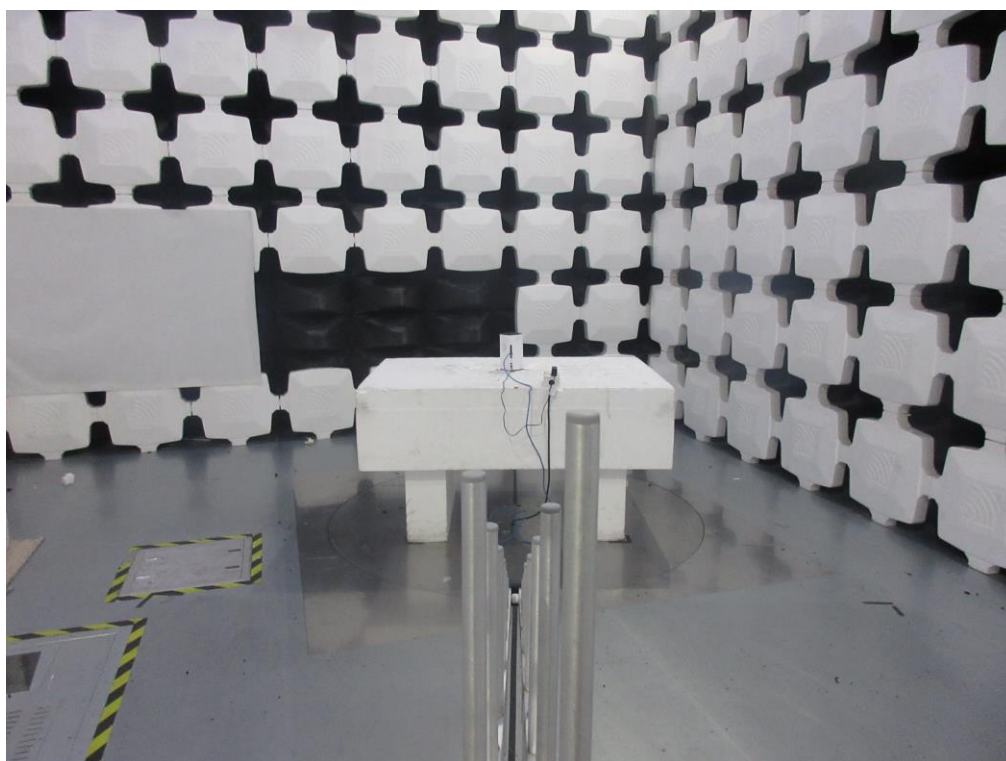
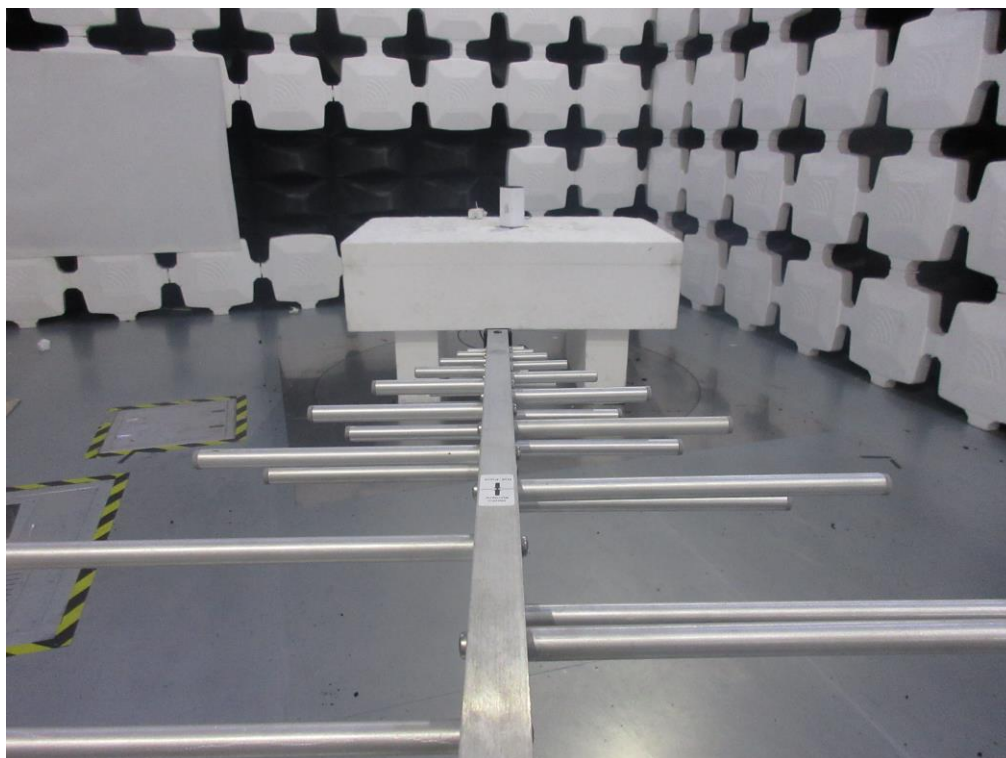
Radiated Emissions Test Photos**30 MHz to 1 GHz**

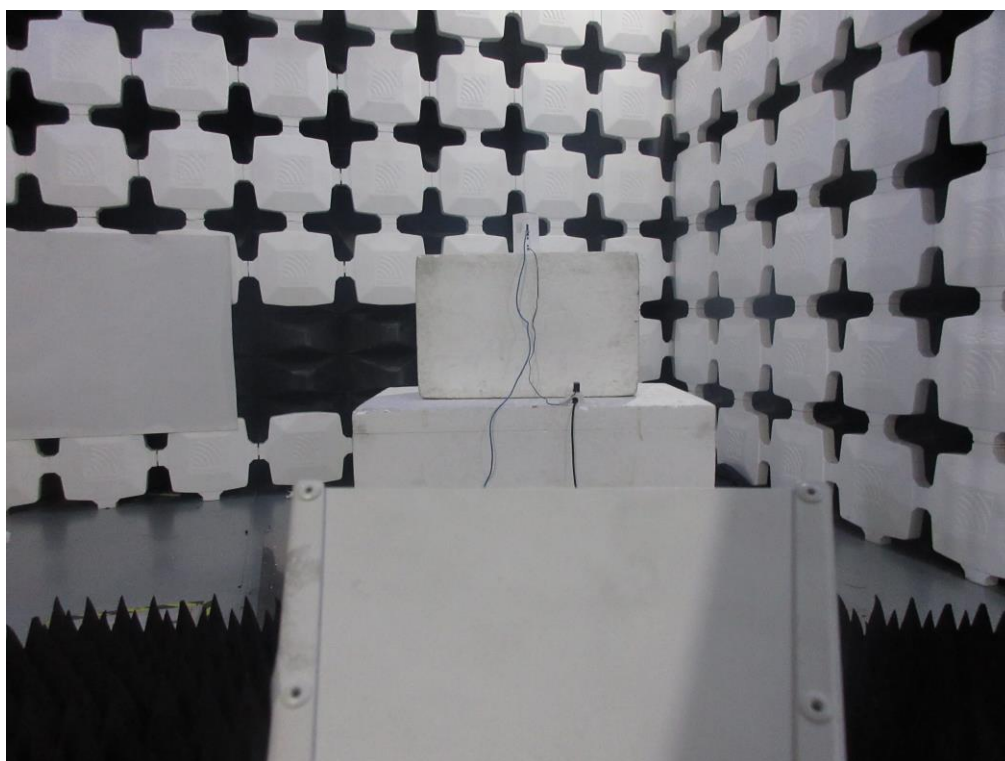
Radiated Emissions Test Photos**Above 1 GHz**

APPENDIX A - AC POWER LINE CONDUCTED EMISSIONS

Test Mode: UNII-2A_TX AX (HE40) Mode 5270 MHz

Line

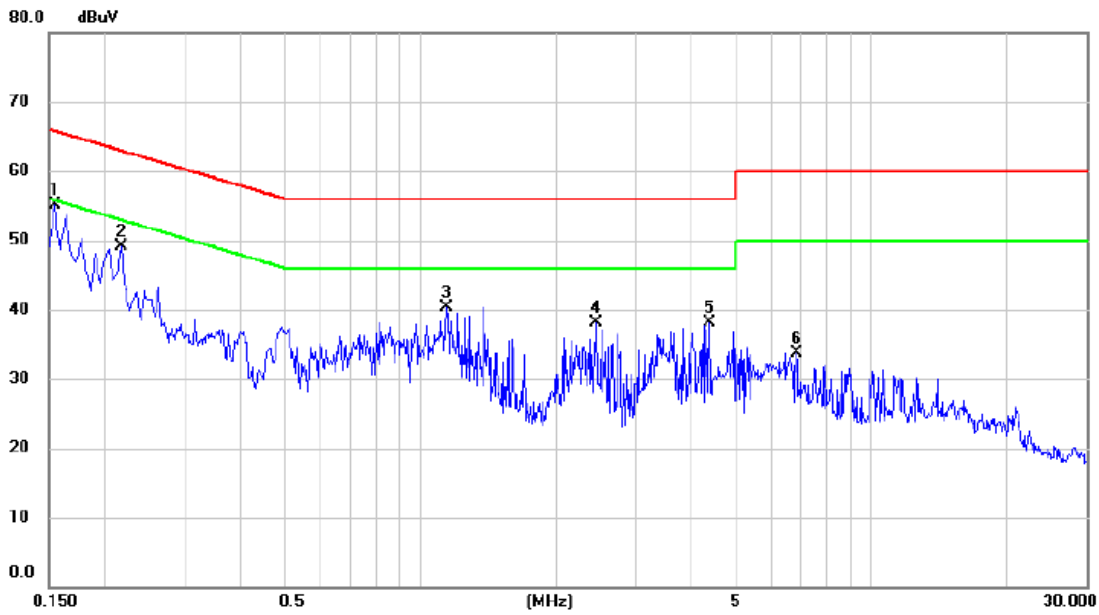

No.	Mk.	Freq. MHz	Reading Level dBuV	Correct Factor dB	Measure- ment dBuV	Limit dBuV	Margin dB	Detector	Comment
1	*	0.1544	45.46	9.73	55.19	65.76	-10.57	peak	
2		0.2174	39.22	9.79	49.01	62.92	-13.91	peak	
3		1.1400	30.58	9.75	40.33	56.00	-15.67	peak	
4		2.4495	28.35	9.82	38.17	56.00	-17.83	peak	
5		4.3710	28.25	9.93	38.18	56.00	-17.82	peak	
6		6.8323	23.71	10.06	33.77	60.00	-26.23	peak	

REMARKS:

- (1) Measurement Value = Reading Level + Correct Factor.
- (2) Margin Level = Measurement Value - Limit Value.

Test Mode: UNII-2A_TX AX (HE40) Mode 5270 MHz

Neutral

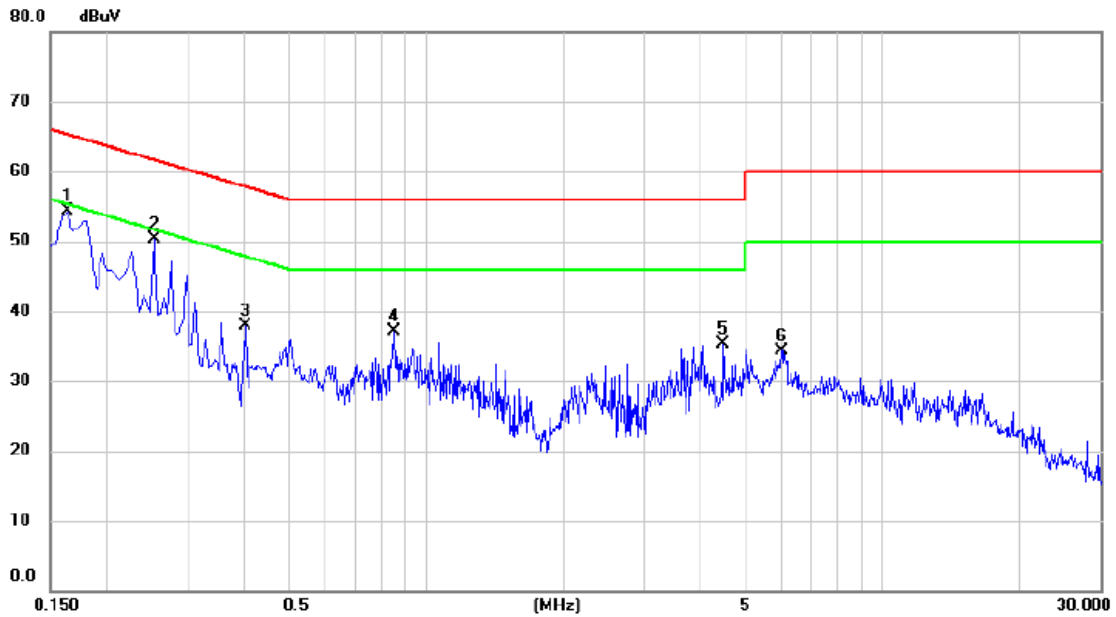

No.	Mk.	Freq. MHz	Reading Level dBuV	Correct Factor dB	Measure- ment dBuV	Limit dBuV	Margin dB	Detector	Comment
1	*	0.1635	44.72	9.61	54.33	65.28	-10.95	peak	
2		0.2535	40.61	9.65	50.26	61.64	-11.38	peak	
3		0.4020	28.27	9.67	37.94	57.81	-19.87	peak	
4		0.8520	27.42	9.72	37.14	56.00	-18.86	peak	
5		4.4790	25.38	9.92	35.30	56.00	-20.70	peak	
6		5.9954	24.40	10.00	34.40	60.00	-25.60	peak	

REMARKS:

- (1) Measurement Value = Reading Level + Correct Factor.
- (2) Margin Level = Measurement Value - Limit Value.

APPENDIX B - RADIATED EMISSION - 30 MHZ TO 1 GHZ

Test Mode: UNII-2A_TX AX (HE40) Mode 5270 MHz

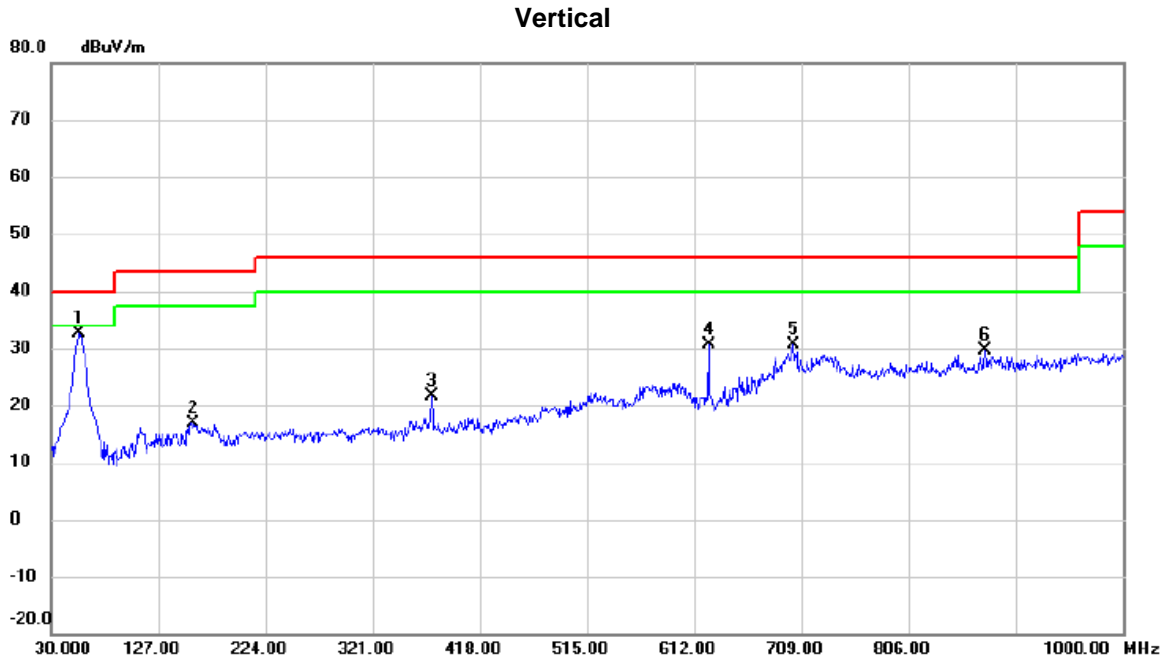

No.	Mk.	Freq. MHz	Reading Level dBuV	Correct Factor dB	Measure- ment dBuV/m	Limit dBuV/m	Margin dB	Detector	Comment
1	*	55.7050	49.27	-16.61	32.66	40.00	-7.34	peak	
2		158.0400	32.46	-15.56	16.90	43.50	-26.60	peak	
3		374.8350	34.74	-13.11	21.63	46.00	-24.37	peak	
4		625.0950	38.26	-7.75	30.51	46.00	-15.49	peak	
5		701.2400	37.42	-6.77	30.65	46.00	-15.35	peak	
6		874.8700	34.39	-4.66	29.73	46.00	-16.27	peak	

REMARKS:

(1) Measurement Value = Reading Level + Correct Factor.

(2) Margin Level = Measurement Value - Limit Value.

Test Mode: UNII-2A_TX AX (HE40) Mode 5270 MHz

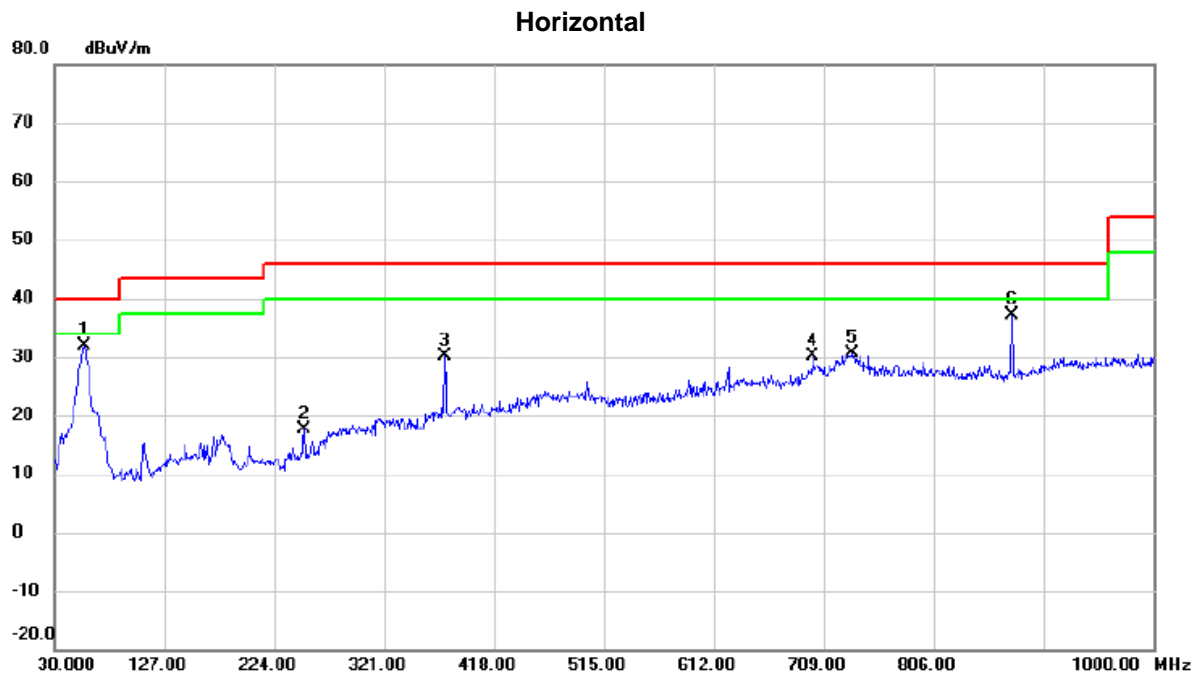

No.	Mk.	Freq. MHz	Reading Level dBuV	Correct Factor dB	Measure- ment dBuV/m	Limit dBuV/m	Margin dB	Detector	Comment
1	*	56.6750	48.49	-16.66	31.83	40.00	-8.17	peak	
2		250.1900	34.42	-16.67	17.75	46.00	-28.25	peak	
3		374.8350	43.31	-13.11	30.20	46.00	-15.80	peak	
4		699.7850	36.97	-6.79	30.18	46.00	-15.82	peak	
5		734.7050	36.66	-6.11	30.55	46.00	-15.45	peak	
6		874.8700	41.77	-4.66	37.11	46.00	-8.89	peak	

REMARKS:

(1) Measurement Value = Reading Level + Correct Factor.

(2) Margin Level = Measurement Value - Limit Value.

APPENDIX C - RADIATED EMISSION - ABOVE 1000 MHZ

Orthogonal Axis	X		
Test Mode	UNII-2A_TX AX (HE20) Mode 5260 MHz	RU configuration	52/40

Vertical

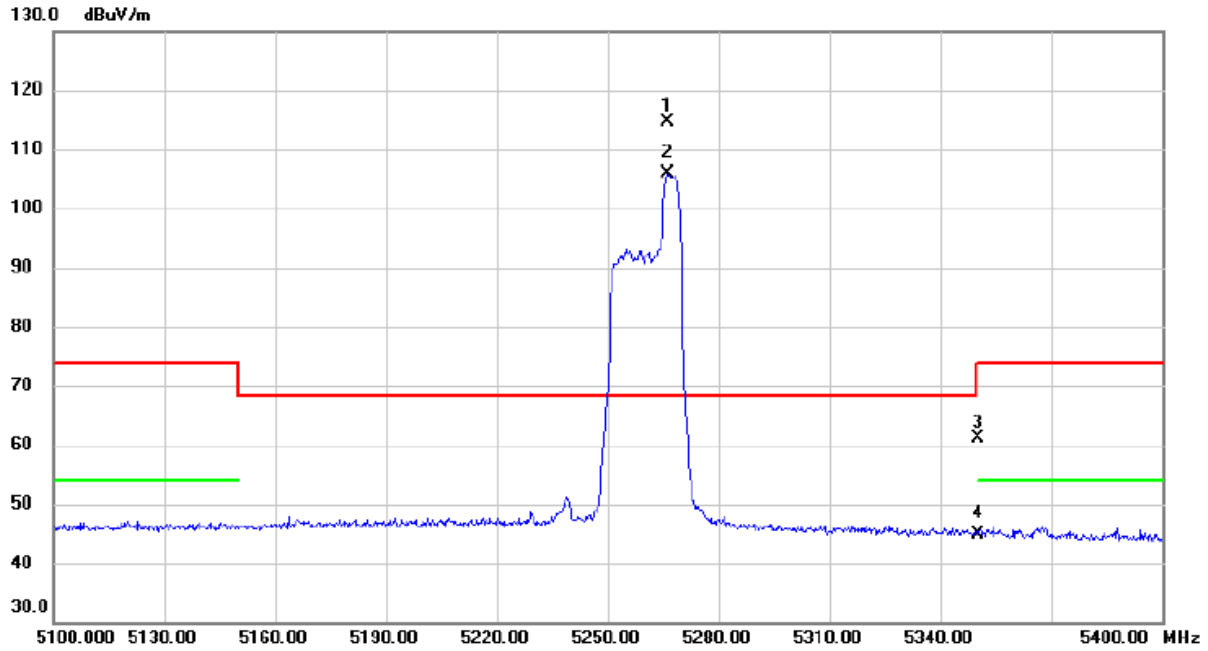

No.	Mk.	Freq. MHz	Reading Level dBuV	Correct Factor dB	Measure- ment dBuV/m	Limit dBuV/m	Margin dB	Detector	Comment
1	*	5266.350	77.05	37.58	114.63	68.30	46.33	peak	No limit
2	X	5266.350	68.27	37.58	105.85	68.30	37.55	AVG	No limit
3		5350.000	23.29	37.73	61.02	74.00	-12.98	peak	
4		5350.000	7.25	37.73	44.98	54.00	-9.02	AVG	

REMARKS:

- (1) Measurement Value = Reading Level + Correct Factor.
- (2) Margin Level = Measurement Value - Limit Value.

Orthogonal Axis	X		
Test Mode	UNII-2A_TX AX (HE20) Mode 5260 MHz	RU configuration	52/40

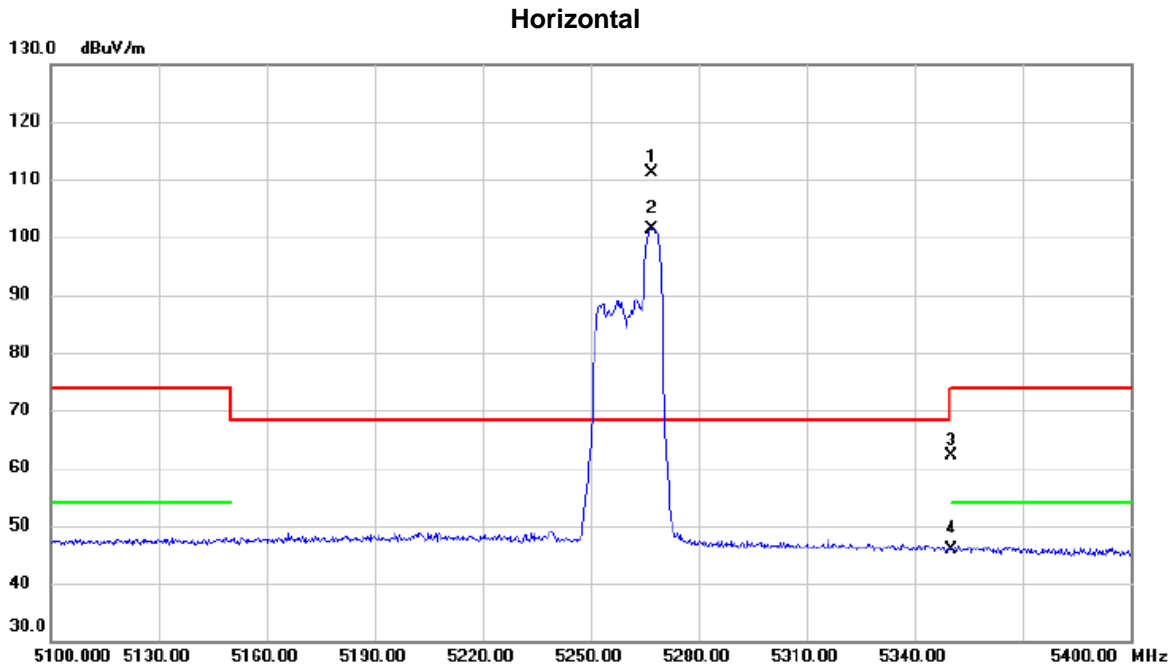

No.	Mk.	Freq.	Reading Level	Correct Factor	Measurement	Limit	Margin		
		MHz	dBuV	dB	dBuV/m	dBuV/m	dB	Detector	Comment
1	*	5266.950	73.45	37.58	111.03	68.30	42.73	peak	No limit
2	X	5266.950	63.90	37.58	101.48	68.30	33.18	AVG	No limit
3		5350.000	24.31	37.73	62.04	74.00	-11.96	peak	
4		5350.000	8.15	37.73	45.88	54.00	-8.12	AVG	

REMARKS:

- (1) Measurement Value = Reading Level + Correct Factor.
- (2) Margin Level = Measurement Value - Limit Value.

Orthogonal Axis	X		
Test Mode	UNII-2A_TX AX (HE20) Mode 5260 MHz	RU configuration	106/54

Vertical

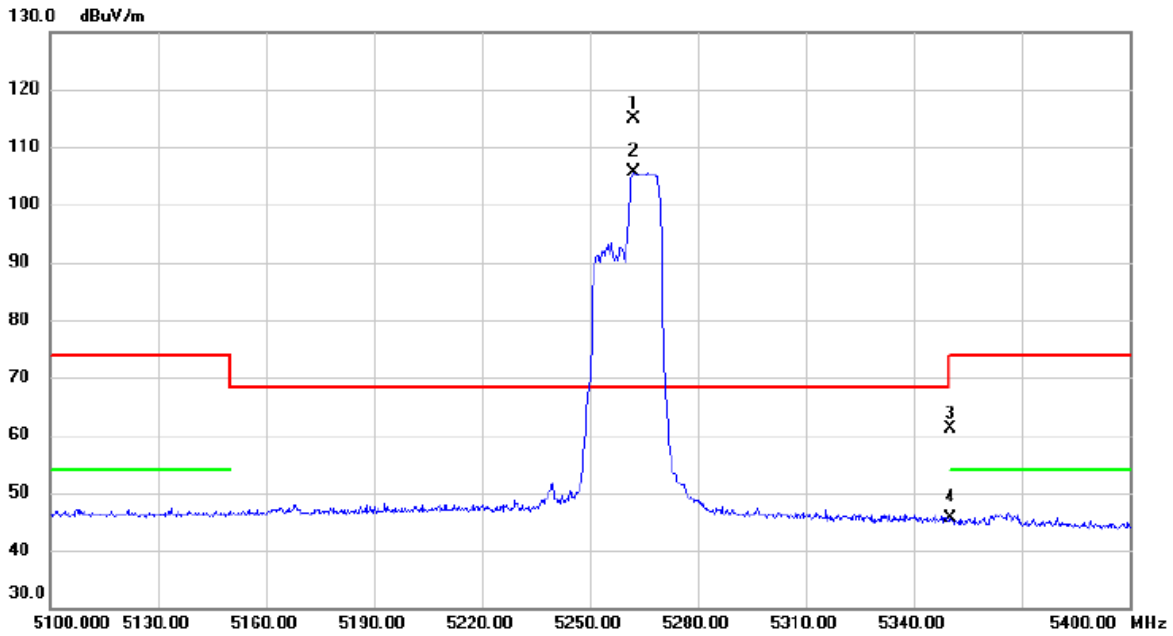

No.	Mk.	Freq. MHz	Reading Level dBuV	Correct Factor dB	Measure- ment dBuV/m	Limit dBuV/m	Margin dB	Detector	Comment
1	*	5262.300	77.37	37.59	114.96	68.30	46.66	peak	No limit
2	X	5262.300	67.96	37.59	105.55	68.30	37.25	AVG	No limit
3		5350.000	23.46	37.73	61.19	74.00	-12.81	peak	
4		5350.000	7.92	37.73	45.65	54.00	-8.35	AVG	

REMARKS:

- (1) Measurement Value = Reading Level + Correct Factor.
- (2) Margin Level = Measurement Value - Limit Value.

Orthogonal Axis	X		
Test Mode	UNII-2A_TX AX (HE20) Mode 5260 MHz	RU configuration	106/54

Horizontal

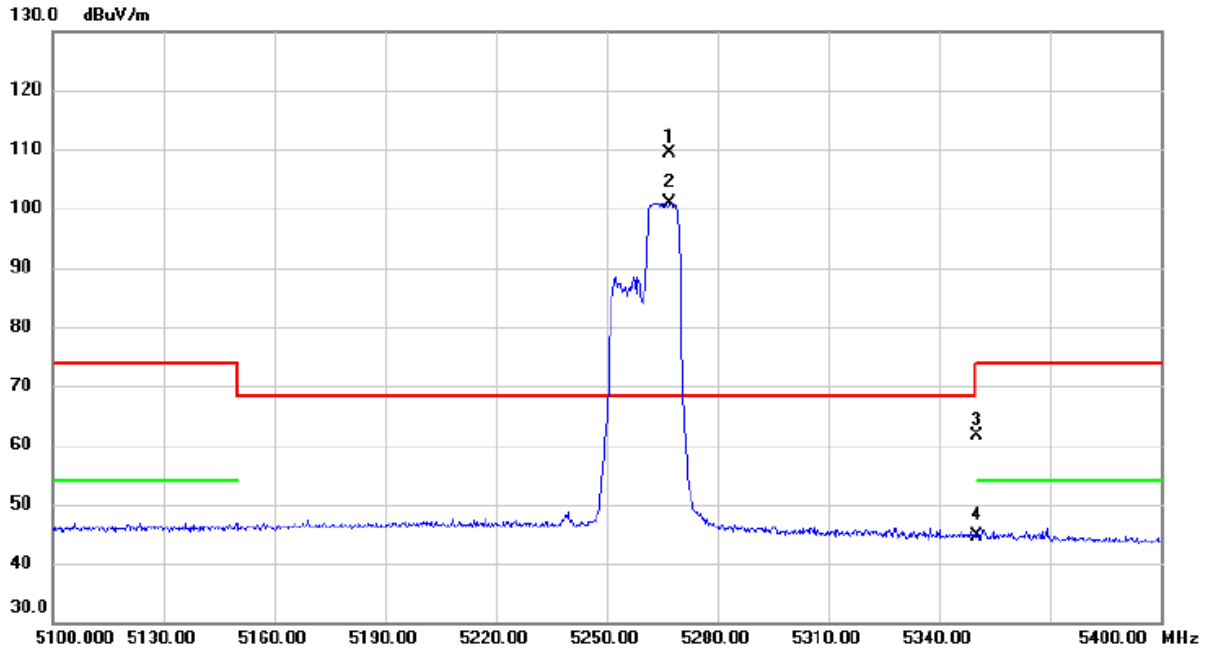

No.	Mk.	Freq. MHz	Reading Level dBuV	Correct Factor dB	Measure- ment dBuV/m	Limit dBuV/m	Margin dB	Detector	Comment
1	*	5267.100	71.92	37.58	109.50	68.30	41.20	peak	No limit
2	X	5267.100	63.42	37.58	101.00	68.30	32.70	AVG	No limit
3		5350.000	23.82	37.73	61.55	74.00	-12.45	peak	
4		5350.000	7.00	37.73	44.73	54.00	-9.27	AVG	

REMARKS:

- (1) Measurement Value = Reading Level + Correct Factor.
- (2) Margin Level = Measurement Value - Limit Value.

Orthogonal Axis	X		
Test Mode	UNII-2A_TX AX (HE20) Mode 5260 MHz	RU configuration	242/61

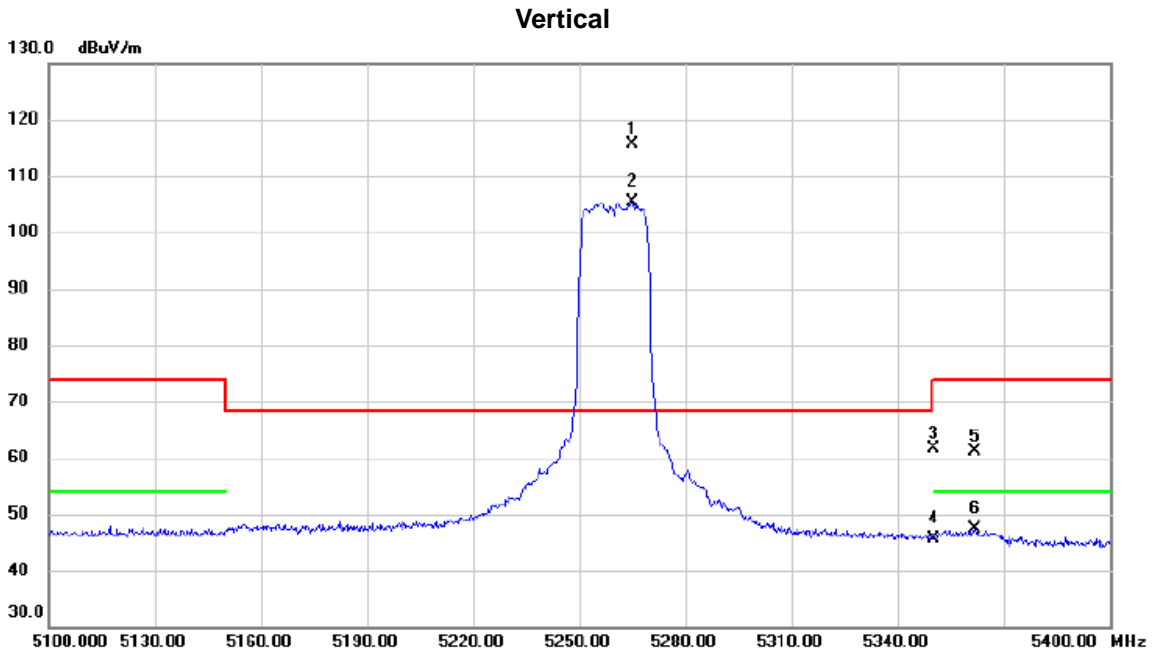

No.	Mk.	Freq. MHz	Reading Level dBuV	Correct Factor dB	Measure- ment dBuV/m	Limit dBuV/m	Margin dB	Detector	Comment
1	*	5265.000	78.17	37.58	115.75	68.30	47.45	peak	No limit
2	X	5265.000	67.76	37.58	105.34	68.30	37.04	AVG	No limit
3		5350.000	24.01	37.73	61.74	74.00	-12.26	peak	
4		5350.000	7.83	37.73	45.56	54.00	-8.44	AVG	
5		5361.600	23.40	37.78	61.18	74.00	-12.82	peak	
6		5361.600	9.48	37.78	47.26	54.00	-6.74	AVG	

REMARKS:

- (1) Measurement Value = Reading Level + Correct Factor.
- (2) Margin Level = Measurement Value - Limit Value.

Orthogonal Axis	X		
Test Mode	UNII-2A_TX AX (HE20) Mode 5260 MHz	RU configuration	242/61

Horizontal

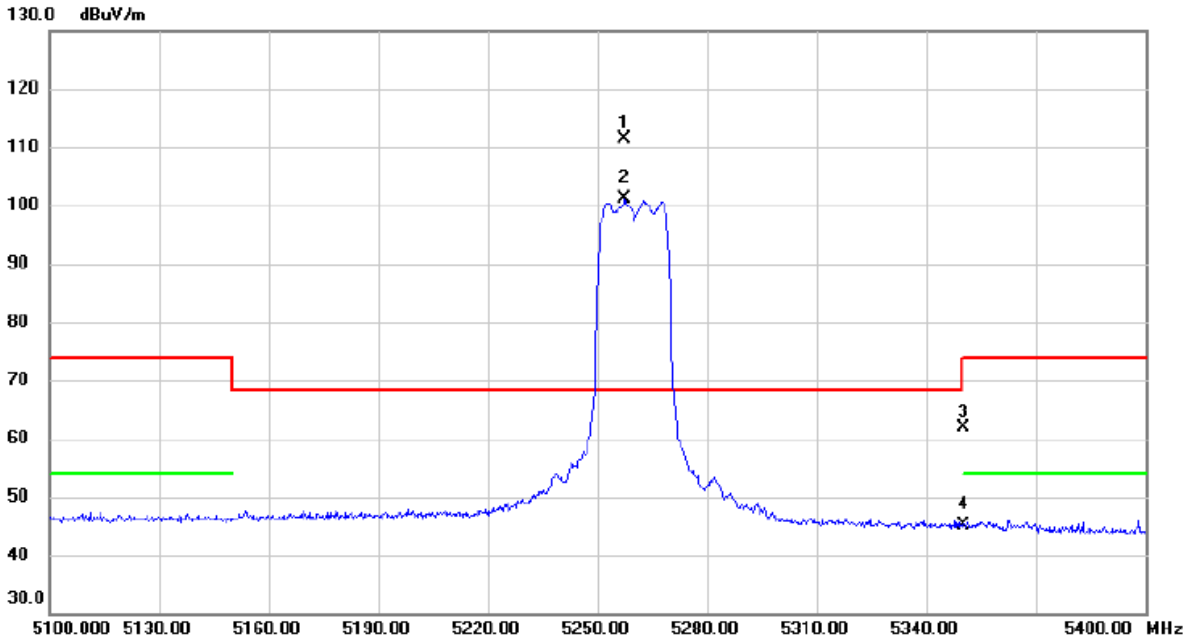

No.	Mk.	Freq. MHz	Reading Level dBuV	Correct Factor dB	Measure- ment dBuV/m	Limit dBuV/m	Margin dB	Detector	Comment
1	*	5257.500	73.81	37.59	111.40	68.30	43.10	peak	No limit
2	X	5257.500	63.43	37.59	101.02	68.30	32.72	AVG	No limit
3		5350.000	24.03	37.73	61.76	74.00	-12.24	peak	
4		5350.000	7.38	37.73	45.11	54.00	-8.89	AVG	

REMARKS:

- (1) Measurement Value = Reading Level + Correct Factor.
- (2) Margin Level = Measurement Value - Limit Value.

Orthogonal Axis	X		
Test Mode	UNII-2A_TX AX (HE20) Mode 5260 MHz	RU configuration	242/61

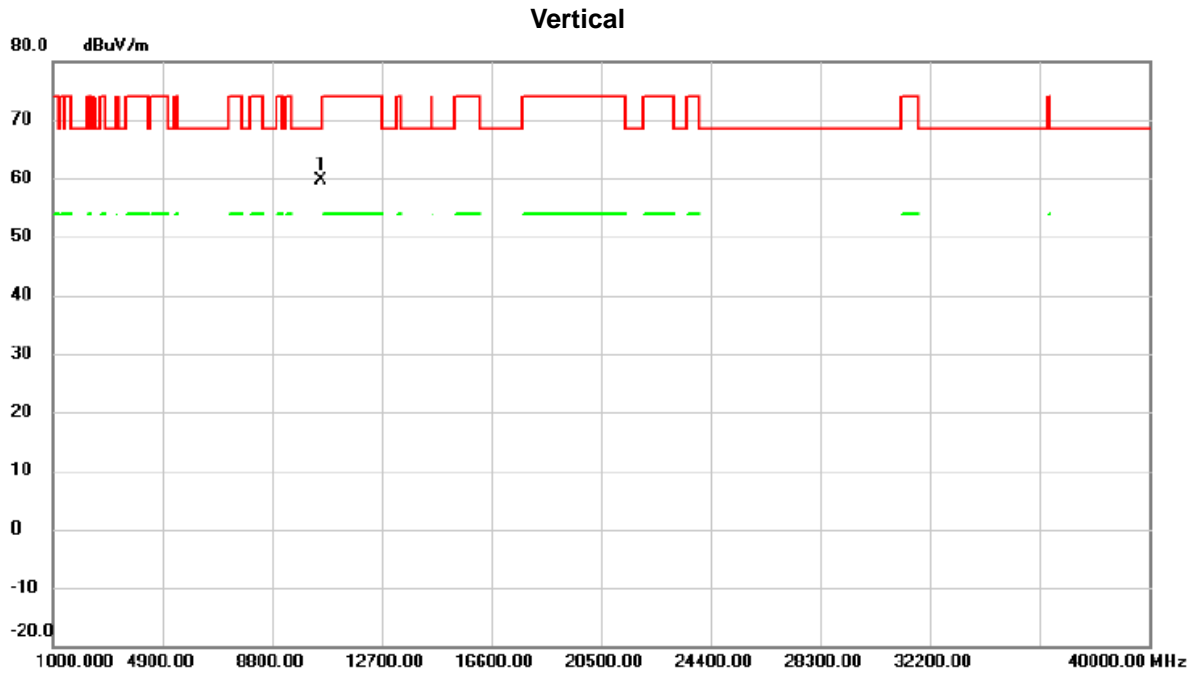

No.	Mk.	Freq. MHz	Reading Level dBuV	Correct Factor dB	Measure- ment dBuV/m	Limit dBuV/m	Margin dB	Detector	Comment
1	*	10522.47	57.83	1.84	59.67	68.30	-8.63	peak	

REMARKS:

- (1) Measurement Value = Reading Level + Correct Factor.
- (2) Margin Level = Measurement Value - Limit Value.

Orthogonal Axis	X		
Test Mode	UNII-2A_TX AX (HE20) Mode 5260 MHz	RU configuration	242/61

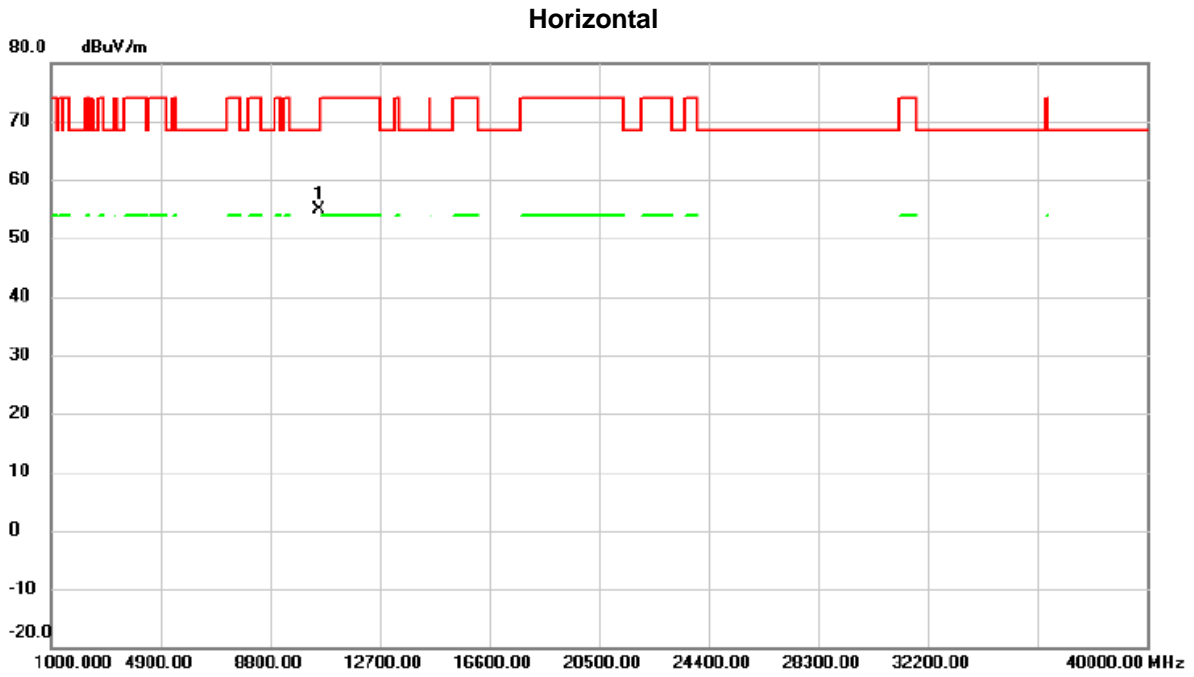

No.	Mk.	Freq. MHz	Reading Level dBuV	Correct Factor dB	Measure- ment dBuV/m	Limit dBuV/m	Margin dB	Detector	Comment
1	*	10520.36	53.09	1.84	54.93	68.30	-13.37	peak	

REMARKS:

- (1) Measurement Value = Reading Level + Correct Factor.
- (2) Margin Level = Measurement Value - Limit Value.

Orthogonal Axis	X		
Test Mode	UNII-2A_TX AX (HE20) Mode 5300 MHz	RU configuration	52/40

Vertical

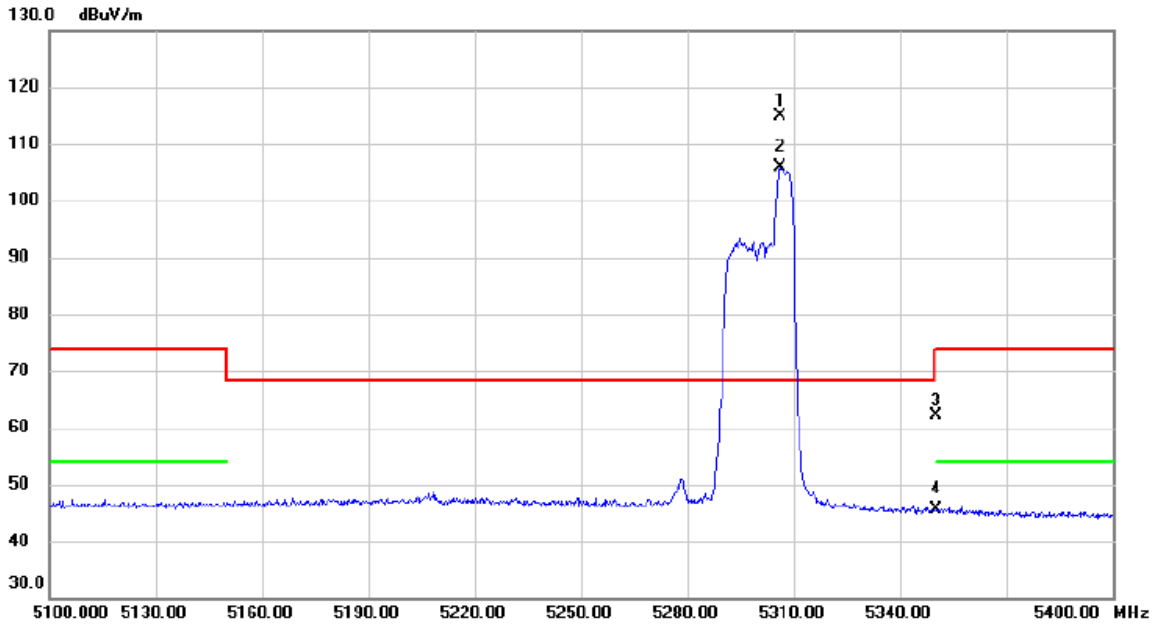

No.	Mk.	Freq. MHz	Reading Level dBuV	Correct Factor dB	Measure- ment dBuV/m	Limit dBuV/m	Margin dB	Detector	Comment
1	*	5306.250	77.34	37.56	114.90	68.30	46.60	peak	No limit
2	X	5306.250	68.24	37.56	105.80	68.30	37.50	AVG	No limit
3		5350.000	24.46	37.73	62.19	74.00	-11.81	peak	
4		5350.000	7.78	37.73	45.51	54.00	-8.49	AVG	

REMARKS:

- (1) Measurement Value = Reading Level + Correct Factor.
- (2) Margin Level = Measurement Value - Limit Value.

Orthogonal Axis	X		
Test Mode	UNII-2A_TX AX (HE20) Mode 5300 MHz	RU configuration	52/40

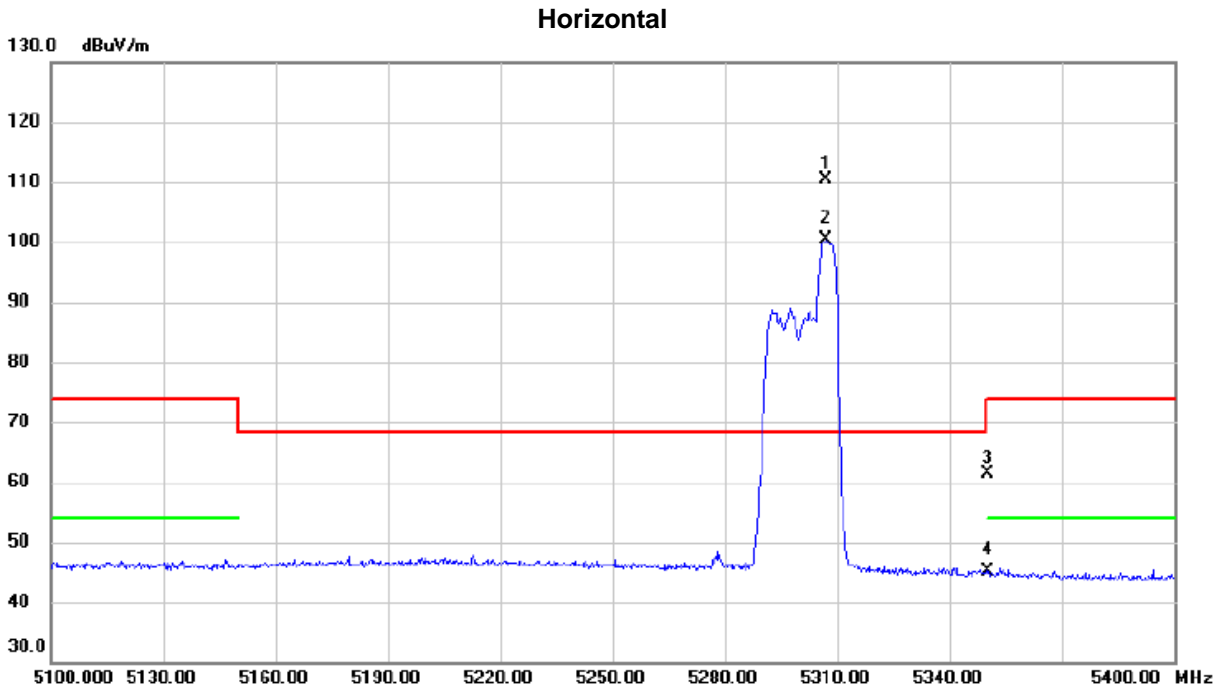

No.	Mk.	Freq. MHz	Reading Level dBuV	Correct Factor dB	Measure- ment dBuV/m	Limit dBuV/m	Margin dB	Detector	Comment
1	*	5306.850	72.85	37.56	110.41	68.30	42.11	peak	No limit
2	X	5306.850	62.77	37.56	100.33	68.30	32.03	AVG	No limit
3		5350.000	23.64	37.73	61.37	74.00	-12.63	peak	
4		5350.000	7.41	37.73	45.14	54.00	-8.86	AVG	

REMARKS:

- (1) Measurement Value = Reading Level + Correct Factor.
- (2) Margin Level = Measurement Value - Limit Value.

Orthogonal Axis	X		
Test Mode	UNII-2A_TX AX (HE20) Mode 5300 MHz	RU configuration	106/54

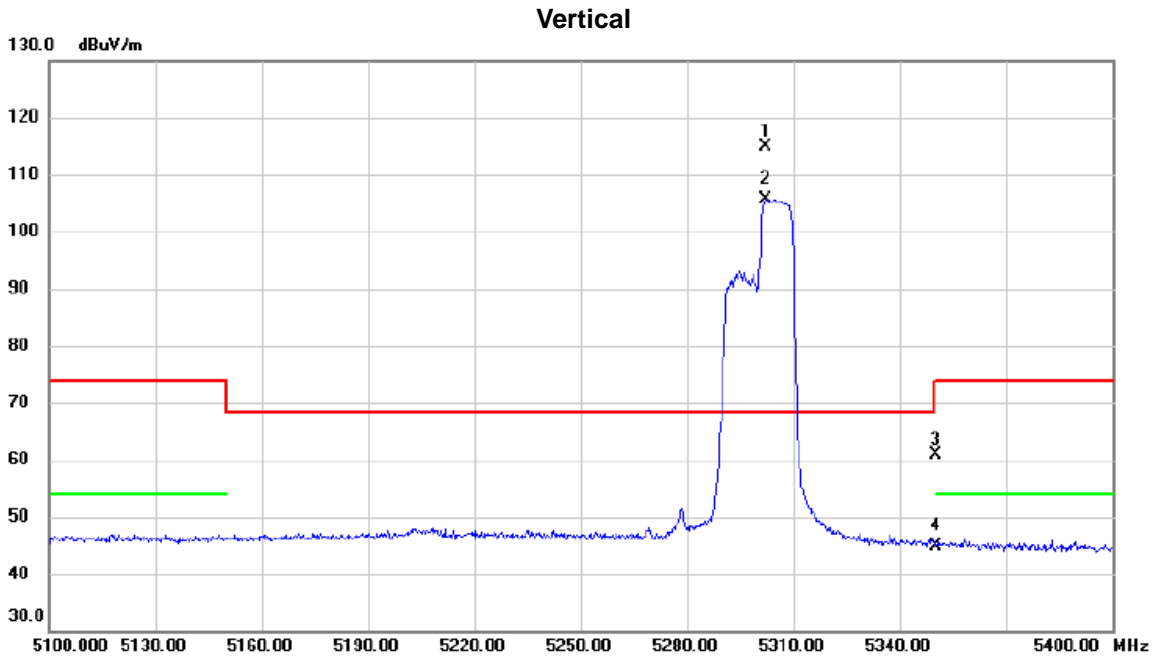

No.	Mk.	Freq. MHz	Reading Level dBuV	Correct Factor dB	Measure- ment dBuV/m	Limit dBuV/m	Margin dB	Detector	Comment
1	*	5302.200	77.28	37.55	114.83	68.30	46.53	peak	No limit
2	X	5302.200	68.03	37.55	105.58	68.30	37.28	AVG	No limit
3		5350.000	23.22	37.73	60.95	74.00	-13.05	peak	
4		5350.000	7.04	37.73	44.77	54.00	-9.23	AVG	

REMARKS:

- (1) Measurement Value = Reading Level + Correct Factor.
- (2) Margin Level = Measurement Value - Limit Value.

Orthogonal Axis	X		
Test Mode	UNII-2A_TX AX (HE20) Mode 5300 MHz	RU configuration	106/54

Horizontal

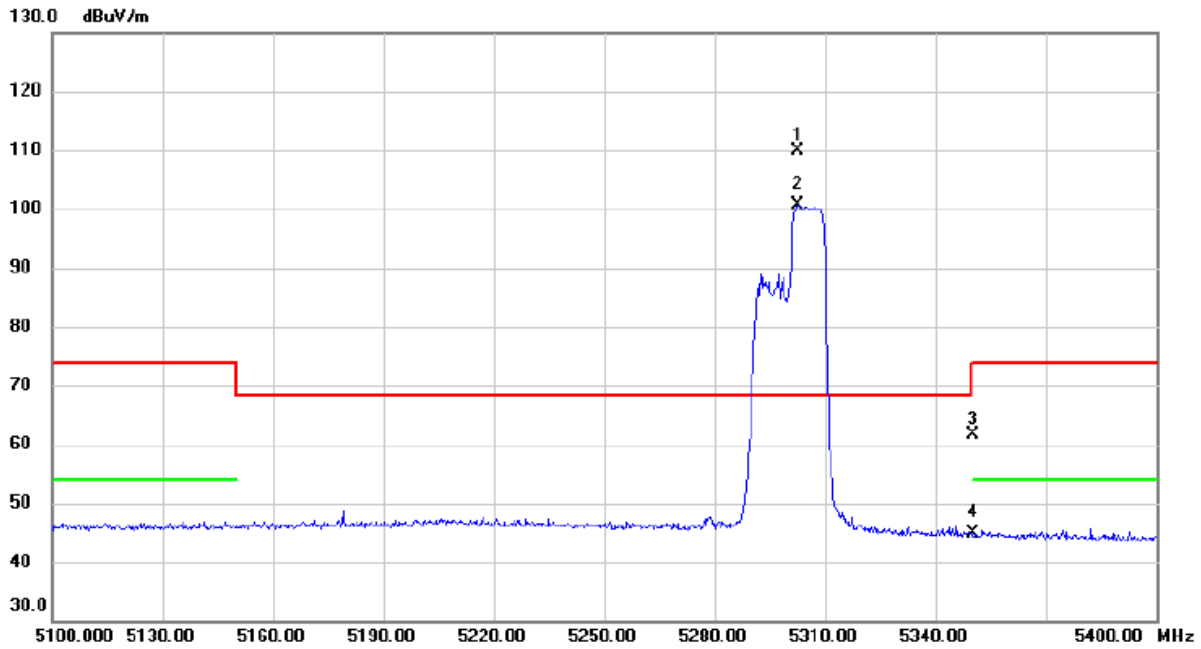

No.	Mk.	Freq.	Reading Level	Correct Factor	Measurement	Limit	Margin	Detector	Comment
		MHz	dBuV	dB	dBuV/m	dBuV/m	dB		
1	*	5302.500	72.22	37.55	109.77	68.30	41.47	peak	No limit
2	X	5302.500	63.10	37.55	100.65	68.30	32.35	AVG	No limit
3		5350.000	23.98	37.73	61.71	74.00	-12.29	peak	
4		5350.000	7.05	37.73	44.78	54.00	-9.22	AVG	

REMARKS:

- (1) Measurement Value = Reading Level + Correct Factor.
- (2) Margin Level = Measurement Value - Limit Value.

Orthogonal Axis	X		
Test Mode	UNII-2A_TX AX (HE20) Mode 5300 MHz	RU configuration	242/61

Vertical

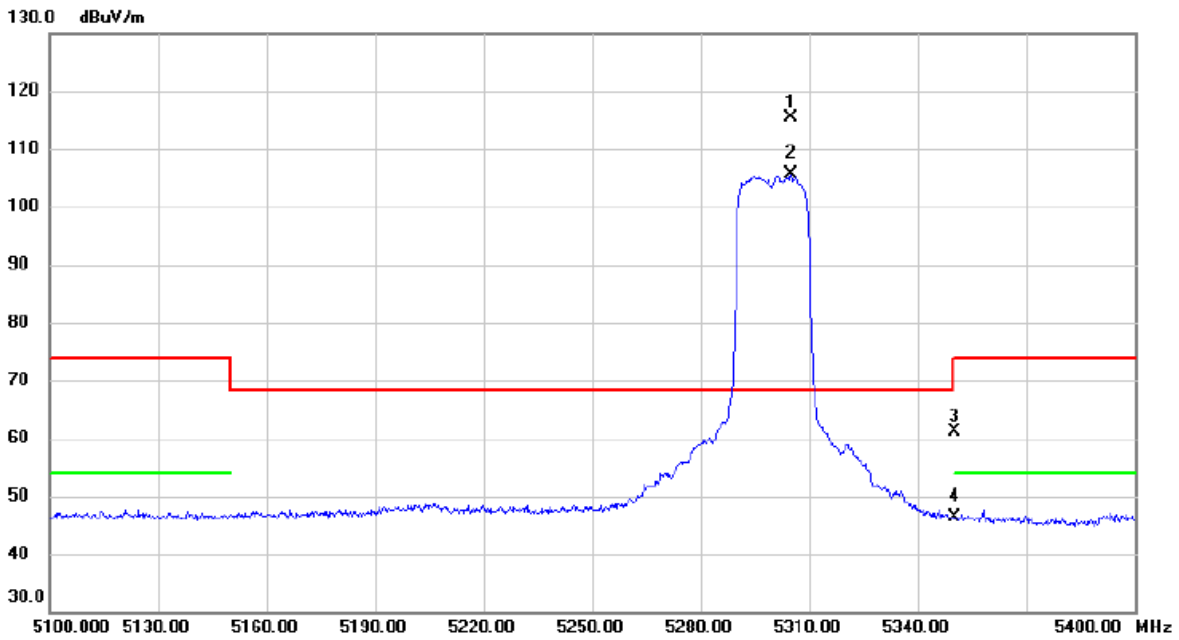

No.	Mk.	Freq. MHz	Reading Level dBuV	Correct Factor dB	Measure- ment dBuV/m	Limit dBuV/m	Margin dB	Detector	Comment
1	*	5305.050	77.84	37.56	115.40	68.30	47.10	peak	No limit
2	X	5305.050	68.13	37.56	105.69	68.30	37.39	AVG	No limit
3		5350.000	23.40	37.73	61.13	74.00	-12.87	peak	
4		5350.000	8.76	37.73	46.49	54.00	-7.51	AVG	

REMARKS:

- (1) Measurement Value = Reading Level + Correct Factor.
- (2) Margin Level = Measurement Value - Limit Value.

Orthogonal Axis	X		
Test Mode	UNII-2A_TX AX (HE20) Mode 5300 MHz	RU configuration	242/61

Horizontal

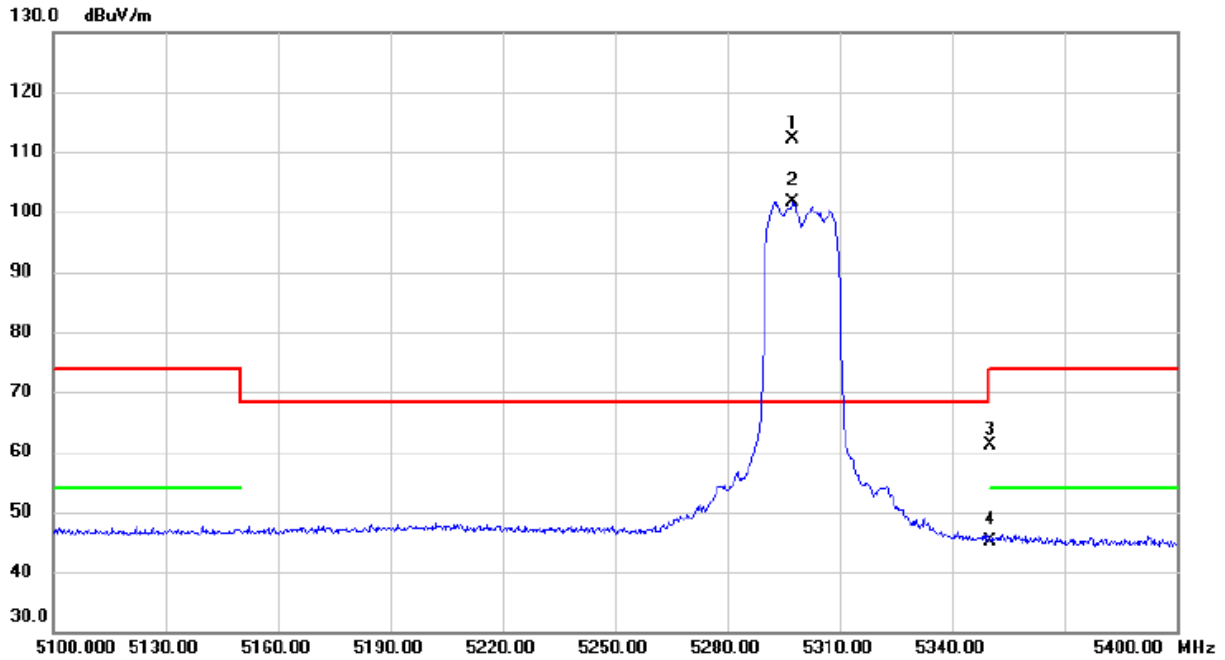

No.	Mk.	Freq. MHz	Reading Level dBuV	Correct Factor dB	Measure- ment dBuV/m	Limit dBuV/m	Margin dB	Detector	Comment
1	*	5297.550	74.57	37.54	112.11	68.30	43.81	peak	No limit
2	X	5297.550	63.99	37.54	101.53	68.30	33.23	AVG	No limit
3		5350.000	23.33	37.73	61.06	74.00	-12.94	peak	
4		5350.000	7.46	37.73	45.19	54.00	-8.81	AVG	

REMARKS:

- (1) Measurement Value = Reading Level + Correct Factor.
- (2) Margin Level = Measurement Value - Limit Value.

Orthogonal Axis	X		
Test Mode	UNII-2A_TX AX (HE20) Mode 5300 MHz	RU configuration	242/61

Vertical

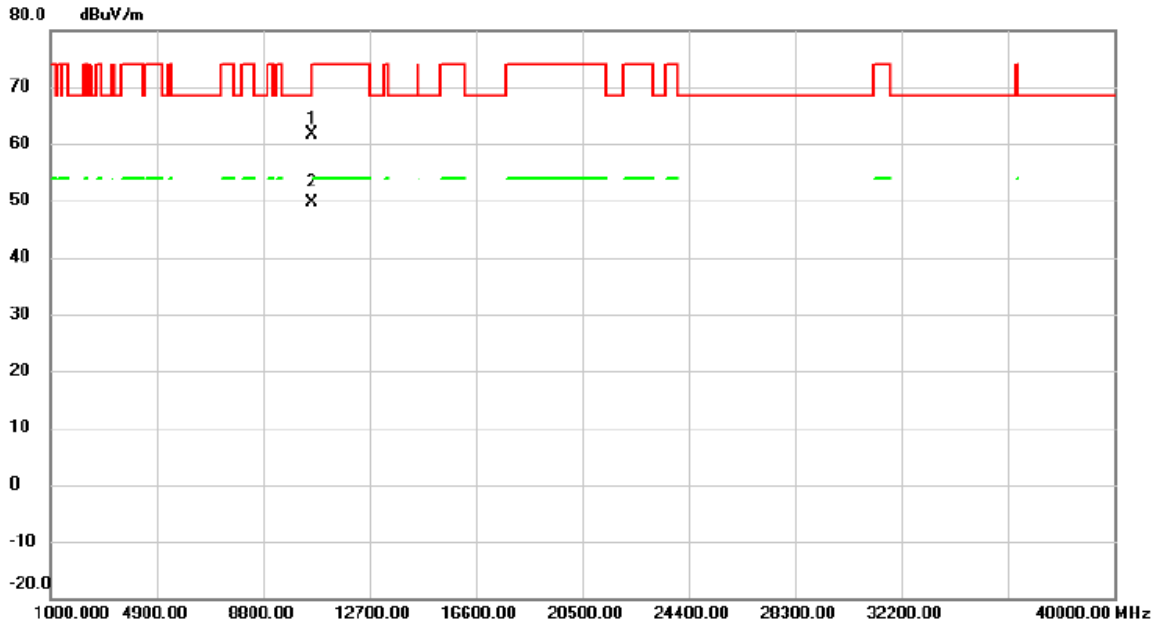

No.	Mk.	Freq. MHz	Reading Level dBuV	Correct Factor dB	Measure- ment dBuV/m	Limit dBuV/m	Margin dB	Detector	Comment
1		10611.35	59.61	1.93	61.54	74.00	-12.46	peak	
2	*	10611.70	47.61	1.93	49.54	54.00	-4.46	AVG	

REMARKS:

- (1) Measurement Value = Reading Level + Correct Factor.
- (2) Margin Level = Measurement Value - Limit Value.

Orthogonal Axis	X		
Test Mode	UNII-2A_TX AX (HE20) Mode 5300 MHz	RU configuration	242/61

Horizontal

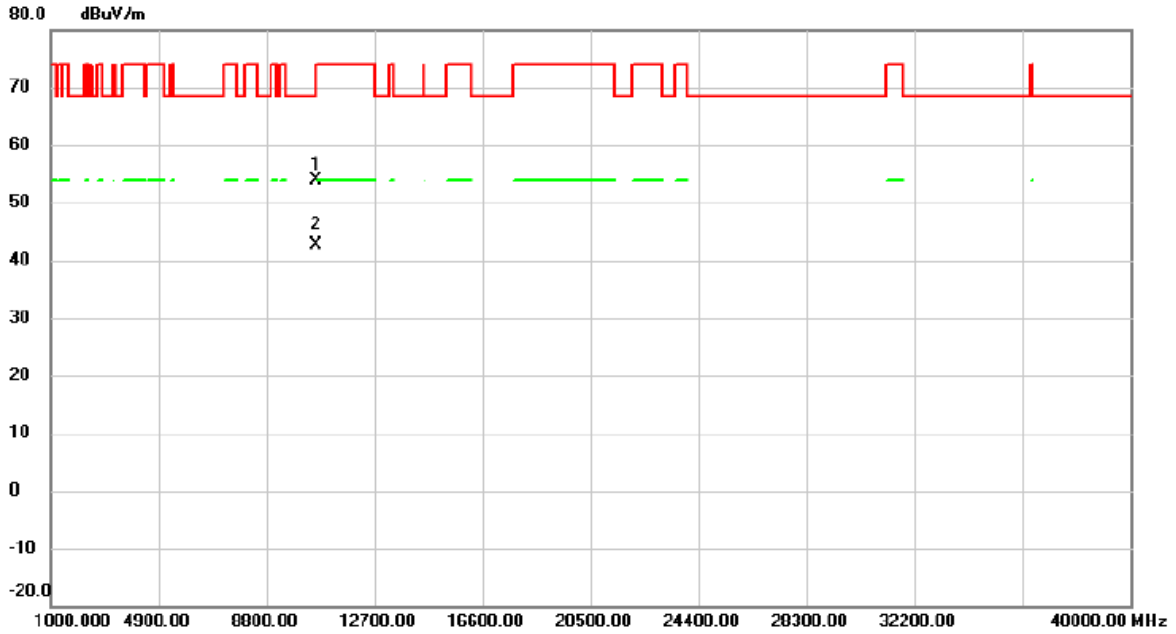

No.	Mk.	Freq. MHz	Reading Level dBuV	Correct Factor dB	Measure- ment dBuV/m	Limit dBuV/m	Margin dB	Detector	Comment
1		10609.07	51.97	1.93	53.90	74.00	-20.10	peak	
2	*	10610.80	40.79	1.93	42.72	54.00	-11.28	AVG	

REMARKS:

- (1) Measurement Value = Reading Level + Correct Factor.
- (2) Margin Level = Measurement Value - Limit Value.

Orthogonal Axis	X		
Test Mode	UNII-2A_TX AX (HE20) Mode 5320 MHz	RU configuration	52/40

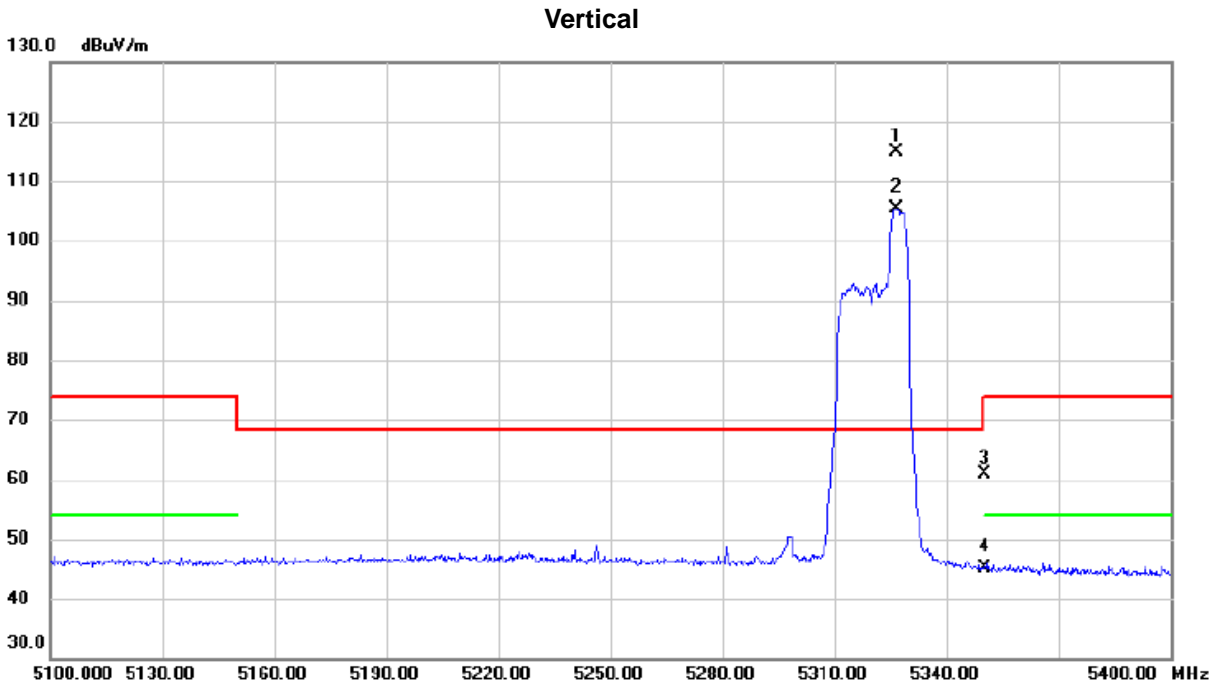

No.	Mk.	Freq. MHz	Reading Level dBuV	Correct Factor dB	Measure- ment dBuV/m	Limit dBuV/m	Margin dB	Detector	Comment
1	*	5326.500	77.29	37.64	114.93	68.30	46.63	peak	No limit
2	X	5326.500	67.82	37.64	105.46	68.30	37.16	AVG	No limit
3		5350.000	23.19	37.73	60.92	74.00	-13.08	peak	
4		5350.000	7.40	37.73	45.13	54.00	-8.87	AVG	

REMARKS:

- (1) Measurement Value = Reading Level + Correct Factor.
- (2) Margin Level = Measurement Value - Limit Value.

Orthogonal Axis	X		
Test Mode	UNII-2A_TX AX (HE20) Mode 5320 MHz	RU configuration	52/40

Horizontal

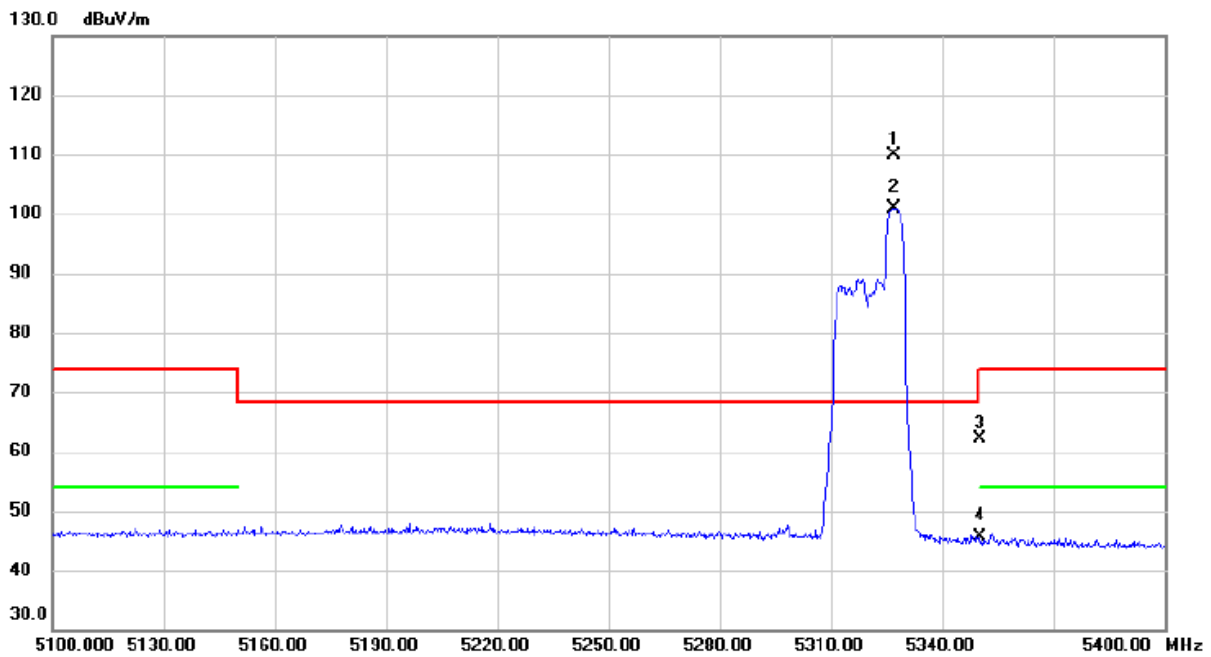

No.	Mk.	Freq. MHz	Reading Level dBuV	Correct Factor dB	Measure- ment dBuV/m	Limit dBuV/m	Margin dB	Detector	Comment
1	*	5326.950	72.24	37.64	109.88	68.30	41.58	peak	No limit
2	X	5326.950	63.30	37.64	100.94	68.30	32.64	AVG	No limit
3		5350.000	24.33	37.73	62.06	74.00	-11.94	peak	
4		5350.000	7.88	37.73	45.61	54.00	-8.39	AVG	

REMARKS:

- (1) Measurement Value = Reading Level + Correct Factor.
- (2) Margin Level = Measurement Value - Limit Value.

Orthogonal Axis	X		
Test Mode	UNII-2A_TX AX (HE20) Mode 5320 MHz	RU configuration	106/54

Vertical

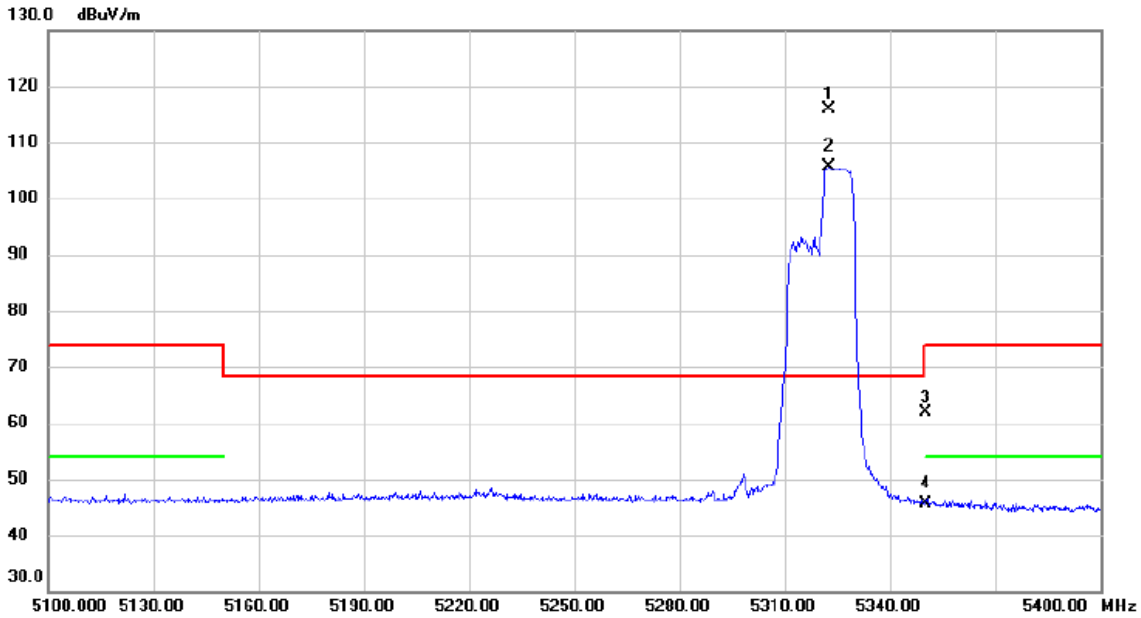

No.	Mk.	Freq. MHz	Reading Level dBuV	Correct Factor dB	Measure- ment dBuV/m	Limit dBuV/m	Margin dB	Detector	Comment
1	*	5322.600	78.24	37.63	115.87	68.30	47.57	peak	No limit
2	X	5322.600	67.95	37.63	105.58	68.30	37.28	AVG	No limit
3		5350.000	24.11	37.73	61.84	74.00	-12.16	peak	
4		5350.000	7.90	37.73	45.63	54.00	-8.37	AVG	

REMARKS:

- (1) Measurement Value = Reading Level + Correct Factor.
- (2) Margin Level = Measurement Value - Limit Value.

Orthogonal Axis	X		
Test Mode	UNII-2A_TX AX (HE20) Mode 5320 MHz	RU configuration	106/54

Horizontal

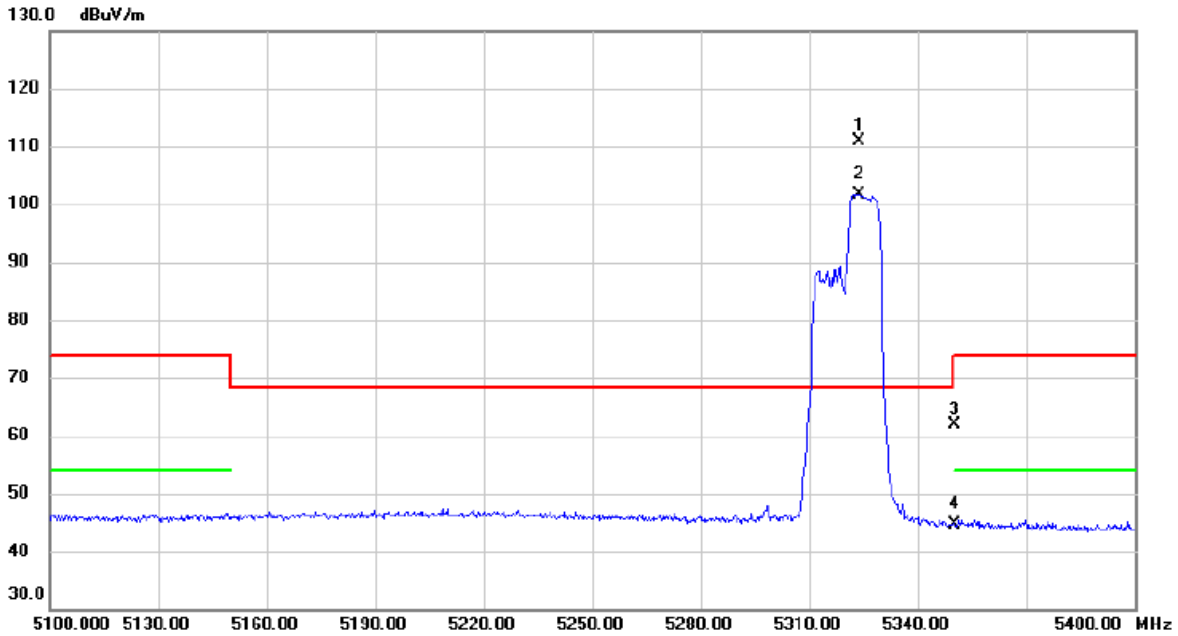

No.	Mk.	Freq. MHz	Reading Level dBuV	Correct Factor dB	Measure- ment dBuV/m	Limit dBuV/m	Margin dB	Detector	Comment
1	*	5323.650	73.35	37.63	110.98	68.30	42.68	peak	No limit
2	X	5323.650	64.03	37.63	101.66	68.30	33.36	AVG	No limit
3		5350.000	24.22	37.73	61.95	74.00	-12.05	peak	
4		5350.000	6.84	37.73	44.57	54.00	-9.43	AVG	

REMARKS:

- (1) Measurement Value = Reading Level + Correct Factor.
- (2) Margin Level = Measurement Value - Limit Value.

Orthogonal Axis	X		
Test Mode	UNII-2A_TX AX (HE20) Mode 5320 MHz	RU configuration	242/61

Vertical

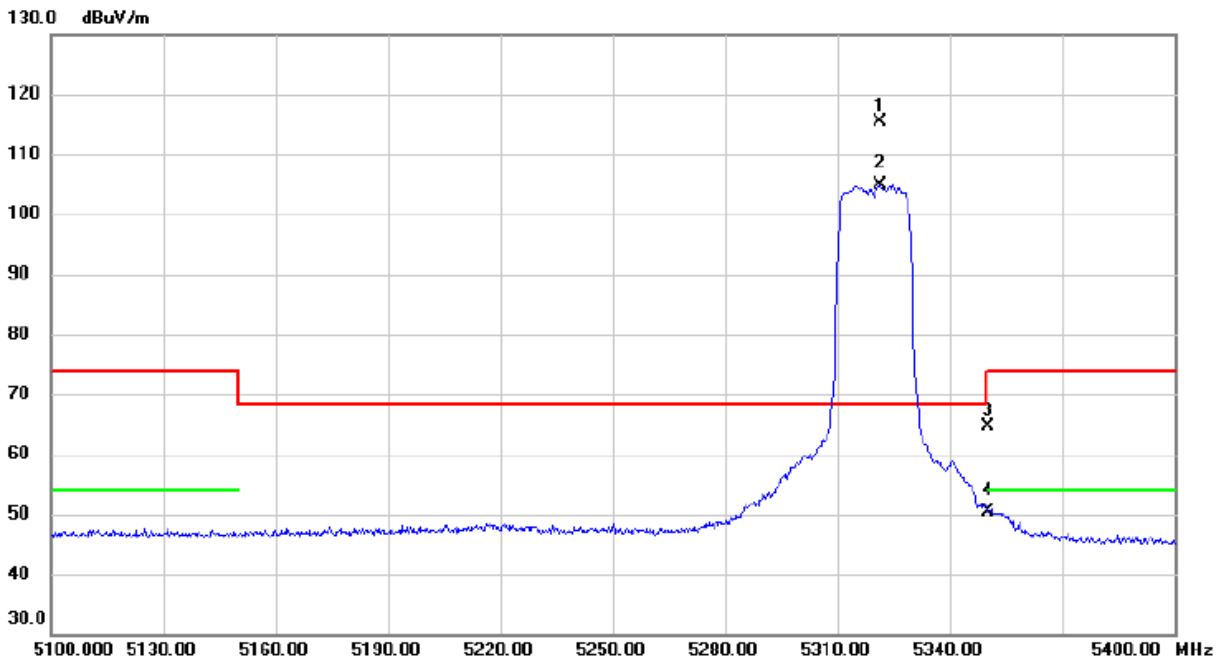

No.	Mk.	Freq. MHz	Reading Level dBuV	Correct Factor dB	Measure- ment dBuV/m	Limit dBuV/m	Margin dB	Detector	Comment
1	*	5321.250	77.77	37.63	115.40	68.30	47.10	peak	No limit
2	X	5321.250	67.35	37.63	104.98	68.30	36.68	AVG	No limit
3		5350.000	27.01	37.73	64.74	74.00	-9.26	peak	
4		5350.000	12.57	37.73	50.30	54.00	-3.70	AVG	

REMARKS:

- (1) Measurement Value = Reading Level + Correct Factor.
- (2) Margin Level = Measurement Value - Limit Value.

Orthogonal Axis	X		
Test Mode	UNII-2A_TX AX (HE20) Mode 5320 MHz	RU configuration	242/61

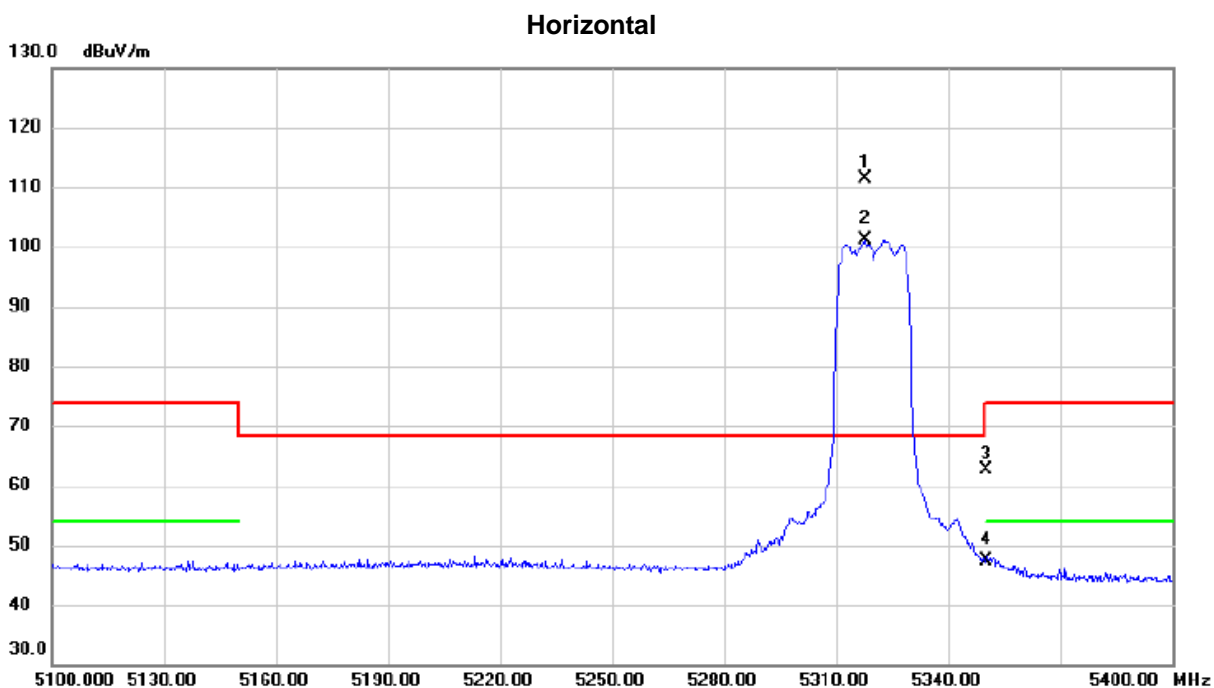

No.	Mk.	Freq. MHz	Reading Level dBuV	Correct Factor dB	Measure- ment dBuV/m	Limit dBuV/m	Margin dB	Detector	Comment
1	*	5317.650	73.90	37.60	111.50	68.30	43.20	peak	No limit
2	X	5317.650	63.59	37.60	101.19	68.30	32.89	AVG	No limit
3		5350.000	24.96	37.73	62.69	74.00	-11.31	peak	
4		5350.000	9.71	37.73	47.44	54.00	-6.56	AVG	

REMARKS:

(1) Measurement Value = Reading Level + Correct Factor.

(2) Margin Level = Measurement Value - Limit Value.

Orthogonal Axis	X		
Test Mode	UNII-2A_TX AX (HE20) Mode 5320 MHz	RU configuration	242/61

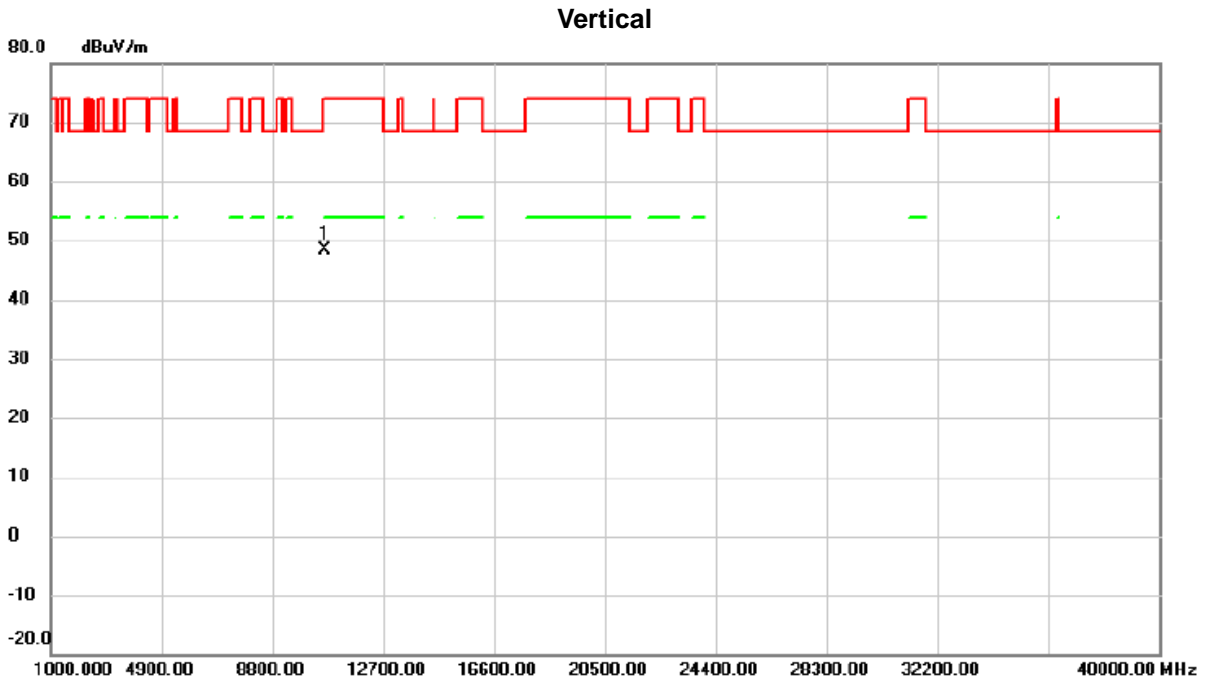

No.	Mk.	Freq. MHz	Reading Level dBuV	Correct Factor dB	Measure- ment dBuV/m	Limit dBuV/m	Margin dB	Detector	Comment
1	*	10634.17	46.48	1.93	48.41	74.00	-25.59	peak	

REMARKS:

- (1) Measurement Value = Reading Level + Correct Factor.
- (2) Margin Level = Measurement Value - Limit Value.

Orthogonal Axis	X		
Test Mode	UNII-2A_TX AX (HE20) Mode 5320 MHz	RU configuration	242/61

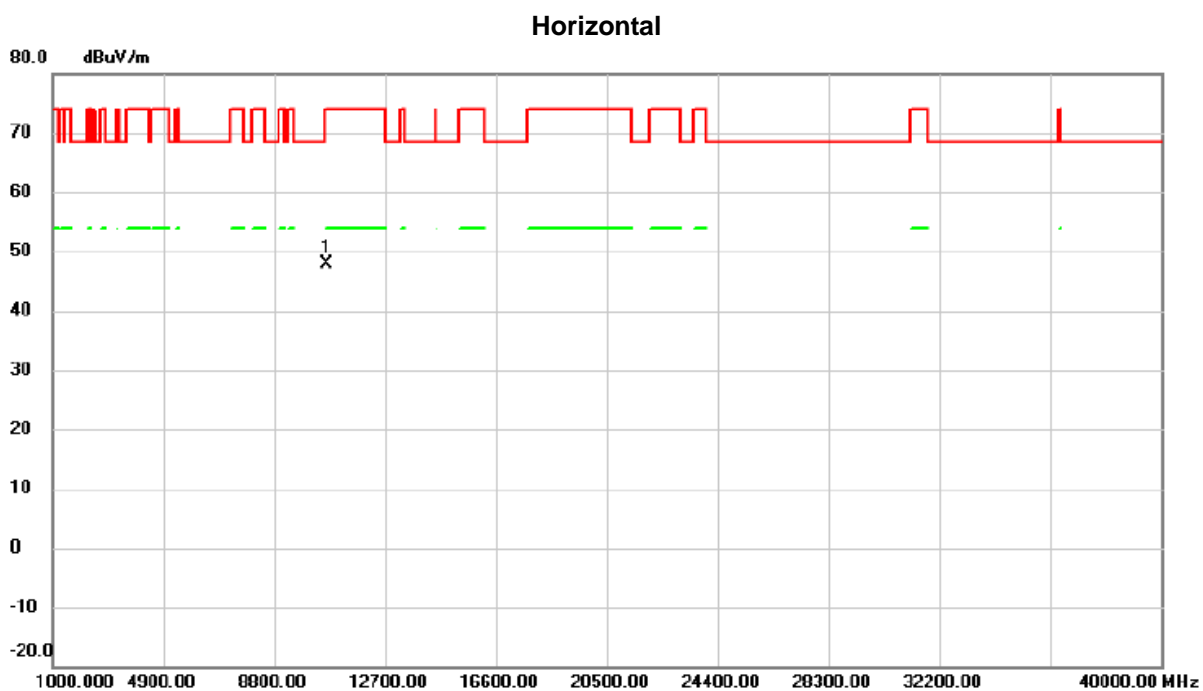

No.	Mk.	Freq. MHz	Reading Level dBuV	Correct Factor dB	Measure- ment dBuV/m	Limit dBuV/m	Margin dB	Detector	Comment
1	*	10640.72	45.92	1.93	47.85	74.00	-26.15	peak	

REMARKS:

- (1) Measurement Value = Reading Level + Correct Factor.
- (2) Margin Level = Measurement Value - Limit Value.

Orthogonal Axis	X		
Test Mode	UNII-2C_TX AX (HE20) Mode 5500 MHz	RU configuration	52/37

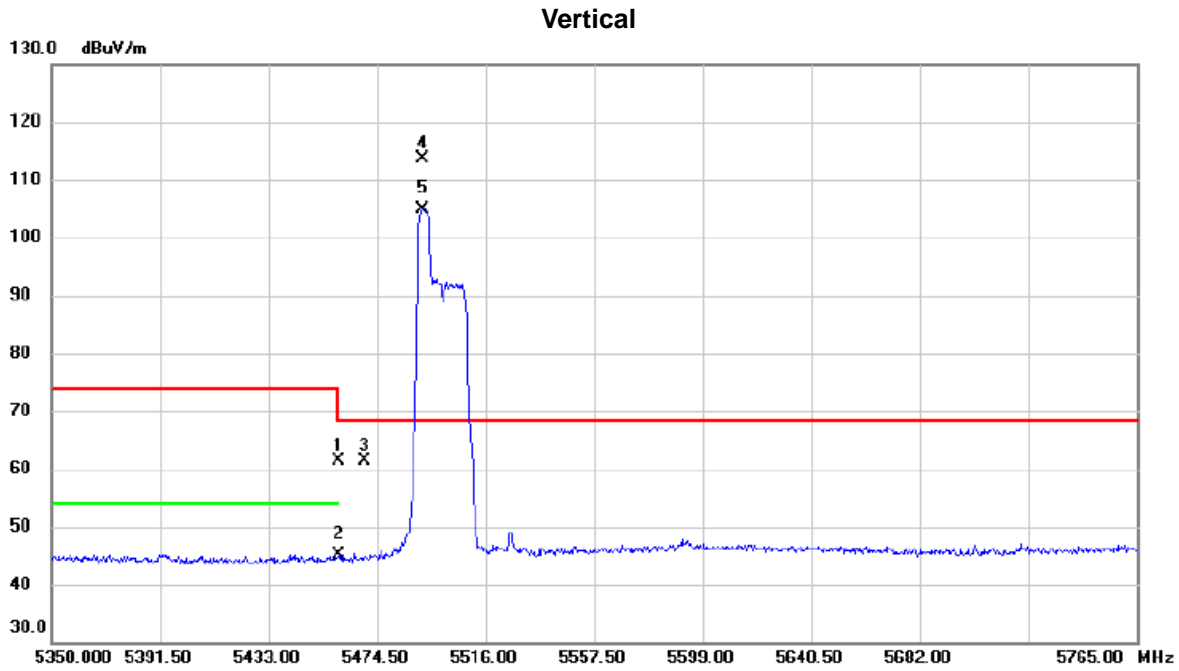

No.	Mk.	Freq. MHz	Reading Level dBuV	Correct Factor dB	Measure- ment dBuV/m	Limit dBuV/m	Margin dB	Detector	Comment
1		5460.000	23.28	38.12	61.40	74.00	-12.60	peak	
2		5460.000	7.10	38.12	45.22	54.00	-8.78	AVG	
3		5470.000	23.24	38.15	61.39	68.30	-6.91	peak	
4	*	5491.930	75.35	38.21	113.56	68.30	45.26	peak	No limit
5	X	5491.930	66.78	38.21	104.99	68.30	36.69	AVG	No limit

REMARKS:

(1) Measurement Value = Reading Level + Correct Factor.

(2) Margin Level = Measurement Value - Limit Value.

Orthogonal Axis	X		
Test Mode	UNII-2C_TX AX (HE20) Mode 5500 MHz	RU configuration	52/37

Horizontal

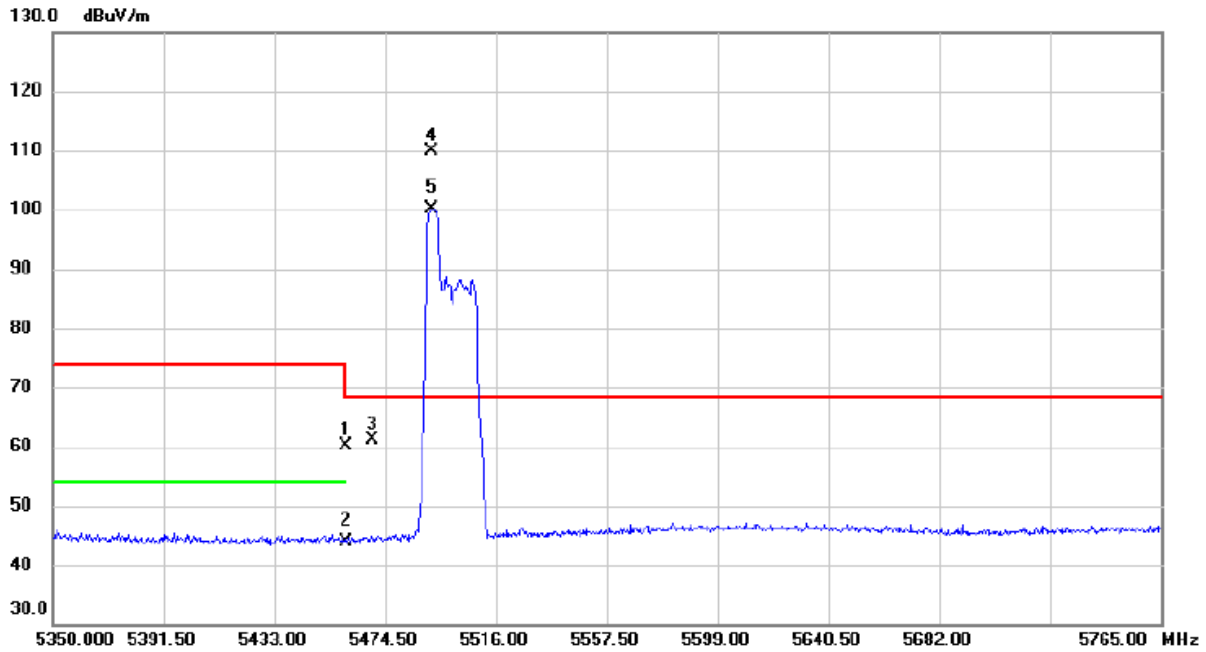

No.	Mk.	Freq. MHz	Reading Level dBuV	Correct Factor dB	Measure- ment dBuV/m	Limit dBuV/m	Margin dB	Detector	Comment
1		5460.000	21.95	38.12	60.07	74.00	-13.93	peak	
2		5460.000	5.85	38.12	43.97	54.00	-10.03	AVG	
3		5470.000	22.95	38.15	61.10	68.30	-7.20	peak	
4	*	5492.137	71.60	38.21	109.81	68.30	41.51	peak	No limit
5	X	5492.137	62.03	38.21	100.24	68.30	31.94	AVG	No limit

REMARKS:

(1) Measurement Value = Reading Level + Correct Factor.

(2) Margin Level = Measurement Value - Limit Value.

Orthogonal Axis	X		
Test Mode	UNII-2C_TX AX (HE20) Mode 5500 MHz	RU configuration	106/54

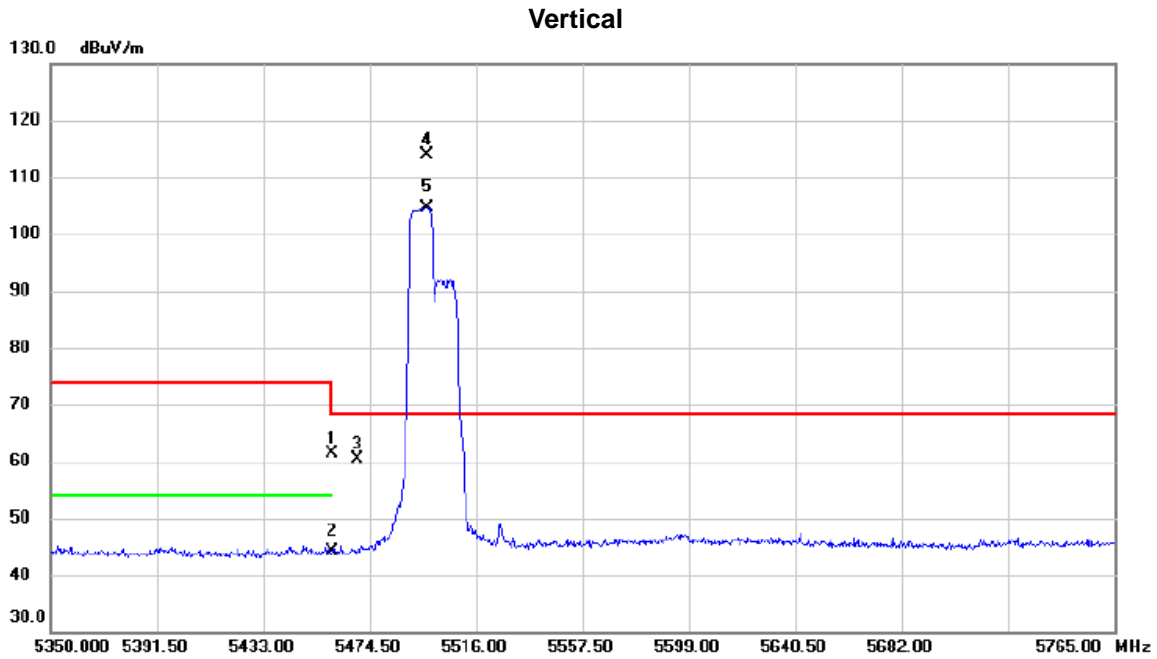

No.	Mk.	Freq. MHz	Reading Level dBuV	Correct Factor dB	Measure- ment dBuV/m	Limit dBuV/m	Margin dB	Detector	Comment
1		5460.000	23.24	38.12	61.36	74.00	-12.64	peak	
2		5460.000	6.05	38.12	44.17	54.00	-9.83	AVG	
3		5470.000	22.11	38.15	60.26	68.30	-8.04	peak	
4	*	5496.910	75.72	38.23	113.95	68.30	45.65	peak	No limit
5	X	5496.910	66.38	38.23	104.61	68.30	36.31	AVG	No limit

REMARKS:

- (1) Measurement Value = Reading Level + Correct Factor.
- (2) Margin Level = Measurement Value - Limit Value.

Orthogonal Axis	X		
Test Mode	UNII-2C_TX AX (HE20) Mode 5500 MHz	RU configuration	106/53

Horizontal

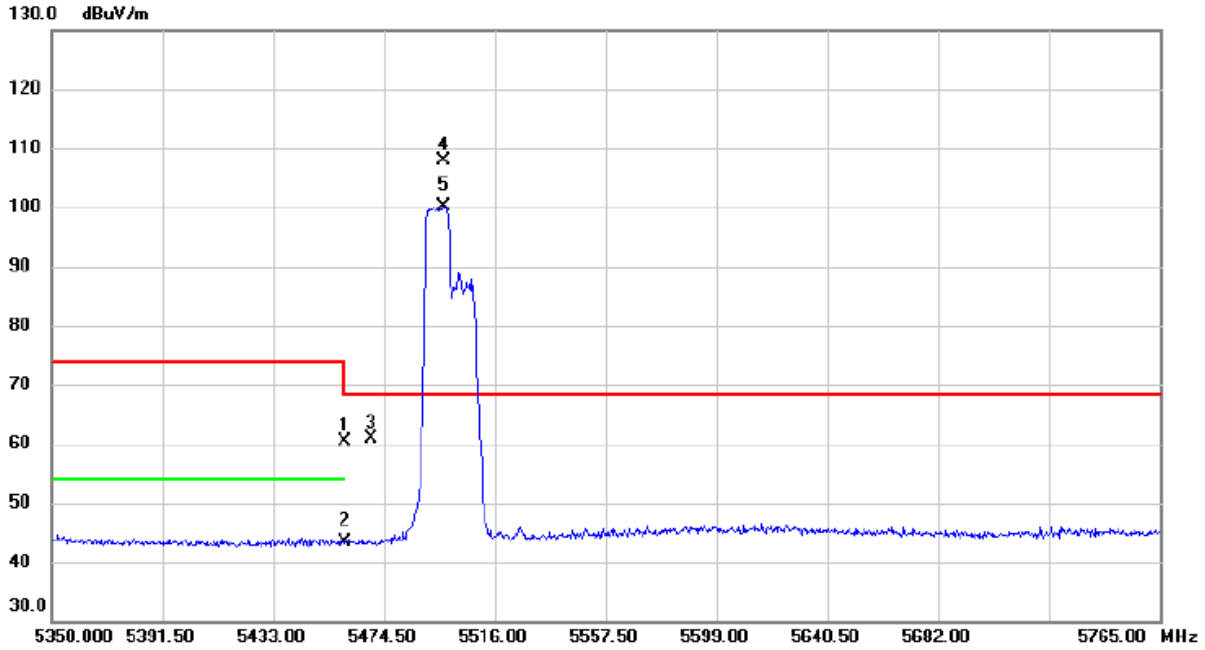

No.	Mk.	Freq. MHz	Reading Level dBuV	Correct Factor dB	Measure- ment dBuV/m	Limit dBuV/m	Margin dB	Detector	Comment
1		5460.000	22.33	38.12	60.45	74.00	-13.55	peak	
2		5460.000	5.25	38.12	43.37	54.00	-10.63	AVG	
3		5470.000	22.82	38.15	60.97	68.30	-7.33	peak	
4	*	5496.703	69.60	38.23	107.83	68.30	39.53	peak	No limit
5	X	5496.703	61.79	38.23	100.02	68.30	31.72	AVG	No limit

REMARKS:

(1) Measurement Value = Reading Level + Correct Factor.

(2) Margin Level = Measurement Value - Limit Value.

Orthogonal Axis	X		
Test Mode	UNII-2C_TX AX (HE20) Mode 5745 MHz	RU configuration	242/61

Vertical

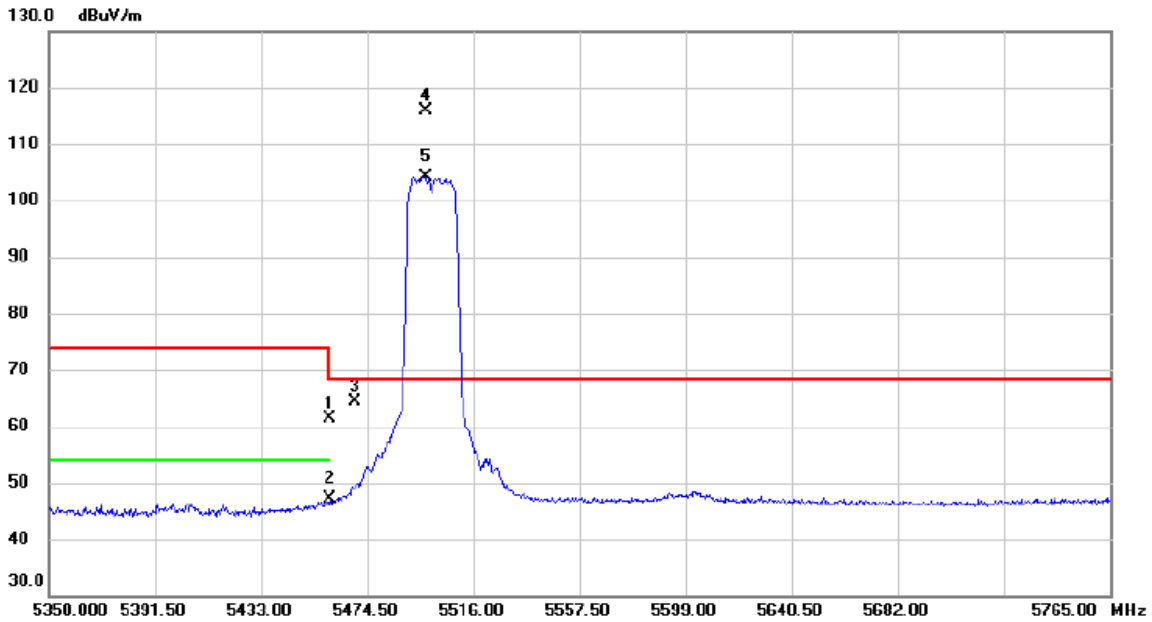

No.	Mk.	Freq. MHz	Reading Level dBuV	Correct Factor dB	Measure- ment dBuV/m	Limit dBuV/m	Margin dB	Detector	Comment
1		5460.000	23.31	38.12	61.43	74.00	-12.57	peak	
2		5460.000	9.05	38.12	47.17	54.00	-6.83	AVG	
3		5470.000	26.13	38.15	64.28	68.30	-4.02	peak	
4	*	5497.533	77.71	38.23	115.94	68.30	47.64	peak	No limit
5	X	5497.533	65.92	38.23	104.15	68.30	35.85	AVG	No limit

REMARKS:

(1) Measurement Value = Reading Level + Correct Factor.

(2) Margin Level = Measurement Value - Limit Value.

Orthogonal Axis	X		
Test Mode	UNII-2C_TX AX (HE20) Mode 5500 MHz	RU configuration	242/61

Horizontal

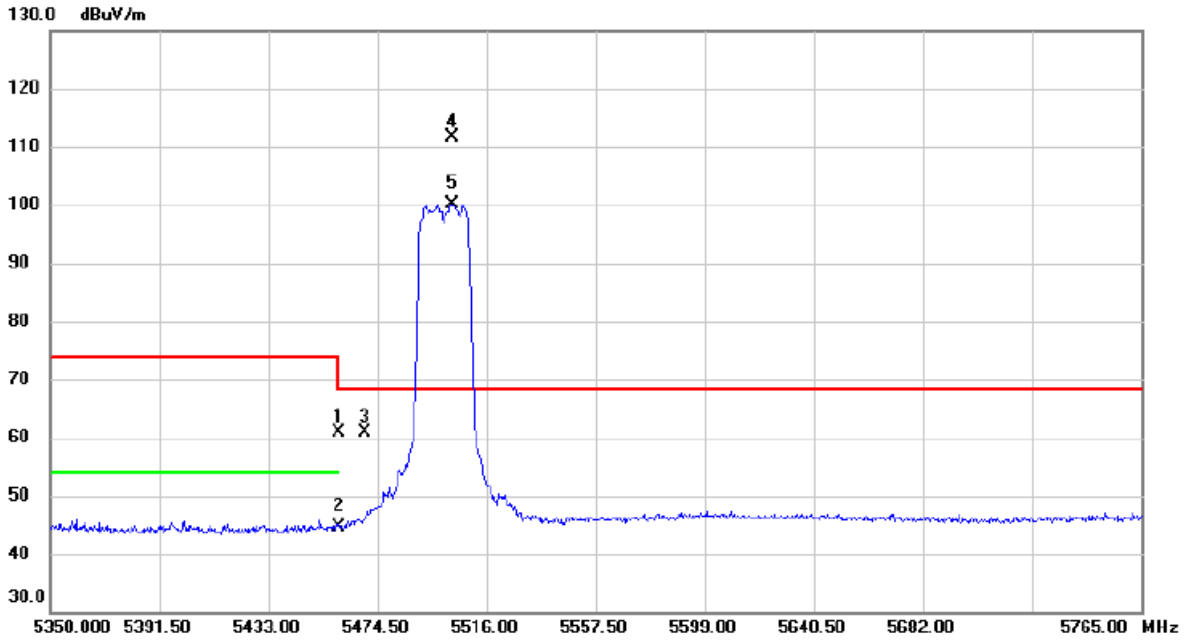

No.	Mk.	Freq. MHz	Reading Level dBuV	Correct Factor dB	Measure- ment dBuV/m	Limit dBuV/m	Margin dB	Detector	Comment
1		5460.000	22.87	38.12	60.99	74.00	-13.01	peak	
2		5460.000	6.53	38.12	44.65	54.00	-9.35	AVG	
3		5470.000	22.72	38.15	60.87	68.30	-7.43	peak	
4	*	5502.720	73.45	38.24	111.69	68.30	43.39	peak	No limit
5	X	5502.720	61.95	38.24	100.19	68.30	31.89	AVG	No limit

REMARKS:

(1) Measurement Value = Reading Level + Correct Factor.

(2) Margin Level = Measurement Value - Limit Value.

Orthogonal Axis	X		
Test Mode	UNII-2C_TX AX (HE20) Mode 5500 MHz	RU configuration	242/61

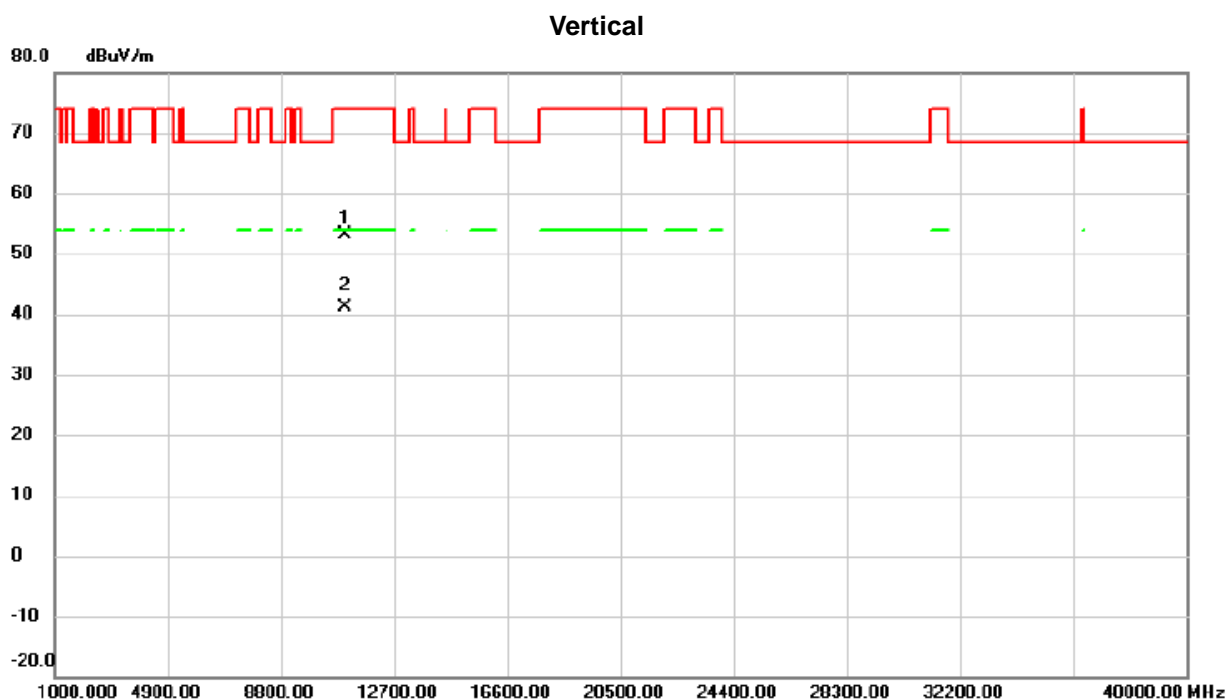

No.	Mk.	Freq. MHz	Reading Level dBuV	Correct Factor dB	Measure- ment dBuV/m	Limit dBuV/m	Margin dB	Detector	Comment
1		11010.12	50.93	2.32	53.25	74.00	-20.75	peak	
2	*	11011.60	38.93	2.32	41.25	54.00	-12.75	AVG	

REMARKS:

- (1) Measurement Value = Reading Level + Correct Factor.
- (2) Margin Level = Measurement Value - Limit Value.

Orthogonal Axis	X		
Test Mode	UNII-2C_TX AX (HE20) Mode 5745 MHz	RU configuration	242/61

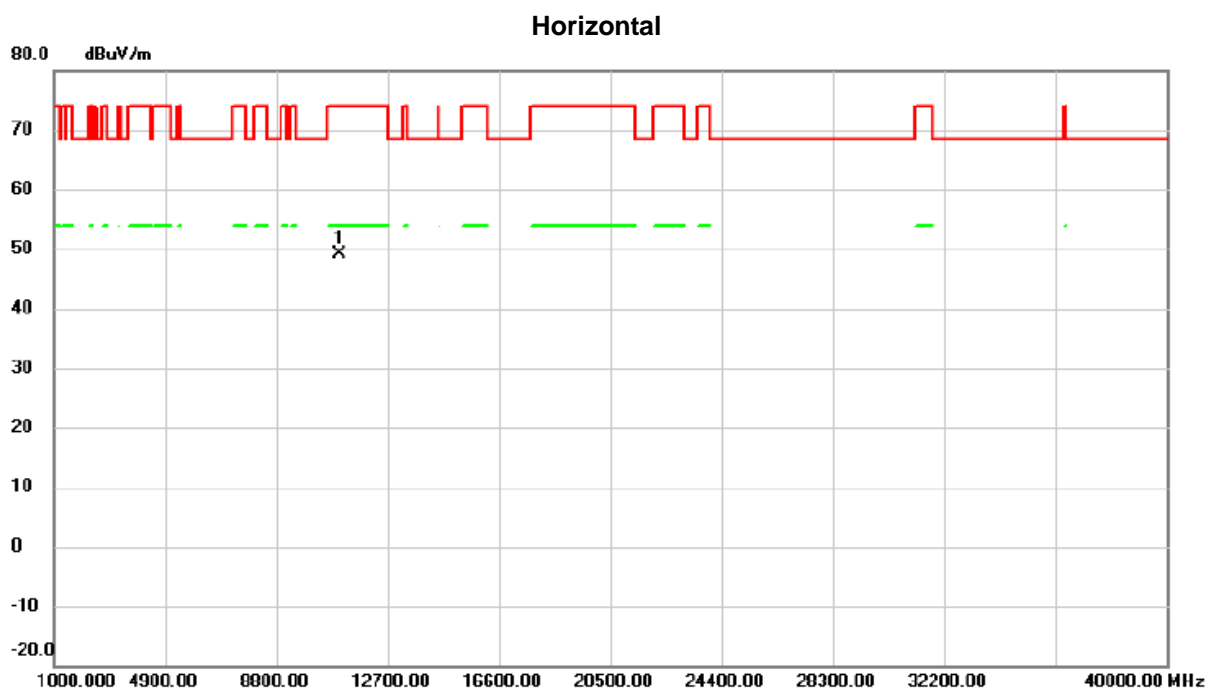

No.	Mk.	Freq. MHz	Reading Level dBuV	Correct Factor dB	Measure- ment dBuV/m	Limit dBuV/m	Margin dB	Detector	Comment
1	*	11009.92	46.90	2.32	49.22	74.00	-24.78	peak	

REMARKS:

- (1) Measurement Value = Reading Level + Correct Factor.
- (2) Margin Level = Measurement Value - Limit Value.

Orthogonal Axis	X		
Test Mode	UNII-2C_TX AX (HE20) Mode 5580 MHz	RU configuration	52/37

Vertical

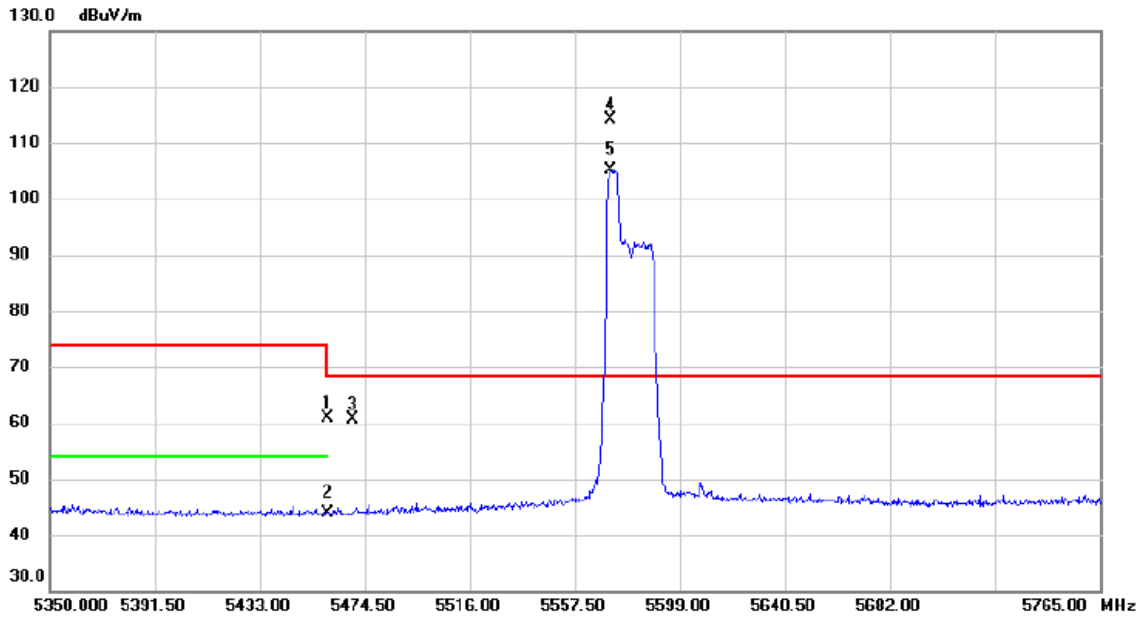

No.	Mk.	Freq. MHz	Reading Level dBuV	Correct Factor dB	Measure- ment dBuV/m	Limit dBuV/m	Margin dB	Detector	Comment
1		5460.000	22.75	38.12	60.87	74.00	-13.13	peak	
2		5460.000	5.73	38.12	43.85	54.00	-10.15	AVG	
3		5470.000	22.58	38.15	60.73	68.30	-7.57	peak	
4	*	5571.403	75.94	38.31	114.25	68.30	45.95	peak	No limit
5	X	5571.403	66.86	38.31	105.17	68.30	36.87	AVG	No limit

REMARKS:

- (1) Measurement Value = Reading Level + Correct Factor.
- (2) Margin Level = Measurement Value - Limit Value.

Orthogonal Axis	X		
Test Mode	UNII-2C_TX AX (HE20) Mode 5580 MHz	RU configuration	52/37

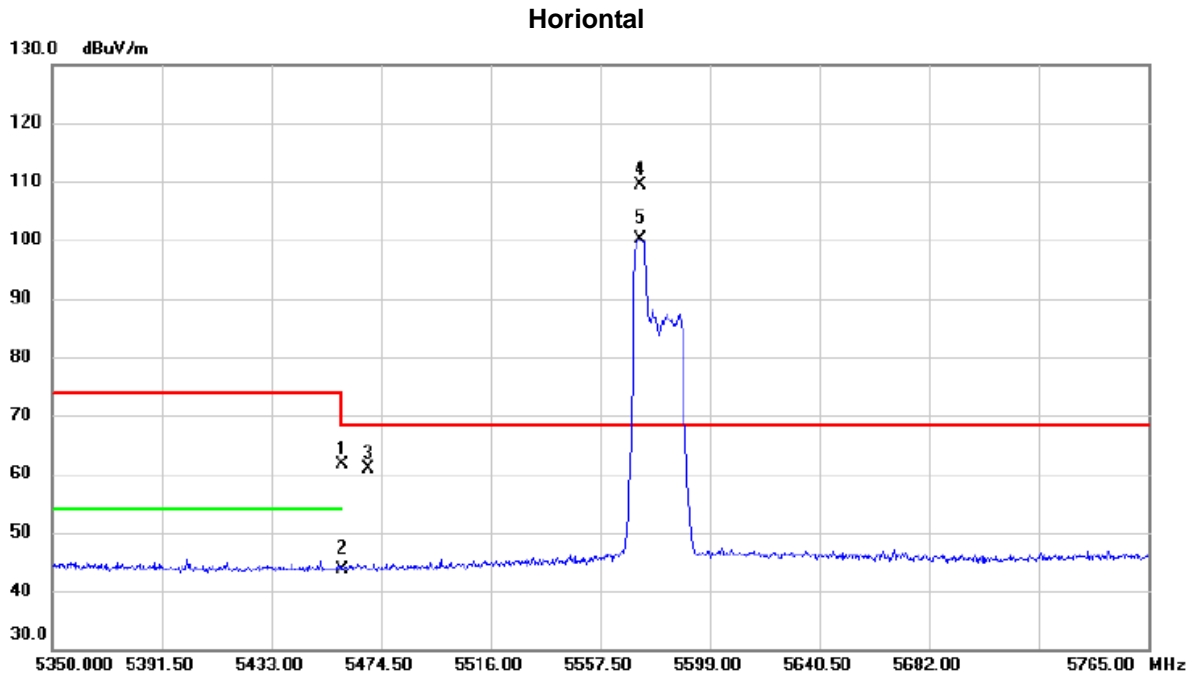

No.	Mk.	Freq. MHz	Reading Level dBuV	Correct Factor dB	Measure- ment dBuV/m	Limit dBuV/m	Margin dB	Detector	Comment
1		5460.000	23.51	38.12	61.63	74.00	-12.37	peak	
2		5460.000	5.54	38.12	43.66	54.00	-10.34	AVG	
3		5470.000	22.74	38.15	60.89	68.30	-7.41	peak	
4	*	5572.855	71.09	38.32	109.41	68.30	41.11	peak	No limit
5	X	5572.855	61.85	38.32	100.17	68.30	31.87	AVG	No limit

REMARKS:

(1) Measurement Value = Reading Level + Correct Factor.

(2) Margin Level = Measurement Value - Limit Value.

Orthogonal Axis	X		
Test Mode	UNII-2C_TX AX (HE20) Mode 5580 MHz	RU configuration	106/54

Vertical

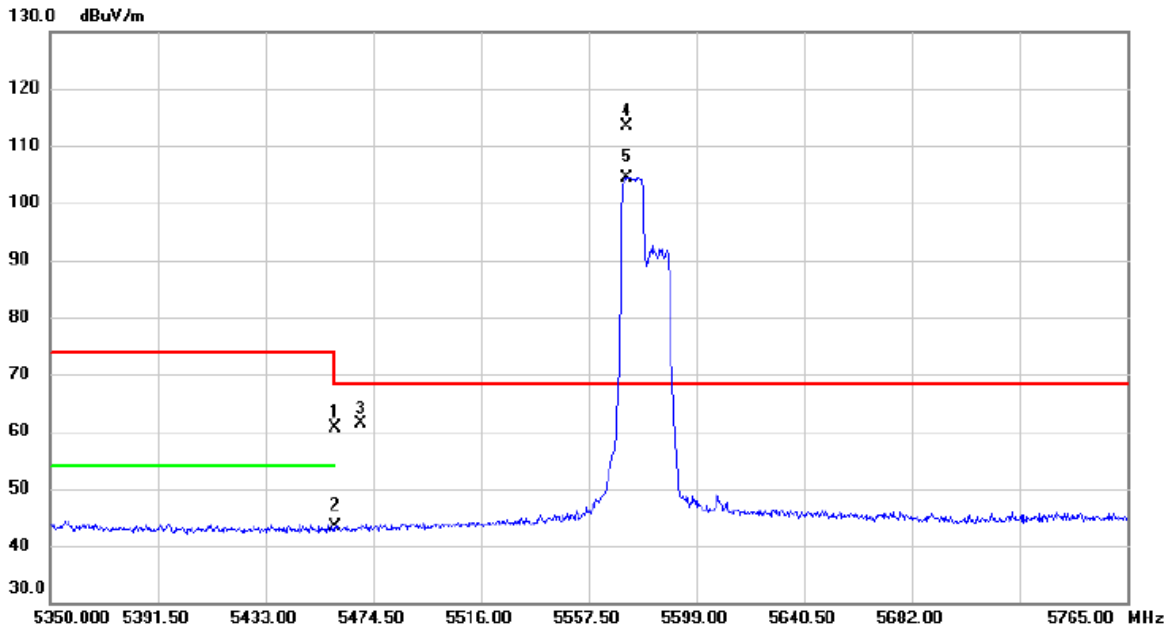

No.	Mk.	Freq. MHz	Reading Level dBuV	Correct Factor dB	Measure- ment dBuV/m	Limit dBuV/m	Margin dB	Detector	Comment
1		5460.000	22.59	38.12	60.71	74.00	-13.29	peak	
2		5460.000	5.17	38.12	43.29	54.00	-10.71	AVG	
3		5470.000	23.26	38.15	61.41	68.30	-6.89	peak	
4	*	5572.025	74.95	38.31	113.26	68.30	44.96	peak	No limit
5	X	5572.025	66.09	38.31	104.40	68.30	36.10	AVG	No limit

REMARKS:

- (1) Measurement Value = Reading Level + Correct Factor.
- (2) Margin Level = Measurement Value - Limit Value.

Orthogonal Axis	X		
Test Mode	UNII-2C_TX AX (HE20) Mode 5580 MHz	RU configuration	106/53

Horizontal

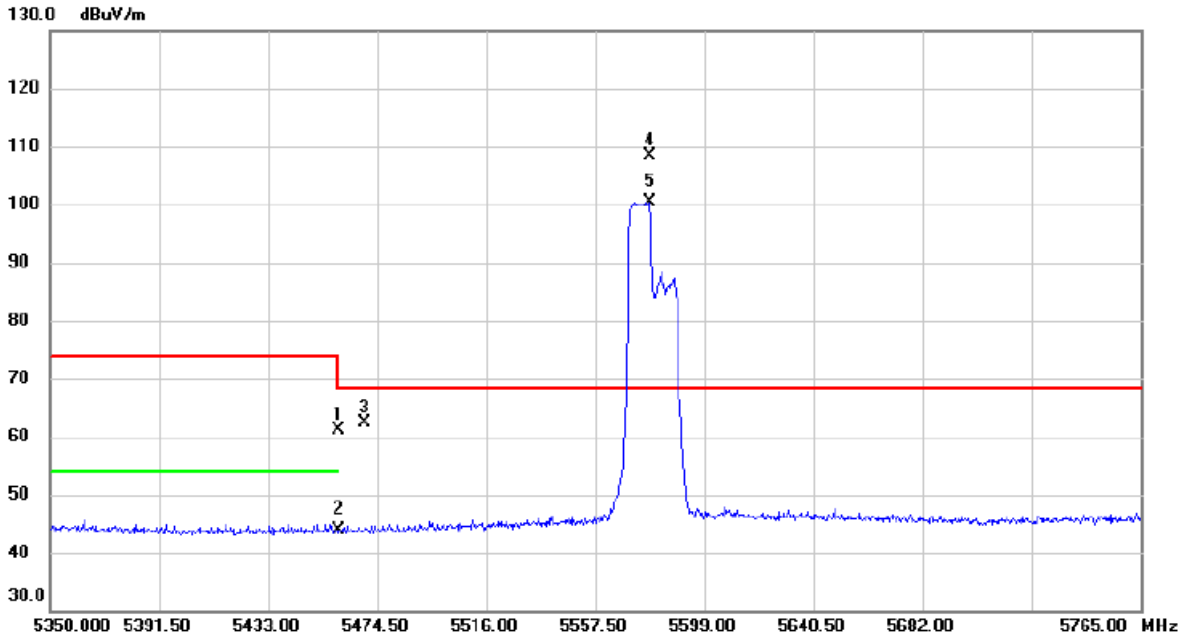

No.	Mk.	Freq. MHz	Reading Level dBuV	Correct Factor dB	Measure- ment dBuV/m	Limit dBuV/m	Margin dB	Detector	Comment
1		5460.000	22.97	38.12	61.09	74.00	-12.91	peak	
2		5460.000	5.77	38.12	43.89	54.00	-10.11	AVG	
3		5470.000	24.26	38.15	62.41	68.30	-5.89	peak	
4	*	5578.042	70.15	38.32	108.47	68.30	40.17	peak	No limit
5	X	5578.042	61.95	38.32	100.27	68.30	31.97	AVG	No limit

REMARKS:

(1) Measurement Value = Reading Level + Correct Factor.

(2) Margin Level = Measurement Value - Limit Value.

Orthogonal Axis	X		
Test Mode	UNII-2C_TX AX (HE20) Mode 5785 MHz	RU configuration	242/61

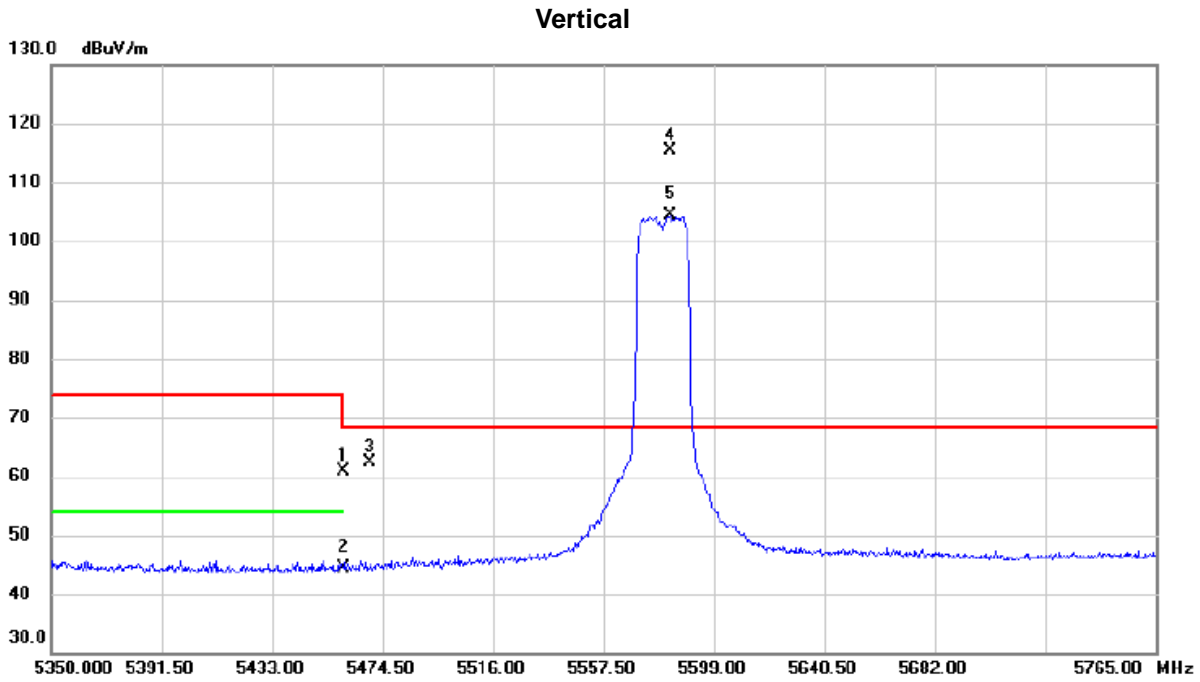

No.	Mk.	Freq. MHz	Reading Level dBuV	Correct Factor dB	Measure- ment dBuV/m	Limit dBuV/m	Margin dB	Detector	Comment
1		5460.000	22.88	38.12	61.00	74.00	-13.00	peak	
2		5460.000	6.35	38.12	44.47	54.00	-9.53	AVG	
3		5470.000	24.12	38.15	62.27	68.30	-6.03	peak	
4	*	5582.608	77.14	38.32	115.46	68.30	47.16	peak	No limit
5	X	5582.608	65.97	38.32	104.29	68.30	35.99	AVG	No limit

REMARKS:

- (1) Measurement Value = Reading Level + Correct Factor.
- (2) Margin Level = Measurement Value - Limit Value.

Orthogonal Axis	X		
Test Mode	UNII-2C_TX AX (HE20) Mode 5580 MHz	RU configuration	242/61

Horizontal

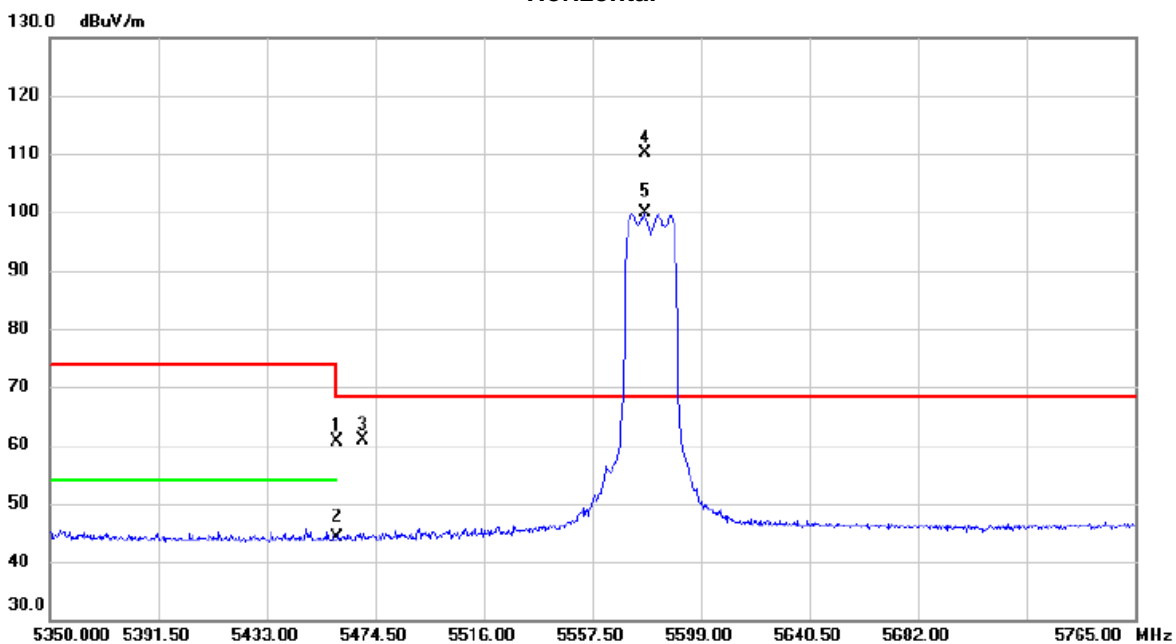

No.	Mk.	Freq. MHz	Reading Level dBuV	Correct Factor dB	Measure- ment dBuV/m	Limit dBuV/m	Margin dB	Detector	Comment
1		5460.000	22.53	38.12	60.65	74.00	-13.35	peak	
2		5460.000	6.10	38.12	44.22	54.00	-9.78	AVG	
3		5470.000	22.73	38.15	60.88	68.30	-7.42	peak	
4	*	5577.627	71.91	38.32	110.23	68.30	41.93	peak	No limit
5	X	5577.627	61.53	38.32	99.85	68.30	31.55	AVG	No limit

REMARKS:

- (1) Measurement Value = Reading Level + Correct Factor.
- (2) Margin Level = Measurement Value - Limit Value.

Orthogonal Axis	X		
Test Mode	UNII-2C_TX AX (HE20) Mode 5580 MHz	RU configuration	242/61

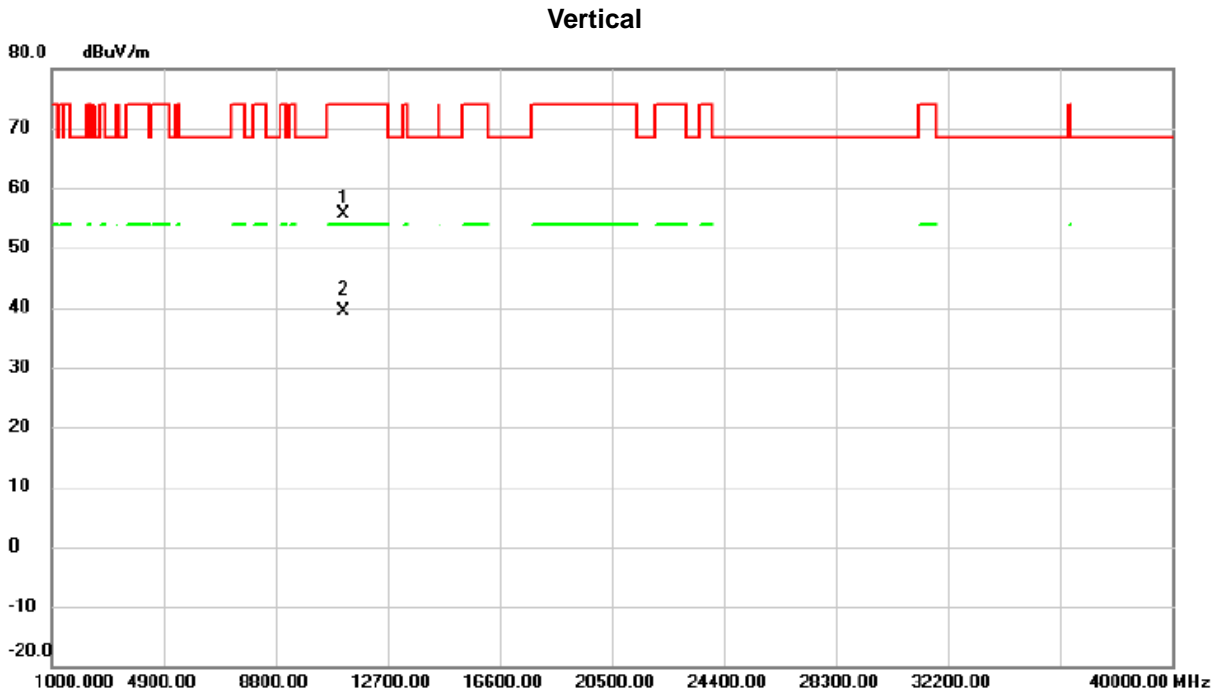

No.	Mk.	Freq. MHz	Reading Level dBuV	Correct Factor dB	Measure- ment dBuV/m	Limit dBuV/m	Margin dB	Detector	Comment
1		11161.77	53.51	2.04	55.55	74.00	-18.45	peak	
2	*	11166.80	37.40	2.02	39.42	54.00	-14.58	AVG	

REMARKS:

- (1) Measurement Value = Reading Level + Correct Factor.
- (2) Margin Level = Measurement Value - Limit Value.

Orthogonal Axis	X		
Test Mode	UNII-2C_TX AX (HE20) Mode 5580 MHz	RU configuration	242/61

Horizontal

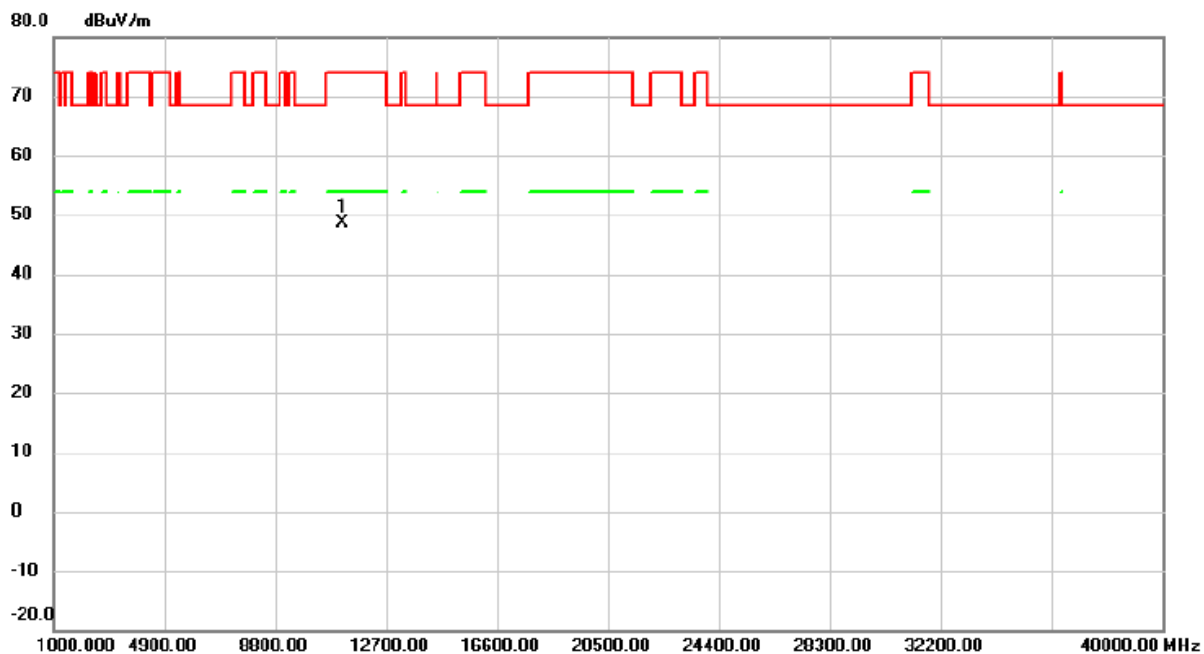

No.	Mk.	Freq. MHz	Reading Level dBuV	Correct Factor dB	Measure- ment dBuV/m	Limit dBuV/m	Margin dB	Detector	Comment
1	*	11185.82	46.58	2.00	48.58	74.00	-25.42	peak	

REMARKS:

- (1) Measurement Value = Reading Level + Correct Factor.
- (2) Margin Level = Measurement Value - Limit Value.

Orthogonal Axis	X		
Test Mode	UNII-2C_TX AX (HE20) Mode 5700 MHz	RU configuration	52/40

Vertical

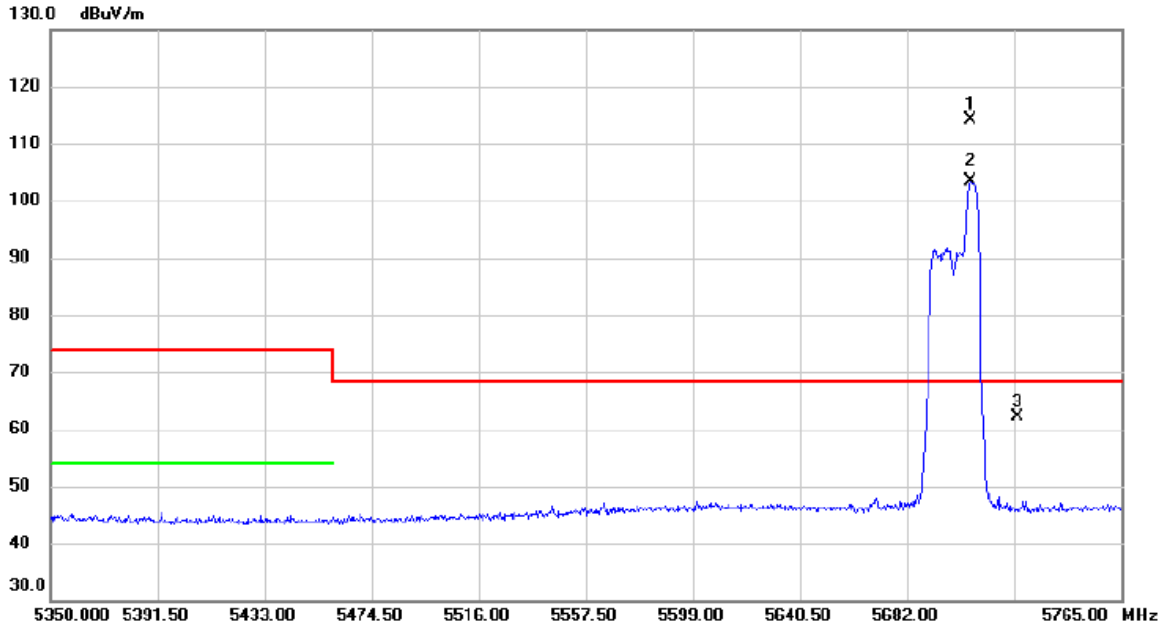

No.	Mk.	Freq. MHz	Reading Level dBuV	Correct Factor dB	Measure- ment dBuV/m	Limit dBuV/m	Margin dB	Detector	Comment
1	*	5706.900	75.80	38.43	114.23	68.30	45.93	peak	No limit
2	X	5706.900	64.88	38.43	103.31	68.30	35.01	AVG	No limit
3		5725.000	23.58	38.50	62.08	68.30	-6.22	peak	

REMARKS:

- (1) Measurement Value = Reading Level + Correct Factor.
- (2) Margin Level = Measurement Value - Limit Value.

Orthogonal Axis	X		
Test Mode	UNII-2C_TX AX (HE20) Mode 5700 MHz	RU configuration	52/40

Horizontal

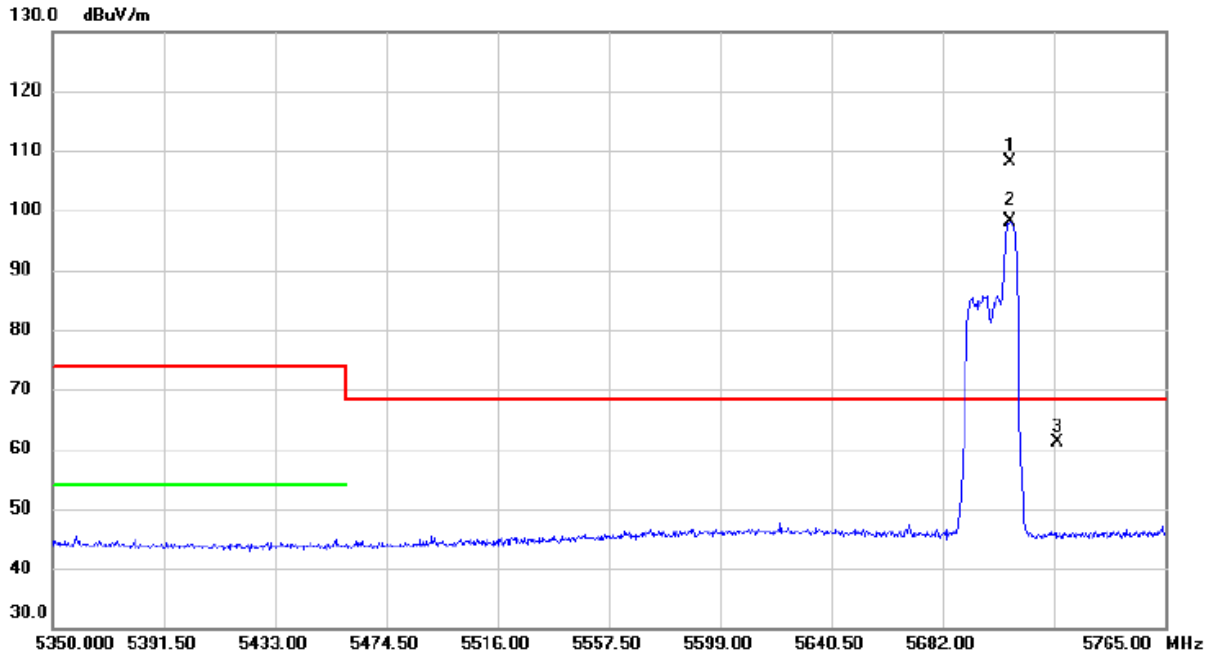

No.	Mk.	Freq. MHz	Reading Level dBuV	Correct Factor dB	Measure- ment dBuV/m	Limit dBuV/m	Margin dB	Detector	Comment
1	*	5707.108	69.60	38.43	108.03	68.30	39.73	peak	No limit
2	X	5707.108	59.59	38.43	98.02	68.30	29.72	AVG	No limit
3		5725.000	22.74	38.50	61.24	68.30	-7.06	peak	

REMARKS:

- (1) Measurement Value = Reading Level + Correct Factor.
- (2) Margin Level = Measurement Value - Limit Value.

Orthogonal Axis	X		
Test Mode	UNII-2C_TX AX (HE20) Mode 5700 MHz	RU configuration	106/54

Vertical

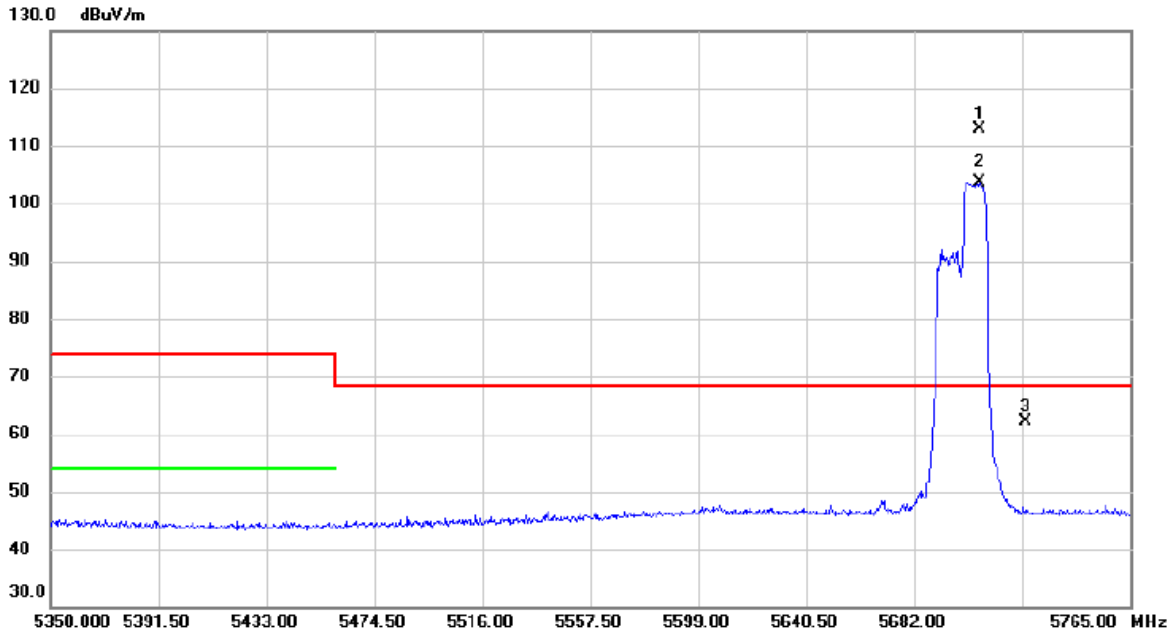

No.	Mk.	Freq. MHz	Reading Level dBuV	Correct Factor dB	Measure- ment dBuV/m	Limit dBuV/m	Margin dB	Detector	Comment
1	*	5707.108	74.47	38.43	112.90	68.30	44.60	peak	No limit
2	X	5707.108	65.13	38.43	103.56	68.30	35.26	AVG	No limit
3		5725.000	23.75	38.50	62.25	68.30	-6.05	peak	

REMARKS:

- (1) Measurement Value = Reading Level + Correct Factor.
- (2) Margin Level = Measurement Value - Limit Value.

Orthogonal Axis	X		
Test Mode	UNII-2C_TX AX (HE20) Mode 5700 MHz	RU configuration	106/54

Horizontal

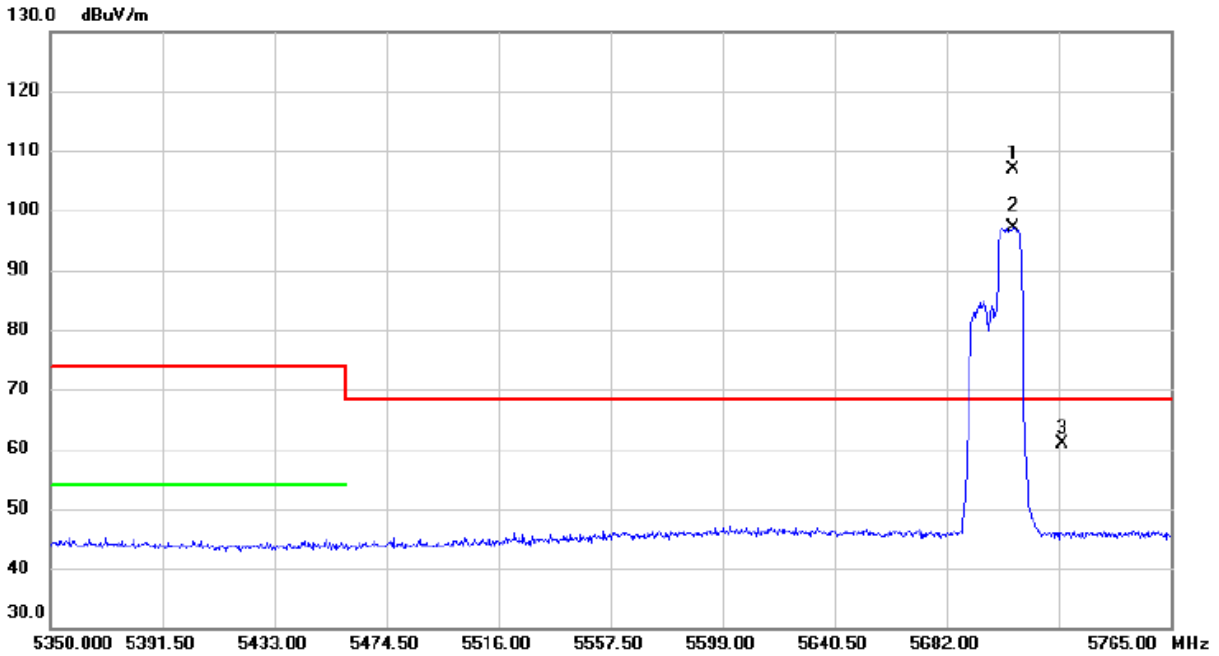

No.	Mk.	Freq. MHz	Reading Level dBuV	Correct Factor dB	Measure- ment dBuV/m	Limit dBuV/m	Margin dB	Detector	Comment
1	*	5706.900	68.40	38.43	106.83	68.30	38.53	peak	No limit
2	X	5706.900	58.79	38.43	97.22	68.30	28.92	AVG	No limit
3		5725.000	22.41	38.50	60.91	68.30	-7.39	peak	

REMARKS:

- (1) Measurement Value = Reading Level + Correct Factor.
- (2) Margin Level = Measurement Value - Limit Value.

Orthogonal Axis	X		
Test Mode	UNII-2C_TX AX (HE20) Mode 5700 MHz	RU configuration	242/61

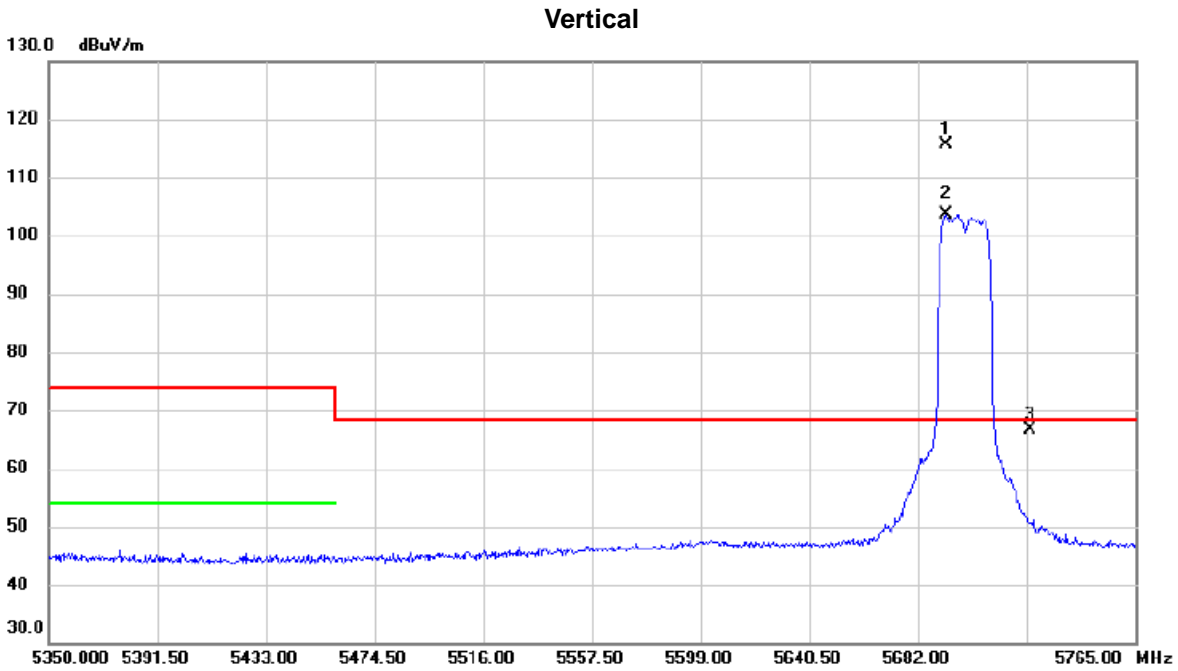

No.	Mk.	Freq. MHz	Reading Level dBuV	Correct Factor dB	Measure- ment dBuV/m	Limit dBuV/m	Margin dB	Detector	Comment
1	*	5692.790	77.31	38.40	115.71	68.30	47.41	peak	No limit
2	X	5692.790	65.25	38.40	103.65	68.30	35.35	AVG	No limit
3		5725.000	28.05	38.50	66.55	68.30	-1.75	peak	

REMARKS:

- (1) Measurement Value = Reading Level + Correct Factor.
- (2) Margin Level = Measurement Value - Limit Value.

Orthogonal Axis	X		
Test Mode	UNII-2C_TX AX (HE20) Mode 5700 MHz	RU configuration	242/61

Horizontal

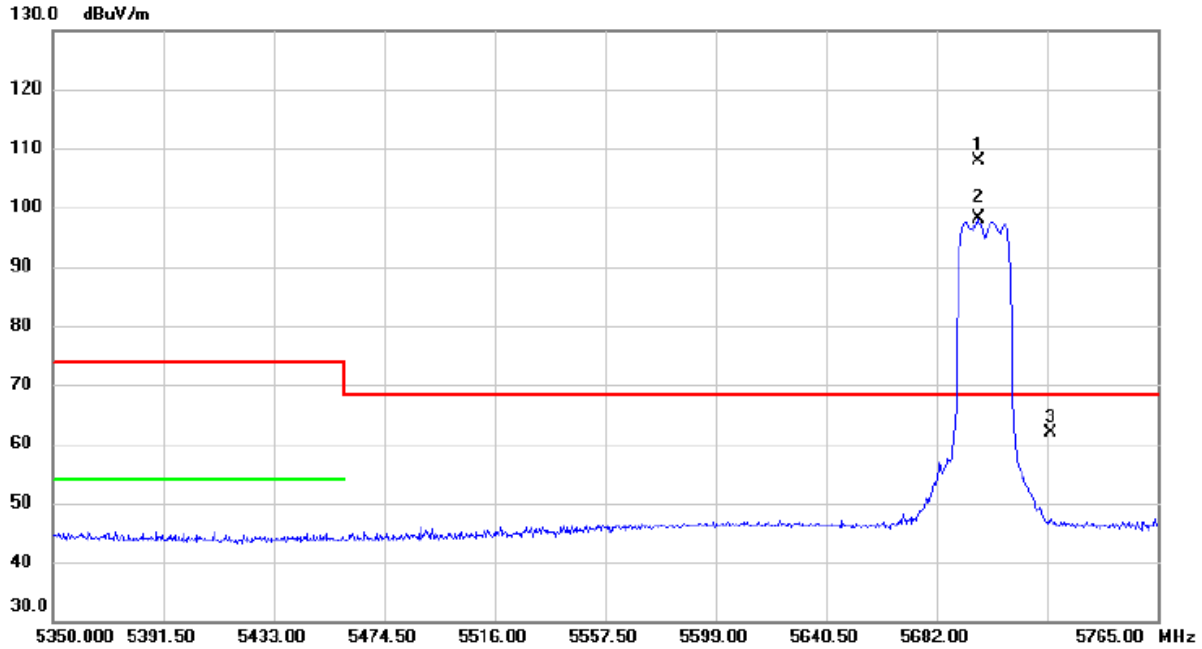

No.	Mk.	Freq. MHz	Reading Level dBuV	Correct Factor dB	Measure- ment dBuV/m	Limit dBuV/m	Margin dB	Detector	Comment
1	*	5697.563	69.42	38.40	107.82	68.30	39.52	peak	No limit
2	X	5697.563	59.73	38.40	98.13	68.30	29.83	AVG	No limit
3		5725.000	23.27	38.50	61.77	68.30	-6.53	peak	

REMARKS:

- (1) Measurement Value = Reading Level + Correct Factor.
- (2) Margin Level = Measurement Value - Limit Value.

Orthogonal Axis	X		
Test Mode	UNII-2C_TX AX (HE20) Mode 5700 MHz	RU configuration	242/61

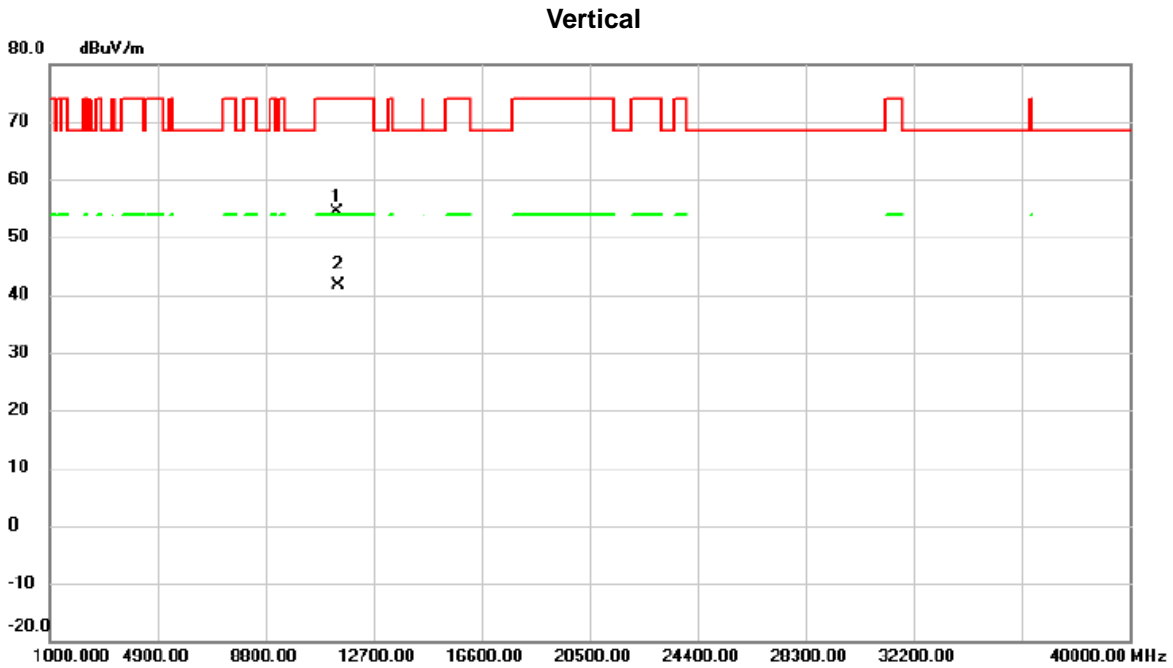

No.	Mk.	Freq. MHz	Reading Level dBuV	Correct Factor dB	Measure- ment dBuV/m	Limit dBuV/m	Margin dB	Detector	Comment
1		11399.40	52.32	2.13	54.45	74.00	-19.55	peak	
2	*	11401.80	39.53	2.13	41.66	54.00	-12.34	AVG	

REMARKS:

- (1) Measurement Value = Reading Level + Correct Factor.
- (2) Margin Level = Measurement Value - Limit Value.

Orthogonal Axis	X		
Test Mode	UNII-2C_TX AX (HE20) Mode 5825 MHz	RU configuration	242/61

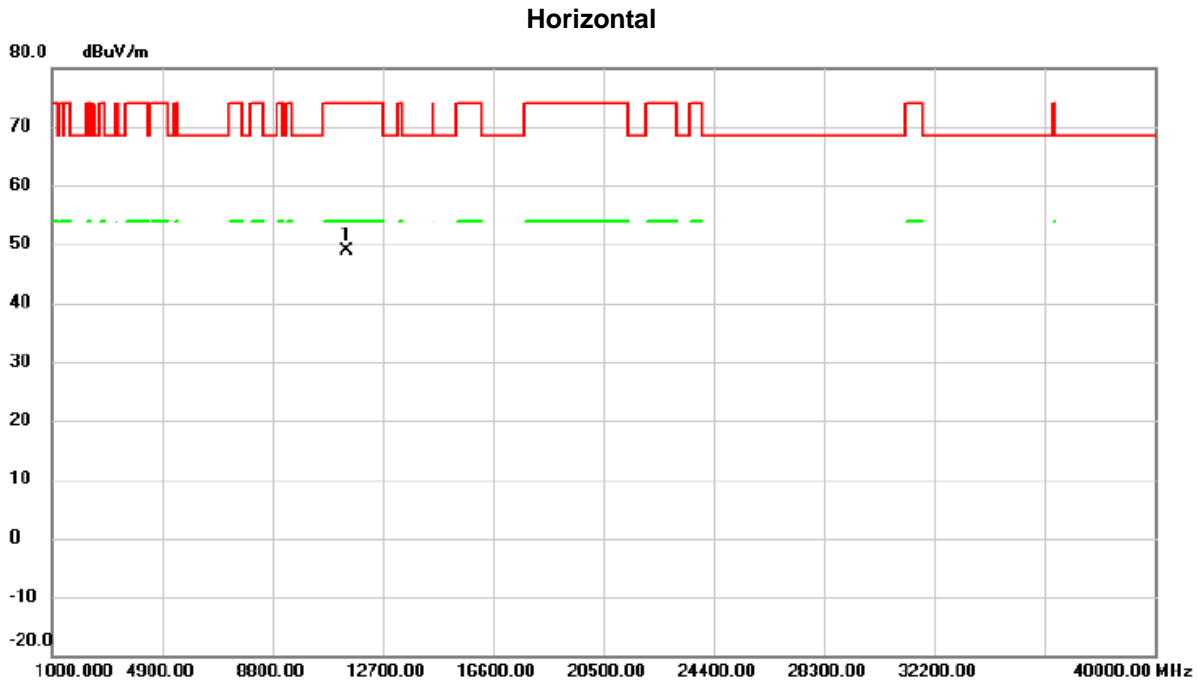

No.	Mk.	Freq. MHz	Reading Level dBuV	Correct Factor dB	Measure- ment dBuV/m	Limit dBuV/m	Margin dB	Detector	Comment
1	*	11403.40	46.75	2.14	48.89	74.00	-25.11	peak	

REMARKS:

- (1) Measurement Value = Reading Level + Correct Factor.
- (2) Margin Level = Measurement Value - Limit Value.

Orthogonal Axis	X		
Test Mode	UNII-2A_TX AX (HE40) Mode 5270 MHz	RU configuration	52/44

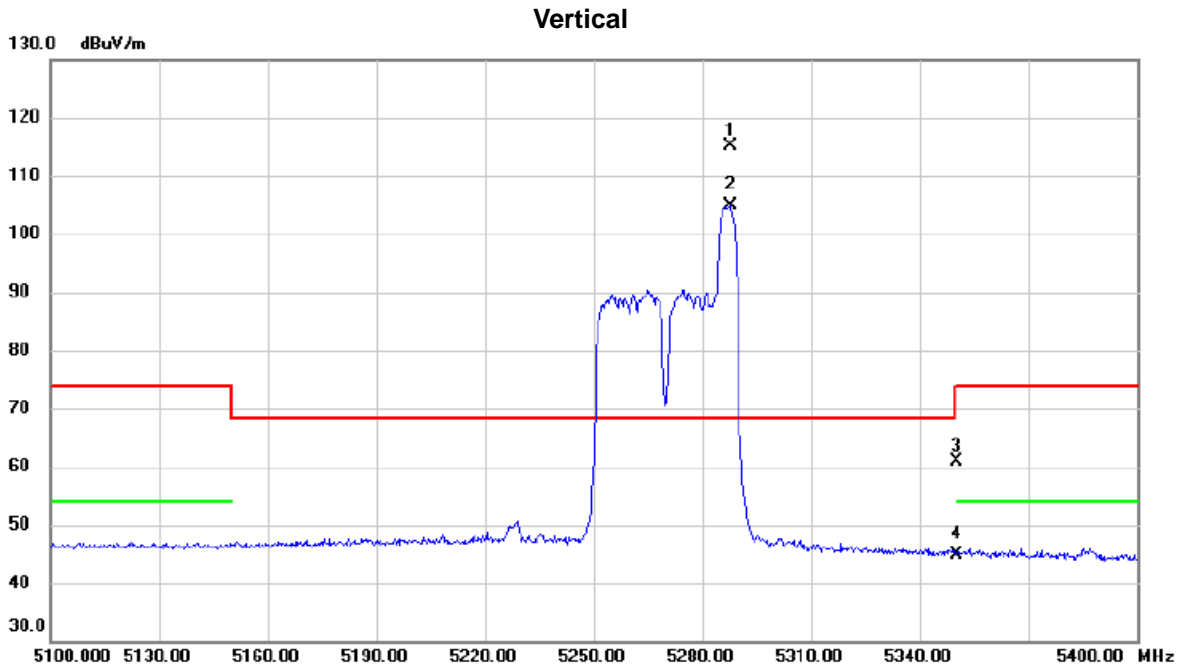

No.	Mk.	Freq. MHz	Reading Level dBuV	Correct Factor dB	Measure- ment dBuV/m	Limit dBuV/m	Margin dB	Detector	Comment
1	*	5287.650	77.63	37.55	115.18	68.30	46.88	peak	No limit
2	X	5287.650	67.21	37.55	104.76	68.30	36.46	AVG	No limit
3		5350.000	23.27	37.73	61.00	74.00	-13.00	peak	
4		5350.000	7.21	37.73	44.94	54.00	-9.06	AVG	

REMARKS:

- (1) Measurement Value = Reading Level + Correct Factor.
- (2) Margin Level = Measurement Value - Limit Value.

Orthogonal Axis	X		
Test Mode	UNII-2A_TX AX (HE40) Mode 5270 MHz	RU configuration	52/44

Horizontal

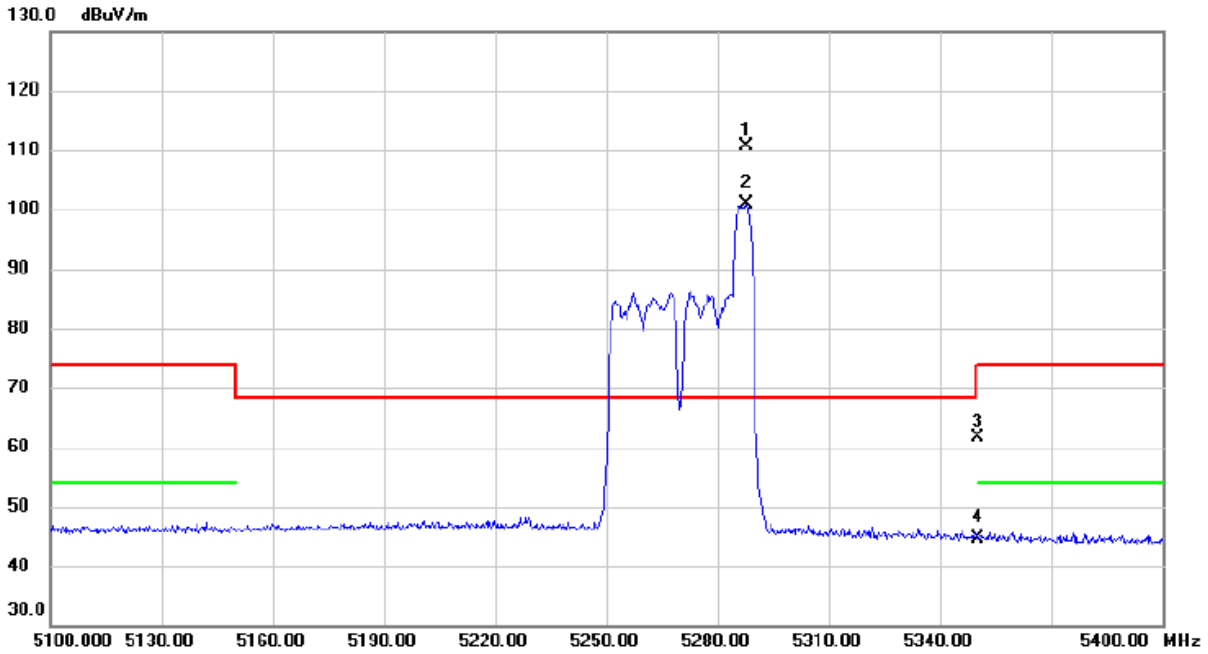

No.	Mk.	Freq. MHz	Reading Level dBuV	Correct Factor dB	Measure- ment dBuV/m	Limit dBuV/m	Margin dB	Detector	Comment
1	*	5287.650	72.99	37.55	110.54	68.30	42.24	peak	No limit
2	X	5287.650	63.26	37.55	100.81	68.30	32.51	AVG	No limit
3		5350.000	23.95	37.73	61.68	74.00	-12.32	peak	
4		5350.000	6.83	37.73	44.56	54.00	-9.44	AVG	

REMARKS:

- (1) Measurement Value = Reading Level + Correct Factor.
- (2) Margin Level = Measurement Value - Limit Value.

Orthogonal Axis	X		
Test Mode	UNII-2A_TX AX (HE40) Mode 5270 MHz	RU configuration	106/56

Vertical

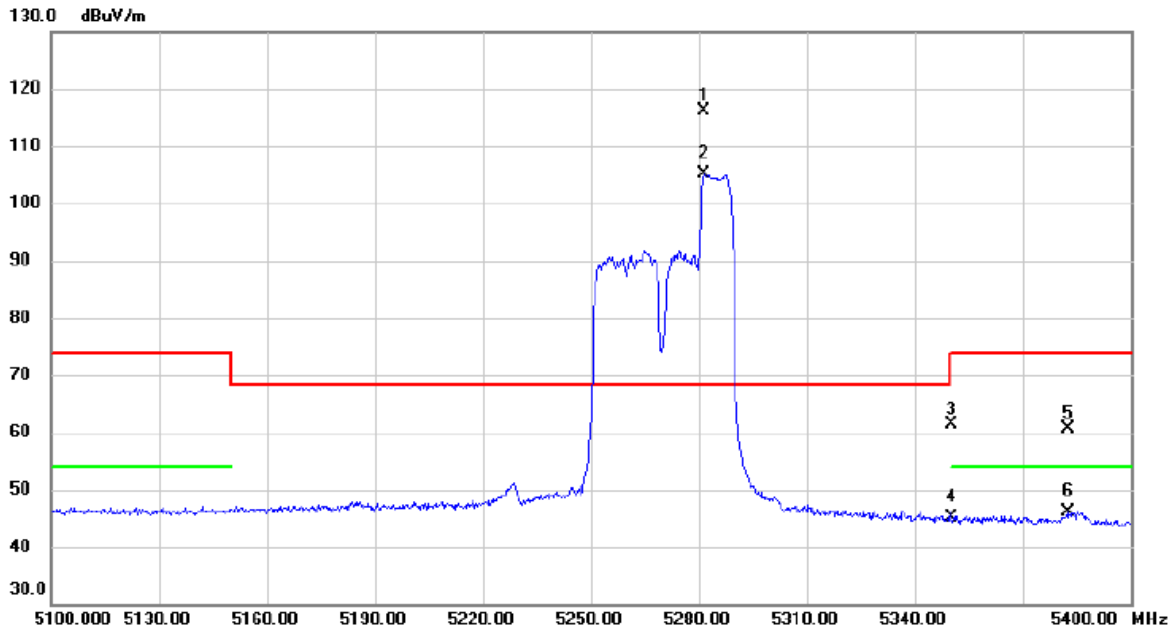

No.	Mk.	Freq. MHz	Reading Level dBuV	Correct Factor dB	Measure- ment dBuV/m	Limit dBuV/m	Margin dB	Detector	Comment
1	*	5281.350	78.58	37.56	116.14	68.30	47.84	peak	No limit
2	X	5281.350	67.48	37.56	105.04	68.30	36.74	AVG	No limit
3		5350.000	23.68	37.73	61.41	74.00	-12.59	peak	
4		5350.000	7.30	37.73	45.03	54.00	-8.97	AVG	
5		5382.450	22.67	37.87	60.54	74.00	-13.46	peak	
6		5382.450	8.23	37.87	46.10	54.00	-7.90	AVG	

REMARKS:

- (1) Measurement Value = Reading Level + Correct Factor.
- (2) Margin Level = Measurement Value - Limit Value.

Orthogonal Axis	X		
Test Mode	UNII-2A_TX AX (HE40) Mode 5270 MHz	RU configuration	106/56

Horizontal

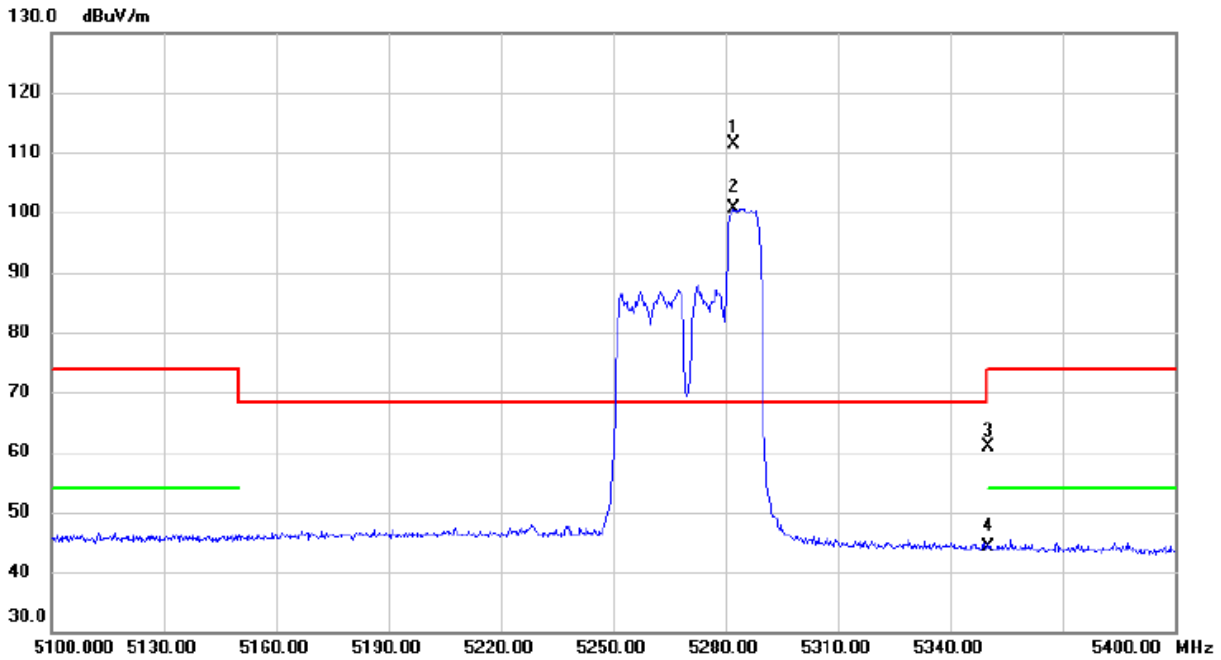

No.	Mk.	Freq. MHz	Reading Level dBuV	Correct Factor dB	Measure- ment dBuV/m	Limit dBuV/m	Margin dB	Detector	Comment
1	*	5282.100	73.83	37.56	111.39	68.30	43.09	peak	No limit
2	X	5282.100	63.17	37.56	100.73	68.30	32.43	AVG	No limit
3		5350.000	23.20	37.73	60.93	74.00	-13.07	peak	
4		5350.000	6.44	37.73	44.17	54.00	-9.83	AVG	

REMARKS:

- (1) Measurement Value = Reading Level + Correct Factor.
- (2) Margin Level = Measurement Value - Limit Value.

Orthogonal Axis	X		
Test Mode	UNII-2A_TX AX (HE40) Mode 5270 MHz	RU configuration	242/62

Vertical

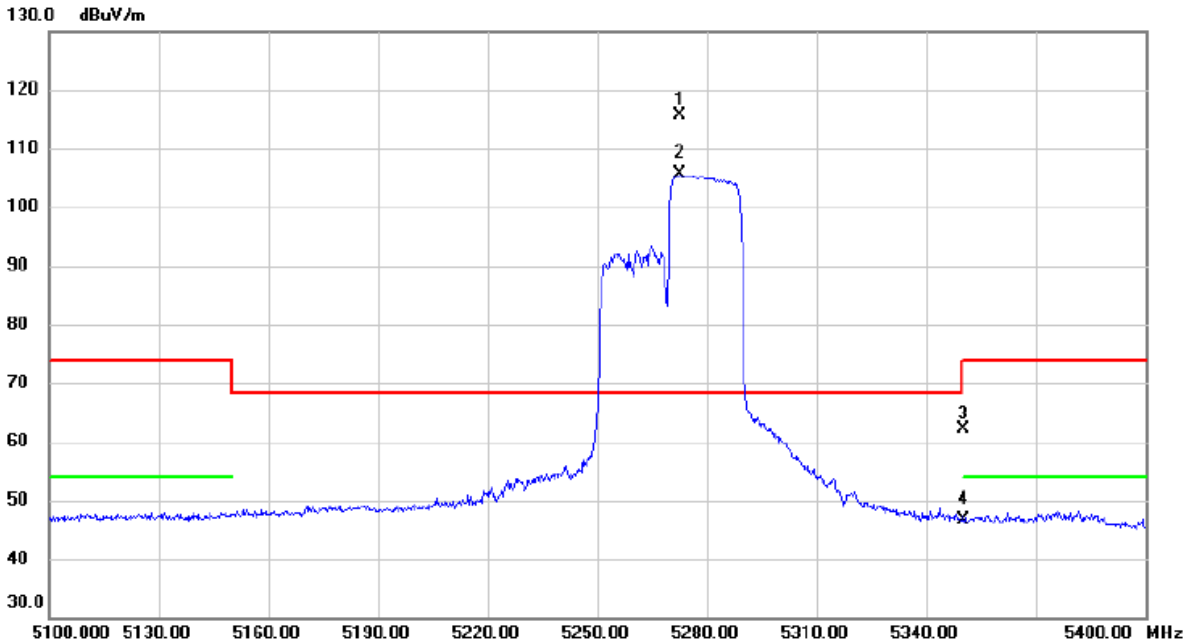

No.	Mk.	Freq. MHz	Reading Level dBuV	Correct Factor dB	Measure- ment dBuV/m	Limit dBuV/m	Margin dB	Detector	Comment
1	*	5272.500	78.09	37.58	115.67	68.30	47.37	peak	No limit
2	X	5272.500	67.94	37.58	105.52	68.30	37.22	AVG	No limit
3		5350.000	24.43	37.73	62.16	74.00	-11.84	peak	
4		5350.000	8.85	37.73	46.58	54.00	-7.42	AVG	

REMARKS:

- (1) Measurement Value = Reading Level + Correct Factor.
- (2) Margin Level = Measurement Value - Limit Value.

Orthogonal Axis	X		
Test Mode	UNII-2A_TX AX (HE40) Mode 5270 MHz	RU configuration	242/62

Horizontal

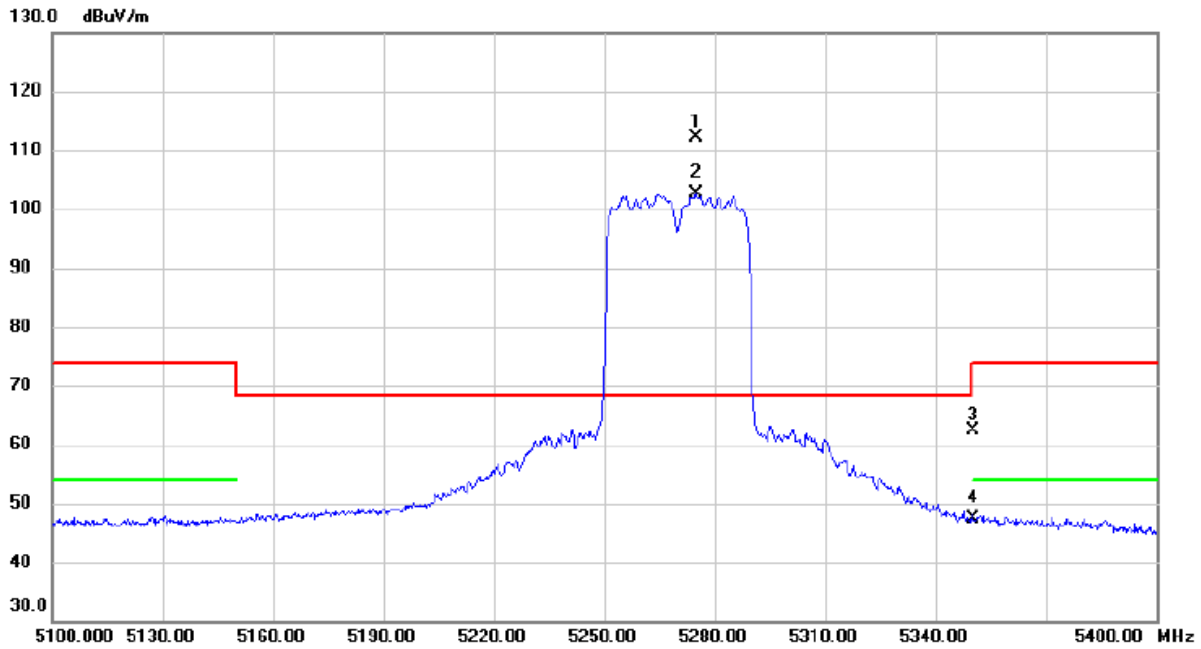

No.	Mk.	Freq. MHz	Reading Level dBuV	Correct Factor dB	Measure- ment dBuV/m	Limit dBuV/m	Margin dB	Detector	Comment
1	*	5275.050	74.51	37.57	112.08	68.30	43.78	peak	No limit
2	X	5275.050	64.98	37.57	102.55	68.30	34.25	AVG	No limit
3		5350.000	24.56	37.73	62.29	74.00	-11.71	peak	
4		5350.000	9.69	37.73	47.42	54.00	-6.58	AVG	

REMARKS:

- (1) Measurement Value = Reading Level + Correct Factor.
- (2) Margin Level = Measurement Value - Limit Value.

Orthogonal Axis	X		
Test Mode	UNII-2A_TX AX (HE40) Mode 5270 MHz	RU configuration	484/65

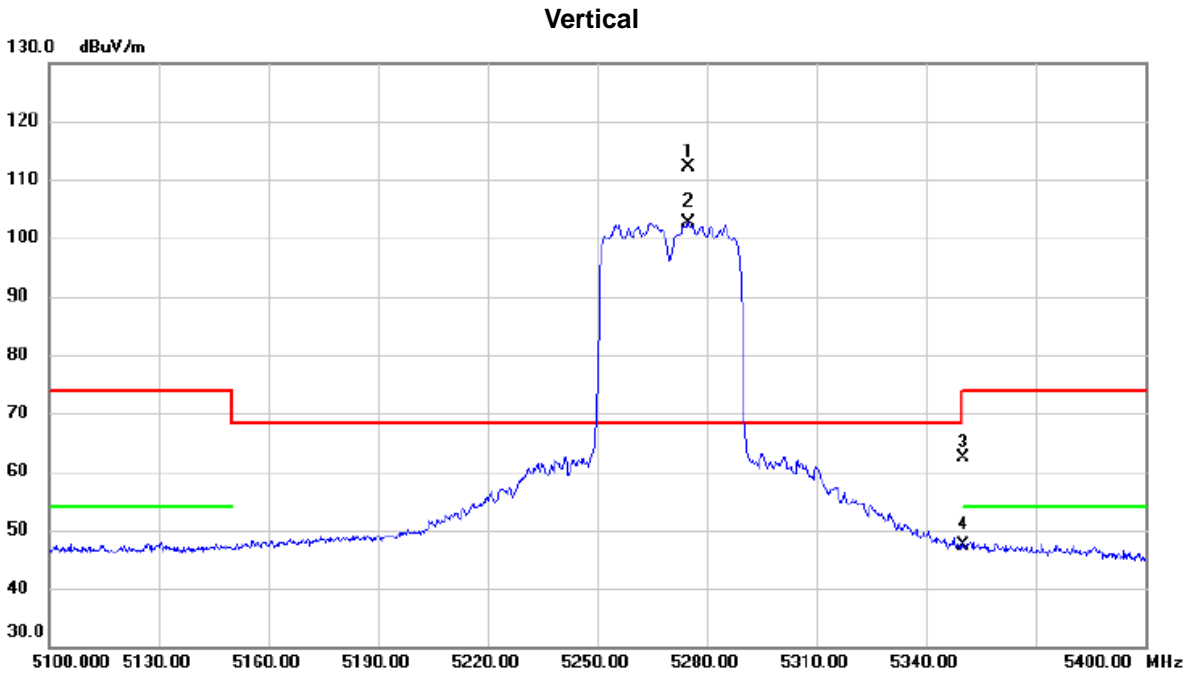

No.	Mk.	Freq. MHz	Reading Level dBuV	Correct Factor dB	Measure- ment dBuV/m	Limit dBuV/m	Margin dB	Detector	Comment
1	*	5275.050	74.51	37.57	112.08	68.30	43.78	peak	No limit
2	X	5275.050	64.98	37.57	102.55	68.30	34.25	AVG	No limit
3		5350.000	24.56	37.73	62.29	74.00	-11.71	peak	
4		5350.000	9.69	37.73	47.42	54.00	-6.58	AVG	

REMARKS:

- (1) Measurement Value = Reading Level + Correct Factor.
- (2) Margin Level = Measurement Value - Limit Value.

Orthogonal Axis	X		
Test Mode	UNII-2A_TX AX (HE40) Mode 5270 MHz	RU configuration	484/65

Horizontal

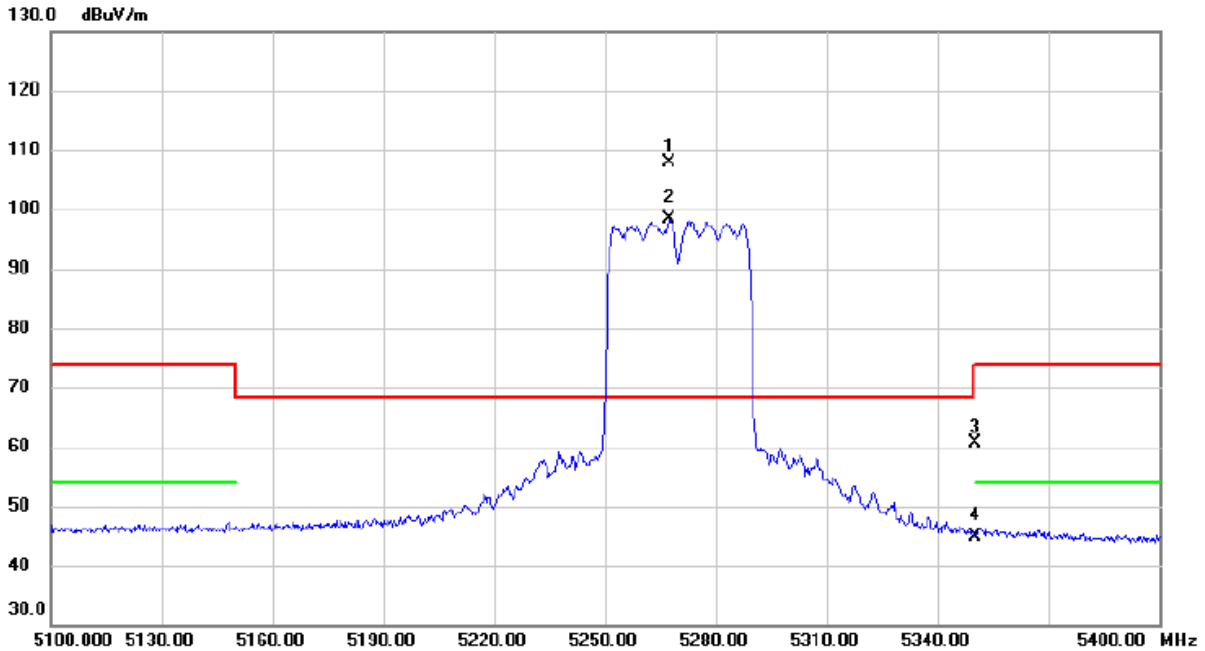

No.	Mk.	Freq. MHz	Reading Level dBuV	Correct Factor dB	Measure- ment dBuV/m	Limit dBuV/m	Margin dB	Detector	Comment
1	*	5267.400	70.34	37.58	107.92	68.30	39.62	peak	No limit
2	X	5267.400	60.72	37.58	98.30	68.30	30.00	AVG	No limit
3		5350.000	22.80	37.73	60.53	74.00	-13.47	peak	
4		5350.000	7.23	37.73	44.96	54.00	-9.04	AVG	

REMARKS:

- (1) Measurement Value = Reading Level + Correct Factor.
- (2) Margin Level = Measurement Value - Limit Value.

Orthogonal Axis	X		
Test Mode	UNII-2A_TX AX (HE40) Mode 5270 MHz	RU configuration	242/62

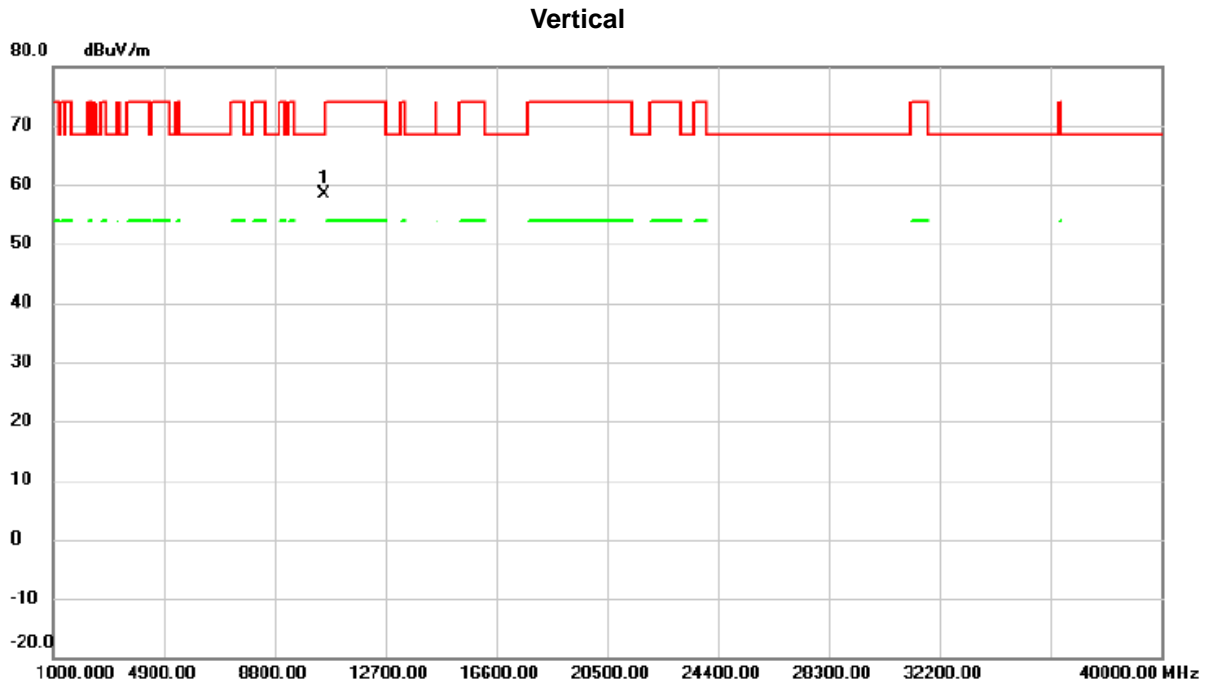

No.	Mk.	Freq. MHz	Reading Level dBuV	Correct Factor dB	Measure- ment dBuV/m	Limit dBuV/m	Margin dB	Detector	Comment
1	*	10559.02	56.53	1.88	58.41	68.30	-9.89	peak	

REMARKS:

- (1) Measurement Value = Reading Level + Correct Factor.
- (2) Margin Level = Measurement Value - Limit Value.

Orthogonal Axis	X		
Test Mode	UNII-2A_TX AX (HE40) Mode 5190 MHz	RU configuration	242/62

Horizontal

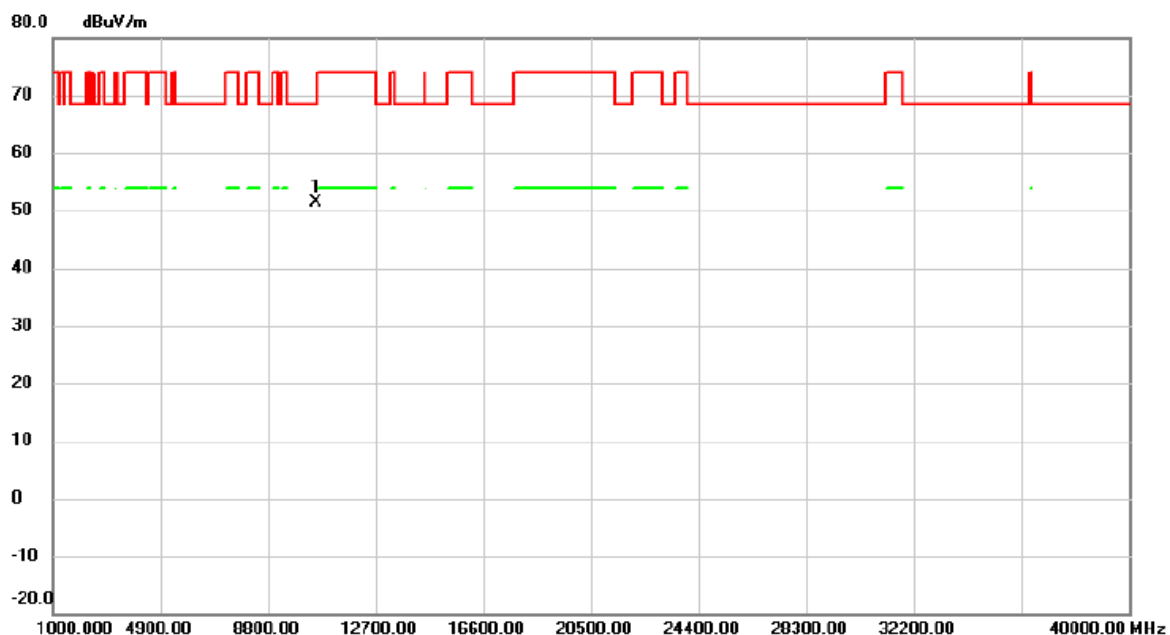

No.	Mk.	Freq.	Reading Level	Correct Factor	Measurement	Limit	Margin	Detector	Comment
		MHz	dBuV	dB	dBuV/m	dBuV/m	dB		
1	*	10559.50	49.62	1.88	51.50	68.30	-16.80	peak	

REMARKS:

- (1) Measurement Value = Reading Level + Correct Factor.
- (2) Margin Level = Measurement Value - Limit Value.

Orthogonal Axis	X		
Test Mode	UNII-2A_TX AX (HE40) Mode 5310 MHz	RU configuration	52/44

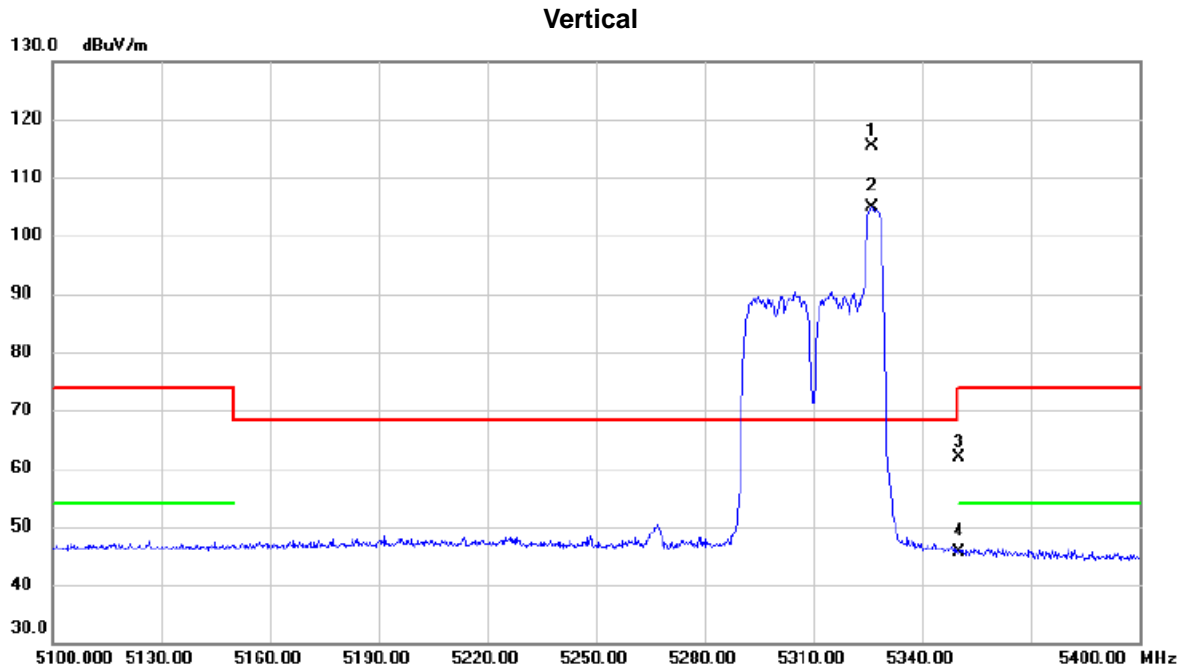

No.	Mk.	Freq. MHz	Reading Level dBuV	Correct Factor dB	Measure- ment dBuV/m	Limit dBuV/m	Margin dB	Detector	Comment
1	*	5326.350	77.70	37.64	115.34	68.30	47.04	peak	No limit
2	X	5326.350	67.31	37.64	104.95	68.30	36.65	AVG	No limit
3		5350.000	24.12	37.73	61.85	74.00	-12.15	peak	
4		5350.000	7.86	37.73	45.59	54.00	-8.41	AVG	

REMARKS:

- (1) Measurement Value = Reading Level + Correct Factor.
- (2) Margin Level = Measurement Value - Limit Value.

Orthogonal Axis	X		
Test Mode	UNII-2A_TX AX (HE40) Mode 5310 MHz	RU configuration	52/44

Horizontal

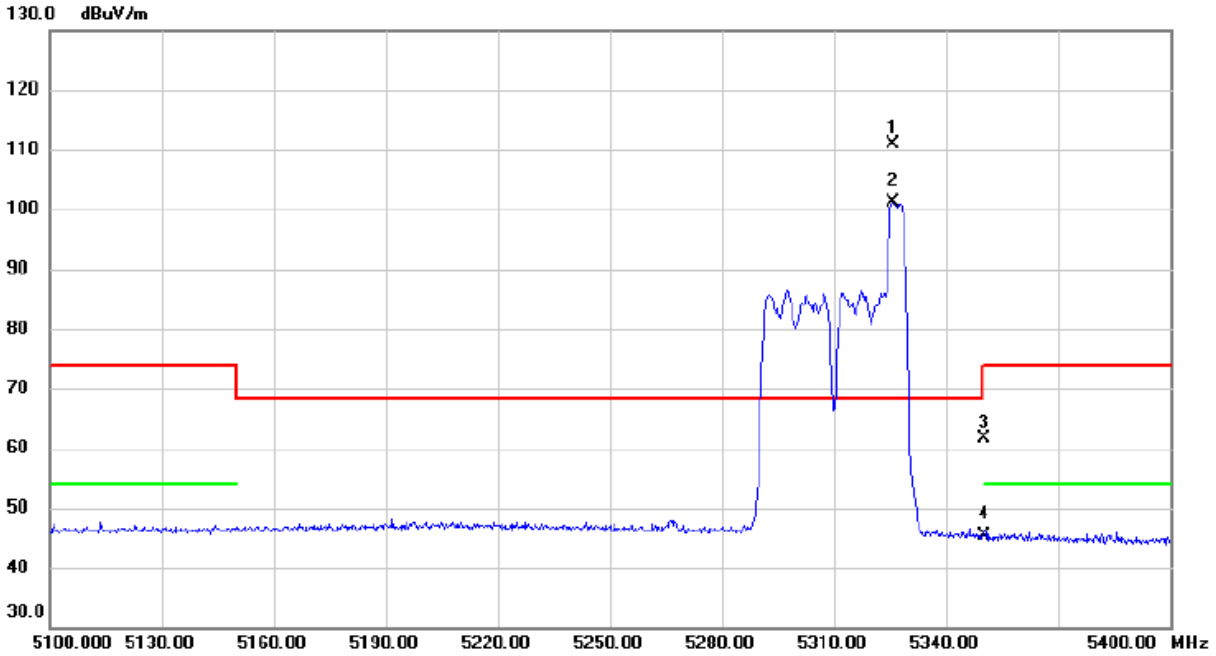

No.	Mk.	Freq. MHz	Reading Level dBuV	Correct Factor dB	Measure- ment dBuV/m	Limit dBuV/m	Margin dB	Detector	Comment
1	*	5325.900	73.33	37.64	110.97	68.30	42.67	peak	No limit
2	X	5325.900	63.44	37.64	101.08	68.30	32.78	AVG	No limit
3		5350.000	23.90	37.73	61.63	74.00	-12.37	peak	
4		5350.000	7.55	37.73	45.28	54.00	-8.72	AVG	

REMARKS:

- (1) Measurement Value = Reading Level + Correct Factor.
- (2) Margin Level = Measurement Value - Limit Value.

Orthogonal Axis	X		
Test Mode	UNII-2A_TX AX (HE40) Mode 5310 MHz	RU configuration	106/56

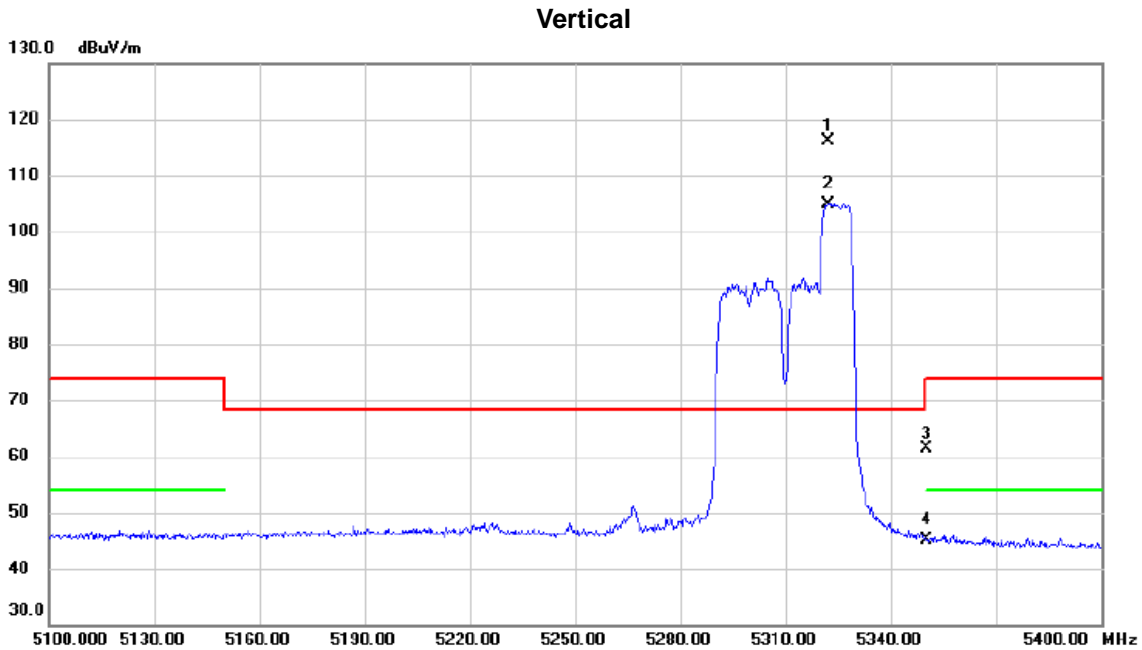

No.	Mk.	Freq. MHz	Reading Level dBuV	Correct Factor dB	Measure- ment dBuV/m	Limit dBuV/m	Margin dB	Detector	Comment
1	*	5322.150	78.58	37.63	116.21	68.30	47.91	peak	No limit
2	X	5322.150	67.23	37.63	104.86	68.30	36.56	AVG	No limit
3		5350.000	23.63	37.73	61.36	74.00	-12.64	peak	
4		5350.000	7.42	37.73	45.15	54.00	-8.85	AVG	

REMARKS:

- (1) Measurement Value = Reading Level + Correct Factor.
- (2) Margin Level = Measurement Value - Limit Value.

Orthogonal Axis	X		
Test Mode	UNII-2A_TX AX (HE40) Mode 5310 MHz	RU configuration	106/56

Horizontal

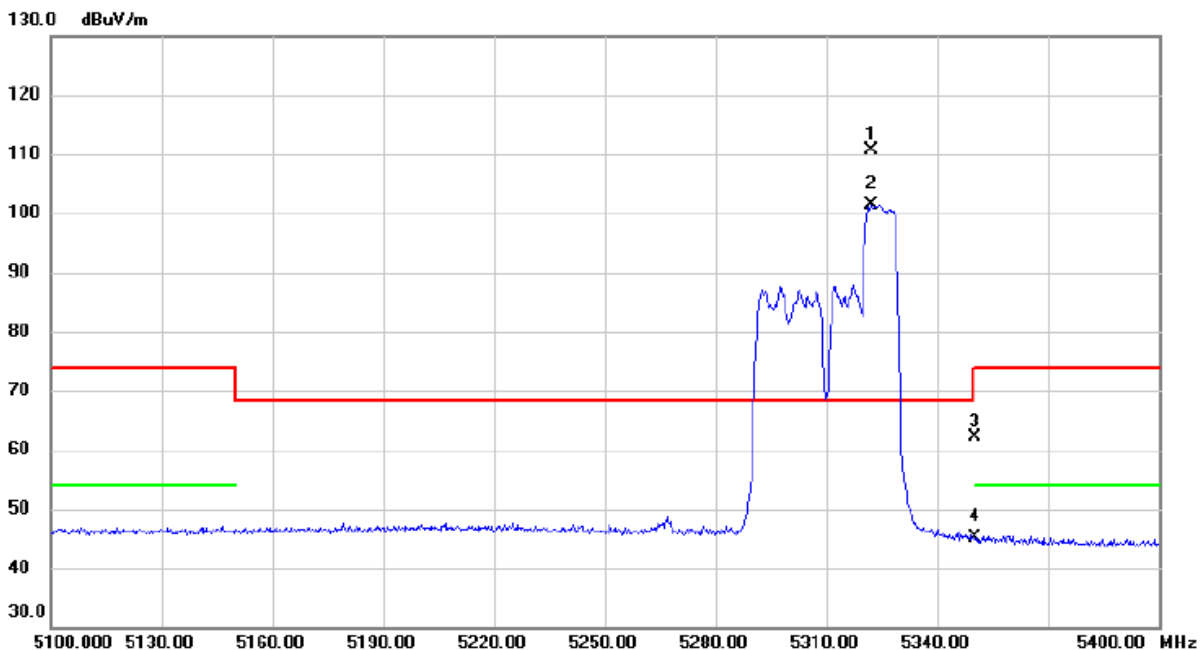

No.	Mk.	Freq. MHz	Reading Level dBuV	Correct Factor dB	Measure- ment dBuV/m	Limit dBuV/m	Margin dB	Detector	Comment
1	*	5322.300	73.01	37.63	110.64	68.30	42.34	peak	No limit
2	X	5322.300	63.78	37.63	101.41	68.30	33.11	AVG	No limit
3		5350.000	24.31	37.73	62.04	74.00	-11.96	peak	
4		5350.000	7.41	37.73	45.14	54.00	-8.86	AVG	

REMARKS:

- (1) Measurement Value = Reading Level + Correct Factor.
- (2) Margin Level = Measurement Value - Limit Value.

Orthogonal Axis	X		
Test Mode	UNII-2A_TX AX (HE40) Mode 5310 MHz	RU configuration	242/62

Vertical

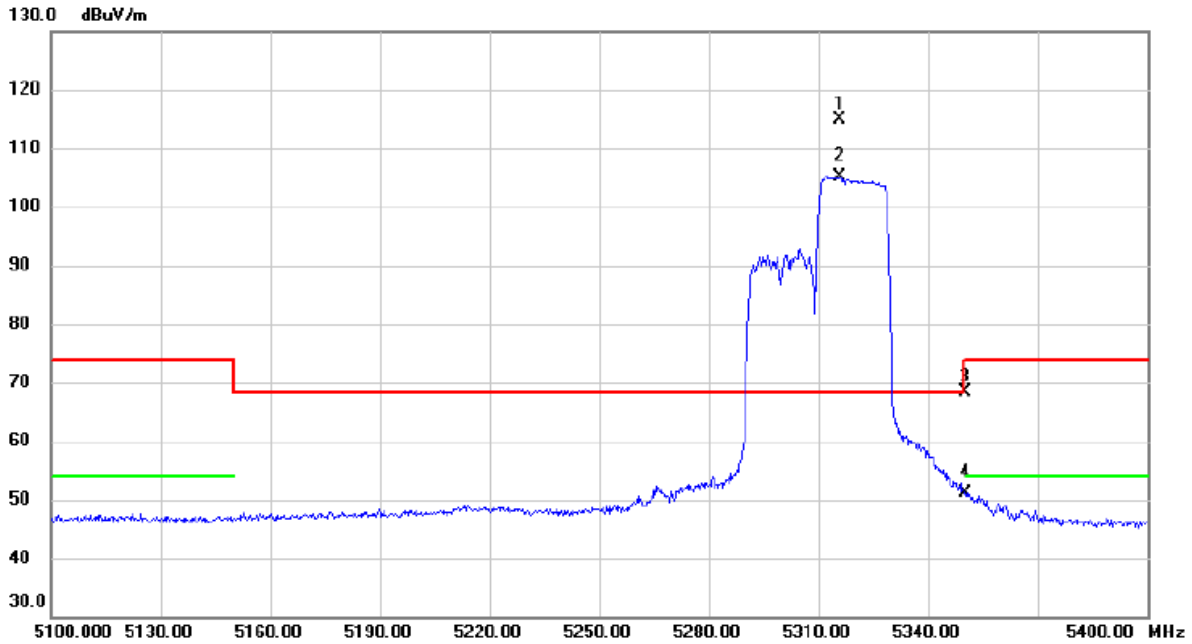

No.	Mk.	Freq. MHz	Reading Level dBuV	Correct Factor dB	Measure- ment dBuV/m	Limit dBuV/m	Margin dB	Detector	Comment
1	*	5315.850	77.20	37.60	114.80	68.30	46.50	peak	No limit
2	X	5315.850	67.48	37.60	105.08	68.30	36.78	AVG	No limit
3		5350.000	30.67	37.73	68.40	74.00	-5.60	peak	
4		5350.000	13.28	37.73	51.01	54.00	-2.99	AVG	

REMARKS:

(1) Measurement Value = Reading Level + Correct Factor.

(2) Margin Level = Measurement Value - Limit Value.

Orthogonal Axis	X		
Test Mode	UNII-2A_TX AX (HE40) Mode 5310 MHz	RU configuration	242/62

Horizontal

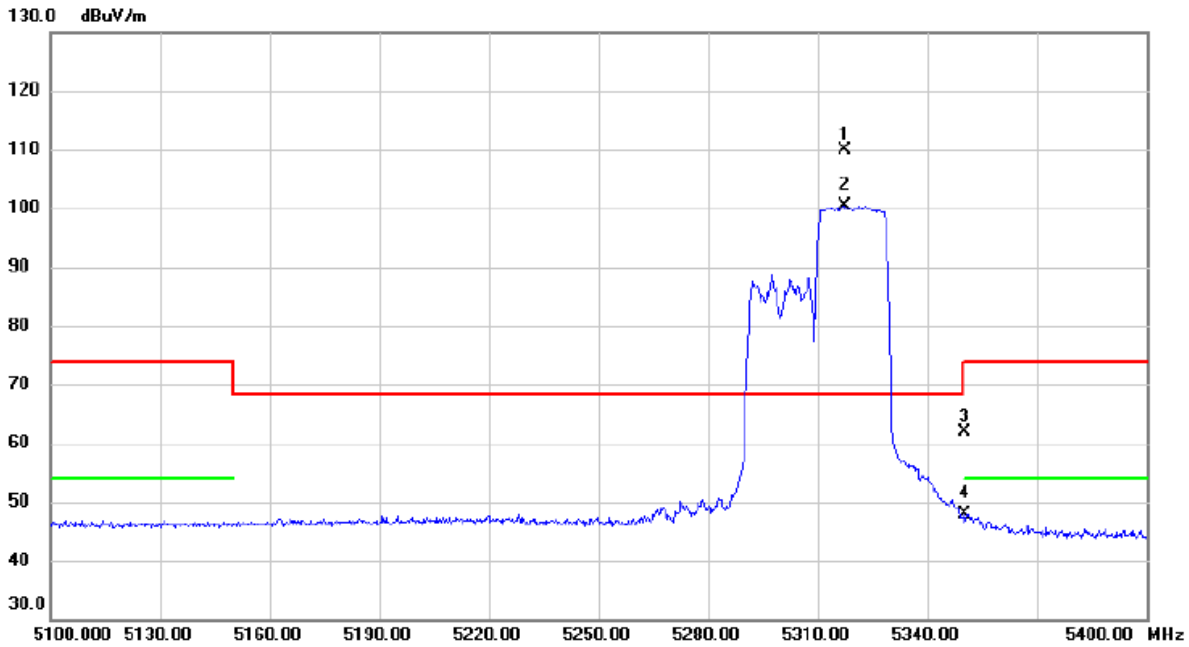

No.	Mk.	Freq. MHz	Reading Level dBuV	Correct Factor dB	Measure- ment dBuV/m	Limit dBuV/m	Margin dB	Detector	Comment
1	*	5317.500	72.28	37.60	109.88	68.30	41.58	peak	No limit
2	X	5317.500	62.86	37.60	100.46	68.30	32.16	AVG	No limit
3		5350.000	24.26	37.73	61.99	74.00	-12.01	peak	
4		5350.000	10.15	37.73	47.88	54.00	-6.12	AVG	

REMARKS:

(1) Measurement Value = Reading Level + Correct Factor.

(2) Margin Level = Measurement Value - Limit Value.

Orthogonal Axis	X		
Test Mode	UNII-2A_TX AX (HE40) Mode 5310 MHz	RU configuration	484/65

Vertical

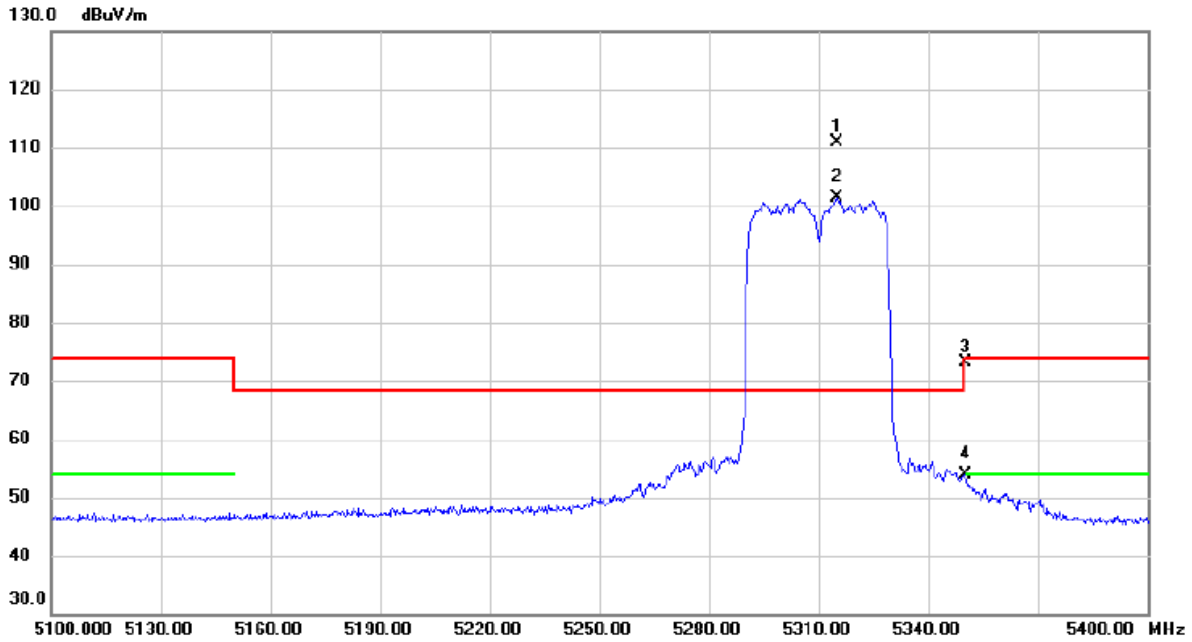

No.	Mk.	Freq. MHz	Reading Level dBuV	Correct Factor dB	Measure- ment dBuV/m	Limit dBuV/m	Margin dB	Detector	Comment
1	*	5314.950	73.37	37.60	110.97	68.30	42.67	peak	No limit
2	X	5314.950	63.84	37.60	101.44	68.30	33.14	AVG	No limit
3		5350.000	35.37	37.73	73.10	74.00	-0.90	peak	
4		5350.000	16.13	37.73	53.86	54.00	-0.14	AVG	

REMARKS:

- (1) Measurement Value = Reading Level + Correct Factor.
- (2) Margin Level = Measurement Value - Limit Value.

Orthogonal Axis	X		
Test Mode	UNII-2A_TX AX (HE40) Mode 5310 MHz	RU configuration	484/65

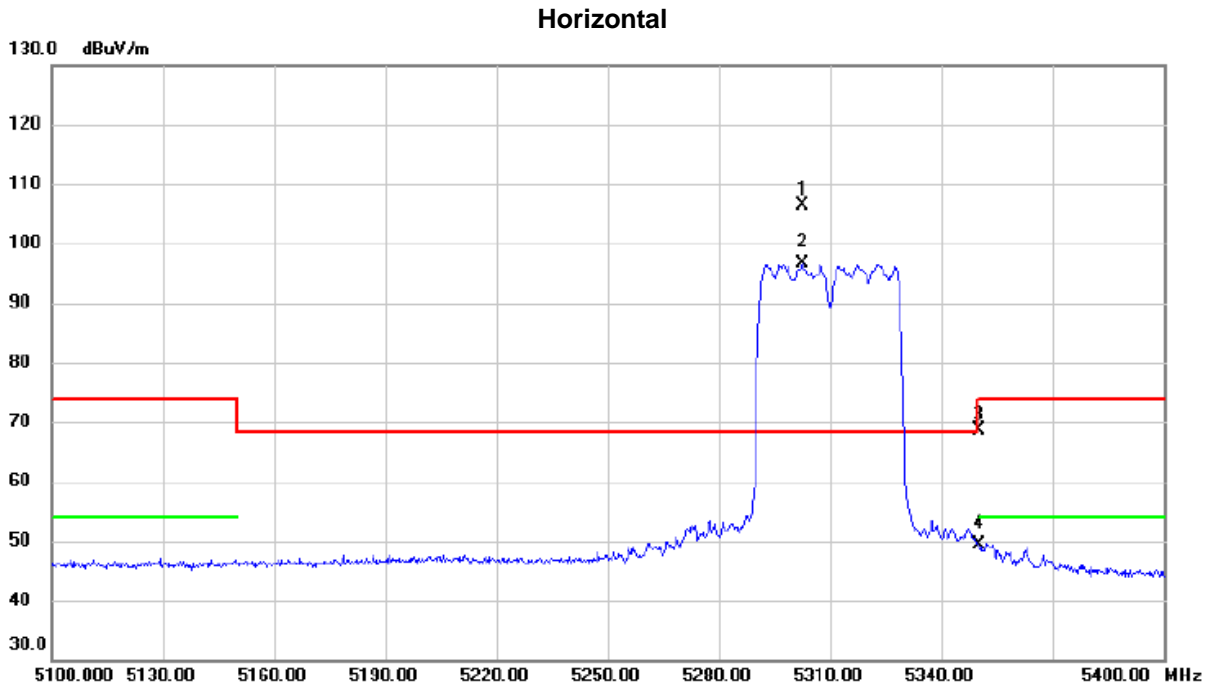

No.	Mk.	Freq. MHz	Reading Level dBuV	Correct Factor dB	Measure- ment dBuV/m	Limit dBuV/m	Margin dB	Detector	Comment
1	*	5302.500	68.89	37.55	106.44	68.30	38.14	peak	No limit
2	X	5302.500	59.11	37.55	96.66	68.30	28.36	AVG	No limit
3		5350.000	30.81	37.73	68.54	74.00	-5.46	peak	
4		5350.000	11.63	37.73	49.36	54.00	-4.64	AVG	

REMARKS:

- (1) Measurement Value = Reading Level + Correct Factor.
- (2) Margin Level = Measurement Value - Limit Value.

Orthogonal Axis	X		
Test Mode	UNII-2A_TX AX (HE40) Mode 5310 MHz	RU configuration	242/62

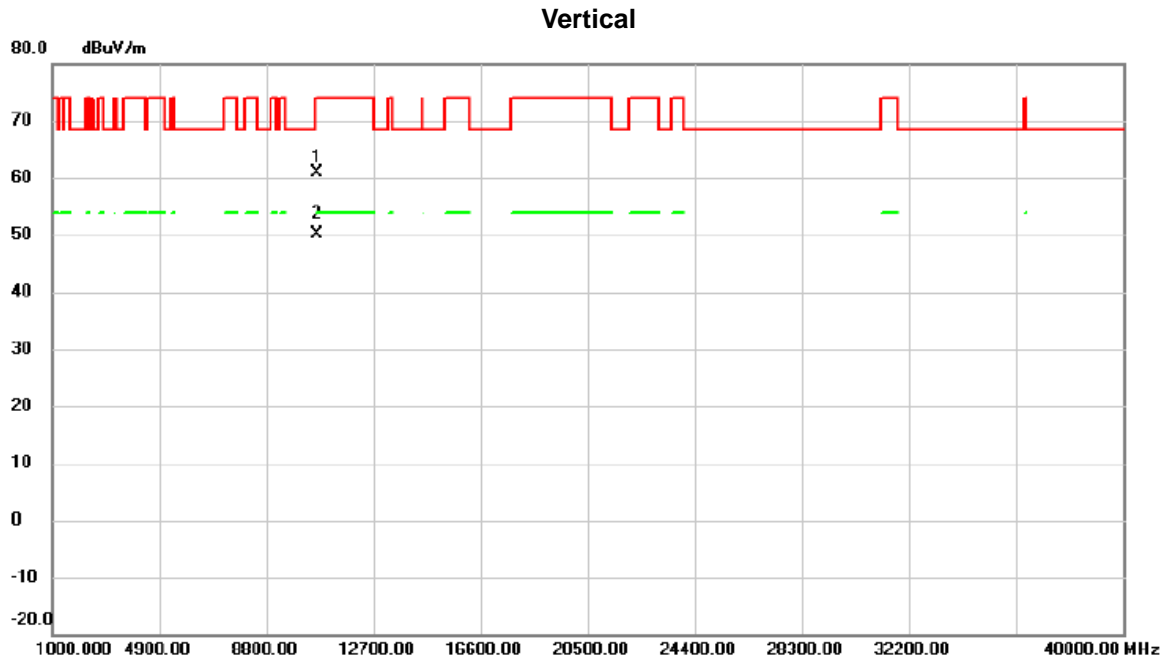

No.	Mk.	Freq. MHz	Reading Level dBuV	Correct Factor dB	Measure- ment dBuV/m	Limit dBuV/m	Margin dB	Detector	Comment
1		10643.40	59.05	1.93	60.98	74.00	-13.02	peak	
2	*	10649.02	48.32	1.93	50.25	54.00	-3.75	AVG	

REMARKS:

- (1) Measurement Value = Reading Level + Correct Factor.
- (2) Margin Level = Measurement Value - Limit Value.

Orthogonal Axis	X		
Test Mode	UNII-2A_TX AX (HE40) Mode 5310 MHz	RU configuration	242/62

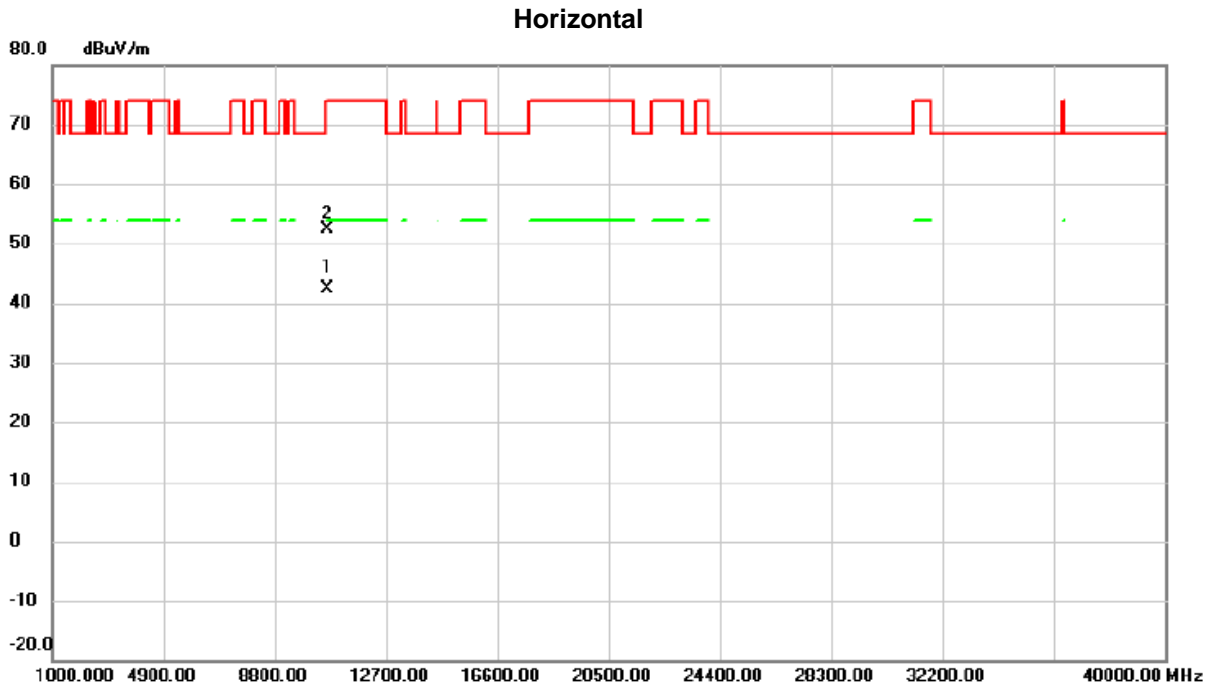

No.	Mk.	Freq. MHz	Reading Level dBuV	Correct Factor dB	Measure- ment dBuV/m	Limit dBuV/m	Margin dB	Detector	Comment
1	*	10649.82	40.37	1.93	42.30	54.00	-11.70	AVG	
2		10652.30	50.51	1.95	52.46	74.00	-21.54	peak	

REMARKS:

- (1) Measurement Value = Reading Level + Correct Factor.
- (2) Margin Level = Measurement Value - Limit Value.

Orthogonal Axis	X		
Test Mode	UNII-2C_TX AX (HE40) Mode 5510 MHz	RU configuration	52/37

Vertical

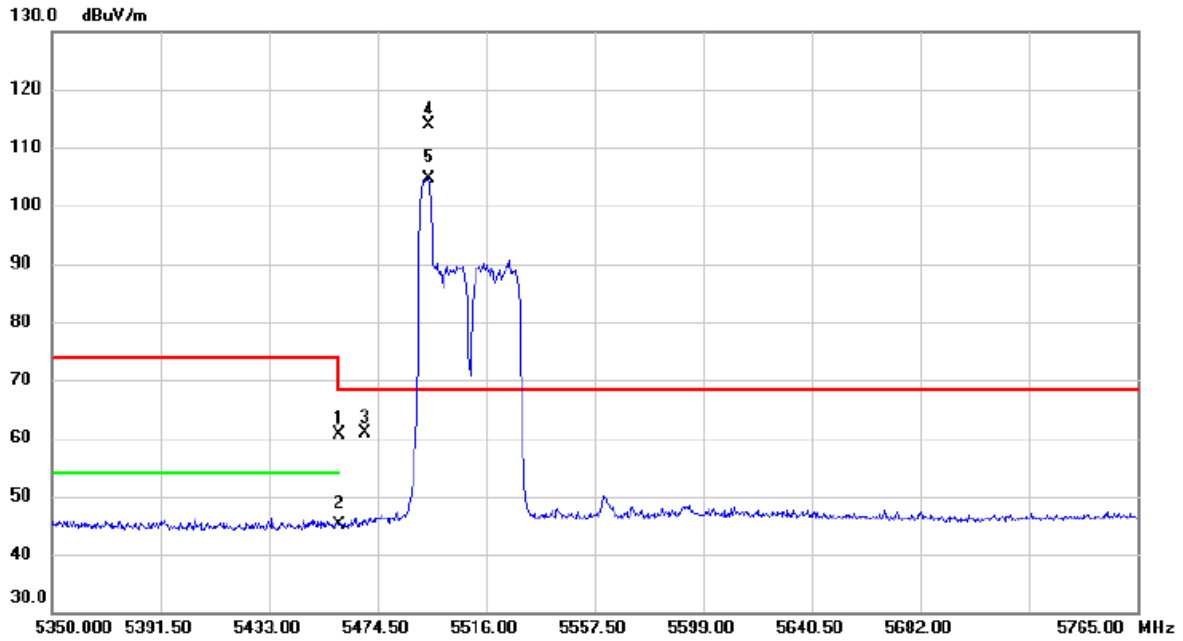

No.	Mk.	Freq. MHz	Reading Level dBuV	Correct Factor dB	Measure- ment dBuV/m	Limit dBuV/m	Margin dB	Detector	Comment
1		5460.000	22.47	38.12	60.59	74.00	-13.41	peak	
2		5460.000	7.02	38.12	45.14	54.00	-8.86	AVG	
3		5470.000	22.76	38.15	60.91	68.30	-7.39	peak	
4	*	5494.005	75.60	38.22	113.82	68.30	45.52	peak	No limit
5	X	5494.005	66.51	38.22	104.73	68.30	36.43	AVG	No limit

REMARKS:

(1) Measurement Value = Reading Level + Correct Factor.

(2) Margin Level = Measurement Value - Limit Value.

Orthogonal Axis	X		
Test Mode	UNII-2C_TX AX (HE40) Mode 5510 MHz	RU configuration	52/37

Horizontal

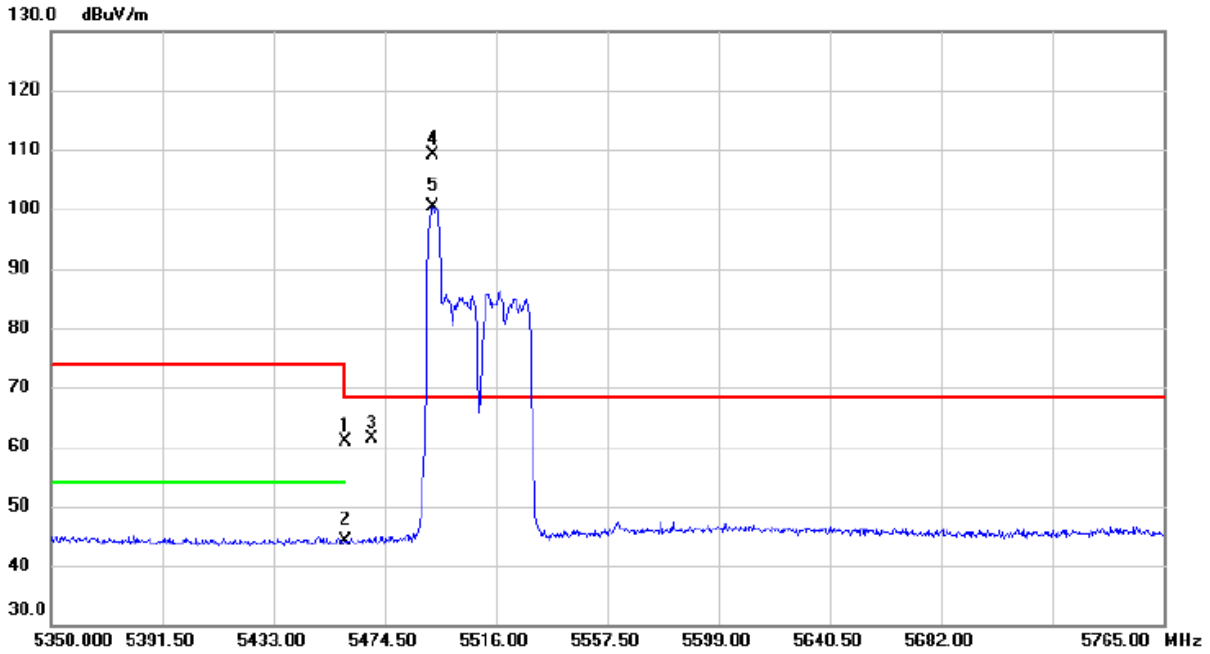

No.	Mk.	Freq. MHz	Reading Level dBuV	Correct Factor dB	Measure- ment dBuV/m	Limit dBuV/m	Margin dB	Detector	Comment
1		5460.000	22.69	38.12	60.81	74.00	-13.19	peak	
2		5460.000	5.96	38.12	44.08	54.00	-9.92	AVG	
3		5470.000	23.12	38.15	61.27	68.30	-7.03	peak	
4	*	5492.345	71.00	38.21	109.21	68.30	40.91	peak	No limit
5	X	5492.345	62.26	38.21	100.47	68.30	32.17	AVG	No limit

REMARKS:

- (1) Measurement Value = Reading Level + Correct Factor.
- (2) Margin Level = Measurement Value - Limit Value.

Orthogonal Axis	X		
Test Mode	UNII-2C_TX AX (HE40) Mode 5510 MHz	RU configuration	106/53

Vertical

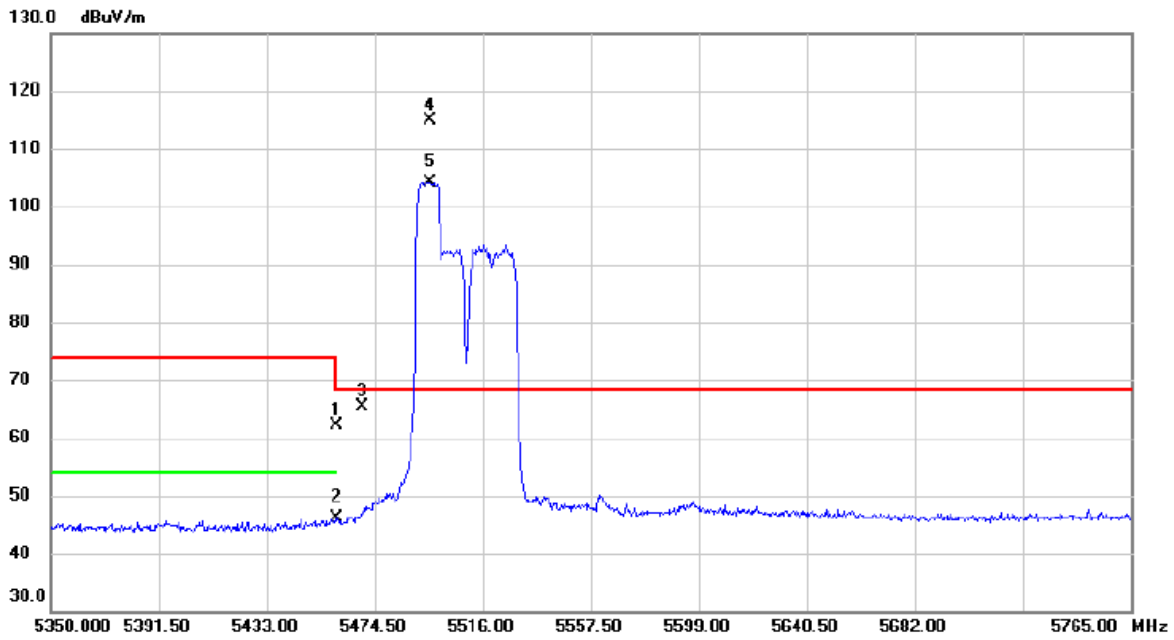

No.	Mk.	Freq. MHz	Reading Level dBuV	Correct Factor dB	Measure- ment dBuV/m	Limit dBuV/m	Margin dB	Detector	Comment
1		5460.000	23.95	38.12	62.07	74.00	-11.93	peak	
2		5460.000	8.04	38.12	46.16	54.00	-7.84	AVG	
3		5470.000	27.34	38.15	65.49	68.30	-2.81	peak	
4	*	5496.080	76.64	38.23	114.87	68.30	46.57	peak	No limit
5	X	5496.080	65.97	38.23	104.20	68.30	35.90	AVG	No limit

REMARKS:

(1) Measurement Value = Reading Level + Correct Factor.

(2) Margin Level = Measurement Value - Limit Value.

Orthogonal Axis	X		
Test Mode	UNII-2C_TX AX (HE40) Mode 5510 MHz	RU configuration	106/53

Horizontal

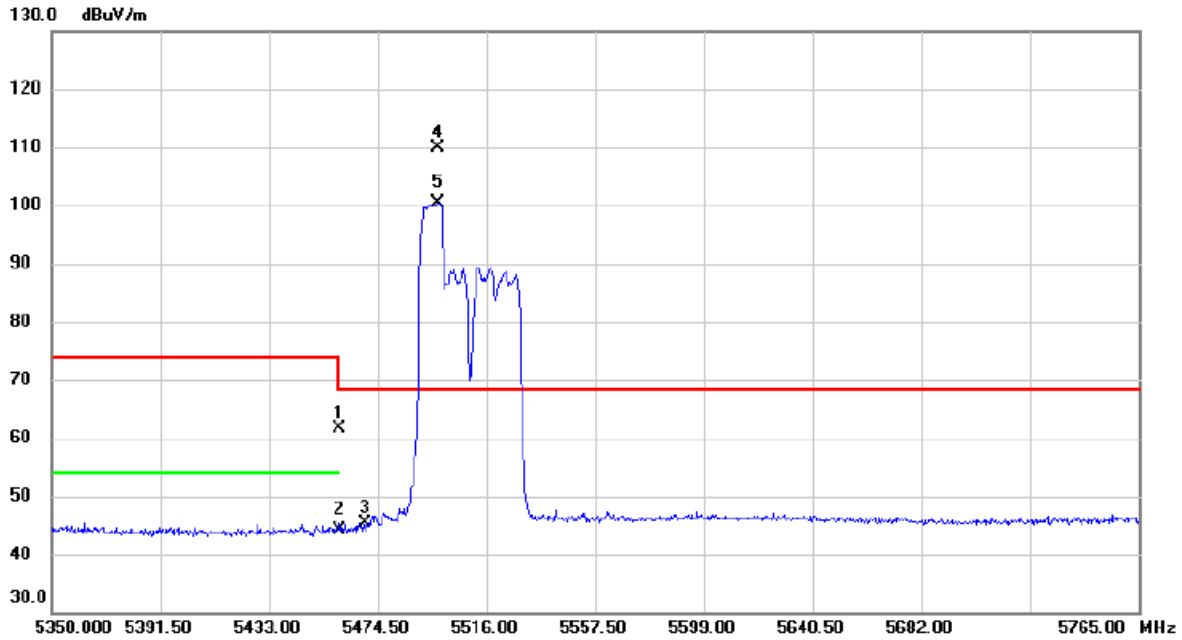

No.	Mk.	Freq. MHz	Reading Level dBuV	Correct Factor dB	Measure- ment dBuV/m	Limit dBuV/m	Margin dB	Detector	Comment
1		5460.000	23.41	38.12	61.53	74.00	-12.47	peak	
2		5460.000	6.07	38.12	44.19	54.00	-9.81	AVG	
3		5470.000	7.12	38.15	45.27	68.30	-23.03	peak	
4	*	5497.533	71.59	38.23	109.82	68.30	41.52	peak	No limit
5	X	5497.533	62.15	38.23	100.38	68.30	32.08	AVG	No limit

REMARKS:

- (1) Measurement Value = Reading Level + Correct Factor.
- (2) Margin Level = Measurement Value - Limit Value.

Orthogonal Axis	X		
Test Mode	UNII-2C_TX AX (HE40) Mode 5510 MHz	RU configuration	242/61

Vertical

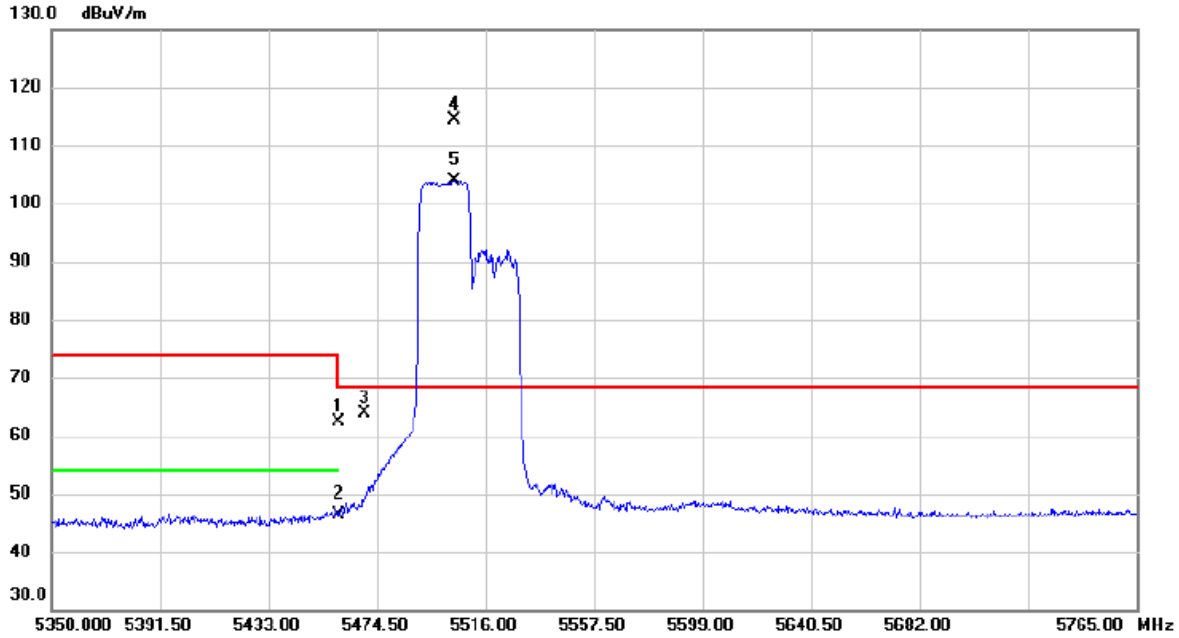

No.	Mk.	Freq. MHz	Reading Level dBuV	Correct Factor dB	Measure- ment dBuV/m	Limit dBuV/m	Margin dB	Detector	Comment
1		5460.000	24.38	38.12	62.50	74.00	-11.50	peak	
2		5460.000	8.19	38.12	46.31	54.00	-7.69	AVG	
3		5470.000	25.81	38.15	63.96	68.30	-4.34	peak	
4	*	5504.172	76.09	38.24	114.33	68.30	46.03	peak	No limit
5	X	5504.172	65.73	38.24	103.97	68.30	35.67	AVG	No limit

REMARKS:

(1) Measurement Value = Reading Level + Correct Factor.

(2) Margin Level = Measurement Value - Limit Value.

Orthogonal Axis	X		
Test Mode	UNII-2C_TX AX (HE40) Mode 5510 MHz	RU configuration	242/61

Horizontal

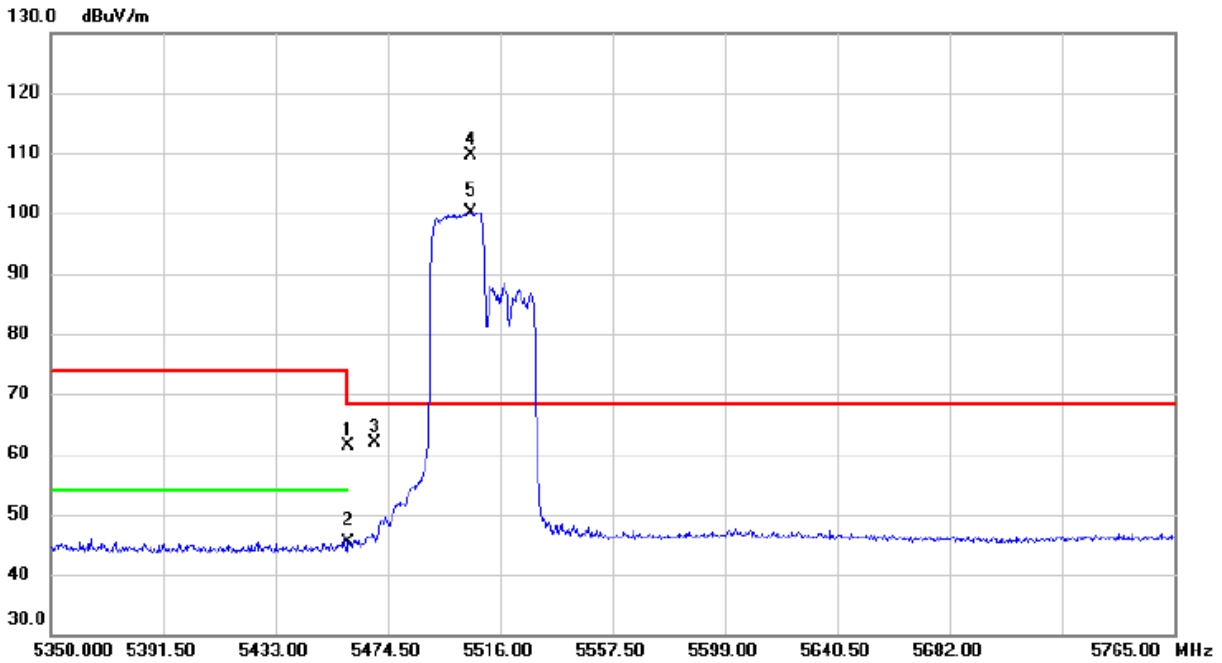

No.	Mk.	Freq. MHz	Reading Level dBuV	Correct Factor dB	Measure- ment dBuV/m	Limit dBuV/m	Margin dB	Detector	Comment
1		5460.000	23.36	38.12	61.48	74.00	-12.52	peak	
2		5460.000	7.24	38.12	45.36	54.00	-8.64	AVG	
3		5470.000	23.74	38.15	61.89	68.30	-6.41	peak	
4	*	5505.002	71.27	38.24	109.51	68.30	41.21	peak	No limit
5	X	5505.002	61.90	38.24	100.14	68.30	31.84	AVG	No limit

REMARKS:

- (1) Measurement Value = Reading Level + Correct Factor.
- (2) Margin Level = Measurement Value - Limit Value.

Orthogonal Axis	X		
Test Mode	UNII-2C_TX AX (HE40) Mode 5510 MHz	RU configuration	484/65

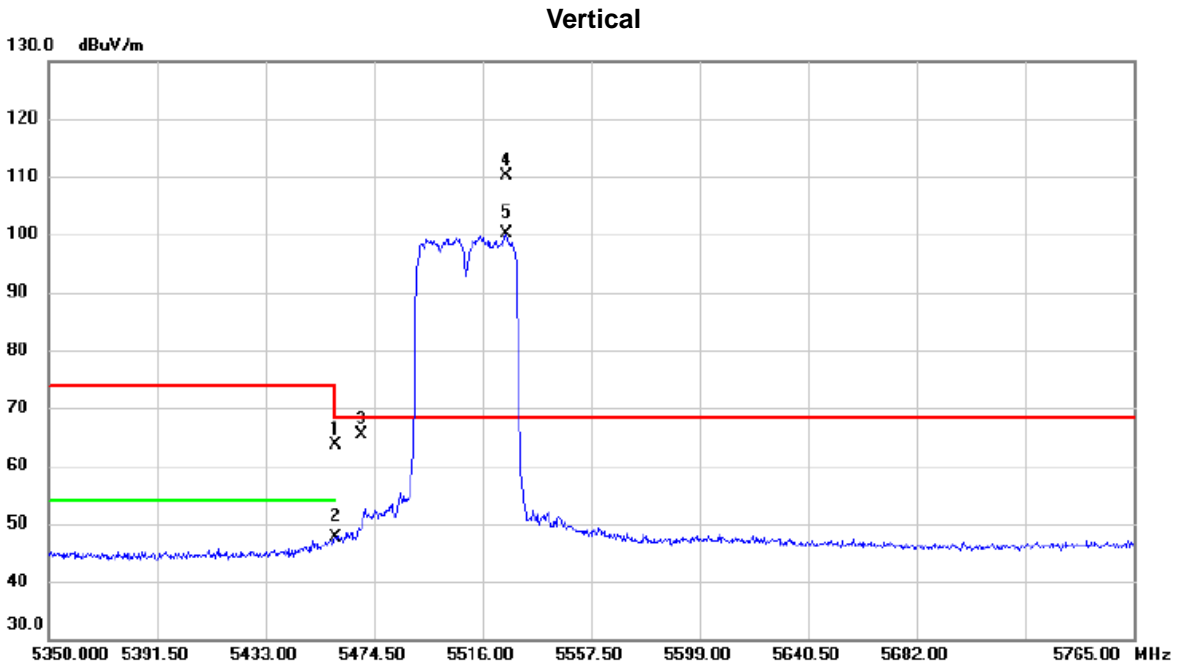

No.	Mk.	Freq. MHz	Reading Level dBuV	Correct Factor dB	Measure- ment dBuV/m	Limit dBuV/m	Margin dB	Detector	Comment
1		5460.000	25.59	38.12	63.71	74.00	-10.29	peak	
2		5460.000	9.60	38.12	47.72	54.00	-6.28	AVG	
3		5470.000	27.26	38.15	65.41	68.30	-2.89	peak	
4	*	5524.922	71.93	38.26	110.19	68.30	41.89	peak	No limit
5	X	5524.922	61.78	38.26	100.04	68.30	31.74	AVG	No limit

REMARKS:

(1) Measurement Value = Reading Level + Correct Factor.

(2) Margin Level = Measurement Value - Limit Value.

Orthogonal Axis	X		
Test Mode	UNII-2C_TX AX (HE40) Mode 5510 MHz	RU configuration	484/65

Horizontal

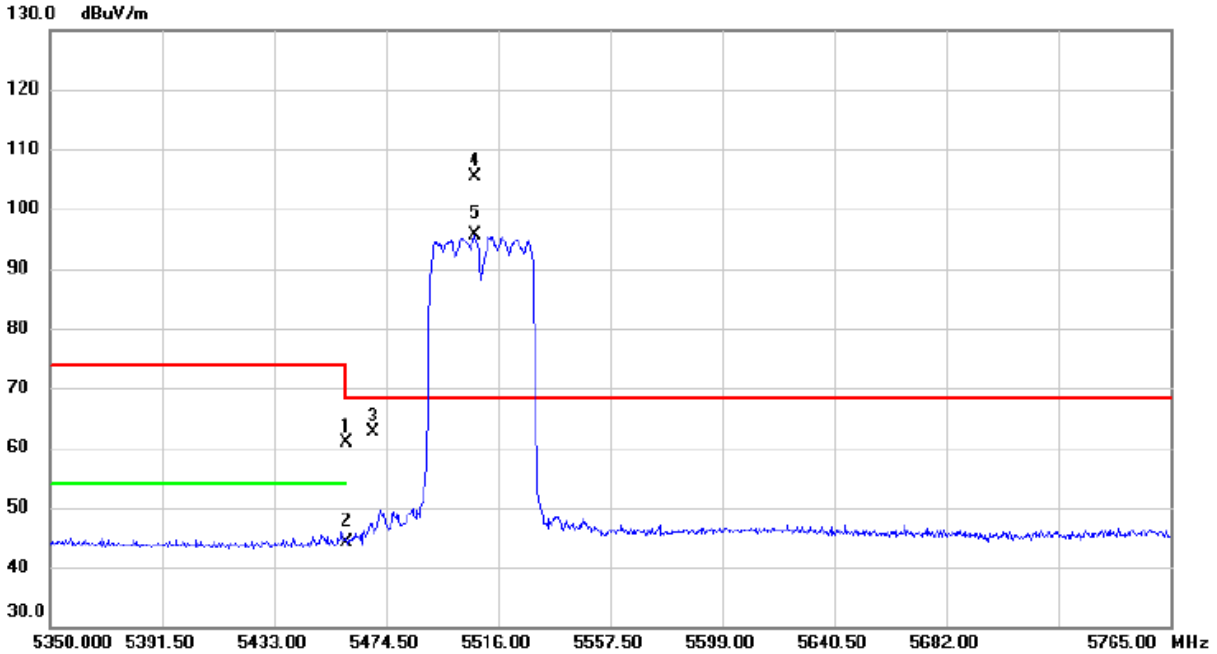

No.	Mk.	Freq. MHz	Reading Level dBuV	Correct Factor dB	Measure- ment dBuV/m	Limit dBuV/m	Margin dB	Detector	Comment
1		5460.000	22.72	38.12	60.84	74.00	-13.16	peak	
2		5460.000	5.99	38.12	44.11	54.00	-9.89	AVG	
3		5470.000	24.57	38.15	62.72	68.30	-5.58	peak	
4	*	5507.493	67.23	38.25	105.48	68.30	37.18	peak	No limit
5	X	5507.493	57.28	38.25	95.53	68.30	27.23	AVG	No limit

REMARKS:

- (1) Measurement Value = Reading Level + Correct Factor.
- (2) Margin Level = Measurement Value - Limit Value.

Orthogonal Axis	X		
Test Mode	UNII-2C_TX AX (HE40) Mode 5510 MHz	RU configuration	242/61

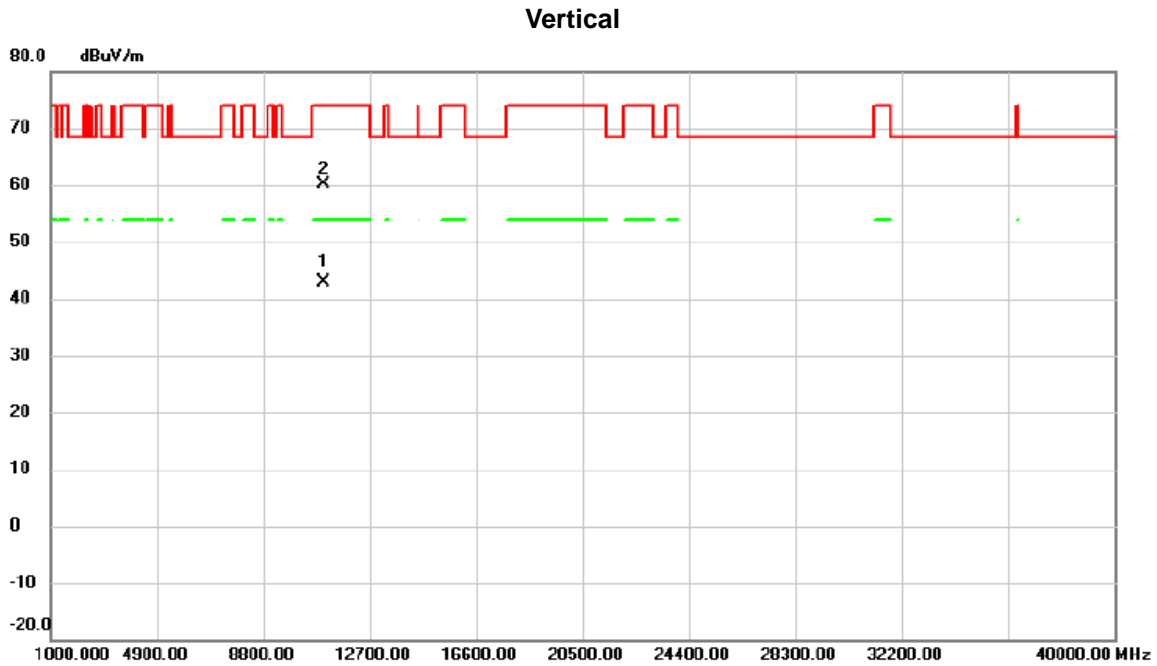

No.	Mk.	Freq.	Reading Level	Correct Factor	Measurement	Limit	Margin	Detector	Comment
		MHz	dBuV	dB	dBuV/m	dBuV/m	dB		
1	*	11010.77	40.55	2.32	42.87	54.00	-11.13	AVG	
2		11013.37	57.71	2.31	60.02	74.00	-13.98	peak	

REMARKS:

- (1) Measurement Value = Reading Level + Correct Factor.
- (2) Margin Level = Measurement Value - Limit Value.

Orthogonal Axis	X		
Test Mode	UNII-2C_TX AX (HE40) Mode 5510 MHz	RU configuration	242/61

Horizontal

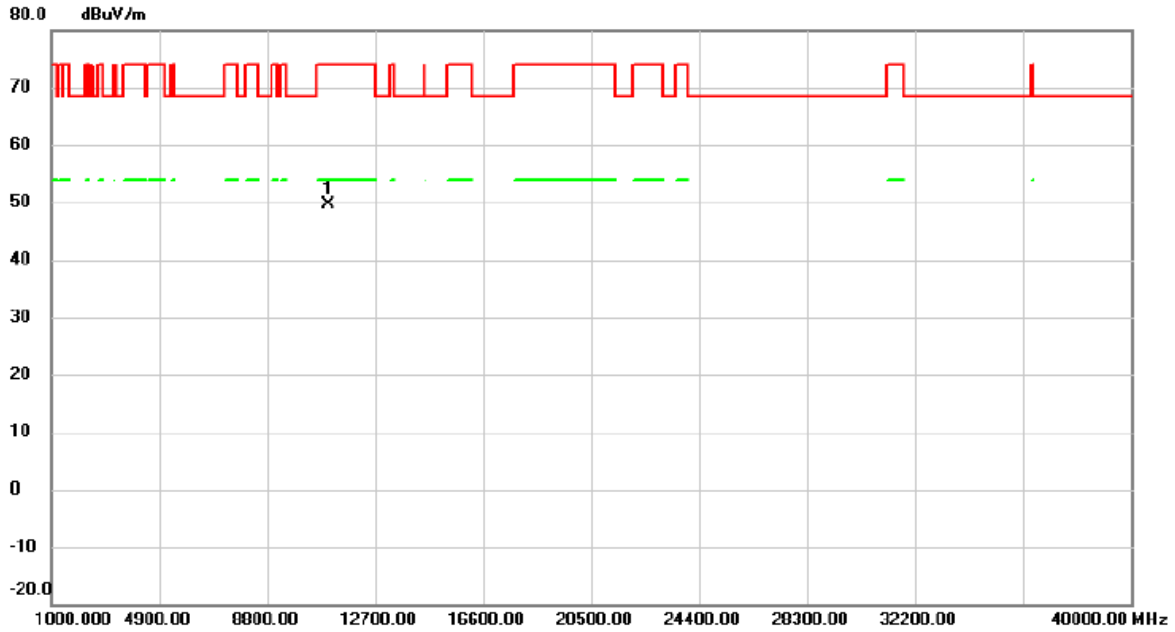

No.	Mk.	Freq.	Reading Level	Correct Factor	Measurement	Limit	Margin	Detector	Comment
		MHz	dBuV	dB	dBuV/m	dBuV/m	dB		
1	*	11019.20	47.37	2.30	49.67	74.00	-24.33	peak	

REMARKS:

- (1) Measurement Value = Reading Level + Correct Factor.
- (2) Margin Level = Measurement Value - Limit Value.

Orthogonal Axis	X		
Test Mode	UNII-2C_TX AX (HE40) Mode 5550 MHz	RU configuration	52/37

Vertical

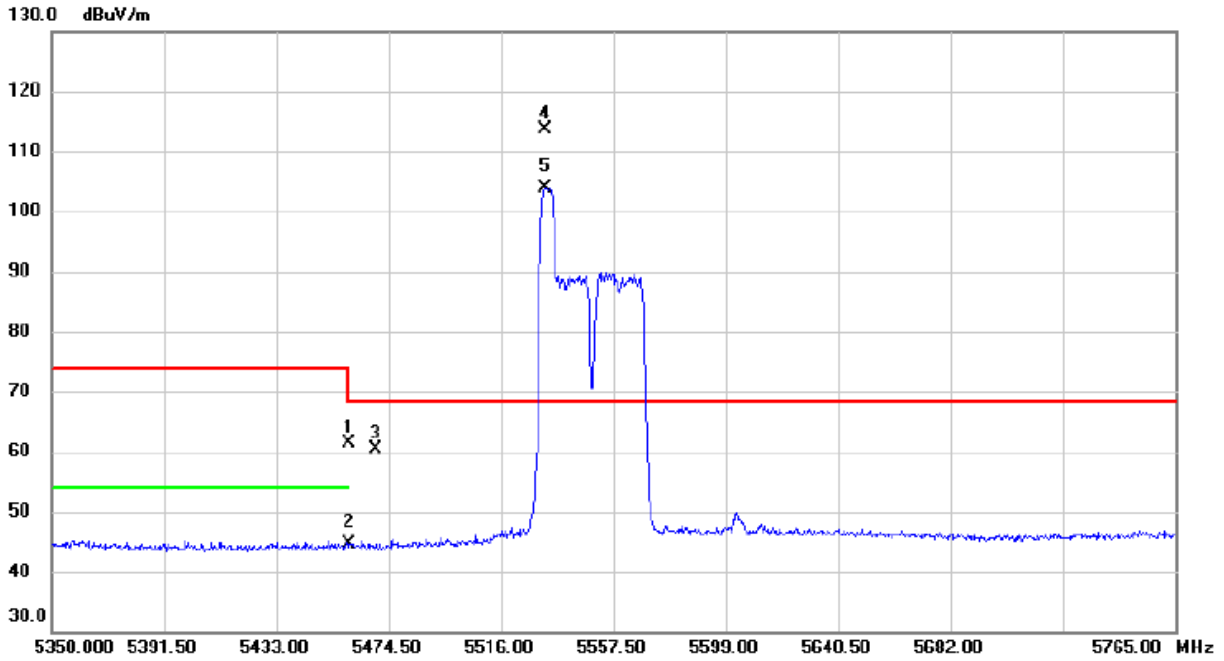

No.	Mk.	Freq. MHz	Reading Level dBuV	Correct Factor dB	Measure- ment dBuV/m	Limit dBuV/m	Margin dB	Detector	Comment
1		5460.000	23.19	38.12	61.31	74.00	-12.69	peak	
2		5460.000	6.47	38.12	44.59	54.00	-9.41	AVG	
3		5470.000	22.31	38.15	60.46	68.30	-7.84	peak	
4	*	5532.392	75.40	38.27	113.67	68.30	45.37	peak	No limit
5	X	5532.392	65.60	38.27	103.87	68.30	35.57	AVG	No limit

REMARKS:

- (1) Measurement Value = Reading Level + Correct Factor.
- (2) Margin Level = Measurement Value - Limit Value.

Orthogonal Axis	X		
Test Mode	UNII-2C_TX AX (HE40) Mode 5550 MHz	RU configuration	52/37

Horizontal

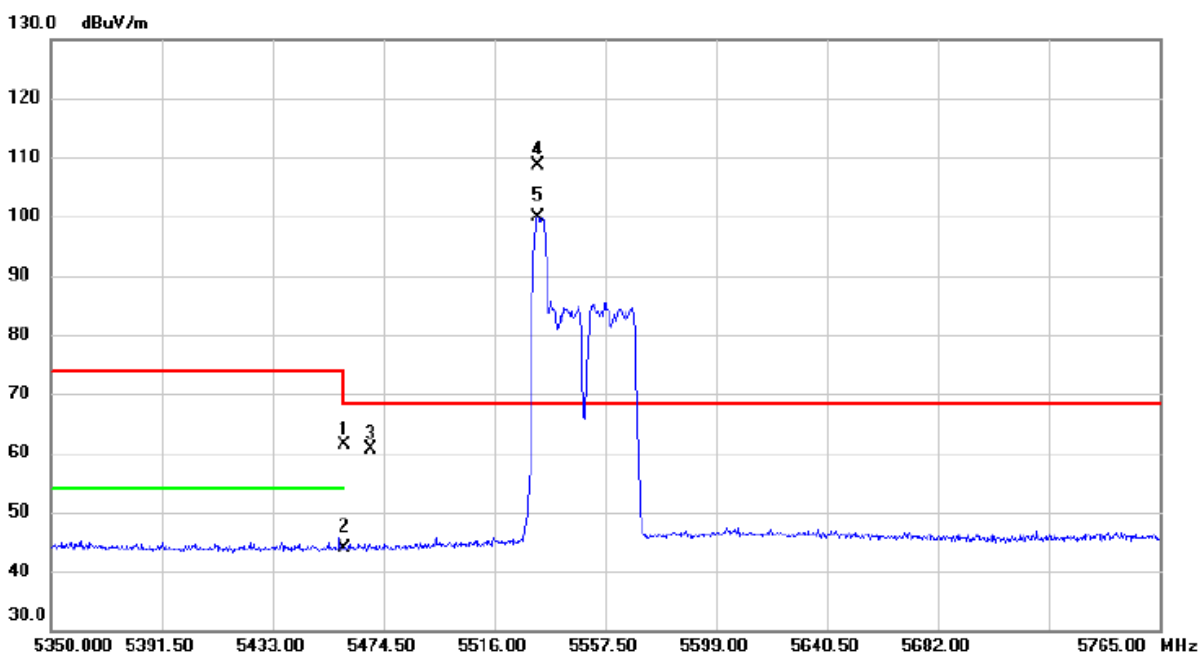

No.	Mk.	Freq. MHz	Reading Level dBuV	Correct Factor dB	Measure- ment dBuV/m	Limit dBuV/m	Margin dB	Detector	Comment
1		5460.000	23.28	38.12	61.40	74.00	-12.60	peak	
2		5460.000	5.64	38.12	43.76	54.00	-10.24	AVG	
3		5470.000	22.41	38.15	60.56	68.30	-7.74	peak	
4	*	5532.185	70.36	38.27	108.63	68.30	40.33	peak	No limit
5	X	5532.185	61.51	38.27	99.78	68.30	31.48	AVG	No limit

REMARKS:

(1) Measurement Value = Reading Level + Correct Factor.

(2) Margin Level = Measurement Value - Limit Value.

Orthogonal Axis	X		
Test Mode	UNII-2C_TX AX (HE40) Mode 5550 MHz	RU configuration	106/53

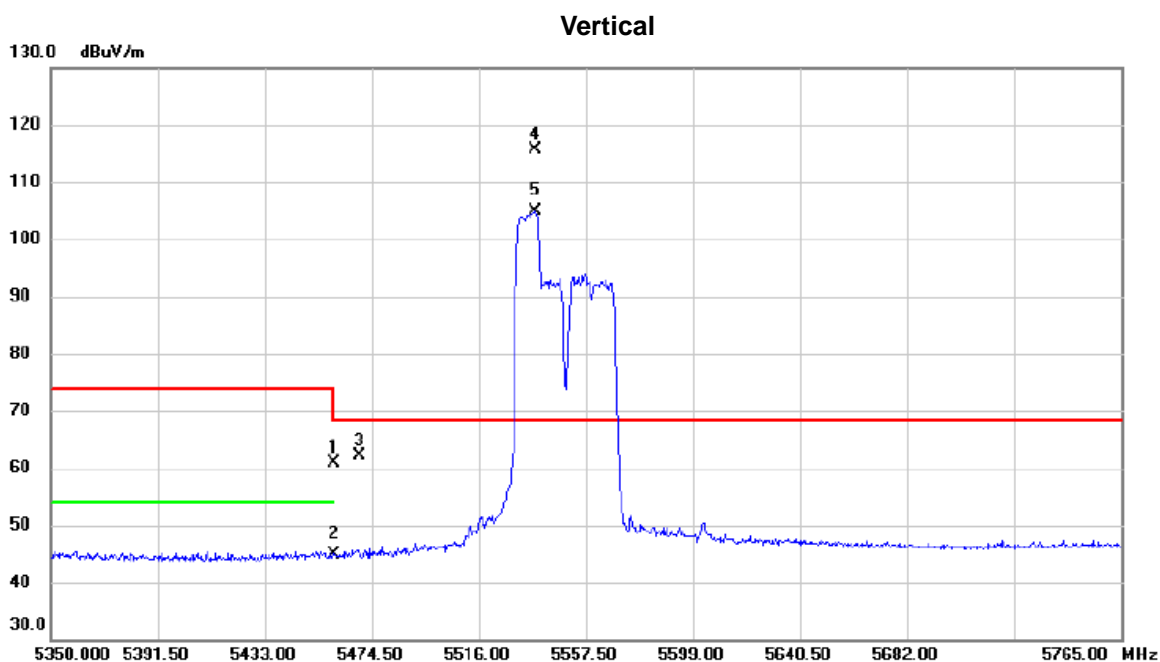

No.	Mk.	Freq. MHz	Reading Level dBuV	Correct Factor dB	Measure- ment dBuV/m	Limit dBuV/m	Margin dB	Detector	Comment
1		5460.000	22.83	38.12	60.95	74.00	-13.05	peak	
2		5460.000	6.73	38.12	44.85	54.00	-9.15	AVG	
3		5470.000	23.91	38.15	62.06	68.30	-6.24	peak	
4	*	5537.788	77.24	38.27	115.51	68.30	47.21	peak	No limit
5	X	5537.788	66.50	38.27	104.77	68.30	36.47	AVG	No limit

REMARKS:

(1) Measurement Value = Reading Level + Correct Factor.

(2) Margin Level = Measurement Value - Limit Value.

Orthogonal Axis	X		
Test Mode	UNII-2C_TX AX (HE40) Mode 5550 MHz	RU configuration	106/53

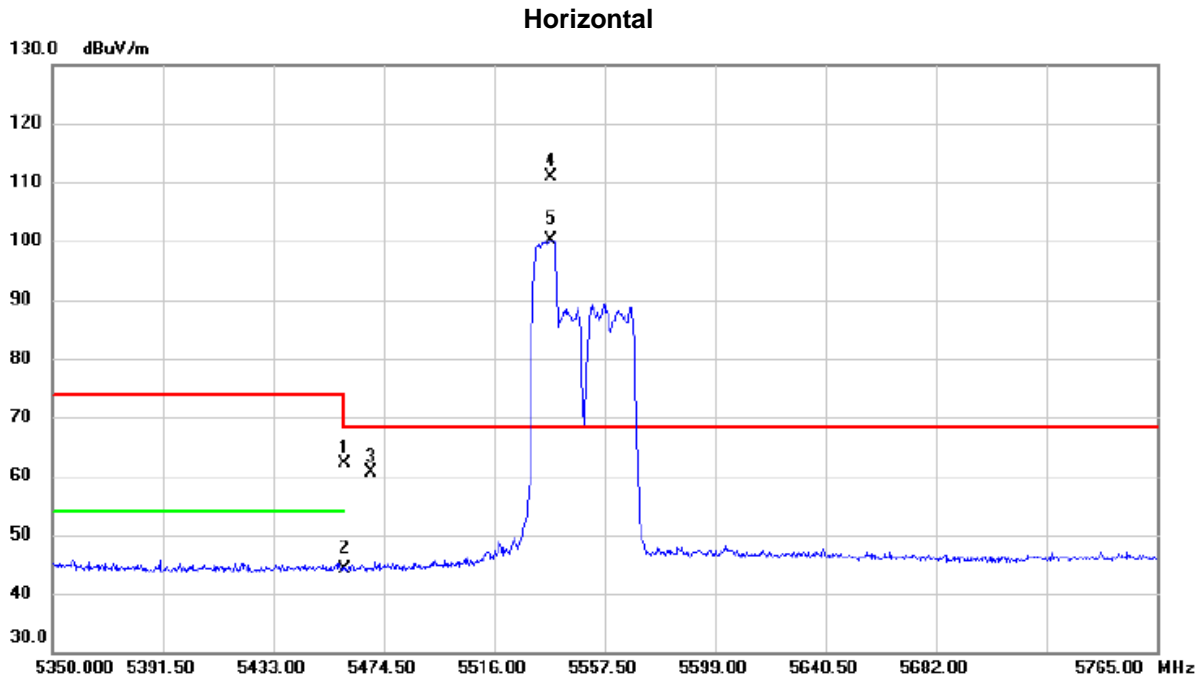

No.	Mk.	Freq. MHz	Reading Level dBuV	Correct Factor dB	Measure- ment dBuV/m	Limit dBuV/m	Margin dB	Detector	Comment
1		5460.000	23.90	38.12	62.02	74.00	-11.98	peak	
2		5460.000	6.00	38.12	44.12	54.00	-9.88	AVG	
3		5470.000	22.45	38.15	60.60	68.30	-7.70	peak	
4	*	5537.580	72.69	38.27	110.96	68.30	42.66	peak	No limit
5	X	5537.580	61.90	38.27	100.17	68.30	31.87	AVG	No limit

REMARKS:

(1) Measurement Value = Reading Level + Correct Factor.

(2) Margin Level = Measurement Value - Limit Value.

Orthogonal Axis	X		
Test Mode	UNII-2C_TX AX (HE40) Mode 5550 MHz	RU configuration	242/61

Vertical

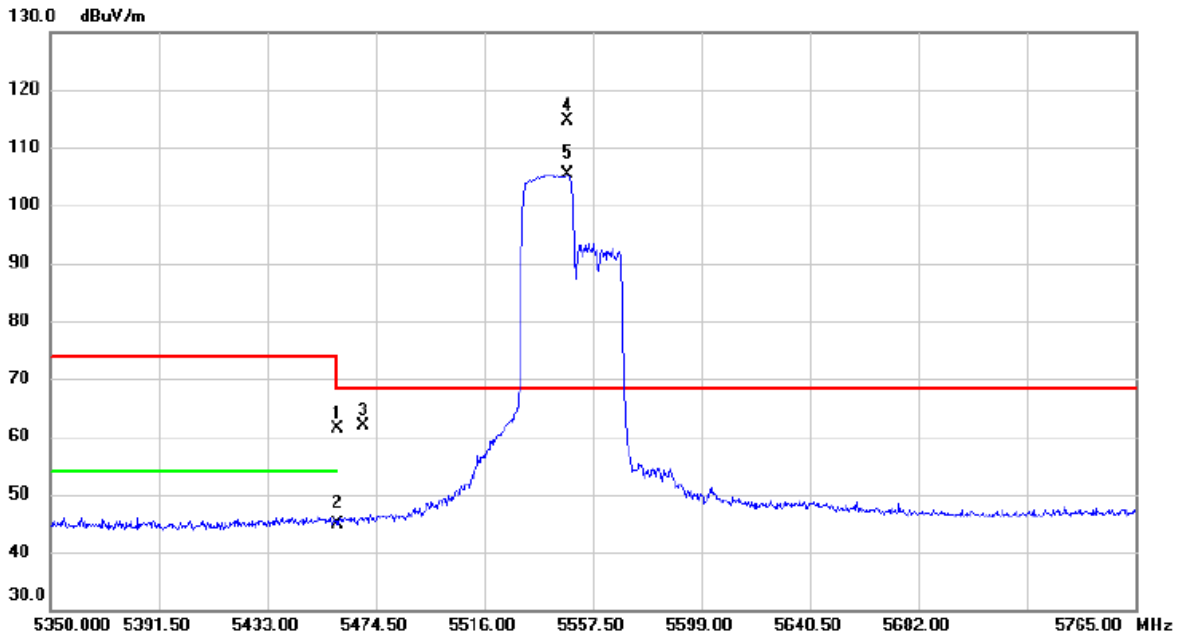

No.	Mk.	Freq. MHz	Reading Level dBuV	Correct Factor dB	Measure- ment dBuV/m	Limit dBuV/m	Margin dB	Detector	Comment
1		5460.000	23.24	38.12	61.36	74.00	-12.64	peak	
2		5460.000	6.86	38.12	44.98	54.00	-9.02	AVG	
3		5470.000	23.76	38.15	61.91	68.30	-6.39	peak	
4	*	5547.748	76.23	38.28	114.51	68.30	46.21	peak	No limit
5	X	5547.748	67.09	38.28	105.37	68.30	37.07	AVG	No limit

REMARKS:

(1) Measurement Value = Reading Level + Correct Factor.

(2) Margin Level = Measurement Value - Limit Value.

Orthogonal Axis	X		
Test Mode	UNII-2C_TX AX (HE40) Mode 5550 MHz	RU configuration	242/61

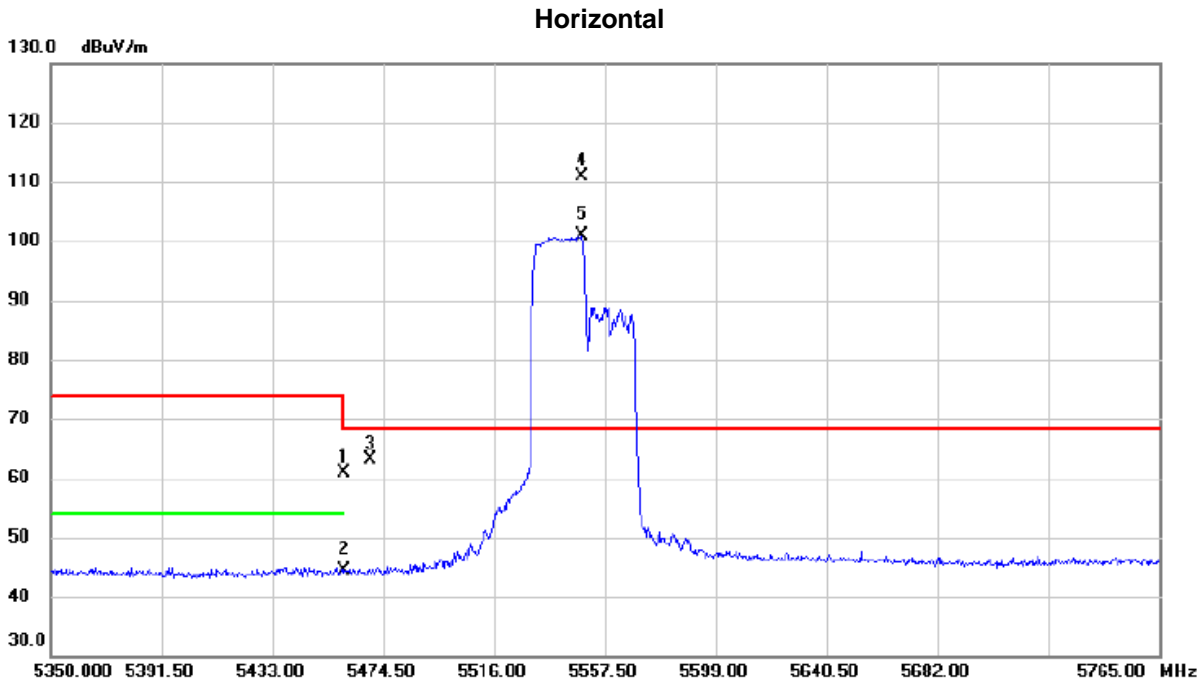

No.	Mk.	Freq. MHz	Reading Level dBuV	Correct Factor dB	Measure- ment dBuV/m	Limit dBuV/m	Margin dB	Detector	Comment
1		5460.000	22.88	38.12	61.00	74.00	-13.00	peak	
2		5460.000	6.14	38.12	44.26	54.00	-9.74	AVG	
3		5470.000	25.07	38.15	63.22	68.30	-5.08	peak	
4	*	5548.993	72.52	38.28	110.80	68.30	42.50	peak	No limit
5	X	5548.993	62.60	38.28	100.88	68.30	32.58	AVG	No limit

REMARKS:

- (1) Measurement Value = Reading Level + Correct Factor.
- (2) Margin Level = Measurement Value - Limit Value.

Orthogonal Axis	X		
Test Mode	UNII-2C_TX AX (HE40) Mode 5550 MHz	RU configuration	484/65

Vertical

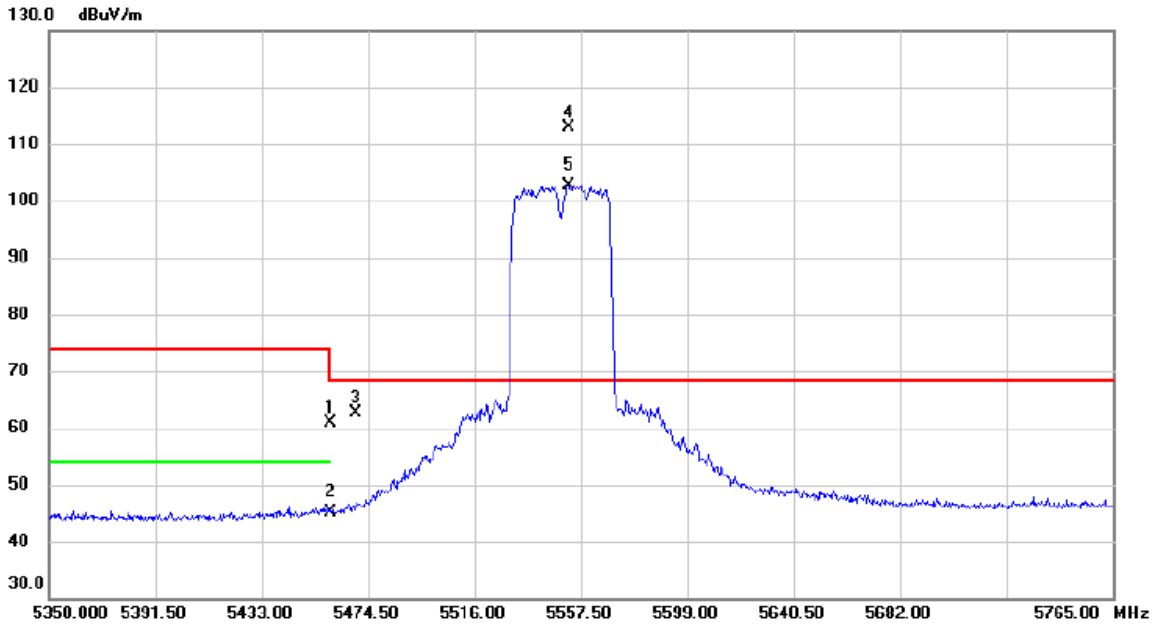

No.	Mk.	Freq. MHz	Reading Level dBuV	Correct Factor dB	Measure- ment dBuV/m	Limit dBuV/m	Margin dB	Detector	Comment
1		5460.000	22.65	38.12	60.77	74.00	-13.23	peak	
2		5460.000	7.07	38.12	45.19	54.00	-8.81	AVG	
3		5470.000	24.55	38.15	62.70	68.30	-5.60	peak	
4	*	5552.520	74.60	38.30	112.90	68.30	44.60	peak	No limit
5	X	5552.520	64.41	38.30	102.71	68.30	34.41	AVG	No limit

REMARKS:

- (1) Measurement Value = Reading Level + Correct Factor.
- (2) Margin Level = Measurement Value - Limit Value.

Orthogonal Axis	X		
Test Mode	UNII-2C_TX AX (HE40) Mode 5550 MHz	RU configuration	484/65

Horizontal

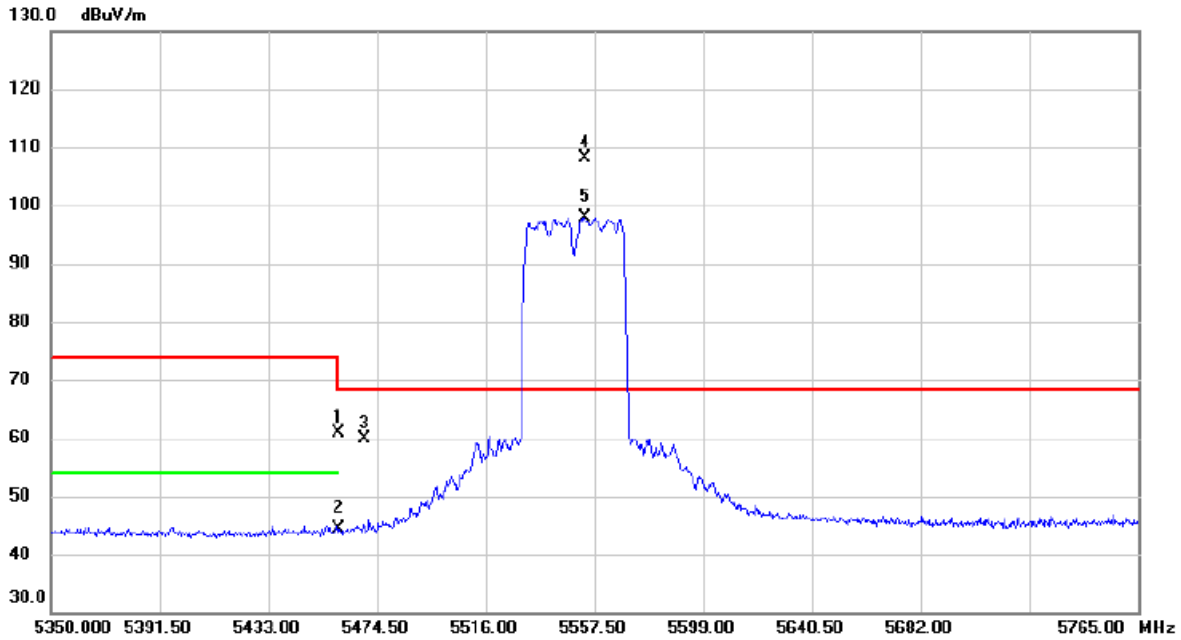

No.	Mk.	Freq. MHz	Reading Level dBuV	Correct Factor dB	Measure- ment dBuV/m	Limit dBuV/m	Margin dB	Detector	Comment
1		5460.000	22.74	38.12	60.86	74.00	-13.14	peak	
2		5460.000	6.16	38.12	44.28	54.00	-9.72	AVG	
3		5470.000	21.76	38.15	59.91	68.30	-8.39	peak	
4	*	5553.765	69.79	38.30	108.09	68.30	39.79	peak	No limit
5	X	5553.765	59.57	38.30	97.87	68.30	29.57	AVG	No limit

REMARKS:

- (1) Measurement Value = Reading Level + Correct Factor.
- (2) Margin Level = Measurement Value - Limit Value.

Orthogonal Axis	X		
Test Mode	UNII-2C_TX AX (HE40) Mode 5550 MHz	RU configuration	242/61

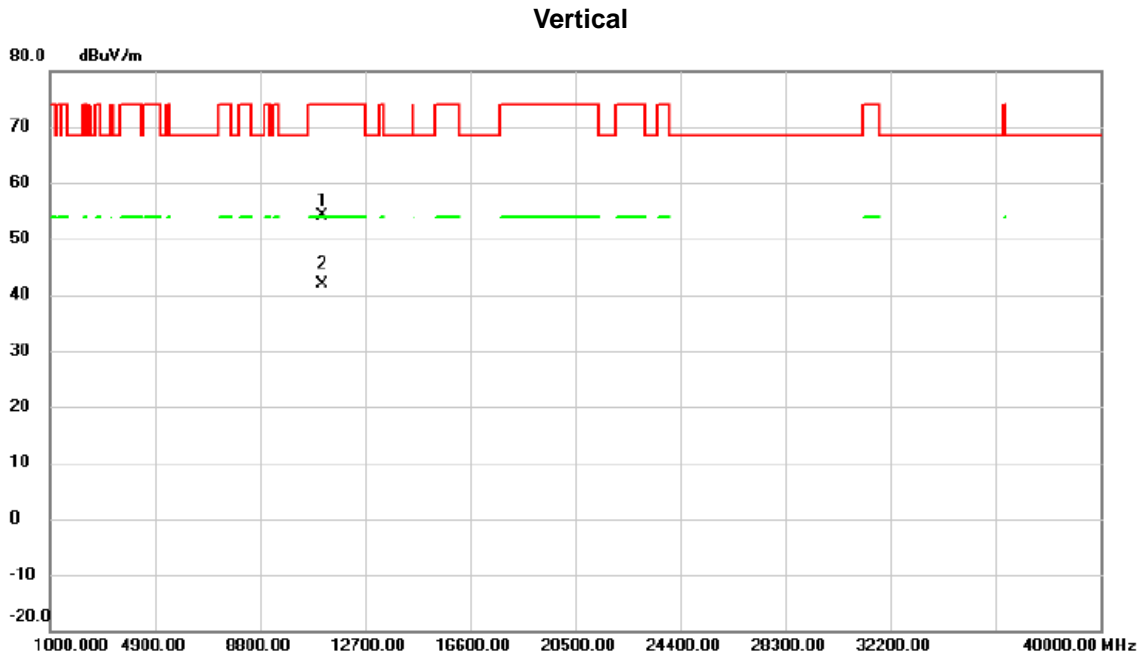

No.	Mk.	Freq. MHz	Reading Level dBuV	Correct Factor dB	Measure- ment dBuV/m	Limit dBuV/m	Margin dB	Detector	Comment
1		11090.17	52.00	2.16	54.16	74.00	-19.84	peak	
2	*	11091.15	39.62	2.16	41.78	54.00	-12.22	AVG	

REMARKS:

- (1) Measurement Value = Reading Level + Correct Factor.
- (2) Margin Level = Measurement Value - Limit Value.

Orthogonal Axis	X		
Test Mode	UNII-2C_TX AX (HE40) Mode 5550 MHz	RU configuration	242/61

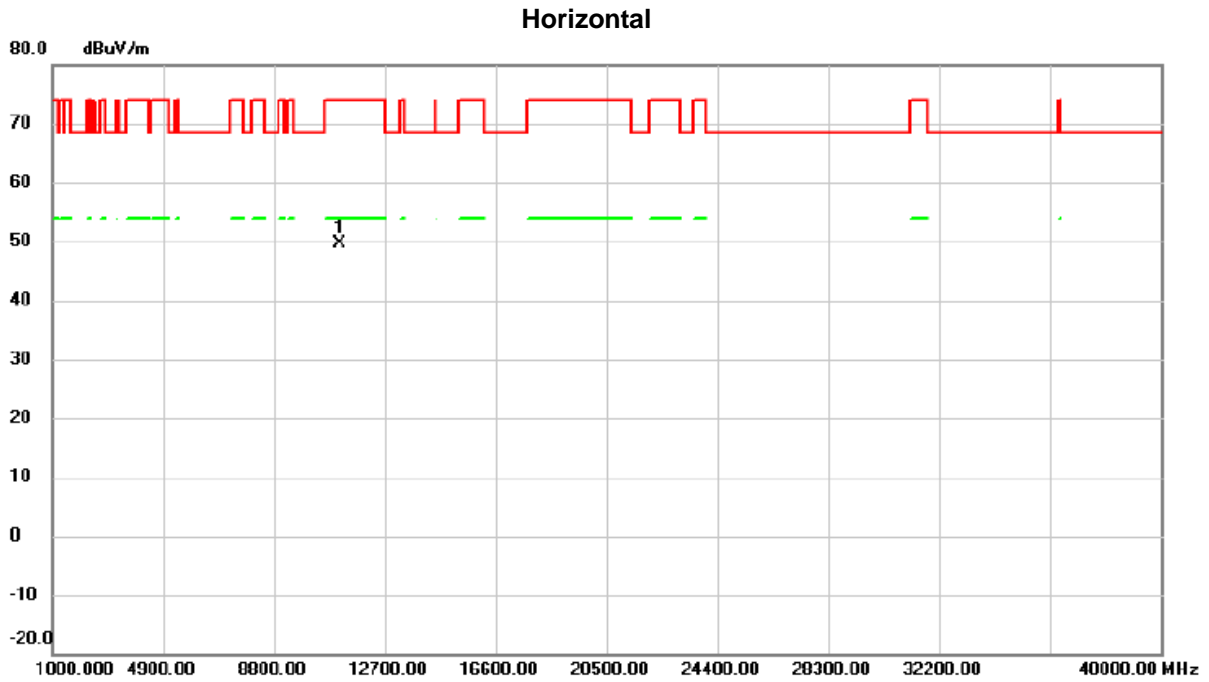

No.	Mk.	Freq.	Reading Level	Correct Factor	Measurement	Limit	Margin	Detector	Comment
		MHz	dBuV	dB	dBuV/m	dBuV/m	dB		
1	*	11096.12	47.52	2.15	49.67	74.00	-24.33	peak	

REMARKS:

- (1) Measurement Value = Reading Level + Correct Factor.
- (2) Margin Level = Measurement Value - Limit Value.

Orthogonal Axis	X		
Test Mode	UNII-2C_TX AX (HE40) Mode 5670 MHz	RU configuration	52/44

Vertical

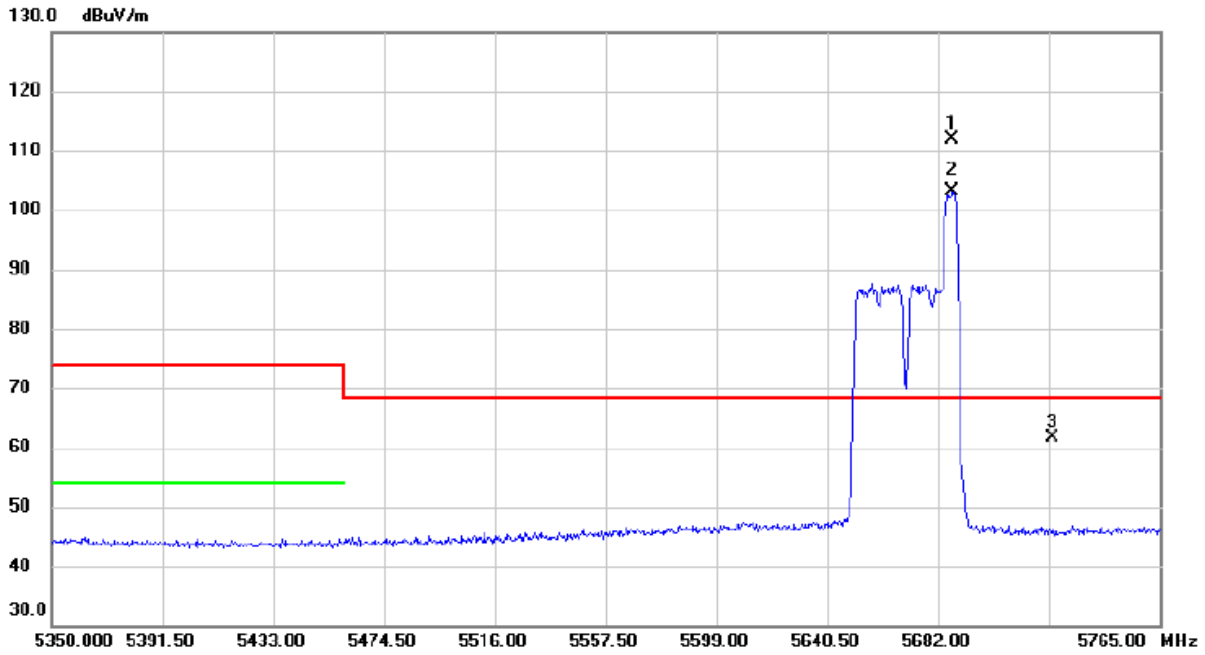

No.	Mk.	Freq. MHz	Reading Level dBuV	Correct Factor dB	Measure- ment dBuV/m	Limit dBuV/m	Margin dB	Detector	Comment
1	*	5687.395	73.44	38.39	111.83	68.30	43.53	peak	No limit
2	X	5687.395	64.72	38.39	103.11	68.30	34.81	AVG	No limit
3		5725.000	23.21	38.50	61.71	68.30	-6.59	peak	

REMARKS:

- (1) Measurement Value = Reading Level + Correct Factor.
- (2) Margin Level = Measurement Value - Limit Value.

Orthogonal Axis	X		
Test Mode	UNII-2C_TX AX (HE40) Mode 5670 MHz	RU configuration	52/44

Horizontal

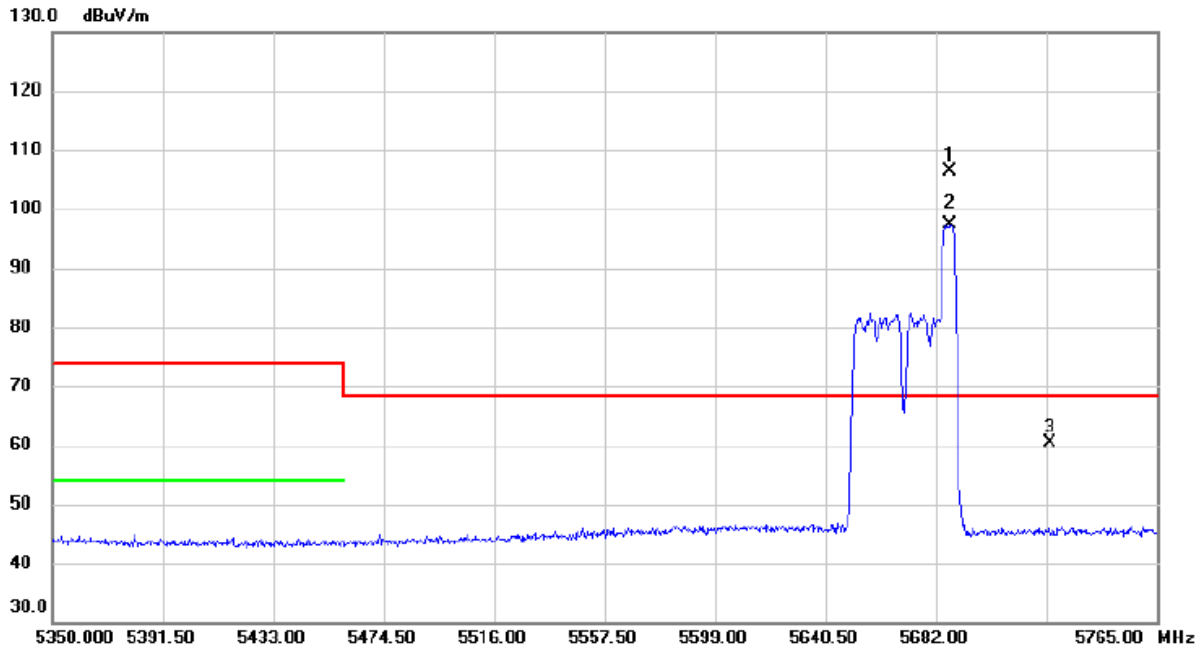

No.	Mk.	Freq. MHz	Reading Level dBuV	Correct Factor dB	Measure- ment dBuV/m	Limit dBuV/m	Margin dB	Detector	Comment
1	*	5687.395	68.05	38.39	106.44	68.30	38.14	peak	No limit
2	X	5687.395	58.87	38.39	97.26	68.30	28.96	AVG	No limit
3		5725.000	21.76	38.50	60.26	68.30	-8.04	peak	

REMARKS:

- (1) Measurement Value = Reading Level + Correct Factor.
- (2) Margin Level = Measurement Value - Limit Value.

Orthogonal Axis	X		
Test Mode	UNII-2C_TX AX (HE40) Mode 5670 MHz	RU configuration	106/56

Vertical

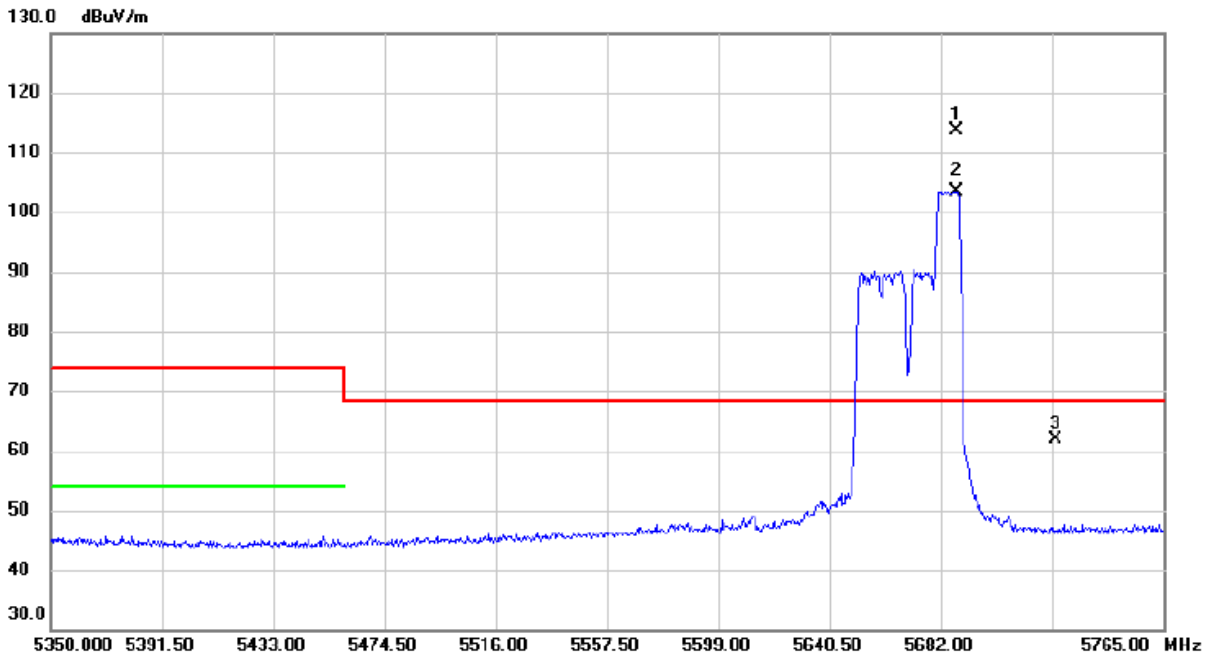

No.	Mk.	Freq. MHz	Reading Level dBuV	Correct Factor dB	Measure- ment dBuV/m	Limit dBuV/m	Margin dB	Detector	Comment
1	*	5687.810	75.15	38.40	113.55	68.30	45.25	peak	No limit
2	X	5687.810	65.03	38.40	103.43	68.30	35.13	AVG	No limit
3		5725.000	23.30	38.50	61.80	68.30	-6.50	peak	

REMARKS:

- (1) Measurement Value = Reading Level + Correct Factor.
- (2) Margin Level = Measurement Value - Limit Value.

Orthogonal Axis	X		
Test Mode	UNII-2C_TX AX (HE40) Mode 5670 MHz	RU configuration	106/56

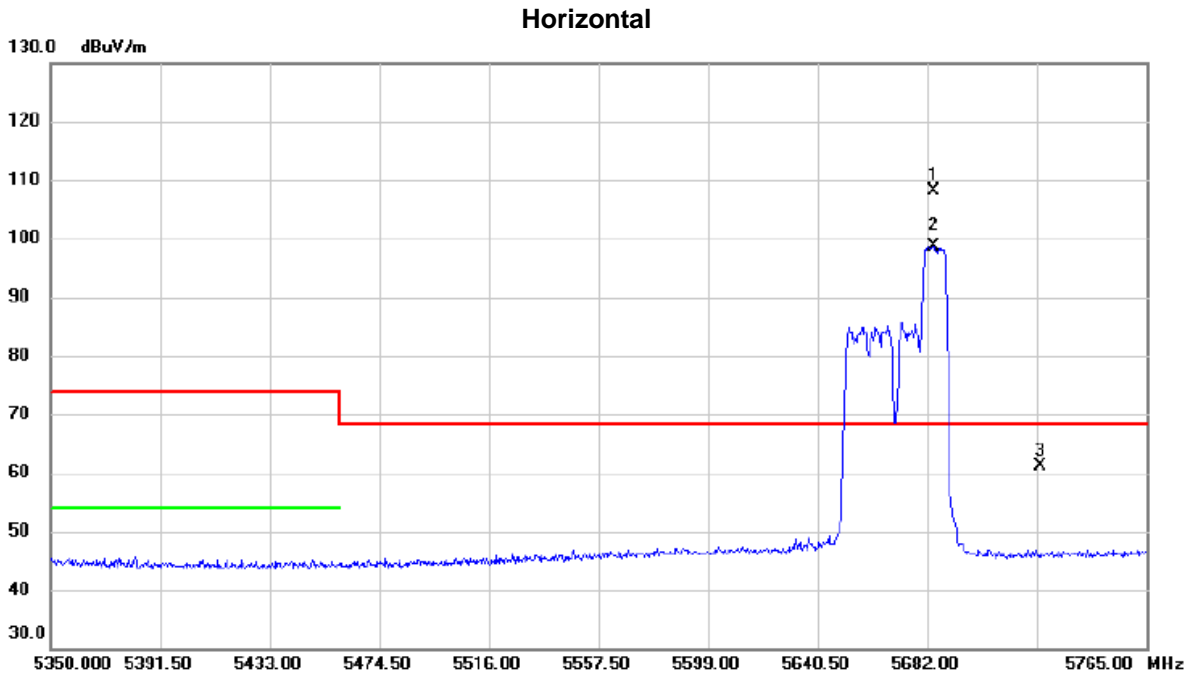

No.	Mk.	Freq. MHz	Reading Level dBuV	Correct Factor dB	Measure- ment dBuV/m	Limit dBuV/m	Margin dB	Detector	Comment
1	*	5684.698	69.86	38.39	108.25	68.30	39.95	peak	No limit
2	X	5684.698	60.32	38.39	98.71	68.30	30.41	AVG	No limit
3		5725.000	22.68	38.50	61.18	68.30	-7.12	peak	

REMARKS:

- (1) Measurement Value = Reading Level + Correct Factor.
- (2) Margin Level = Measurement Value - Limit Value.

Orthogonal Axis	X		
Test Mode	UNII-2C_TX AX (HE40) Mode 5670 MHz	RU configuration	242/62

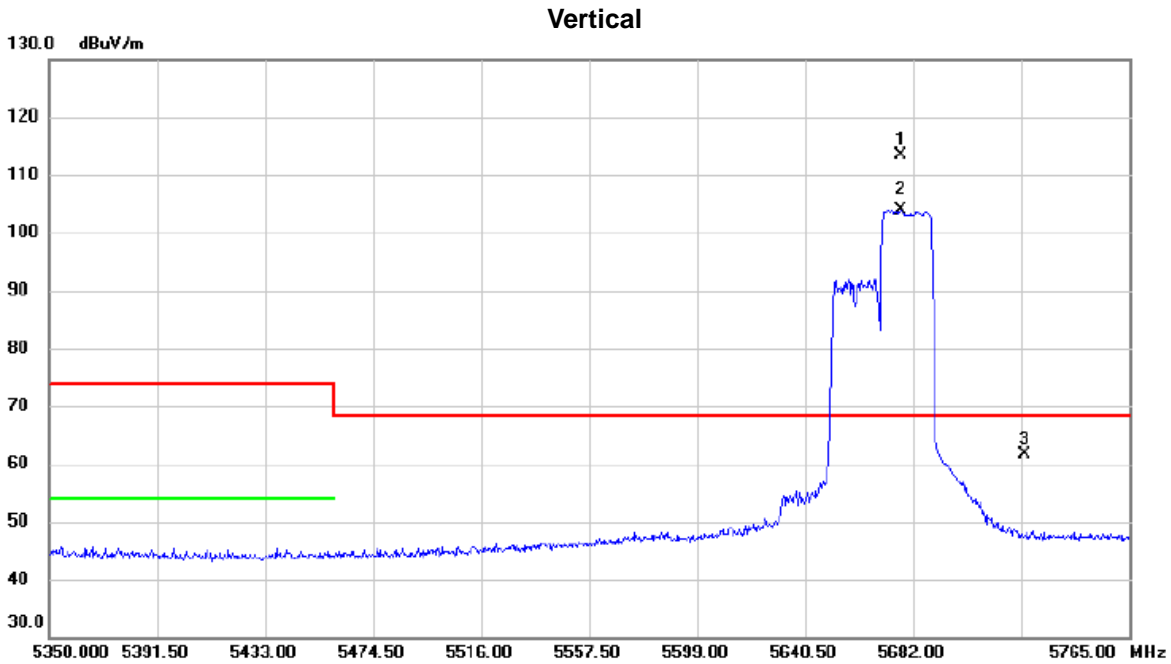

No.	Mk.	Freq. MHz	Reading Level dBuV	Correct Factor dB	Measure- ment dBuV/m	Limit dBuV/m	Margin dB	Detector	Comment
1	*	5677.227	74.93	38.39	113.32	68.30	45.02	peak	No limit
2	X	5677.227	65.57	38.39	103.96	68.30	35.66	AVG	No limit
3		5725.000	23.13	38.50	61.63	68.30	-6.67	peak	

REMARKS:

- (1) Measurement Value = Reading Level + Correct Factor.
- (2) Margin Level = Measurement Value - Limit Value.

Orthogonal Axis	X		
Test Mode	UNII-2C_TX AX (HE40) Mode 5670 MHz	RU configuration	242/62

Horizontal

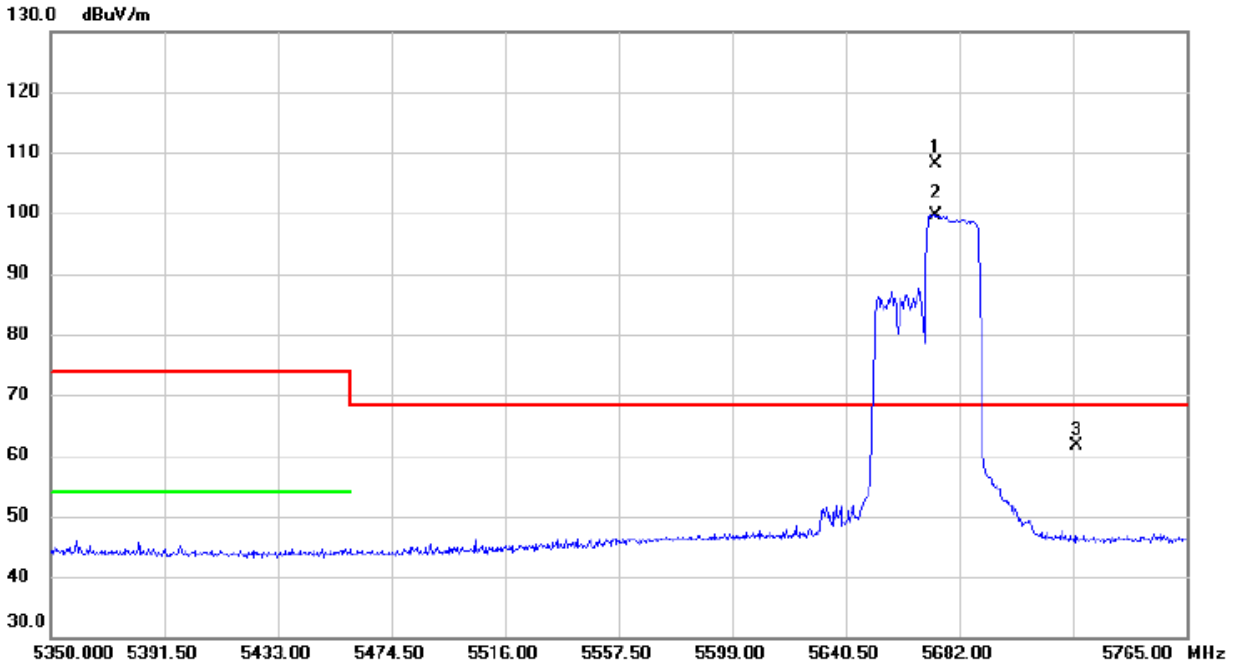

No.	Mk.	Freq. MHz	Reading Level dBuV	Correct Factor dB	Measure- ment dBuV/m	Limit dBuV/m	Margin dB	Detector	Comment
1	*	5673.700	69.83	38.39	108.22	68.30	39.92	peak	No limit
2	X	5673.700	61.19	38.39	99.58	68.30	31.28	AVG	No limit
3		5725.000	23.09	38.50	61.59	68.30	-6.71	peak	

REMARKS:

- (1) Measurement Value = Reading Level + Correct Factor.
- (2) Margin Level = Measurement Value - Limit Value.

Orthogonal Axis	X		
Test Mode	UNII-2C_TX AX (HE40) Mode 5670 MHz	RU configuration	484/65

Vertical

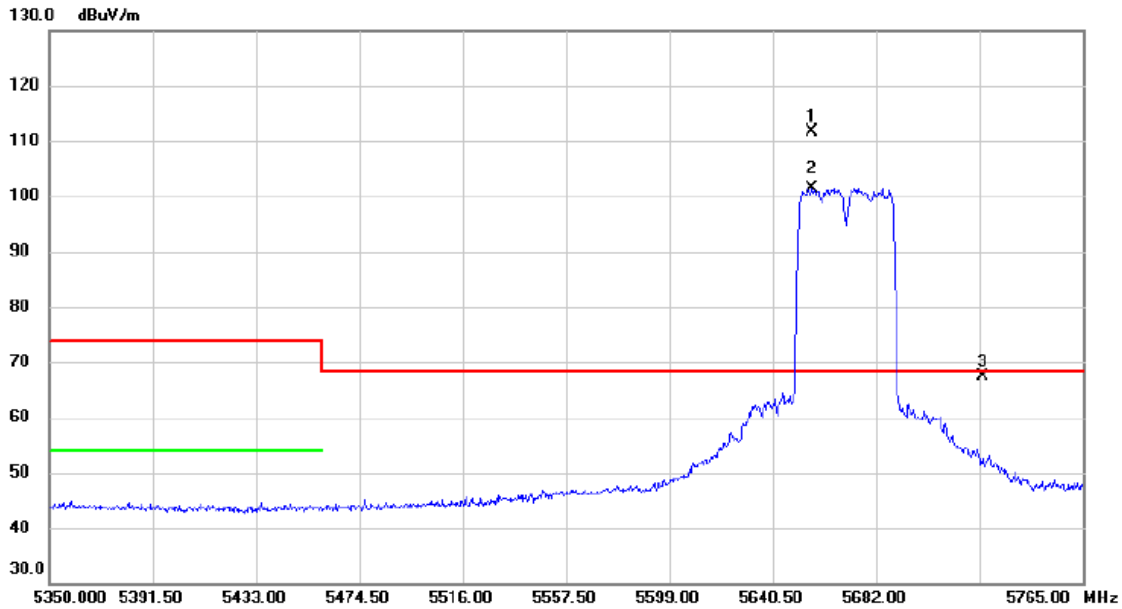

No.	Mk.	Freq. MHz	Reading Level dBuV	Correct Factor dB	Measure- ment dBuV/m	Limit dBuV/m	Margin dB	Detector	Comment
1	*	5656.270	73.29	38.37	111.66	68.30	43.36	peak	No limit
2	X	5656.270	62.99	38.37	101.36	68.30	33.06	AVG	No limit
3		5725.000	28.79	38.50	67.29	68.30	-1.01	peak	

REMARKS:

- (1) Measurement Value = Reading Level + Correct Factor.
- (2) Margin Level = Measurement Value - Limit Value.

Orthogonal Axis	X		
Test Mode	UNII-2C_TX AX (HE40) Mode 5670 MHz	RU configuration	484/65

Horizontal

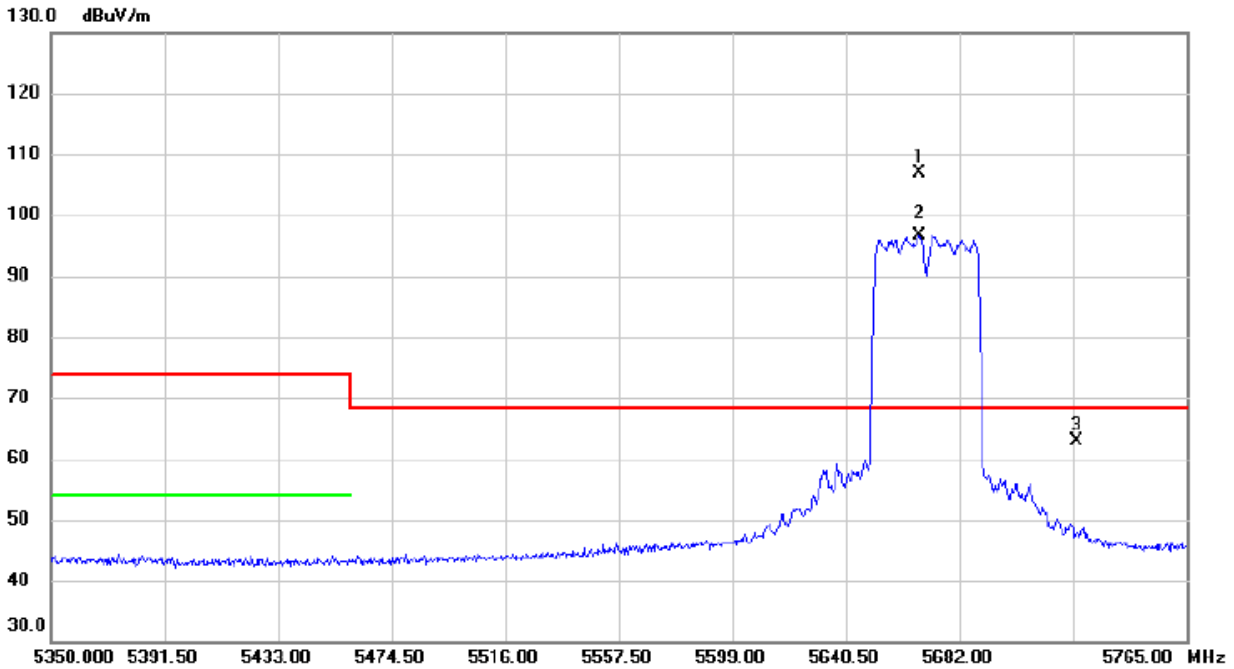

No.	Mk.	Freq. MHz	Reading Level dBuV	Correct Factor dB	Measure- ment dBuV/m	Limit dBuV/m	Margin dB	Detector	Comment
1	*	5667.475	68.53	38.39	106.92	68.30	38.62	peak	No limit
2	X	5667.475	58.36	38.39	96.75	68.30	28.45	AVG	No limit
3		5725.000	24.41	38.50	62.91	68.30	-5.39	peak	

REMARKS:

- (1) Measurement Value = Reading Level + Correct Factor.
- (2) Margin Level = Measurement Value - Limit Value.

Orthogonal Axis	X		
Test Mode	UNII-2C_TX AX (HE40) Mode 5670 MHz	RU configuration	242/62

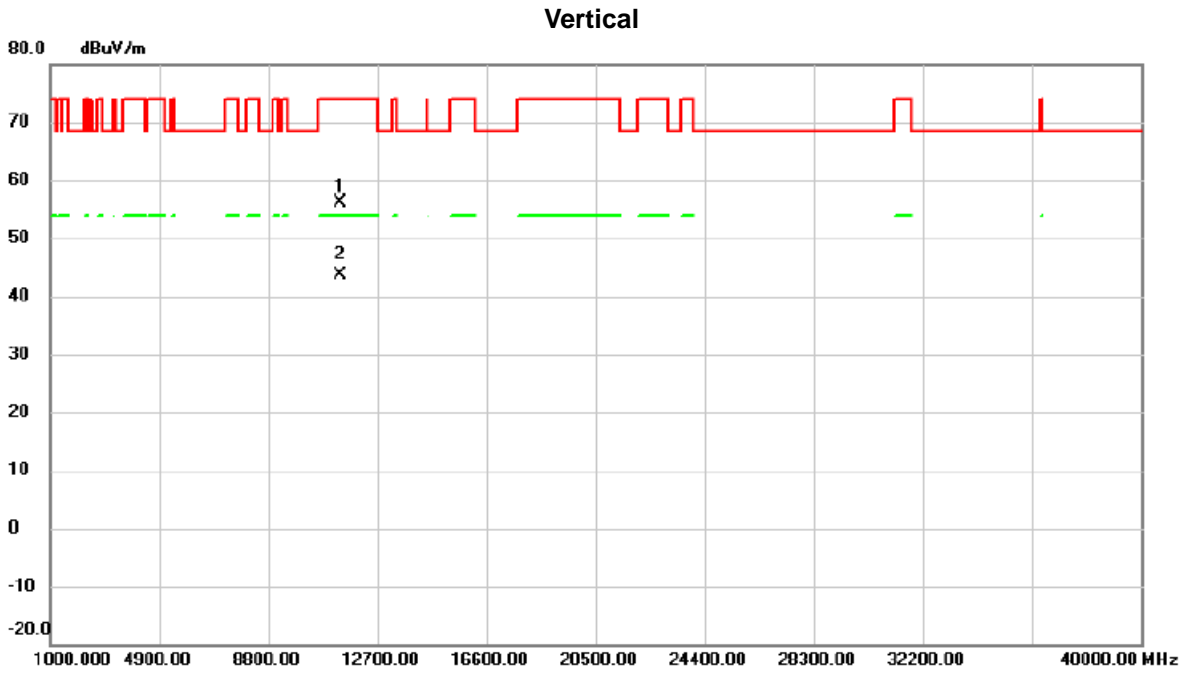

No.	Mk.	Freq. MHz	Reading Level dBuV	Correct Factor dB	Measure- ment dBuV/m	Limit dBuV/m	Margin dB	Detector	Comment
1		11369.70	53.92	2.10	56.02	74.00	-17.98	peak	
2	*	11369.80	41.43	2.10	43.53	54.00	-10.47	AVG	

REMARKS:

- (1) Measurement Value = Reading Level + Correct Factor.
- (2) Margin Level = Measurement Value - Limit Value.

Orthogonal Axis	X		
Test Mode	UNII-2C_TX AX (HE40) Mode 5670 MHz	RU configuration	242/62

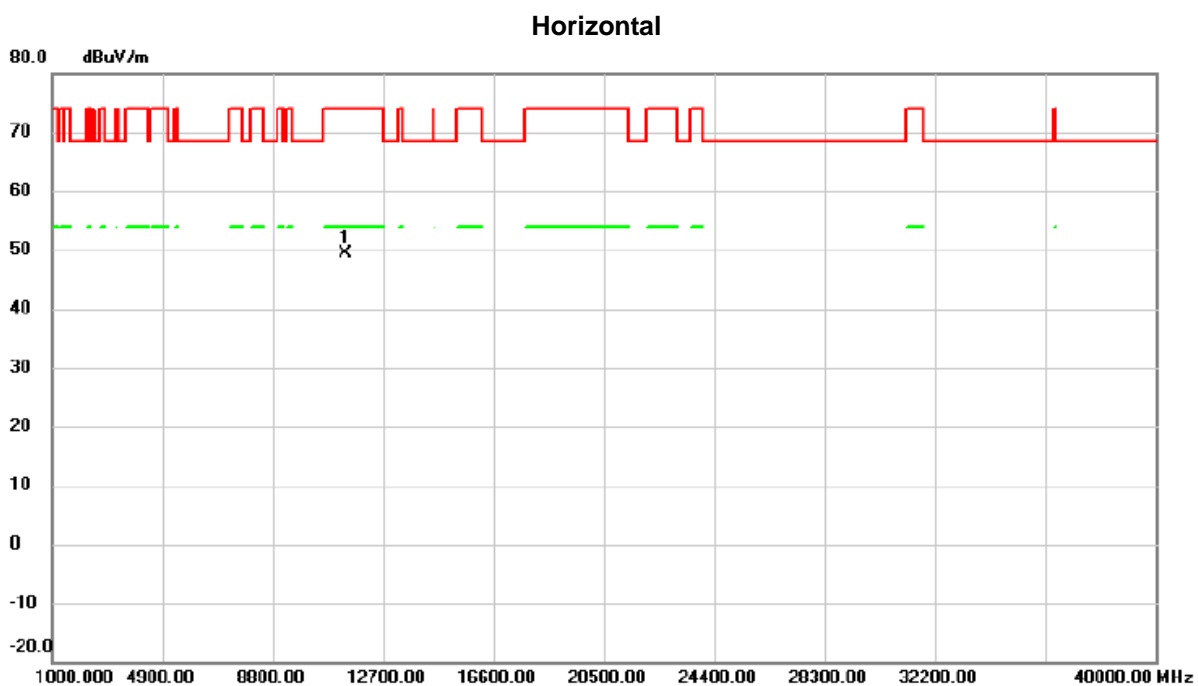

No.	Mk.	Freq. MHz	Reading Level dBuV	Correct Factor dB	Measure- ment dBuV/m	Limit dBuV/m	Margin dB	Detector	Comment
1	*	11368.37	47.25	2.10	49.35	74.00	-24.65	peak	

REMARKS:

- (1) Measurement Value = Reading Level + Correct Factor.
- (2) Margin Level = Measurement Value - Limit Value.

Orthogonal Axis	X		
Test Mode	UNII-2A_TX AX (HE80) Mode 5290 MHz	RU configuration	106/53

Vertical

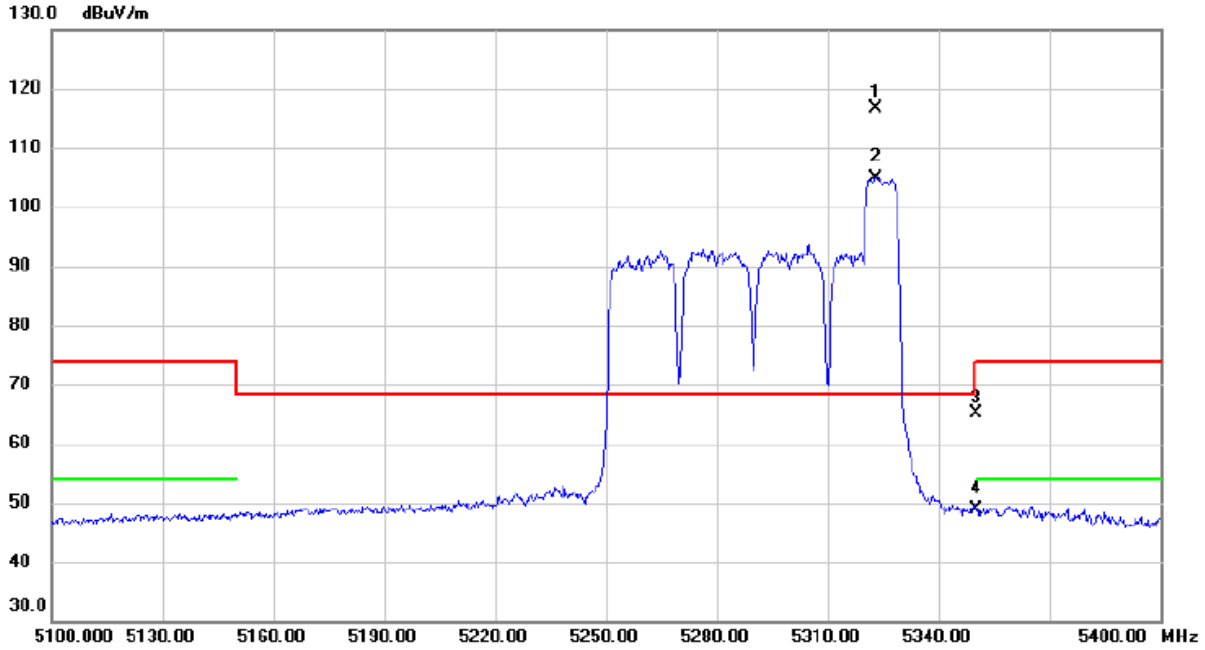

No.	Mk.	Freq.	Reading Level	Correct Factor	Measurement	Limit	Margin	Detector	Comment
		MHz	dBuV	dB	dBuV/m	dBuV/m	dB		
1	*	5323.050	78.93	37.63	116.56	68.30	48.26	peak	No limit
2	X	5323.050	67.37	37.63	105.00	68.30	36.70	AVG	No limit
3		5350.000	27.49	37.73	65.22	74.00	-8.78	peak	
4		5350.000	11.23	37.73	48.96	54.00	-5.04	AVG	

REMARKS:

- (1) Measurement Value = Reading Level + Correct Factor.
- (2) Margin Level = Measurement Value - Limit Value.

Orthogonal Axis	X		
Test Mode	UNII-2A_TX AX (HE80) Mode 5290 MHz	RU configuration	106/44

Horizontal

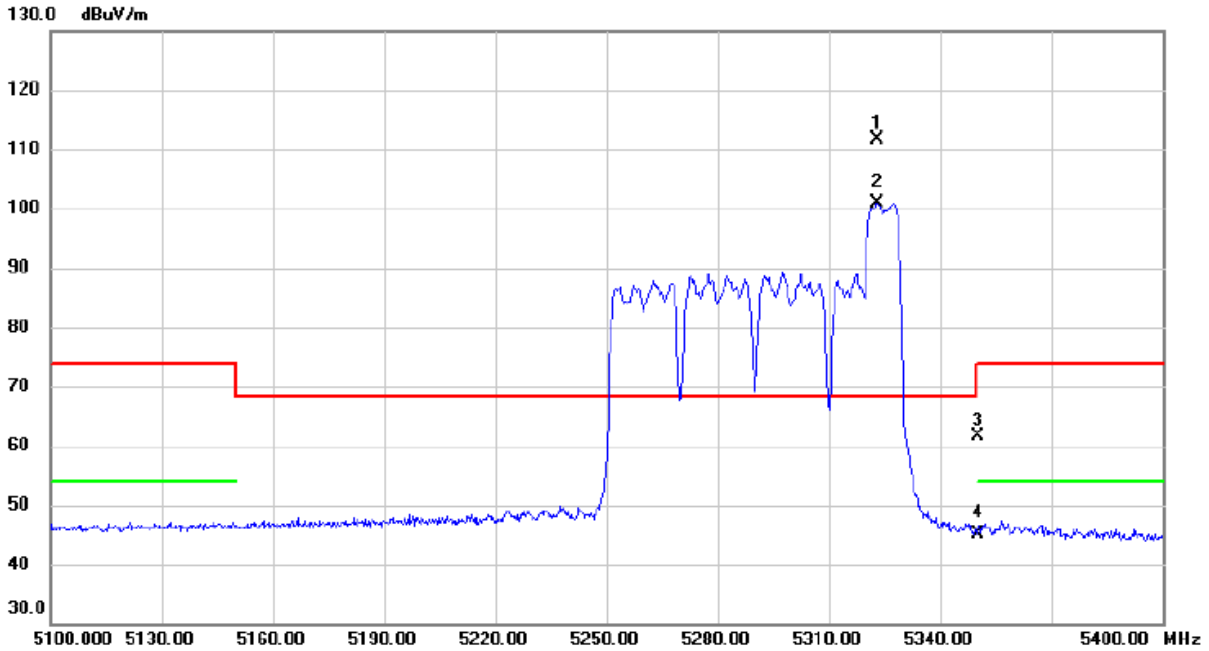

No.	Mk.	Freq. MHz	Reading Level dBuV	Correct Factor dB	Measure- ment dBuV/m	Limit dBuV/m	Margin dB	Detector	Comment
1	*	5323.050	73.94	37.63	111.57	68.30	43.27	peak	No limit
2	X	5323.050	63.34	37.63	100.97	68.30	32.67	AVG	No limit
3		5350.000	23.97	37.73	61.70	74.00	-12.30	peak	
4		5350.000	7.41	37.73	45.14	54.00	-8.86	AVG	

REMARKS:

- (1) Measurement Value = Reading Level + Correct Factor.
- (2) Margin Level = Measurement Value - Limit Value.

Orthogonal Axis	X		
Test Mode	UNII-2A_TX AX (HE80) Mode 5290 MHz	RU configuration	242/64

Vertical

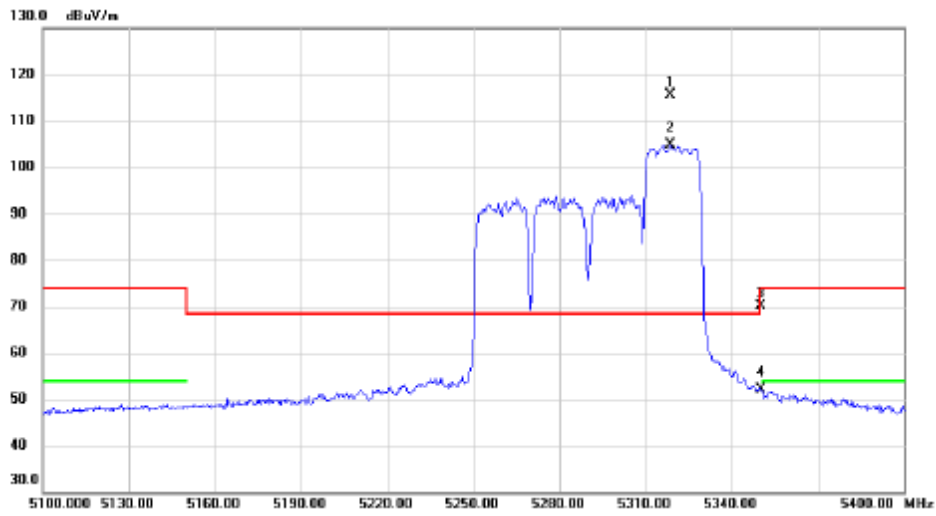

No.	Mk.	Freq. MHz	Reading Level dBuV	Correct Factor dB	Measure- ment dBuV/m	Limit dBuV/m	Margin dB	Detector	Comment
1	*	5318.700	77.91	37.61	115.52	68.30	47.22	peak	No limit
2	X	5318.700	67.34	37.61	104.95	68.30	36.65	AVG	No limit
3		5350.000	32.51	37.73	70.24	74.00	-3.76	peak	
4		5350.000	14.46	37.73	52.19	54.00	-1.81	AVG	

REMARKS:

- (1) Measurement Value = Reading Level + Correct Factor.
- (2) Margin Level = Measurement Value - Limit Value.

Orthogonal Axis	X		
Test Mode	UNII-2A_TX AX (HE80) Mode 5290 MHz	RU configuration	242/64

Horizontal

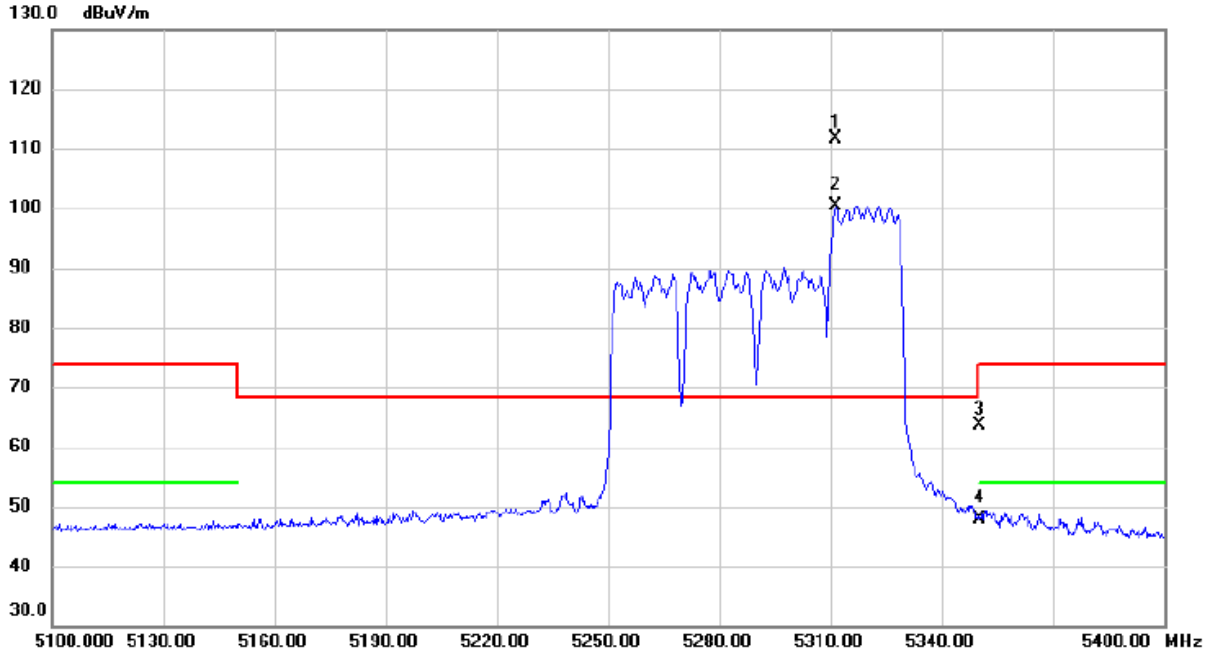

No.	Mk.	Freq.	Reading Level	Correct Factor	Measurement	Limit	Margin	Detector	Comment
		MHz	dBuV	dB	dBuV/m	dBuV/m	dB		
1	*	5311.500	74.04	37.59	111.63	68.30	43.33	peak	No limit
2	X	5311.500	62.89	37.59	100.48	68.30	32.18	AVG	No limit
3		5350.000	25.80	37.73	63.53	74.00	-10.47	peak	
4		5350.000	10.12	37.73	47.85	54.00	-6.15	AVG	

REMARKS:

- (1) Measurement Value = Reading Level + Correct Factor.
- (2) Margin Level = Measurement Value - Limit Value.

Orthogonal Axis	X		
Test Mode	UNII-2A_TX AX (HE80) Mode 5290 MHz	RU configuration	484/66

Vertical

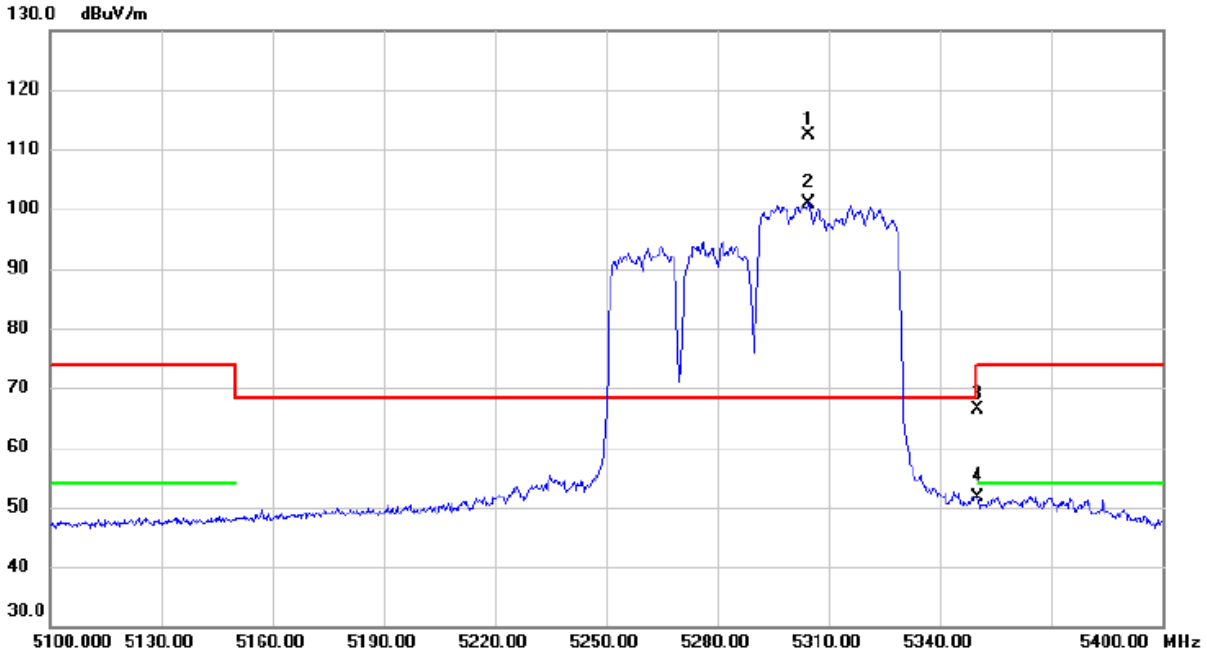

No.	Mk.	Freq. MHz	Reading Level dBuV	Correct Factor dB	Measure- ment dBuV/m	Limit dBuV/m	Margin dB	Detector	Comment
1	*	5304.750	74.86	37.55	112.41	68.30	44.11	peak	No limit
2	X	5304.750	63.45	37.55	101.00	68.30	32.70	AVG	No limit
3		5350.000	28.76	37.73	66.49	74.00	-7.51	peak	
4		5350.000	13.98	37.73	51.71	54.00	-2.29	AVG	

REMARKS:

- (1) Measurement Value = Reading Level + Correct Factor.
- (2) Margin Level = Measurement Value - Limit Value.

Orthogonal Axis	X		
Test Mode	UNII-2A_TX AX (HE80) Mode 5290 MHz	RU configuration	484/66

Horizontal

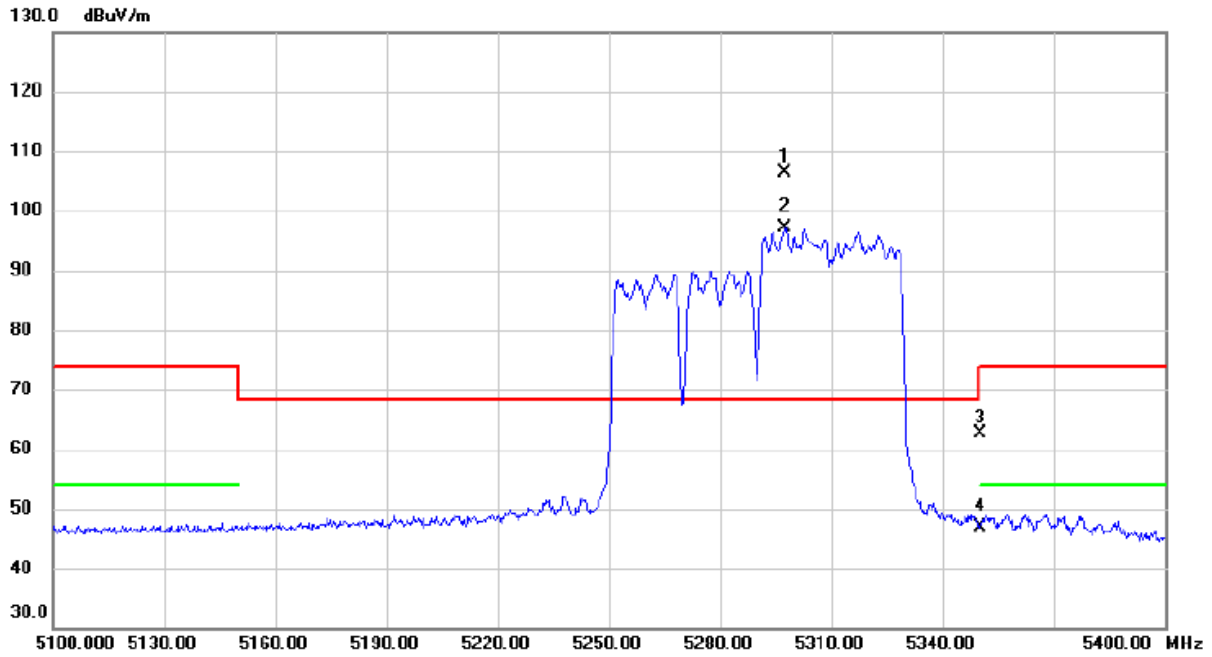

No.	Mk.	Freq. MHz	Reading Level dBuV	Correct Factor dB	Measure- ment dBuV/m	Limit dBuV/m	Margin dB	Detector	Comment
1	*	5297.400	68.91	37.54	106.45	68.30	38.15	peak	No limit
2	X	5297.400	59.64	37.54	97.18	68.30	28.88	AVG	No limit
3		5350.000	24.92	37.73	62.65	74.00	-11.35	peak	
4		5350.000	9.17	37.73	46.90	54.00	-7.10	AVG	

REMARKS:

- (1) Measurement Value = Reading Level + Correct Factor.
- (2) Margin Level = Measurement Value - Limit Value.

Orthogonal Axis	X		
Test Mode	UNII-2A_TX AX (HE80) Mode 5290 MHz	RU configuration	996/67

Vertical

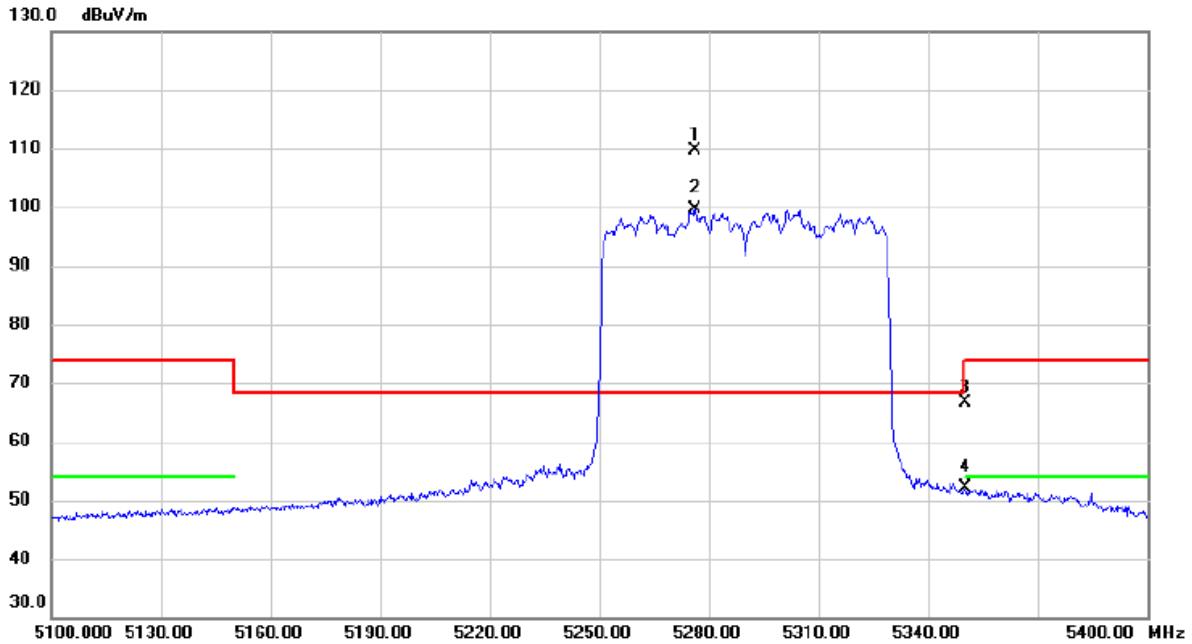

No.	Mk.	Freq. MHz	Reading Level dBuV	Correct Factor dB	Measure- ment dBuV/m	Limit dBuV/m	Margin dB	Detector	Comment
1	*	5276.250	72.09	37.57	109.66	68.30	41.36	peak	No limit
2	X	5276.250	62.11	37.57	99.68	68.30	31.38	AVG	No limit
3		5350.000	28.81	37.73	66.54	74.00	-7.46	peak	
4		5350.000	14.31	37.73	52.04	54.00	-1.96	AVG	

REMARKS:

- (1) Measurement Value = Reading Level + Correct Factor.
- (2) Margin Level = Measurement Value - Limit Value.