

FCC Radio Test Report

FCC ID: KA2IRLX1870A1

This report concerns: Original Grant

Project No. : 2005H044
Equipment : 1) AX1800 Whole Home Mesh Wi-Fi 6 Router
2) AX1800 Whole Home Mesh Wi-Fi 6 System
Brand Name : D-Link
Test Model : COVR-X1870
Series Model : COVR-X1872, COVR-X1873, DIR-LX1870, DIR-LX1872, DIR-LX1873
Applicant : D-Link Corporation
Address : 17595 Mt. Herrmann, Fountain Valley, California United State 92708
Manufacturer : D-Link Corporation
Address : 17595 Mt. Herrmann, Fountain Valley, California United State 92708
Date of Receipt : May 25, 2020
Date of Test : May 25, 2020~Jul. 02, 2020
Issued Date : Aug. 19, 2020
Report Version : R01
Test Sample : Engineering Sample No.: SH2020052550 for EUT; SH2020052550-1/
SH20200609295-2 for adapter.
Standard(s) : FCC Part15, Subpart E(15.407)
ANSI C63.10-2013
FCC KDB 789033 D02 General UNII Test Procedures New Rules
v02r01
FCC KDB 662911 D01 Multiple Transmitter Output v02r01

The above equipment has been tested and found compliance with the requirement of the relative standards by BTL Inc.

Krain. Wu

Prepared by : Krain Wu

Ryan. Wang

Approved by : Ryan Wang



Certificate # 5123. 03

Add: No. 29, Jintang Road, Tangzhen Industry Park, Pudong New Area, Shanghai 201210, China

TEL: +86-021-61765666

Web: www.newbtl.com

Declaration

BTL represents to the client that testing is done in accordance with standard procedures as applicable and that test instruments used has been calibrated with standards traceable to international standard(s) and/or national standard(s).

BTL's reports apply only to the specific samples tested under conditions. It is manufacture's responsibility to ensure that additional production units of this model are manufactured with the identical electrical and mechanical components. **BTL** shall have no liability for any declarations, inferences or generalizations drawn by the client or others from **BTL** issued reports.

The report must not be used by the client to claim product certification, approval, or endorsement by NVLAP, NIST, A2LA, or any agency of the U.S. Government.

This report is the confidential property of the client. As a mutual protection to the clients, the public and ourselves, the test report shall not be reproduced, except in full, without our written approval.

BTL's laboratory quality assurance procedures are in compliance with the **ISO/IEC 17025** requirements, and accredited by the conformity assessment authorities listed in this test report.

BTL is not responsible for the sampling stage, so the results only apply to the sample as received.

The information, data and test plan are provided by manufacturer which may affect the validity of results, so it is manufacturer's responsibility to ensure that the apparatus meets the essential requirements of applied standards and in all the possible configurations as representative of its intended use.

Limitation

For the use of the authority's logo is limited unless the Test Standard(s)/Scope(s)/Item(s) mentioned in this test report is (are) included in the conformity assessment authorities acceptance respective.

Table of Contents	Page
REPORT ISSUED HISTORY	5
1 . SUMMARY OF TEST RESULTS	6
1.1 TEST FACILITY	7
1.2 MEASUREMENT UNCERTAINTY	7
1.3 TEST ENVIRONMENT CONDITIONS	7
2 . GENERAL INFORMATION	8
2.1 GENERAL DESCRIPTION OF EUT	8
2.2 TEST MODES	11
2.3 PARAMETERS OF TEST SOFTWARE	12
2.4 DUTY CYCLE	18
2.5 BLOCK DIAGRAM SHOWING THE CONFIGURATION OF SYSTEM TESTED	19
2.6 SUPPORT UNITS	19
3 . AC POWER LINE CONDUCTED EMISSIONS TEST	20
3.1 LIMIT	20
3.2 TEST PROCEDURE	20
3.3 DEVIATION FROM TEST STANDARD	20
3.4 TEST SETUP	21
3.5 EUT OPERATION CONDITIONS	21
3.6 TEST RESULTS	21
4 . RADIATED EMISSIONS TEST	22
4.1 LIMIT	22
4.2 TEST PROCEDURE	23
4.3 DEVIATION FROM TEST STANDARD	23
4.4 TEST SETUP	24
4.5 EUT OPERATION CONDITIONS	26
4.6 TEST RESULTS - 30 MHz TO 1000 MHz	26
4.7 TEST RESULTS - ABOVE 1000 MHz	26
5 . BANDWIDTH TEST	27
5.1 LIMIT	27
5.2 TEST PROCEDURE	27
5.3 TEST PROCEDURE	27
5.4 TEST SETUP	28
5.5 EUT OPERATION CONDITIONS	28

Table of Contents	Page
5.6 TEST RESULTS	28
6 . MAXIMUM OUTPUT POWER TEST	29
6.1 LIMIT	29
6.2 TEST PROCEDURE	29
6.3 DEVIATION FROM STANDARD	29
6.4 TEST SETUP	29
6.5 EUT OPERATION CONDITIONS	29
6.6 TEST RESULTS	29
7 . POWER SPECTRAL DENSITY TEST	30
7.1 LIMIT	30
7.2 TEST PROCEDURE	30
7.3 DEVIATION FROM STANDARD	30
7.4 TEST SETUP	31
7.5 EUT OPERATION CONDITIONS	31
7.6 TEST RESULTS	31
8 . MEASUREMENT INSTRUMENTS LIST	32
9 . EUT TEST PHOTOS	34
APPENDIX A - AC POWER LINE CONDUCTED EMISSIONS	37
APPENDIX B - RADIATED EMISSION - 30 MHZ TO 1 GHZ	40
APPENDIX C - RADIATED EMISSION - ABOVE 1000 MHZ	43
APPENDIX D - BANDWIDTH	152
APPENDIX E - CONDUCTED OUTPUT POWER	170
APPENDIX F - POWER SPECTRAL DENSITY	199

REPORT ISSUED HISTORY

Report Version	Description	Issued Date
R00	Original Issue.	Jul. 20, 2020
R01	Correct the type error in page 8.	Aug. 19, 2020

1. SUMMARY OF TEST RESULTS

Test procedures according to the technical standard(s):

FCC Part15, Subpart E(15.407)				
Standard(s) Section	Test Item	Test Result	Judgement	Remark
15.207 15.407(b)	AC Power Line Conducted Emissions	APPENDIX A	PASS	-----
15.407(b) 15.205(a) 15.209(a)	Radiated Emissions	APPENDIX B APPENDIX C APPENDIX D	PASS	-----
15.407(a) 15.407(e)	Spectrum Bandwidth	APPENDIX E	PASS	-----
15.407(a)	Maximum Output Power	APPENDIX F	PASS	-----
15.407(a)	Power Spectral Density	APPENDIX G	PASS	-----
15.407(g)	Frequency Stability	APPENDIX H	PASS	-----
15.203	Antenna Requirements	-----	PASS	-----
15.407(c)	Automatically Discontinue Transmission	-----	PASS	NOTE (2)

Note:

- (1) "N/A" denotes test is not applicable in this test report.
- (2) During no any information transmission, the EUT can automatically discontinue transmission and become standby mode for power saving. the EUT can detect the controlling signal of ACK message transmitting from remote device and verify whether it shall resend or discontinue transmission.
- (3) For UNII-1 this device was functioned as a
 Access point device Client device

1.1 TEST FACILITY

The test facilities used to collect the test data in this report is at the location of No. 29, Jintang Road, Tangzhen Industry Park, Pudong New Area, Shanghai 201210, China
 BTL's Test Firm Registration Number for FCC: 476765
 BTL's Designation Number for FCC: CN1241

1.2 MEASUREMENT UNCERTAINTY

ISO/IEC 17025 requires that an estimate of the measurement uncertainties associated with the emissions test results be included in the report. The measurement uncertainties given below are based on a 95% confidence level (based on a coverage factor (k=2))
 The BTL measurement uncertainty as below table:

A. AC power line conducted emissions test:

Test Site	Method	Measurement Frequency Range	U, (dB)
SH-C01	CISPR	150 kHz ~ 30 MHz	± 2.26

B. Radiated emissions test:

Test Site	Method	Measurement Frequency Range	Ant. H / V	U, (dB)
SH-CB01	CISPR	9 KHz~30 MHz	V	3.79
		9 KHz~30 MHz	H	3.57
		30 MHz~200 MHz	V	4.04
		30 MHz~200 MHz	H	3.76
		200 MHz~1,000 MHz	V	4.24
		200 MHz~1,000 MHz	H	3.84
		1 GHz~18 GHz	V	4.46
		1 GHz~18 GHz	H	4.40
		18 GHz~40 GHz	V	3.95
		18 GHz~40 GHz	H	3.95

Note: Unless specifically mentioned, the uncertainty of measurement has not been taken into account to declare the compliance or non-compliance to the specification.

1.3 TEST ENVIRONMENT CONDITIONS

Test Item	Temperature	Humidity	Test Voltage	Tested By
AC Power Line Conducted Emissions	23°C	56%	AC 120V/60Hz	Forest Li
Radiated Emissions-30 MHz to 1GHz	24°C	58%	AC 120V/60Hz	Forest Li
Radiated Emissions-Above 1000 MHz	24°C	56%	AC 120V/60Hz	Forest Li
Spectrum Bandwidth	24°C	58%	AC 120V/60Hz	Forest Li
Maximum Output Power	24°C	56%	AC 120V/60Hz	Forest Li
Power Spectral Density	24°C	58%	AC 120V/60Hz	Forest Li

2. GENERAL INFORMATION

2.1 GENERAL DESCRIPTION OF EUT

Equipment	1) AX1800 Whole Home Mesh Wi-Fi 6 Router 2) AX1800 Whole Home Mesh Wi-Fi 6 System
Brand Name	D-Link
Test Model	COVR-X1870
Series Model	COVR-X1872, COVR-X1873, DIR-LX1870, DIR-LX1872, DIR-LX1873
Model Difference(s)	COVR-X1870 /DIR-LX1870: Single Pack; COVR-X1872/DIR-LX1872: double Pack; DIR-LX1873 /COVR-X1873: treble Pack All versions of the Models are electrically equal except for the model name and number of packages.
Software Version	1
Hardware Version	A1
Power Source	DC voltage supplied from AC/DC adapter. 1# Brand/Model: Gongjin/S12A12-120A100-CJ 2# Brand/Model: Gongjin/WB-12G12R
Power Rating	1# I/P: 100-240V~50/60Hz max 0.5A O/P:12V $\overline{\text{---}}$ 1A 2# I/P: 100-240V~50-60Hz 0.3A Max. O/P:12.0V $\overline{\text{---}}$ 1.0A 12.0W
Operation Frequency	UNII-1: 5150 MHz~5250 MHz UNII-2A: 5250 MHz~5350 MHz UNII-2C: 5470 MHz~5725 MHz UNII-3: 5725 MHz~5850 MHz
Modulation Type	OFDM,OFDMA
Bit Rate of Transmitter	Up to 1201Mbps
Maximum Conducted Output Power for UNII-1 (2TX) Non-Beamforming	IEEE 802.11ax (HE20): 28.10 dBm (0.6457 W) IEEE 802.11ax (HE40): 28.99 dBm (0.7925 W) IEEE 802.11ax (HE80): 28.89 dBm (0.7745 W)
Maximum Conducted Output Power for UNII-3 (2TX) Non-Beamforming	IEEE 802.11ax (HE20): 25.05 dBm (0.3199 W) IEEE 802.11ax (HE40): 25.46 dBm (0.3516 W) IEEE 802.11ax (HE80): 29.86 dBm (0.9683 W)
Maximum Conducted Output Power for UNII-1 (2TX) Beamforming	IEEE 802.11ax (HE20): 27.75 dBm (0.5957 W) IEEE 802.11ax (HE40): 28.72 dBm (0.7447 W) IEEE 802.11ax (HE80): 28.55dBm (0.7161 W)
Maximum Conducted Output Power for UNII-3 (2TX) Beamforming	IEEE 802.11ax (HE20): 24.70dBm (0.2951 W) IEEE 802.11ax (HE40): 25.02 dBm (0.3199 W) IEEE 802.11ax (HE80): 29.60dBm (0.9120 W)

Note:

- For a more detailed features description, please refer to the manufacturer's specifications or the user's manual.

2. Channel List:

IEEE 802.11ax (HE20)		IEEE 802.11ax (HE40)		IEEE 802.11ax (HE80)	
UNII-1		UNII-1		UNII-1	
Channel	Frequency (MHz)	Channel	Frequency (MHz)	Channel	Frequency (MHz)
36	5180	38	5190	42	5210
40	5200	46	5230		
44	5220				
48	5240				
IEEE 802.11ax (HE20)		IEEE 802.11ax (HE40)		IEEE 802.11ax (HE80)	
UNII-3		UNII-3		UNII-3	
Channel	Frequency (MHz)	Channel	Frequency (MHz)	Channel	Frequency (MHz)
149	5745	151	5755	155	5775
153	5765	159	5795		
157	5785				
161	5805				
165	5825				

3. RU configuration

Operating Mode	Resource Unit	52 Tone(4M)
IEEE 802.11ax (HE20)	Specific Resource Unit	37
		38
		39
		40
	Resource Unit	106 Tone(8M)
	Specific Resource Unit	53
		54
	Resource Unit	242 Tone(20M)
Specific Resource Unit	61	
Operating Mode	Resource Unit	52 Tone(4M)
IEEE 802.11ax (HE40)	Specific Resource Unit	37
		40
		44
	Resource Unit	106 Tone(8M)
	Specific Resource Unit	53
		54
		56
	Resource Unit	242 Tone(20M)
	Specific Resource Unit	61
		62
Resource Unit	484 Tone(40M)	
Specific Resource Unit	65	
Operating Mode	Resource Unit	106 Tone(8M)
IEEE 802.11ax (HE80)	Specific Resource Unit	53
		56
		60
	Resource Unit	242 Tone(20M)
	Specific Resource Unit	61
		63
		64
	Resource Unit	484 Tone(40M)
	Specific Resource Unit	65
		66
Resource Unit	996 Tone(80M)	
Specific Resource Unit	67	

4. Antenna Specification:

Ant.	Brand	Model Name	Antenna Type	Connector	Gain (dBi)	Note
1	N/A	N/A	Dipole	IPEX	3	N/A
2	N/A	N/A	Dipole	IPEX	3	N/A

Note:

- (1) Antenna Gain=3 dBi. This EUT supports MIMO 2X2, any transmit signals are correlated with each other, so Directional gain = $G_{Ant.} + 10\log(N)$ dBi, that is Directional gain= $3+10\log(2)$ dBi=6.01; So,the UNII-1,UNII-3 output power limit is $30-6.01+6=29.99$, The UNII-1 power spectral density limit is $17-6.01+6=16.99$, the UNII-3 power spectral density limit is $30-6.01+6=29.99$.
- (2)Beamforming gain:3dB.

5. Table for Antenna Configuration:

Operating Mode	Ant. 1	Ant. 2	Ant. 1 + Ant. 2
	TX Mode		
IEEE 802.11ax (HE20)	✓	✓	✓
IEEE 802.11ax (HE40)	✓	✓	✓
IEEE 802.11ax (HE80)	✓	✓	✓

2.2 TEST MODES

The test system was pre-tested based on the consideration of all possible combinations of EUT operation mode.

Pretest Mode	Description
Mode 1	TX AX (HE20) Mode / CH36, CH40, CH48 (UNII-1)
Mode 2	TX AX (HE40) Mode / CH38, CH46 (UNII-1)
Mode 3	TX AX (HE80) Mode / CH42 (UNII-1)
Mode 4	TX AX (HE20) Mode / CH149,CH157,CH165 (UNII-3)
Mode 5	TX AX (HE40) Mode / CH151,CH159 (UNII-3)
Mode 6	TX Mode

Following mode(s) as (were) found to be the worst case(s) and selected for the final test.

AC power line conducted emissions test	
Final Test Mode	Description
Mode 6	TX Mode

Radiated emissions test	
Final Test Mode	Description
Mode 1	TX AX (HE20) Mode / CH36, CH40, CH48 (UNII-1)
Mode 2	TX AX (HE40) Mode / CH38, CH46 (UNII-1)
Mode 3	TX AX (HE80) Mode / CH42 (UNII-1)
Mode 4	TX AX (HE20) Mode / CH149,CH157,CH165 (UNII-3)
Mode 5	TX AX (HE40) Mode / CH151,CH159 (UNII-3)
Mode 6	TX AX (HE80) Mode / CH155 (UNII-3)

Note:

- (1) For conducted emissions and radiated emission below 1 GHz test, two power adapter has been pre-tested, but only the worst case recorded in this report.
- (2) For radiated emission above 1 GHz test, 1GHz~26.5GHz and 26.5GHz~40GHz have been pre-tested and in this report only recorded the worst case. The remaining spurious points are all below the limit value of 20dB.
- (3) The measurements for RF Output Power were tested during Non-Beamforming and Beamforming, the worst case was Non-Beamforming, only worst case was documented for other test items.
- (4) The low frequency, which started from 9 kHz to 30MHz, was pre-scanned and the result which was 20dB lower than the limit line was not reported.

2.3 PARAMETERS OF TEST SOFTWARE
Non-Beamforming

2TX				
Test Software	accessMTool			
Operating Mode	Test Frequency (MHz)	Resource Unit	Specific Resource Unit	Parameters of Test Software
IEEE 802.11ax (HE20)	5180	52 Tone	37	84
			38	84
			40	84
		106 Tone	53	88
			54	88
			61	83
	5200	52 Tone	37	85
			38	85
			40	85
		106 Tone	53	94
			54	94
			61	96
	5240	52 Tone	37	85
			38	85
			40	85
		106 Tone	53	93
			54	93
			61	102

Operating Mode	Test Frequency (MHz)	Resource Unit	Specific Resource Unit	Parameters of Test Software
IEEE 802.11ax (HE20)	5745	52 Tone	37	95
			38	95
			40	95
		106 Tone	53	94
			54	94
	242 Tone	61	98	
	5785	52 Tone	37	92
			38	92
			40	92
		106 Tone	53	91
			54	91
	242 Tone	61	98	
	5825	52 Tone	37	84
			38	84
			40	84
106 Tone		53	83	
		54	83	
242 Tone	61	99		
IEEE 802.11ax (HE40)	5190	52 Tone	37	78
			40	78
			44	78
		106 Tone	53	80
			54	80
			56	80
		242 Tone	61	80
	62		80	
	484 Tone	65	70	
	5230	52 Tone	37	85
			40	85
			44	85
		106 Tone	53	92
			54	92
			56	92
242 Tone		61	105	
	62	105		
484 Tone	65	105		

Operating Mode	Test Frequency (MHz)	Resource Unit	Specific Resource Unit	Parameters of Test Software
IEEE 802.11ax (HE40)	5755	52 Tone	37	103
			40	103
			44	103
		106 Tone	53	103
			54	103
			56	103
		242 Tone	61	99
	62		99	
	484 Tone	65	98	
	5795	52 Tone	37	99
			40	99
			44	99
		106 Tone	53	103
			54	103
56			103	
242 Tone		61	95	
	62	95		
484 Tone	65	98		
IEEE 802.11ax (HE80)	5210	106 Tone	37	79
			40	79
			44	79
		242 Tone	61	78
			63	78
			64	78
		484 Tone	65	75
	66		75	
	996 Tone	67	105	
	5775	106 Tone	53	110
			56	110
			60	110
		242 Tone	61	108
			63	108
64			108	
484 Tone		65	108	
	66	108		
996 Tone	67	108		

Beamforming

2TX				
Test Software	accessMTool			
Operating Mode	Test Frequency (MHz)	Resource Unit	Specific Resource Unit	Parameters of Test Software
IEEE 802.11ax (HE20)	5180	52 Tone	37	84
			38	84
			40	84
		106 Tone	53	88
			54	88
			61	83
	5200	52 Tone	37	85
			38	85
			40	85
		106 Tone	53	94
			54	94
			61	96
	5240	52 Tone	37	85
			38	85
			40	85
		106 Tone	53	93
			54	93
			61	102

Operating Mode	Test Frequency (MHz)	Resource Unit	Specific Resource Unit	Parameters of Test Software
IEEE 802.11ax (HE20)	5745	52 Tone	37	95
			38	95
			40	95
		106 Tone	53	94
			54	94
	242 Tone	61	98	
	5785	52 Tone	37	92
			38	92
			40	92
		106 Tone	53	91
			54	91
	242 Tone	61	98	
	5825	52 Tone	37	84
			38	84
			40	84
106 Tone		53	83	
		54	83	
242 Tone	61	99		
IEEE 802.11ax (HE40)	5190	52 Tone	37	78
			40	78
			44	78
		106 Tone	53	80
			54	80
			56	80
		242 Tone	61	80
	62		80	
	484 Tone	65	70	
	5230	52 Tone	37	85
			40	85
			44	85
		106 Tone	53	92
			54	92
			56	92
242 Tone		61	105	
		62	105	
484 Tone	65	105		

Operating Mode	Test Frequency (MHz)	Resource Unit	Specific Resource Unit	Parameters of Test Software
IEEE 802.11ax (HE40)	5755	52 Tone	37	103
			40	103
			44	103
		106 Tone	53	103
			54	103
			56	103
		242 Tone	61	99
	62		99	
	484 Tone	65	98	
	5795	52 Tone	37	99
			40	99
			44	99
		106 Tone	53	103
			54	103
56			103	
242 Tone		61	95	
	62	95		
484 Tone	65	98		
IEEE 802.11ax (HE80)	5210	106 Tone	37	79
			40	79
			44	79
		242 Tone	61	78
			63	78
			64	78
		484 Tone	65	75
	66		75	
	996 Tone	67	105	
	5775	106 Tone	53	110
			56	110
			60	110
		242 Tone	61	108
			63	108
64			108	
484 Tone		65	108	
	66	108		
996 Tone	67	108		

2.4 DUTY CYCLE

If duty cycle is $\geq 98\%$, duty factor is not required.
 If duty cycle is $< 98\%$, duty factor shall be considered.

IEEE 802.11ax (HE20)

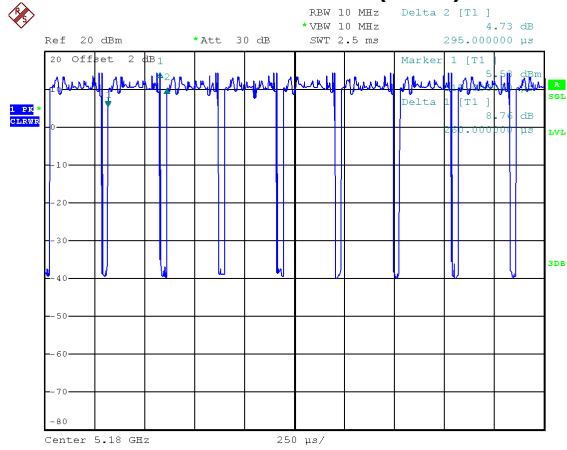

Date: 2.JUN.2020 10:34:51

Duty cycle = $0.260 \text{ ms} / 0.295 \text{ ms} = 88.14\%$
 Duty Factor = $10 * \log(1 / 88.14\%) = 0.55 \text{ dB}$

IEEE 802.11ax (HE40)

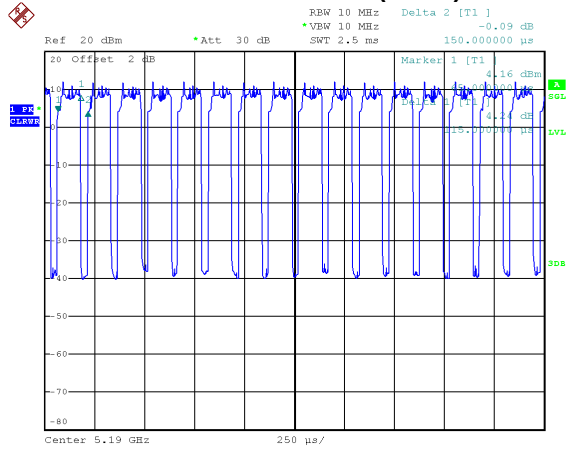

Date: 2.JUN.2020 10:37:43

Duty cycle = $0.115 \text{ ms} / 0.150 \text{ ms} = 76.67\%$
 Duty Factor = $10 * \log(1 / 76.67\%) = 1.15 \text{ dB}$

IEEE 802.11ax (HE80)

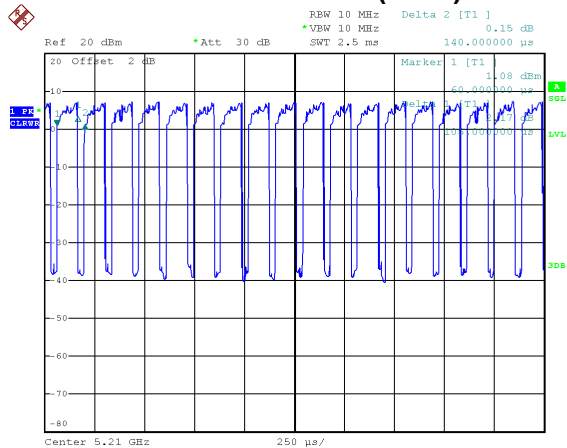

Date: 2.JUN.2020 10:39:48

Duty cycle = $0.105 \text{ ms} / 0.140 \text{ ms} = 75.00\%$
 Duty Factor = $10 * \log(1 / 75.00\%) = 1.25 \text{ dB}$

NOTE:

For IEEE 802.11ax (HE20):

For radiated emissions frequency above 1 GHz, the resolution bandwidth of test receiver/spectrum analyzer is 1 MHz and the video bandwidth is 4 kHz (Duty cycle $< 98\%$).

For IEEE 802.11ax (HE40):

For radiated emissions frequency above 1 GHz, the resolution bandwidth of test receiver/spectrum analyzer is 1 MHz and the video bandwidth is 9 kHz (Duty cycle $< 98\%$).

For IEEE 802.11ax (HE80):

For radiated emissions frequency above 1 GHz, the resolution bandwidth of test receiver/spectrum analyzer is 1 MHz and the video bandwidth is 10 kHz (Duty cycle $< 98\%$).

2.5 BLOCK DIAGRAM SHOWING THE CONFIGURATION OF SYSTEM TESTED

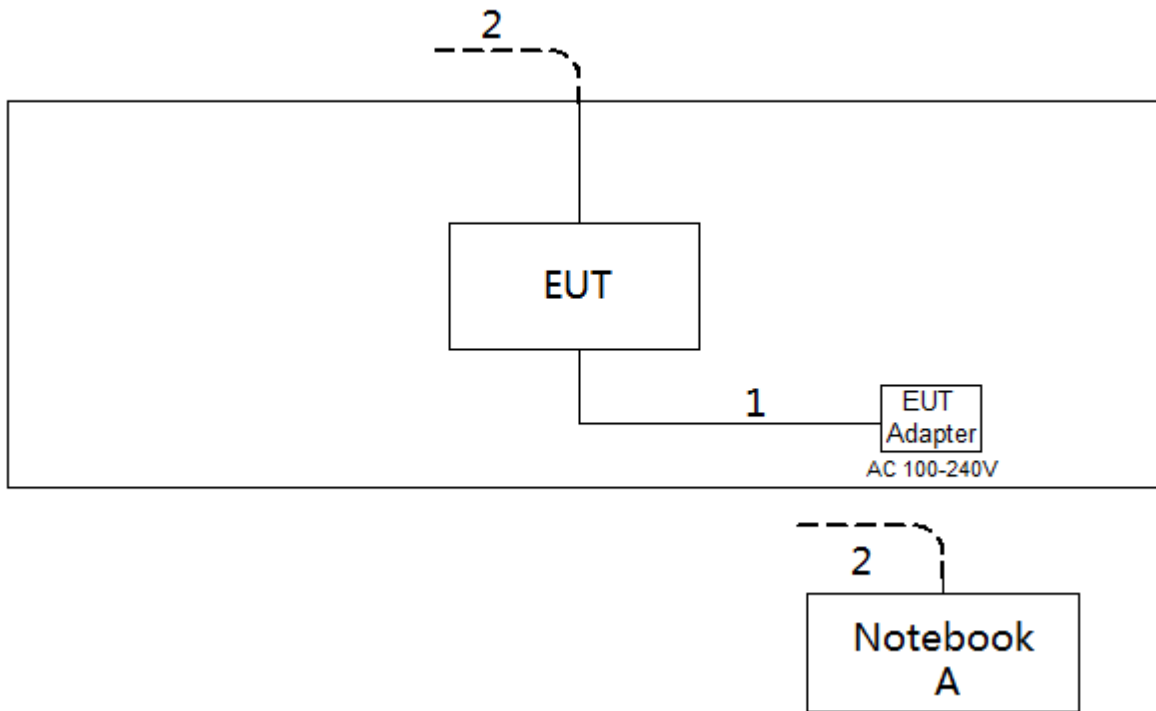

2.6 SUPPORT UNITS

Item	Equipment	Mfr/Brand	Model/Type No.	Series No.
A	Notebook	Lenovo	#P152014	N/A

Item	Cable Type	Shielded Type	Ferrite Core	Length
1	DC Cable	NO	NO	1.5m
2	RJ45 Cable	NO	NO	10m

3. AC POWER LINE CONDUCTED EMISSIONS TEST

3.1 LIMIT

Frequency (MHz)	Limit (dB μ V)	
	Quasi-peak	Average
0.15 - 0.5	66 to 56*	56 - 46*
0.50 - 5.0	56	46
5.0 - 30.0	60	50

NOTE:

- (1) The tighter limit applies at the band edges.
- (2) The limit of " * " marked band means the limitation decreases linearly with the logarithm of the frequency in the range.

The following table is the setting of the receiver

Receiver Parameter	Setting
Attenuation	10 dB
Start Frequency	0.15 MHz
Stop Frequency	30 MHz
IF Bandwidth	9 KHz

3.2 TEST PROCEDURE

- a. The EUT was placed 0.8 meters from the horizontal ground plane with EUT being connected to the power mains through a line impedance stabilization network (LISN). All other support equipment powered from additional LISN(s). The LISN provide 50 Ohm/ 50uH of coupling impedance for the measuring instrument.
- b. Interconnecting cables that hang closer than 40 cm to the ground plane shall be folded back and forth in the center forming a bundle 30 to 40 cm long.
- c. I/O cables that are not connected to a peripheral shall be bundled in the center. The end of the cable may be terminated, if required, using the correct terminating impedance. The overall length shall not exceed 1 m.
- d. LISN at least 80 cm from nearest part of EUT chassis.
- e. For the actual test configuration, please refer to the related Item -EUT Test Photos.

3.3 DEVIATION FROM TEST STANDARD

No deviation

3.4 TEST SETUP

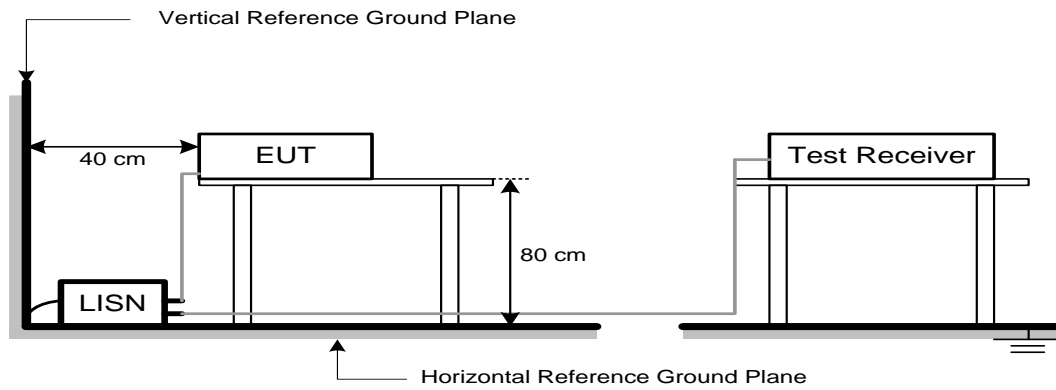

3.5 EUT OPERATION CONDITIONS

The EUT was configured for testing in a typical fashion (as a customer would normally use it). The EUT has been programmed to continuously transmit during test. This operating condition was tested and used to collect the included data.

The EUT was programmed to be in continuously transmitting/TX mode.

3.6 TEST RESULTS

Please refer to the APPENDIX A.

4. RADIATED EMISSIONS TEST

4.1 LIMIT

In case the emission fall within the restricted band specified on 15.205(a), then the 15.209(a) limit in the table below has to be followed.

LIMITS OF RADIATED EMISSIONS MEASUREMENT (9 kHz to 1000 MHz)

Frequency (MHz)	Field Strength (microvolts/meter)	Measurement Distance (meters)
0.009-0.490	2400/F(kHz)	300
0.490-1.705	24000/F(kHz)	30
1.705-30.0	30	30
30-88	100	3
88-216	150	3
216-960	200	3
Above 960	500	3

LIMITS OF UNWANTED EMISSION OUT OF THE RESTRICTED BANDS

Frequency (MHz)	EIRP Limit (dBm/MHz)	Equivalent Field Strength at 3m (dBμV/m)
5150-5250	-27	68.3
5250-5350	-27	68.3
5470-5725	-27	68.3
5725-5850	-27 NOTE (2)	68.3
	10 NOTE (2)	105.3
	15.6 NOTE (2)	110.9
	27 NOTE (2)	122.3

NOTE:

(1) The following formula is used to convert the equipment isotropic radiated power (eirp) to field strength:

$$E = \frac{1000000\sqrt{30P}}{3} \mu\text{V/m, where P is the eirp (Watts)}$$

(2) According to 15.407(b)(4)(i), all emissions shall be limited to a level of -27 dBm/MHz at 75 MHz or more above or below the band edge increasing linearly to 10 dBm/MHz at 25 MHz above or below the band edge, and from 25 MHz above or below the band edge increasing linearly to a level of 15.6 dBm/MHz at 5 MHz above or below the band edge, and from 5 MHz above or below the band edge increasing linearly to a level of 27 dBm/MHz at the band edge.

4.2 TEST PROCEDURE

- a. The measuring distance of 3 m shall be used for measurements. The EUT was placed on the top of a rotating table 0.8 meter above the ground at a 3 meter semi-anechoic chamber. The table was rotated 360 degrees to determine the position of the highest radiation.(below 1GHz)
- b. The measuring distance of 3 m shall be used for measurements. The EUT was placed on the top of a rotating table 1.5 meter above the ground at a 3 meter semi-anechoic chamber. The table was rotated 360 degrees to determine the position of the highest radiation.(above 1GHz)
- c. The height of the equipment or of the substitution antenna shall be 0.8m or 1.5m; the height of the test antenna shall vary between 1 m to 4 m. Both horizontal and vertical polarizations of the antenna are set to make the measurement.
- d. For each suspected emission, the EUT was arranged to its worst case and then the antenna was tuned to heights find the maximum reading (used Bore sight function).
- e. The receiver system was set to peak and average detect function and specified bandwidth with maximum hold mode when the test frequency is above 1 GHz.
- f. The initial step in collecting radiated emission data is a receiver peak detector mode pre-scanning the measurement frequency range. Significant peaks are then marked and then Quasi Peak detector mode re-measured.
- g. All readings are Peak unless otherwise stated QP in column of Note. Peak denotes that the Peak reading compliance with the QP Limits and then QP Mode measurement didn't perform.
(below 1 GHz)
- h. All readings are Peak Mode value unless otherwise stated AVG in column of Note. If the Peak Mode Measured value compliance with the Peak Limits and lower than AVG Limits, the EUT shall be deemed to meet both Peak & AVG Limits and then only Peak Mode was measured, but AVG Mode didn't perform. (above 1 GHz)
- i. For the actual test configuration, please refer to the related Item –EUT Test Photos.

4.3 DEVIATION FROM TEST STANDARD

No deviation

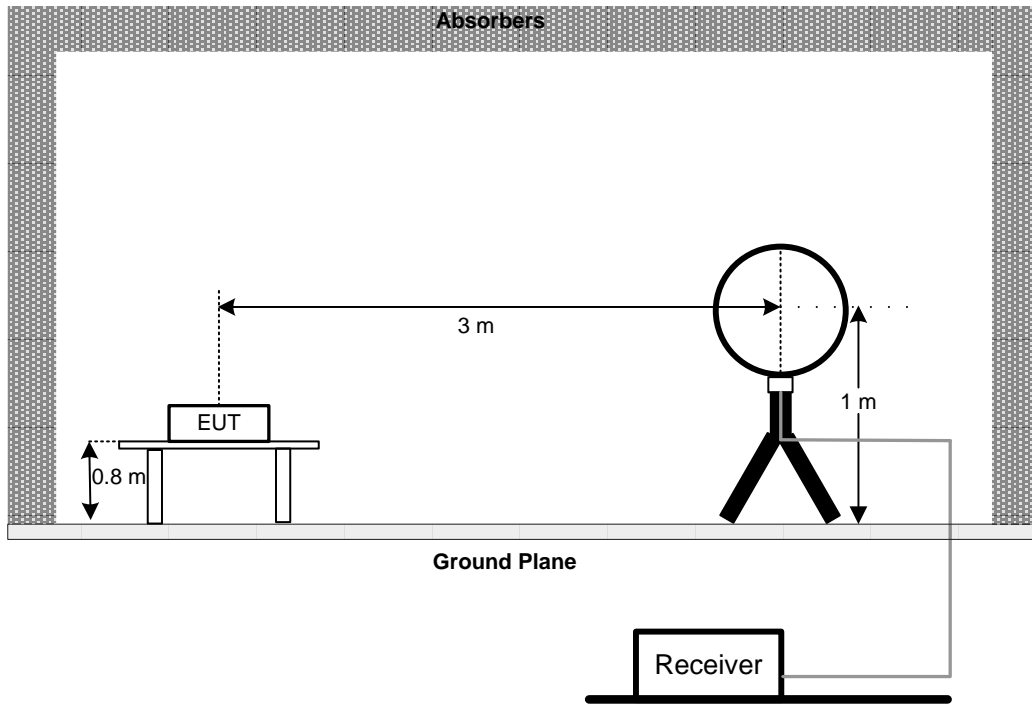
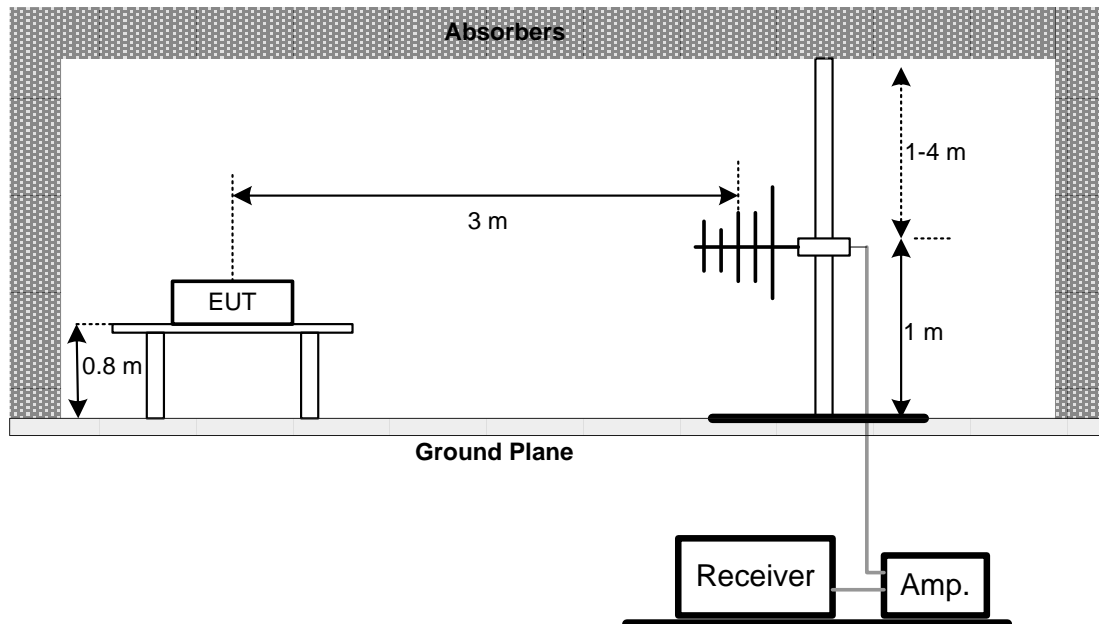
4.4 TEST SETUP**9 kHz to 30 MHz****30 MHz to 1 GHz**

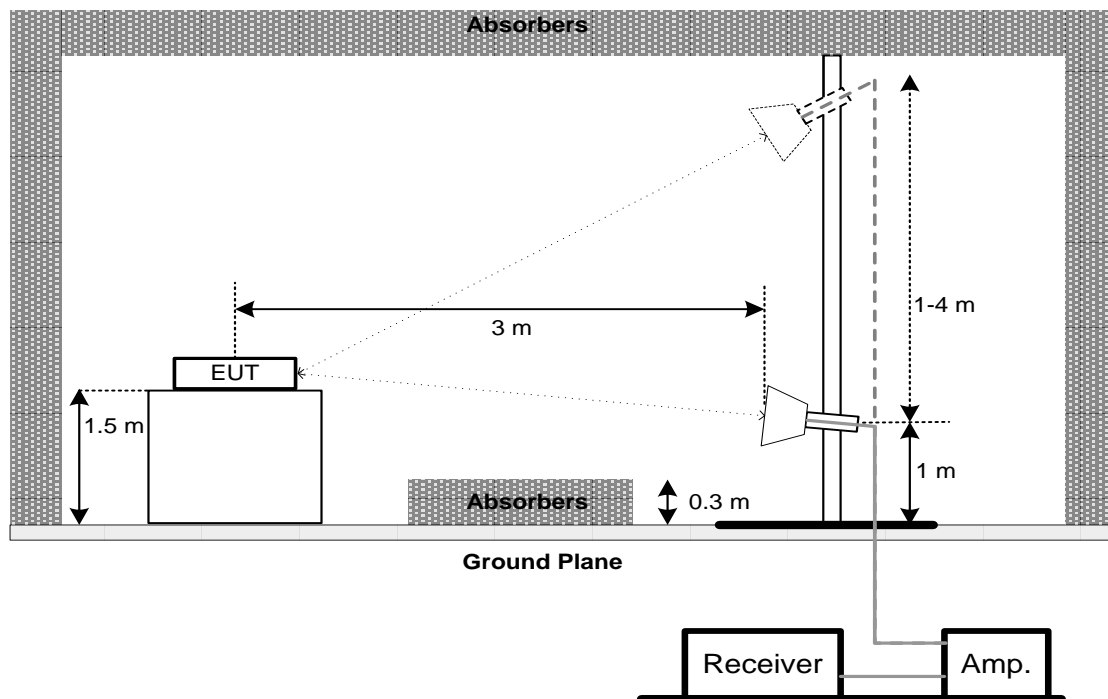
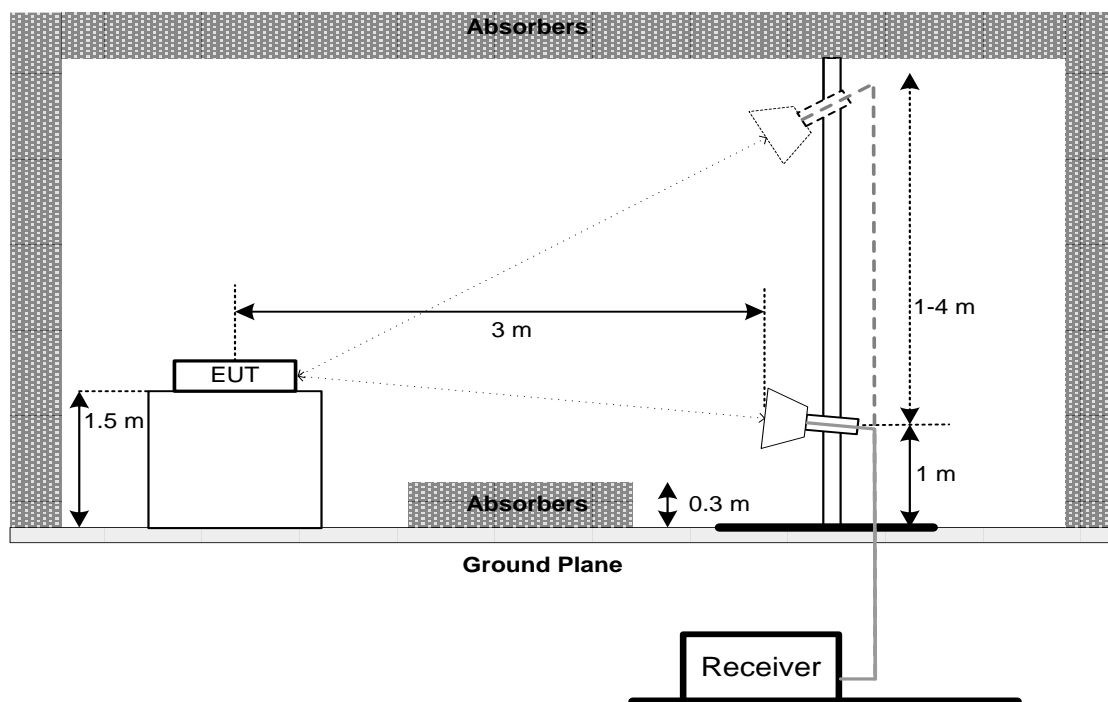
Above 1 GHz**Above 1 GHz
Band edge**

4.5 EUT OPERATION CONDITIONS

The EUT tested system was configured as the statements of 4.1.5 unless otherwise a special operating condition is specified in the follows during the testing.

4.6 TEST RESULTS - 30 MHz TO 1000 MHz

Please refer to the APPENDIX B.

4.7 TEST RESULTS - ABOVE 1000 MHz

Please refer to the APPENDIX C.

Remark:

- (1) No limit: This is fundamental signal, the judgment is not applicable.
For fundamental signal judgment was referred to Peak output test.

5. BANDWIDTH TEST

5.1 LIMIT

FCC Part15, Subpart E (15.407)			
Section	Test Item	Limit	Frequency Range (MHz)
15.407(a) 15.407(e)	26 dB Bandwidth	-	5150-5250
	26 dB Bandwidth	-	5250-5350
	26 dB Bandwidth	-	5470-5725
	6 dB Bandwidth	Minimum 500 kHz	5725-5850

5.2 TEST PROCEDURE

a. The EUT was directly connected to the spectrum analyzer and antenna output port as show in the block diagram below

b. a. Spectrum Setting:

For UNII-1, UNII-2A, UNII-2C:

Spectrum Parameter	Setting
Attenuation	Auto
Span Frequency	> 26 dB Bandwidth
RBW	300 kHz (Bandwidth 20 MHz) 1 MHz (Bandwidth 40 MHz and 80 MHz)
VBW	1 MHz (Bandwidth 20 MHz) 3 MHz (Bandwidth 40 MHz and 80 MHz)
Detector	Peak
Trace	Max Hold
Sweep Time	Auto

For UNII-3:

Spectrum Parameter	Setting
Attenuation	Auto
Span Frequency	6 dB Bandwidth
RBW	100 kHz
VBW	300 kHz
Detector	Peak
Trace	Max Hold
Sweep Time	Auto

c. Measured the spectrum width with power higher than 26 dB below carrier

5.3 TEST PROCEDURE

No deviation.

5.4 TEST SETUP**5.5 EUT OPERATION CONDITIONS**

The EUT was programmed to be in continuously transmitting mode.

5.6 TEST RESULTS

Please refer to the APPENDIX D.

6. MAXIMUM OUTPUT POWER TEST

6.1 LIMIT

FCC Part15, Subpart E (15.407)			
Section	Test Item	Limit	Frequency Range (MHz)
15.407(a)	Conducted Output Power	AP device: 1 Watt (30 dBm) Client device: 250 mW (24 dBm)	5150-5250
		250 mW (24 dBm)	5250-5350
		250 mW (24 dBm)	5470-5725
		1 Watt (30dBm)	5725-5850

Note:

- a. For an indoor access point operating in the band 5.15-5.25 GHz, the maximum conducted output power over the frequency band of operation shall not exceed 1 W provided the maximum antenna gain does not exceed 6 dBi. In addition, the maximum power spectral density shall not exceed 17 dBm in any 1 megahertz band. If transmitting antennas of directional gain greater than 6 dBi are used, both the maximum conducted output power and the maximum power spectral density shall be reduced by the amount in dB that the directional gain of the antenna exceeds 6 dBi.
- b. For the 5.25-5.35 GHz and 5.47-5.725 GHz bands, the maximum conducted output power over the frequency bands of operation shall not exceed the lesser of 250 mW or 11 dBm + 10log B, where B is the 26dB Bandwidth in megahertz.

6.2 TEST PROCEDURE

- a. The EUT was directly connected to the power meter and antenna output port as show in the block diagram below.
- b. Test test was performed in accordance with method of FCC KDB 789033 D02 General UNII Test Procedures New Rules v02r01.

6.3 DEVIATION FROM STANDARD

No deviation.

6.4 TEST SETUP



6.5 EUT OPERATION CONDITIONS

The EUT was programmed to be in continuously transmitting mode.

6.6 TEST RESULTS

Please refer to the APPENDIX E.

7. POWER SPECTRAL DENSITY TEST

7.1 LIMIT

FCC Part15, Subpart E (15.407)			
Section	Test Item	Limit	Frequency Range (MHz)
15.407(a)	Power Spectral Density	AP device: 17 dBm/MHz Client device: 11 dBm/MHz	5150-5250
		11 dBm/MHz	5250-5350
		11 dBm/MHz	5470-5725
		30 dBm/500 kHz	5725-5850

7.2 TEST PROCEDURE

- a. The EUT was directly connected to the spectrum analyzer and antenna output port as show in the block diagram below.
- b. Spectrum Setting

Spectrum Parameter	Setting
Attenuation	Auto
Span Frequency	Encompass the entire emissions bandwidth (EBW) of the signal
RBW	= 1 MHz.
VBW	≥ 3 MHz.
Detector	RMS
Trace average	100 trace
Sweep Time	Auto

Note:

1. For UNII-3, according to KDB publication 789033 D02 General UNII Test Procedures New Rules v02r01, section II.F.5., it is acceptable to set RBW at 1 MHz and VBW at 3 MHz if the spectrum analyzer does not have 500 kHz RBW.
2. The value measured with RBW=1 MHz is to be added with $10\log(500 \text{ kHz}/1 \text{ MHz})$ which is -3 dB. For example, if the measured value is +10dBm using RBW=1 MHz (that is +10 dBm/MHz), then the converted value will be +7dBm/500kHz.

7.3 DEVIATION FROM STANDARD

No deviation.

7.4 TEST SETUP**7.5 EUT OPERATION CONDITIONS**

The EUT was programmed to be in continuously transmitting mode.

7.6 TEST RESULTS

Please refer to the APPENDIX F.

8. MEASUREMENT INSTRUMENTS LIST

AC Power Line Conducted Emissions					
Item	Kind of Equipment	Manufacturer	Type No.	Serial No.	Calibrated until
1	Line Impedance Stabilisation Network	Schwarzbeck	NNLK 8121	8121-822	Mar. 21, 2021
2	TWO-LINE V-NETWORK	R&S	ENV216	101340	Sep. 01, 2020
3	EMI Test Receiver	R&S	ESCI	100082	Mar. 21, 2021
4	50Ω coaxial switch	Anritsu	MP59B	6201750902	Mar. 21, 2021
5	Cable	10m	EMCRG400-BM-N M-10000	170628	Jul. 16, 2020
6	Measurement Software	Farad	EZ-EMC Ver.NB-03A1-01	N/A	N/A

Radiated Emissions - 9 kHz to 30 MHz					
Item	Kind of Equipment	Manufacturer	Type No.	Serial No.	Calibrated until
1	Loop Antenna	EMCI	EMCI LPA600	275	Apr. 02, 2021
2	Cable	N/A	EMCRG400-BM-N M-10000	170628	Jul. 16, 2020
3	MXE EMI Receiver	Keysight	N9038A	MY57150106	May. 06, 2021
4	Measurement Software	Farad	EZ-EMC Ver.BTL-2ANT-1	N/A	N/A

Radiated Emissions - 30 MHz to 1 GHz					
Item	Kind of Equipment	Manufacturer	Type No.	Serial No.	Calibrated until
1	TRILOG Broadband Antenna	Schwarzbeck	VULB 9168	719	Apr. 02, 2021
2	Pre-Amplifier	emci	EMC9135	980400	Mar. 21, 2021
3	MXE EMI Receiver	Keysight	N9038A	MY57150106	May. 06, 2021
4	Attenuator	emci	EMCI-N-6-06	AT-N0644	Mar. 21, 2021
5	Cable	7m	EMC104-SM-SM-7000	170330	Apr. 13, 2021
6	Cable	1m	EMC104-SM-SM-1000	170331	Apr. 13, 2021
7	Cable	3.5m	EMC104-SM-NM-3500	170621	Apr. 13, 2021
8	Measurement Software	Farad	EZ-EMC Ver.BTL-2ANT-1	N/A	N/A

Radiated Emissions - Above 1 GHz					
Item	Kind of Equipment	Manufacturer	Type No.	Serial No.	Calibrated until
1	Double-Ridged Waveguide Horn Antenna	Schwarzbeck	BBHA 9120D	9120D-1787	Mar. 21, 2021
2	Double-Ridged Waveguide Horn Antenna	ETS-Lindgren	3116C	00203919	Mar. 21, 2021
3	Pre-Amplifier	emci	EMC012645SE	980421	May. 11, 2021
4	Pre-Amplifier	emci	EMC184045SE	980409	Mar. 21, 2021
5	EXA Spectrum Analyzer	Keysight	N9010A	MY56480559	Mar. 21, 2021
6	MXE EMI Receiver	Keysight	N9038A	MY56400088	Mar. 21, 2021
7	Cable	7m	EMC104-SM-SM-700 0	170330	Apr. 13, 2021
8	Cable	1m	EMC104-SM-SM-100 0	170331	Apr. 13, 2021
9	Cable	3.5m	EMC104-SM-NM-350 0	170621	Apr. 13, 2021
10	Cable	0.8m	EMC102-SM-SM-800	170335	Apr. 13, 2021
11	Cable	6m	EMC102-SM-SM-600 0	170336	Apr. 13, 2021
12	Measurement Software	Farad	EZ-EMC Ver.NB-03A1-01	N/A	N/A

Bandwidth					
Item	Kind of Equipment	Manufacturer	Type No.	Serial No.	Calibrated until
1	Spectrum Analyzer	R&S	FSP40	100626	May. 06, 2021

Maximum Output Power					
Item	Kind of Equipment	Manufacturer	Type No.	Serial No.	Calibrated until
1	Power Meter	Keysight	8990B	MY51000507	Mar. 21, 2021
2	Pulse Power Sensor	Keysight	N1923A	MY58310003	Mar. 21, 2021

Antenna Conducted Spurious Emissions					
Item	Kind of Equipment	Manufacturer	Type No.	Serial No.	Calibrated until
1	Spectrum Analyzer	R&S	FSP40	100626	May. 06, 2021

Power Spectral Density					
Item	Kind of Equipment	Manufacturer	Type No.	Serial No.	Calibrated until
1	Spectrum Analyzer	R&S	FSP40	100626	May. 06, 2021

Remark: "N/A" denotes no model name, serial no. or calibration specified.

All calibration period of equipment list is one year.

9. EUT TEST PHOTOS

Conducted Emissions Test Photos

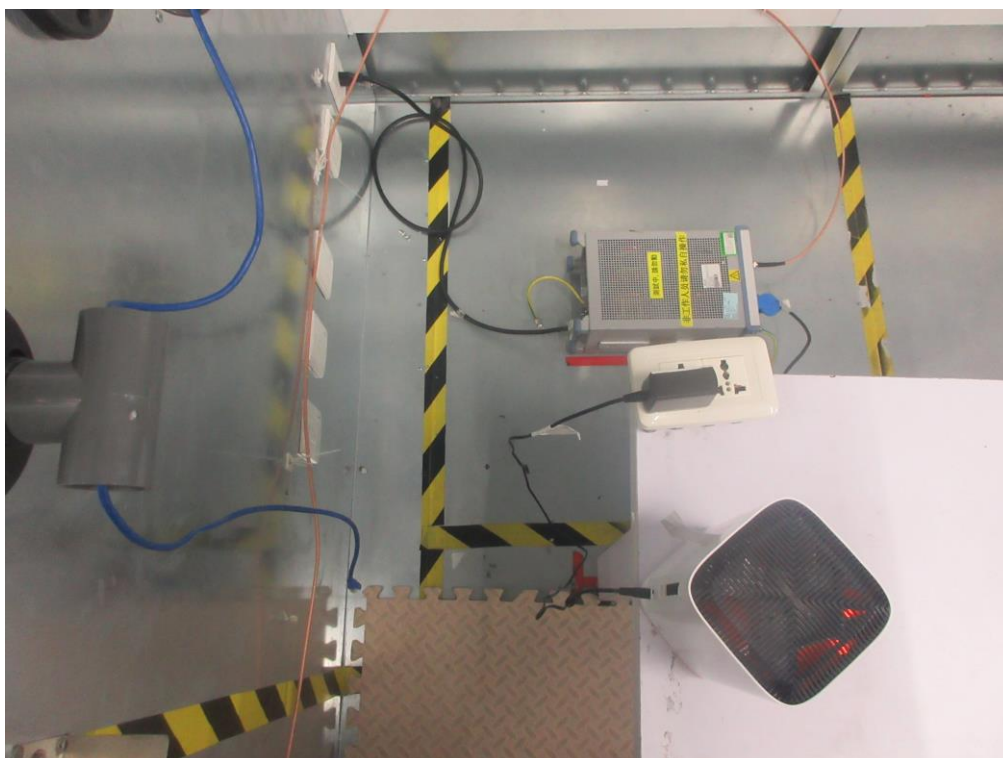

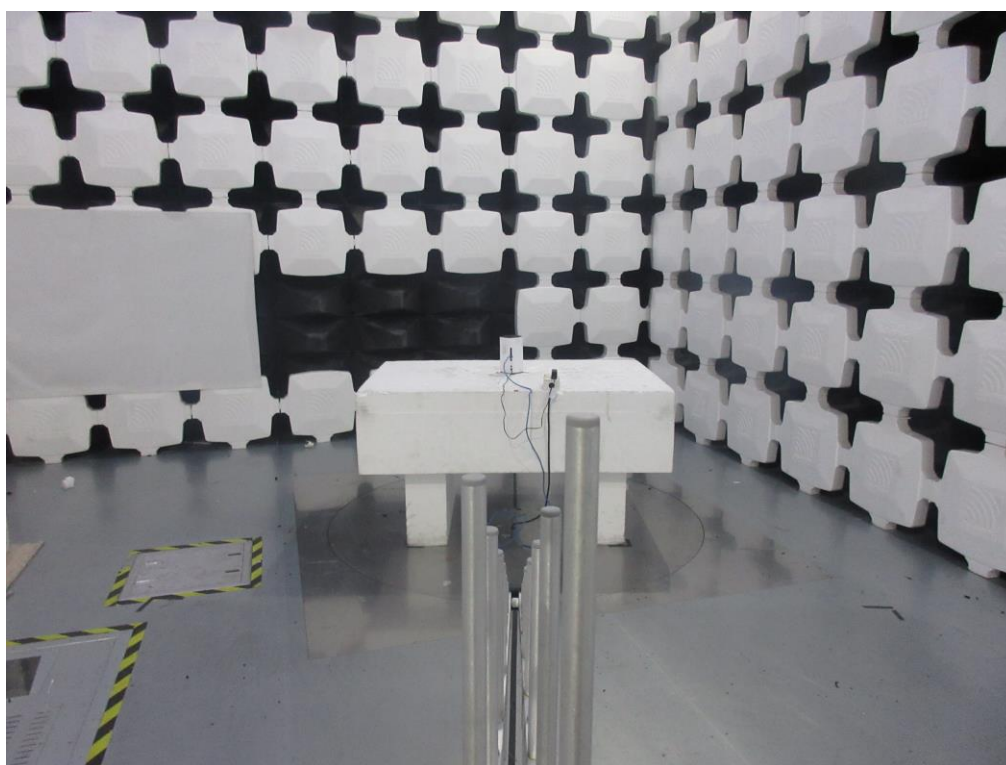
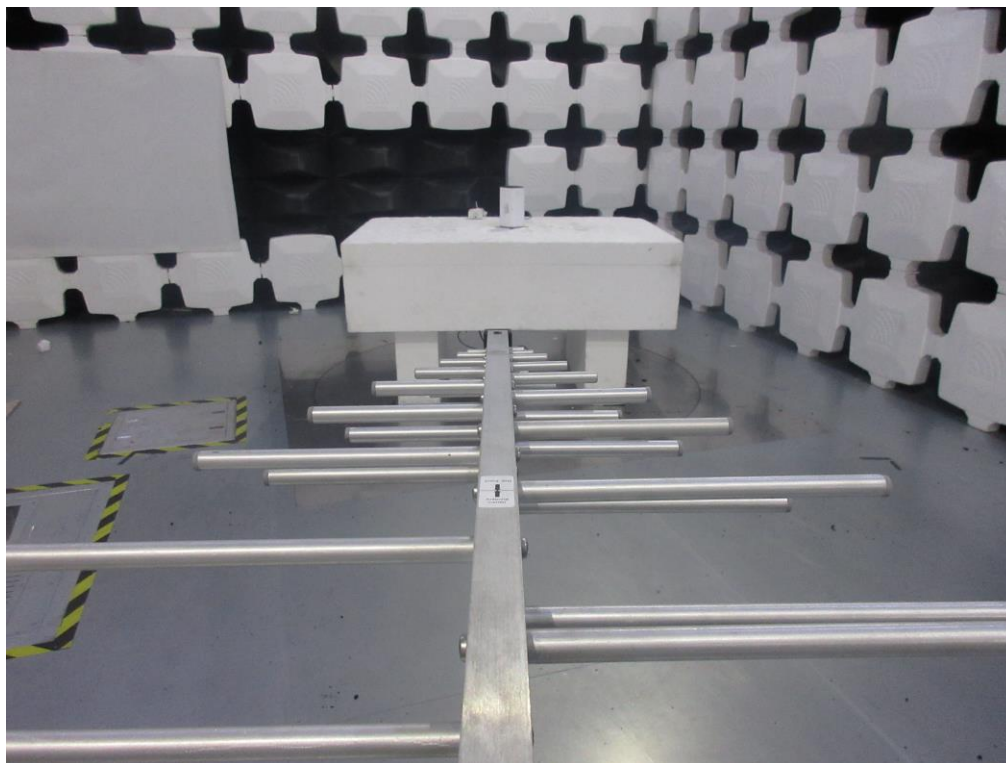
Radiated Emissions Test Photos**30 MHz to 1 GHz**

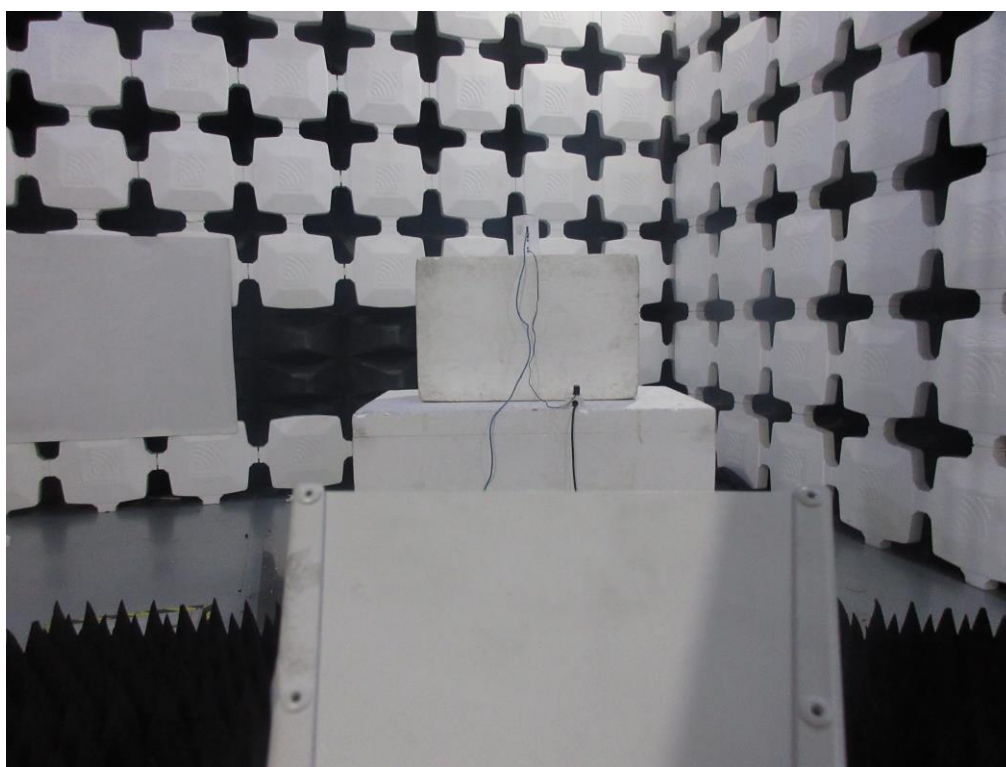
Radiated Emissions Test Photos**Above 1 GHz**

APPENDIX A - AC POWER LINE CONDUCTED EMISSIONS

Test Mode: TX Mode Adapter: S12A12-120A100-CJ

Line

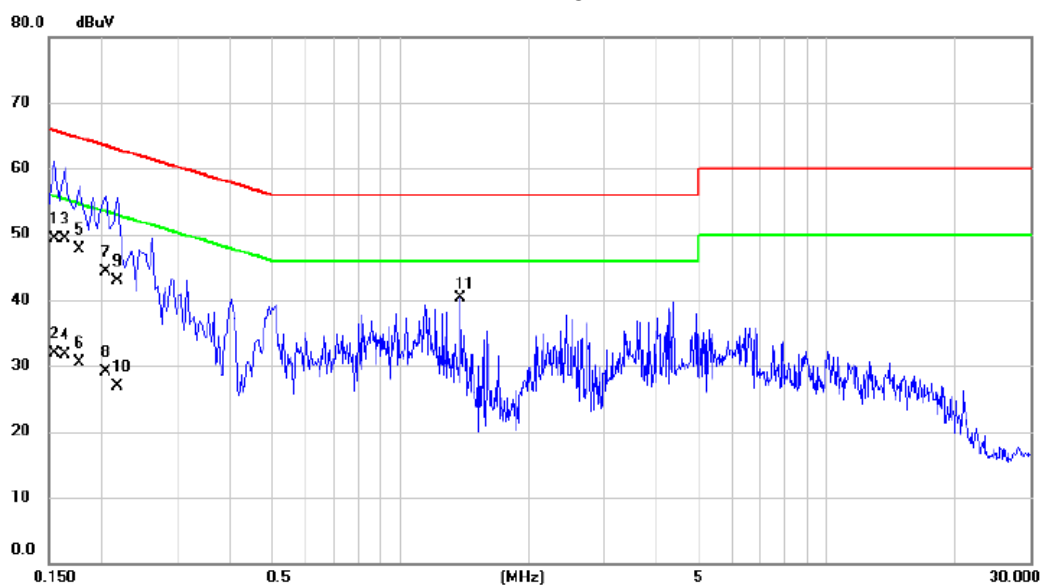

No. Mk.	Freq. MHz	Reading Level dBuV	Correct Factor dB	Measure- ment dBuV	Limit dBuV	Margin dB	Detector	Comment
1	0.1545	39.50	9.73	49.23	65.75	-16.52	QP	
2	0.1545	22.10	9.73	31.83	55.75	-23.92	AVG	
3	0.1635	39.60	9.74	49.34	65.28	-15.94	QP	
4	0.1635	22.00	9.74	31.74	55.28	-23.54	AVG	
5	0.1770	37.90	9.76	47.66	64.63	-16.97	QP	
6	0.1770	20.80	9.76	30.56	54.63	-24.07	AVG	
7	0.2040	34.50	9.78	44.28	63.45	-19.17	QP	
8	0.2040	19.40	9.78	29.18	53.45	-24.27	AVG	
9	0.2175	33.20	9.79	42.99	62.91	-19.92	QP	
10	0.2175	17.10	9.79	26.89	52.91	-26.02	AVG	
11 *	1.3875	30.46	9.76	40.22	56.00	-15.78	peak	

REMARKS:

- (1) Measurement Value = Reading Level + Correct Factor.
- (2) Margin Level = Measurement Value - Limit Value.

Test Mode: TX Mode Adapter: S12A12-120A100-CJ

Neutral

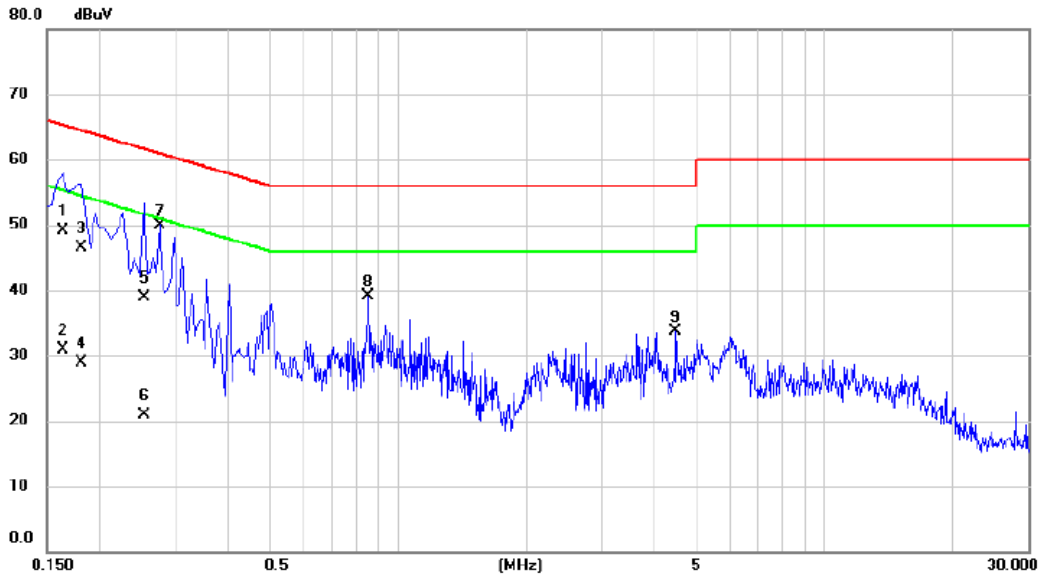

No. Mk.	Freq. MHz	Reading Level dBuV	Correct Factor dB	Measurement dBuV	Limit dBuV	Margin dB	Detector	Comment
1	0.1635	39.50	9.61	49.11	65.28	-16.17	QP	
2	0.1635	21.20	9.61	30.81	55.28	-24.47	AVG	
3	0.1815	36.80	9.63	46.43	64.42	-17.99	QP	
4	0.1815	19.30	9.63	28.93	54.42	-25.49	AVG	
5	0.2535	29.20	9.65	38.85	61.64	-22.79	QP	
6	0.2535	11.30	9.65	20.95	51.64	-30.69	AVG	
7 *	0.2760	40.35	9.65	50.00	60.94	-10.94	peak	
8	0.8520	29.42	9.72	39.14	56.00	-16.86	peak	
9	4.4790	23.88	9.92	33.80	56.00	-22.20	peak	

REMARKS:

- (1) Measurement Value = Reading Level + Correct Factor.
- (2) Margin Level = Measurement Value - Limit Value.

APPENDIX B - RADIATED EMISSION - 30 MHZ TO 1 GHZ

Test Mode: TX Mode Adapter: S12A12-120A100-CJ

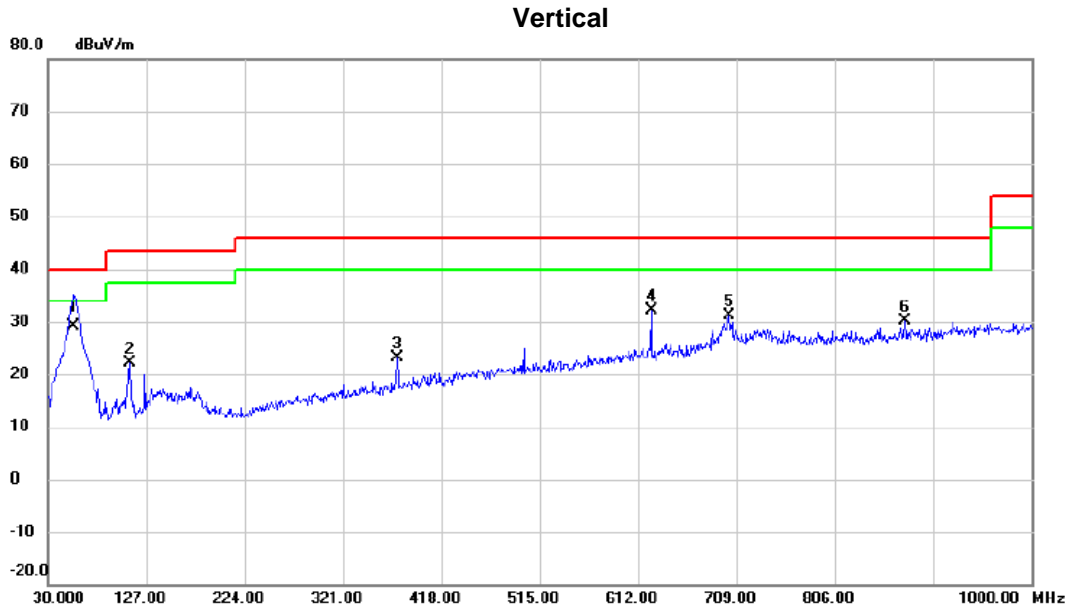

No.	Mk.	Freq. MHz	Reading Level dBuV	Correct Factor dB	Measure- ment dBuV/m	Limit dBuV/m	Margin dB	Detector	Comment
1	*	55.7050	45.84	-16.61	29.23	40.00	-10.77	QP	
2		110.5100	41.27	-19.20	22.07	43.50	-21.43	peak	
3		374.8350	36.24	-13.11	23.13	46.00	-22.87	peak	
4		625.0950	39.76	-7.75	32.01	46.00	-13.99	peak	
5		701.2400	37.92	-6.77	31.15	46.00	-14.85	peak	
6		874.8700	34.89	-4.66	30.23	46.00	-15.77	peak	

REMARKS:

- (1) Measurement Value = Reading Level + Correct Factor.
- (2) Margin Level = Measurement Value - Limit Value.

Test Mode: TX Mode Adapter: S12A12-120A100-CJ

Horizontal

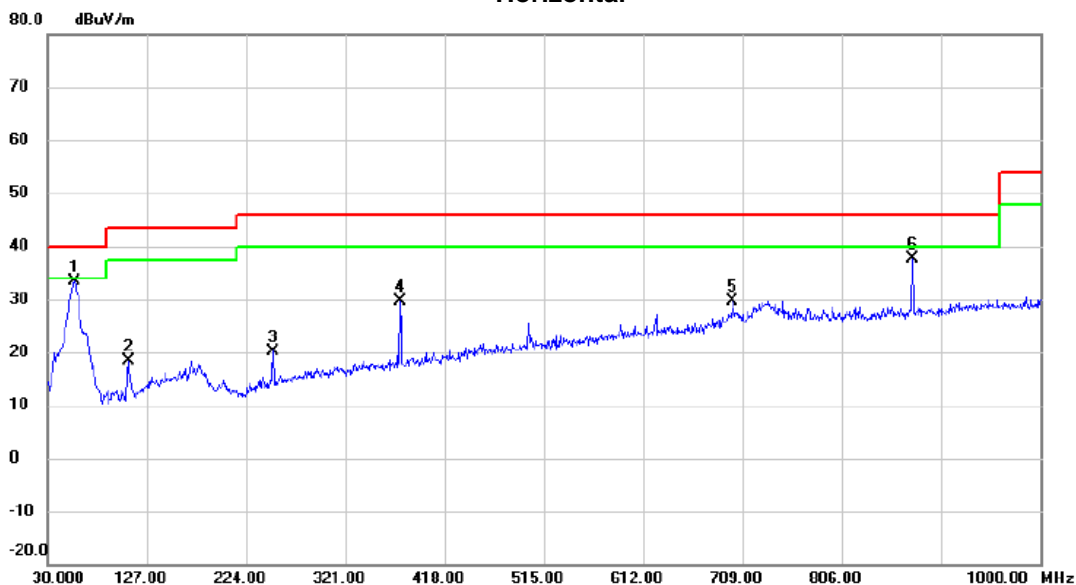

No.	Mk.	Freq. MHz	Reading Level dBuV	Correct Factor dB	Measure- ment dBuV/m	Limit dBuV/m	Margin dB	Detector	Comment
1	*	56.6750	49.99	-16.66	33.33	40.00	-6.67	peak	
2		109.0550	37.73	-19.39	18.34	43.50	-25.16	peak	
3		250.1900	36.92	-16.67	20.25	46.00	-25.75	peak	
4		374.8350	42.81	-13.11	29.70	46.00	-16.30	peak	
5		699.7850	36.47	-6.79	29.68	46.00	-16.32	peak	
6		874.8700	42.27	-4.66	37.61	46.00	-8.39	peak	

REMARKS:

- (1) Measurement Value = Reading Level + Correct Factor.
- (2) Margin Level = Measurement Value - Limit Value.

APPENDIX C - RADIATED EMISSION - ABOVE 1000 MHZ

Orthogonal Axis	X		
Test Mode	UNII-1_TX AX (HE20) Mode 5180 MHz	RU configuration	52/38

Vertical

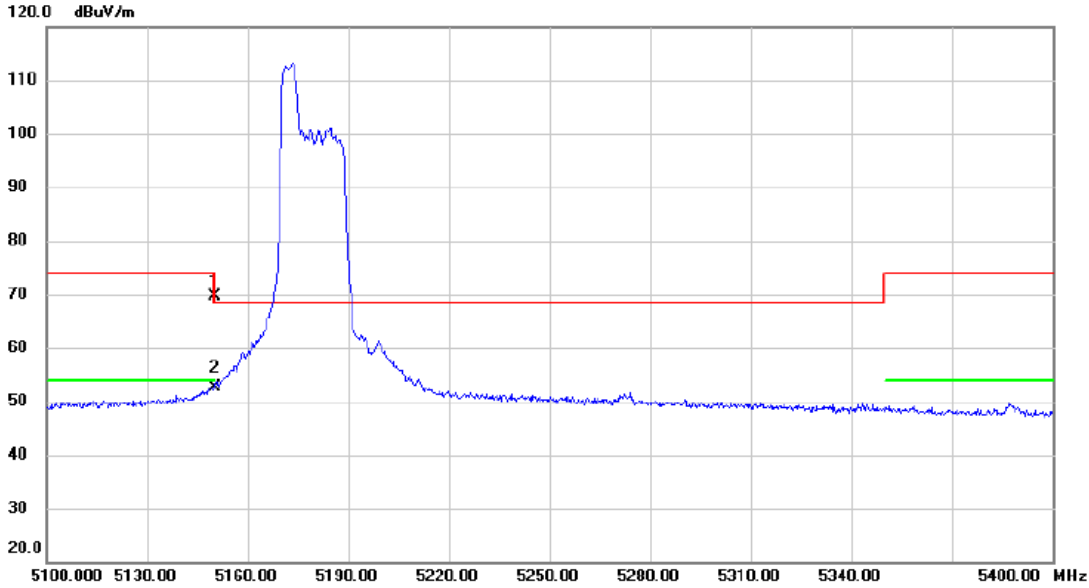

No.	Mk.	Freq. MHz	Reading Level dBuV	Correct Factor dB	Measure- ment dBuV/m	Limit dBuV/m	Margin dB	Detector	Comment
1		5150.000	29.22	40.53	69.75	74.00	-4.25	peak	
2	*	5150.000	12.11	40.53	52.64	54.00	-1.36	AVG	

REMARKS:

- (1) Measurement Value = Reading Level + Correct Factor.
- (2) Margin Level = Measurement Value - Limit Value.

Orthogonal Axis	X		
Test Mode	UNII-1_TX AX (HE20) Mode 5180 MHz	RU configuration	52/38

Horizontal

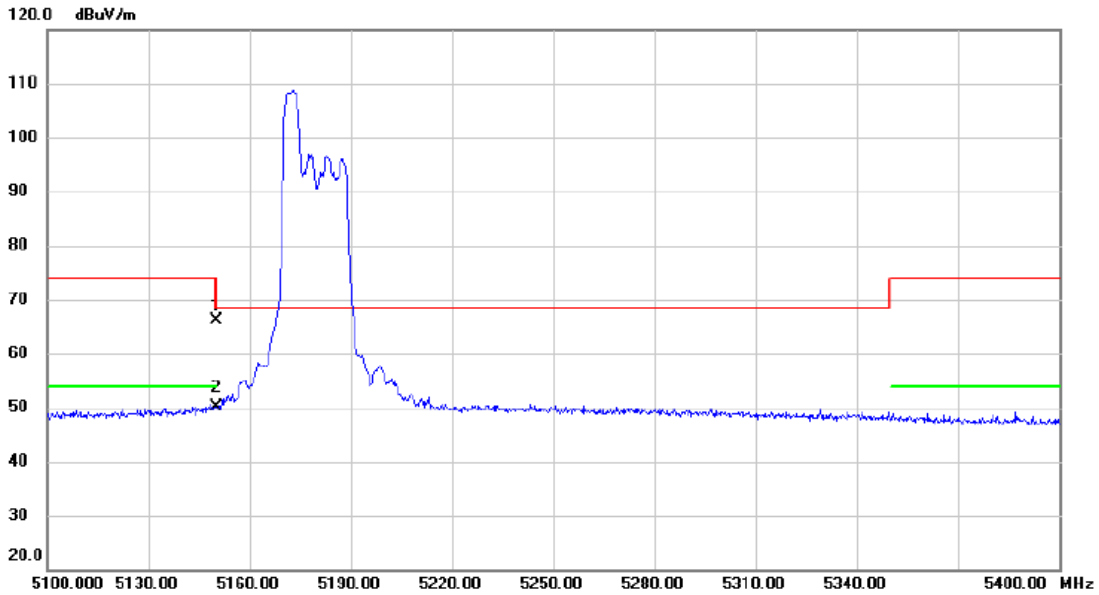

No.	Mk.	Freq. MHz	Reading Level dBuV	Correct Factor dB	Measure- ment dBuV/m	Limit dBuV/m	Margin dB	Detector	Comment
1		5150.000	25.57	40.53	66.10	74.00	-7.90	peak	
2	*	5150.000	9.51	40.53	50.04	54.00	-3.96	AVG	

REMARKS:

- (1) Measurement Value = Reading Level + Correct Factor.
- (2) Margin Level = Measurement Value - Limit Value.

Orthogonal Axis	X		
Test Mode	UNII-1_TX AX (HE20) Mode 5180 MHz	RU configuration	106/54

Vertical

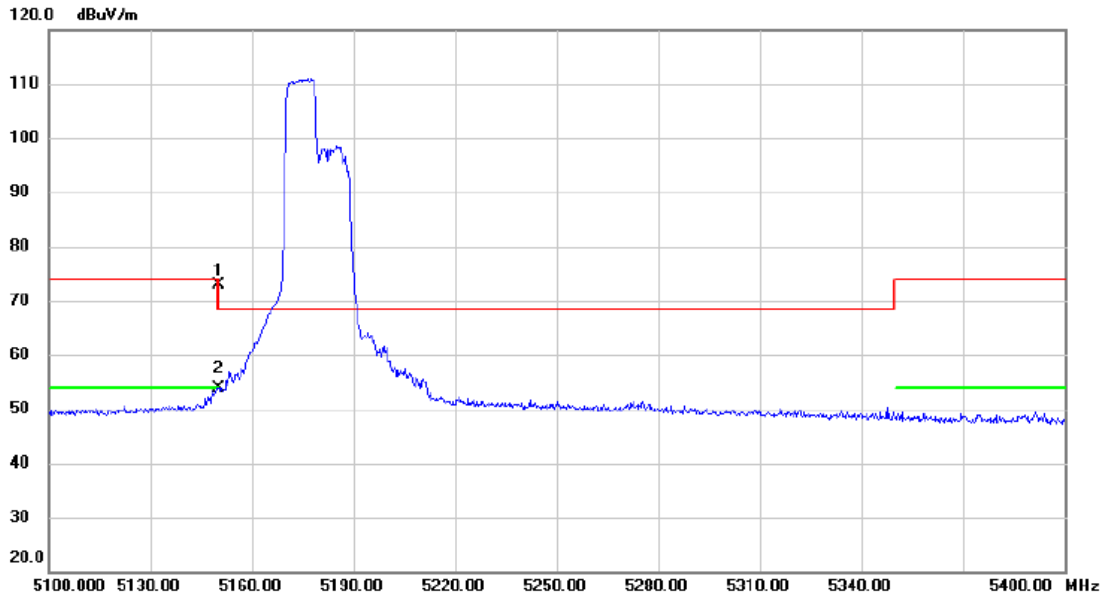

No.	Mk.	Freq. MHz	Reading Level dBuV	Correct Factor dB	Measure- ment dBuV/m	Limit dBuV/m	Margin dB	Detector	Comment
1		5150.000	32.41	40.53	72.94	74.00	-1.06	peak	
2	*	5150.000	13.26	40.53	53.79	54.00	-0.21	AVG	

REMARKS:

- (1) Measurement Value = Reading Level + Correct Factor.
- (2) Margin Level = Measurement Value - Limit Value.

Orthogonal Axis	X		
Test Mode	UNII-1_TX AX (HE20) Mode 5180 MHz	RU configuration	106/54

Horizontal

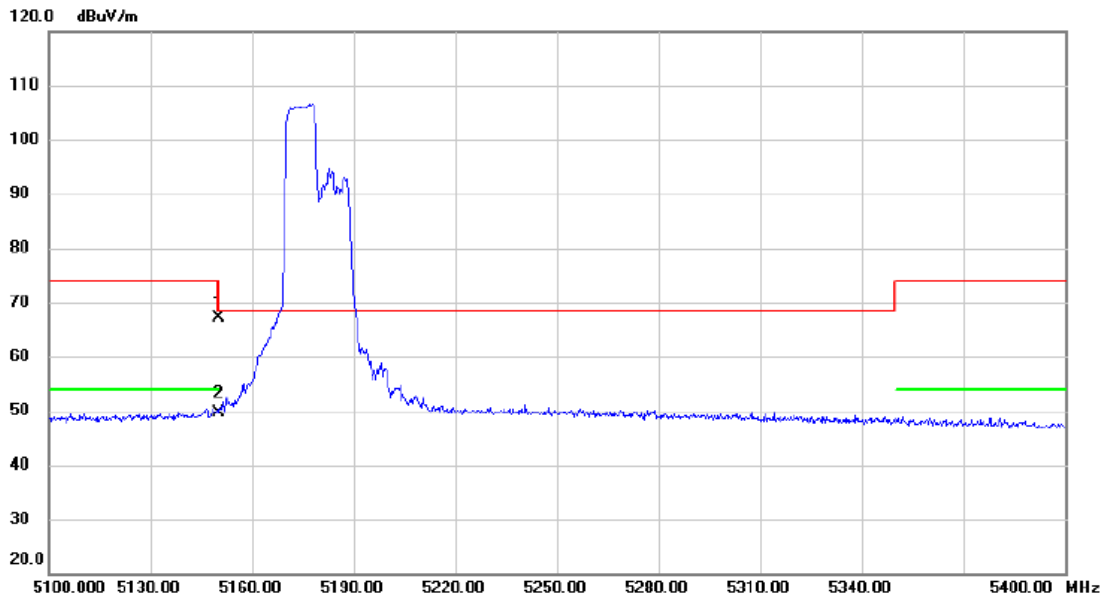

No.	Mk.	Freq. MHz	Reading Level dBuV	Correct Factor dB	Measure- ment dBuV/m	Limit dBuV/m	Margin dB	Detector	Comment
1		5150.000	26.60	40.53	67.13	74.00	-6.87	peak	
2	*	5150.000	9.02	40.53	49.55	54.00	-4.45	AVG	

REMARKS:

- (1) Measurement Value = Reading Level + Correct Factor.
- (2) Margin Level = Measurement Value - Limit Value.

Orthogonal Axis	X		
Test Mode	UNII-1_TX AX (HE20) Mode 5180 MHz	RU configuration	242/61

Vertical

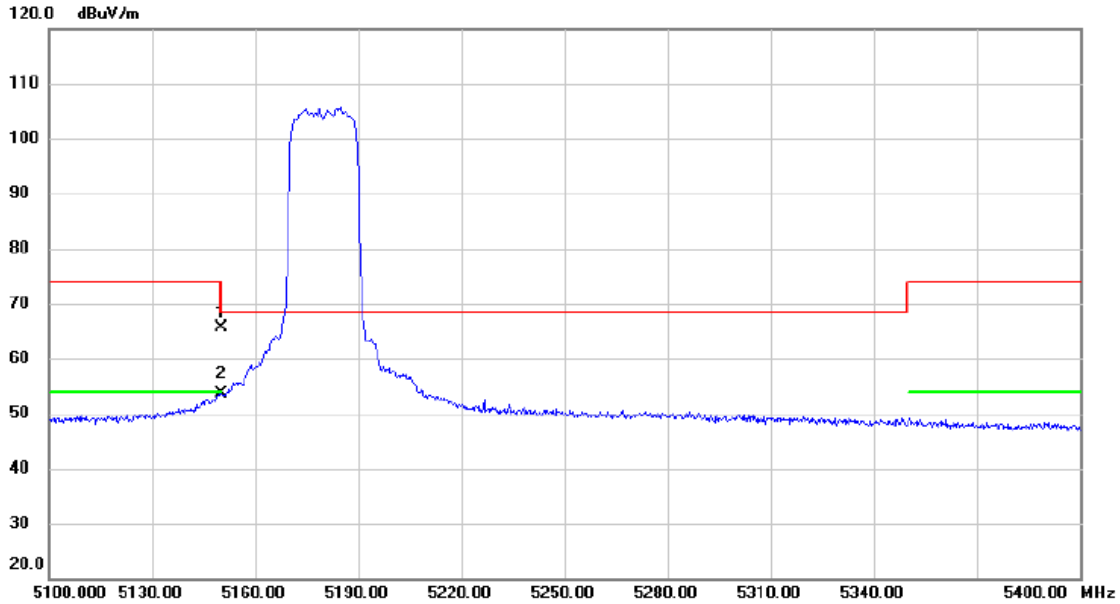

No.	Mk.	Freq. MHz	Reading Level dBuV	Correct Factor dB	Measure- ment dBuV/m	Limit dBuV/m	Margin dB	Detector	Comment
1		5150.000	25.02	40.53	65.55	74.00	-8.45	peak	
2	*	5150.000	13.10	40.53	53.63	54.00	-0.37	AVG	

REMARKS:

- (1) Measurement Value = Reading Level + Correct Factor.
- (2) Margin Level = Measurement Value - Limit Value.

Orthogonal Axis	X		
Test Mode	UNII-1_TX AX (HE20) Mode 5180 MHz	RU configuration	242/61

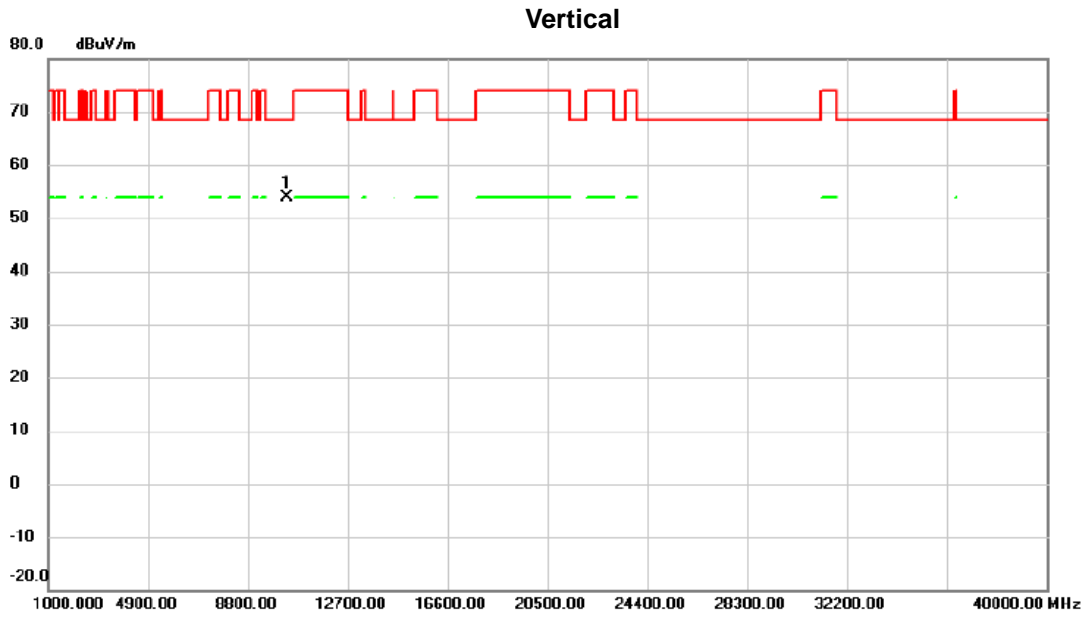

No.	Mk.	Freq. MHz	Reading Level dBuV	Correct Factor dB	Measure- ment dBuV/m	Limit dBuV/m	Margin dB	Detector	Comment
1	*	10358.64	53.32	0.67	53.99	68.30	-14.31	peak	

REMARKS:

- (1) Measurement Value = Reading Level + Correct Factor.
- (2) Margin Level = Measurement Value - Limit Value.

Orthogonal Axis	X		
Test Mode	UNII-1_TX AX (HE20) Mode 5180 MHz	RU configuration	242/61

Horizontal

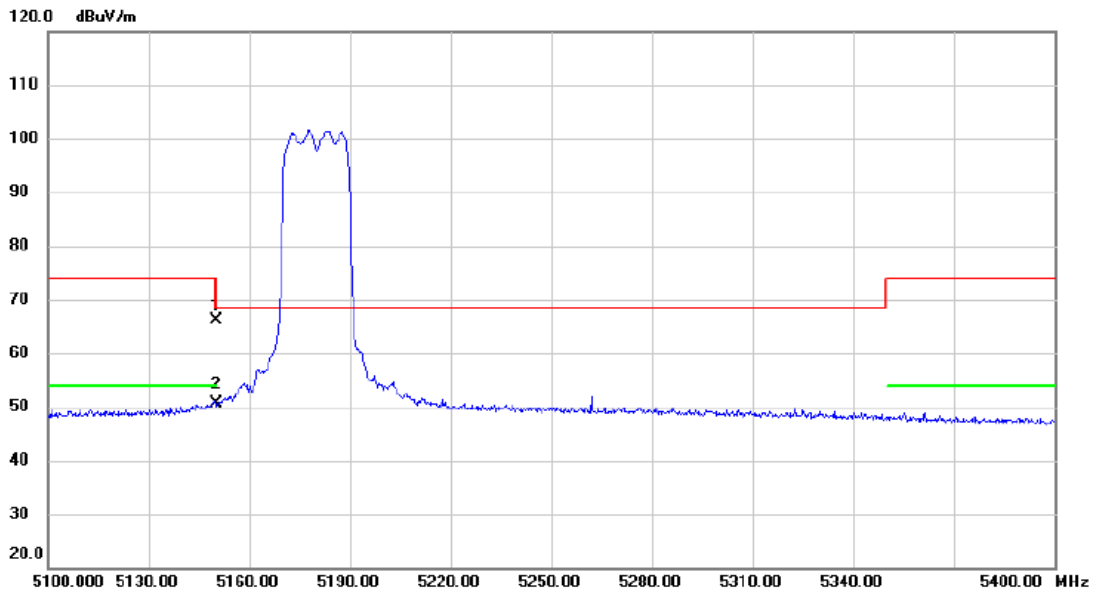

No.	Mk.	Freq. MHz	Reading Level dBuV	Correct Factor dB	Measure- ment dBuV/m	Limit dBuV/m	Margin dB	Detector	Comment
1		5150.000	25.66	40.53	66.19	74.00	-7.81	peak	
2	*	5150.000	10.16	40.53	50.69	54.00	-3.31	AVG	

REMARKS:

- (1) Measurement Value = Reading Level + Correct Factor.
- (2) Margin Level = Measurement Value - Limit Value.

Orthogonal Axis	X		
Test Mode	UNII-1_TX AX (HE20) Mode 5180 MHz	RU configuration	242/61

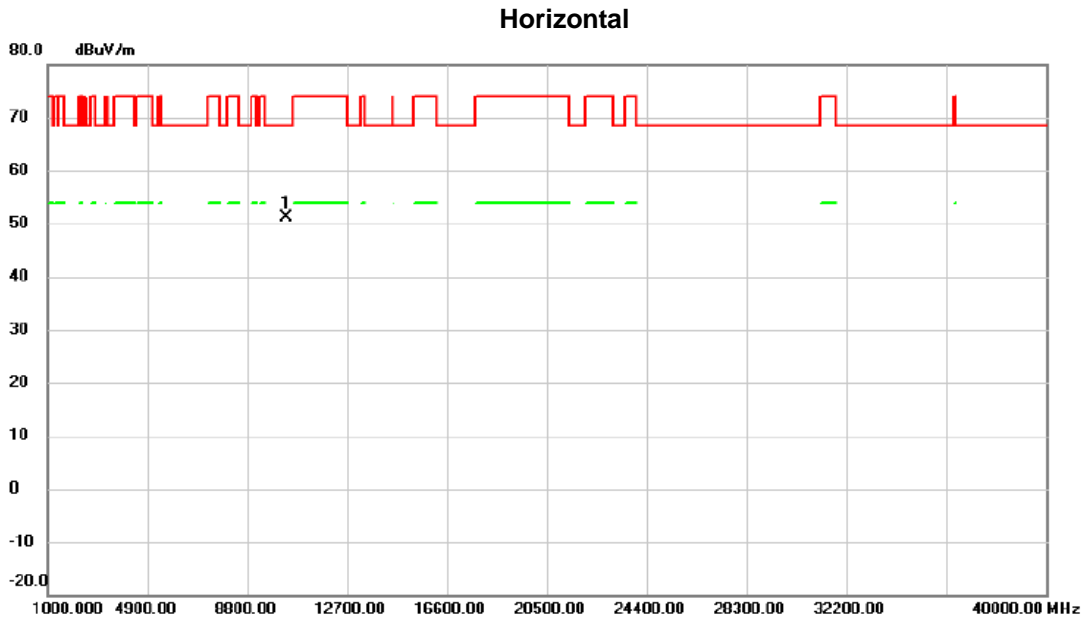

No.	Mk.	Freq.	Reading Level	Correct Factor	Measurement	Limit	Margin	Detector	Comment
		MHz	dBuV	dB	dBuV/m	dBuV/m	dB		
1	*	10358.75	50.34	0.67	51.01	68.30	-17.29	peak	

REMARKS:

(1) Measurement Value = Reading Level + Correct Factor.

(2) Margin Level = Measurement Value - Limit Value.

Orthogonal Axis	X		
Test Mode	UNII-1_TX AX (HE20) Mode 5200 MHz	RU configuration	52/38

Vertical

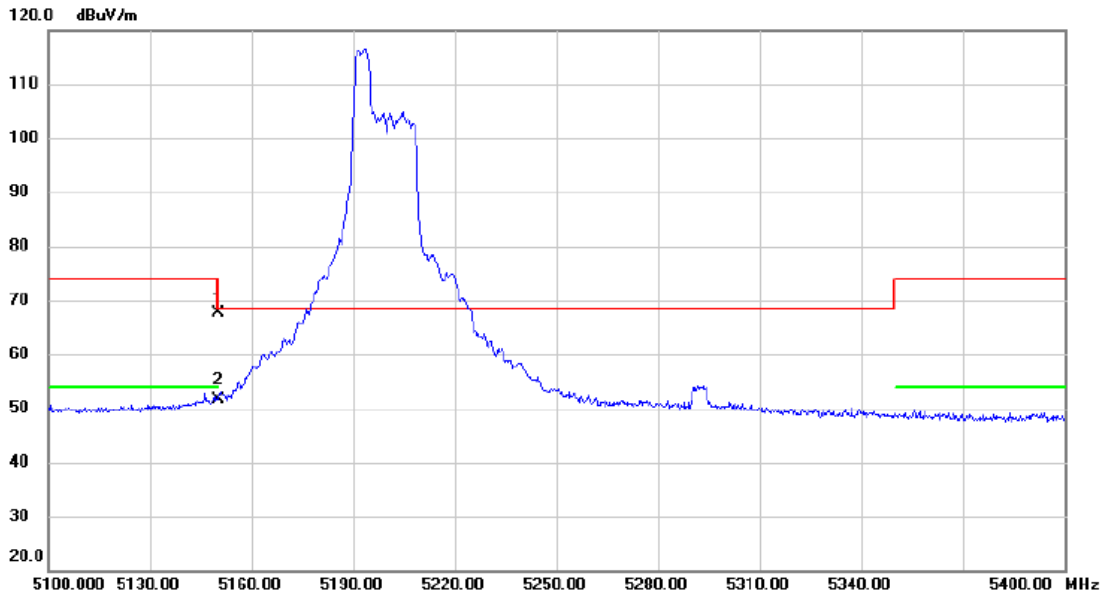

No.	Mk.	Freq. MHz	Reading Level dBuV	Correct Factor dB	Measure- ment dBuV/m	Limit dBuV/m	Margin dB	Detector	Comment
1		5150.000	27.09	40.53	67.62	74.00	-6.38	peak	
2	*	5150.000	11.18	40.53	51.71	54.00	-2.29	AVG	

REMARKS:

- (1) Measurement Value = Reading Level + Correct Factor.
- (2) Margin Level = Measurement Value - Limit Value.

Orthogonal Axis	X		
Test Mode	UNII-1_TX AX (HE20) Mode 5200 MHz	RU configuration	52/38

Horizontal

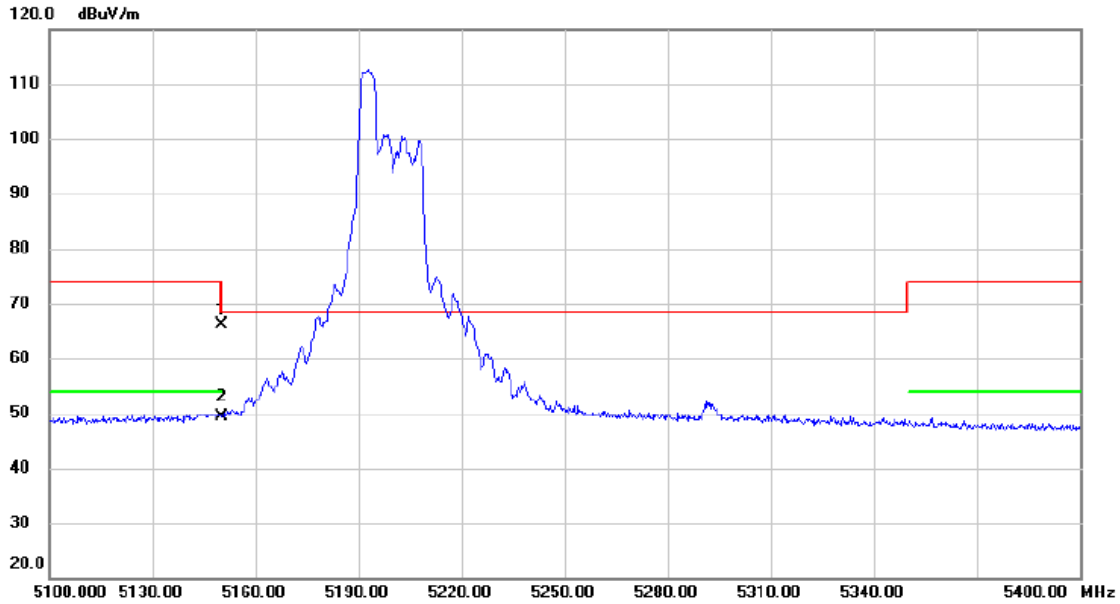

No.	Mk.	Freq.	Reading Level	Correct Factor	Measurement	Limit	Margin	Detector	Comment
		MHz	dBuV	dB	dBuV/m	dBuV/m	dB		
1		5150.000	25.71	40.53	66.24	74.00	-7.76	peak	
2	*	5150.000	8.82	40.53	49.35	54.00	-4.65	AVG	

REMARKS:

- (1) Measurement Value = Reading Level + Correct Factor.
- (2) Margin Level = Measurement Value - Limit Value.

Orthogonal Axis	X		
Test Mode	UNII-1_TX AX (HE20) Mode 5200 MHz	RU configuration	106/54

Vertical

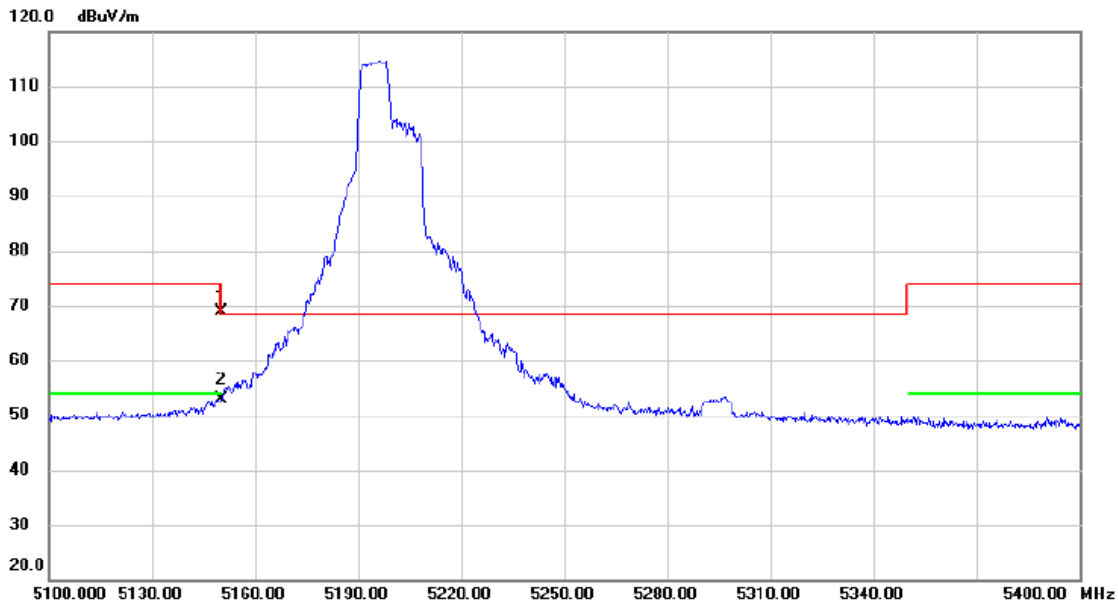

No.	Mk.	Freq. MHz	Reading Level dBuV	Correct Factor dB	Measure- ment dBuV/m	Limit dBuV/m	Margin dB	Detector	Comment
1		5150.000	28.43	40.53	68.96	74.00	-5.04	peak	
2	*	5150.000	12.38	40.53	52.91	54.00	-1.09	AVG	

REMARKS:

- (1) Measurement Value = Reading Level + Correct Factor.
- (2) Margin Level = Measurement Value - Limit Value.

Orthogonal Axis	X		
Test Mode	UNII-1_TX AX (HE20) Mode 5200 MHz	RU configuration	106/54

Horizontal

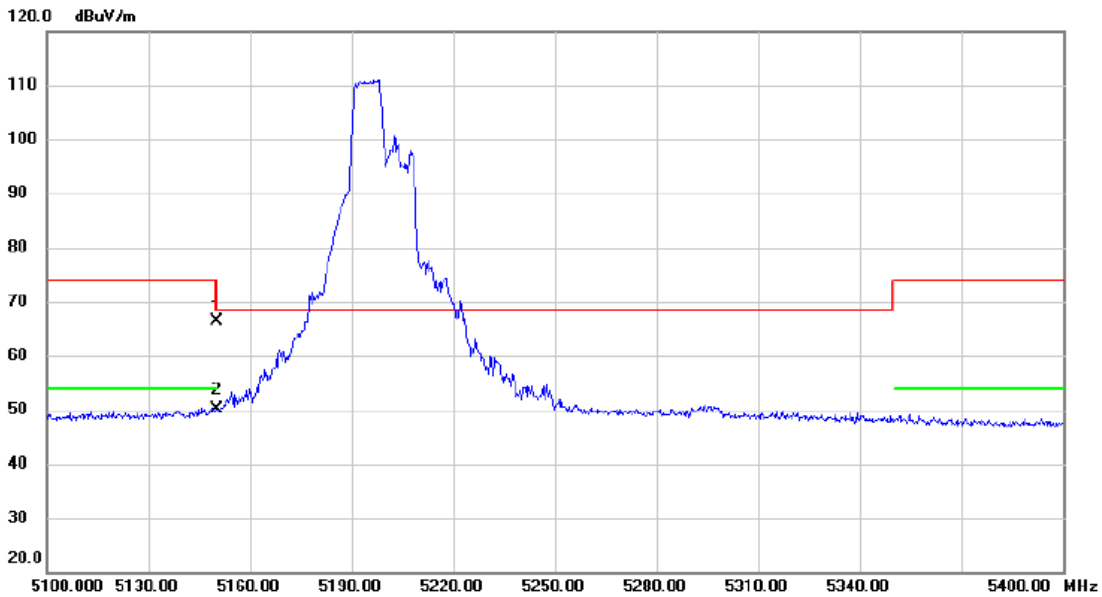

No.	Mk.	Freq. MHz	Reading Level dBuV	Correct Factor dB	Measure- ment dBuV/m	Limit dBuV/m	Margin dB	Detector	Comment
1		5150.000	25.83	40.53	66.36	74.00	-7.64	peak	
2	*	5150.000	9.68	40.53	50.21	54.00	-3.79	AVG	

REMARKS:

- (1) Measurement Value = Reading Level + Correct Factor.
- (2) Margin Level = Measurement Value - Limit Value.

Orthogonal Axis	X		
Test Mode	UNII-1_TX AX (HE20) Mode 5200 MHz	RU configuration	242/61

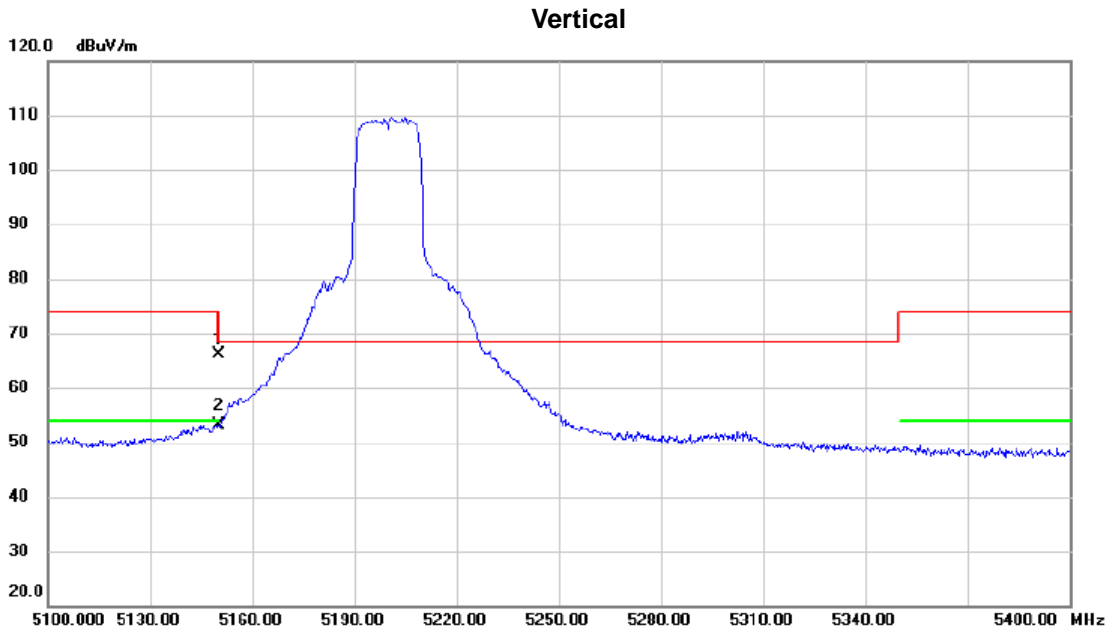

No.	Mk.	Freq. MHz	Reading Level dBuV	Correct Factor dB	Measure- ment dBuV/m	Limit dBuV/m	Margin dB	Detector	Comment
1		5150.000	25.66	40.53	66.19	74.00	-7.81	peak	
2	*	5150.000	12.57	40.53	53.10	54.00	-0.90	AVG	

REMARKS:

- (1) Measurement Value = Reading Level + Correct Factor.
- (2) Margin Level = Measurement Value - Limit Value.

Orthogonal Axis	X		
Test Mode	UNII-1_TX AX (HE20) Mode 5200 MHz	RU configuration	242/61

Vertical

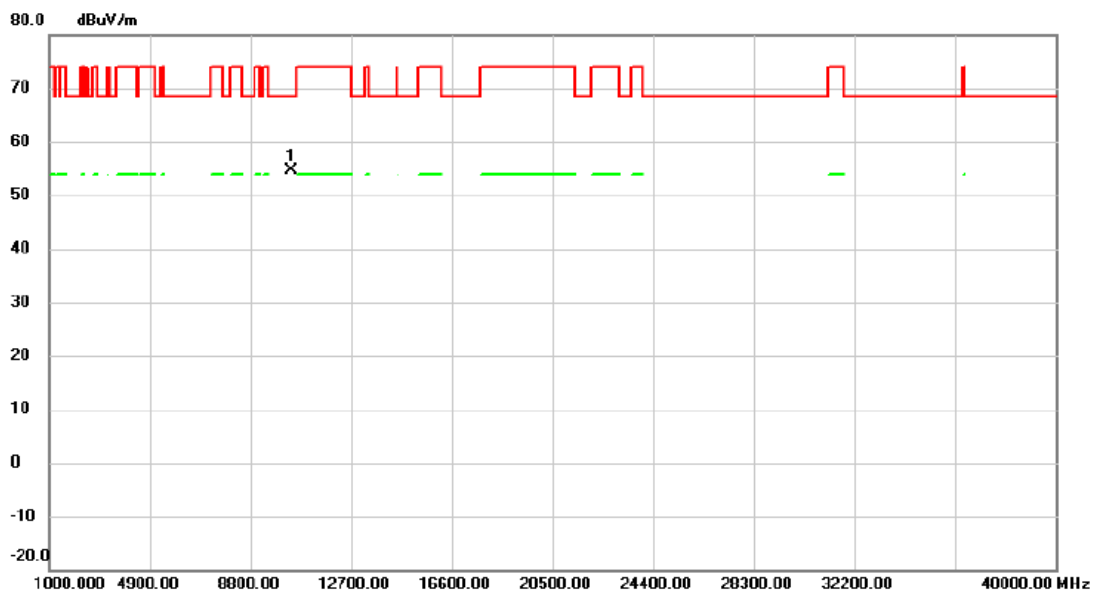

No.	Mk.	Freq.	Reading Level	Correct Factor	Measurement	Limit	Margin	Detector	Comment
		MHz	dBuV	dB	dBuV/m	dBuV/m	dB		
1	*	10398.87	53.92	0.79	54.71	68.30	-13.59	peak	

REMARKS:

- (1) Measurement Value = Reading Level + Correct Factor.
- (2) Margin Level = Measurement Value - Limit Value.

Orthogonal Axis	X		
Test Mode	UNII-1_TX AX (HE20) Mode 5200 MHz	RU configuration	242/61

Horizontal

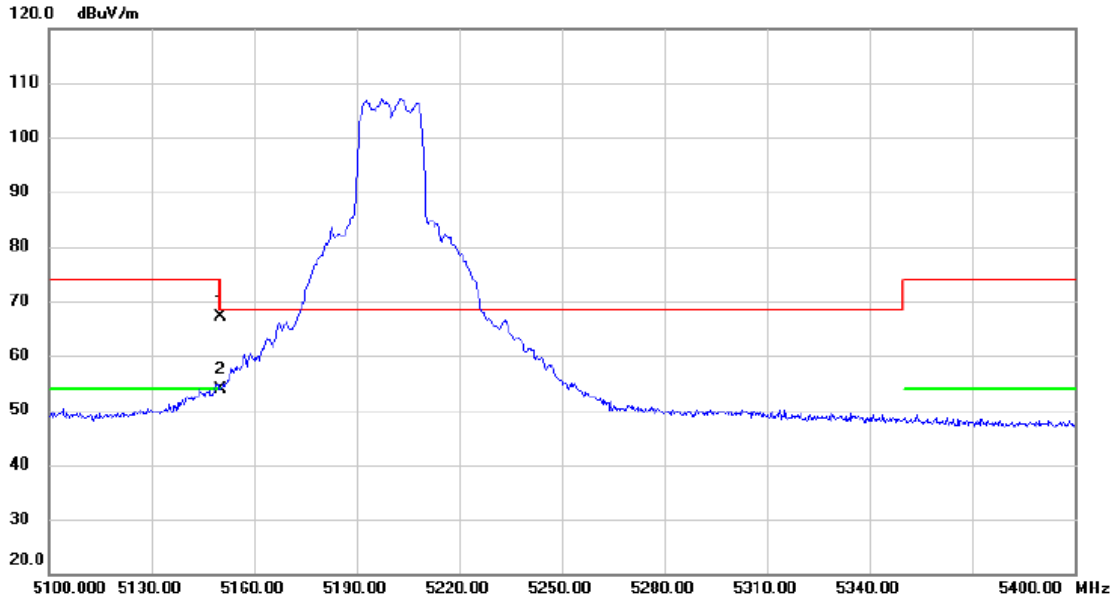

No.	Mk.	Freq. MHz	Reading Level dBuV	Correct Factor dB	Measure- ment dBuV/m	Limit dBuV/m	Margin dB	Detector	Comment
1		5150.000	26.48	40.53	67.01	74.00	-6.99	peak	
2	*	5150.000	13.32	40.53	53.85	54.00	-0.15	AVG	

REMARKS:

- (1) Measurement Value = Reading Level + Correct Factor.
- (2) Margin Level = Measurement Value - Limit Value.

Orthogonal Axis	X		
Test Mode	UNII-1_TX AX (HE20) Mode 5200 MHz	RU configuration	242/61

Horizontal

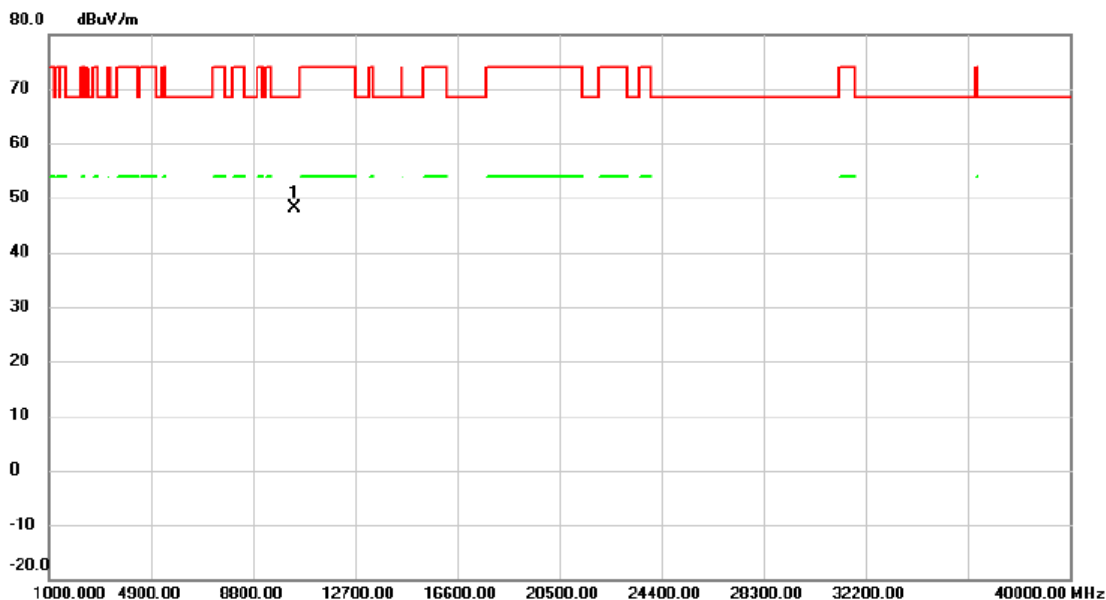

No.	Mk.	Freq.	Reading Level	Correct Factor	Measurement	Limit	Margin	Detector	Comment
		MHz	dBuV	dB	dBuV/m	dBuV/m	dB		
1	*	10402.30	47.23	0.81	48.04	68.30	-20.26	peak	

REMARKS:

- (1) Measurement Value = Reading Level + Correct Factor.
- (2) Margin Level = Measurement Value - Limit Value.

Orthogonal Axis	X		
Test Mode	UNII-1_TX AX (HE20) Mode 5240 MHz	RU configuration	52/38

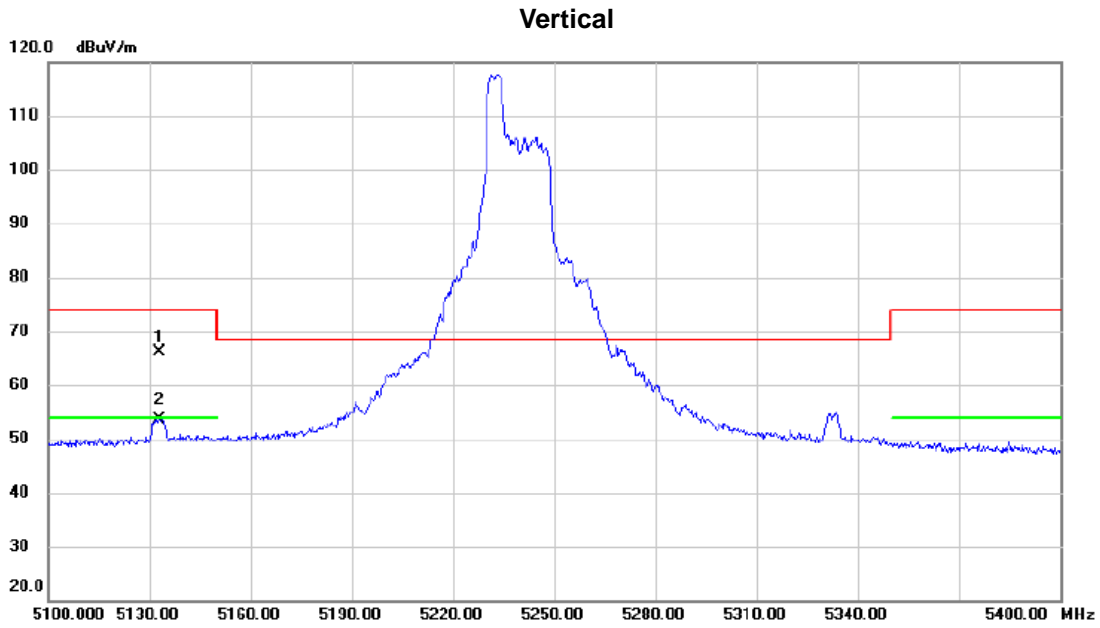

No.	Mk.	Freq. MHz	Reading Level dBuV	Correct Factor dB	Measure- ment dBuV/m	Limit dBuV/m	Margin dB	Detector	Comment
1		5133.150	25.74	40.50	66.24	74.00	-7.76	peak	
2	*	5133.150	13.16	40.50	53.66	54.00	-0.34	AVG	

REMARKS:

- (1) Measurement Value = Reading Level + Correct Factor.
- (2) Margin Level = Measurement Value - Limit Value.

Orthogonal Axis	X		
Test Mode	UNII-1_TX AX (HE20) Mode 5240 MHz	RU configuration	52/38

Horizontal

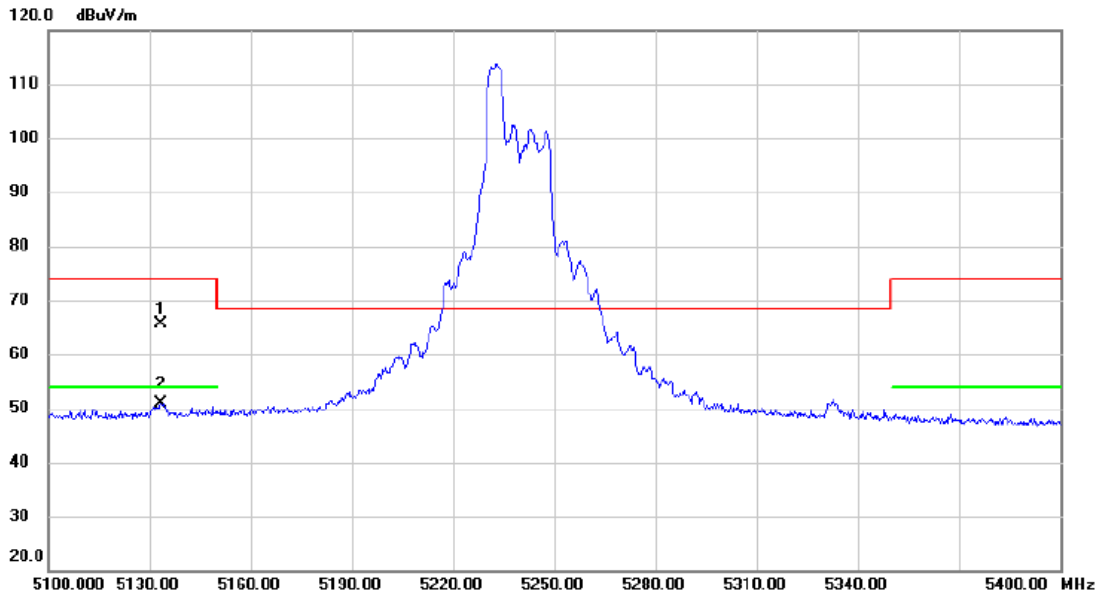

No.	Mk.	Freq. MHz	Reading Level dBuV	Correct Factor dB	Measure- ment dBuV/m	Limit dBuV/m	Margin dB	Detector	Comment
1		5133.450	25.07	40.50	65.57	74.00	-8.43	peak	
2	*	5133.450	10.34	40.50	50.84	54.00	-3.16	AVG	

REMARKS:

- (1) Measurement Value = Reading Level + Correct Factor.
- (2) Margin Level = Measurement Value - Limit Value.

Orthogonal Axis	X		
Test Mode	UNII-1_TX AX (HE20) Mode 5240 MHz	RU configuration	106/54

Vertical

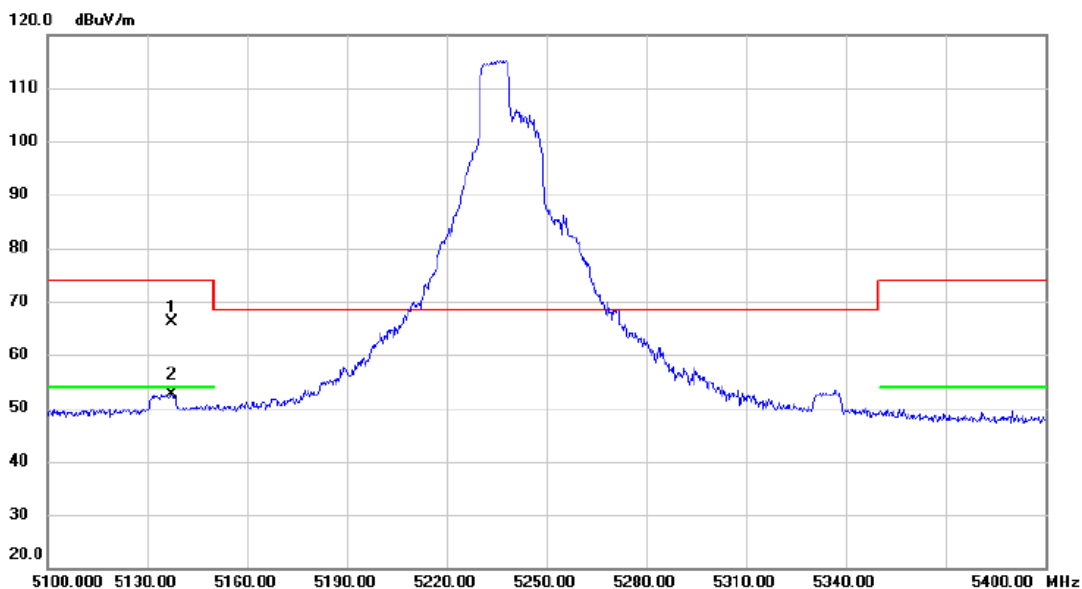

No. Mk.	Freq. MHz	Reading Level dBuV	Correct Factor dB	Measurement dBuV/m	Limit dBuV/m	Margin dB	Detector	Comment
1	5137.500	25.68	40.50	66.18	74.00	-7.82	peak	
2 *	5137.500	12.07	40.50	52.57	54.00	-1.43	AVG	

REMARKS:

- (1) Measurement Value = Reading Level + Correct Factor.
- (2) Margin Level = Measurement Value - Limit Value.

Orthogonal Axis	X		
Test Mode	UNII-1_TX AX (HE20) Mode 5240 MHz	RU configuration	106/54

Horizontal

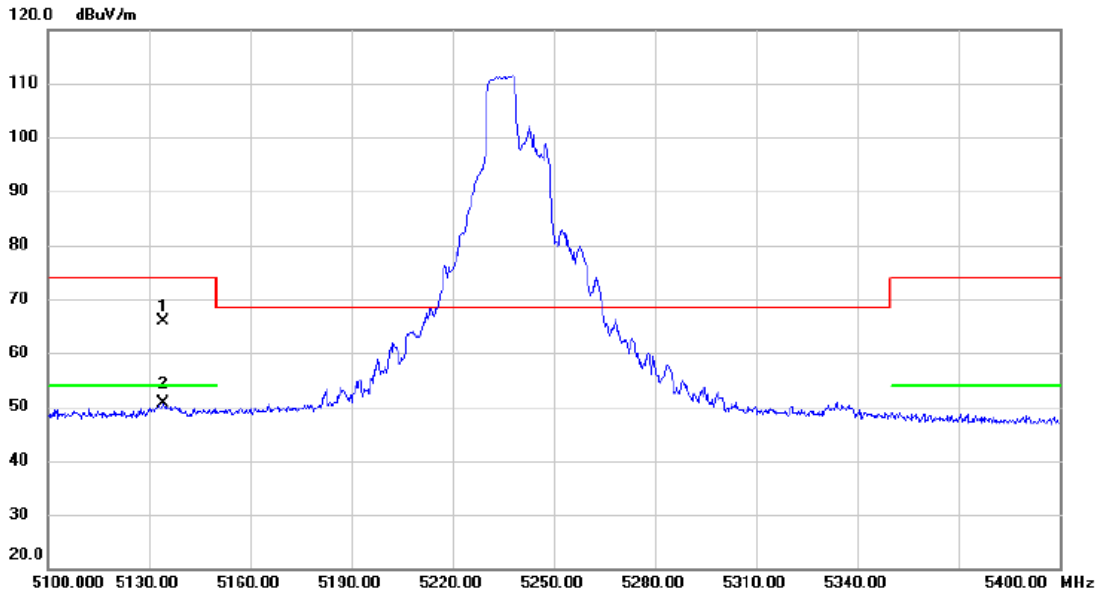

No.	Mk.	Freq. MHz	Reading Level dBuV	Correct Factor dB	Measure- ment dBuV/m	Limit dBuV/m	Margin dB	Detector	Comment
1		5134.350	25.32	40.50	65.82	74.00	-8.18	peak	
2	*	5134.350	10.11	40.50	50.61	54.00	-3.39	AVG	

REMARKS:

- (1) Measurement Value = Reading Level + Correct Factor.
- (2) Margin Level = Measurement Value - Limit Value.

Orthogonal Axis	X		
Test Mode	UNII-1_TX AX (HE20) Mode 5240 MHz	RU configuration	242/61

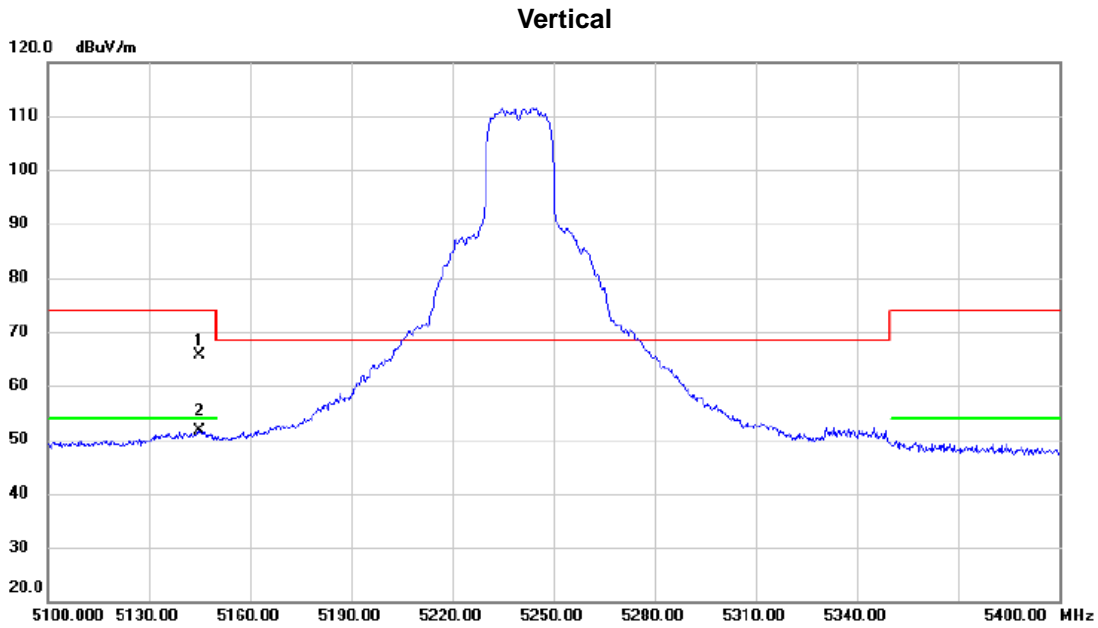

No.	Mk.	Freq. MHz	Reading Level dBuV	Correct Factor dB	Measure- ment dBuV/m	Limit dBuV/m	Margin dB	Detector	Comment
1		5144.850	25.16	40.51	65.67	74.00	-8.33	peak	
2	*	5144.850	11.21	40.51	51.72	54.00	-2.28	AVG	

REMARKS:

- (1) Measurement Value = Reading Level + Correct Factor.
- (2) Margin Level = Measurement Value - Limit Value.

Orthogonal Axis	X		
Test Mode	UNII-1_TX AX (HE20) Mode 5240 MHz	RU configuration	242/61

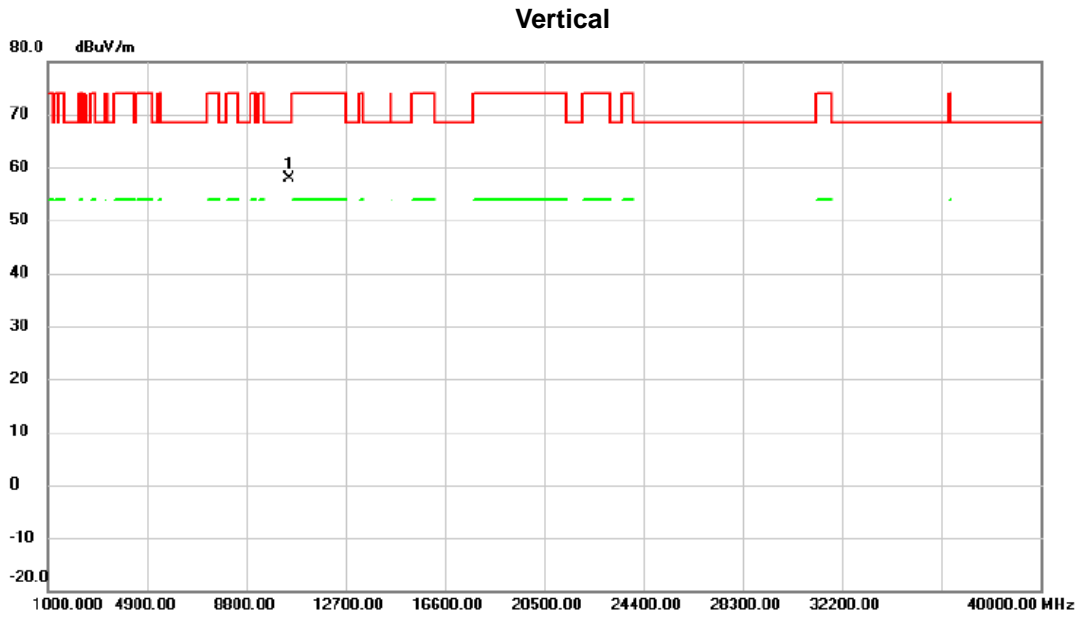

No.	Mk.	Freq.	Reading Level	Correct Factor	Measurement	Limit	Margin	Detector	Comment
		MHz	dBuV	dB	dBuV/m	dBuV/m	dB		
1	*	10478.76	56.78	1.05	57.83	68.30	-10.47	peak	

REMARKS:

- (1) Measurement Value = Reading Level + Correct Factor.
- (2) Margin Level = Measurement Value - Limit Value.

Orthogonal Axis	X		
Test Mode	UNII-1_TX AX (HE20) Mode 5240 MHz	RU configuration	242/61

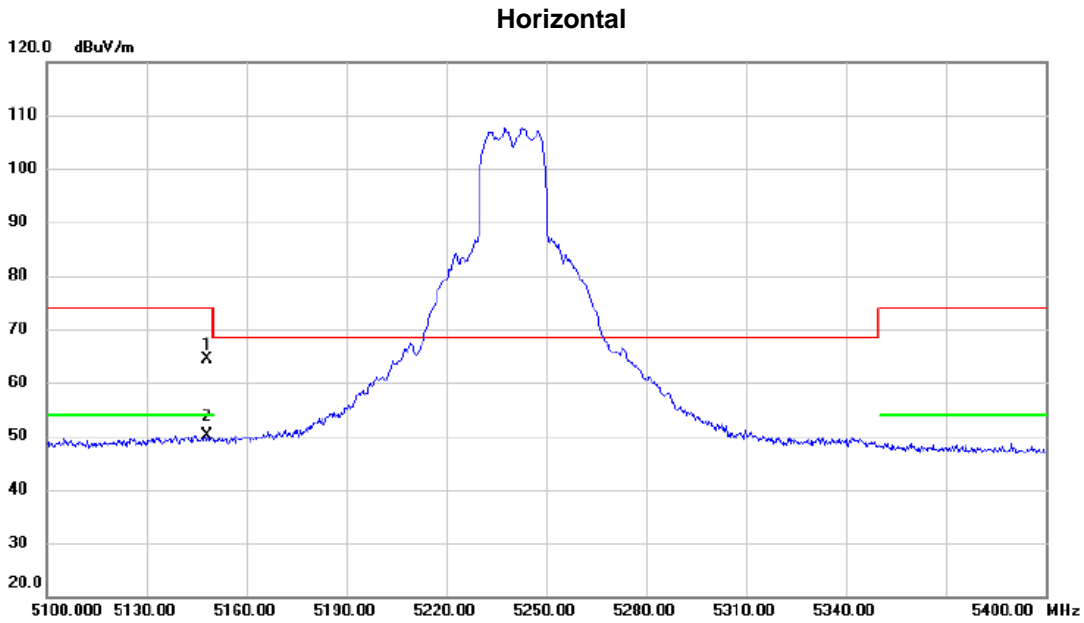

No. Mk.	Freq. MHz	Reading Level dBuV	Correct Factor dB	Measure- ment dBuV/m	Limit dBuV/m	Margin dB	Detector	Comment
1	5148.000	23.97	40.53	64.50	74.00	-9.50	peak	
2 *	5148.000	9.62	40.53	50.15	54.00	-3.85	AVG	

REMARKS:

- (1) Measurement Value = Reading Level + Correct Factor.
- (2) Margin Level = Measurement Value - Limit Value.

Orthogonal Axis	X		
Test Mode	UNII-1_TX AX (HE20) Mode 5240 MHz	RU configuration	242/61

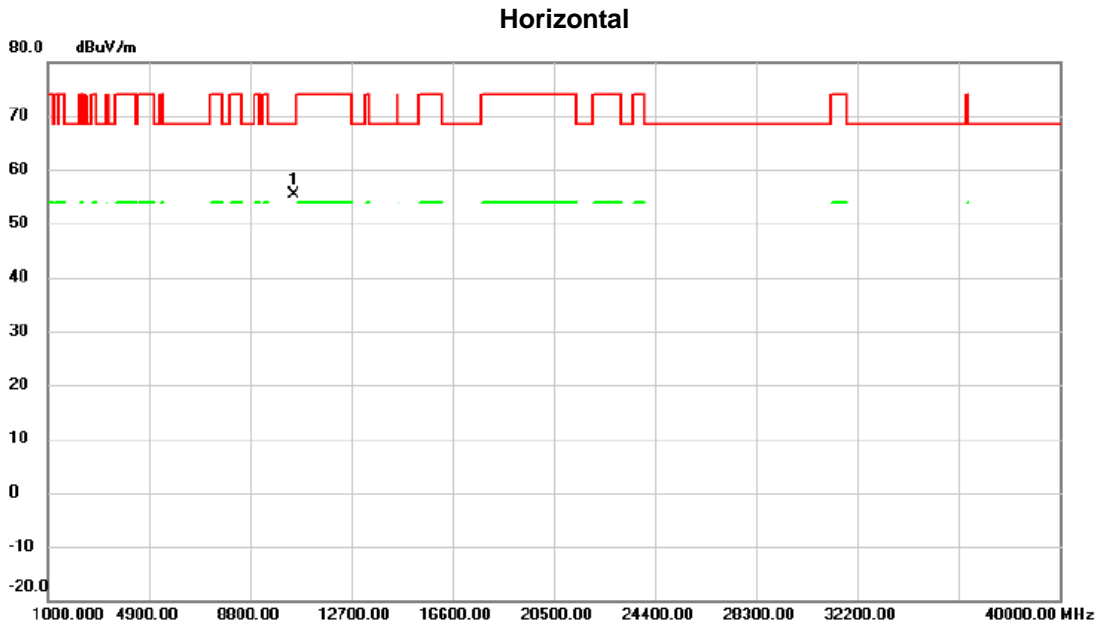

No.	Mk.	Freq.	Reading Level	Correct Factor	Measurement	Limit	Margin	Detector	Comment
		MHz	dBuV	dB	dBuV/m	dBuV/m	dB		
1	*	10478.86	54.37	1.05	55.42	68.30	-12.88	peak	

REMARKS:

- (1) Measurement Value = Reading Level + Correct Factor.
- (2) Margin Level = Measurement Value - Limit Value.

Orthogonal Axis	X		
Test Mode	UNII-3_TX AX (HE20) Mode 5745 MHz	RU configuration	52/38

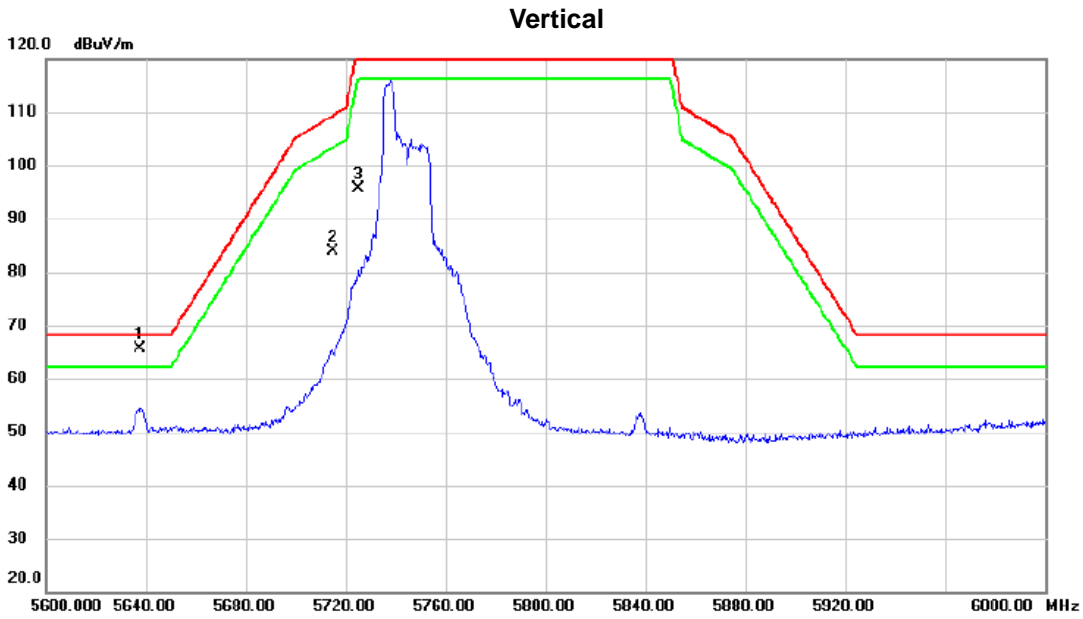

No.	Mk.	Freq. MHz	Reading Level dBuV	Correct Factor dB	Measure- ment dBuV/m	Limit dBuV/m	Margin dB	Detector	Comment
1	*	5637.800	24.05	41.47	65.52	68.20	-2.68	peak	
2		5715.000	42.36	41.58	83.94	109.40	-25.46	peak	
3		5725.000	53.96	41.60	95.56	122.20	-26.64	peak	

REMARKS:

- (1) Measurement Value = Reading Level + Correct Factor.
- (2) Margin Level = Measurement Value - Limit Value.

Orthogonal Axis	X		
Test Mode	UNII-3_TX AX (HE20) Mode 5745 MHz	RU configuration	52/38

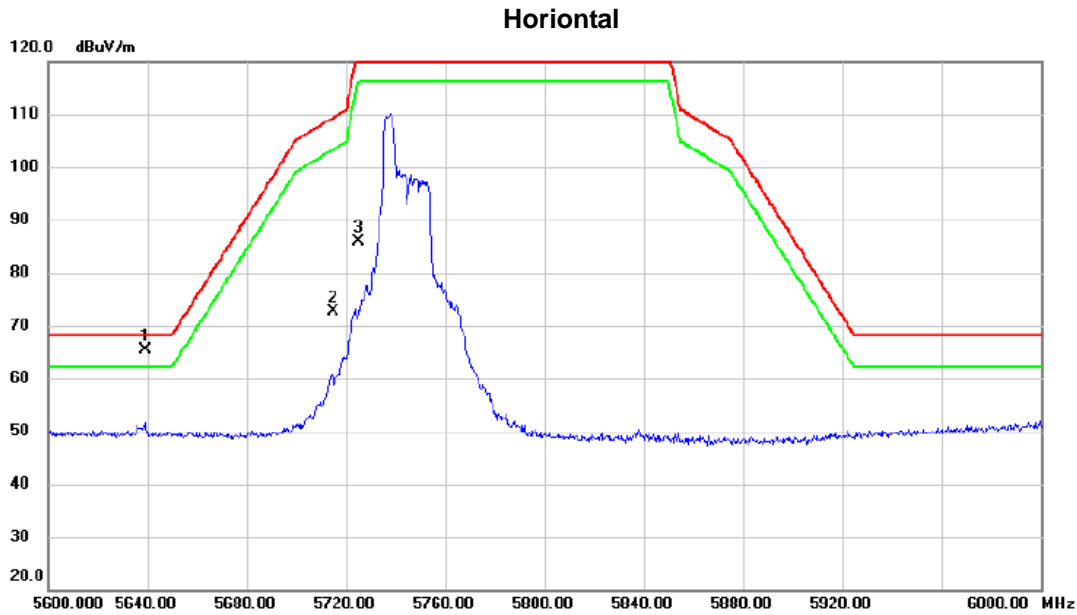

No. Mk.	Freq. MHz	Reading Level dBuV	Correct Factor dB	Measurement dBuV/m	Limit dBuV/m	Margin dB	Detector	Comment
1 *	5639.000	23.93	41.47	65.40	68.20	-2.80	peak	
2	5715.000	31.01	41.58	72.59	109.40	-36.81	peak	
3	5725.000	44.37	41.60	85.97	122.20	-36.23	peak	

REMARKS:

- (1) Measurement Value = Reading Level + Correct Factor.
- (2) Margin Level = Measurement Value - Limit Value.

Orthogonal Axis	X		
Test Mode	UNII-3_TX AX (HE20) Mode 5745 MHz	RU configuration	106/54

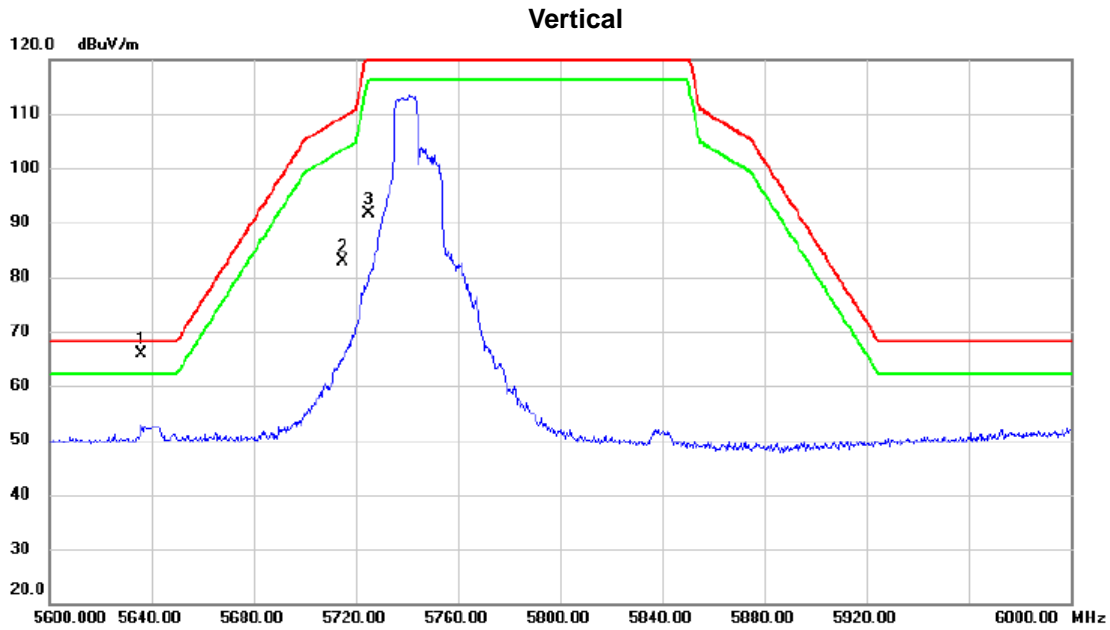

No.	Mk.	Freq. MHz	Reading Level dBuV	Correct Factor dB	Measure- ment dBuV/m	Limit dBuV/m	Margin dB	Detector	Comment
1	*	5636.200	24.38	41.47	65.85	68.20	-2.35	peak	
2		5715.000	41.24	41.58	82.82	109.40	-26.58	peak	
3		5725.000	49.96	41.60	91.56	122.20	-30.64	peak	

REMARKS:

- (1) Measurement Value = Reading Level + Correct Factor.
- (2) Margin Level = Measurement Value - Limit Value.

Orthogonal Axis	X		
Test Mode	UNII-3_TX AX (HE20) Mode 5745 MHz	RU configuration	106/54

Horizontal

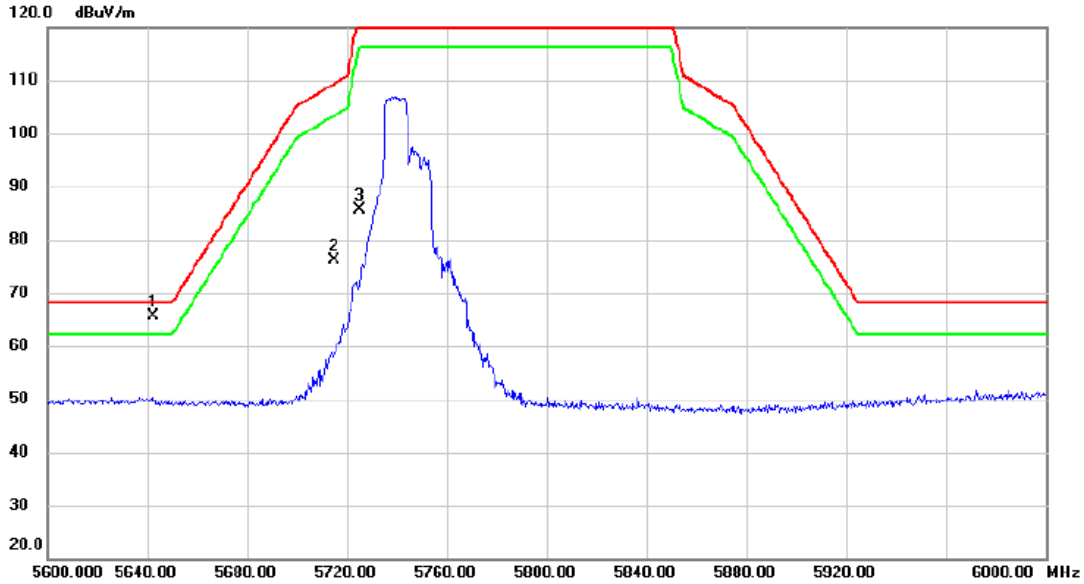

No. Mk.	Freq. MHz	Reading Level dBuV	Correct Factor dB	Measurement dBuV/m	Limit dBuV/m	Margin dB	Detector	Comment
1 *	5642.600	24.20	41.47	65.67	68.20	-2.53	peak	
2	5715.000	34.53	41.58	76.11	109.40	-33.29	peak	
3	5725.000	43.99	41.60	85.59	122.20	-36.61	peak	

REMARKS:

- (1) Measurement Value = Reading Level + Correct Factor.
- (2) Margin Level = Measurement Value - Limit Value.

Orthogonal Axis	X		
Test Mode	UNII-3_TX AX (HE20) Mode 5745 MHz	RU configuration	242/61

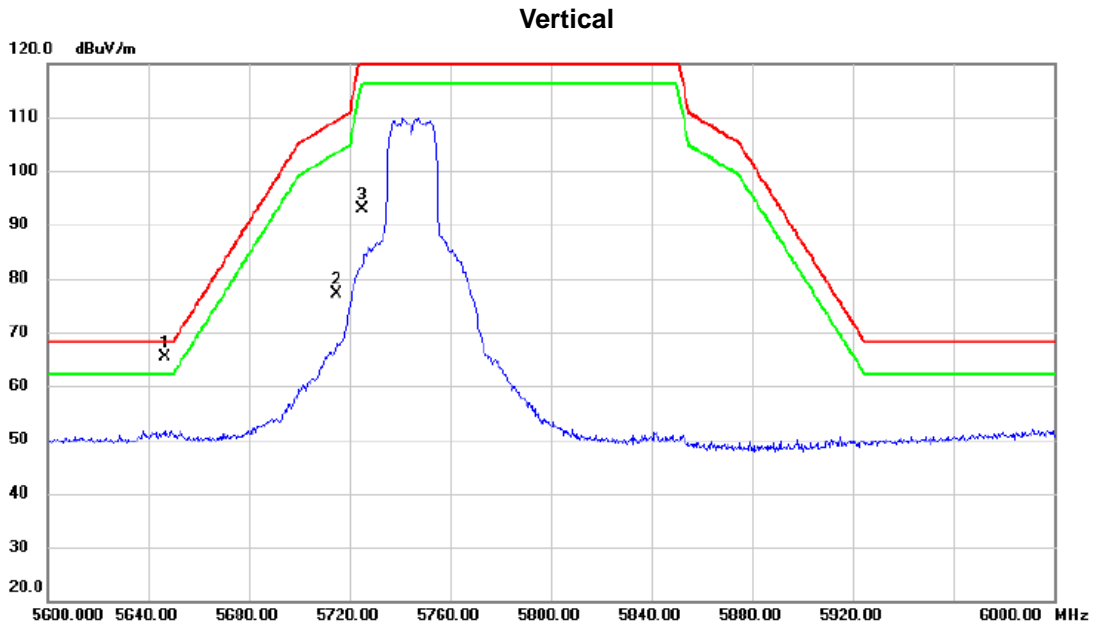

No.	Mk.	Freq. MHz	Reading Level dBuV	Correct Factor dB	Measure- ment dBuV/m	Limit dBuV/m	Margin dB	Detector	Comment
1	*	5646.800	23.89	41.48	65.37	68.20	-2.83	peak	
2		5715.000	35.55	41.58	77.13	109.40	-32.27	peak	
3		5725.000	51.16	41.60	92.76	122.20	-29.44	peak	

REMARKS:

- (1) Measurement Value = Reading Level + Correct Factor.
- (2) Margin Level = Measurement Value - Limit Value.

Orthogonal Axis	X		
Test Mode	UNII-3_TX AX (HE20) Mode 5745 MHz	RU configuration	242/61

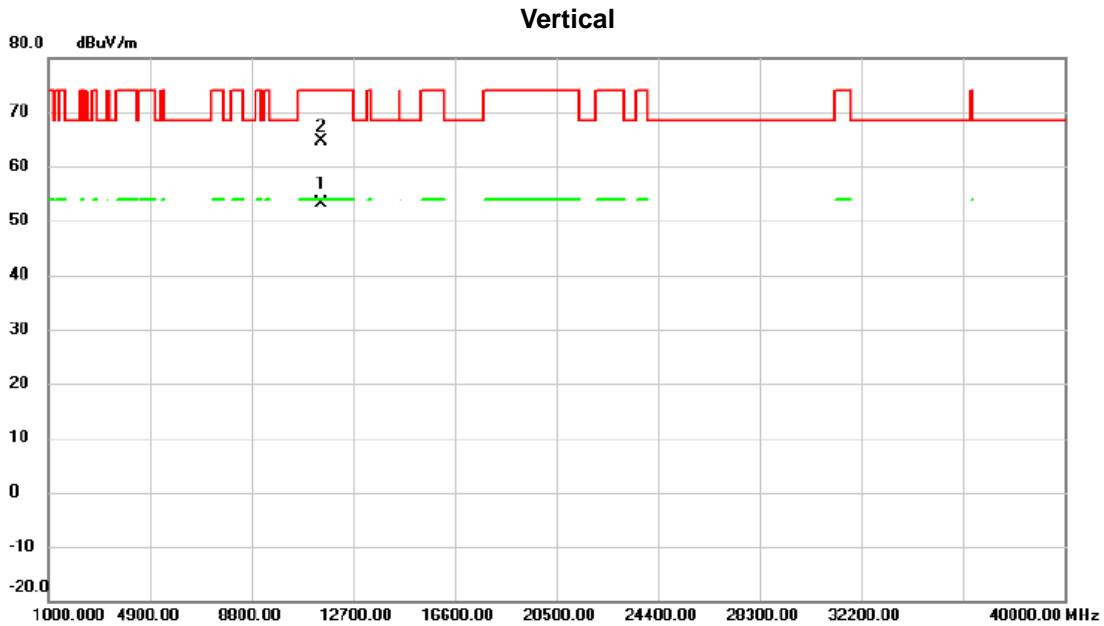

No.	Mk.	Freq. MHz	Reading Level dBuV	Correct Factor dB	Measure- ment dBuV/m	Limit dBuV/m	Margin dB	Detector	Comment
1	*	11500.95	50.99	2.18	53.17	54.00	-0.83	AVG	
2		11501.77	62.33	2.18	64.51	74.00	-9.49	peak	

REMARKS:

- (1) Measurement Value = Reading Level + Correct Factor.
- (2) Margin Level = Measurement Value - Limit Value.

Orthogonal Axis	X		
Test Mode	UNII-3_TX AX (HE20) Mode 5745 MHz	RU configuration	242/61

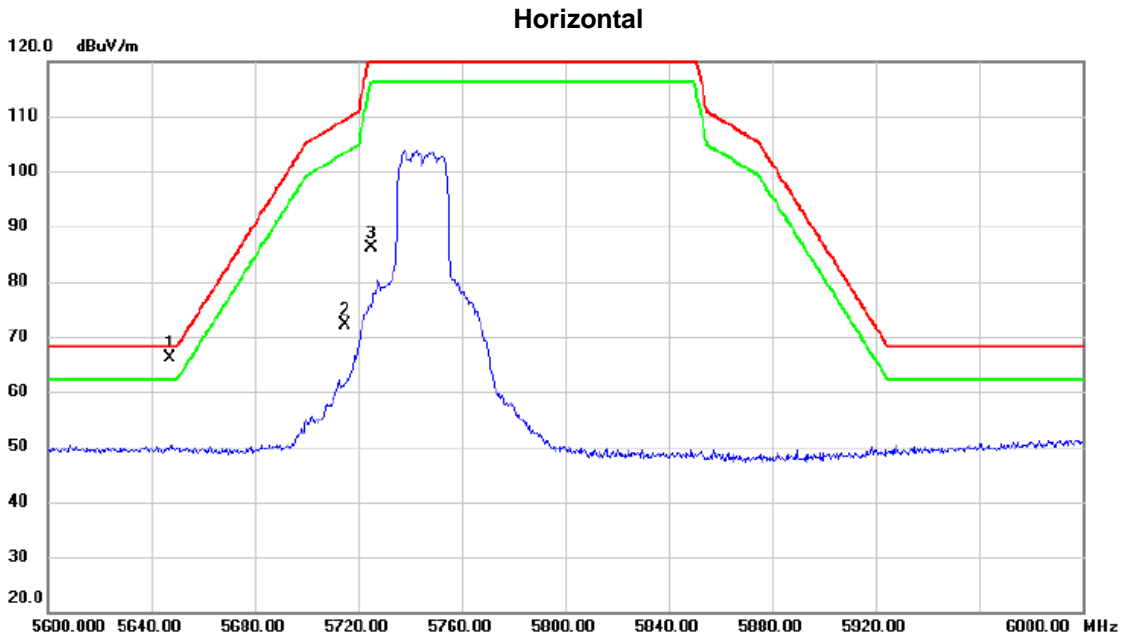

No.	Mk.	Freq. MHz	Reading Level dBuV	Correct Factor dB	Measure- ment dBuV/m	Limit dBuV/m	Margin dB	Detector	Comment
1	*	5647.400	24.66	41.48	66.14	68.20	-2.06	peak	
2		5715.000	30.47	41.58	72.05	109.40	-37.35	peak	
3		5725.000	44.53	41.60	86.13	122.20	-36.07	peak	

REMARKS:

- (1) Measurement Value = Reading Level + Correct Factor.
- (2) Margin Level = Measurement Value - Limit Value.

Orthogonal Axis	X		
Test Mode	UNII-3_TX AX (HE20) Mode 5745 MHz	RU configuration	242/61

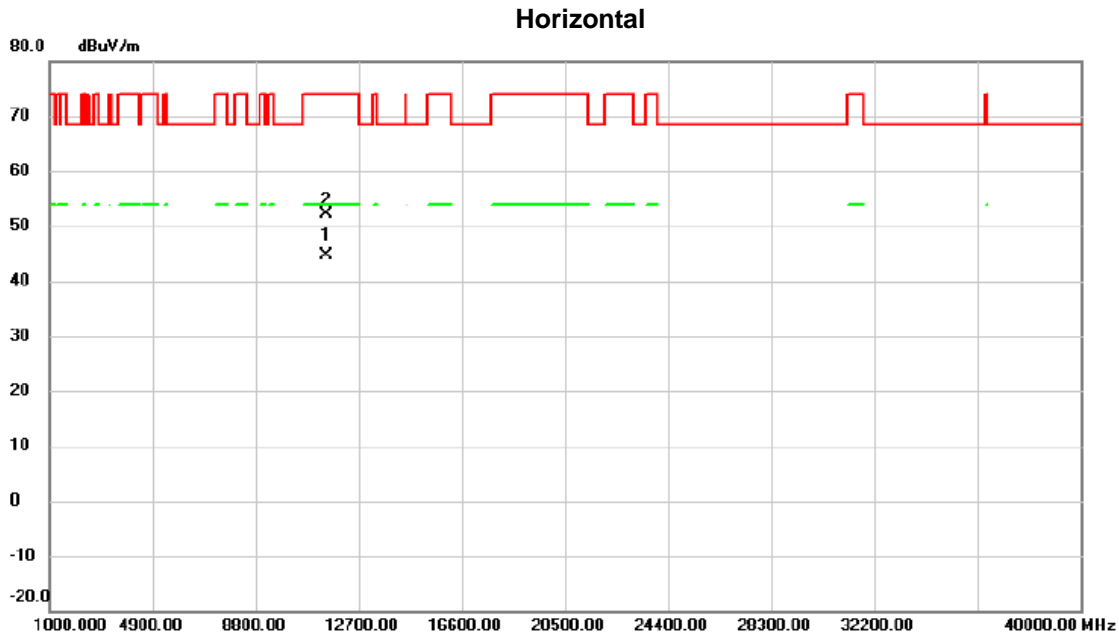

No.	Mk.	Freq. MHz	Reading Level dBuV	Correct Factor dB	Measure- ment dBuV/m	Limit dBuV/m	Margin dB	Detector	Comment
1	*	11500.75	42.48	2.18	44.66	54.00	-9.34	AVG	
2		11501.75	49.96	2.18	52.14	74.00	-21.86	peak	

REMARKS:

- (1) Measurement Value = Reading Level + Correct Factor.
- (2) Margin Level = Measurement Value - Limit Value.

Orthogonal Axis	X		
Test Mode	UNII-3_TX AX (HE20) Mode 5785 MHz	RU configuration	52/38

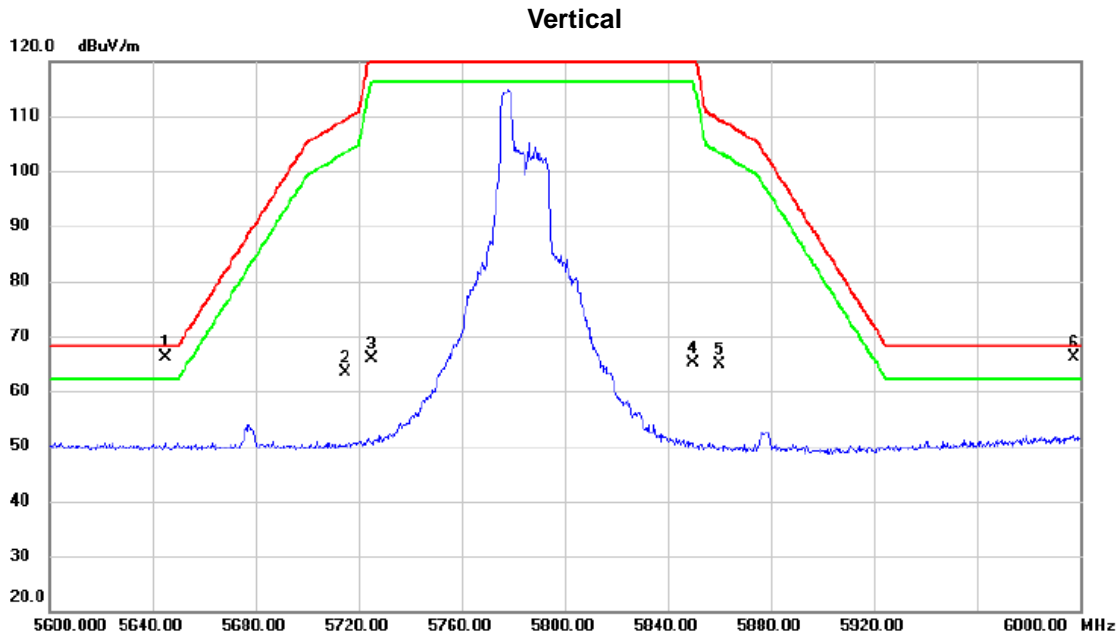

No.	Mk.	Freq. MHz	Reading Level dBuV	Correct Factor dB	Measure- ment dBuV/m	Limit dBuV/m	Margin dB	Detector	Comment
1	*	5645.000	24.70	41.48	66.18	68.20	-2.02	peak	
2		5715.000	21.87	41.58	63.45	109.40	-45.95	peak	
3		5725.000	24.16	41.60	65.76	122.20	-56.44	peak	
4		5850.000	23.21	41.80	65.01	122.20	-57.19	peak	
5		5860.000	23.02	41.81	64.83	109.40	-44.57	peak	
6	!	5997.800	24.01	42.03	66.04	68.20	-2.16	peak	

REMARKS:

- (1) Measurement Value = Reading Level + Correct Factor.
- (2) Margin Level = Measurement Value - Limit Value.

Orthogonal Axis	X		
Test Mode	UNII-3_TX AX (HE20) Mode 5785 MHz	RU configuration	52/38

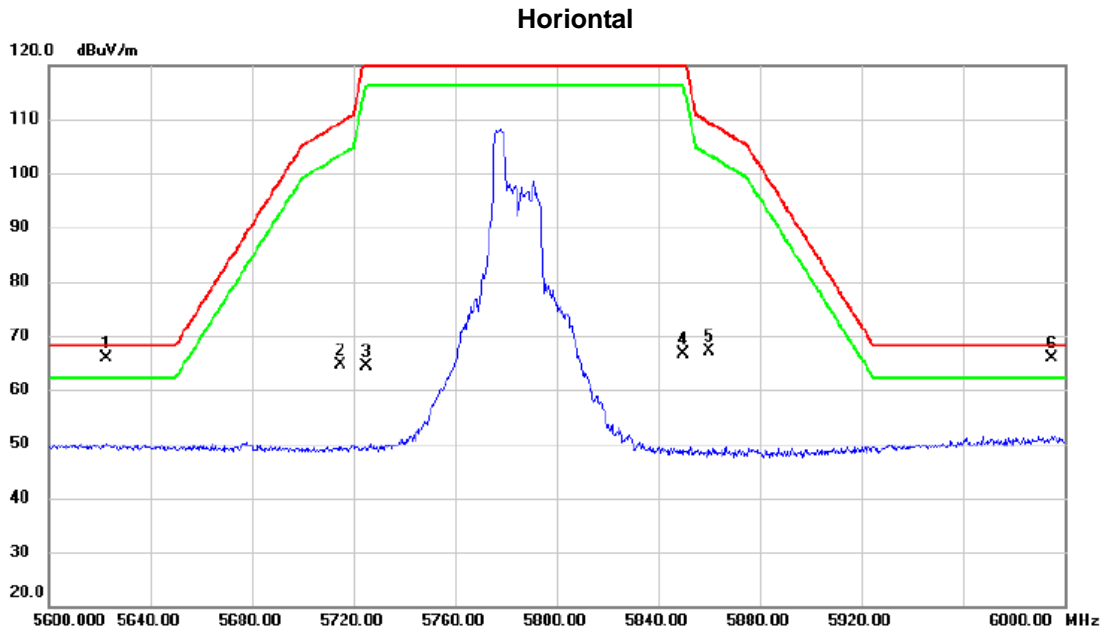

No.	Mk.	Freq. MHz	Reading Level dBuV	Correct Factor dB	Measure- ment dBuV/m	Limit dBuV/m	Margin dB	Detector	Comment
1	*	5622.800	24.48	41.44	65.92	68.20	-2.28	peak	
2		5715.000	23.04	41.58	64.62	109.40	-44.78	peak	
3		5725.000	22.71	41.60	64.31	122.20	-57.89	peak	
4		5850.000	24.76	41.80	66.56	122.20	-55.64	peak	
5		5860.000	25.40	41.81	67.21	109.40	-42.19	peak	
6	!	5995.200	23.90	42.02	65.92	68.20	-2.28	peak	

REMARKS:

- (1) Measurement Value = Reading Level + Correct Factor.
- (2) Margin Level = Measurement Value - Limit Value.

Orthogonal Axis	X		
Test Mode	UNII-3_TX AX (HE20) Mode 5785 MHz	RU configuration	106/54

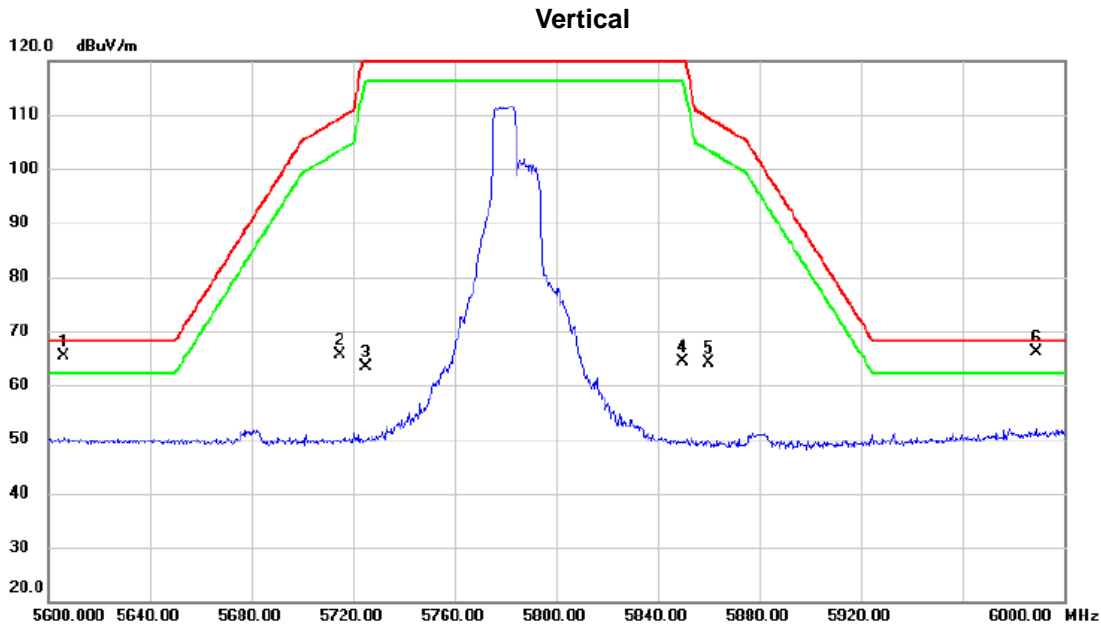

No.	Mk.	Freq. MHz	Reading Level dBuV	Correct Factor dB	Measure- ment dBuV/m	Limit dBuV/m	Margin dB	Detector	Comment
1	!	5606.200	23.89	41.42	65.31	68.20	-2.89	peak	
2		5715.000	24.14	41.58	65.72	109.40	-43.68	peak	
3		5725.000	21.75	41.60	63.35	122.20	-58.85	peak	
4		5850.000	22.63	41.80	64.43	122.20	-57.77	peak	
5		5860.000	22.23	41.81	64.04	109.40	-45.36	peak	
6	*	5989.000	24.03	42.02	66.05	68.20	-2.15	peak	

REMARKS:

- (1) Measurement Value = Reading Level + Correct Factor.
- (2) Margin Level = Measurement Value - Limit Value.

Orthogonal Axis	X		
Test Mode	UNII-3_TX AX (HE20) Mode 5785 MHz	RU configuration	106/54

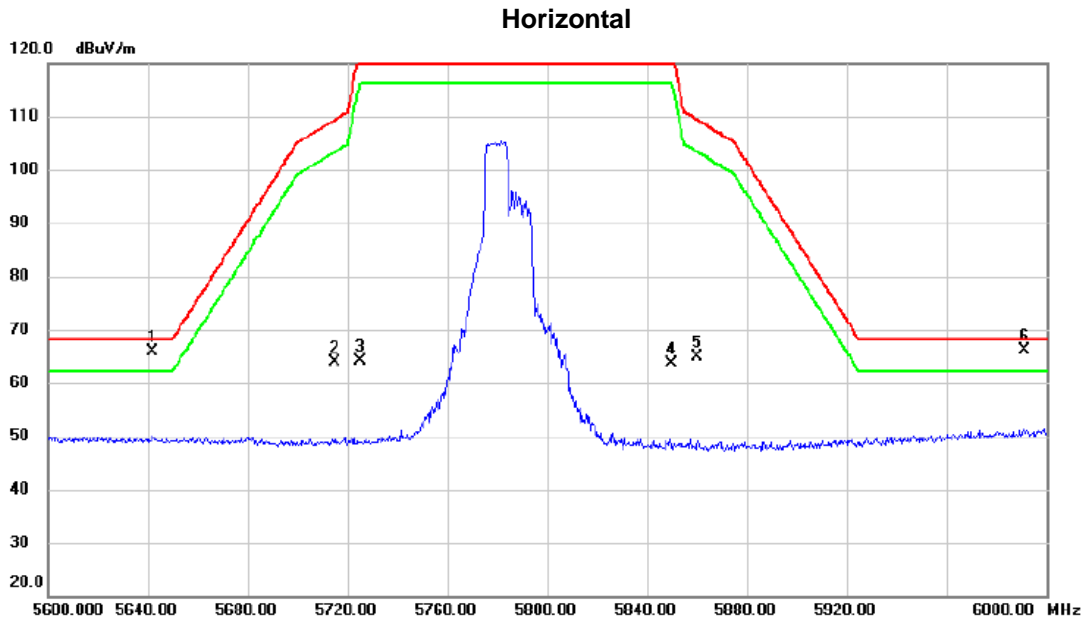

No. Mk.	Freq. MHz	Reading Level dBuV	Correct Factor dB	Measurement dBuV/m	Limit dBuV/m	Margin dB	Detector	Comment
1 !	5642.000	24.37	41.47	65.84	68.20	-2.36	peak	
2	5715.000	22.41	41.58	63.99	109.40	-45.41	peak	
3	5725.000	22.57	41.60	64.17	122.20	-58.03	peak	
4	5850.000	21.88	41.80	63.68	122.20	-58.52	peak	
5	5860.000	23.11	41.81	64.92	109.40	-44.48	peak	
6 *	5991.200	24.10	42.02	66.12	68.20	-2.08	peak	

REMARKS:

- (1) Measurement Value = Reading Level + Correct Factor.
- (2) Margin Level = Measurement Value - Limit Value.

Orthogonal Axis	X		
Test Mode	UNII-3_TX AX (HE20) Mode 5785 MHz	RU configuration	242/61

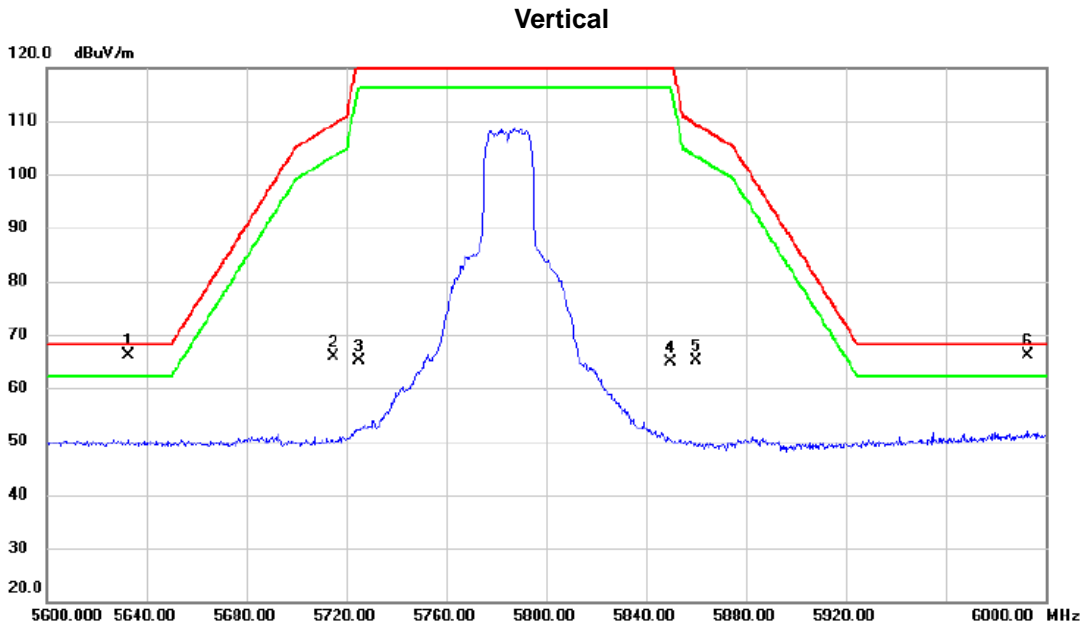

No.	Mk.	Freq. MHz	Reading Level dBuV	Correct Factor dB	Measurement dBuV/m	Limit dBuV/m	Margin dB	Detector	Comment
1	*	5632.600	24.66	41.46	66.12	68.20	-2.08	peak	
2		5715.000	24.38	41.58	65.96	109.40	-43.44	peak	
3		5725.000	23.52	41.60	65.12	122.20	-57.08	peak	
4		5850.000	23.00	41.80	64.80	122.20	-57.40	peak	
5		5860.000	23.23	41.81	65.04	109.40	-44.36	peak	
6	!	5993.000	24.08	42.02	66.10	68.20	-2.10	peak	

REMARKS:

(1) Measurement Value = Reading Level + Correct Factor.

(2) Margin Level = Measurement Value - Limit Value.

Orthogonal Axis	X		
Test Mode	UNII-3_TX AX (HE20) Mode 5785 MHz	RU configuration	242/61

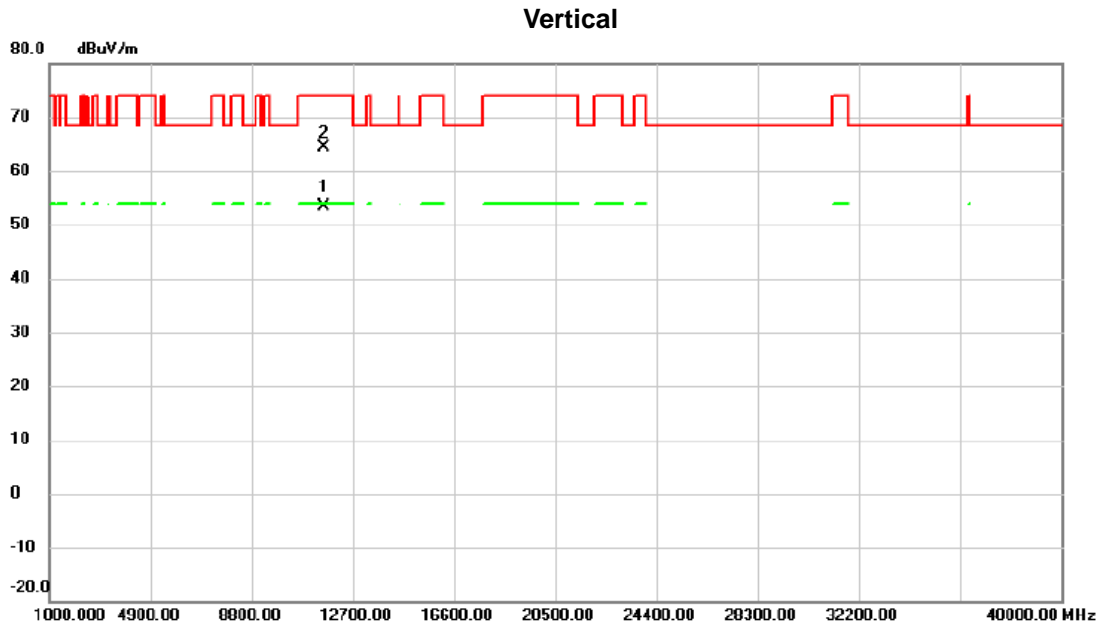

No.	Mk.	Freq. MHz	Reading Level dBuV	Correct Factor dB	Measure- ment dBuV/m	Limit dBuV/m	Margin dB	Detector	Comment
1	*	11580.47	51.23	2.09	53.32	54.00	-0.68	AVG	
2		11581.52	62.39	2.09	64.48	74.00	-9.52	peak	

REMARKS:

- (1) Measurement Value = Reading Level + Correct Factor.
- (2) Margin Level = Measurement Value - Limit Value.

Orthogonal Axis	X		
Test Mode	UNII-3_TX AX (HE20) Mode 5785 MHz	RU configuration	242/61

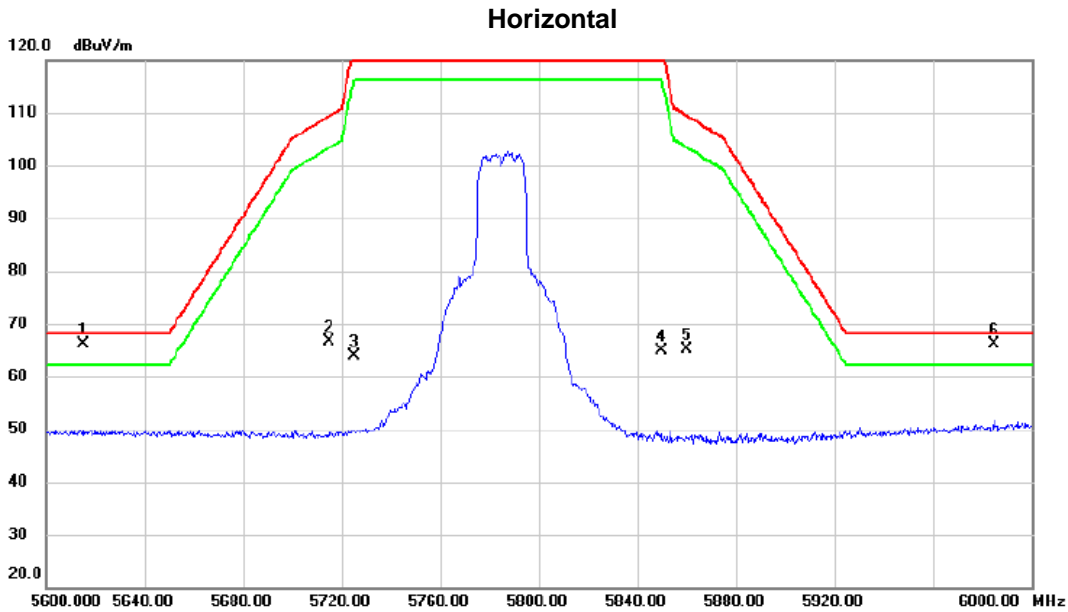

No.	Mk.	Freq. MHz	Reading Level dBuV	Correct Factor dB	Measure- ment dBuV/m	Limit dBuV/m	Margin dB	Detector	Comment
1	*	5615.200	24.79	41.43	66.22	68.20	-1.98	peak	
2		5715.000	24.99	41.58	66.57	109.40	-42.83	peak	
3		5725.000	22.34	41.60	63.94	122.20	-58.26	peak	
4		5850.000	22.97	41.80	64.77	122.20	-57.43	peak	
5		5860.000	23.38	41.81	65.19	109.40	-44.21	peak	
6	!	5984.600	24.02	42.00	66.02	68.20	-2.18	peak	

REMARKS:

- (1) Measurement Value = Reading Level + Correct Factor.
- (2) Margin Level = Measurement Value - Limit Value.

Orthogonal Axis	X		
Test Mode	UNII-3_TX AX (HE20) Mode 5785 MHz	RU configuration	242/61

Horizontal

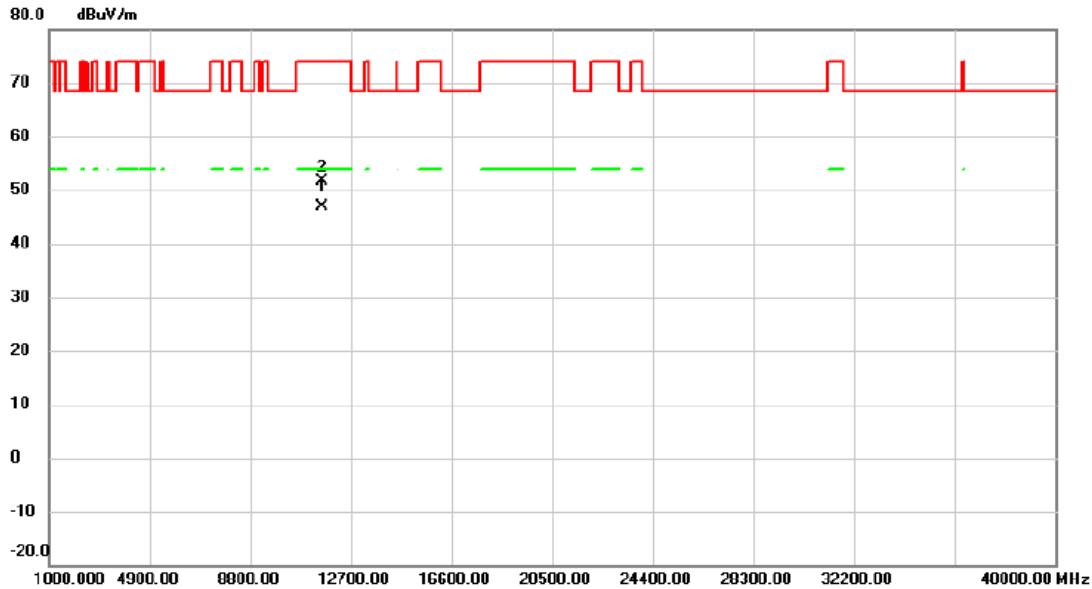

No.	Mk.	Freq. MHz	Reading Level dBuV	Correct Factor dB	Measure- ment dBuV/m	Limit dBuV/m	Margin dB	Detector	Comment
1	*	11566.22	44.65	2.11	46.76	54.00	-7.24	AVG	
2		11577.17	49.41	2.10	51.51	74.00	-22.49	peak	

REMARKS:

- (1) Measurement Value = Reading Level + Correct Factor.
- (2) Margin Level = Measurement Value - Limit Value.

Orthogonal Axis	X		
Test Mode	UNII-3_TX AX (HE20) Mode 5825 MHz	RU configuration	52/38

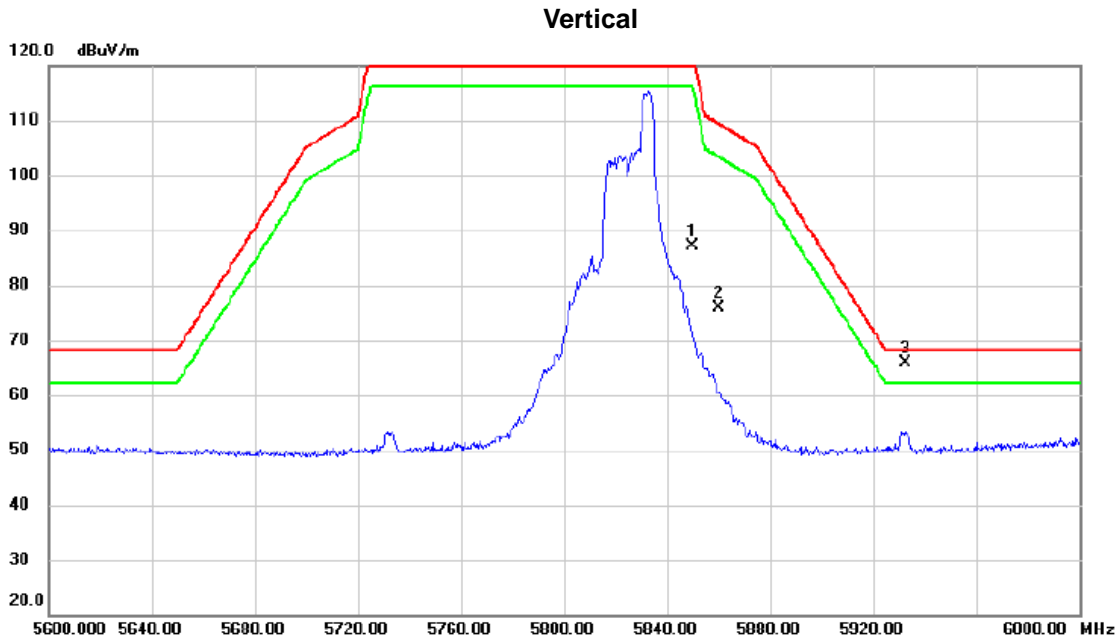

No.	Mk.	Freq. MHz	Reading Level dBuV	Correct Factor dB	Measure- ment dBuV/m	Limit dBuV/m	Margin dB	Detector	Comment
1		5850.000	45.22	41.80	87.02	122.20	-35.18	peak	
2		5860.000	34.10	41.81	75.91	109.40	-33.49	peak	
3	*	5932.600	23.95	41.93	65.88	68.20	-2.32	peak	

REMARKS:

- (1) Measurement Value = Reading Level + Correct Factor.
- (2) Margin Level = Measurement Value - Limit Value.

Orthogonal Axis	X		
Test Mode	UNII-3_TX AX (HE20) Mode 5825 MHz	RU configuration	52/38

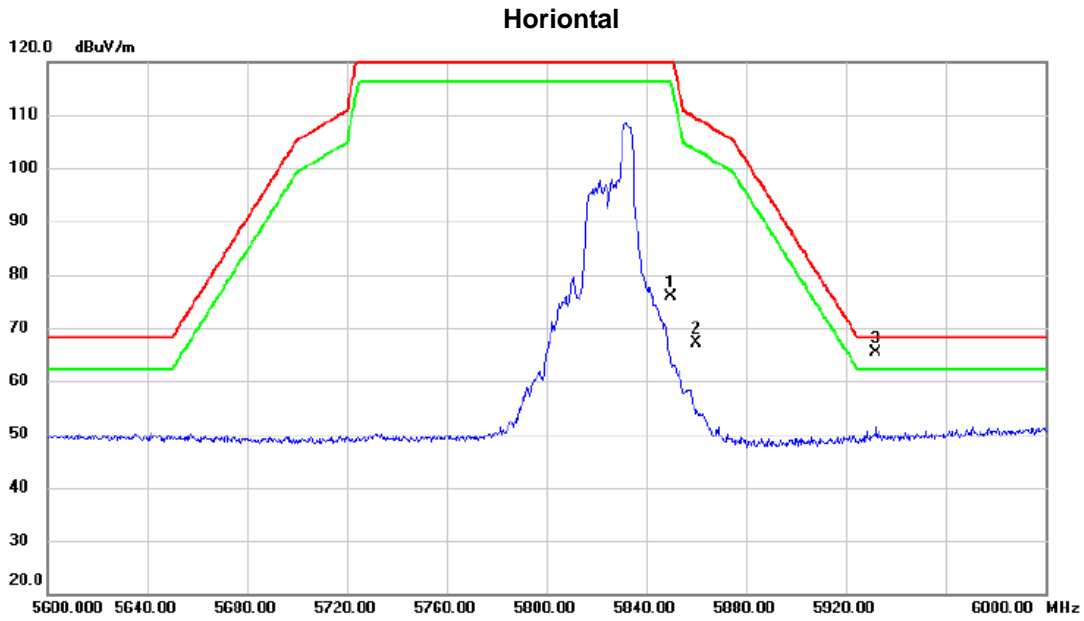

No.	Mk.	Freq. MHz	Reading Level dBuV	Correct Factor dB	Measure- ment dBuV/m	Limit dBuV/m	Margin dB	Detector	Comment
1		5850.000	34.02	41.80	75.82	122.20	-46.38	peak	
2		5860.000	25.31	41.81	67.12	109.40	-42.28	peak	
3	*	5932.200	23.48	41.93	65.41	68.20	-2.79	peak	

REMARKS:

- (1) Measurement Value = Reading Level + Correct Factor.
- (2) Margin Level = Measurement Value - Limit Value.

Orthogonal Axis	X		
Test Mode	UNII-3_TX AX (HE20) Mode 5825 MHz	RU configuration	106/54

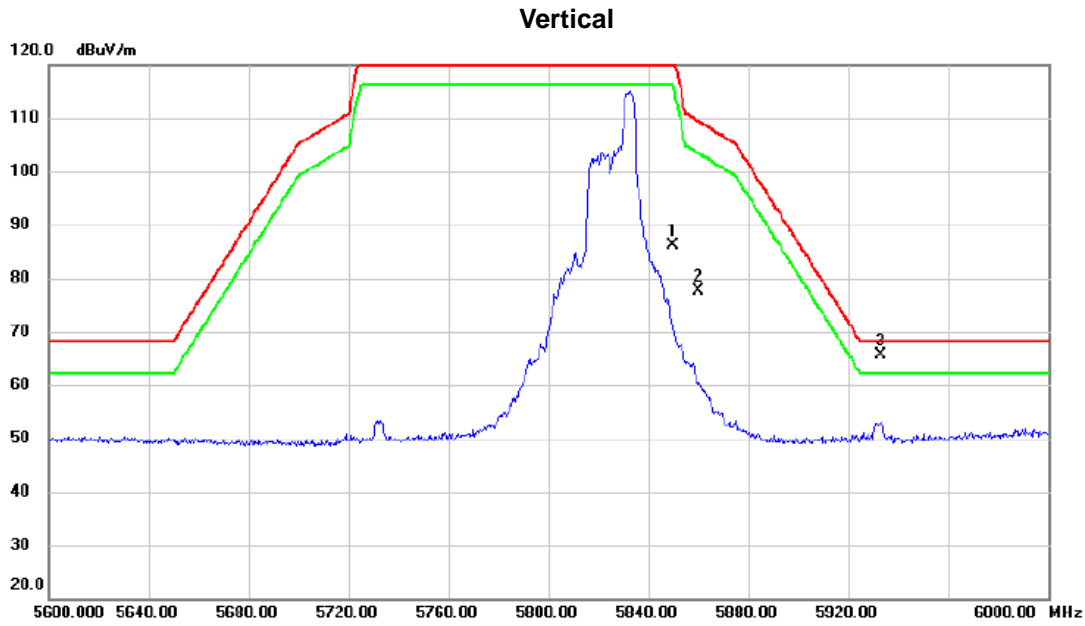

No. Mk.	Freq. MHz	Reading Level dBuV	Correct Factor dB	Measurement dBuV/m	Limit dBuV/m	Margin dB	Detector	Comment
1	5850.000	44.22	41.80	86.02	122.20	-36.18	peak	
2	5860.000	35.86	41.81	77.67	109.40	-31.73	peak	
3 *	5933.000	23.67	41.93	65.60	68.20	-2.60	peak	

REMARKS:

- (1) Measurement Value = Reading Level + Correct Factor.
- (2) Margin Level = Measurement Value - Limit Value.

Orthogonal Axis	X		
Test Mode	UNII-3_TX AX (HE20) Mode 5825 MHz	RU configuration	106/54

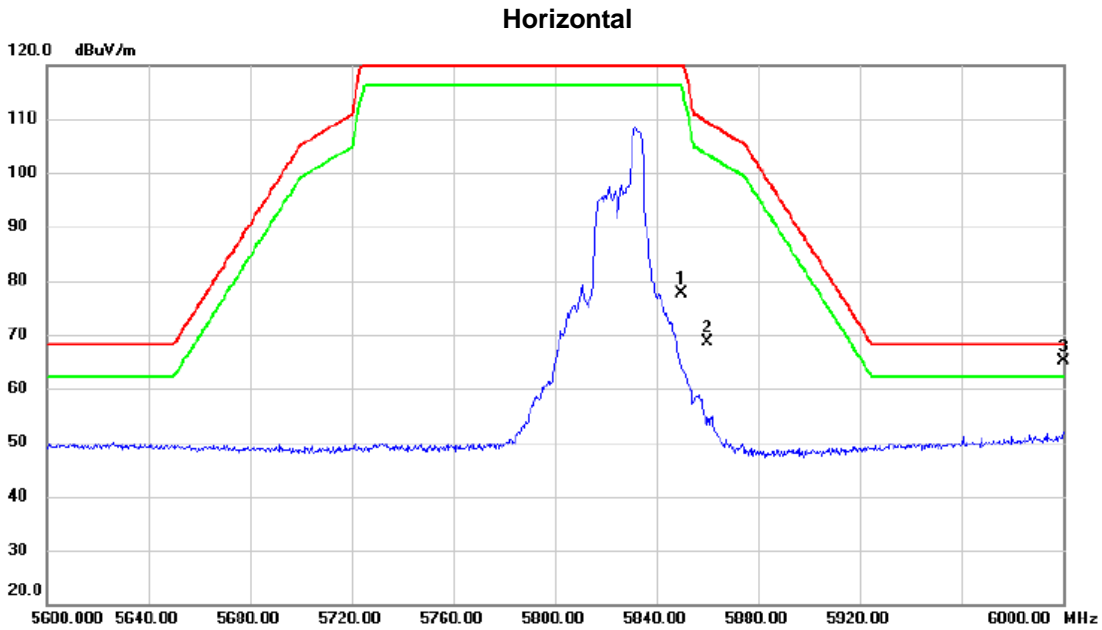

No.	Mk.	Freq. MHz	Reading Level dBuV	Correct Factor dB	Measure- ment dBuV/m	Limit dBuV/m	Margin dB	Detector	Comment
1		5850.000	35.84	41.80	77.64	122.20	-44.56	peak	
2		5860.000	26.85	41.81	68.66	109.40	-40.74	peak	
3	*	6000.000	23.10	42.03	65.13	68.20	-3.07	peak	

REMARKS:

- (1) Measurement Value = Reading Level + Correct Factor.
- (2) Margin Level = Measurement Value - Limit Value.

Orthogonal Axis	X		
Test Mode	UNII-3_TX AX (HE20) Mode 5825 MHz	RU configuration	242/61

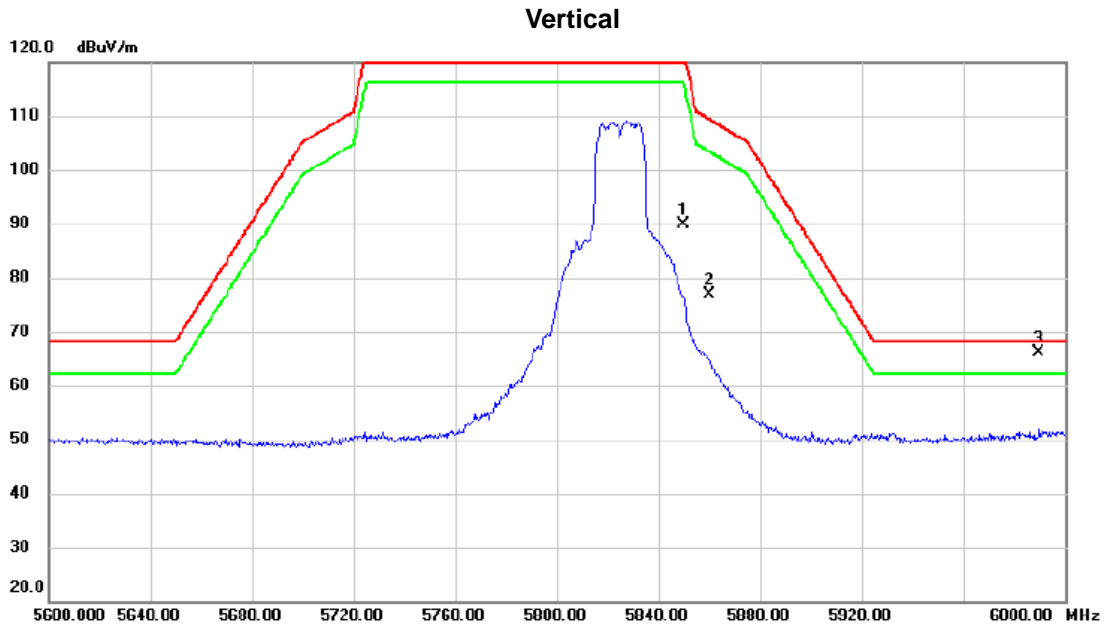

No.	Mk.	Freq. MHz	Reading Level dBuV	Correct Factor dB	Measure- ment dBuV/m	Limit dBuV/m	Margin dB	Detector	Comment
1		5850.000	48.11	41.80	89.91	122.20	-32.29	peak	
2		5860.000	35.12	41.81	76.93	109.40	-32.47	peak	
3	*	5989.600	24.12	42.02	66.14	68.20	-2.06	peak	

REMARKS:

- (1) Measurement Value = Reading Level + Correct Factor.
- (2) Margin Level = Measurement Value - Limit Value.

Orthogonal Axis	X		
Test Mode	UNII-3_TX AX (HE20) Mode 5825 MHz	RU configuration	242/61

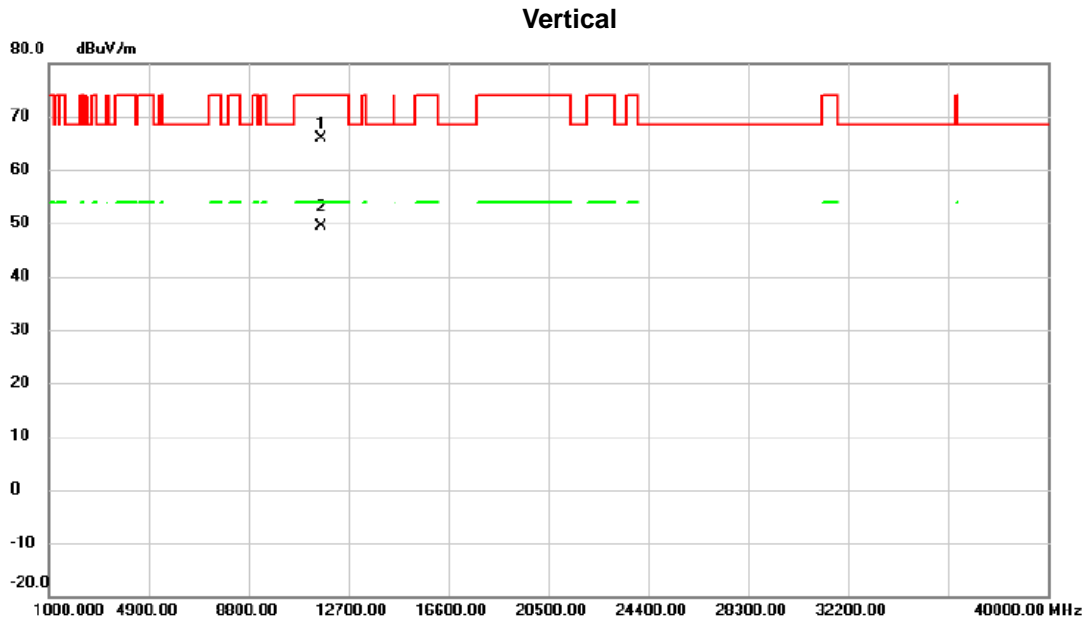

No.	Mk.	Freq.	Reading Level	Correct Factor	Measurement	Limit	Margin	Detector	Comment
		MHz	dBuV	dB	dBuV/m	dBuV/m	dB		
1		11647.85	63.73	2.03	65.76	74.00	-8.24	peak	
2	*	11648.62	47.41	2.02	49.43	54.00	-4.57	AVG	

REMARKS:

- (1) Measurement Value = Reading Level + Correct Factor.
- (2) Margin Level = Measurement Value - Limit Value.

Orthogonal Axis	X		
Test Mode	UNII-3_TX AX (HE20) Mode 5825 MHz	RU configuration	242/61

Horizontal

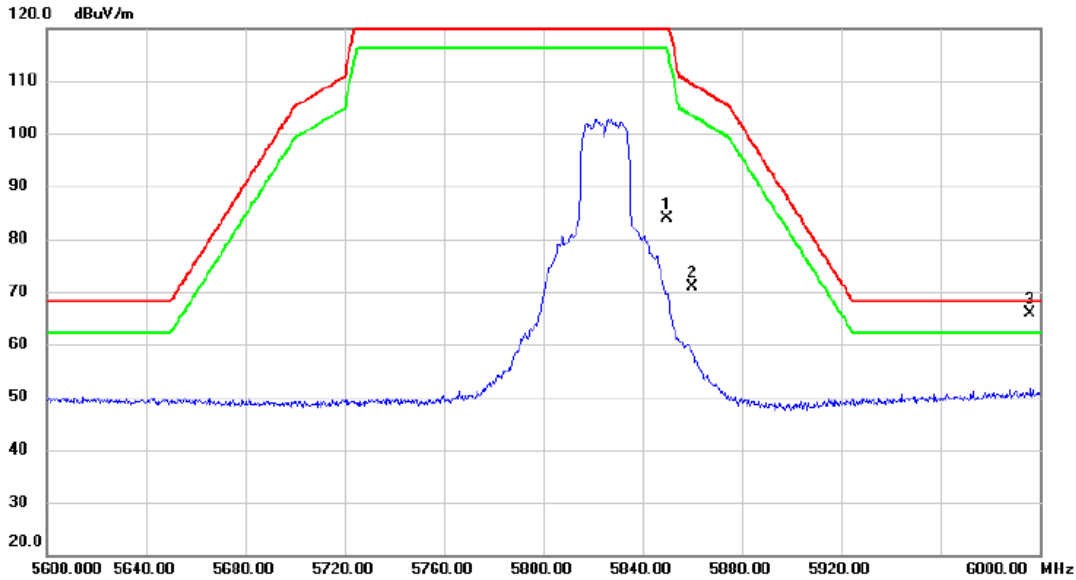

No. Mk.	Freq. MHz	Reading Level dBuV	Correct Factor dB	Measurement dBuV/m	Limit dBuV/m	Margin dB	Detector	Comment
1	5850.000	41.99	41.80	83.79	122.20	-38.41	peak	
2	5860.000	29.16	41.81	70.97	109.40	-38.43	peak	
3 *	5996.200	23.82	42.03	65.85	68.20	-2.35	peak	

REMARKS:

- (1) Measurement Value = Reading Level + Correct Factor.
- (2) Margin Level = Measurement Value - Limit Value.

Orthogonal Axis	X		
Test Mode	UNII-3_TX AX (HE20) Mode 5825 MHz	RU configuration	242/61

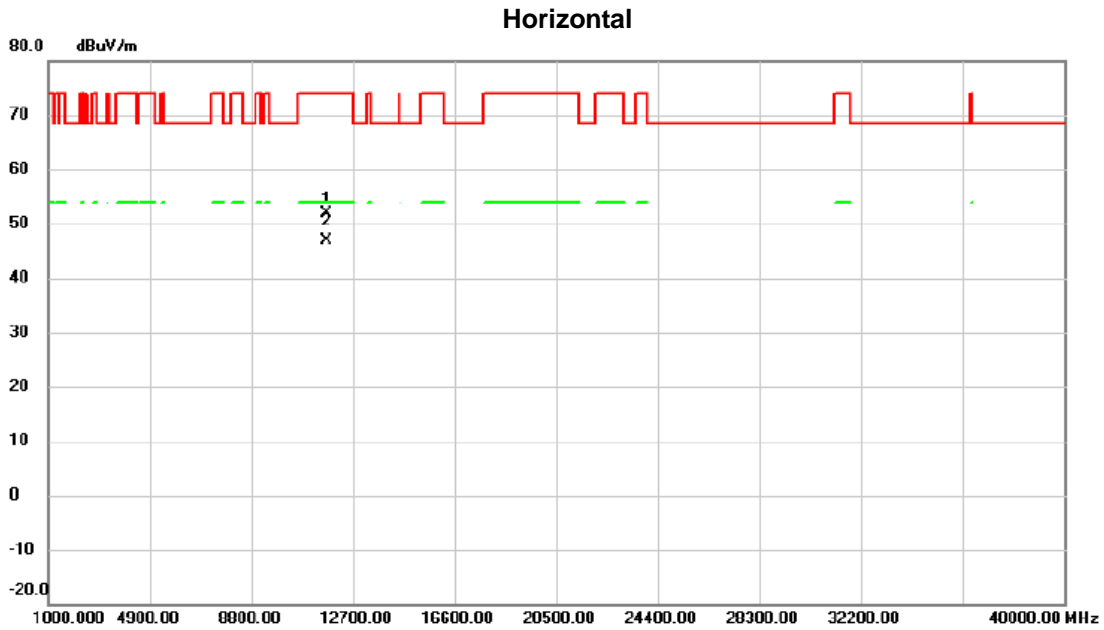

No.	Mk.	Freq. MHz	Reading Level dBuV	Correct Factor dB	Measure- ment dBuV/m	Limit dBuV/m	Margin dB	Detector	Comment
1		11662.25	49.81	2.00	51.81	74.00	-22.19	peak	
2	*	11662.52	44.99	2.00	46.99	54.00	-7.01	AVG	

REMARKS:

- (1) Measurement Value = Reading Level + Correct Factor.
- (2) Margin Level = Measurement Value - Limit Value.

Orthogonal Axis	X		
Test Mode	UNII-1_TX AX (HE40) Mode 5190 MHz	RU configuration	52/37

Vertical

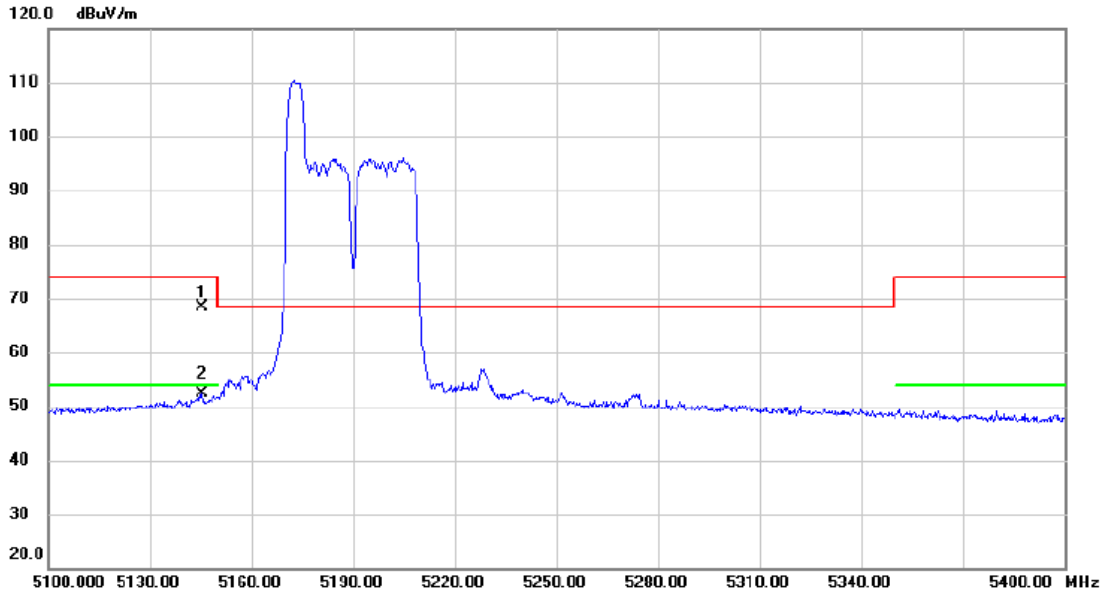

No.	Mk.	Freq.	Reading Level	Correct Factor	Measurement	Limit	Margin	Detector	Comment
		MHz	dBuV	dB	dBuV/m	dBuV/m	dB		
1		5145.450	27.82	40.51	68.33	74.00	-5.67	peak	
2	*	5145.450	11.90	40.51	52.41	54.00	-1.59	AVG	

REMARKS:

- (1) Measurement Value = Reading Level + Correct Factor.
- (2) Margin Level = Measurement Value - Limit Value.

Orthogonal Axis	X		
Test Mode	UNII-1_TX AX (HE40) Mode 5190 MHz	RU configuration	52/37

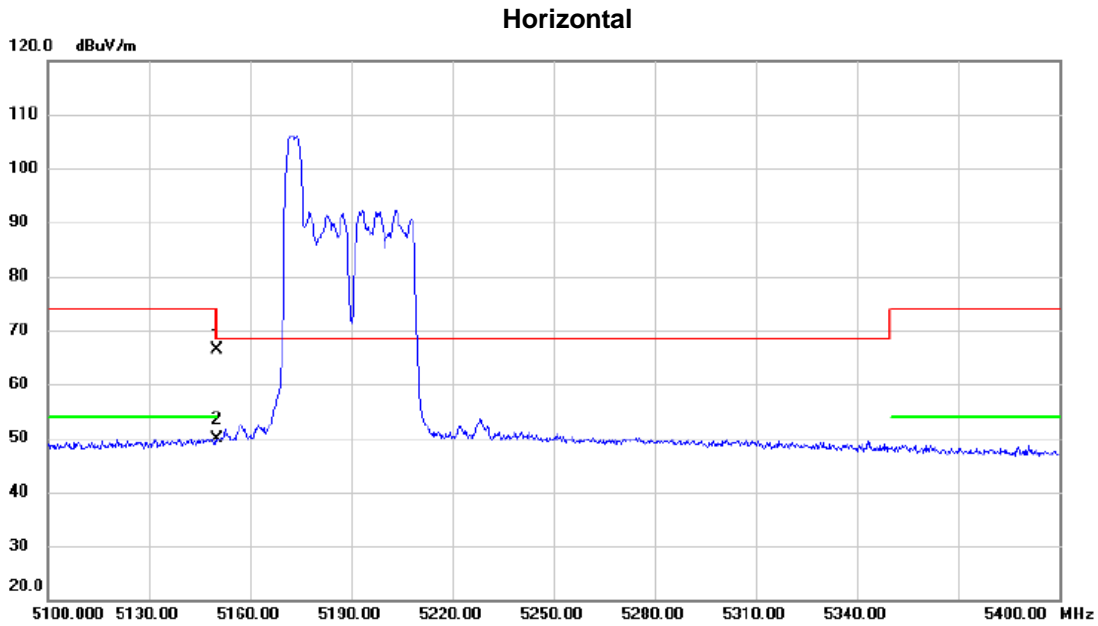

No.	Mk.	Freq. MHz	Reading Level dBuV	Correct Factor dB	Measure- ment dBuV/m	Limit dBuV/m	Margin dB	Detector	Comment
1		5150.000	25.77	40.53	66.30	74.00	-7.70	peak	
2	*	5150.000	9.23	40.53	49.76	54.00	-4.24	AVG	

REMARKS:

- (1) Measurement Value = Reading Level + Correct Factor.
- (2) Margin Level = Measurement Value - Limit Value.

Orthogonal Axis	X		
Test Mode	UNII-1_TX AX (HE40) Mode 5190 MHz	RU configuration	106/54

Vertical

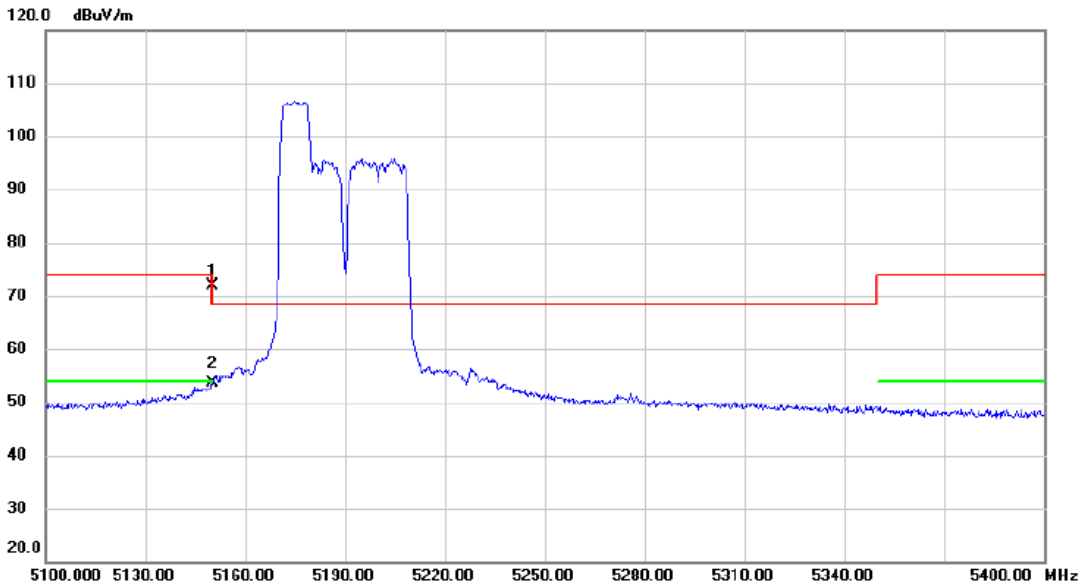

No.	Mk.	Freq. MHz	Reading Level dBuV	Correct Factor dB	Measure- ment dBuV/m	Limit dBuV/m	Margin dB	Detector	Comment
1		5150.000	31.26	40.53	71.79	74.00	-2.21	peak	
2	*	5150.000	12.99	40.53	53.52	54.00	-0.48	AVG	

REMARKS:

- (1) Measurement Value = Reading Level + Correct Factor.
- (2) Margin Level = Measurement Value - Limit Value.

Orthogonal Axis	X		
Test Mode	UNII-1_TX AX (HE40) Mode 5190 MHz	RU configuration	106/54

Horizontal

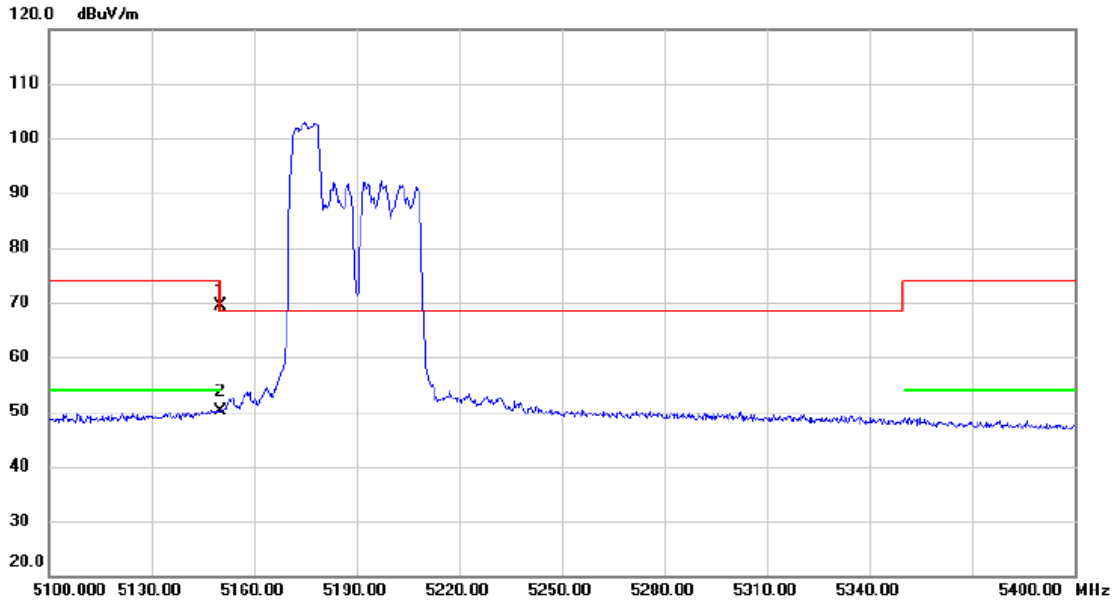

No.	Mk.	Freq. MHz	Reading Level dBuV	Correct Factor dB	Measure- ment dBuV/m	Limit dBuV/m	Margin dB	Detector	Comment
1		5150.000	28.79	40.53	69.32	74.00	-4.68	peak	
2	*	5150.000	9.60	40.53	50.13	54.00	-3.87	AVG	

REMARKS:

- (1) Measurement Value = Reading Level + Correct Factor.
- (2) Margin Level = Measurement Value - Limit Value.

Orthogonal Axis	X		
Test Mode	UNII-1_TX AX (HE40) Mode 5190 MHz	RU configuration	242/62

Vertical

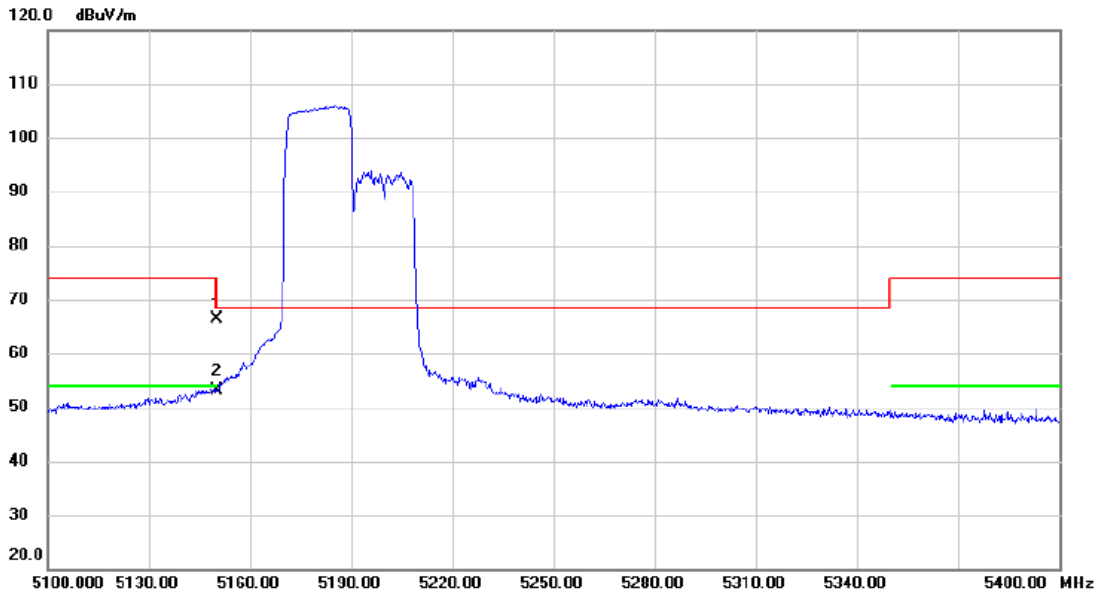

No.	Mk.	Freq.	Reading Level	Correct Factor	Measurement	Limit	Margin	Detector	Comment
		MHz	dBuV	dB	dBuV/m	dBuV/m	dB		
1		5150.000	25.84	40.53	66.37	74.00	-7.63	peak	
2	*	5150.000	12.59	40.53	53.12	54.00	-0.88	AVG	

REMARKS:

- (1) Measurement Value = Reading Level + Correct Factor.
- (2) Margin Level = Measurement Value - Limit Value.

Orthogonal Axis	X		
Test Mode	UNII-1_TX AX (HE40) Mode 5190 MHz	RU configuration	242/62

Horizontal

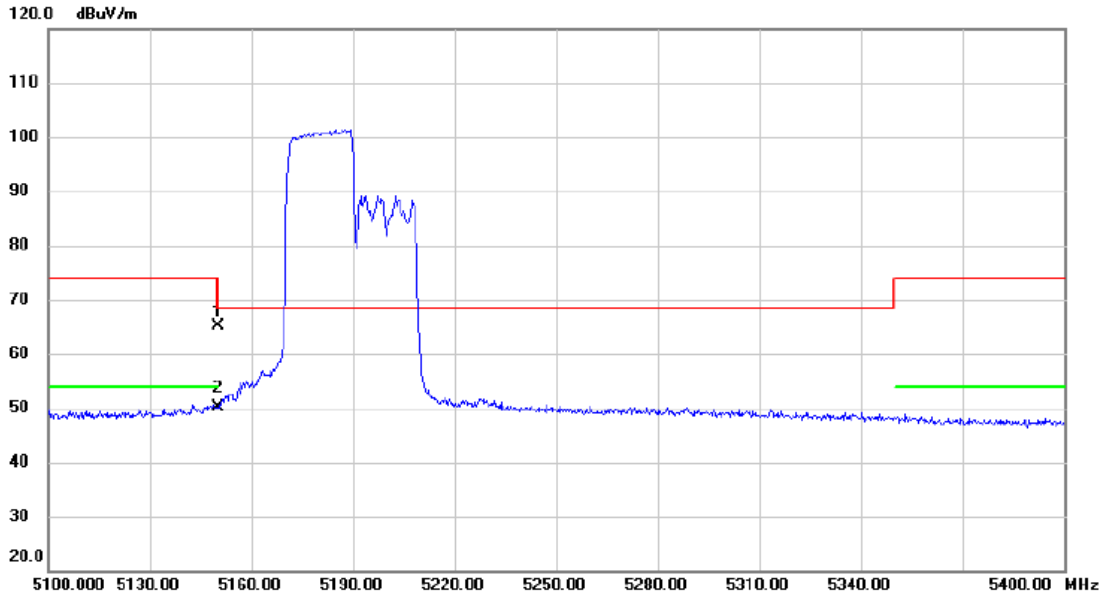

No.	Mk.	Freq. MHz	Reading Level dBuV	Correct Factor dB	Measure- ment dBuV/m	Limit dBuV/m	Margin dB	Detector	Comment
1		5150.000	24.48	40.53	65.01	74.00	-8.99	peak	
2	*	5150.000	9.71	40.53	50.24	54.00	-3.76	AVG	

REMARKS:

- (1) Measurement Value = Reading Level + Correct Factor.
- (2) Margin Level = Measurement Value - Limit Value.

Orthogonal Axis	X		
Test Mode	UNII-1_TX AX (HE40) Mode 5190 MHz	RU configuration	484/65

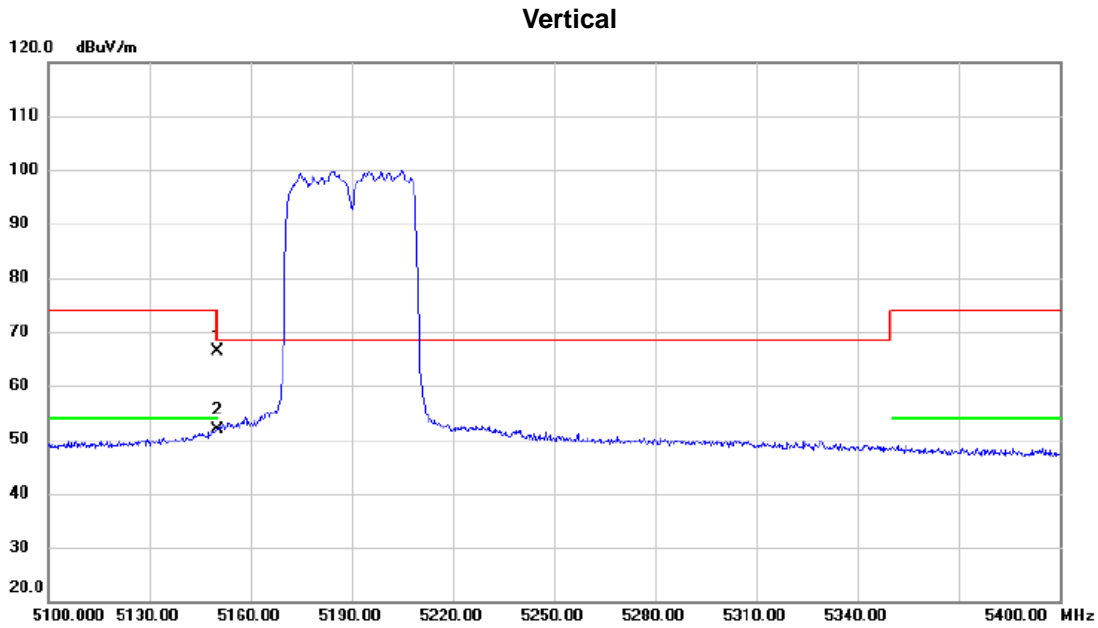

No.	Mk.	Freq. MHz	Reading Level dBuV	Correct Factor dB	Measure- ment dBuV/m	Limit dBuV/m	Margin dB	Detector	Comment
1		5150.000	25.83	40.53	66.36	74.00	-7.64	peak	
2	*	5150.000	11.45	40.53	51.98	54.00	-2.02	AVG	

REMARKS:

- (1) Measurement Value = Reading Level + Correct Factor.
- (2) Margin Level = Measurement Value - Limit Value.

Orthogonal Axis	X		
Test Mode	UNII-1_TX AX (HE40) Mode 5190 MHz	RU configuration	484/65

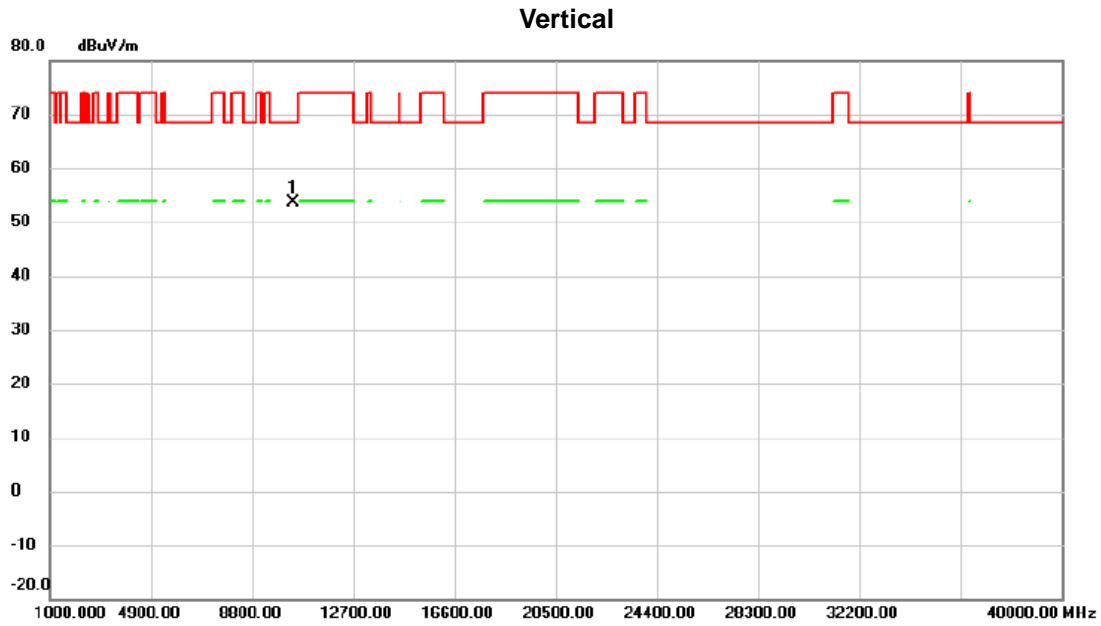

No.	Mk.	Freq. MHz	Reading Level dBuV	Correct Factor dB	Measure- ment dBuV/m	Limit dBuV/m	Margin dB	Detector	Comment
1	*	10378.26	52.92	0.73	53.65	68.30	-14.65	peak	

REMARKS:

(1) Measurement Value = Reading Level + Correct Factor.

(2) Margin Level = Measurement Value - Limit Value.

Orthogonal Axis	X		
Test Mode	UNII-1_TX AX (HE40) Mode 5190 MHz	RU configuration	484/65

Horizontal

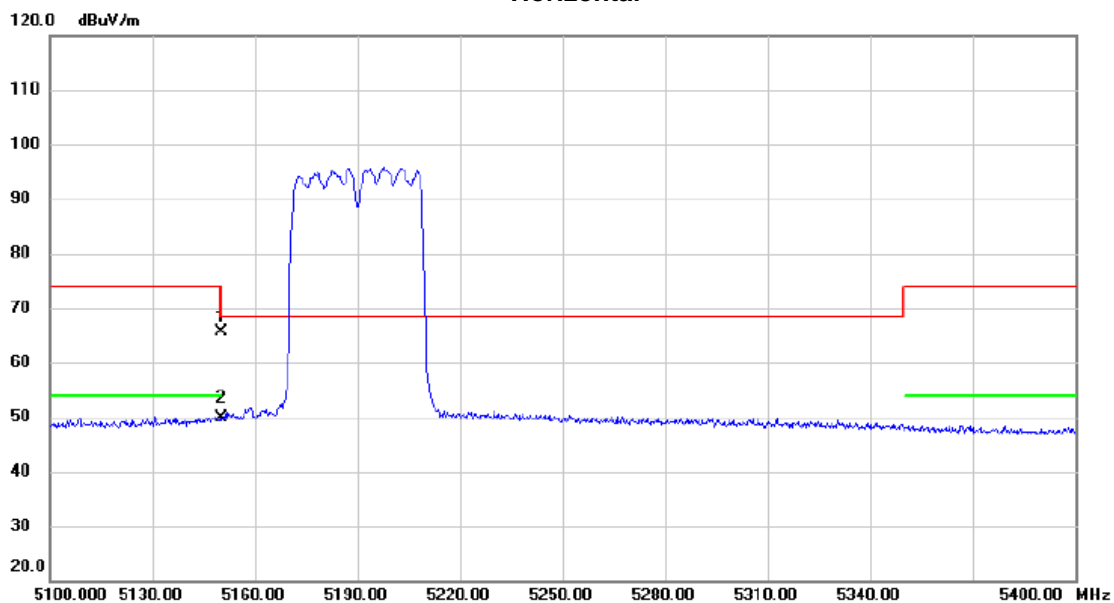

No.	Mk.	Freq. MHz	Reading Level dBuV	Correct Factor dB	Measure- ment dBuV/m	Limit dBuV/m	Margin dB	Detector	Comment
1		5150.000	25.16	40.53	65.69	74.00	-8.31	peak	
2	*	5150.000	9.31	40.53	49.84	54.00	-4.16	AVG	

REMARKS:

- (1) Measurement Value = Reading Level + Correct Factor.
- (2) Margin Level = Measurement Value - Limit Value.

Orthogonal Axis	X		
Test Mode	UNII-1_TX AX (HE40) Mode 5190 MHz	RU configuration	484/65

Horizontal

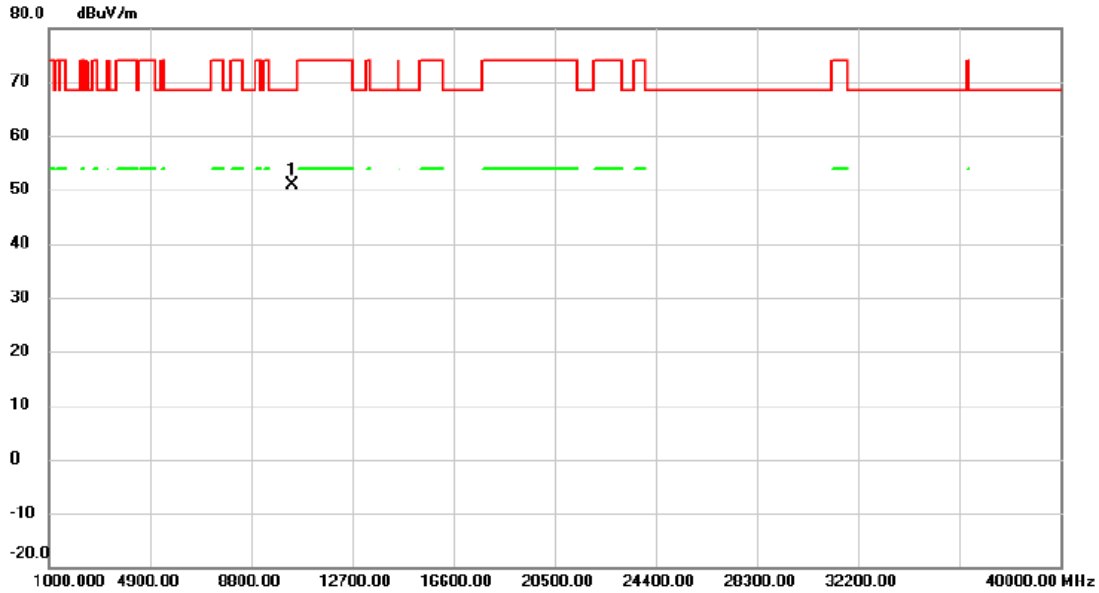

No.	Mk.	Freq.	Reading Level	Correct Factor	Measurement	Limit	Margin	Detector	Comment
		MHz	dBuV	dB	dBuV/m	dBuV/m	dB		
1	*	10378.36	50.06	0.73	50.79	68.30	-17.51	peak	

REMARKS:

- (1) Measurement Value = Reading Level + Correct Factor.
- (2) Margin Level = Measurement Value - Limit Value.

Orthogonal Axis	X		
Test Mode	UNII-1_TX AX (HE40) Mode 5230 MHz	RU configuration	52/37

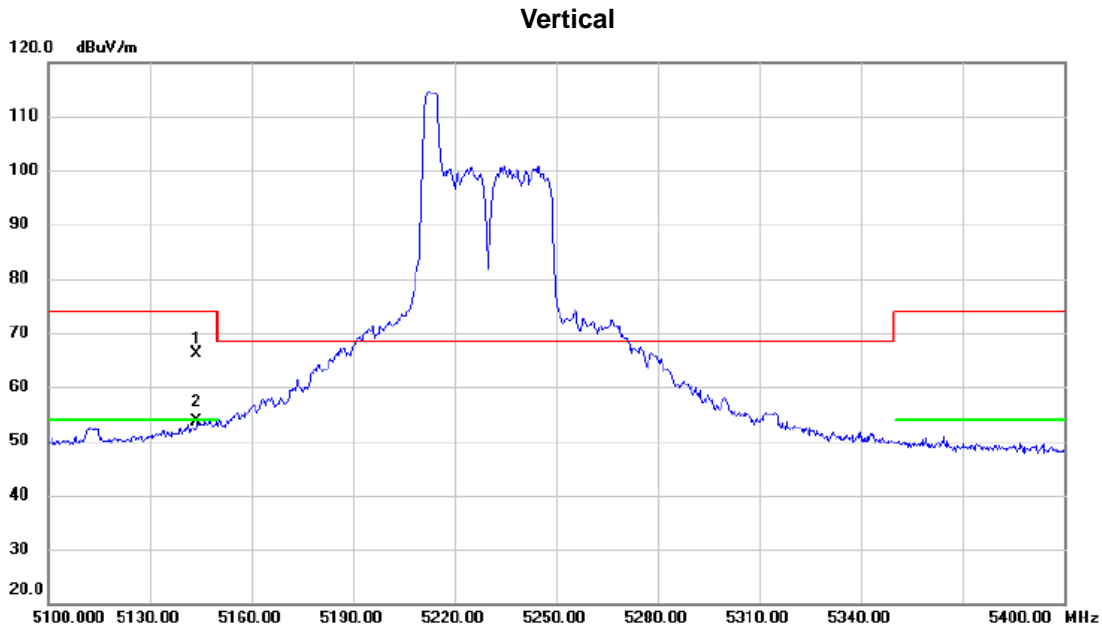

No.	Mk.	Freq. MHz	Reading Level dBuV	Correct Factor dB	Measure- ment dBuV/m	Limit dBuV/m	Margin dB	Detector	Comment
1		5143.950	25.74	40.51	66.25	74.00	-7.75	peak	
2	*	5143.950	13.11	40.51	53.62	54.00	-0.38	AVG	

REMARKS:

- (1) Measurement Value = Reading Level + Correct Factor.
- (2) Margin Level = Measurement Value - Limit Value.

Orthogonal Axis	X		
Test Mode	UNII-1_TX AX (HE40) Mode 5230 MHz	RU configuration	52/37

Horizontal

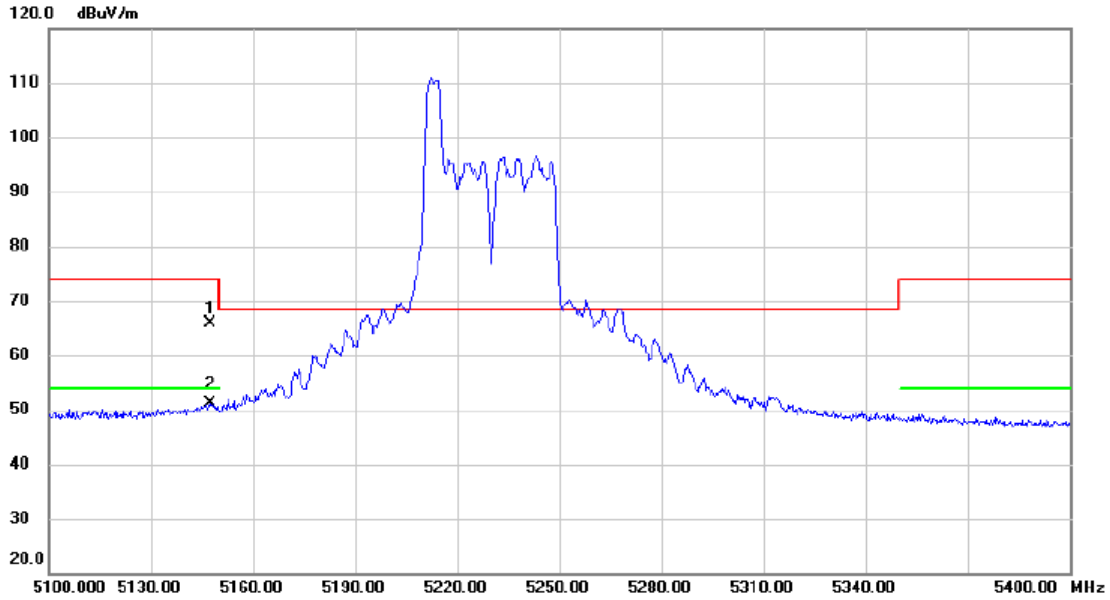

No.	Mk.	Freq. MHz	Reading Level dBuV	Correct Factor dB	Measure- ment dBuV/m	Limit dBuV/m	Margin dB	Detector	Comment
1		5147.550	25.45	40.53	65.98	74.00	-8.02	peak	
2	*	5147.550	10.59	40.53	51.12	54.00	-2.88	AVG	

REMARKS:

- (1) Measurement Value = Reading Level + Correct Factor.
- (2) Margin Level = Measurement Value - Limit Value.

Orthogonal Axis	X		
Test Mode	UNII-1_TX AX (HE40) Mode 5230 MHz	RU configuration	106/54

Vertical

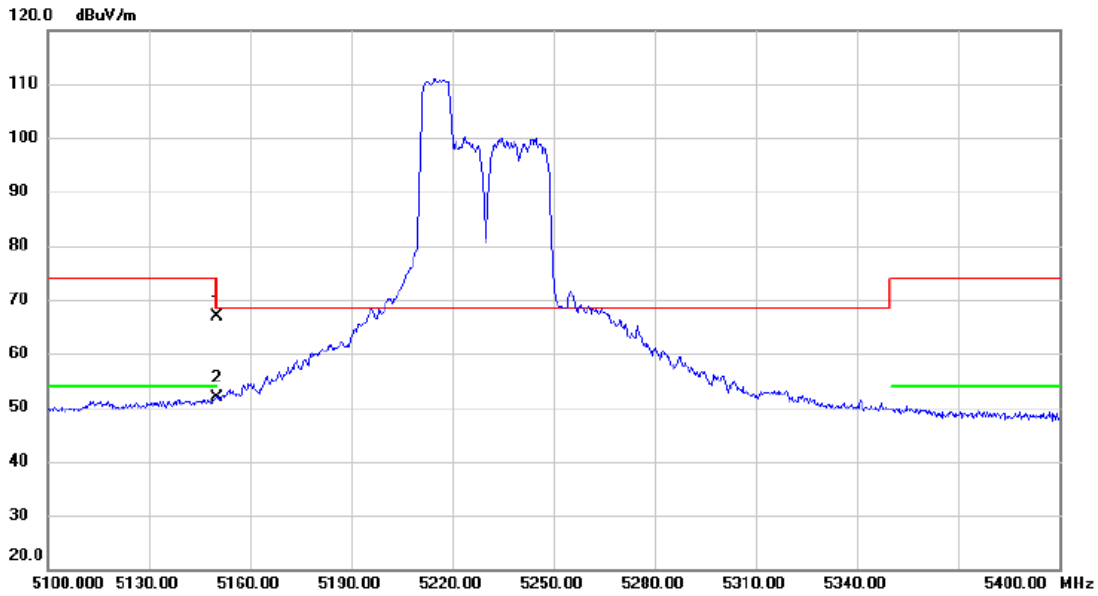

No.	Mk.	Freq.	Reading Level	Correct Factor	Measurement	Limit	Margin	Detector	Comment
		MHz	dBuV	dB	dBuV/m	dBuV/m	dB		
1		5150.000	26.40	40.53	66.93	74.00	-7.07	peak	
2	*	5150.000	11.41	40.53	51.94	54.00	-2.06	AVG	

REMARKS:

- (1) Measurement Value = Reading Level + Correct Factor.
- (2) Margin Level = Measurement Value - Limit Value.

Orthogonal Axis	X		
Test Mode	UNII-1_TX AX (HE40) Mode 5230 MHz	RU configuration	106/54

Horizontal

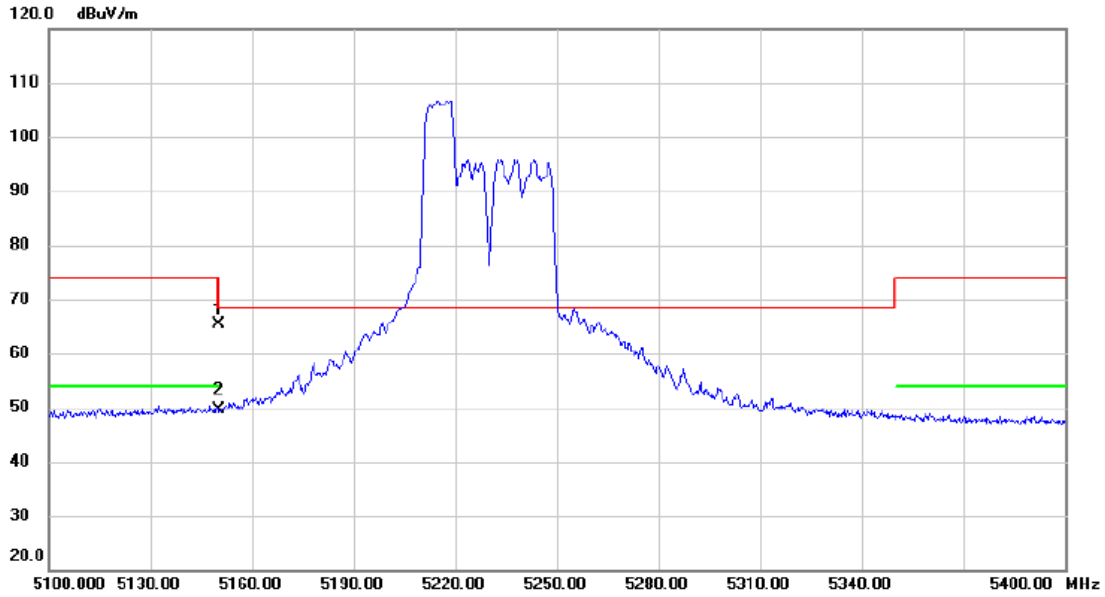

No.	Mk.	Freq.	Reading Level	Correct Factor	Measurement	Limit	Margin	Detector	Comment
		MHz	dBuV	dB	dBuV/m	dBuV/m	dB		
1		5150.000	24.96	40.53	65.49	74.00	-8.51	peak	
2	*	5150.000	9.10	40.53	49.63	54.00	-4.37	AVG	

REMARKS:

- (1) Measurement Value = Reading Level + Correct Factor.
- (2) Margin Level = Measurement Value - Limit Value.

Orthogonal Axis	X		
Test Mode	UNII-1_TX AX (HE40) Mode 5230 MHz	RU configuration	242/62

Vertical

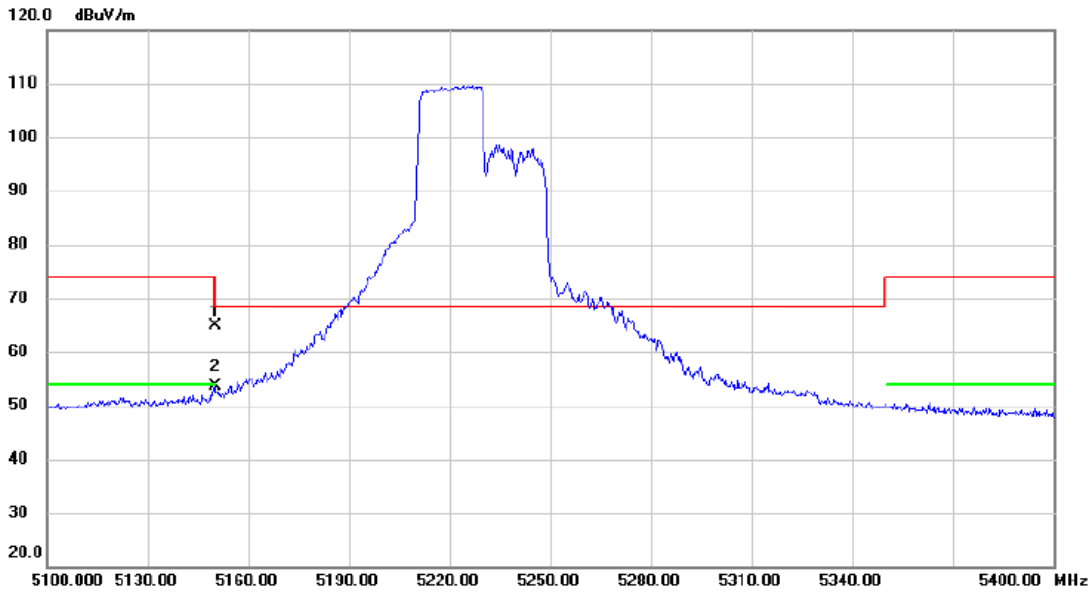

No.	Mk.	Freq. MHz	Reading Level dBuV	Correct Factor dB	Measure- ment dBuV/m	Limit dBuV/m	Margin dB	Detector	Comment
1		5150.000	24.42	40.53	64.95	74.00	-9.05	peak	
2	*	5150.000	13.04	40.53	53.57	54.00	-0.43	AVG	

REMARKS:

- (1) Measurement Value = Reading Level + Correct Factor.
- (2) Margin Level = Measurement Value - Limit Value.

Orthogonal Axis	X		
Test Mode	UNII-1_TX AX (HE40) Mode 5230 MHz	RU configuration	242/62

Horizontal

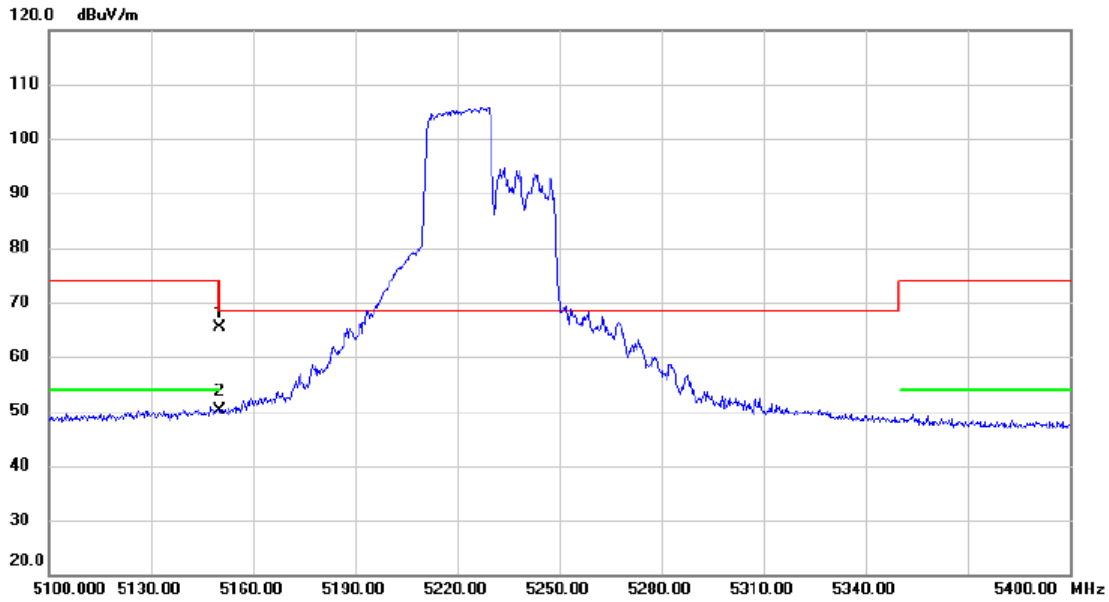

No.	Mk.	Freq.	Reading Level	Correct Factor	Measurement	Limit	Margin	Detector	Comment
		MHz	dBuV	dB	dBuV/m	dBuV/m	dB		
1		5150.000	24.76	40.53	65.29	74.00	-8.71	peak	
2	*	5150.000	9.54	40.53	50.07	54.00	-3.93	AVG	

REMARKS:

- (1) Measurement Value = Reading Level + Correct Factor.
- (2) Margin Level = Measurement Value - Limit Value.

Orthogonal Axis	X		
Test Mode	UNII-1_TX AX (HE40) Mode 5230 MHz	RU configuration	484/65

Vertical

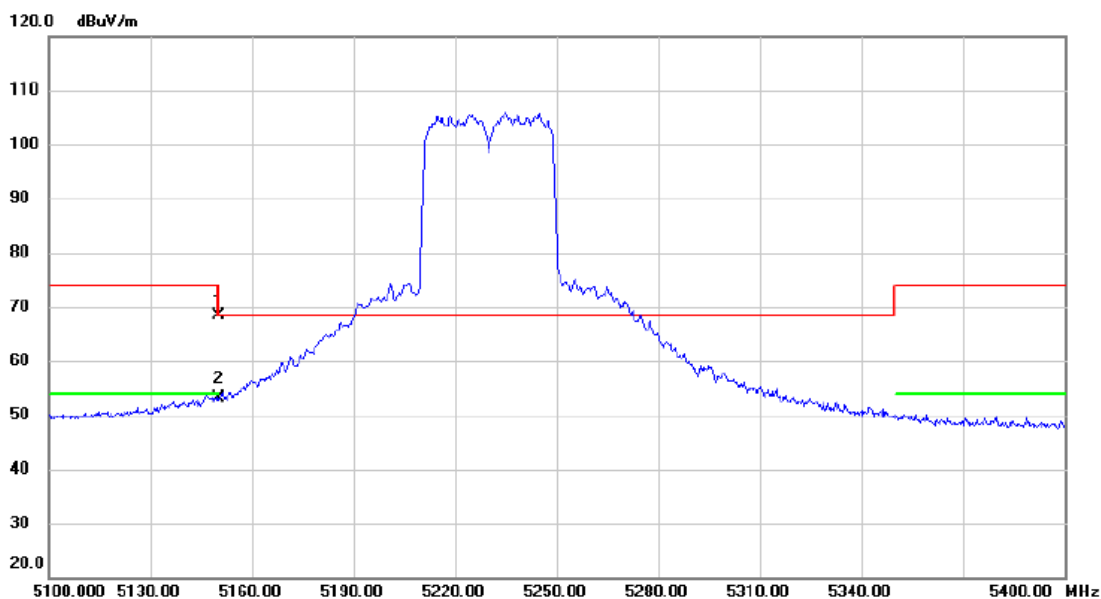

No.	Mk.	Freq. MHz	Reading Level dBuV	Correct Factor dB	Measure- ment dBuV/m	Limit dBuV/m	Margin dB	Detector	Comment
1		5150.000	27.92	40.53	68.45	74.00	-5.55	peak	
2	*	5150.000	12.66	40.53	53.19	54.00	-0.81	AVG	

REMARKS:

- (1) Measurement Value = Reading Level + Correct Factor.
- (2) Margin Level = Measurement Value - Limit Value.

Orthogonal Axis	X		
Test Mode	UNII-1_TX AX (HE40) Mode 5230 MHz	RU configuration	484/65

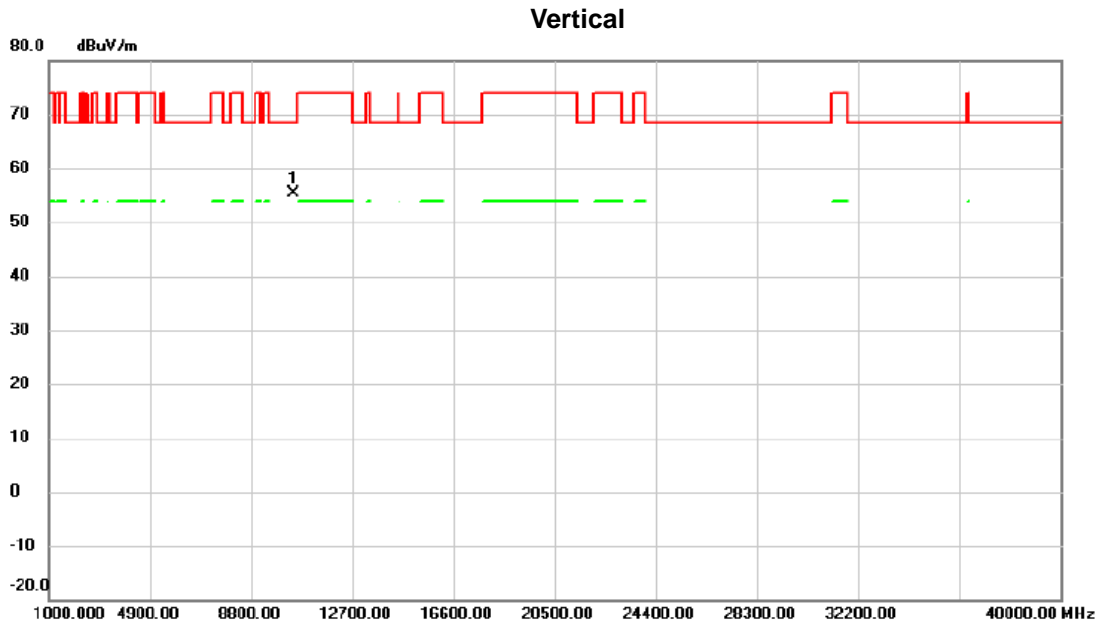

No.	Mk.	Freq. MHz	Reading Level dBuV	Correct Factor dB	Measurement dBuV/m	Limit dBuV/m	Margin dB	Detector	Comment
1	*	10458.42	54.29	0.98	55.27	68.30	-13.03	peak	

REMARKS:

- (1) Measurement Value = Reading Level + Correct Factor.
- (2) Margin Level = Measurement Value - Limit Value.

Orthogonal Axis	X		
Test Mode	UNII-1_TX AX (HE40) Mode 5230 MHz	RU configuration	484/65

Horizontal

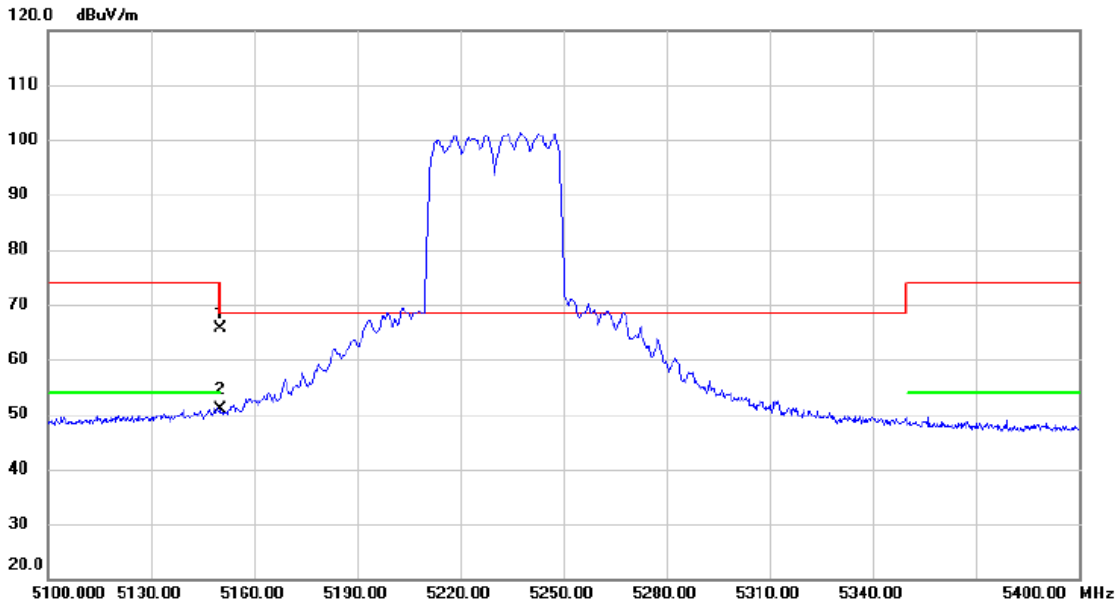

No.	Mk.	Freq. MHz	Reading Level dBuV	Correct Factor dB	Measure- ment dBuV/m	Limit dBuV/m	Margin dB	Detector	Comment
1		5150.000	25.03	40.53	65.56	74.00	-8.44	peak	
2	*	5150.000	10.28	40.53	50.81	54.00	-3.19	AVG	

REMARKS:

- (1) Measurement Value = Reading Level + Correct Factor.
- (2) Margin Level = Measurement Value - Limit Value.