

FCC Test Report

Report No.: RF170116E03-1

FCC ID: KA2IR882A1

Test Model: DIR-882

Received Date: Jan. 16, 2017

Test Date: Jan. 25 to Mar. 16, 2017

Issued Date: Mar. 29, 2017

Applicant: D-Link Corporation

Address: 17595 Mt. Herrmann Street Fountain Valley, CA92708 USA

Issued By: Bureau Veritas Consumer Products Services (H.K.) Ltd., Taoyuan Branch
Hsin Chu Laboratory

Lab Address: E-2, No.1, Li Hsin 1st Road, Hsinchu Science Park, Hsinchu City 300,
Taiwan R.O.C.

Test Location (1): E-2, No.1, Li Hsin 1st Road, Hsinchu Science Park, Hsinchu City 300,
Taiwan R.O.C.

Test Location (2): No. 49, Ln. 206, Wende Rd., Shangshan Tsuen, Chiung Lin Hsiang, Hsin
Chu Hsien 307, Taiwan R.O.C.



This report is for your exclusive use. Any copying or replication of this report to or for any other person or entity, or use of our name or trademark, is permitted only with our prior written permission. This report sets forth our findings solely with respect to the test samples identified herein. The results set forth in this report are not indicative or representative of the quality or characteristics of the lot from which a test sample was taken or any similar or identical product unless specifically and expressly noted. Our report includes all of the tests requested by you and the results thereof based upon the information that you provided to us. You have 60 days from date of issuance of this report to notify us of any material error or omission caused by our negligence, provided, however, that such notice shall be in writing and shall specifically address the issue you wish to raise. A failure to raise such issue within the prescribed time shall constitute your unqualified acceptance of the completeness of this report, the tests conducted and the correctness of the report contents. Unless specific mention, the uncertainty of measurement has been explicitly taken into account to declare the compliance or non-compliance to the specification. The report must not be used by the client to claim product certification, approval, or endorsement by TAF or any government agencies.

Table of Contents

Release Control Record	4
1 Certificate of Conformity	5
2 Summary of Test Results	6
2.1 Measurement Uncertainty	6
2.2 Modification Record	6
3 General Information	7
3.1 General Description of EUT	7
3.2 Description of Test Modes	11
3.2.1 Test Mode Applicability and Tested Channel Detail	12
3.3 Duty Cycle of Test Signal	15
3.4 Description of Support Units	16
3.4.1 Configuration of System under Test	17
3.5 General Description of Applied Standard	18
4 Test Types and Results	19
4.1 Radiated Emission and Bandedge Measurement	19
4.1.1 Limits of Radiated Emission and Bandedge Measurement	19
4.1.2 Test Instruments	20
4.1.3 Test Procedure	22
4.1.4 Deviation from Test Standard	23
4.1.5 Test Setup	23
4.1.6 EUT Operating Condition	24
4.1.7 Test Results (Mode 1)	25
4.1.8 Test Results (Mode 2)	45
4.2 Conducted Emission Measurement	66
4.2.1 Limits of Conducted Emission Measurement	66
4.2.2 Test Instruments	66
4.2.3 Test Procedure	67
4.2.4 Deviation from Test Standard	67
4.2.5 Test Setup	67
4.2.6 EUT Operating Condition	67
4.2.7 Test Results	68
4.3 Transmit Power Measurement	70
4.3.1 Limits of Transmit Power Measurement	70
4.3.2 Test Setup	70
4.3.3 Test Instruments	70
4.3.4 Test Procedure	70
4.3.5 Deviation from Test Standard	70
4.3.6 EUT Operating Condition	70
4.3.7 Test Result (Mode 1)	71
4.3.8 Test Result (Mode 2)	74
4.4 Occupied Bandwidth Measurement	77
4.4.1 Test Setup	77
4.4.2 Test Instruments	77
4.4.3 Test Procedure	77
4.4.4 Test Results	78
4.5 Peak Power Spectral Density Measurement	86
4.5.1 Limits of Peak Power Spectral Density Measurement	86
4.5.2 Test Setup	86
4.5.3 Test Instruments	86
4.5.4 Test Procedure	86
4.5.5 Deviation from Test Standard	87
4.5.6 EUT Operating Condition	87
4.5.7 Test Results (Mode 1)	88

4.5.8 Test Results (Mode 2).....	95
4.6 Frequency Stability Measurement.....	102
4.6.1 Limits of Frequency Stability Measurement	102
4.6.2 Test Setup.....	102
4.6.3 Test Instruments	102
4.6.4 Test Procedure	102
4.6.5 Deviation from Test Standard	102
4.6.6 EUT Operating Condition	102
4.6.7 Test Results	103
4.7 6dB Bandwidth Measurement.....	104
4.7.1 Limits of 6dB Bandwidth Measurement.....	104
4.7.2 Test Setup.....	104
4.7.3 Test Instruments	104
4.7.4 Test Procedure	104
4.7.5 Deviation from Test Standard	104
4.7.6 EUT Operating Condition	104
4.7.7 Test Results	105
5 Pictures of Test Arrangements.....	107
Annex A- Radiated Out of Band Emission (OOBE) Measurement (For U-NII-3 band)	108
Annex A.1 (Mode 1).....	108
Annex A.2 (Mode 2).....	112
Appendix – Information on the Testing Laboratories	116

Release Control Record

Issue No.	Description	Date Issued
RF170116E03-1	Original release.	Mar. 29, 2017

1 Certificate of Conformity

Product: AC2600 MU-MIMO Wi-Fi Gigabit Router

Brand: D-Link

Test Model: DIR-882

Sample Status: ENGINEERING SAMPLE

Applicant: D-Link Corporation

Test Date: Jan. 25 to Mar. 16, 2017

Standard: 47 CFR FCC Part 15, Subpart E (Section 15.407)
ANSI C63.10: 2013

The above equipment has been tested by **Bureau Veritas Consumer Products Services (H.K.) Ltd., Taoyuan Branch**, and found compliance with the requirement of the above standards. The test record, data evaluation & Equipment Under Test (EUT) configurations represented herein are true and accurate accounts of the measurements of the sample's EMC characteristics under the conditions specified in this report.

Prepared by : Midoli Peng , **Date:** Mar. 29, 2017
Midoli Peng / Specialist

Approved by : May Chen , **Date:** Mar. 29, 2017
May Chen / Manager

2 Summary of Test Results

47 CFR FCC Part 15, Subpart E (Section 15.407)			
FCC Clause	Test Item	Result	Remarks
15.407(b)(6)	AC Power Conducted Emissions	Pass	Meet the requirement of limit. Minimum passing margin is -13.45dB at 20.18359MHz.
15.407(b)(1/2/3/4(i/ii)/6)	Radiated Emissions & Band Edge Measurement*	Pass	Meet the requirement of limit. Minimum passing margin is -0.1dB at 5150.00MHz & 5645.51MHz.
15.407(a)(1/2/3)	Max Average Transmit Power	Pass	Meet the requirement of limit.
---	Occupied Bandwidth Measurement	-	Reference only.
15.407(a)(1/2/3)	Peak Power Spectral Density	Pass	Meet the requirement of limit.
15.407(e)	6dB bandwidth	Pass	Meet the requirement of limit. (U-NII-3 Band only)
15.407(g)	Frequency Stability	Pass	Meet the requirement of limit.
15.203	Antenna Requirement	Pass	Antenna connector is i-pex (MHF) not a standard connector.

*For U-NII-3 band compliance with rule part 15.407(b)(4)(i), the OOB test plots were recorded in Annex A.

2.1 Measurement Uncertainty

Where relevant, the following measurement uncertainty levels have been estimated for tests performed on the EUT as specified in CISPR 16-4-2:

Measurement	Frequency	Expanded Uncertainty (k=2) (±)
Conducted Emissions at mains ports	150kHz ~ 30MHz	1.84 dB
Radiated Emissions up to 1 GHz	30MHz ~ 1GHz	5.30 dB
Radiated Emissions above 1 GHz	1GHz ~ 6GHz	4.78 dB
	6GHz ~ 18GHz	4.52 dB
	18GHz ~ 40GHz	5.08 dB

2.2 Modification Record

There were no modifications required for compliance.

3 General Information

3.1 General Description of EUT

Product	AC2600 MU-MIMO Wi-Fi Gigabit Router
Brand	D-Link
Test Model	DIR-882
Status of EUT	ENGINEERING SAMPLE
Power Supply Rating	DC 12V from power adapter
Modulation Type	CCK, DQPSK, DBPSK for DSSS 64QAM, 16QAM, QPSK, BPSK for OFDM 256QAM for OFDM in 11ac mode and VHT20/40 in 2.4GHz band
Modulation Technology	DSSS, OFDM
Transfer Rate	802.11b: up to 11Mbps 802.11a/g: up to 54Mbps 802.11n: up to 600Mbps 802.11ac: up to 1733.3Mbps 802.11ac (80+80): up to 3466.7Mbps
Operating Frequency	2.4GHz: 2.412GHz ~ 2.462GHz 5GHz: 5.18GHz ~ 5.24GHz, 5.745GHz ~ 5.825GHz
Number of Channel	2.4GHz: 802.11b, 802.11g, 802.11n (HT20), VHT20: 11 802.11n (HT40), VHT40: 7 5GHz: 802.11a, 802.11n (HT20), 802.11ac (VHT20): 9 802.11n (HT40), 802.11ac (VHT40): 4 802.11ac (VHT80): 2 802.11ac (VHT80+80): 1 set
Output Power	For Antenna set 1 (Gain : 2dBi) 2.4GHz: 788.724mW 5GHz: 5.18GHz ~ 5.24GHz: CDD Mode: 995.277mW Beamforming Mode: 571.911mW 5.745GHz ~ 5.825GHz: CDD Mode: 975.714mW Beamforming Mode: 600.3mW

Output Power	For Antenna set 2 (Gain : 5dBi) 2.4GHz: 788.724mW 5GHz: 5.18GHz ~ 5.24GHz: CDD Mode: 322.367mW Beamforming Mode: 313.257mW 5.745GHz ~ 5.825GHz: CDD Mode: 655.424mW Beamforming Mode: 310.007mW
Antenna Type	Refer to Note
Antenna Connector	Refer to Note
Accessory Device	Adapter x 1
Data Cable Supplied	NA

Note:

1. Simultaneously transmission condition.

Condition	Technology	
1	WLAN (2.4GHz)	WLAN (5GHz)

Note: The emission of the simultaneous operation has been evaluated and no non-compliance was found.

2. The EUT must be supplied with a power adapter as following table:

Brand	Model No.	Spec.
Shenzhen Gongjin Electronics Co., Ltd	S36B52-120A250-04	AC Input: 100-240V, 1A, 50/60Hz DC Output: 12V, 2.5A DC Output cable: unshielded, 1.1m

3. The antennas provided to the EUT, please refer to the following table:

Set 1 Antenna				
Chain No.	Antenna Gain (dBi)	Frequency range (GHz)	Antenna Type	Connector Type
Chain 0	2	2.4~2.4835	Dipole	i-pex (MHF)
	2	5.15~5.85		
Chain 1	2	2.4~2.4835	Dipole	i-pex (MHF)
	2	5.15~5.85		
Chain 2	2	2.4~2.4835	Dipole	i-pex (MHF)
	2	5.15~5.85		
Chain 3	2	2.4~2.4835	Dipole	i-pex (MHF)
	2	5.15~5.85		
Set 2 Antenna				
Chain No.	Antenna Gain (dBi)	Frequency range (GHz)	Antenna Type	Connector Type
Chain 0	5	2.4~2.4835	Dipole	i-pex (MHF)
	5	5.15~5.85		
Chain 1	5	2.4~2.4835	Dipole	i-pex (MHF)
	5	5.15~5.85		
Chain 2	5	2.4~2.4835	Dipole	i-pex (MHF)
	5	5.15~5.85		
Chain 3	5	2.4~2.4835	Dipole	i-pex (MHF)
	5	5.15~5.85		

4. The Directional gain table:

Frequency (MHz)	Max Gain (dBi)
2412-2462	7.39 (for Set 1 Antenna) 10.06 (for Set 2 Antenna)
5180-5825	7.75 (for Set 1 Antenna) 10.90 (for Set 2 Antenna)

Note:

1. Non-TxBF mode & TxBF mode antenna gain refer to KDB 662911 F 2) f) (ii)

$$DirectionalGain = 10 \cdot \log \left[\frac{\sum_{j=1}^{N_{SS}} \left\{ \sum_{k=1}^{N_{ANT}} g_{j,k} \right\}^2}{N_{ANT}} \right]$$

where

Each antenna is driven by no more than one spatial stream;

N_{SS} = the number of independent spatial streams of data;

N_{ANT} = the total number of antennas

$g_{j,k} = 10^{G_k/20}$ if the k th antenna is being fed by spatial stream j , or zero if it is not;

G_k is the gain in dBi of the k th antenna.

2. Above directional gain were calculated from actual measurement data.

5. The EUT incorporates a MIMO function.

2.4GHz Band			
MODULATION MODE	DATA RATE (MCS)	TX & RX CONFIGURATION	
802.11b	1 ~ 11Mbps	4TX	4RX
802.11g	6 ~ 54Mbps	4TX	4RX
802.11n (HT20)	MCS 0~7	4TX	4RX
	MCS 8~15	4TX	4RX
	MCS 16~23	4TX	4RX
	MCS 24~31	4TX	4RX
802.11n (HT40)	MCS 0~7	4TX	4RX
	MCS 8~15	4TX	4RX
	MCS 16~23	4TX	4RX
	MCS 24~31	4TX	4RX
VHT20	MCS 0~8, Nss=1	4TX	4RX
	MCS 0~8, Nss=2	4TX	4RX
	MCS 0~9, Nss=3	4TX	4RX
	MCS 0~8, Nss=4	4TX	4RX
VHT40	MCS0~9 Nss=1	4TX	4RX
	MCS0~9 Nss=2	4TX	4RX
	MCS0~9 Nss=3	4TX	4RX
	MCS0~9 Nss=4	4TX	4RX
5GHz Band			
MODULATION MODE	DATA RATE (MCS)	TX & RX CONFIGURATION	
802.11a	6 ~ 54Mbps	4TX	4RX
802.11n (HT20)	MCS 0~7	4TX	4RX
	MCS 8~15	4TX	4RX
	MCS 16~23	4TX	4RX
	MCS 24~31	4TX	4RX
802.11n (HT40)	MCS 0~7	4TX	4RX
	MCS 8~15	4TX	4RX
	MCS 16~23	4TX	4RX
	MCS 24~31	4TX	4RX
802.11ac (VHT20)	MCS 0~8, Nss=1	4TX	4RX
	MCS 0~8, Nss=2	4TX	4RX
	MCS 0~9, Nss=3	4TX	4RX
	MCS 0~8, Nss=4	4TX	4RX
802.11ac (VHT40)	MCS 0~9, Nss=1	4TX	4RX
	MCS 0~9, Nss=2	4TX	4RX
	MCS 0~9, Nss=3	4TX	4RX
	MCS 0~9, Nss=4	4TX	4RX
802.11ac (VHT80)	MCS 0~9, Nss=1	4TX	4RX
	MCS 0~9, Nss=2	4TX	4RX
	MCS 0~9, Nss=3	4TX	4RX
	MCS 0~9, Nss=4	4TX	4RX
802.11ac (VHT80+VHT80) noncontiguous	MCS 0~9, Nss=1	2TX+2TX	2RX +2RX
	MCS 0~9, Nss=2	2TX+2TX	2RX +2RX

Note:

- All of modulation mode support beamforming function except 2.4GHz & 802.11a modulation mode.
- The EUT support Beamforming and CDD mode, therefore both mode were investigated and the worst case scenario was identified. The worst case data were presented in test report.
- The modulation and bandwidth are similar for 802.11n mode for 20MHz (40MHz) and 802.11ac mode for 20MHz (40MHz), therefore investigated worst case to representative mode in test report. (Final test mode refer section 3.2.1)

6. The above EUT information is declared by manufacturer and for more detailed features description, please refer to the manufacturer's specifications or user's manual.

3.2 Description of Test Modes

FOR 5180 ~ 5240MHz

4 channels are provided for 802.11a, 802.11n (HT20), 802.11ac (VHT20):

Channel	Frequency	Channel	Frequency
36	5180 MHz	44	5220 MHz
40	5200 MHz	48	5240 MHz

2 channels are provided for 802.11n (HT40), 802.11ac (VHT40):

Channel	Frequency	Channel	Frequency
38	5190 MHz	46	5230 MHz

1 channel is provided for 802.11ac (VHT80):

Channel	Frequency
42	5210MHz

FOR 5745 ~ 5825MHz:

5 channels are provided for 802.11a, 802.11n (HT20), 802.11ac (VHT20):

Channel	Frequency	Channel	Frequency
149	5745MHz	161	5805MHz
153	5765MHz	165	5825MHz
157	5785MHz		

2 channels are provided for 802.11n (HT40), 802.11ac (VHT40):

Channel	Frequency	Channel	Frequency
151	5755MHz	159	5795MHz

1 channel is provided for 802.11ac (VHT80):

Channel	Frequency
155	5775MHz

For simultaneous transmission in non-adjacent channels:

1 set is provided for 802.11ac (VHT80+80):

Channel	Frequency
42+155	5210 MHz + 5775 MHz

Note: The transmission is for noncontiguous transmission using two nonadjacent 80MHz channels.

3.2.1 Test Mode Applicability and Tested Channel Detail

EUT Configure Mode	Applicable To				Description
	RE \geq 1G	RE $<$ 1G	PLC	APCM	
1	√	-	-	√	With antenna set 1 (Gain : 2dBi)
2	√	√	√	√	With antenna set 2 (Gain : 5dBi)

Where **RE \geq 1G**: Radiated Emission above 1GHz **RE $<$ 1G**: Radiated Emission below 1GHz
PLC: Power Line Conducted Emission **APCM**: Antenna Port Conducted Measurement

NOTE:

1. The EUT had been pre-tested on the positioned of each 2 axis. The worst case was found when positioned on **X-plane(below 1GHz) & Y-plane(above 1GHz)**
2. "-" means no effect.

Radiated Emission Test (Above 1GHz):

- Pre-Scan has been conducted to determine the worst-case mode from all possible combinations between available modulations, data rates and antenna ports (if EUT with antenna diversity architecture).
- Following channel(s) was (were) selected for the final test as listed below.

CDD Mode						
Mode	FREQ. Band (MHz)	Available Channel	Tested Channel	Modulation Technology	Modulation Type	Data Rate (Mbps)
802.11a	5180-5240	36 to 48	36, 40, 48	OFDM	BPSK	6
802.11ac (VHT20)		36 to 48	36, 40, 48	OFDM	BPSK	6.5
802.11ac (VHT40)		38 to 46	38, 46	OFDM	BPSK	13.5
802.11ac (VHT80)		42	42	OFDM	BPSK	29.3
802.11a	5745-5825	149 to 165	149, 157, 165	OFDM	BPSK	6
802.11ac (VHT20)		149 to 165	149, 157, 165	OFDM	BPSK	6.5
802.11ac (VHT40)		151 to 159	151, 159	OFDM	BPSK	13.5
802.11ac (VHT80)		155	155	OFDM	BPSK	29.3
802.11ac (VHT80+80)	5180-5240 5745-5825	42 + 155	42 + 155	OFDM	BPSK	58.5

Radiated Emission Test (Below 1GHz):

- Pre-Scan has been conducted to determine the worst-case mode from all possible combinations between available modulations, data rates and antenna ports (if EUT with antenna diversity architecture).
- Following channel(s) was (were) selected for the final test as listed below.

CDD Mode						
Mode	FREQ. Band (MHz)	Available Channel	Tested Channel	Modulation Technology	Modulation Type	Data Rate (Mbps)
802.11a	5180-5240	36 to 48	157	OFDM	BPSK	6
	5745-5825	149 to 165				

Power Line Conducted Emission Test:

- Pre-Scan has been conducted to determine the worst-case mode from all possible combinations between available modulations, data rates and antenna ports (if EUT with antenna diversity architecture).
- Following channel(s) was (were) selected for the final test as listed below.

CDD Mode						
Mode	FREQ. Band (MHz)	Available Channel	Tested Channel	Modulation Technology	Modulation Type	Data Rate (Mbps)
802.11a	5180-5240	36 to 48	157	OFDM	BPSK	6
	5745-5825	149 to 165				

Antenna Port Conducted Measurement:

- This item includes all test value of each mode, but only includes spectrum plot of worst value of each mode.
- Pre-Scan has been conducted to determine the worst-case mode from all possible combinations between available modulations, data rates and antenna ports (if EUT with antenna diversity architecture).
- Following channel(s) was (were) selected for the final test as listed below.

CDD Mode						
Mode	FREQ. Band (MHz)	Available Channel	Tested Channel	Modulation Technology	Modulation Type	Data Rate (Mbps)
802.11a	5180-5240	36 to 48	36, 40, 48	OFDM	BPSK	6
802.11ac (VHT20)		36 to 48	36, 40, 48	OFDM	BPSK	6.5
802.11ac (VHT40)		38 to 46	38, 46	OFDM	BPSK	13.5
802.11ac (VHT80)		42	42	OFDM	BPSK	29.3
802.11a	5745-5825	149 to 165	149, 157, 165	OFDM	BPSK	6
802.11ac (VHT20)		149 to 165	149, 157, 165	OFDM	BPSK	6.5
802.11ac (VHT40)		151 to 159	151, 159	OFDM	BPSK	13.5
802.11ac (VHT80)		155	155	OFDM	BPSK	29.3
802.11ac (VHT80+80)	5180-5240 5745-5825	42 + 155	42 + 155	OFDM	BPSK	58.5
Beamforming Mode (Output power only)						
Mode	FREQ. Band (MHz)	Available Channel	Tested Channel	Modulation Technology	Modulation Type	Data Rate (Mbps)
802.11ac (VHT20)	5180-5240	36 to 48	36, 40, 48	OFDM	BPSK	6.5
802.11ac (VHT40)		38 to 46	38, 46	OFDM	BPSK	13.5
802.11ac (VHT80)		42	42	OFDM	BPSK	29.3
802.11ac (VHT20)	5745-5825	149 to 165	149, 157, 165	OFDM	BPSK	6.5
802.11ac (VHT40)		151 to 159	151, 159	OFDM	BPSK	13.5
802.11ac (VHT80)		155	155	OFDM	BPSK	29.3
802.11ac (VHT80+80)	5180-5240 5745-5825	42 + 155	42 + 155	OFDM	BPSK	58.5

Test Condition:

Applicable To	Environmental Conditions	Input Power	Tested By
RE\geq1G	23deg. C, 66%RH	120Vac, 60Hz	Terry Huang
RE$<$1G	23deg. C, 61%RH	120Vac, 60Hz	Jyunchun Lin
PLC	23deg. C, 64%RH	120Vac, 60Hz	Jyunchun Lin
APCM	24deg. C, 63%RH	120Vac, 60Hz	Anderson Chen

3.3 Duty Cycle of Test Signal

Duty cycle of test signal is 100 %, duty factor is not required.

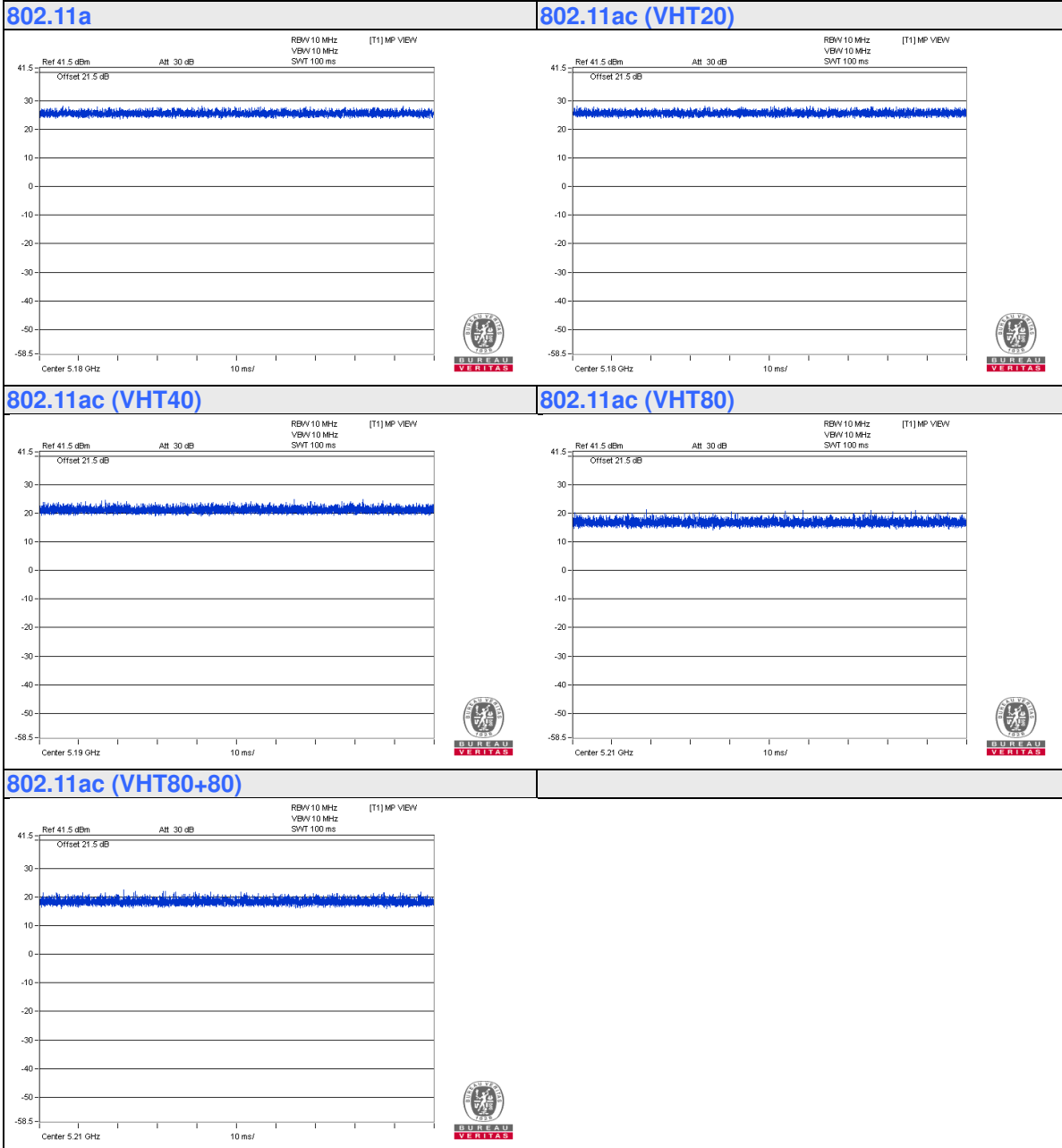

3.4 Description of Support Units

The EUT has been tested as an independent unit together with other necessary accessories or support units. The following support units or accessories were used to form a representative test configuration during the tests.

ID	Product	Brand	Model No.	Serial No.	FCC ID	Remarks
A.	Laptop	DELL	E5430	4YV4VY1	FCC DoC	Provided by Lab
B.	Laptop	DELL	E5430	HYV4VY1	FCC DoC	Provided by Lab
C.	iPod	Apple	MD778TA/A	CC4JG680F4T1	NA	Provided by Lab
D.	USB Disk	Transcend	16G	NA	NA	Provided by Lab

Note:

1. All power cords of the above support units are non-shielded (1.8m).

ID	Descriptions	Qty.	Length (m)	Shielding (Yes/No)	Cores (Qty.)	Remarks
1.	DC Cable	1	1.1	No	0	Supplied by client
2.	RJ-45 Cable	1	10	No	0	Provided by Lab
3.	RJ-45 Cable	1	10	No	0	Provided by Lab

3.4.1 Configuration of System under Test

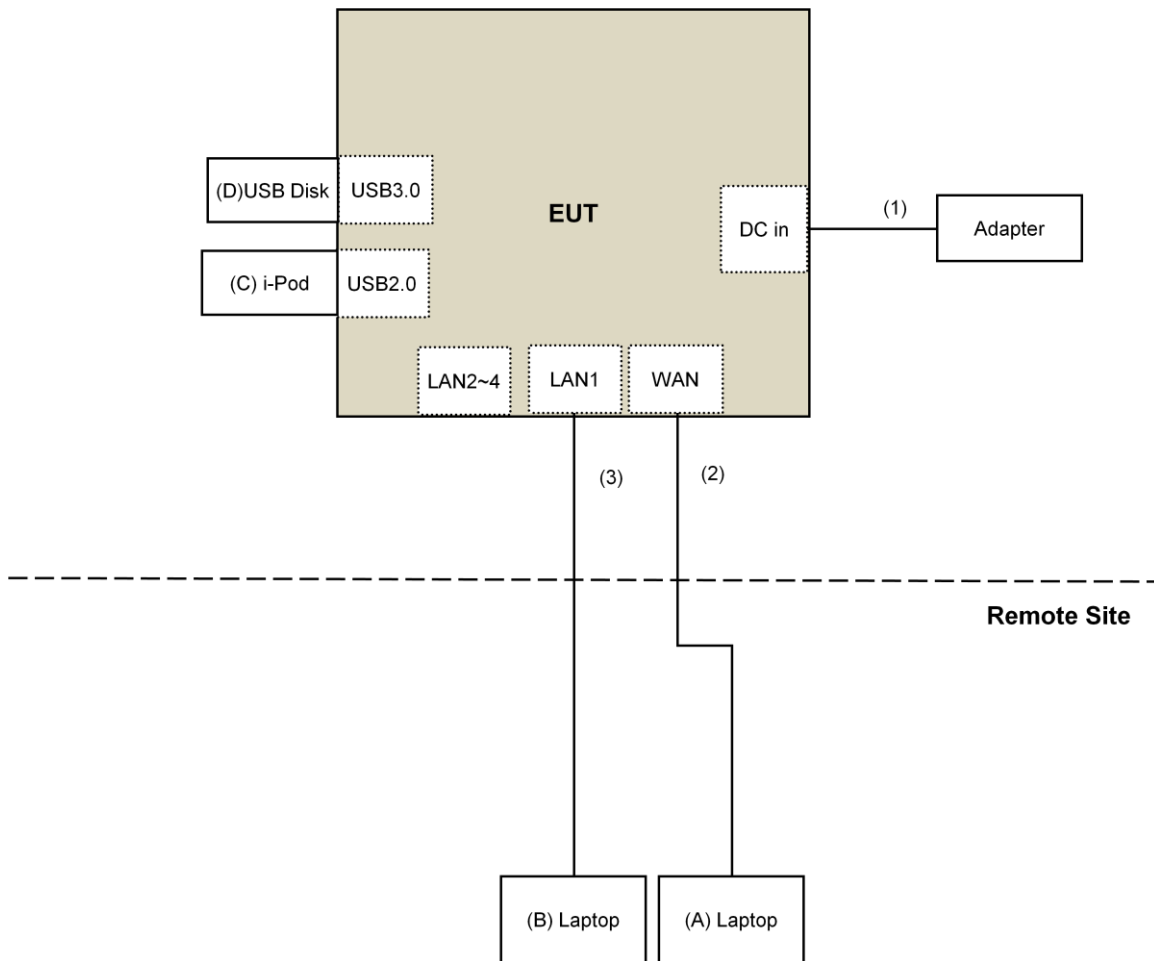

3.5 General Description of Applied Standard

The EUT is a RF Product. According to the specifications of the manufacturer, it must comply with the requirements of the following standards:

FCC Part 15, Subpart E (15.407)
KDB 789033 D02 General UNII Test Procedure New Rules v01r03
KDB 662911 D01 Multiple Transmitter Output v02r01
ANSI C63.10-2013

All test items have been performed and recorded as per the above standards.

NOTE: The EUT has been verified to comply with the requirements of FCC Part 15, Subpart B, Class B (DoC). The test report has been issued separately.

4 Test Types and Results

4.1 Radiated Emission and Bandedge Measurement

4.1.1 Limits of Radiated Emission and Bandedge Measurement

Radiated emissions which fall in the restricted bands must comply with the radiated emission limits specified as below table.

Frequencies (MHz)	Field Strength (microvolts/meter)	Measurement Distance (meters)
0.009 ~ 0.490	2400/F(kHz)	300
0.490 ~ 1.705	24000/F(kHz)	30
1.705 ~ 30.0	30	30
30 ~ 88	100	3
88 ~ 216	150	3
216 ~ 960	200	3
Above 960	500	3

NOTE:

1. The lower limit shall apply at the transition frequencies.
2. Emission level (dBuV/m) = 20 log Emission level (uV/m).
3. For frequencies above 1000MHz, the field strength limits are based on average detector, however, the peak field strength of any emission shall not exceed the maximum permitted average limits, specified above by more than 20dB under any condition of modulation.

Limits of unwanted emission out of the restricted bands

Applicable To		Limit	
789033 D02 General UNII Test Procedure New Rules v01r03		Field Strength at 3m	
		PK:74 (dBμV/m)	AV:54 (dBμV/m)
Frequency Band	Applicable To	EIRP Limit	Equivalent Field Strength at 3m
5150~5250 MHz	15.407(b)(1)	PK:-27 (dBm/MHz)	PK:68.2(dBμV/m)
5250~5350 MHz	15.407(b)(2)		
5470~5725 MHz	15.407(b)(3)		
5725~5850 MHz	<input checked="" type="checkbox"/> 15.407(b)(4)(i)	PK:-27 (dBm/MHz) ^{*1} PK:10 (dBm/MHz) ^{*2} PK:15.6 (dBm/MHz) ^{*3} PK:27 (dBm/MHz) ^{*4}	PK: 68.2(dBμV/m) ^{*1} PK:105.2 (dBμV/m) ^{*2} PK: 110.8(dBμV/m) ^{*3} PK:122.2 (dBμV/m) ^{*4}
	<input type="checkbox"/> 15.407(b)(4)(ii)	Emission limits in section 15.247(d)	
^{*1} beyond 75 MHz or more above of the band edge.		^{*2} below the band edge increasing linearly to 10 dBm/MHz at 25 MHz above.	
^{*3} below the band edge increasing linearly to a level of 15.6 dBm/MHz at 5 MHz above.		^{*4} from 5 MHz above or below the band edge increasing linearly to a level of 27 dBm/MHz at the band edge.	

Note:

The following formula is used to convert the equipment isotropic radiated power (eirp) to field strength:

$$E = \frac{1000000\sqrt{30P}}{3} \mu\text{V/m, where P is the eirp (Watts).}$$

4.1.2 Test Instruments

DESCRIPTION & MANUFACTURER	MODEL NO.	SERIAL NO.	CALIBRATED DATE	CALIBRATED UNTIL
Test Receiver Keysight	N9038A	MY54450088	July 20, 2016	July 19, 2017
Pre-Amplifier ^(*) EMCI	EMC001340	980142	Jan. 20, 2016	Jan. 19, 2018
Loop Antenna ^(*) Electro-Metrics	EM-6879	264	Dec. 16, 2016	Dec. 15, 2018
RF Cable	NA	LOOPCAB-001 LOOPCAB-002	Jan. 17, 2017	Jan. 16, 2018
Pre-Amplifier Mini-Circuits	ZFL-1000VH2B	AMP-ZFL-01	Nov. 10, 2016	Nov. 09, 2017
Trilog Broadband Antenna SCHWARZBECK	VULB 9168	9168-406	Dec. 13, 2016	Dec. 12, 2017
RF Cable	8D	966-4-1 966-4-2 966-4-3	Apr. 02, 2016	Apr. 01, 2017
Fixed attenuator Mini-Circuits	UNAT-5+	PAD-3m-4-01	Oct. 05, 2016	Oct. 04, 2017
Horn_Antenna SCHWARZBECK	BBHA 9120D	9120D-783	Dec. 27, 2016	Dec. 26, 2017
Pre-Amplifier EMCI	EMC12630SE	980385	Feb. 02, 2017	Feb. 01, 2018
RF Cable	EMC104-SM-SM-2000 EMC104-SM-SM-5000 EMC104-SM-SM-5000	160923 150318 150323	Feb. 02, 2017 Mar. 30, 2016 Mar. 30, 2016	Feb. 01, 2018 Mar. 29, 2017 Mar. 29, 2017
Pre-Amplifier EMCI	EMC184045SE	980387	Feb. 02, 2017	Feb. 01, 2018
Horn_Antenna SCHWARZBECK	BBHA 9170	BBHA9170608	Dec. 15, 2016	Dec. 14, 2017
RF Cable	SUCOFLEX 102	36432/2 36433/2	Jan. 15, 2017	Jan. 14, 2018
Software	ADT_Radiated_V 8.7.08	NA	NA	NA
Antenna Tower & Turn Table Max-Full	MF-7802	MF780208410	NA	NA
Boresight Antenna Fixture	FBA-01	FBA-SIP02	NA	NA
Spectrum Analyzer R&S	FSV40	100964	June 28, 2016	June 27, 2017
Power meter Anritsu	ML2495A	0824006	May 26, 2016	May 25, 2017
Power sensor Anritsu	MA2411B	0738172	May 26, 2016	May 25, 2017
AC Power Source Extech Electronics	6502	1140503	NA	NA
Temperature & Humidity Chamber TERCHY	MHU-225AU	911033	Dec. 02, 2016	Dec. 01, 2017
Digital Multimeter FLUKE	87III	73680266	Nov. 10, 2016	Nov. 09, 2017

Note:

1. The calibration interval of the above test instruments is 12 months and the calibrations are traceable to NML/ROC and NIST/USA.
2. *The calibration interval of the above test instruments is 24 months and the calibrations are traceable to NML/ROC and NIST/USA.
3. The test was performed in 966 Chamber No. 4.
4. The FCC Site Registration No. is 292998
5. The CANADA Site Registration No. is 20331-2
6. Loop antenna was used for all emissions below 30 MHz.
7. Tested Date: Feb. 06 to Mar. 16, 2017

4.1.3 Test Procedure

For Radiated emission below 30MHz

- a. The EUT was placed on the top of a rotating table 0.8 meters above the ground at a 3 meter chamber room. The table was rotated 360 degrees to determine the position of the highest radiation.
- b. The EUT was set 3 meters away from the interference-receiving antenna, which was mounted on the top of a variable-height antenna tower.
- c. Both X and Y axes of the antenna are set to make the measurement.
- d. For each suspected emission, the EUT was arranged to its worst case and the rotatable table was turned from 0 degrees to 360 degrees to find the maximum reading.
- e. The test-receiver system was set to Quasi-Peak Detect Function and Specified Bandwidth with Maximum Hold Mode.

NOTE:

1. The resolution bandwidth and video bandwidth of test receiver/spectrum analyzer is 9kHz at frequency below 30MHz.

For Radiated emission above 30MHz

- a. The EUT was placed on the top of a rotating table 0.8 meters (for 30MHz ~ 1GHz) / 1.5 meters (for above 1GHz) above the ground at 3 meter chamber room for test. The table was rotated 360 degrees to determine the position of the highest radiation.
- b. The EUT was set 3 meters away from the interference-receiving antenna, which was mounted on the top of a variable-height antenna tower.
- c. The height of antenna is varied from one meter to four meters above the ground to determine the maximum value of the field strength. Both horizontal and vertical polarizations of the antenna are set to make the measurement.
- d. For each suspected emission, the EUT was arranged to its worst case and then the antenna was tuned to heights from 1 meter to 4 meters and the rotatable table was turned from 0 degrees to 360 degrees to find the maximum reading.
- e. The test-receiver system was set to quasi-peak detect function and specified bandwidth with maximum hold mode when the test frequency is below 1 GHz.
- f. The test-receiver system was set to peak and average detect function and specified bandwidth with maximum hold mode when the test frequency is above 1 GHz. If the peak reading value also meets average limit, measurement with the average detector is unnecessary.

Note:

1. The resolution bandwidth and video bandwidth of test receiver/spectrum analyzer is 120kHz for Quasi-peak detection (QP) at frequency below 1GHz.
2. The resolution bandwidth of test receiver/spectrum analyzer is 1 MHz and the video bandwidth is 3 MHz for Peak detection (PK) at frequency above 1GHz.
3. The resolution bandwidth of test receiver/spectrum analyzer is 1MHz and the video bandwidth is $\geq 1/T$ (Duty cycle < 98%) or 10Hz (Duty cycle $\geq 98\%$) for Average detection (AV) at frequency above 1GHz.
4. All modes of operation were investigated and the worst-case emissions are reported.

4.1.4 Deviation from Test Standard

No deviation.

4.1.5 Test Setup

For Radiated emission below 30MHz

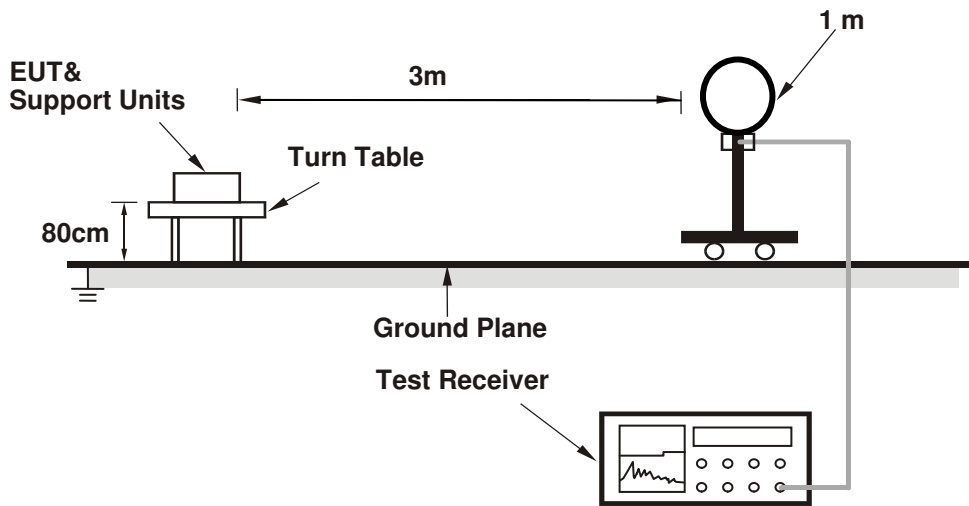

For Radiated emission 30MHz to 1GHz

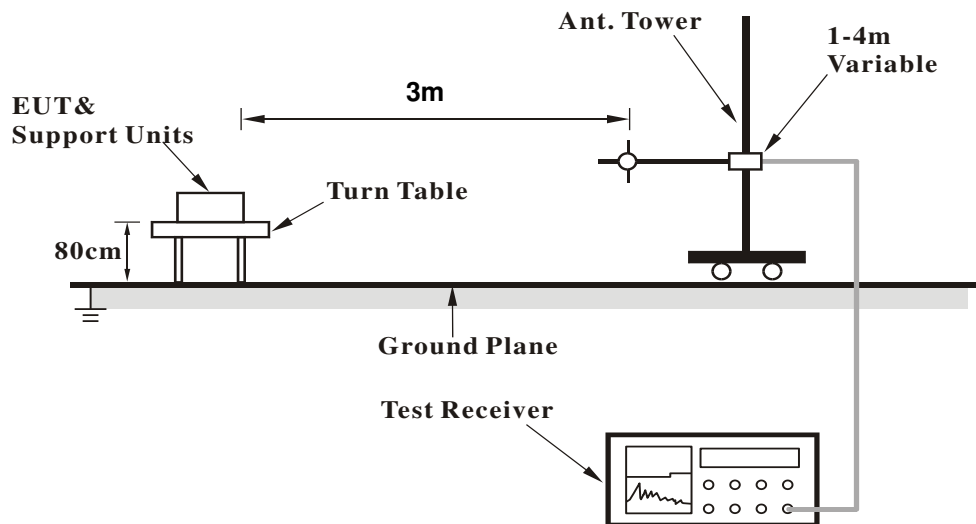

For Radiated emission above 1GHz

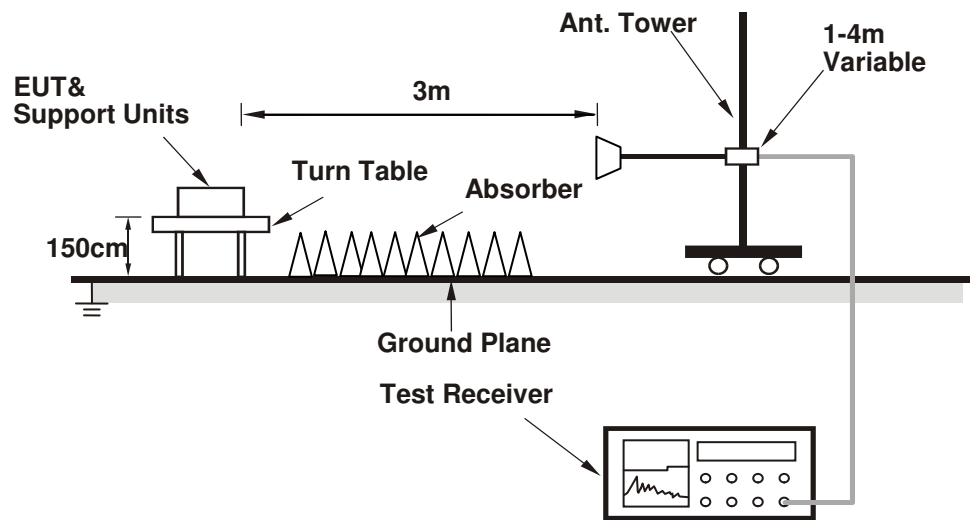

For the actual test configuration, please refer to the attached file (Test Setup Photo).

4.1.6 EUT Operating Condition

- a. Connected the EUT with the Laptop which is placed on remote site.
- b. Controlling software (MT7615 QA 0.0.1.73) has been activated to set the EUT on specific status.

4.1.7 Test Results (Mode 1)

Above 1GHz Data:

802.11a

CHANNEL	TX Channel 36	DETECTOR FUNCTION	Peak (PK)
FREQUENCY RANGE	1GHz ~ 40GHz		Average (AV)

ANTENNA POLARITY & TEST DISTANCE: HORIZONTAL AT 3 M

NO.	FREQ. (MHz)	EMISSION LEVEL (dBuV/m)	LIMIT (dBuV/m)	MARGIN (dB)	ANTENNA HEIGHT (m)	TABLE ANGLE (Degree)	RAW VALUE (dBuV)	CORRECTION FACTOR (dB/m)
1	5150.00	55.6 PK	74.0	-18.4	1.20 H	293	52.7	2.9
2	5150.00	44.3 AV	54.0	-9.7	1.20 H	293	41.4	2.9
3	*5180.00	110.6 PK			2.44 H	105	107.6	3.0
4	*5180.00	101.5 AV			2.44 H	105	98.5	3.0
5	#10360.00	59.8 PK	74.0	-14.2	1.82 H	306	47.9	11.9
6	#10360.00	47.3 AV	54.0	-6.7	1.82 H	306	35.4	11.9
7	15540.00	53.6 PK	74.0	-20.4	1.59 H	295	41.4	12.2
8	15540.00	41.1 AV	54.0	-12.9	1.59 H	295	28.9	12.2

ANTENNA POLARITY & TEST DISTANCE: VERTICAL AT 3 M

NO.	FREQ. (MHz)	EMISSION LEVEL (dBuV/m)	LIMIT (dBuV/m)	MARGIN (dB)	ANTENNA HEIGHT (m)	TABLE ANGLE (Degree)	RAW VALUE (dBuV)	CORRECTION FACTOR (dB/m)
1	5150.00	65.2 PK	74.0	-8.8	1.50 V	217	62.3	2.9
2	5150.00	53.9 AV	54.0	-0.1	1.50 V	217	51.0	2.9
3	*5180.00	120.9 PK			1.50 V	217	117.9	3.0
4	*5180.00	111.3 AV			1.50 V	217	108.3	3.0
5	#10360.00	59.8 PK	74.0	-14.2	1.42 V	33	47.9	11.9
6	#10360.00	46.6 AV	54.0	-7.4	1.42 V	33	34.7	11.9
7	15540.00	53.7 PK	74.0	-20.3	1.66 V	154	41.5	12.2
8	15540.00	40.9 AV	54.0	-13.1	1.66 V	154	28.7	12.2

REMARKS:

1. Emission Level(dBuV/m) = Raw Value(dBuV) + Correction Factor(dB/m)
2. Correction Factor(dB/m) = Antenna Factor(dB/m) + Cable Factor(dB) – Pre-Amplifier Factor(dB)
3. The other emission levels were very low against the limit.
4. Margin value = Emission Level – Limit value
5. " * ": Fundamental frequency.
6. " # ": The radiated frequency is out of the restricted band.

CHANNEL	TX Channel 40	DETECTOR FUNCTION	Peak (PK)
FREQUENCY RANGE	1GHz ~ 40GHz		Average (AV)

ANTENNA POLARITY & TEST DISTANCE: HORIZONTAL AT 3 M

NO.	FREQ. (MHz)	EMISSION LEVEL (dBuV/m)	LIMIT (dBuV/m)	MARGIN (dB)	ANTENNA HEIGHT (m)	TABLE ANGLE (Degree)	RAW VALUE (dBuV)	CORRECTION FACTOR (dB/m)
1	5150.00	53.8 PK	74.0	-20.2	1.23 H	297	50.9	2.9
2	5150.00	41.1 AV	54.0	-12.9	1.23 H	297	38.2	2.9
3	*5200.00	111.3 PK			2.45 H	103	108.3	3.0
4	*5200.00	101.5 AV			2.45 H	103	98.5	3.0
5	#10400.00	59.9 PK	74.0	-14.1	1.79 H	300	48.0	11.9
6	#10400.00	47.0 AV	54.0	-7.0	1.79 H	300	35.1	11.9
7	15600.00	53.5 PK	74.0	-20.5	1.60 H	288	41.2	12.3
8	15600.00	40.8 AV	54.0	-13.2	1.60 H	288	28.5	12.3

ANTENNA POLARITY & TEST DISTANCE: VERTICAL AT 3 M

NO.	FREQ. (MHz)	EMISSION LEVEL (dBuV/m)	LIMIT (dBuV/m)	MARGIN (dB)	ANTENNA HEIGHT (m)	TABLE ANGLE (Degree)	RAW VALUE (dBuV)	CORRECTION FACTOR (dB/m)
1	5150.00	57.7 PK	74.0	-16.3	1.50 V	215	54.8	2.9
2	5150.00	46.1 AV	54.0	-7.9	1.50 V	215	43.2	2.9
3	*5200.00	121.5 PK			1.50 V	215	118.5	3.0
4	*5200.00	111.9 AV			1.50 V	215	108.9	3.0
5	#10400.00	59.4 PK	74.0	-14.6	1.36 V	46	47.5	11.9
6	#10400.00	46.4 AV	54.0	-7.6	1.36 V	46	34.5	11.9
7	15600.00	53.6 PK	74.0	-20.4	1.62 V	153	41.3	12.3
8	15600.00	40.5 AV	54.0	-13.5	1.62 V	153	28.2	12.3

REMARKS:

1. Emission Level(dBuV/m) = Raw Value(dBuV) + Correction Factor(dB/m)
2. Correction Factor(dB/m) = Antenna Factor(dB/m) + Cable Factor(dB) – Pre-Amplifier Factor(dB)
3. The other emission levels were very low against the limit.
4. Margin value = Emission Level – Limit value
5. " * ": Fundamental frequency.
6. " # ": The radiated frequency is out of the restricted band.

CHANNEL	TX Channel 48	DETECTOR FUNCTION	Peak (PK)
FREQUENCY RANGE	1GHz ~ 40GHz		Average (AV)

ANTENNA POLARITY & TEST DISTANCE: HORIZONTAL AT 3 M

NO.	FREQ. (MHz)	EMISSION LEVEL (dBuV/m)	LIMIT (dBuV/m)	MARGIN (dB)	ANTENNA HEIGHT (m)	TABLE ANGLE (Degree)	RAW VALUE (dBuV)	CORRECTION FACTOR (dB/m)
1	5150.00	51.1 PK	74.0	-22.9	1.21 H	301	48.2	2.9
2	5150.00	38.8 AV	54.0	-15.2	1.21 H	301	35.9	2.9
3	*5240.00	110.2 PK			2.46 H	125	107.1	3.1
4	*5240.00	101.3 AV			2.46 H	125	98.2	3.1
5	#10480.00	60.3 PK	74.0	-13.7	1.79 H	302	48.4	11.9
6	#10480.00	47.2 AV	54.0	-6.8	1.79 H	302	35.3	11.9
7	15720.00	53.3 PK	74.0	-20.7	1.55 H	281	40.3	13.0
8	15720.00	40.6 AV	54.0	-13.4	1.55 H	281	27.6	13.0

ANTENNA POLARITY & TEST DISTANCE: VERTICAL AT 3 M

NO.	FREQ. (MHz)	EMISSION LEVEL (dBuV/m)	LIMIT (dBuV/m)	MARGIN (dB)	ANTENNA HEIGHT (m)	TABLE ANGLE (Degree)	RAW VALUE (dBuV)	CORRECTION FACTOR (dB/m)
1	5150.00	55.4 PK	74.0	-18.6	1.50 V	215	52.5	2.9
2	5150.00	42.3 AV	54.0	-11.7	1.50 V	215	39.4	2.9
3	*5240.00	121.3 PK			1.50 V	215	118.2	3.1
4	*5240.00	111.8 AV			1.50 V	215	108.7	3.1
5	#10480.00	59.4 PK	74.0	-14.6	1.39 V	44	47.5	11.9
6	#10480.00	46.4 AV	54.0	-7.6	1.39 V	44	34.5	11.9
7	15720.00	53.5 PK	74.0	-20.5	1.64 V	141	40.5	13.0
8	15720.00	40.7 AV	54.0	-13.3	1.64 V	141	27.7	13.0

REMARKS:

1. Emission Level(dBuV/m) = Raw Value(dBuV) + Correction Factor(dB/m)
2. Correction Factor(dB/m) = Antenna Factor(dB/m) + Cable Factor(dB) – Pre-Amplifier Factor(dB)
3. The other emission levels were very low against the limit.
4. Margin value = Emission Level – Limit value
5. " * ": Fundamental frequency.
6. " # ": The radiated frequency is out of the restricted band.

CHANNEL	TX Channel 149	DETECTOR FUNCTION	Peak (PK)
FREQUENCY RANGE	1GHz ~ 40GHz		Average (AV)

ANTENNA POLARITY & TEST DISTANCE: HORIZONTAL AT 3 M

NO.	FREQ. (MHz)	EMISSION LEVEL (dBuV/m)	LIMIT (dBuV/m)	MARGIN (dB)	ANTENNA HEIGHT (m)	TABLE ANGLE (Degree)	RAW VALUE (dBuV)	CORRECTION FACTOR (dB/m)
1	#5626.69	62.7 PK	68.2	-5.5	1.49 H	64	58.9	3.8
2	*5745.00	111.1 PK			1.49 H	64	107.1	4.0
3	*5745.00	101.7 AV			1.49 H	64	97.7	4.0
4	#5981.50	62.3 PK	68.2	-5.9	1.49 H	64	57.2	5.1
5	11490.00	59.5 PK	74.0	-14.5	1.72 H	341	46.7	12.8
6	11490.00	47.5 AV	54.0	-6.5	1.72 H	341	34.7	12.8
7	#17235.00	52.9 PK	74.0	-21.1	1.50 H	330	35.5	17.4
8	#17235.00	38.8 AV	54.0	-15.2	1.50 H	330	21.4	17.4

ANTENNA POLARITY & TEST DISTANCE: VERTICAL AT 3 M

NO.	FREQ. (MHz)	EMISSION LEVEL (dBuV/m)	LIMIT (dBuV/m)	MARGIN (dB)	ANTENNA HEIGHT (m)	TABLE ANGLE (Degree)	RAW VALUE (dBuV)	CORRECTION FACTOR (dB/m)
1	#5648.46	67.9 PK	68.2	-0.3	1.50 V	157	64.0	3.9
2	*5745.00	124.3 PK			1.50 V	157	120.3	4.0
3	*5745.00	114.9 AV			1.50 V	157	110.9	4.0
4	#5952.68	65.7 PK	68.2	-2.5	1.50 V	157	61.1	4.6
5	11490.00	58.0 PK	74.0	-16.0	1.50 V	360	45.2	12.8
6	11490.00	45.3 AV	54.0	-8.7	1.50 V	360	32.5	12.8
7	#17235.00	52.2 PK	74.0	-21.8	1.49 V	221	34.8	17.4
8	#17235.00	38.3 AV	54.0	-15.7	1.49 V	221	20.9	17.4

REMARKS:

1. Emission Level(dBuV/m) = Raw Value(dBuV) + Correction Factor(dB/m)
2. Correction Factor(dB/m) = Antenna Factor(dB/m) + Cable Factor(dB) – Pre-Amplifier Factor(dB)
3. The other emission levels were very low against the limit.
4. Margin value = Emission Level – Limit value
5. " * ": Fundamental frequency.
6. " # ": The radiated frequency is out of the restricted band.

CHANNEL	TX Channel 157	DETECTOR FUNCTION	Peak (PK)
FREQUENCY RANGE	1GHz ~ 40GHz		Average (AV)

ANTENNA POLARITY & TEST DISTANCE: HORIZONTAL AT 3 M

NO.	FREQ. (MHz)	EMISSION LEVEL (dBuV/m)	LIMIT (dBuV/m)	MARGIN (dB)	ANTENNA HEIGHT (m)	TABLE ANGLE (Degree)	RAW VALUE (dBuV)	CORRECTION FACTOR (dB/m)
1	#5607.62	62.2 PK	68.2	-6.0	1.48 H	52	58.4	3.8
2	*5785.00	110.6 PK			1.48 H	52	106.6	4.0
3	*5785.00	101.2 AV			1.48 H	52	97.2	4.0
4	#5946.92	63.3 PK	68.2	-4.9	1.48 H	52	58.7	4.6
5	11570.00	59.2 PK	74.0	-14.8	1.78 H	326	46.6	12.6
6	11570.00	47.3 AV	54.0	-6.7	1.78 H	326	34.7	12.6
7	#17355.00	52.6 PK	74.0	-21.4	1.52 H	336	34.5	18.1
8	#17355.00	38.8 AV	54.0	-15.2	1.52 H	336	20.7	18.1

ANTENNA POLARITY & TEST DISTANCE: VERTICAL AT 3 M

NO.	FREQ. (MHz)	EMISSION LEVEL (dBuV/m)	LIMIT (dBuV/m)	MARGIN (dB)	ANTENNA HEIGHT (m)	TABLE ANGLE (Degree)	RAW VALUE (dBuV)	CORRECTION FACTOR (dB/m)
1	#5640.95	67.3 PK	68.2	-0.9	1.50 V	157	63.4	3.9
2	*5785.00	124.1 PK			1.50 V	157	120.1	4.0
3	*5785.00	115.2 AV			1.50 V	157	111.2	4.0
4	#5922.22	65.1 PK	70.2	-5.1	1.50 V	157	60.7	4.4
5	11570.00	58.4 PK	74.0	-15.6	1.57 V	328	45.8	12.6
6	11570.00	46.1 AV	54.0	-7.9	1.57 V	328	33.5	12.6
7	#17355.00	52.3 PK	74.0	-21.7	1.40 V	221	34.2	18.1
8	#17355.00	38.5 AV	54.0	-15.5	1.40 V	221	20.4	18.1

REMARKS:

1. Emission Level(dBuV/m) = Raw Value(dBuV) + Correction Factor(dB/m)
2. Correction Factor(dB/m) = Antenna Factor(dB/m) + Cable Factor(dB) – Pre-Amplifier Factor(dB)
3. The other emission levels were very low against the limit.
4. Margin value = Emission Level – Limit value
5. " * ": Fundamental frequency.
6. " # ": The radiated frequency is out of the restricted band.

CHANNEL	TX Channel 165	DETECTOR FUNCTION	Peak (PK)
FREQUENCY RANGE	1GHz ~ 40GHz		Average (AV)

ANTENNA POLARITY & TEST DISTANCE: HORIZONTAL AT 3 M

NO.	FREQ. (MHz)	EMISSION LEVEL (dBuV/m)	LIMIT (dBuV/m)	MARGIN (dB)	ANTENNA HEIGHT (m)	TABLE ANGLE (Degree)	RAW VALUE (dBuV)	CORRECTION FACTOR (dB/m)
1	#5621.84	64.1 PK	68.2	-4.1	1.50 H	42	60.3	3.8
2	*5825.00	109.8 PK			1.50 H	42	105.7	4.1
3	*5825.00	100.7 AV			1.50 H	42	96.6	4.1
4	#5967.26	62.2 PK	68.2	-6.0	1.50 H	42	57.3	4.9
5	11650.00	59.4 PK	74.0	-14.6	1.74 H	329	46.7	12.7
6	11650.00	47.5 AV	54.0	-6.5	1.74 H	329	34.8	12.7
7	#17475.00	52.7 PK	74.0	-21.3	1.49 H	329	33.8	18.9
8	#17475.00	39.1 AV	54.0	-14.9	1.49 H	329	20.2	18.9

ANTENNA POLARITY & TEST DISTANCE: VERTICAL AT 3 M

NO.	FREQ. (MHz)	EMISSION LEVEL (dBuV/m)	LIMIT (dBuV/m)	MARGIN (dB)	ANTENNA HEIGHT (m)	TABLE ANGLE (Degree)	RAW VALUE (dBuV)	CORRECTION FACTOR (dB/m)
1	#5630.45	65.9 PK	68.2	-2.3	1.50 V	157	62.1	3.8
2	*5825.00	125.3 PK			1.50 V	157	121.2	4.1
3	*5825.00	115.2 AV			1.50 V	157	111.1	4.1
4	#5941.34	67.5 PK	68.2	-0.7	1.50 V	157	62.9	4.6
5	11650.00	58.1 PK	74.0	-15.9	1.51 V	346	45.4	12.7
6	11650.00	45.6 AV	54.0	-8.4	1.51 V	346	32.9	12.7
7	#17475.00	52.4 PK	74.0	-21.6	1.44 V	210	33.5	18.9
8	#17475.00	38.9 AV	54.0	-15.1	1.44 V	210	20.0	18.9

REMARKS:

1. Emission Level(dBuV/m) = Raw Value(dBuV) + Correction Factor(dB/m)
2. Correction Factor(dB/m) = Antenna Factor(dB/m) + Cable Factor(dB) – Pre-Amplifier Factor(dB)
3. The other emission levels were very low against the limit.
4. Margin value = Emission Level – Limit value
5. " * ": Fundamental frequency.
6. " # ": The radiated frequency is out of the restricted band.

802.11ac (VHT20)

CHANNEL	TX Channel 36	DETECTOR FUNCTION	Peak (PK)
FREQUENCY RANGE	1GHz ~ 40GHz		Average (AV)

ANTENNA POLARITY & TEST DISTANCE: HORIZONTAL AT 3 M

NO.	FREQ. (MHz)	EMISSION LEVEL (dBuV/m)	LIMIT (dBuV/m)	MARGIN (dB)	ANTENNA HEIGHT (m)	TABLE ANGLE (Degree)	RAW VALUE (dBuV)	CORRECTION FACTOR (dB/m)
1	5150.00	56.2 PK	74.0	-17.8	1.19 H	284	53.3	2.9
2	5150.00	44.1 AV	54.0	-9.9	1.19 H	284	41.2	2.9
3	*5180.00	111.0 PK			1.19 H	284	108.0	3.0
4	*5180.00	101.4 AV			1.19 H	284	98.4	3.0
5	#10360.00	59.8 PK	74.0	-14.2	1.77 H	301	47.9	11.9
6	#10360.00	46.8 AV	54.0	-7.2	1.77 H	301	34.9	11.9
7	15540.00	53.1 PK	74.0	-20.9	1.61 H	283	40.9	12.2
8	15540.00	40.4 AV	54.0	-13.6	1.61 H	283	28.2	12.2

ANTENNA POLARITY & TEST DISTANCE: VERTICAL AT 3 M

NO.	FREQ. (MHz)	EMISSION LEVEL (dBuV/m)	LIMIT (dBuV/m)	MARGIN (dB)	ANTENNA HEIGHT (m)	TABLE ANGLE (Degree)	RAW VALUE (dBuV)	CORRECTION FACTOR (dB/m)
1	5150.00	65.8 PK	74.0	-8.2	1.50 V	215	62.9	2.9
2	5150.00	53.5 AV	54.0	-0.5	1.50 V	215	50.6	2.9
3	*5180.00	121.1 PK			1.50 V	215	118.1	3.0
4	*5180.00	111.4 AV			1.50 V	215	108.4	3.0
5	#10360.00	59.2 PK	74.0	-14.8	1.32 V	59	47.3	11.9
6	#10360.00	46.0 AV	54.0	-8.0	1.32 V	59	34.1	11.9
7	15540.00	54.1 PK	74.0	-19.9	1.67 V	139	41.9	12.2
8	15540.00	41.0 AV	54.0	-13.0	1.67 V	139	28.8	12.2

REMARKS:

- Emission Level(dBuV/m) = Raw Value(dBuV) + Correction Factor(dB/m)
- Correction Factor(dB/m) = Antenna Factor(dB/m) + Cable Factor(dB) – Pre-Amplifier Factor(dB)
- The other emission levels were very low against the limit.
- Margin value = Emission Level – Limit value
- " * ": Fundamental frequency.
- " # ": The radiated frequency is out of the restricted band.

CHANNEL	TX Channel 40	DETECTOR FUNCTION	Peak (PK)
FREQUENCY RANGE	1GHz ~ 40GHz		Average (AV)

ANTENNA POLARITY & TEST DISTANCE: HORIZONTAL AT 3 M

NO.	FREQ. (MHz)	EMISSION LEVEL (dBuV/m)	LIMIT (dBuV/m)	MARGIN (dB)	ANTENNA HEIGHT (m)	TABLE ANGLE (Degree)	RAW VALUE (dBuV)	CORRECTION FACTOR (dB/m)
1	5150.00	53.8 PK	74.0	-20.2	1.19 H	305	50.9	2.9
2	5150.00	40.8 AV	54.0	-13.2	1.19 H	305	37.9	2.9
3	*5200.00	111.8 PK			1.19 H	305	108.8	3.0
4	*5200.00	102.0 AV			1.19 H	305	99.0	3.0
5	#10400.00	60.0 PK	74.0	-14.0	1.85 H	303	48.1	11.9
6	#10400.00	47.3 AV	54.0	-6.7	1.85 H	303	35.4	11.9
7	15600.00	53.0 PK	74.0	-21.0	1.61 H	295	40.7	12.3
8	15600.00	40.4 AV	54.0	-13.6	1.61 H	295	28.1	12.3

ANTENNA POLARITY & TEST DISTANCE: VERTICAL AT 3 M

NO.	FREQ. (MHz)	EMISSION LEVEL (dBuV/m)	LIMIT (dBuV/m)	MARGIN (dB)	ANTENNA HEIGHT (m)	TABLE ANGLE (Degree)	RAW VALUE (dBuV)	CORRECTION FACTOR (dB/m)
1	5150.00	57.8 PK	74.0	-16.2	1.51 V	217	54.9	2.9
2	5150.00	46.3 AV	54.0	-7.7	1.51 V	217	43.4	2.9
3	*5200.00	121.5 PK			1.51 V	217	118.5	3.0
4	*5200.00	111.6 AV			1.51 V	217	108.6	3.0
5	#10400.00	59.1 PK	74.0	-14.9	1.34 V	51	47.2	11.9
6	#10400.00	46.3 AV	54.0	-7.7	1.34 V	51	34.4	11.9
7	15600.00	53.8 PK	74.0	-20.2	1.66 V	142	41.5	12.3
8	15600.00	40.8 AV	54.0	-13.2	1.66 V	142	28.5	12.3

REMARKS:

1. Emission Level(dBuV/m) = Raw Value(dBuV) + Correction Factor(dB/m)
2. Correction Factor(dB/m) = Antenna Factor(dB/m) + Cable Factor(dB) – Pre-Amplifier Factor(dB)
3. The other emission levels were very low against the limit.
4. Margin value = Emission Level – Limit value
5. " * ": Fundamental frequency.
6. " # ": The radiated frequency is out of the restricted band.

CHANNEL	TX Channel 48	DETECTOR FUNCTION	Peak (PK)
FREQUENCY RANGE	1GHz ~ 40GHz		Average (AV)

ANTENNA POLARITY & TEST DISTANCE: HORIZONTAL AT 3 M

NO.	FREQ. (MHz)	EMISSION LEVEL (dBuV/m)	LIMIT (dBuV/m)	MARGIN (dB)	ANTENNA HEIGHT (m)	TABLE ANGLE (Degree)	RAW VALUE (dBuV)	CORRECTION FACTOR (dB/m)
1	5150.00	52.2 PK	74.0	-21.8	1.24 H	302	49.3	2.9
2	5150.00	38.5 AV	54.0	-15.5	1.24 H	302	35.6	2.9
3	*5240.00	111.4 PK			1.24 H	302	108.3	3.1
4	*5240.00	101.5 AV			1.24 H	302	98.4	3.1
5	#10480.00	60.2 PK	74.0	-13.8	1.78 H	306	48.3	11.9
6	#10480.00	47.4 AV	54.0	-6.6	1.78 H	306	35.5	11.9
7	15720.00	53.9 PK	74.0	-20.1	1.57 H	287	40.9	13.0
8	15720.00	41.0 AV	54.0	-13.0	1.57 H	287	28.0	13.0

ANTENNA POLARITY & TEST DISTANCE: VERTICAL AT 3 M

NO.	FREQ. (MHz)	EMISSION LEVEL (dBuV/m)	LIMIT (dBuV/m)	MARGIN (dB)	ANTENNA HEIGHT (m)	TABLE ANGLE (Degree)	RAW VALUE (dBuV)	CORRECTION FACTOR (dB/m)
1	5150.00	55.1 PK	74.0	-18.9	1.50 V	217	52.2	2.9
2	5150.00	42.5 AV	54.0	-11.5	1.50 V	217	39.6	2.9
3	*5240.00	121.3 PK			1.50 V	217	118.2	3.1
4	*5240.00	111.4 AV			1.50 V	217	108.3	3.1
5	#10480.00	59.6 PK	74.0	-14.4	1.32 V	45	47.7	11.9
6	#10480.00	46.6 AV	54.0	-7.4	1.32 V	45	34.7	11.9
7	15720.00	53.1 PK	74.0	-20.9	1.68 V	167	40.1	13.0
8	15720.00	40.3 AV	54.0	-13.7	1.68 V	167	27.3	13.0

REMARKS:

1. Emission Level(dBuV/m) = Raw Value(dBuV) + Correction Factor(dB/m)
2. Correction Factor(dB/m) = Antenna Factor(dB/m) + Cable Factor(dB) – Pre-Amplifier Factor(dB)
3. The other emission levels were very low against the limit.
4. Margin value = Emission Level – Limit value
5. " * ": Fundamental frequency.
6. " # ": The radiated frequency is out of the restricted band.

CHANNEL	TX Channel 149	DETECTOR FUNCTION	Peak (PK)
FREQUENCY RANGE	1GHz ~ 40GHz		Average (AV)

ANTENNA POLARITY & TEST DISTANCE: HORIZONTAL AT 3 M

NO.	FREQ. (MHz)	EMISSION LEVEL (dBuV/m)	LIMIT (dBuV/m)	MARGIN (dB)	ANTENNA HEIGHT (m)	TABLE ANGLE (Degree)	RAW VALUE (dBuV)	CORRECTION FACTOR (dB/m)
1	#5646.39	63.1 PK	68.2	-5.1	2.37 H	129	59.2	3.9
2	*5745.00	115.2 PK			2.41 H	116	111.2	4.0
3	*5745.00	105.2 AV			2.41 H	116	101.2	4.0
4	#5995.32	63.3 PK	68.2	-4.9	2.37 H	129	58.1	5.2
5	11490.00	59.4 PK	74.0	-14.6	1.75 H	334	46.6	12.8
6	11490.00	47.1 AV	54.0	-6.9	1.75 H	334	34.3	12.8
7	#17235.00	53.0 PK	74.0	-21.0	1.52 H	323	35.6	17.4
8	#17235.00	39.2 AV	54.0	-14.8	1.52 H	323	21.8	17.4

ANTENNA POLARITY & TEST DISTANCE: VERTICAL AT 3 M

NO.	FREQ. (MHz)	EMISSION LEVEL (dBuV/m)	LIMIT (dBuV/m)	MARGIN (dB)	ANTENNA HEIGHT (m)	TABLE ANGLE (Degree)	RAW VALUE (dBuV)	CORRECTION FACTOR (dB/m)
1	#5630.09	68.0 PK	68.2	-0.2	1.50 V	156	64.2	3.8
2	*5745.00	124.4 PK			1.50 V	156	120.4	4.0
3	*5745.00	115.4 AV			1.50 V	156	111.4	4.0
4	#5946.33	64.7 PK	68.2	-3.5	1.50 V	156	60.1	4.6
5	11490.00	57.9 PK	74.0	-16.1	1.48 V	360	45.1	12.8
6	11490.00	45.5 AV	54.0	-8.5	1.48 V	360	32.7	12.8
7	#17235.00	52.0 PK	74.0	-22.0	1.48 V	215	34.6	17.4
8	#17235.00	37.9 AV	54.0	-16.1	1.48 V	215	20.5	17.4

REMARKS:

1. Emission Level(dBuV/m) = Raw Value(dBuV) + Correction Factor(dB/m)
2. Correction Factor(dB/m) = Antenna Factor(dB/m) + Cable Factor(dB) – Pre-Amplifier Factor(dB)
3. The other emission levels were very low against the limit.
4. Margin value = Emission Level – Limit value
5. " * ": Fundamental frequency.
6. " # ": The radiated frequency is out of the restricted band.

CHANNEL	TX Channel 157	DETECTOR FUNCTION	Peak (PK)
FREQUENCY RANGE	1GHz ~ 40GHz		Average (AV)

ANTENNA POLARITY & TEST DISTANCE: HORIZONTAL AT 3 M

NO.	FREQ. (MHz)	EMISSION LEVEL (dBuV/m)	LIMIT (dBuV/m)	MARGIN (dB)	ANTENNA HEIGHT (m)	TABLE ANGLE (Degree)	RAW VALUE (dBuV)	CORRECTION FACTOR (dB/m)
1	#5619.23	63.1 PK	68.2	-5.1	2.33 H	141	59.3	3.8
2	*5785.00	115.2 PK			2.33 H	141	111.2	4.0
3	*5785.00	105.4 AV			2.33 H	141	101.4	4.0
4	#5950.12	62.4 PK	68.2	-5.8	2.33 H	141	57.8	4.6
5	11570.00	59.5 PK	74.0	-14.5	1.75 H	295	46.9	12.6
6	11570.00	47.2 AV	54.0	-6.8	1.75 H	295	34.6	12.6
7	#17355.00	52.8 PK	74.0	-21.2	1.55 H	345	34.7	18.1
8	#17355.00	38.5 AV	54.0	-15.5	1.55 H	345	20.4	18.1

ANTENNA POLARITY & TEST DISTANCE: VERTICAL AT 3 M

NO.	FREQ. (MHz)	EMISSION LEVEL (dBuV/m)	LIMIT (dBuV/m)	MARGIN (dB)	ANTENNA HEIGHT (m)	TABLE ANGLE (Degree)	RAW VALUE (dBuV)	CORRECTION FACTOR (dB/m)
1	#5645.51	68.1 PK	68.2	-0.1	1.48 V	156	64.2	3.9
2	*5785.00	125.0 PK			1.48 V	156	121.0	4.0
3	*5785.00	115.3 AV			1.48 V	156	111.3	4.0
4	#5927.64	64.2 PK	68.2	-4.0	1.48 V	156	59.7	4.5
5	11570.00	59.0 PK	74.0	-15.0	1.56 V	342	46.4	12.6
6	11570.00	46.4 AV	54.0	-7.6	1.56 V	342	33.8	12.6
7	#17355.00	51.9 PK	74.0	-22.1	1.38 V	225	33.8	18.1
8	#17355.00	38.4 AV	54.0	-15.6	1.38 V	225	20.3	18.1

REMARKS:

- Emission Level(dBuV/m) = Raw Value(dBuV) + Correction Factor(dB/m)
- Correction Factor(dB/m) = Antenna Factor(dB/m) + Cable Factor(dB) – Pre-Amplifier Factor(dB)
- The other emission levels were very low against the limit.
- Margin value = Emission Level – Limit value
- " * ": Fundamental frequency.
- " # ": The radiated frequency is out of the restricted band.

CHANNEL	TX Channel 165	DETECTOR FUNCTION	Peak (PK)
FREQUENCY RANGE	1GHz ~ 40GHz		Average (AV)

ANTENNA POLARITY & TEST DISTANCE: HORIZONTAL AT 3 M

NO.	FREQ. (MHz)	EMISSION LEVEL (dBuV/m)	LIMIT (dBuV/m)	MARGIN (dB)	ANTENNA HEIGHT (m)	TABLE ANGLE (Degree)	RAW VALUE (dBuV)	CORRECTION FACTOR (dB/m)
1	#5612.78	62.3 PK	68.2	-5.9	2.37 H	129	58.5	3.8
2	*5825.00	115.9 PK			2.37 H	129	111.8	4.1
3	*5825.00	105.9 AV			2.37 H	129	101.8	4.1
4	#5949.15	63.2 PK	68.2	-5.0	2.37 H	129	58.6	4.6
5	11650.00	59.8 PK	74.0	-14.2	1.84 H	286	47.1	12.7
6	11650.00	47.3 AV	54.0	-6.7	1.84 H	286	34.6	12.7
7	#17475.00	52.9 PK	74.0	-21.1	1.49 H	345	34.0	18.9
8	#17475.00	39.0 AV	54.0	-15.0	1.49 H	345	20.1	18.9

ANTENNA POLARITY & TEST DISTANCE: VERTICAL AT 3 M

NO.	FREQ. (MHz)	EMISSION LEVEL (dBuV/m)	LIMIT (dBuV/m)	MARGIN (dB)	ANTENNA HEIGHT (m)	TABLE ANGLE (Degree)	RAW VALUE (dBuV)	CORRECTION FACTOR (dB/m)
1	#5638.94	66.9 PK	68.2	-1.3	1.49 V	156	63.1	3.8
2	*5825.00	124.8 PK			1.49 V	156	120.7	4.1
3	*5825.00	115.2 AV			1.49 V	156	111.1	4.1
4	#5959.81	66.2 PK	68.2	-2.0	1.49 V	156	61.4	4.8
5	11650.00	57.9 PK	74.0	-16.1	1.58 V	355	45.2	12.7
6	11650.00	45.9 AV	54.0	-8.1	1.58 V	355	33.2	12.7
7	#17475.00	52.4 PK	74.0	-21.6	1.41 V	211	33.5	18.9
8	#17475.00	38.4 AV	54.0	-15.6	1.41 V	211	19.5	18.9

REMARKS:

1. Emission Level(dBuV/m) = Raw Value(dBuV) + Correction Factor(dB/m)
2. Correction Factor(dB/m) = Antenna Factor(dB/m) + Cable Factor(dB) – Pre-Amplifier Factor(dB)
3. The other emission levels were very low against the limit.
4. Margin value = Emission Level – Limit value
5. " * ": Fundamental frequency.
6. " # ": The radiated frequency is out of the restricted band.

802.11ac (VHT40)

CHANNEL	TX Channel 38	DETECTOR FUNCTION	Peak (PK)
FREQUENCY RANGE	1GHz ~ 40GHz		Average (AV)

ANTENNA POLARITY & TEST DISTANCE: HORIZONTAL AT 3 M

NO.	FREQ. (MHz)	EMISSION LEVEL (dBuV/m)	LIMIT (dBuV/m)	MARGIN (dB)	ANTENNA HEIGHT (m)	TABLE ANGLE (Degree)	RAW VALUE (dBuV)	CORRECTION FACTOR (dB/m)
1	5150.00	58.9 PK	74.0	-15.1	1.21 H	318	56.0	2.9
2	5150.00	43.9 AV	54.0	-10.1	1.21 H	318	41.0	2.9
3	*5190.00	105.5 PK			1.21 H	318	102.5	3.0
4	*5190.00	95.8 AV			1.21 H	318	92.8	3.0
5	5350.00	52.3 PK	74.0	-21.7	1.21 H	318	48.9	3.4
6	5350.00	38.7 AV	54.0	-15.3	1.21 H	318	35.3	3.4
7	#10380.00	60.1 PK	74.0	-13.9	1.73 H	301	48.1	12.0
8	#10380.00	47.5 AV	54.0	-6.5	1.73 H	301	35.5	12.0
9	15570.00	54.1 PK	74.0	-19.9	1.52 H	289	41.8	12.3
10	15570.00	41.1 AV	54.0	-12.9	1.52 H	289	28.8	12.3

ANTENNA POLARITY & TEST DISTANCE: VERTICAL AT 3 M

NO.	FREQ. (MHz)	EMISSION LEVEL (dBuV/m)	LIMIT (dBuV/m)	MARGIN (dB)	ANTENNA HEIGHT (m)	TABLE ANGLE (Degree)	RAW VALUE (dBuV)	CORRECTION FACTOR (dB/m)
1	5150.00	68.6 PK	74.0	-5.4	1.49 V	216	65.7	2.9
2	5150.00	53.6 AV	54.0	-0.4	1.49 V	216	50.7	2.9
3	*5190.00	115.8 PK			1.49 V	216	112.8	3.0
4	*5190.00	106.1 AV			1.49 V	216	103.1	3.0
5	5350.00	58.6 PK	74.0	-15.4	1.49 V	216	55.2	3.4
6	5350.00	46.2 AV	54.0	-7.8	1.49 V	216	42.8	3.4
7	#10380.00	58.2 PK	74.0	-15.8	1.26 V	51	46.2	12.0
8	#10380.00	44.8 AV	54.0	-9.2	1.26 V	51	32.8	12.0
9	15570.00	54.0 PK	74.0	-20.0	1.69 V	140	41.7	12.3
10	15570.00	41.0 AV	54.0	-13.0	1.69 V	140	28.7	12.3

REMARKS:

1. Emission Level(dBuV/m) = Raw Value(dBuV) + Correction Factor(dB/m)
2. Correction Factor(dB/m) = Antenna Factor(dB/m) + Cable Factor(dB) – Pre-Amplifier Factor(dB)
3. The other emission levels were very low against the limit.
4. Margin value = Emission Level – Limit value
5. " * ": Fundamental frequency.
6. " # ": The radiated frequency is out of the restricted band.

CHANNEL	TX Channel 46	DETECTOR FUNCTION	Peak (PK)
FREQUENCY RANGE	1GHz ~ 40GHz		Average (AV)

ANTENNA POLARITY & TEST DISTANCE: HORIZONTAL AT 3 M

NO.	FREQ. (MHz)	EMISSION LEVEL (dBuV/m)	LIMIT (dBuV/m)	MARGIN (dB)	ANTENNA HEIGHT (m)	TABLE ANGLE (Degree)	RAW VALUE (dBuV)	CORRECTION FACTOR (dB/m)
1	5150.00	55.6 PK	74.0	-18.4	1.20 H	305	52.7	2.9
2	5150.00	43.7 AV	54.0	-10.3	1.20 H	305	40.8	2.9
3	*5230.00	111.2 PK			1.20 H	305	108.1	3.1
4	*5230.00	100.3 AV			1.20 H	305	97.2	3.1
5	5350.00	54.3 PK	74.0	-19.7	1.20 H	305	50.9	3.4
6	5350.00	42.6 AV	54.0	-11.4	1.20 H	305	39.2	3.4
7	#10460.00	60.0 PK	74.0	-14.0	1.82 H	301	48.0	12.0
8	#10460.00	47.1 AV	54.0	-6.9	1.82 H	301	35.1	12.0
9	15690.00	53.9 PK	74.0	-20.1	1.59 H	287	40.9	13.0
10	15690.00	41.1 AV	54.0	-12.9	1.59 H	287	28.1	13.0

ANTENNA POLARITY & TEST DISTANCE: VERTICAL AT 3 M

NO.	FREQ. (MHz)	EMISSION LEVEL (dBuV/m)	LIMIT (dBuV/m)	MARGIN (dB)	ANTENNA HEIGHT (m)	TABLE ANGLE (Degree)	RAW VALUE (dBuV)	CORRECTION FACTOR (dB/m)
1	5150.00	63.9 PK	74.0	-10.1	1.51 V	216	61.0	2.9
2	5150.00	53.4 AV	54.0	-0.6	1.51 V	216	50.5	2.9
3	*5230.00	121.6 PK			1.51 V	216	118.5	3.1
4	*5230.00	110.6 AV			1.51 V	216	107.5	3.1
5	5350.00	62.8 PK	74.0	-11.2	1.51 V	216	59.4	3.4
6	5350.00	52.1 AV	54.0	-1.9	1.51 V	216	48.7	3.4
7	#10460.00	59.1 PK	74.0	-14.9	1.31 V	39	47.1	12.0
8	#10460.00	46.2 AV	54.0	-7.8	1.31 V	39	34.2	12.0
9	15690.00	52.6 PK	74.0	-21.4	1.71 V	151	39.6	13.0
10	15690.00	39.8 AV	54.0	-14.2	1.71 V	151	26.8	13.0

REMARKS:

1. Emission Level(dBuV/m) = Raw Value(dBuV) + Correction Factor(dB/m)
2. Correction Factor(dB/m) = Antenna Factor(dB/m) + Cable Factor(dB) – Pre-Amplifier Factor(dB)
3. The other emission levels were very low against the limit.
4. Margin value = Emission Level – Limit value
5. " * ": Fundamental frequency.
6. " # ": The radiated frequency is out of the restricted band.

CHANNEL	TX Channel 151	DETECTOR FUNCTION	Peak (PK)
FREQUENCY RANGE	1GHz ~ 40GHz		Average (AV)

ANTENNA POLARITY & TEST DISTANCE: HORIZONTAL AT 3 M

NO.	FREQ. (MHz)	EMISSION LEVEL (dBuV/m)	LIMIT (dBuV/m)	MARGIN (dB)	ANTENNA HEIGHT (m)	TABLE ANGLE (Degree)	RAW VALUE (dBuV)	CORRECTION FACTOR (dB/m)
1	#5564.59	63.8 PK	68.2	-4.4	2.41 H	131	60.1	3.7
2	*5755.00	110.6 PK			2.41 H	131	106.6	4.0
3	*5755.00	100.7 AV			2.41 H	131	96.7	4.0
4	#5933.30	62.9 PK	68.2	-5.3	2.41 H	131	58.4	4.5
5	11510.00	57.7 PK	74.0	-16.3	1.79 H	308	45.0	12.7
6	11510.00	45.8 AV	54.0	-8.2	1.79 H	308	33.1	12.7
7	#17265.00	53.2 PK	74.0	-20.8	1.60 H	334	35.6	17.6
8	#17265.00	38.9 AV	54.0	-15.1	1.60 H	334	21.3	17.6

ANTENNA POLARITY & TEST DISTANCE: VERTICAL AT 3 M

NO.	FREQ. (MHz)	EMISSION LEVEL (dBuV/m)	LIMIT (dBuV/m)	MARGIN (dB)	ANTENNA HEIGHT (m)	TABLE ANGLE (Degree)	RAW VALUE (dBuV)	CORRECTION FACTOR (dB/m)
1	#5641.86	67.5 PK	68.2	-0.7	1.52 V	157	63.6	3.9
2	*5755.00	121.6 PK			1.52 V	157	117.6	4.0
3	*5755.00	112.2 AV			1.52 V	157	108.2	4.0
4	#5976.67	64.5 PK	68.2	-3.7	1.52 V	157	59.5	5.0
5	11510.00	56.7 PK	74.0	-17.3	1.60 V	350	44.0	12.7
6	11510.00	45.0 AV	54.0	-9.0	1.60 V	350	32.3	12.7
7	#17265.00	52.4 PK	74.0	-21.6	1.45 V	218	34.8	17.6
8	#17265.00	38.6 AV	54.0	-15.4	1.45 V	218	21.0	17.6

REMARKS:

1. Emission Level(dBuV/m) = Raw Value(dBuV) + Correction Factor(dB/m)
2. Correction Factor(dB/m) = Antenna Factor(dB/m) + Cable Factor(dB) – Pre-Amplifier Factor(dB)
3. The other emission levels were very low against the limit.
4. Margin value = Emission Level – Limit value
5. " * ": Fundamental frequency.
6. " # ": The radiated frequency is out of the restricted band.

CHANNEL	TX Channel 159	DETECTOR FUNCTION	Peak (PK)
FREQUENCY RANGE	1GHz ~ 40GHz		Average (AV)

ANTENNA POLARITY & TEST DISTANCE: HORIZONTAL AT 3 M

NO.	FREQ. (MHz)	EMISSION LEVEL (dBuV/m)	LIMIT (dBuV/m)	MARGIN (dB)	ANTENNA HEIGHT (m)	TABLE ANGLE (Degree)	RAW VALUE (dBuV)	CORRECTION FACTOR (dB/m)
1	#5647.74	63.1 PK	68.2	-5.1	2.42 H	133	59.2	3.9
2	*5795.00	110.9 PK			2.42 H	133	106.9	4.0
3	*5795.00	100.9 AV			2.42 H	133	96.9	4.0
4	#5981.18	62.5 PK	68.2	-5.7	2.42 H	133	57.4	5.1
5	11590.00	58.0 PK	74.0	-16.0	1.74 H	295	45.4	12.6
6	11590.00	46.1 AV	54.0	-7.9	1.74 H	295	33.5	12.6
7	#17385.00	52.5 PK	74.0	-21.5	1.61 H	327	34.1	18.4
8	#17385.00	38.5 AV	54.0	-15.5	1.61 H	327	20.1	18.4

ANTENNA POLARITY & TEST DISTANCE: VERTICAL AT 3 M

NO.	FREQ. (MHz)	EMISSION LEVEL (dBuV/m)	LIMIT (dBuV/m)	MARGIN (dB)	ANTENNA HEIGHT (m)	TABLE ANGLE (Degree)	RAW VALUE (dBuV)	CORRECTION FACTOR (dB/m)
1	#5633.21	66.6 PK	68.2	-1.6	1.48 V	157	62.8	3.8
2	*5795.00	121.5 PK			1.48 V	157	117.5	4.0
3	*5795.00	112.0 AV			1.48 V	157	108.0	4.0
4	#5941.99	65.4 PK	68.2	-2.8	1.48 V	157	60.8	4.6
5	11590.00	56.7 PK	74.0	-17.3	1.54 V	310	44.1	12.6
6	11590.00	45.2 AV	54.0	-8.8	1.54 V	310	32.6	12.6
7	#17385.00	52.7 PK	74.0	-21.3	1.36 V	198	34.3	18.4
8	#17385.00	38.5 AV	54.0	-15.5	1.36 V	198	20.1	18.4

REMARKS:

1. Emission Level(dBuV/m) = Raw Value(dBuV) + Correction Factor(dB/m)
2. Correction Factor(dB/m) = Antenna Factor(dB/m) + Cable Factor(dB) – Pre-Amplifier Factor(dB)
3. The other emission levels were very low against the limit.
4. Margin value = Emission Level – Limit value
5. " * ": Fundamental frequency.
6. " # ": The radiated frequency is out of the restricted band.

802.11ac (VHT80)

CHANNEL	TX Channel 42	DETECTOR FUNCTION	Peak (PK)
FREQUENCY RANGE	1GHz ~ 40GHz		Average (AV)

ANTENNA POLARITY & TEST DISTANCE: HORIZONTAL AT 3 M

NO.	FREQ. (MHz)	EMISSION LEVEL (dBuV/m)	LIMIT (dBuV/m)	MARGIN (dB)	ANTENNA HEIGHT (m)	TABLE ANGLE (Degree)	RAW VALUE (dBuV)	CORRECTION FACTOR (dB/m)
1	5150.00	57.8 PK	74.0	-16.2	1.17 H	281	54.9	2.9
2	5150.00	44.3 AV	54.0	-9.7	1.17 H	281	41.4	2.9
3	*5210.00	100.5 PK			1.17 H	281	97.5	3.0
4	*5210.00	91.2 AV			1.17 H	281	88.2	3.0
5	5350.00	52.1 PK	74.0	-21.9	1.17 H	281	48.7	3.4
6	5350.00	36.9 AV	54.0	-17.1	1.17 H	281	33.5	3.4
7	#10420.00	57.4 PK	74.0	-16.6	1.71 H	291	45.5	11.9
8	#10420.00	44.0 AV	54.0	-10.0	1.71 H	291	32.1	11.9
9	15630.00	54.5 PK	74.0	-19.5	1.61 H	327	42.0	12.5
10	15630.00	41.2 AV	54.0	-12.8	1.61 H	327	28.7	12.5

ANTENNA POLARITY & TEST DISTANCE: VERTICAL AT 3 M

NO.	FREQ. (MHz)	EMISSION LEVEL (dBuV/m)	LIMIT (dBuV/m)	MARGIN (dB)	ANTENNA HEIGHT (m)	TABLE ANGLE (Degree)	RAW VALUE (dBuV)	CORRECTION FACTOR (dB/m)
1	5150.00	67.2 PK	74.0	-6.8	1.32 V	216	64.3	2.9
2	5150.00	53.5 AV	54.0	-0.5	1.32 V	216	50.6	2.9
3	*5210.00	110.6 PK			1.32 V	216	107.6	3.0
4	*5210.00	101.3 AV			1.32 V	216	98.3	3.0
5	5350.00	58.1 PK	74.0	-15.9	1.32 V	216	54.7	3.4
6	5350.00	45.8 AV	54.0	-8.2	1.32 V	216	42.4	3.4
7	#10420.00	57.0 PK	74.0	-17.0	1.20 V	62	45.1	11.9
8	#10420.00	43.8 AV	54.0	-10.2	1.20 V	62	31.9	11.9
9	15630.00	54.2 PK	74.0	-19.8	1.67 V	137	41.7	12.5
10	15630.00	41.1 AV	54.0	-12.9	1.67 V	137	28.6	12.5

REMARKS:

- Emission Level(dBuV/m) = Raw Value(dBuV) + Correction Factor(dB/m)
- Correction Factor(dB/m) = Antenna Factor(dB/m) + Cable Factor(dB) – Pre-Amplifier Factor(dB)
- The other emission levels were very low against the limit.
- Margin value = Emission Level – Limit value
- " * ": Fundamental frequency.
- " # ": The radiated frequency is out of the restricted band.

CHANNEL	TX Channel 155	DETECTOR FUNCTION	Peak (PK)
FREQUENCY RANGE	1GHz ~ 40GHz		Average (AV)

ANTENNA POLARITY & TEST DISTANCE: HORIZONTAL AT 3 M

NO.	FREQ. (MHz)	EMISSION LEVEL (dBuV/m)	LIMIT (dBuV/m)	MARGIN (dB)	ANTENNA HEIGHT (m)	TABLE ANGLE (Degree)	RAW VALUE (dBuV)	CORRECTION FACTOR (dB/m)
1	#5633.94	59.2 PK	68.2	-9.0	2.33 H	133	55.4	3.8
2	*5775.00	104.1 PK			2.33 H	133	100.1	4.0
3	*5775.00	94.2 AV			2.33 H	133	90.2	4.0
4	#5980.78	55.9 PK	68.2	-12.3	2.33 H	133	50.8	5.1
5	11550.00	57.5 PK	74.0	-16.5	1.76 H	280	44.9	12.6
6	11550.00	44.1 AV	54.0	-9.9	1.76 H	280	31.5	12.6
7	#17325.00	52.6 PK	74.0	-21.4	1.63 H	318	34.8	17.8
8	#17325.00	38.5 AV	54.0	-15.5	1.63 H	318	20.7	17.8

ANTENNA POLARITY & TEST DISTANCE: VERTICAL AT 3 M

NO.	FREQ. (MHz)	EMISSION LEVEL (dBuV/m)	LIMIT (dBuV/m)	MARGIN (dB)	ANTENNA HEIGHT (m)	TABLE ANGLE (Degree)	RAW VALUE (dBuV)	CORRECTION FACTOR (dB/m)
1	#5648.85	68.0 PK	68.2	-0.2	1.44 V	214	64.1	3.9
2	*5775.00	112.2 PK			1.14 V	214	108.2	4.0
3	*5775.00	102.3 AV			1.14 V	214	98.3	4.0
4	#5930.55	64.5 PK	68.2	-3.7	1.44 V	214	60.0	4.5
5	11550.00	56.8 PK	74.0	-17.2	1.25 V	72	44.2	12.6
6	11550.00	43.5 AV	54.0	-10.5	1.25 V	72	30.9	12.6
7	#17325.00	52.9 PK	74.0	-21.1	1.36 V	213	35.1	17.8
8	#17325.00	38.7 AV	54.0	-15.3	1.36 V	213	20.9	17.8

REMARKS:

1. Emission Level(dBuV/m) = Raw Value(dBuV) + Correction Factor(dB/m)
2. Correction Factor(dB/m) = Antenna Factor(dB/m) + Cable Factor(dB) – Pre-Amplifier Factor(dB)
3. The other emission levels were very low against the limit.
4. Margin value = Emission Level – Limit value
5. " * ": Fundamental frequency.
6. " # ": The radiated frequency is out of the restricted band.

802.11ac (VHT80+80)

CHANNEL	TX Channel 42+155	DETECTOR FUNCTION	Peak (PK)
FREQUENCY RANGE	1GHz ~ 40GHz		Average (AV)

ANTENNA POLARITY & TEST DISTANCE: HORIZONTAL AT 3 M

NO.	FREQ. (MHz)	EMISSION LEVEL (dBuV/m)	LIMIT (dBuV/m)	MARGIN (dB)	ANTENNA HEIGHT (m)	TABLE ANGLE (Degree)	RAW VALUE (dBuV)	CORRECTION FACTOR (dB/m)
1	5150.00	57.5 PK	74.0	-16.5	2.38 H	138	54.6	2.9
2	5150.00	43.9 AV	54.0	-10.1	2.38 H	138	41.0	2.9
3	*5210.00	92.5 PK			2.38 H	138	89.5	3.0
4	*5210.00	82.6 AV			2.38 H	138	79.6	3.0
5	5350.00	52.3 PK	74.0	-21.7	2.38 H	138	48.9	3.4
6	5350.00	37.0 AV	54.0	-17.0	2.38 H	138	33.6	3.4
7	#5622.66	55.9 PK	68.2	-12.3	2.12 H	130	52.1	3.8
8	*5775.00	93.6 PK			2.12 H	130	89.6	4.0
9	*5775.00	83.5 AV			2.12 H	130	79.5	4.0
10	#5958.93	54.7 PK	68.2	-13.5	2.12 H	130	49.9	4.8
11	#10420.00	57.0 PK	74.0	-17.0	1.67 H	285	45.1	11.9
12	#10420.00	43.8 AV	54.0	-10.2	1.67 H	285	31.9	11.9
13	11550.00	57.8 PK	74.0	-16.2	1.73 H	268	45.2	12.6
14	11550.00	44.3 AV	54.0	-9.7	1.73 H	268	31.7	12.6
15	15630.00	54.4 PK	74.0	-19.6	1.58 H	332	41.9	12.5
16	15630.00	40.9 AV	54.0	-13.1	1.58 H	332	28.4	12.5
17	#17325.00	52.6 PK	74.0	-21.4	1.63 H	304	34.8	17.8
18	#17325.00	38.7 AV	54.0	-15.3	1.63 H	304	20.9	17.8

ANTENNA POLARITY & TEST DISTANCE: VERTICAL AT 3 M

NO.	FREQ. (MHz)	EMISSION LEVEL (dBuV/m)	LIMIT (dBuV/m)	MARGIN (dB)	ANTENNA HEIGHT (m)	TABLE ANGLE (Degree)	RAW VALUE (dBuV)	CORRECTION FACTOR (dB/m)
1	5150.00	64.5 PK	74.0	-9.5	1.50 V	279	61.6	2.9
2	5150.00	53.8 AV	54.0	-0.2	1.50 V	279	50.9	2.9
3	*5210.00	106.4 PK			1.50 V	279	103.4	3.0
4	*5210.00	97.1 AV			1.50 V	279	94.1	3.0
5	5350.00	56.2 PK	74.0	-17.8	1.50 V	279	52.8	3.4
6	5350.00	44.7 AV	54.0	-9.3	1.50 V	279	41.3	3.4
7	#5650.40	68.1 PK	68.5	-0.4	1.50 V	320	64.2	3.9
8	*5775.00	107.8 PK			1.50 V	320	103.8	4.0
9	*5775.00	97.9 AV			1.50 V	320	93.9	4.0
10	#5936.28	60.0 PK	68.2	-8.2	1.50 V	320	55.5	4.5
11	#10420.00	57.1 PK	74.0	-16.9	1.20 V	58	45.2	11.9
12	#10420.00	44.0 AV	54.0	-10.0	1.20 V	58	32.1	11.9
13	11550.00	57.1 PK	74.0	-16.9	1.30 V	76	44.5	12.6
14	11550.00	43.5 AV	54.0	-10.5	1.30 V	76	30.9	12.6
15	15630.00	54.3 PK	74.0	-19.7	1.69 V	126	41.8	12.5
16	15630.00	41.1 AV	54.0	-12.9	1.69 V	126	28.6	12.5
17	#17325.00	53.4 PK	74.0	-20.6	1.37 V	213	35.6	17.8
18	#17325.00	40.1 AV	54.0	-13.9	1.37 V	213	22.3	17.8

REMARKS:

1. Emission Level(dBuV/m) = Raw Value(dBuV) + Correction Factor(dB/m)
2. Correction Factor(dB/m) = Antenna Factor(dB/m) + Cable Factor(dB) – Pre-Amplifier Factor(dB)
3. The other emission levels were very low against the limit.
4. Margin value = Emission Level – Limit value
5. " * ": Fundamental frequency.
6. " # ": The radiated frequency is out of the restricted band.

4.1.8 Test Results (Mode 2)

Above 1GHz Data:

802.11a

CHANNEL	TX Channel 36	DETECTOR FUNCTION	Peak (PK)
FREQUENCY RANGE	1GHz ~ 40GHz		Average (AV)

ANTENNA POLARITY & TEST DISTANCE: HORIZONTAL AT 3 M								
NO.	FREQ. (MHz)	EMISSION LEVEL (dBuV/m)	LIMIT (dBuV/m)	MARGIN (dB)	ANTENNA HEIGHT (m)	TABLE ANGLE (Degree)	RAW VALUE (dBuV)	CORRECTION FACTOR (dB/m)
1	5150.00	52.9 PK	74.0	-21.1	1.21 H	27	50.0	2.9
2	5150.00	42.2 AV	54.0	-11.8	1.21 H	27	39.3	2.9
3	*5180.00	100.7 PK			1.21 H	27	97.7	3.0
4	*5180.00	91.4 AV			1.21 H	27	88.4	3.0
5	#10360.00	56.0 PK	74.0	-18.0	1.00 H	182	44.1	11.9
6	#10360.00	43.5 AV	54.0	-10.5	1.00 H	182	31.6	11.9
7	15540.00	53.9 PK	74.0	-20.1	1.95 H	209	41.7	12.2
8	15540.00	41.6 AV	54.0	-12.4	1.95 H	209	29.4	12.2

ANTENNA POLARITY & TEST DISTANCE: VERTICAL AT 3 M								
NO.	FREQ. (MHz)	EMISSION LEVEL (dBuV/m)	LIMIT (dBuV/m)	MARGIN (dB)	ANTENNA HEIGHT (m)	TABLE ANGLE (Degree)	RAW VALUE (dBuV)	CORRECTION FACTOR (dB/m)
1	5150.00	64.2 PK	74.0	-9.8	1.58 V	145	61.3	2.9
2	5150.00	53.7 AV	54.0	-0.3	1.58 V	145	50.8	2.9
3	*5180.00	123.8 PK			1.58 V	145	120.8	3.0
4	*5180.00	114.7 AV			1.58 V	145	111.7	3.0
5	#10360.00	56.0 PK	74.0	-18.0	1.49 V	173	44.1	11.9
6	#10360.00	43.5 AV	54.0	-10.5	1.49 V	173	31.6	11.9
7	15540.00	54.2 PK	74.0	-19.8	1.23 V	354	42.0	12.2
8	15540.00	41.7 AV	54.0	-12.3	1.23 V	354	29.5	12.2

REMARKS:

1. Emission Level(dBuV/m) = Raw Value(dBuV) + Correction Factor(dB/m)
2. Correction Factor(dB/m) = Antenna Factor(dB/m) + Cable Factor(dB) – Pre-Amplifier Factor(dB)
3. The other emission levels were very low against the limit.
4. Margin value = Emission Level – Limit value
5. " * ": Fundamental frequency.
6. " # ": The radiated frequency is out of the restricted band.

CHANNEL	TX Channel 40	DETECTOR FUNCTION	Peak (PK)
FREQUENCY RANGE	1GHz ~ 40GHz		Average (AV)

ANTENNA POLARITY & TEST DISTANCE: HORIZONTAL AT 3 M

NO.	FREQ. (MHz)	EMISSION LEVEL (dBuV/m)	LIMIT (dBuV/m)	MARGIN (dB)	ANTENNA HEIGHT (m)	TABLE ANGLE (Degree)	RAW VALUE (dBuV)	CORRECTION FACTOR (dB/m)
1	5150.00	50.2 PK	74.0	-23.8	1.16 H	38	47.3	2.9
2	5150.00	39.4 AV	54.0	-14.6	1.16 H	38	36.5	2.9
3	*5200.00	100.4 PK			1.16 H	38	97.4	3.0
4	*5200.00	90.9 AV			1.16 H	38	87.9	3.0
5	#10400.00	55.3 PK	74.0	-18.7	1.01 H	185	43.4	11.9
6	#10400.00	42.9 AV	54.0	-11.1	1.01 H	185	31.0	11.9
7	15600.00	53.9 PK	74.0	-20.1	1.97 H	219	41.6	12.3
8	15600.00	41.8 AV	54.0	-12.2	1.97 H	219	29.5	12.3

ANTENNA POLARITY & TEST DISTANCE: VERTICAL AT 3 M

NO.	FREQ. (MHz)	EMISSION LEVEL (dBuV/m)	LIMIT (dBuV/m)	MARGIN (dB)	ANTENNA HEIGHT (m)	TABLE ANGLE (Degree)	RAW VALUE (dBuV)	CORRECTION FACTOR (dB/m)
1	5150.00	57.1 PK	74.0	-16.9	1.53 V	146	54.2	2.9
2	5150.00	47.6 AV	54.0	-6.4	1.53 V	146	44.7	2.9
3	*5200.00	123.9 PK			1.53 V	146	120.9	3.0
4	*5200.00	114.3 AV			1.53 V	146	111.3	3.0
5	#10400.00	55.5 PK	74.0	-18.5	1.50 V	170	43.6	11.9
6	#10400.00	43.4 AV	54.0	-10.6	1.50 V	170	31.5	11.9
7	15600.00	54.2 PK	74.0	-19.8	1.29 V	360	41.9	12.3
8	15600.00	41.7 AV	54.0	-12.3	1.29 V	360	29.4	12.3

REMARKS:

1. Emission Level(dBuV/m) = Raw Value(dBuV) + Correction Factor(dB/m)
2. Correction Factor(dB/m) = Antenna Factor(dB/m) + Cable Factor(dB) – Pre-Amplifier Factor(dB)
3. The other emission levels were very low against the limit.
4. Margin value = Emission Level – Limit value
5. " * ": Fundamental frequency.
6. " # ": The radiated frequency is out of the restricted band.

CHANNEL	TX Channel 48	DETECTOR FUNCTION	Peak (PK)
FREQUENCY RANGE	1GHz ~ 40GHz		Average (AV)

ANTENNA POLARITY & TEST DISTANCE: HORIZONTAL AT 3 M

NO.	FREQ. (MHz)	EMISSION LEVEL (dBuV/m)	LIMIT (dBuV/m)	MARGIN (dB)	ANTENNA HEIGHT (m)	TABLE ANGLE (Degree)	RAW VALUE (dBuV)	CORRECTION FACTOR (dB/m)
1	5150.00	48.6 PK	74.0	-25.4	1.24 H	23	45.7	2.9
2	5150.00	36.6 AV	54.0	-17.4	1.24 H	23	33.7	2.9
3	*5240.00	100.0 PK			1.24 H	23	96.9	3.1
4	*5240.00	90.8 AV			1.24 H	23	87.7	3.1
5	5350.00	48.1 PK	74.0	-25.9	1.24 H	23	44.7	3.4
6	5350.00	36.2 AV	54.0	-17.8	1.24 H	23	32.8	3.4
7	#10480.00	55.5 PK	74.0	-18.5	1.00 H	183	43.6	11.9
8	#10480.00	43.3 AV	54.0	-10.7	1.00 H	183	31.4	11.9
9	15720.00	54.5 PK	74.0	-19.5	1.92 H	225	41.5	13.0
10	15720.00	42.3 AV	54.0	-11.7	1.92 H	225	29.3	13.0

ANTENNA POLARITY & TEST DISTANCE: VERTICAL AT 3 M

NO.	FREQ. (MHz)	EMISSION LEVEL (dBuV/m)	LIMIT (dBuV/m)	MARGIN (dB)	ANTENNA HEIGHT (m)	TABLE ANGLE (Degree)	RAW VALUE (dBuV)	CORRECTION FACTOR (dB/m)
1	5150.00	53.3 PK	74.0	-20.7	1.55 V	146	50.4	2.9
2	5150.00	43.3 AV	54.0	-10.7	1.55 V	146	40.4	2.9
3	*5240.00	124.1 PK			1.55 V	146	121.0	3.1
4	*5240.00	114.5 AV			1.55 V	146	111.4	3.1
5	5350.00	52.9 PK	74.0	-21.1	1.55 V	146	49.5	3.4
6	5350.00	42.8 AV	54.0	-11.2	1.55 V	146	39.4	3.4
7	#10480.00	55.7 PK	74.0	-18.3	1.50 V	186	43.8	11.9
8	#10480.00	43.8 AV	54.0	-10.2	1.50 V	186	31.9	11.9
9	15720.00	53.9 PK	74.0	-20.1	1.28 V	360	40.9	13.0
10	15720.00	41.4 AV	54.0	-12.6	1.28 V	360	28.4	13.0

REMARKS:

1. Emission Level(dBuV/m) = Raw Value(dBuV) + Correction Factor(dB/m)
2. Correction Factor(dB/m) = Antenna Factor(dB/m) + Cable Factor(dB) – Pre-Amplifier Factor(dB)
3. The other emission levels were very low against the limit.
4. Margin value = Emission Level – Limit value
5. " * ": Fundamental frequency.
6. " # ": The radiated frequency is out of the restricted band.

CHANNEL	TX Channel 149	DETECTOR FUNCTION	Peak (PK)
FREQUENCY RANGE	1GHz ~ 40GHz		Average (AV)

ANTENNA POLARITY & TEST DISTANCE: HORIZONTAL AT 3 M

NO.	FREQ. (MHz)	EMISSION LEVEL (dBuV/m)	LIMIT (dBuV/m)	MARGIN (dB)	ANTENNA HEIGHT (m)	TABLE ANGLE (Degree)	RAW VALUE (dBuV)	CORRECTION FACTOR (dB/m)
1	#5632.33	61.3 PK	68.2	-6.9	1.50 H	343	57.5	3.8
2	*5745.00	108.2 PK			1.50 H	343	104.2	4.0
3	*5745.00	100.3 AV			1.50 H	343	96.3	4.0
4	#5965.36	60.7 PK	68.2	-7.5	1.50 H	343	55.9	4.8
5	11490.00	57.4 PK	74.0	-16.6	1.64 H	174	44.6	12.8
6	11490.00	45.2 AV	54.0	-8.8	1.64 H	174	32.4	12.8
7	#17235.00	57.3 PK	74.0	-16.7	3.06 H	54	39.9	17.4
8	#17235.00	46.8 AV	54.0	-7.2	3.06 H	54	29.4	17.4

ANTENNA POLARITY & TEST DISTANCE: VERTICAL AT 3 M

NO.	FREQ. (MHz)	EMISSION LEVEL (dBuV/m)	LIMIT (dBuV/m)	MARGIN (dB)	ANTENNA HEIGHT (m)	TABLE ANGLE (Degree)	RAW VALUE (dBuV)	CORRECTION FACTOR (dB/m)
1	#5642.15	67.5 PK	68.2	-0.7	1.86 V	6	63.6	3.9
2	*5745.00	125.9 PK			1.86 V	6	121.9	4.0
3	*5745.00	116.9 AV			1.86 V	6	112.9	4.0
4	#5949.95	62.6 PK	68.2	-5.6	1.86 V	6	58.0	4.6
5	11490.00	57.7 PK	74.0	-16.3	2.75 V	166	44.9	12.8
6	11490.00	45.6 AV	54.0	-8.4	2.75 V	166	32.8	12.8
7	#17235.00	57.3 PK	74.0	-16.7	2.11 V	310	39.9	17.4
8	#17235.00	48.6 AV	54.0	-5.4	2.11 V	310	31.2	17.4

REMARKS:

1. Emission Level(dBuV/m) = Raw Value(dBuV) + Correction Factor(dB/m)
2. Correction Factor(dB/m) = Antenna Factor(dB/m) + Cable Factor(dB) – Pre-Amplifier Factor(dB)
3. The other emission levels were very low against the limit.
4. Margin value = Emission Level – Limit value
5. " * ": Fundamental frequency.
6. " # ": The radiated frequency is out of the restricted band.

CHANNEL	TX Channel 157	DETECTOR FUNCTION	Peak (PK)
FREQUENCY RANGE	1GHz ~ 40GHz		Average (AV)

ANTENNA POLARITY & TEST DISTANCE: HORIZONTAL AT 3 M

NO.	FREQ. (MHz)	EMISSION LEVEL (dBuV/m)	LIMIT (dBuV/m)	MARGIN (dB)	ANTENNA HEIGHT (m)	TABLE ANGLE (Degree)	RAW VALUE (dBuV)	CORRECTION FACTOR (dB/m)
1	#5616.02	60.0 PK	68.2	-8.2	1.51 H	358	56.2	3.8
2	*5785.00	108.1 PK			1.51 H	358	104.1	4.0
3	*5785.00	100.1 AV			1.51 H	358	96.1	4.0
4	#5926.00	61.0 PK	68.2	-7.2	1.51 H	358	56.6	4.4
5	11570.00	57.3 PK	74.0	-16.7	1.62 H	167	44.7	12.6
6	11570.00	45.1 AV	54.0	-8.9	1.62 H	167	32.5	12.6
7	#17355.00	57.4 PK	74.0	-16.6	3.13 H	49	39.3	18.1
8	#17355.00	46.6 AV	54.0	-7.4	3.13 H	49	28.5	18.1

ANTENNA POLARITY & TEST DISTANCE: VERTICAL AT 3 M

NO.	FREQ. (MHz)	EMISSION LEVEL (dBuV/m)	LIMIT (dBuV/m)	MARGIN (dB)	ANTENNA HEIGHT (m)	TABLE ANGLE (Degree)	RAW VALUE (dBuV)	CORRECTION FACTOR (dB/m)
1	#5643.10	65.8 PK	68.2	-2.4	1.81 V	7	61.9	3.9
2	*5785.00	125.4 PK			1.81 V	7	121.4	4.0
3	*5785.00	116.5 AV			1.81 V	7	112.5	4.0
4	#5927.15	63.4 PK	68.2	-4.8	1.81 V	7	59.0	4.4
5	11570.00	57.9 PK	74.0	-16.1	2.78 V	167	45.3	12.6
6	11570.00	46.1 AV	54.0	-7.9	2.78 V	167	33.5	12.6
7	#17355.00	56.9 PK	74.0	-17.1	2.09 V	296	38.8	18.1
8	#17355.00	48.5 AV	54.0	-5.5	2.09 V	296	30.4	18.1

REMARKS:

1. Emission Level(dBuV/m) = Raw Value(dBuV) + Correction Factor(dB/m)
2. Correction Factor(dB/m) = Antenna Factor(dB/m) + Cable Factor(dB) – Pre-Amplifier Factor(dB)
3. The other emission levels were very low against the limit.
4. Margin value = Emission Level – Limit value
5. " * ": Fundamental frequency.
6. " # ": The radiated frequency is out of the restricted band.

CHANNEL	TX Channel 165	DETECTOR FUNCTION	Peak (PK)
FREQUENCY RANGE	1GHz ~ 40GHz		Average (AV)

ANTENNA POLARITY & TEST DISTANCE: HORIZONTAL AT 3 M

NO.	FREQ. (MHz)	EMISSION LEVEL (dBuV/m)	LIMIT (dBuV/m)	MARGIN (dB)	ANTENNA HEIGHT (m)	TABLE ANGLE (Degree)	RAW VALUE (dBuV)	CORRECTION FACTOR (dB/m)
1	#5625.90	61.4 PK	68.2	-6.8	1.56 H	360	57.6	3.8
2	*5825.00	108.7 PK			1.56 H	360	104.6	4.1
3	*5825.00	100.5 AV			1.56 H	360	96.4	4.1
4	#5923.66	61.8 PK	69.2	-7.4	1.56 H	360	57.4	4.4
5	11650.00	57.4 PK	74.0	-16.6	1.61 H	164	44.7	12.7
6	11650.00	45.2 AV	54.0	-8.8	1.61 H	164	32.5	12.7
7	#17475.00	57.5 PK	74.0	-16.5	3.11 H	64	38.6	18.9
8	#17475.00	46.8 AV	54.0	-7.2	3.11 H	64	27.9	18.9

ANTENNA POLARITY & TEST DISTANCE: VERTICAL AT 3 M

NO.	FREQ. (MHz)	EMISSION LEVEL (dBuV/m)	LIMIT (dBuV/m)	MARGIN (dB)	ANTENNA HEIGHT (m)	TABLE ANGLE (Degree)	RAW VALUE (dBuV)	CORRECTION FACTOR (dB/m)
1	#5602.25	63.6 PK	68.2	-4.6	1.84 V	8	59.9	3.7
2	*5825.00	126.1 PK			1.84 V	8	122.0	4.1
3	*5825.00	116.9 AV			1.84 V	8	112.8	4.1
4	#5935.70	67.3 PK	68.2	-0.9	1.84 V	8	62.8	4.5
5	11650.00	57.6 PK	74.0	-16.4	2.77 V	180	44.9	12.7
6	11650.00	45.7 AV	54.0	-8.3	2.77 V	180	33.0	12.7
7	#17475.00	57.3 PK	74.0	-16.7	2.08 V	304	38.4	18.9
8	#17475.00	48.8 AV	54.0	-5.2	2.08 V	304	29.9	18.9

REMARKS:

1. Emission Level(dBuV/m) = Raw Value(dBuV) + Correction Factor(dB/m)
2. Correction Factor(dB/m) = Antenna Factor(dB/m) + Cable Factor(dB) – Pre-Amplifier Factor(dB)
3. The other emission levels were very low against the limit.
4. Margin value = Emission Level – Limit value
5. " * ": Fundamental frequency.
6. " # ": The radiated frequency is out of the restricted band.

802.11ac (VHT20)

CHANNEL	TX Channel 36	DETECTOR FUNCTION	Peak (PK)
FREQUENCY RANGE	1GHz ~ 40GHz		Average (AV)

ANTENNA POLARITY & TEST DISTANCE: HORIZONTAL AT 3 M

NO.	FREQ. (MHz)	EMISSION LEVEL (dBuV/m)	LIMIT (dBuV/m)	MARGIN (dB)	ANTENNA HEIGHT (m)	TABLE ANGLE (Degree)	RAW VALUE (dBuV)	CORRECTION FACTOR (dB/m)
1	5150.00	51.4 PK	74.0	-22.6	1.19 H	34	48.5	2.9
2	5150.00	42.4 AV	54.0	-11.6	1.19 H	34	39.5	2.9
3	*5180.00	97.5 PK			1.19 H	34	94.5	3.0
4	*5180.00	87.1 AV			1.19 H	34	84.1	3.0
5	#10360.00	56.5 PK	74.0	-17.5	1.00 H	185	44.6	11.9
6	#10360.00	43.7 AV	54.0	-10.3	1.00 H	185	31.8	11.9
7	15540.00	54.1 PK	74.0	-19.9	1.90 H	231	41.9	12.2
8	15540.00	41.9 AV	54.0	-12.1	1.90 H	231	29.7	12.2

ANTENNA POLARITY & TEST DISTANCE: VERTICAL AT 3 M

NO.	FREQ. (MHz)	EMISSION LEVEL (dBuV/m)	LIMIT (dBuV/m)	MARGIN (dB)	ANTENNA HEIGHT (m)	TABLE ANGLE (Degree)	RAW VALUE (dBuV)	CORRECTION FACTOR (dB/m)
1	5150.00	62.6 PK	74.0	-11.4	1.44 V	358	59.7	2.9
2	5150.00	53.9 AV	54.0	-0.1	1.44 V	358	51.0	2.9
3	*5180.00	121.2 PK			1.44 V	358	118.2	3.0
4	*5180.00	110.9 AV			1.44 V	358	107.9	3.0
5	#10360.00	56.1 PK	74.0	-17.9	1.46 V	171	44.2	11.9
6	#10360.00	43.9 AV	54.0	-10.1	1.46 V	171	32.0	11.9
7	15540.00	53.3 PK	74.0	-20.7	1.33 V	351	41.1	12.2
8	15540.00	41.0 AV	54.0	-13.0	1.33 V	351	28.8	12.2

REMARKS:

- Emission Level(dBuV/m) = Raw Value(dBuV) + Correction Factor(dB/m)
- Correction Factor(dB/m) = Antenna Factor(dB/m) + Cable Factor(dB) – Pre-Amplifier Factor(dB)
- The other emission levels were very low against the limit.
- Margin value = Emission Level – Limit value
- " * ": Fundamental frequency.
- " # ": The radiated frequency is out of the restricted band.

CHANNEL	TX Channel 40	DETECTOR FUNCTION	Peak (PK)
FREQUENCY RANGE	1GHz ~ 40GHz		Average (AV)

ANTENNA POLARITY & TEST DISTANCE: HORIZONTAL AT 3 M

NO.	FREQ. (MHz)	EMISSION LEVEL (dBuV/m)	LIMIT (dBuV/m)	MARGIN (dB)	ANTENNA HEIGHT (m)	TABLE ANGLE (Degree)	RAW VALUE (dBuV)	CORRECTION FACTOR (dB/m)
1	5150.00	50.6 PK	74.0	-23.4	1.23 H	23	47.7	2.9
2	5150.00	39.8 AV	54.0	-14.2	1.23 H	23	36.9	2.9
3	*5200.00	99.0 PK			1.23 H	23	96.0	3.0
4	*5200.00	88.2 AV			1.23 H	23	85.2	3.0
5	#10400.00	55.7 PK	74.0	-18.3	1.08 H	171	43.8	11.9
6	#10400.00	43.0 AV	54.0	-11.0	1.08 H	171	31.1	11.9
7	15600.00	53.1 PK	74.0	-20.9	1.90 H	214	40.8	12.3
8	15600.00	41.0 AV	54.0	-13.0	1.90 H	214	28.7	12.3

ANTENNA POLARITY & TEST DISTANCE: VERTICAL AT 3 M

NO.	FREQ. (MHz)	EMISSION LEVEL (dBuV/m)	LIMIT (dBuV/m)	MARGIN (dB)	ANTENNA HEIGHT (m)	TABLE ANGLE (Degree)	RAW VALUE (dBuV)	CORRECTION FACTOR (dB/m)
1	5150.00	57.1 PK	74.0	-16.9	1.35 V	360	54.2	2.9
2	5150.00	47.5 AV	54.0	-6.5	1.35 V	360	44.6	2.9
3	*5200.00	122.1 PK			1.35 V	360	119.1	3.0
4	*5200.00	111.5 AV			1.35 V	360	108.5	3.0
5	#10400.00	55.5 PK	74.0	-18.5	1.49 V	177	43.6	11.9
6	#10400.00	43.2 AV	54.0	-10.8	1.49 V	177	31.3	11.9
7	15600.00	53.5 PK	74.0	-20.5	1.34 V	360	41.2	12.3
8	15600.00	41.0 AV	54.0	-13.0	1.34 V	360	28.7	12.3

REMARKS:

1. Emission Level(dBuV/m) = Raw Value(dBuV) + Correction Factor(dB/m)
2. Correction Factor(dB/m) = Antenna Factor(dB/m) + Cable Factor(dB) – Pre-Amplifier Factor(dB)
3. The other emission levels were very low against the limit.
4. Margin value = Emission Level – Limit value
5. " * ": Fundamental frequency.
6. " # ": The radiated frequency is out of the restricted band.

CHANNEL	TX Channel 48	DETECTOR FUNCTION	Peak (PK)
FREQUENCY RANGE	1GHz ~ 40GHz		Average (AV)

ANTENNA POLARITY & TEST DISTANCE: HORIZONTAL AT 3 M

NO.	FREQ. (MHz)	EMISSION LEVEL (dBuV/m)	LIMIT (dBuV/m)	MARGIN (dB)	ANTENNA HEIGHT (m)	TABLE ANGLE (Degree)	RAW VALUE (dBuV)	CORRECTION FACTOR (dB/m)
1	5150.00	48.5 PK	74.0	-25.5	1.24 H	30	45.6	2.9
2	5150.00	36.8 AV	54.0	-17.2	1.24 H	30	33.9	2.9
3	*5240.00	98.0 PK			1.24 H	30	94.9	3.1
4	*5240.00	88.0 AV			1.24 H	30	84.9	3.1
5	5350.00	48.3 PK	74.0	-25.7	1.24 H	30	44.9	3.4
6	5350.00	36.4 AV	54.0	-17.6	1.24 H	30	33.0	3.4
7	#10480.00	55.5 PK	74.0	-18.5	1.00 H	184	43.6	11.9
8	#10480.00	42.8 AV	54.0	-11.2	1.00 H	184	30.9	11.9
9	15720.00	53.2 PK	74.0	-20.8	1.87 H	226	40.2	13.0
10	15720.00	41.1 AV	54.0	-12.9	1.87 H	226	28.1	13.0

ANTENNA POLARITY & TEST DISTANCE: VERTICAL AT 3 M

NO.	FREQ. (MHz)	EMISSION LEVEL (dBuV/m)	LIMIT (dBuV/m)	MARGIN (dB)	ANTENNA HEIGHT (m)	TABLE ANGLE (Degree)	RAW VALUE (dBuV)	CORRECTION FACTOR (dB/m)
1	5150.00	53.6 PK	74.0	-20.4	1.33 V	360	50.7	2.9
2	5150.00	43.4 AV	54.0	-10.6	1.33 V	360	40.5	2.9
3	*5240.00	122.0 PK			1.33 V	360	118.9	3.1
4	*5240.00	111.2 AV			1.33 V	360	108.1	3.1
5	5350.00	53.1 PK	74.0	-20.9	1.33 V	360	49.7	3.4
6	5350.00	42.9 AV	54.0	-11.1	1.33 V	360	39.5	3.4
7	#10480.00	55.9 PK	74.0	-18.1	1.52 V	187	44.0	11.9
8	#10480.00	43.6 AV	54.0	-10.4	1.52 V	187	31.7	11.9
9	15720.00	53.3 PK	74.0	-20.7	1.29 V	360	40.3	13.0
10	15720.00	41.2 AV	54.0	-12.8	1.29 V	360	28.2	13.0

REMARKS:

1. Emission Level(dBuV/m) = Raw Value(dBuV) + Correction Factor(dB/m)
2. Correction Factor(dB/m) = Antenna Factor(dB/m) + Cable Factor(dB) – Pre-Amplifier Factor(dB)
3. The other emission levels were very low against the limit.
4. Margin value = Emission Level – Limit value
5. " * ": Fundamental frequency.
6. " # ": The radiated frequency is out of the restricted band.

CHANNEL	TX Channel 149	DETECTOR FUNCTION	Peak (PK)
FREQUENCY RANGE	1GHz ~ 40GHz		Average (AV)

ANTENNA POLARITY & TEST DISTANCE: HORIZONTAL AT 3 M

NO.	FREQ. (MHz)	EMISSION LEVEL (dBuV/m)	LIMIT (dBuV/m)	MARGIN (dB)	ANTENNA HEIGHT (m)	TABLE ANGLE (Degree)	RAW VALUE (dBuV)	CORRECTION FACTOR (dB/m)
1	#5613.18	61.4 PK	68.2	-6.8	1.50 H	330	57.6	3.8
2	*5745.00	110.0 PK			1.50 H	330	106.0	4.0
3	*5745.00	100.4 AV			1.50 H	330	96.4	4.0
4	#5949.07	60.4 PK	68.2	-7.8	1.50 H	330	55.8	4.6
5	11490.00	57.1 PK	74.0	-16.9	1.59 H	158	44.3	12.8
6	11490.00	45.0 AV	54.0	-9.0	1.59 H	158	32.2	12.8
7	#17235.00	57.0 PK	74.0	-17.0	3.13 H	52	39.6	17.4
8	#17235.00	46.4 AV	54.0	-7.6	3.13 H	52	29.0	17.4

ANTENNA POLARITY & TEST DISTANCE: VERTICAL AT 3 M

NO.	FREQ. (MHz)	EMISSION LEVEL (dBuV/m)	LIMIT (dBuV/m)	MARGIN (dB)	ANTENNA HEIGHT (m)	TABLE ANGLE (Degree)	RAW VALUE (dBuV)	CORRECTION FACTOR (dB/m)
1	#5612.81	67.9 PK	68.2	-0.3	2.08 V	217	64.1	3.8
2	*5745.00	125.5 PK			2.08 V	217	121.5	4.0
3	*5745.00	116.5 AV			2.08 V	217	112.5	4.0
4	#5932.32	63.9 PK	68.2	-4.3	2.08 V	217	59.4	4.5
5	11490.00	57.5 PK	74.0	-16.5	2.75 V	170	44.7	12.8
6	11490.00	45.3 AV	54.0	-8.7	2.75 V	170	32.5	12.8
7	#17235.00	57.1 PK	74.0	-16.9	2.16 V	313	39.7	17.4
8	#17235.00	48.3 AV	54.0	-5.7	2.16 V	313	30.9	17.4

REMARKS:

1. Emission Level(dBuV/m) = Raw Value(dBuV) + Correction Factor(dB/m)
2. Correction Factor(dB/m) = Antenna Factor(dB/m) + Cable Factor(dB) – Pre-Amplifier Factor(dB)
3. The other emission levels were very low against the limit.
4. Margin value = Emission Level – Limit value
5. " * ": Fundamental frequency.
6. " # ": The radiated frequency is out of the restricted band.

CHANNEL	TX Channel 157	DETECTOR FUNCTION	Peak (PK)
FREQUENCY RANGE	1GHz ~ 40GHz		Average (AV)

ANTENNA POLARITY & TEST DISTANCE: HORIZONTAL AT 3 M

NO.	FREQ. (MHz)	EMISSION LEVEL (dBuV/m)	LIMIT (dBuV/m)	MARGIN (dB)	ANTENNA HEIGHT (m)	TABLE ANGLE (Degree)	RAW VALUE (dBuV)	CORRECTION FACTOR (dB/m)
1	#5622.52	61.2 PK	68.2	-7.0	1.50 H	330	57.4	3.8
2	*5785.00	109.8 PK			1.50 H	330	105.8	4.0
3	*5785.00	100.5 AV			1.50 H	330	96.5	4.0
4	#5943.13	60.8 PK	68.2	-7.4	1.50 H	330	56.2	4.6
5	11570.00	57.2 PK	74.0	-16.8	1.61 H	152	44.6	12.6
6	11570.00	45.2 AV	54.0	-8.8	1.61 H	152	32.6	12.6
7	#17355.00	56.9 PK	74.0	-17.1	3.14 H	43	38.8	18.1
8	#17355.00	46.2 AV	54.0	-7.8	3.14 H	43	28.1	18.1

ANTENNA POLARITY & TEST DISTANCE: VERTICAL AT 3 M

NO.	FREQ. (MHz)	EMISSION LEVEL (dBuV/m)	LIMIT (dBuV/m)	MARGIN (dB)	ANTENNA HEIGHT (m)	TABLE ANGLE (Degree)	RAW VALUE (dBuV)	CORRECTION FACTOR (dB/m)
1	#5631.70	66.8 PK	68.2	-1.4	1.85 V	360	63.0	3.8
2	*5785.00	125.2 PK			1.85 V	360	121.2	4.0
3	*5785.00	115.8 AV			1.85 V	360	111.8	4.0
4	#5919.43	65.4 PK	72.3	-6.9	1.85 V	360	61.0	4.4
5	11570.00	57.2 PK	74.0	-16.8	2.76 V	151	44.6	12.6
6	11570.00	45.3 AV	54.0	-8.7	2.76 V	151	32.7	12.6
7	#17355.00	56.8 PK	74.0	-17.2	2.09 V	313	38.7	18.1
8	#17355.00	48.1 AV	54.0	-5.9	2.09 V	313	30.0	18.1

REMARKS:

1. Emission Level(dBuV/m) = Raw Value(dBuV) + Correction Factor(dB/m)
2. Correction Factor(dB/m) = Antenna Factor(dB/m) + Cable Factor(dB) – Pre-Amplifier Factor(dB)
3. The other emission levels were very low against the limit.
4. Margin value = Emission Level – Limit value
5. " * ": Fundamental frequency.
6. " # ": The radiated frequency is out of the restricted band.

CHANNEL	TX Channel 165	DETECTOR FUNCTION	Peak (PK)
FREQUENCY RANGE	1GHz ~ 40GHz		Average (AV)

ANTENNA POLARITY & TEST DISTANCE: HORIZONTAL AT 3 M

NO.	FREQ. (MHz)	EMISSION LEVEL (dBuV/m)	LIMIT (dBuV/m)	MARGIN (dB)	ANTENNA HEIGHT (m)	TABLE ANGLE (Degree)	RAW VALUE (dBuV)	CORRECTION FACTOR (dB/m)
1	#5649.33	61.0 PK	68.2	-7.2	1.45 H	327	57.1	3.9
2	*5825.00	110.0 PK			1.45 H	327	105.9	4.1
3	*5825.00	100.6 AV			1.45 H	327	96.5	4.1
4	#5961.26	62.0 PK	68.2	-6.2	1.45 H	327	57.2	4.8
5	11650.00	57.3 PK	74.0	-16.7	1.61 H	155	44.6	12.7
6	11650.00	44.9 AV	54.0	-9.1	1.61 H	155	32.2	12.7
7	#17475.00	57.8 PK	74.0	-16.2	3.12 H	62	38.9	18.9
8	#17475.00	46.8 AV	54.0	-7.2	3.12 H	62	27.9	18.9

ANTENNA POLARITY & TEST DISTANCE: VERTICAL AT 3 M

NO.	FREQ. (MHz)	EMISSION LEVEL (dBuV/m)	LIMIT (dBuV/m)	MARGIN (dB)	ANTENNA HEIGHT (m)	TABLE ANGLE (Degree)	RAW VALUE (dBuV)	CORRECTION FACTOR (dB/m)
1	#5644.95	65.7 PK	68.2	-2.5	1.74 V	12	61.8	3.9
2	*5825.00	125.6 PK			1.74 V	12	121.5	4.1
3	*5825.00	115.7 AV			1.74 V	12	111.6	4.1
4	#5934.38	66.6 PK	68.2	-1.6	1.74 V	12	62.1	4.5
5	11650.00	57.6 PK	74.0	-16.4	2.76 V	175	44.9	12.7
6	11650.00	45.5 AV	54.0	-8.5	2.76 V	175	32.8	12.7
7	#17475.00	57.2 PK	74.0	-16.8	2.07 V	306	38.3	18.9
8	#17475.00	48.7 AV	54.0	-5.3	2.07 V	306	29.8	18.9

REMARKS:

1. Emission Level(dBuV/m) = Raw Value(dBuV) + Correction Factor(dB/m)
2. Correction Factor(dB/m) = Antenna Factor(dB/m) + Cable Factor(dB) – Pre-Amplifier Factor(dB)
3. The other emission levels were very low against the limit.
4. Margin value = Emission Level – Limit value
5. " * ": Fundamental frequency.
6. " # ": The radiated frequency is out of the restricted band.

802.11ac (VHT40)

CHANNEL	TX Channel 38	DETECTOR FUNCTION	Peak (PK)
FREQUENCY RANGE	1GHz ~ 40GHz		Average (AV)

ANTENNA POLARITY & TEST DISTANCE: HORIZONTAL AT 3 M

NO.	FREQ. (MHz)	EMISSION LEVEL (dBuV/m)	LIMIT (dBuV/m)	MARGIN (dB)	ANTENNA HEIGHT (m)	TABLE ANGLE (Degree)	RAW VALUE (dBuV)	CORRECTION FACTOR (dB/m)
1	5150.00	55.1 PK	74.0	-18.9	1.29 H	27	52.2	2.9
2	5150.00	42.6 AV	54.0	-11.4	1.29 H	27	39.7	2.9
3	*5190.00	94.9 PK			1.29 H	27	91.9	3.0
4	*5190.00	85.8 AV			1.29 H	27	82.8	3.0
5	5350.00	47.5 PK	74.0	-26.5	1.29 H	27	44.1	3.4
6	5350.00	37.2 AV	54.0	-16.8	1.29 H	27	33.8	3.4
7	#10380.00	55.3 PK	74.0	-18.7	1.00 H	184	43.3	12.0
8	#10380.00	42.6 AV	54.0	-11.4	1.00 H	184	30.6	12.0
9	15570.00	53.5 PK	74.0	-20.5	1.89 H	229	41.2	12.3
10	15570.00	41.4 AV	54.0	-12.6	1.89 H	229	29.1	12.3

ANTENNA POLARITY & TEST DISTANCE: VERTICAL AT 3 M

NO.	FREQ. (MHz)	EMISSION LEVEL (dBuV/m)	LIMIT (dBuV/m)	MARGIN (dB)	ANTENNA HEIGHT (m)	TABLE ANGLE (Degree)	RAW VALUE (dBuV)	CORRECTION FACTOR (dB/m)
1	5150.00	66.2 PK	74.0	-7.8	1.50 V	360	63.3	2.9
2	5150.00	53.9 AV	54.0	-0.1	1.50 V	360	51.0	2.9
3	*5190.00	117.1 PK			1.50 V	360	114.1	3.0
4	*5190.00	108.2 AV			1.50 V	360	105.2	3.0
5	5350.00	58.6 PK	74.0	-15.4	1.50 V	360	55.2	3.4
6	5350.00	48.7 AV	54.0	-5.3	1.50 V	360	45.3	3.4
7	#10380.00	55.8 PK	74.0	-18.2	1.44 V	164	43.8	12.0
8	#10380.00	43.4 AV	54.0	-10.6	1.44 V	164	31.4	12.0
9	15570.00	54.0 PK	74.0	-20.0	1.36 V	342	41.7	12.3
10	15570.00	41.5 AV	54.0	-12.5	1.36 V	342	29.2	12.3

REMARKS:

1. Emission Level(dBuV/m) = Raw Value(dBuV) + Correction Factor(dB/m)
2. Correction Factor(dB/m) = Antenna Factor(dB/m) + Cable Factor(dB) – Pre-Amplifier Factor(dB)
3. The other emission levels were very low against the limit.
4. Margin value = Emission Level – Limit value
5. " * ": Fundamental frequency.
6. " # ": The radiated frequency is out of the restricted band.

CHANNEL	TX Channel 46	DETECTOR FUNCTION	Peak (PK)
FREQUENCY RANGE	1GHz ~ 40GHz		Average (AV)

ANTENNA POLARITY & TEST DISTANCE: HORIZONTAL AT 3 M

NO.	FREQ. (MHz)	EMISSION LEVEL (dBuV/m)	LIMIT (dBuV/m)	MARGIN (dB)	ANTENNA HEIGHT (m)	TABLE ANGLE (Degree)	RAW VALUE (dBuV)	CORRECTION FACTOR (dB/m)
1	5150.00	52.6 PK	74.0	-21.4	1.30 H	40	49.7	2.9
2	5150.00	42.1 AV	54.0	-11.9	1.30 H	40	39.2	2.9
3	*5230.00	97.3 PK			1.30 H	40	94.2	3.1
4	*5230.00	89.3 AV			1.30 H	40	86.2	3.1
5	5350.00	51.8 PK	74.0	-22.2	1.30 H	40	48.4	3.4
6	5350.00	39.6 AV	54.0	-14.4	1.30 H	40	36.2	3.4
7	#10460.00	55.6 PK	74.0	-18.4	1.04 H	177	43.6	12.0
8	#10460.00	42.9 AV	54.0	-11.1	1.04 H	177	30.9	12.0
9	15690.00	53.7 PK	74.0	-20.3	1.88 H	242	40.7	13.0
10	15690.00	41.6 AV	54.0	-12.4	1.88 H	242	28.6	13.0

ANTENNA POLARITY & TEST DISTANCE: VERTICAL AT 3 M

NO.	FREQ. (MHz)	EMISSION LEVEL (dBuV/m)	LIMIT (dBuV/m)	MARGIN (dB)	ANTENNA HEIGHT (m)	TABLE ANGLE (Degree)	RAW VALUE (dBuV)	CORRECTION FACTOR (dB/m)
1	5150.00	64.2 PK	74.0	-9.8	1.46 V	360	61.3	2.9
2	5150.00	53.7 AV	54.0	-0.3	1.46 V	360	50.8	2.9
3	*5230.00	118.9 PK			1.46 V	360	115.8	3.1
4	*5230.00	111.2 AV			1.46 V	360	108.1	3.1
5	5350.00	63.6 PK	74.0	-10.4	1.46 V	360	60.2	3.4
6	5350.00	51.5 AV	54.0	-2.5	1.46 V	360	48.1	3.4
7	#10460.00	55.4 PK	74.0	-18.6	1.41 V	163	43.4	12.0
8	#10460.00	43.5 AV	54.0	-10.5	1.41 V	163	31.5	12.0
9	15690.00	52.9 PK	74.0	-21.1	1.38 V	347	39.9	13.0
10	15690.00	40.7 AV	54.0	-13.3	1.38 V	347	27.7	13.0

REMARKS:

1. Emission Level(dBuV/m) = Raw Value(dBuV) + Correction Factor(dB/m)
2. Correction Factor(dB/m) = Antenna Factor(dB/m) + Cable Factor(dB) – Pre-Amplifier Factor(dB)
3. The other emission levels were very low against the limit.
4. Margin value = Emission Level – Limit value
5. " * ": Fundamental frequency.
6. " # ": The radiated frequency is out of the restricted band.

CHANNEL	TX Channel 151	DETECTOR FUNCTION	Peak (PK)
FREQUENCY RANGE	1GHz ~ 40GHz		Average (AV)

ANTENNA POLARITY & TEST DISTANCE: HORIZONTAL AT 3 M

NO.	FREQ. (MHz)	EMISSION LEVEL (dBuV/m)	LIMIT (dBuV/m)	MARGIN (dB)	ANTENNA HEIGHT (m)	TABLE ANGLE (Degree)	RAW VALUE (dBuV)	CORRECTION FACTOR (dB/m)
1	#5643.54	61.2 PK	68.2	-7.0	2.19 H	331	57.3	3.9
2	*5755.00	106.7 PK			2.19 H	331	102.7	4.0
3	*5755.00	97.8 AV			2.19 H	331	93.8	4.0
4	#5930.23	61.4 PK	68.2	-6.8	2.19 H	331	56.9	4.5
5	11510.00	57.5 PK	74.0	-16.5	1.63 H	143	44.8	12.7
6	11510.00	45.3 AV	54.0	-8.7	1.63 H	143	32.6	12.7
7	#17265.00	58.4 PK	74.0	-15.6	3.14 H	57	40.8	17.6
8	#17265.00	47.2 AV	54.0	-6.8	3.14 H	57	29.6	17.6

ANTENNA POLARITY & TEST DISTANCE: VERTICAL AT 3 M

NO.	FREQ. (MHz)	EMISSION LEVEL (dBuV/m)	LIMIT (dBuV/m)	MARGIN (dB)	ANTENNA HEIGHT (m)	TABLE ANGLE (Degree)	RAW VALUE (dBuV)	CORRECTION FACTOR (dB/m)
1	#5644.67	66.9 PK	68.2	-1.3	2.11 V	216	63.0	3.9
2	*5755.00	121.7 PK			2.11 V	216	117.7	4.0
3	*5755.00	113.0 AV			2.11 V	216	109.0	4.0
4	#5928.99	63.7 PK	68.2	-4.5	2.11 V	216	59.2	4.5
5	11510.00	58.0 PK	74.0	-16.0	2.81 V	170	45.3	12.7
6	11510.00	45.7 AV	54.0	-8.3	2.81 V	170	33.0	12.7
7	#17265.00	57.3 PK	74.0	-16.7	2.13 V	302	39.7	17.6
8	#17265.00	48.7 AV	54.0	-5.3	2.13 V	302	31.1	17.6

REMARKS:

1. Emission Level(dBuV/m) = Raw Value(dBuV) + Correction Factor(dB/m)
2. Correction Factor(dB/m) = Antenna Factor(dB/m) + Cable Factor(dB) – Pre-Amplifier Factor(dB)
3. The other emission levels were very low against the limit.
4. Margin value = Emission Level – Limit value
5. " * ": Fundamental frequency.
6. " # ": The radiated frequency is out of the restricted band.

CHANNEL	TX Channel 159	DETECTOR FUNCTION	Peak (PK)
FREQUENCY RANGE	1GHz ~ 40GHz		Average (AV)

ANTENNA POLARITY & TEST DISTANCE: HORIZONTAL AT 3 M

NO.	FREQ. (MHz)	EMISSION LEVEL (dBuV/m)	LIMIT (dBuV/m)	MARGIN (dB)	ANTENNA HEIGHT (m)	TABLE ANGLE (Degree)	RAW VALUE (dBuV)	CORRECTION FACTOR (dB/m)
1	#5637.54	62.6 PK	68.2	-5.6	2.15 H	328	58.8	3.8
2	*5795.00	107.3 PK			2.15 H	328	103.3	4.0
3	*5795.00	98.2 AV			2.15 H	328	94.2	4.0
4	#5959.11	60.6 PK	68.2	-7.6	2.15 H	328	55.8	4.8
5	11590.00	57.6 PK	74.0	-16.4	1.64 H	151	45.0	12.6
6	11590.00	45.3 AV	54.0	-8.7	1.64 H	151	32.7	12.6
7	#17385.00	58.4 PK	74.0	-15.6	3.08 H	75	40.0	18.4
8	#17385.00	47.2 AV	54.0	-6.8	3.08 H	75	28.8	18.4

ANTENNA POLARITY & TEST DISTANCE: VERTICAL AT 3 M

NO.	FREQ. (MHz)	EMISSION LEVEL (dBuV/m)	LIMIT (dBuV/m)	MARGIN (dB)	ANTENNA HEIGHT (m)	TABLE ANGLE (Degree)	RAW VALUE (dBuV)	CORRECTION FACTOR (dB/m)
1	#5621.30	67.0 PK	68.2	-1.2	1.90 V	218	63.2	3.8
2	*5795.00	123.0 PK			1.90 V	218	119.0	4.0
3	*5795.00	113.8 AV			1.90 V	218	109.8	4.0
4	#5936.02	65.4 PK	68.2	-2.8	1.90 V	218	60.9	4.5
5	11590.00	57.8 PK	74.0	-16.2	2.71 V	185	45.2	12.6
6	11590.00	45.8 AV	54.0	-8.2	2.71 V	185	33.2	12.6
7	#17385.00	56.9 PK	74.0	-17.1	2.16 V	326	38.5	18.4
8	#17385.00	48.3 AV	54.0	-5.7	2.16 V	326	29.9	18.4

REMARKS:

1. Emission Level(dBuV/m) = Raw Value(dBuV) + Correction Factor(dB/m)
2. Correction Factor(dB/m) = Antenna Factor(dB/m) + Cable Factor(dB) – Pre-Amplifier Factor(dB)
3. The other emission levels were very low against the limit.
4. Margin value = Emission Level – Limit value
5. " * ": Fundamental frequency.
6. " # ": The radiated frequency is out of the restricted band.

802.11ac (VHT80)

CHANNEL	TX Channel 42	DETECTOR FUNCTION	Peak (PK)
FREQUENCY RANGE	1GHz ~ 40GHz		Average (AV)

ANTENNA POLARITY & TEST DISTANCE: HORIZONTAL AT 3 M

NO.	FREQ. (MHz)	EMISSION LEVEL (dBuV/m)	LIMIT (dBuV/m)	MARGIN (dB)	ANTENNA HEIGHT (m)	TABLE ANGLE (Degree)	RAW VALUE (dBuV)	CORRECTION FACTOR (dB/m)
1	5150.00	51.1 PK	74.0	-22.9	1.25 H	29	48.2	2.9
2	5150.00	42.6 AV	54.0	-11.4	1.25 H	29	39.7	2.9
3	*5210.00	90.0 PK			1.25 H	29	87.0	3.0
4	*5210.00	81.8 AV			1.25 H	29	78.8	3.0
5	5350.00	46.8 PK	74.0	-27.2	1.25 H	29	43.4	3.4
6	5350.00	35.9 AV	54.0	-18.1	1.25 H	29	32.5	3.4
7	#10420.00	54.8 PK	74.0	-19.2	1.02 H	188	42.9	11.9
8	#10420.00	42.2 AV	54.0	-11.8	1.02 H	188	30.3	11.9
9	15630.00	53.6 PK	74.0	-20.4	1.89 H	225	41.1	12.5
10	15630.00	41.5 AV	54.0	-12.5	1.89 H	225	29.0	12.5

ANTENNA POLARITY & TEST DISTANCE: VERTICAL AT 3 M

NO.	FREQ. (MHz)	EMISSION LEVEL (dBuV/m)	LIMIT (dBuV/m)	MARGIN (dB)	ANTENNA HEIGHT (m)	TABLE ANGLE (Degree)	RAW VALUE (dBuV)	CORRECTION FACTOR (dB/m)
1	5150.00	62.0 PK	74.0	-12.0	1.50 V	0	59.1	2.9
2	5150.00	53.9 AV	54.0	-0.1	1.50 V	0	51.0	2.9
3	*5210.00	110.5 PK			1.50 V	0	107.5	3.0
4	*5210.00	102.8 AV			1.50 V	0	99.8	3.0
5	5350.00	58.2 PK	74.0	-15.8	1.50 V	0	54.8	3.4
6	5350.00	47.5 AV	54.0	-6.5	1.50 V	0	44.1	3.4
7	#10420.00	56.5 PK	74.0	-17.5	1.49 V	157	44.6	11.9
8	#10420.00	44.2 AV	54.0	-9.8	1.49 V	157	32.3	11.9
9	15630.00	53.5 PK	74.0	-20.5	1.30 V	360	41.0	12.5
10	15630.00	41.2 AV	54.0	-12.8	1.30 V	360	28.7	12.5

REMARKS:

- Emission Level(dBuV/m) = Raw Value(dBuV) + Correction Factor(dB/m)
- Correction Factor(dB/m) = Antenna Factor(dB/m) + Cable Factor(dB) – Pre-Amplifier Factor(dB)
- The other emission levels were very low against the limit.
- Margin value = Emission Level – Limit value
- " * ": Fundamental frequency.
- " # ": The radiated frequency is out of the restricted band.

CHANNEL	TX Channel 155	DETECTOR FUNCTION	Peak (PK)
FREQUENCY RANGE	1GHz ~ 40GHz		Average (AV)

ANTENNA POLARITY & TEST DISTANCE: HORIZONTAL AT 3 M

NO.	FREQ. (MHz)	EMISSION LEVEL (dBuV/m)	LIMIT (dBuV/m)	MARGIN (dB)	ANTENNA HEIGHT (m)	TABLE ANGLE (Degree)	RAW VALUE (dBuV)	CORRECTION FACTOR (dB/m)
1	#5635.16	60.4 PK	68.2	-7.8	1.50 H	210	56.6	3.8
2	*5775.00	98.6 PK			1.50 H	210	94.6	4.0
3	*5775.00	91.3 AV			1.50 H	210	87.3	4.0
4	#5953.14	60.7 PK	68.2	-7.5	1.50 H	210	56.1	4.6
5	11550.00	58.0 PK	74.0	-16.0	1.60 H	165	45.4	12.6
6	11550.00	45.4 AV	54.0	-8.6	1.60 H	165	32.8	12.6
7	#17325.00	58.3 PK	74.0	-15.7	3.12 H	85	40.5	17.8
8	#17325.00	46.8 AV	54.0	-7.2	3.12 H	85	29.0	17.8

ANTENNA POLARITY & TEST DISTANCE: VERTICAL AT 3 M

NO.	FREQ. (MHz)	EMISSION LEVEL (dBuV/m)	LIMIT (dBuV/m)	MARGIN (dB)	ANTENNA HEIGHT (m)	TABLE ANGLE (Degree)	RAW VALUE (dBuV)	CORRECTION FACTOR (dB/m)
1	#5639.12	67.7 PK	68.2	-0.5	2.10 V	216	63.9	3.8
2	*5775.00	114.3 PK			2.10 V	216	110.3	4.0
3	*5775.00	106.9 AV			2.10 V	216	102.9	4.0
4	#5923.85	65.0 PK	69.0	-4.0	2.10 V	216	60.6	4.4
5	11550.00	56.8 PK	74.0	-17.2	2.78 V	170	44.2	12.6
6	11550.00	44.8 AV	54.0	-9.2	2.78 V	170	32.2	12.6
7	#17325.00	56.8 PK	74.0	-17.2	2.15 V	324	39.0	17.8
8	#17325.00	48.3 AV	54.0	-5.7	2.15 V	324	30.5	17.8

REMARKS:

1. Emission Level(dBuV/m) = Raw Value(dBuV) + Correction Factor(dB/m)
2. Correction Factor(dB/m) = Antenna Factor(dB/m) + Cable Factor(dB) – Pre-Amplifier Factor(dB)
3. The other emission levels were very low against the limit.
4. Margin value = Emission Level – Limit value
5. " * ": Fundamental frequency.
6. " # ": The radiated frequency is out of the restricted band.

802.11ac (VHT80+80)

CHANNEL	TX Channel 42+155	DETECTOR FUNCTION	Peak (PK)
FREQUENCY RANGE	1GHz ~ 40GHz		Average (AV)

ANTENNA POLARITY & TEST DISTANCE: HORIZONTAL AT 3 M

NO.	FREQ. (MHz)	EMISSION LEVEL (dBuV/m)	LIMIT (dBuV/m)	MARGIN (dB)	ANTENNA HEIGHT (m)	TABLE ANGLE (Degree)	RAW VALUE (dBuV)	CORRECTION FACTOR (dB/m)
1	5150.00	51.2 PK	74.0	-22.8	1.23 H	37	48.3	2.9
2	5150.00	43.0 AV	54.0	-11.0	1.23 H	37	40.1	2.9
3	*5210.00	93.1 PK			1.23 H	37	90.1	3.0
4	*5210.00	85.1 AV			1.23 H	37	82.1	3.0
5	5350.00	46.7 PK	74.0	-27.3	1.23 H	37	43.3	3.4
6	5350.00	35.8 AV	54.0	-18.2	1.23 H	37	32.4	3.4
7	#5631.11	60.6 PK	68.2	-7.6	1.96 H	321	56.8	3.8
8	*5775.00	97.0 PK			1.96 H	321	93.0	4.0
9	*5775.00	89.3 AV			1.96 H	321	85.3	4.0
10	#5956.93	60.4 PK	68.2	-7.8	1.96 H	321	55.6	4.8
11	#10420.00	56.5 PK	74.0	-17.5	1.02 H	195	44.6	11.9
12	#10420.00	43.7 AV	54.0	-10.3	1.02 H	195	31.8	11.9
13	11550.00	57.1 PK	74.0	-16.9	1.66 H	179	44.5	12.6
14	11550.00	45.1 AV	54.0	-8.9	1.66 H	179	32.5	12.6
15	15630.00	53.4 PK	74.0	-20.6	1.89 H	220	40.9	12.5
16	15630.00	41.0 AV	54.0	-13.0	1.89 H	220	28.5	12.5
17	#17325.00	57.5 PK	74.0	-16.5	3.15 H	60	39.7	17.8
18	#17325.00	46.6 AV	54.0	-7.4	3.15 H	60	28.8	17.8

ANTENNA POLARITY & TEST DISTANCE: VERTICAL AT 3 M

NO.	FREQ. (MHz)	EMISSION LEVEL (dBuV/m)	LIMIT (dBuV/m)	MARGIN (dB)	ANTENNA HEIGHT (m)	TABLE ANGLE (Degree)	RAW VALUE (dBuV)	CORRECTION FACTOR (dB/m)
1	5150.00	63.8 PK	74.0	-10.2	1.50 V	1	60.9	2.9
2	5150.00	53.9 AV	54.0	-0.1	1.50 V	1	51.0	2.9
3	*5210.00	108.8 PK			1.50 V	1	105.8	3.0
4	*5210.00	100.7 AV			1.50 V	1	97.7	3.0
5	5350.00	57.6 PK	74.0	-16.4	1.50 V	1	54.2	3.4
6	5350.00	48.0 AV	54.0	-6.0	1.50 V	1	44.6	3.4
7	#5631.78	65.5 PK	68.2	-2.7	1.91 V	21	61.7	3.8
8	*5775.00	110.4 PK			1.91 V	21	106.4	4.0
9	*5775.00	102.5 AV			1.91 V	21	98.5	4.0
10	#5977.46	61.9 PK	68.2	-6.3	1.91 V	21	56.9	5.0
11	#10420.00	56.3 PK	74.0	-17.7	1.53 V	177	44.4	11.9
12	#10420.00	44.0 AV	54.0	-10.0	1.53 V	177	32.1	11.9
13	11550.00	57.8 PK	74.0	-16.2	2.73 V	185	45.2	12.6
14	11550.00	45.7 AV	54.0	-8.3	2.73 V	185	33.1	12.6
15	15630.00	54.0 PK	74.0	-20.0	1.30 V	354	41.5	12.5
16	15630.00	41.5 AV	54.0	-12.5	1.30 V	354	29.0	12.5
17	#17325.00	57.6 PK	74.0	-16.4	2.12 V	320	39.8	17.8
18	#17325.00	49.1 AV	54.0	-4.9	2.12 V	320	31.3	17.8

REMARKS:

1. Emission Level(dBuV/m) = Raw Value(dBuV) + Correction Factor(dB/m)
2. Correction Factor(dB/m) = Antenna Factor(dB/m) + Cable Factor(dB) – Pre-Amplifier Factor(dB)
3. The other emission levels were very low against the limit.
4. Margin value = Emission Level – Limit value
5. " * ": Fundamental frequency.
6. " # ": The radiated frequency is out of the restricted band.

Below 1GHz Data:

CHANNEL	TX Channel 157	DETECTOR FUNCTION	Quasi-Peak (QP)
FREQUENCY RANGE	9kHz ~ 1GHz		

ANTENNA POLARITY & TEST DISTANCE: HORIZONTAL AT 3 M

NO.	FREQ. (MHz)	EMISSION LEVEL (dBuV/m)	LIMIT (dBuV/m)	MARGIN (dB)	ANTENNA HEIGHT (m)	TABLE ANGLE (Degree)	RAW VALUE (dBuV)	CORRECTION FACTOR (dB/m)
1	33.35	33.5 QP	40.0	-6.5	2.50 H	135	42.5	-9.0
2	101.88	26.6 QP	43.5	-16.9	2.50 H	298	38.9	-12.3
3	250.00	30.0 QP	46.0	-16.0	1.50 H	83	39.7	-9.7
4	393.29	30.4 QP	46.0	-15.6	1.00 H	297	36.1	-5.7
5	500.01	30.6 QP	46.0	-15.4	2.00 H	27	33.4	-2.8
6	994.81	33.7 QP	54.0	-20.3	1.50 H	38	28.7	5.0

ANTENNA POLARITY & TEST DISTANCE: VERTICAL AT 3 M

NO.	FREQ. (MHz)	EMISSION LEVEL (dBuV/m)	LIMIT (dBuV/m)	MARGIN (dB)	ANTENNA HEIGHT (m)	TABLE ANGLE (Degree)	RAW VALUE (dBuV)	CORRECTION FACTOR (dB/m)
1	50.44	31.4 QP	40.0	-8.6	1.00 V	360	39.6	-8.2
2	108.81	29.2 QP	43.5	-14.3	1.00 V	18	40.5	-11.3
3	250.02	27.8 QP	46.0	-18.2	1.50 V	360	37.5	-9.7
4	348.38	26.1 QP	46.0	-19.9	1.00 V	360	32.8	-6.7
5	750.06	28.8 QP	46.0	-17.2	1.50 V	128	26.8	2.0
6	994.81	37.2 QP	54.0	-16.8	1.00 V	103	32.2	5.0

REMARKS:

1. Emission Level(dBuV/m) = Raw Value(dBuV) + Correction Factor(dB/m)
2. Correction Factor(dB/m) = Antenna Factor(dB/m) + Cable Factor(dB) – Pre-Amplifier Factor(dB)
3. The other emission levels were very low against the limit.
4. Margin value = Emission Level – Limit value

4.2 Conducted Emission Measurement

4.2.1 Limits of Conducted Emission Measurement

Frequency (MHz)	Conducted Limit (dBuV)	
	Quasi-peak	Average
0.15 - 0.5	66 - 56	56 - 46
0.50 - 5.0	56	46
5.0 - 30.0	60	50

Note: 1. The lower limit shall apply at the transition frequencies.

2. The limit decreases in line with the logarithm of the frequency in the range of 0.15 to 0.50MHz.

4.2.2 Test Instruments

DESCRIPTION & MANUFACTURER	MODEL NO.	SERIAL NO.	CALIBRATED DATE	CALIBRATED UNTIL
Test Receiver R&S	ESCS 30	847124/029	Oct. 24, 2016	Oct. 23, 2017
Line-Impedance Stabilization Network (for EUT) R&S	ESH3-Z5	848773/004	Oct. 26, 2016	Oct. 25, 2017
Line-Impedance Stabilization Network (for Peripheral) R&S	ENV216	100072	June 13, 2016	June 12, 2017
50 ohms Terminator	N/A	EMC-02	Sep. 29, 2016	Sep. 28, 2017
RF Cable	5D-FB	COCCAB-001	Sep. 30, 2016	Sep. 29, 2017
10 dB PAD Mini-Circuits	HAT-10+	CONATT-004	June 20, 2016	June 19, 2017
Software BVADT	BVADT_Cond_ V7.3.7.4	NA	NA	NA

Note:

1. The calibration interval of the above test instruments are 12 months and the calibrations are traceable to NML/ROC and NIST/USA.
2. The test was performed in Shielded Room No. 1.
3. Tested Date: Jan. 25, 2017

4.2.3 Test Procedure

- The EUT was placed 0.4 meters from the conducting wall of the shielded room with EUT being connected to the power mains through a line impedance stabilization network (LISN). Other support units were connected to the power mains through another LISN. The two LISNs provide 50 ohm/ 50uH of coupling impedance for the measuring instrument.
- Both lines of the power mains connected to the EUT were checked for maximum conducted interference.
- The frequency range from 150kHz to 30MHz was searched. Emission levels under (Limit - 20dB) was not recorded.

NOTE: All modes of operation were investigated and the worst-case emissions are reported.

4.2.4 Deviation from Test Standard

No deviation.

4.2.5 Test Setup

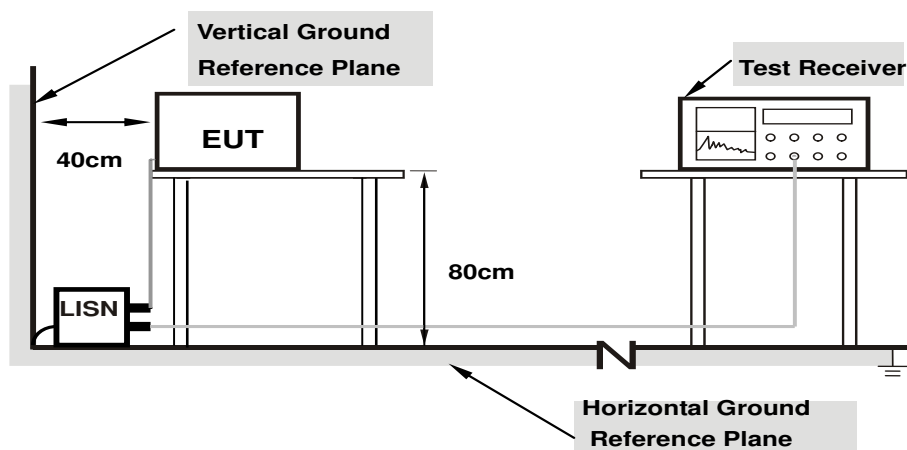

Note: 1.Support units were connected to second LISN.

For the actual test configuration, please refer to the attached file (Test Setup Photo).

4.2.6 EUT Operating Condition

Same as 4.1.6.

4.2.7 Test Results

Phase	Line (L)	Detector Function	Quasi-Peak (QP) / Average (AV)
-------	----------	-------------------	--------------------------------

Phase Of Power : Line (L)										
No	Frequency (MHz)	Correction Factor (dB)	Reading Value (dBuV)		Emission Level (dBuV)		Limit (dBuV)		Margin (dB)	
			Q.P.	AV.	Q.P.	AV.	Q.P.	AV.	Q.P.	AV.
1	0.15781	10.19	30.85	17.31	41.04	27.50	65.58	55.58	-24.54	-28.08
2	0.37656	10.22	29.73	21.89	39.95	32.11	58.35	48.35	-18.40	-16.24
3	0.75156	10.24	12.44	3.61	22.68	13.85	56.00	46.00	-33.32	-32.15
4	1.75391	10.24	16.20	8.31	26.44	18.55	56.00	46.00	-29.56	-27.45
5	2.95703	10.24	18.93	8.89	29.17	19.13	56.00	46.00	-26.83	-26.87
6	20.18359	11.38	30.36	25.17	41.74	36.55	60.00	50.00	-18.26	-13.45

Remarks:

1. Q.P. and AV. are abbreviations of quasi-peak and average individually.
2. The emission levels of other frequencies were very low against the limit.
3. Margin value = Emission level – Limit value
4. Correction factor = Insertion loss + Cable loss
5. Emission Level = Correction Factor + Reading Value

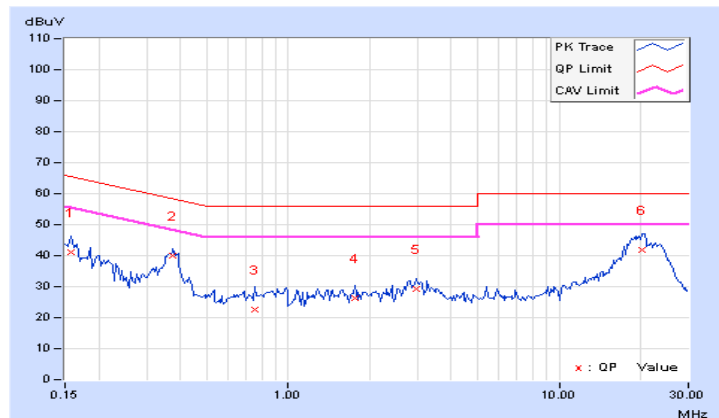

Phase	Neutral (N)	Detector Function	Quasi-Peak (QP) / Average (AV)
-------	-------------	-------------------	--------------------------------

Phase Of Power : Neutral (N)										
No	Frequency (MHz)	Correction Factor (dB)	Reading Value (dBuV)		Emission Level (dBuV)		Limit (dBuV)		Margin (dB)	
			Q.P.	AV.	Q.P.	AV.	Q.P.	AV.	Q.P.	AV.
1	0.15781	10.18	30.75	17.15	40.93	27.33	65.58	55.58	-24.65	-28.25
2	0.37656	10.20	26.51	18.75	36.71	28.95	58.35	48.35	-21.64	-19.40
3	0.69688	10.22	13.82	4.79	24.04	15.01	56.00	46.00	-31.96	-30.99
4	2.17969	10.27	13.43	4.33	23.70	14.60	56.00	46.00	-32.30	-31.40
5	3.79688	10.17	12.99	4.14	23.16	14.31	56.00	46.00	-32.84	-31.69
6	19.67188	11.09	28.36	23.17	39.45	34.26	60.00	50.00	-20.55	-15.74

Remarks:

1. Q.P. and AV. are abbreviations of quasi-peak and average individually.
2. The emission levels of other frequencies were very low against the limit.
3. Margin value = Emission level – Limit value
4. Correction factor = Insertion loss + Cable loss
5. Emission Level = Correction Factor + Reading Value

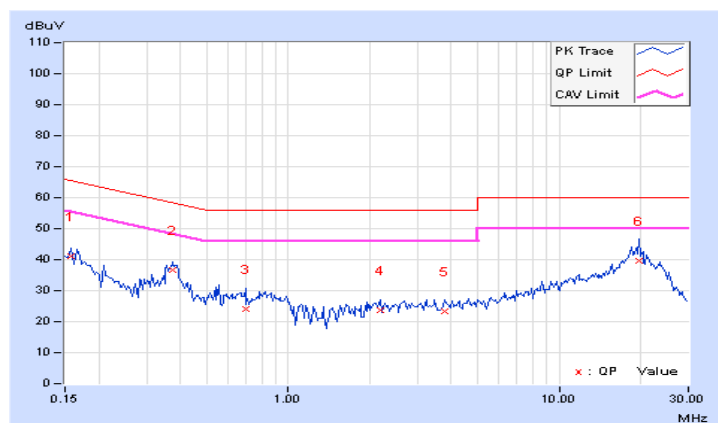

4.3 Transmit Power Measurement

4.3.1 Limits of Transmit Power Measurement

Operation Band	EUT Category		Limit
U-NII-1		Outdoor Access Point	1 Watt (30 dBm) (Max. e.i.r.p \leq 125mW(21 dBm) at any elevation angle above 30 degrees as measured from the horizon)
		Fixed point-to-point Access Point	1 Watt (30 dBm)
	√	Indoor Access Point	1 Watt (30 dBm)
		Mobile and Portable client device	250mW (24 dBm)
U-NII-2A			250mW (24 dBm) or 11 dBm+10 log B*
U-NII-2C			250mW (24 dBm) or 11 dBm+10 log B*
U-NII-3	√		1 Watt (30 dBm)

*B is the 26 dB emission bandwidth in megahertz

Per KDB 662911 Method of conducted output power measurement on IEEE 802.11 devices,

Array Gain = 0 dB (i.e., no array gain) for $N_{ANT} \leq 4$;

Array Gain = 0 dB (i.e., no array gain) for channel widths ≥ 40 MHz for any N_{ANT} ;

Array Gain = $5 \log(N_{ANT}/N_{SS})$ dB or 3 dB, whichever is less for 20-MHz channel widths with $N_{ANT} \geq 5$.

For power measurements on all other devices: Array Gain = $10 \log(N_{ANT}/N_{SS})$ dB.

4.3.2 Test Setup

4.3.3 Test Instruments

Refer to section 4.1.2 to get information of above instrument.

4.3.4 Test Procedure

Method PM is used to perform output power measurement, trigger and gating function of wide band power meter is enabled to measure max output power of TX on burst. Duty factor is not added to measured value.

4.3.5 Deviation from Test Standard

No deviation.

4.3.6 EUT Operating Condition

The software provided by client to enable the EUT under transmission condition continuously at lowest, middle and highest channel frequencies individually.

4.3.7 Test Result (Mode 1)

CDD Mode
802.11a

Chan.	Chan. Freq. (MHz)	Maximum Conducted Power (dBm)				Total Power (mW)	Total Power (dBm)	Limit (dBm)	Pass / Fail
		Chain 0	Chain 1	Chain 2	Chain 3				
36	5180	21.80	21.75	21.18	21.84	584.957	27.67	30.00	Pass
40	5200	22.13	21.94	22.08	22.64	664.71	28.23	30.00	Pass
48	5240	22.03	21.93	22.04	22.53	654.56	28.16	30.00	Pass
149	5745	24.06	23.47	23.80	22.26	885.164	29.47	30.00	Pass
157	5785	24.38	24.05	24.12	22.77	975.714	29.89	30.00	Pass
165	5825	24.00	24.15	24.10	23.03	969.154	29.86	30.00	Pass

802.11ac (VHT20)

Chan.	Chan. Freq. (MHz)	Maximum Conducted Power (dBm)				Total Power (mW)	Total Power (dBm)	Limit (dBm)	Pass / Fail
		Chain 0	Chain 1	Chain 2	Chain 3				
36	5180	22.08	21.95	21.95	22.65	658.863	28.19	30.00	Pass
40	5200	22.02	21.95	22.00	22.51	652.623	28.15	30.00	Pass
48	5240	22.14	22.01	21.87	22.27	645.007	28.10	30.00	Pass
149	5745	24.28	23.91	23.87	22.68	943.088	29.75	30.00	Pass
157	5785	24.31	24.08	23.97	22.65	959.169	29.82	30.00	Pass
165	5825	23.96	24.14	23.98	22.82	949.765	29.78	30.00	Pass

802.11ac (VHT40)

Chan.	Chan. Freq. (MHz)	Maximum Conducted Power (dBm)				Total Power (mW)	Total Power (dBm)	Limit (dBm)	Pass / Fail
		Chain 0	Chain 1	Chain 2	Chain 3				
38	5190	20.28	20.16	20.14	20.91	436.999	26.40	30.00	Pass
46	5230	23.85	23.66	24.00	24.30	995.277	29.98	30.00	Pass
151	5755	24.36	23.93	23.79	22.59	940.954	29.74	30.00	Pass
159	5795	24.30	24.00	23.95	22.62	951.465	29.78	30.00	Pass

802.11ac (VHT80)

Chan.	Chan. Freq. (MHz)	Maximum Conducted Power (dBm)				Total Power (mW)	Total Power (dBm)	Limit (dBm)	Pass / Fail
		Chain 0	Chain 1	Chain 2	Chain 3				
42	5210	18.99	18.96	19.06	19.68	331.39	25.20	30.00	Pass
155	5775	22.24	22.04	21.75	20.42	587.228	27.69	30.00	Pass

802.11ac (VHT80+80)

Chan.	Chan. Freq. (MHz)	Maximum Conducted Power (dBm)				Total Power (mW)	Total Power (dBm)	Limit (dBm)	Pass / Fail
		Chain 0	Chain 1	Chain 2	Chain 3				
42 +155	5210	20.95	20.74	-	-	243.028	23.86	30.00	Pass
	5775	-	-	21.42	20.98	263.99	24.22	30.00	Pass

Beamforming Mode

802.11ac (VHT20)

Chan.	Chan. Freq. (MHz)	Maximum Conducted Power (dBm)				Total Power (mW)	Total Power (dBm)	Limit (dBm)	Pass / Fail
		Chain 0	Chain 1	Chain 2	Chain 3				
36	5180	21.07	20.88	20.91	21.54	516.271	27.13	28.25	Pass
40	5200	21.01	20.89	21.02	21.13	505.119	27.03	28.25	Pass
48	5240	21.03	20.94	20.83	21.15	502.307	27.01	28.25	Pass
149	5745	22.21	21.88	21.79	20.56	585.282	27.67	28.25	Pass
157	5785	22.28	22.04	21.93	20.62	600.3	27.78	28.25	Pass
165	5825	21.93	22.10	21.90	20.79	592.968	27.73	28.25	Pass

NOTE: Directional gain = 7.75dBi > 6dBi, so the power limit shall be reduced to $30 - (7.75 - 6) = 28.25$ dBm.

802.11ac (VHT40)

Chan.	Chan. Freq. (MHz)	Maximum Conducted Power (dBm)				Total Power (mW)	Total Power (dBm)	Limit (dBm)	Pass / Fail
		Chain 0	Chain 1	Chain 2	Chain 3				
38	5190	20.28	20.16	20.14	20.91	436.999	26.40	28.25	Pass
46	5230	21.52	21.23	21.62	21.82	571.911	27.57	28.25	Pass
151	5755	22.34	21.87	21.74	20.48	586.176	27.68	28.25	Pass
159	5795	22.02	21.89	21.86	20.55	580.709	27.64	28.25	Pass

NOTE: Directional gain = 7.75dBi > 6dBi, so the power limit shall be reduced to $30 - (7.75 - 6) = 28.25$ dBm.

802.11ac (VHT80)

Chan.	Chan. Freq. (MHz)	Maximum Conducted Power (dBm)				Total Power (mW)	Total Power (dBm)	Limit (dBm)	Pass / Fail
		Chain 0	Chain 1	Chain 2	Chain 3				
42	5210	18.99	18.96	19.06	19.68	331.39	25.20	28.25	Pass
155	5775	22.24	22.04	21.75	20.42	587.228	27.69	28.25	Pass

NOTE: Directional gain = 7.75dBi > 6dBi, so the power limit shall be reduced to $30 - (7.75 - 6) = 28.25$ dBm.

802.11ac (VHT80+80)

Chan.	Chan. Freq. (MHz)	Maximum Conducted Power (dBm)				Total Power (mW)	Total Power (dBm)	Limit (dBm)	Pass / Fail
		Chain 0	Chain 1	Chain 2	Chain 3				
42+155	5210	20.95	20.74	-	-	243.028	23.86	30	Pass
	5775	-	-	21.42	20.98	263.99	24.22	30	Pass

NOTE: Directional gain = $2\text{dBi} + 10\log(2) = 5.01\text{dBi} < 6\text{dBi}$, so the power limit shall not be reduced.

4.3.8 Test Result (Mode 2)

CDD Mode
802.11a

Chan.	Chan. Freq. (MHz)	Maximum Conducted Power (dBm)				Total Power (mW)	Total Power (dBm)	Limit (dBm)	Pass / Fail
		Chain 0	Chain 1	Chain 2	Chain 3				
36	5180	19.05	18.87	18.82	19.48	322.367	25.08	30.00	Pass
40	5200	19.03	18.90	18.89	19.40	322.15	25.08	30.00	Pass
48	5240	18.99	18.70	18.95	19.16	314.319	24.97	30.00	Pass
149	5745	22.94	21.96	22.27	20.31	629.879	27.99	30.00	Pass
157	5785	23.13	22.16	22.54	20.25	655.424	28.17	30.00	Pass
165	5825	22.31	22.23	22.68	20.93	646.558	28.11	30.00	Pass

802.11ac (VHT20)

Chan.	Chan. Freq. (MHz)	Maximum Conducted Power (dBm)				Total Power (mW)	Total Power (dBm)	Limit (dBm)	Pass / Fail
		Chain 0	Chain 1	Chain 2	Chain 3				
36	5180	17.36	17.25	17.48	18.05	227.34	23.57	30.00	Pass
40	5200	18.19	18.11	18.47	18.90	278.563	24.45	30.00	Pass
48	5240	18.22	18.06	18.40	18.60	271.974	24.35	30.00	Pass
149	5745	22.52	21.54	21.84	19.90	571.691	27.57	30.00	Pass
157	5785	22.91	22.10	22.35	20.35	637.799	28.05	30.00	Pass
165	5825	22.33	22.23	22.75	20.97	651.502	28.14	30.00	Pass

802.11ac (VHT40)

Chan.	Chan. Freq. (MHz)	Maximum Conducted Power (dBm)				Total Power (mW)	Total Power (dBm)	Limit (dBm)	Pass / Fail
		Chain 0	Chain 1	Chain 2	Chain 3				
38	5190	16.45	16.19	16.71	17.30	186.332	22.70	30.00	Pass
46	5230	18.76	18.37	19.10	19.45	313.257	24.96	30.00	Pass
151	5755	21.82	21.01	21.36	19.31	500.321	26.99	30.00	Pass
159	5795	21.96	21.11	21.69	19.58	524.511	27.20	30.00	Pass

802.11ac (VHT80)

Chan.	Chan. Freq. (MHz)	Maximum Conducted Power (dBm)				Total Power (mW)	Total Power (dBm)	Limit (dBm)	Pass / Fail
		Chain 0	Chain 1	Chain 2	Chain 3				
42	5210	12.63	12.37	12.80	13.13	75.195	18.76	30.00	Pass
155	5775	18.42	17.78	17.54	16.63	232.261	23.66	30.00	Pass

802.11ac (VHT80+80)

Chan.	Chan. Freq. (MHz)	Maximum Conducted Power (dBm)				Total Power (mW)	Total Power (dBm)	Limit (dBm)	Pass / Fail
		Chain 0	Chain 1	Chain 2	Chain 3				
42 +155	5210	17.70	17.44	-	-	114.347	20.58	30.00	Pass
	5775	-	-	17.81	17.41	115.476	20.62	30.00	Pass

Beamforming Mode

802.11ac (VHT20)

Chan.	Chan. Freq. (MHz)	Maximum Conducted Power (dBm)				Total Power (mW)	Total Power (dBm)	Limit (dBm)	Pass / Fail
		Chain 0	Chain 1	Chain 2	Chain 3				
36	5180	17.36	17.25	17.48	18.05	227.34	23.57	25.1	Pass
40	5200	18.19	18.11	18.47	18.90	278.563	24.45	25.1	Pass
48	5240	18.22	18.06	18.40	18.60	271.974	24.35	25.1	Pass
149	5745	19.62	18.64	18.92	16.86	291.248	24.64	25.1	Pass
157	5785	19.64	18.72	18.92	16.92	293.705	24.68	25.1	Pass
165	5825	19.09	19.27	19.42	17.55	310.007	24.91	25.1	Pass

NOTE: Directional gain = 10.9dBi > 6dBi, so the power limit shall be reduced to $30-(10.9-6) = 25.1$ dBm.

802.11ac (VHT40)

Chan.	Chan. Freq. (MHz)	Maximum Conducted Power (dBm)				Total Power (mW)	Total Power (dBm)	Limit (dBm)	Pass / Fail
		Chain 0	Chain 1	Chain 2	Chain 3				
38	5190	16.45	16.19	16.71	17.30	186.332	22.70	25.1	Pass
46	5230	18.76	18.37	19.10	19.45	313.257	24.96	25.1	Pass
151	5755	19.66	18.95	19.25	17.32	309.085	24.90	25.1	Pass
159	5795	18.26	17.37	17.64	16.49	224.206	23.51	25.1	Pass

NOTE: Directional gain = 10.9dBi > 6dBi, so the power limit shall be reduced to $30-(10.9-6) = 25.1$ dBm.

802.11ac (VHT80)

Chan.	Chan. Freq. (MHz)	Maximum Conducted Power (dBm)				Total Power (mW)	Total Power (dBm)	Limit (dBm)	Pass / Fail
		Chain 0	Chain 1	Chain 2	Chain 3				
42	5210	12.63	12.37	12.80	13.13	75.195	18.76	25.1	Pass
155	5775	18.42	17.78	17.54	16.63	232.261	23.66	25.1	Pass

NOTE: Directional gain = 10.9dBi > 6dBi, so the power limit shall be reduced to $30-(10.9-6) = 25.1$ dBm.

802.11ac (VHT80+80)

Chan.	Chan. Freq. (MHz)	Maximum Conducted Power (dBm)				Total Power (mW)	Total Power (dBm)	Limit (dBm)	Pass / Fail
		Chain 0	Chain 1	Chain 2	Chain 3				
42+155	5210	17.70	17.44			114.347	20.58	27.99	Pass
	5775			17.81	17.41	115.476	20.62	27.99	Pass

NOTE: Directional gain = 5dBi + $10\log(2) = 8.01$ dBi > 6dBi, so the power limit shall be reduced to $30-(8.01-6) = 27.99$ dBm.

4.4 Occupied Bandwidth Measurement

4.4.1 Test Setup



4.4.2 Test Instruments

Refer to section 4.1.2 to get information of above instrument.

4.4.3 Test Procedure

The transmitter output was connected to the spectrum analyzer through an attenuator. The bandwidth of the fundamental frequency was measured by spectrum analyzer with resolution bandwidth in the range of 1% to 5% of the anticipated emission bandwidth, and a video bandwidth at least 3x the resolution bandwidth and set the detector to SAMPLE. The width of a frequency band such that, below the lower and above the upper frequency limits, the mean powers emitted are each equal to a specified percentage 0.5 %of the total mean power of a given emission.

4.4.4 Test Results

802.11a

Channel	Channel Frequency (MHz)	Occupied Bandwidth (MHz)			
		Chain 0	Chain 1	Chain 2	Chain 3
36	5180	16.68	16.56	16.56	16.68
40	5200	16.44	16.68	16.80	16.68
48	5240	16.56	16.56	16.68	16.56
149	5745	17.16	16.80	17.04	16.80
157	5785	17.28	17.16	17.16	16.68
165	5825	17.16	17.40	17.28	16.80

802.11ac (VHT20)

Channel	Channel Frequency (MHz)	Occupied Bandwidth (MHz)			
		Chain 0	Chain 1	Chain 2	Chain 3
36	5180	17.64	17.76	17.88	17.64
40	5200	17.88	17.76	17.76	17.76
48	5240	17.64	17.76	17.64	17.76
149	5745	18.36	17.88	17.76	17.76
157	5785	18.36	18.00	18.12	17.88
165	5825	18.00	18.00	17.88	17.88

802.11ac (VHT40)

Channel	Channel Frequency (MHz)	Occupied Bandwidth (MHz)			
		Chain 0	Chain 1	Chain 2	Chain 3
38	5190	36.24	36.24	36.24	36.24
46	5230	36.72	36.48	36.72	36.48
151	5755	37.20	36.72	36.48	36.24
159	5795	36.96	36.72	36.96	36.48

802.11ac (VHT80)

Channel	Channel Frequency (MHz)	Occupied Bandwidth (MHz)			
		Chain 0	Chain 1	Chain 2	Chain 3
42	5210	75.84	76.32	75.36	75.84
155	5775	75.84	75.84	75.84	75.36

802.11ac (VHT80+80)

Channel	Channel Frequency (MHz)	Occupied Bandwidth (MHz)			
		Chain 0	Chain 1	Chain 2	Chain 3
42+155	5210	76.32	75.84	-	-
	5775	-	-	75.36	75.84

Spectrum Plot of Worst Value

802.11a / Chain 1 : CH165

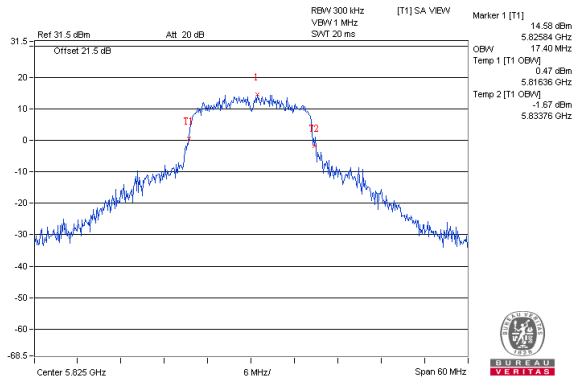

802.11ac (VHT20) / Chain 0 : CH149

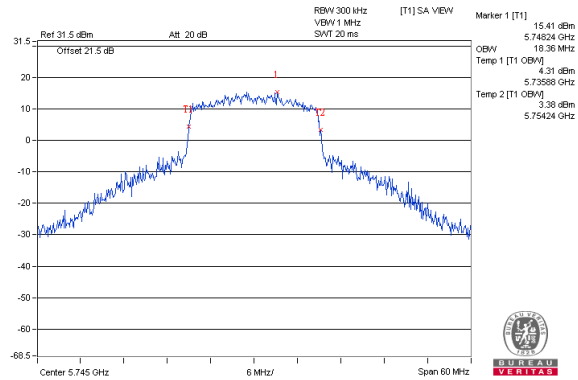

802.11ac (VHT40) / Chain 0: CH151

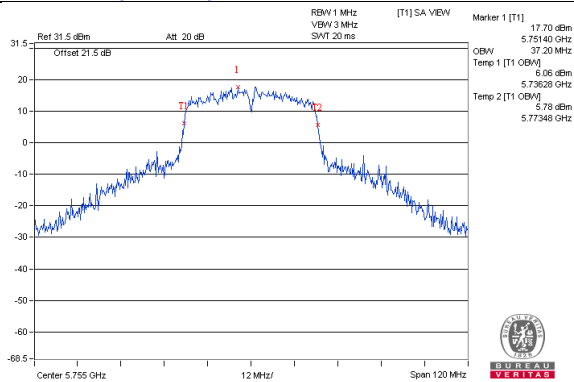

802.11ac (VHT80) / Chain 1 : CH42

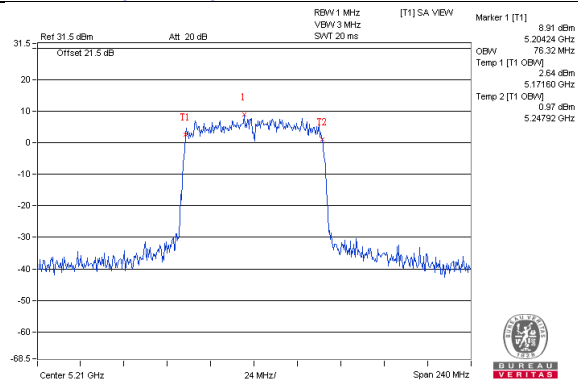

802.11ac (VHT80+80) / Chain 0: CH42

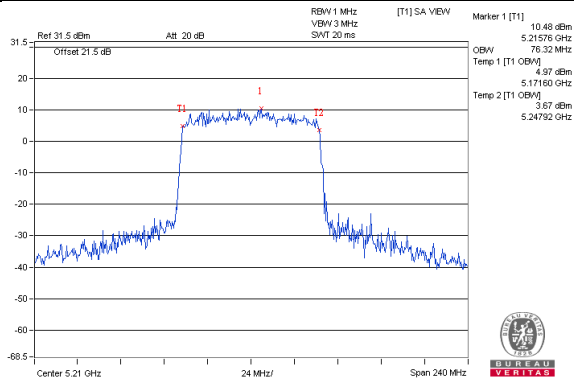

**Spectrum Plot for near by DFS band
(DFS is required, if 99% OCP straddle into U-NII-2A band)**

802.11a / Chain 0 : CH48

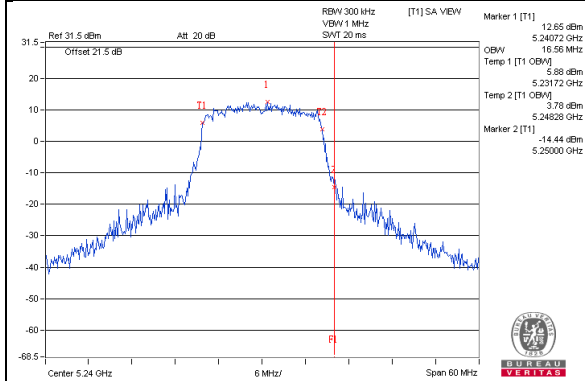

802.11a / Chain 1 : CH48

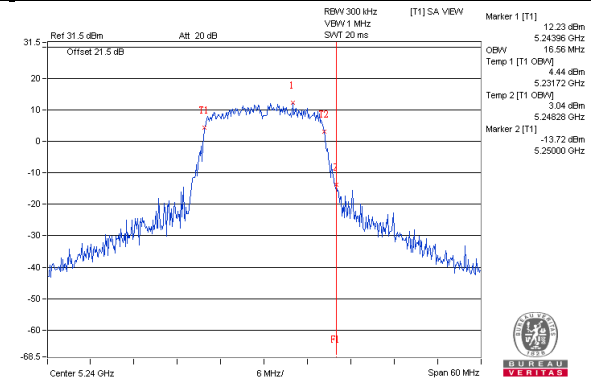

802.11a / Chain 2 : CH48

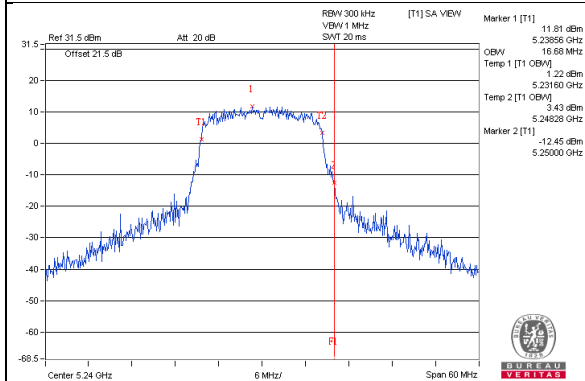

802.11a / Chain 3 : CH48

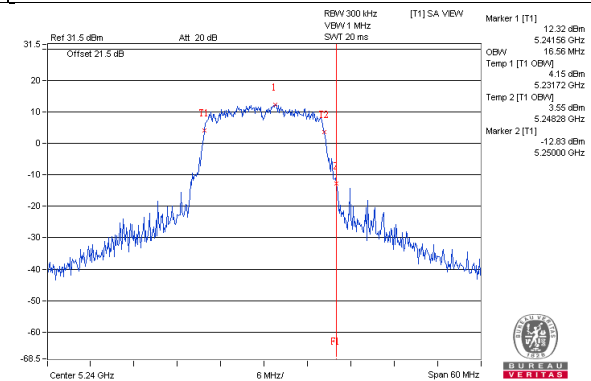

802.11ac (VHT20) / Chain 0 : CH48

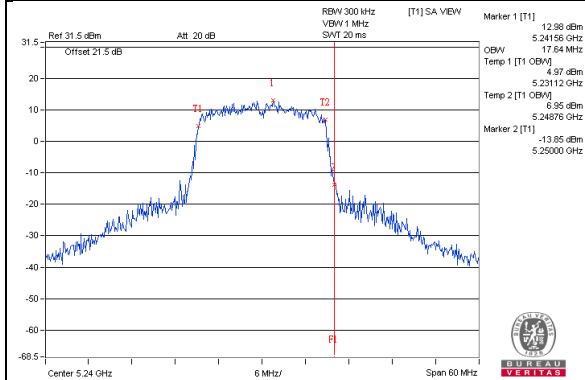

802.11ac (VHT20) / Chain 1 : CH48

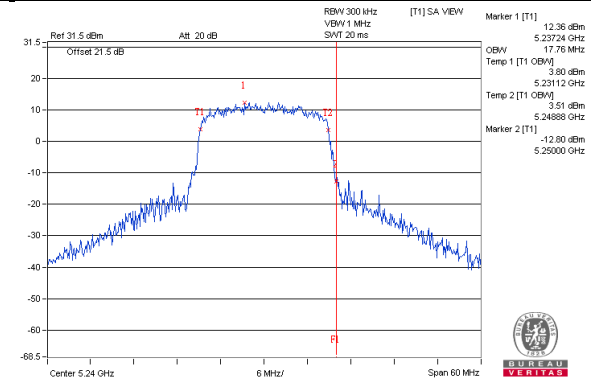

802.11ac (VHT20) / Chain 2 : CH48

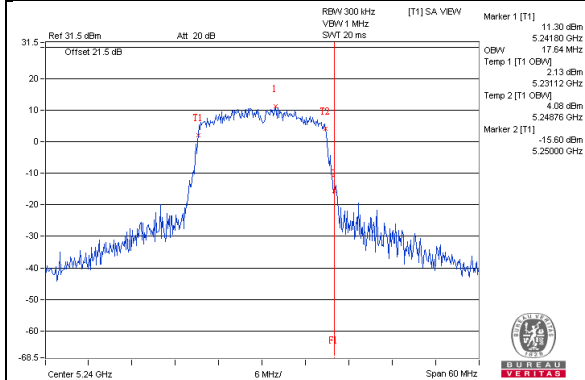

802.11ac (VHT20) / Chain 3 : CH48

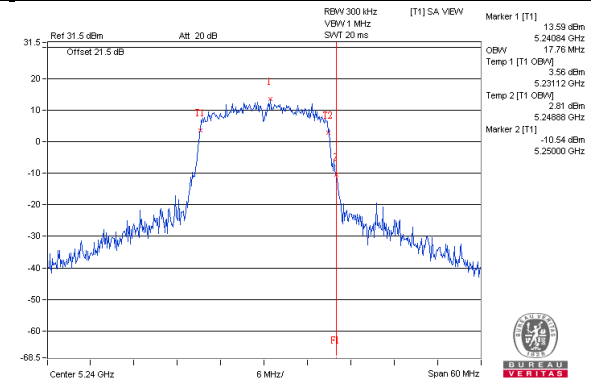

Spectrum Plot for near by DFS band (DFS is required, if 99% OCP straddle into U-NII-2A band)

802.11ac (VHT40) / Chain 0 : CH46

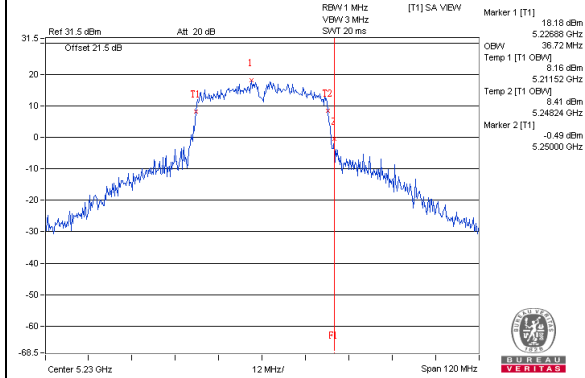

802.11ac (VHT40) / Chain 1 : CH46

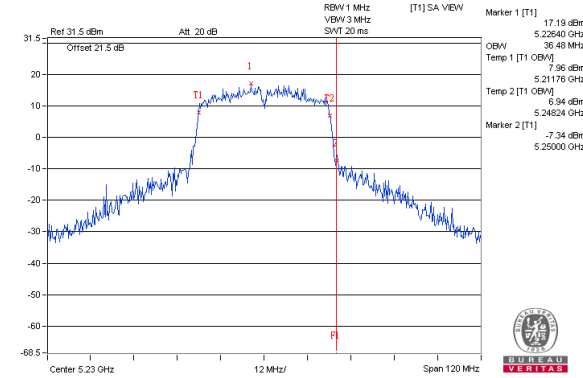

802.11ac (VHT40) / Chain 2 : CH46

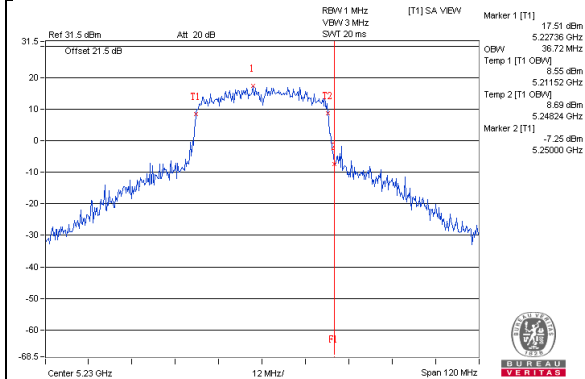

802.11ac (VHT40) / Chain 3 : CH46

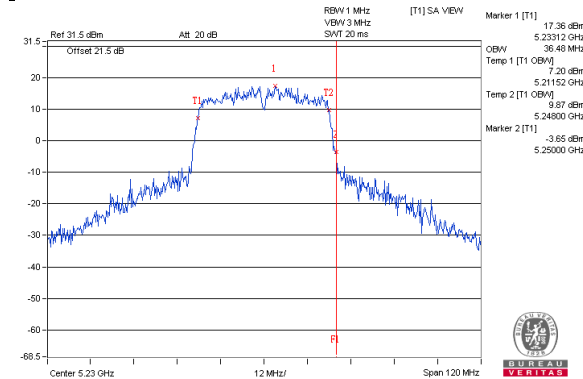

802.11ac (VHT80) / Chain 0 : CH42

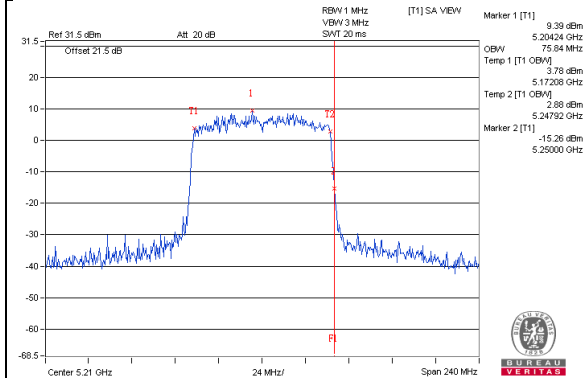

802.11ac (VHT80) / Chain 1 : CH42

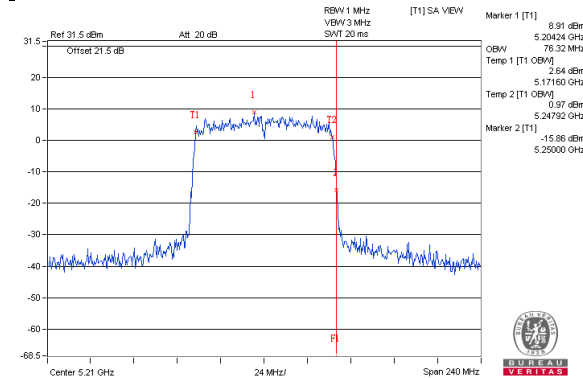

802.11ac (VHT80) / Chain 2 : CH42

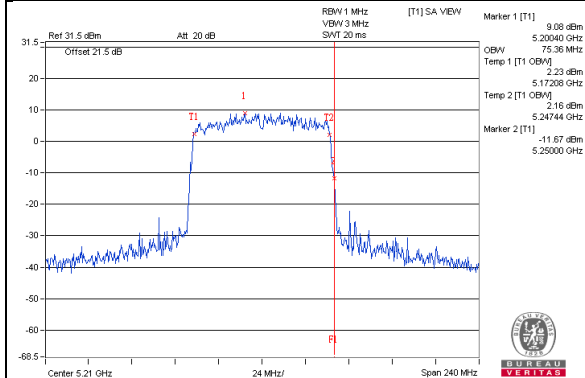

802.11ac (VHT80) / Chain 3 : CH42

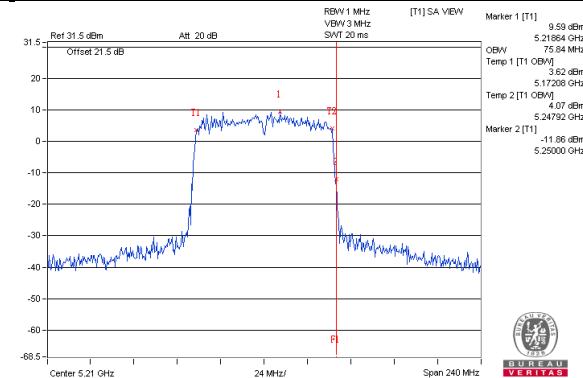

**Spectrum Plot for near by DFS band
(DFS is required, if 99% OCP straddle into U-NII-2A band)**

802.11ac(VHT80+80) / Chain 0 : CH42

802.11ac(VHT80+80) / Chain 1 : CH42

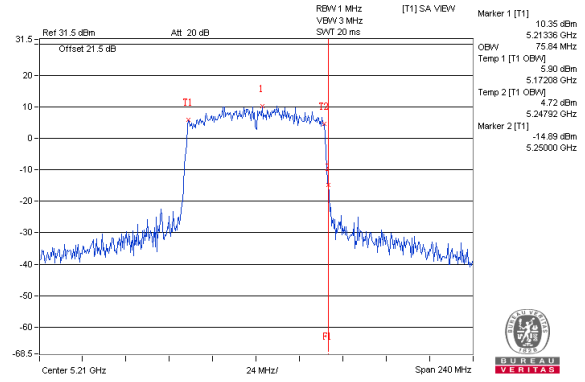
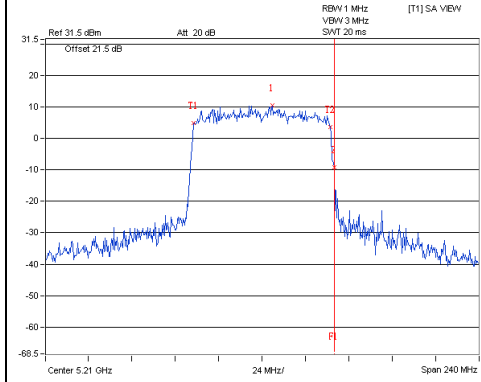

Spectrum Plot for near by DFS band (DFS is required, if 99% OCP straddle into U-NII-2C band)

802.11a / Chain 0 : CH149

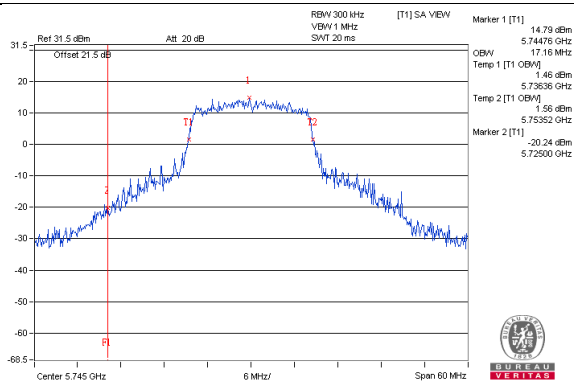

802.11a / Chain 1 : CH149

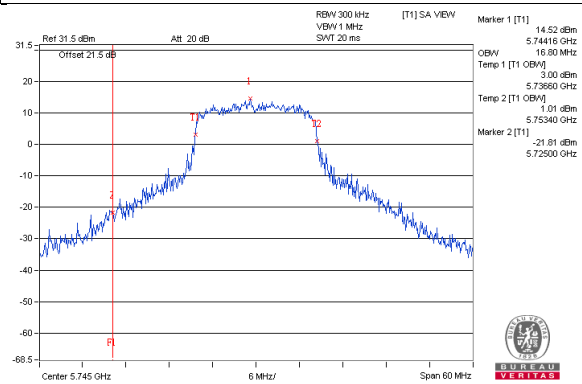

802.11a / Chain 2 : CH149

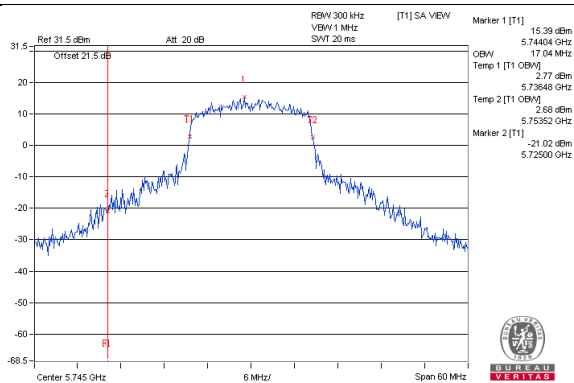

802.11a / Chain 3 : CH149

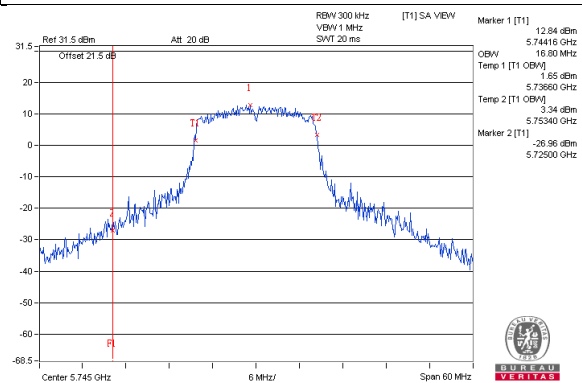

802.11ac (VHT20) / Chain 0 : CH149

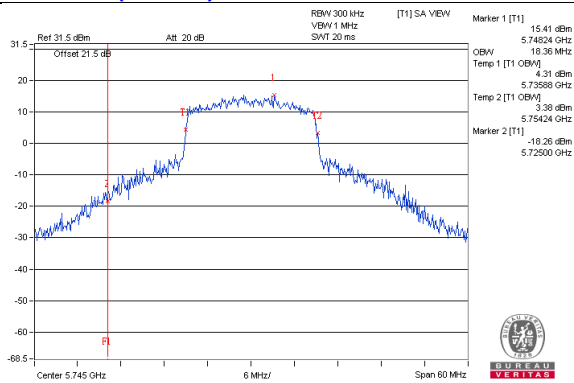

802.11ac (VHT20) / Chain 1 : CH149

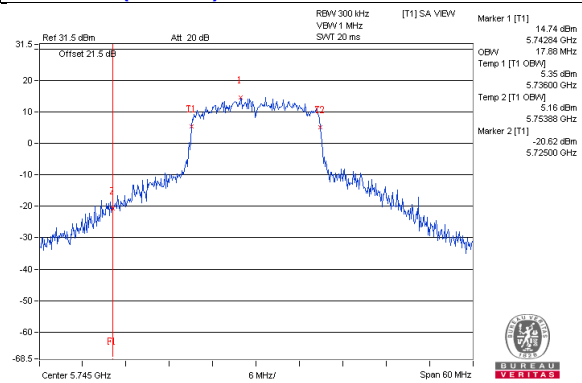

802.11ac (VHT20) / Chain 2 : CH149

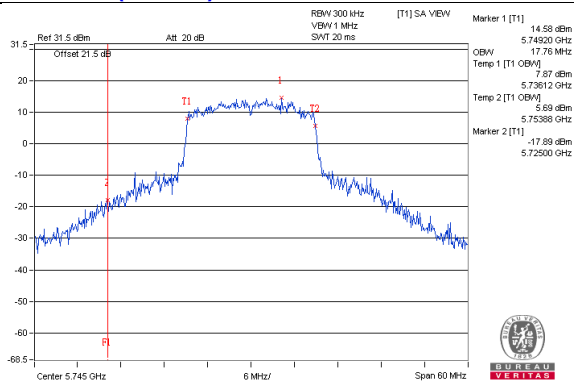

802.11ac (VHT20) / Chain 3 : CH149

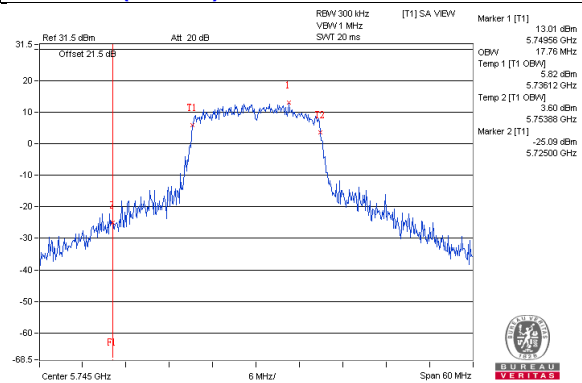

**Spectrum Plot for near by DFS band
(DFS is required, if 99% OCP straddle into U-NII-2C band)**

802.11ac (VHT40) / Chain 0 : CH151

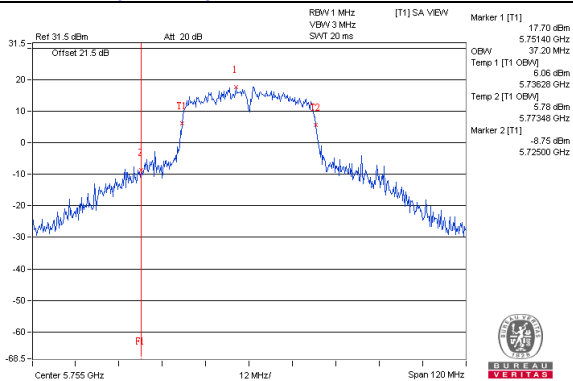

802.11ac (VHT40) / Chain 1 : CH151

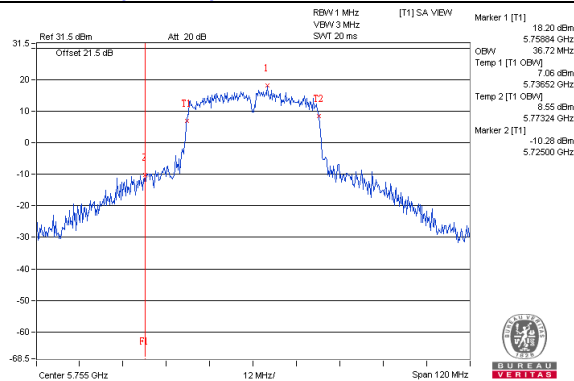

802.11ac (VHT40) / Chain 2 : CH151

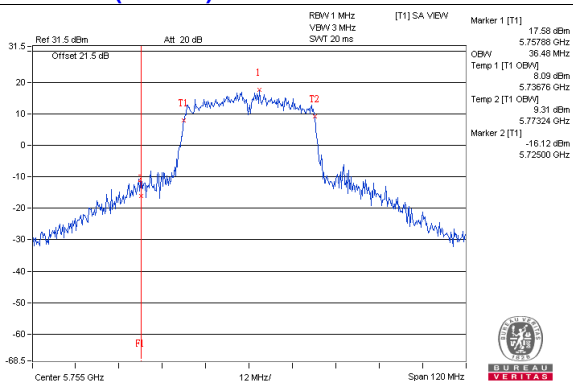

802.11ac (VHT40) / Chain 3 : CH151

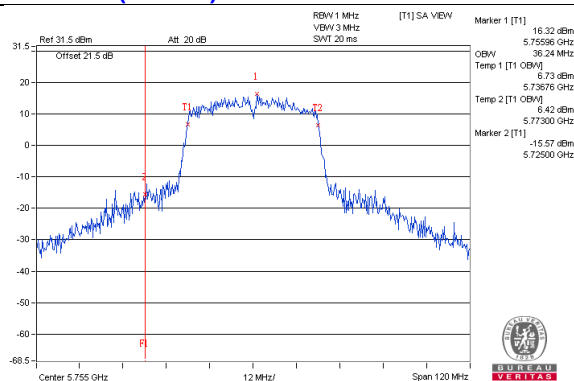

802.11ac (VHT80) / Chain 0 : CH155

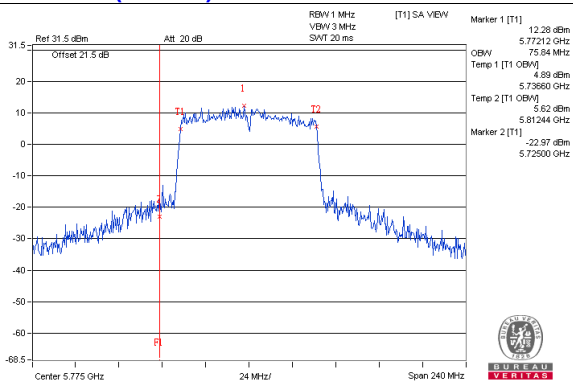

802.11ac (VHT80) / Chain 1 : CH155

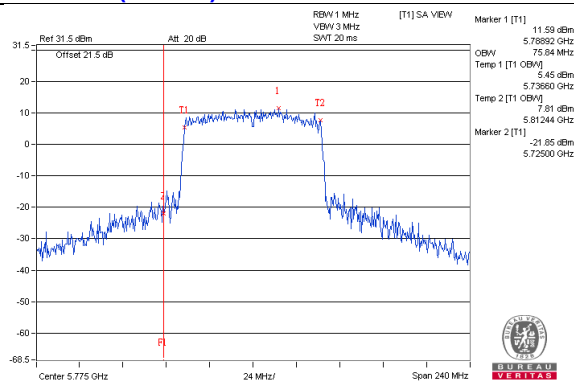

802.11ac (VHT80) / Chain 2 : CH155

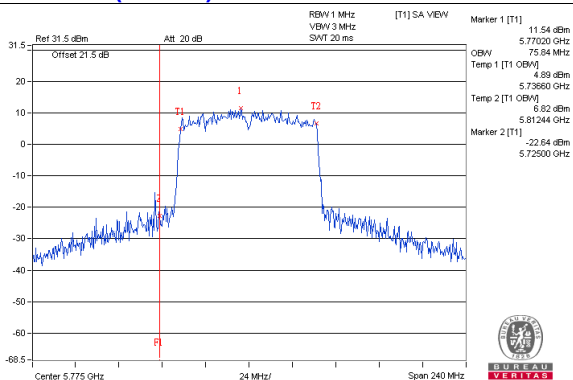

802.11ac (VHT80) / Chain 3 : CH155

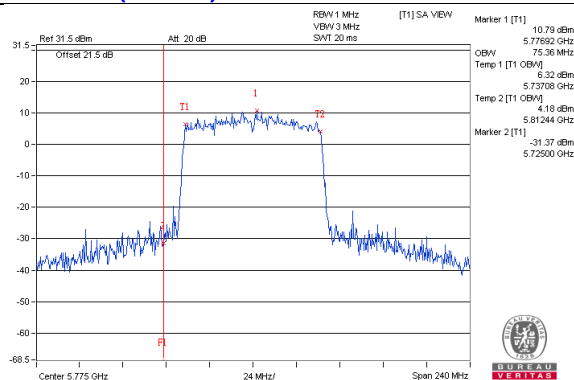

**Spectrum Plot for near by DFS band
(DFS is required, if 99% OCP straddle into U-NII-2C band)**

802.11ac (VHT80+80) / Chain 2 : CH155

802.11ac (VHT80+80) / Chain 3 : CH155

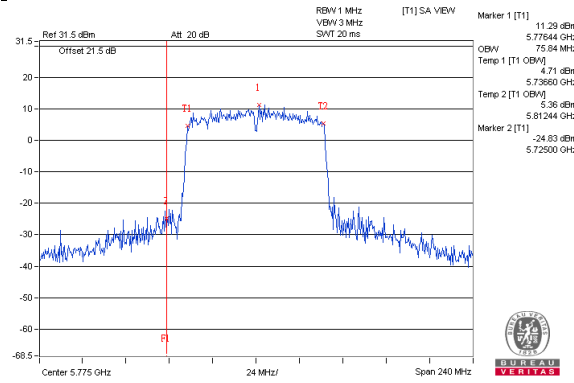
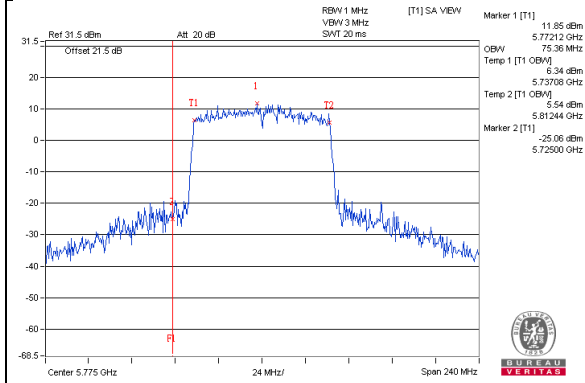

4.5 Peak Power Spectral Density Measurement

4.5.1 Limits of Peak Power Spectral Density Measurement

Operation Band	EUT Category		Limit
U-NII-1		Outdoor Access Point	17dBm/ MHz
		Fixed point-to-point Access Point	
	√	Indoor Access Point	
		Mobile and Portable client device	11dBm/ MHz
U-NII-2A	---		11dBm/ MHz
U-NII-2C	---		11dBm/ MHz
U-NII-3	√		30dBm/ 500kHz

4.5.2 Test Setup

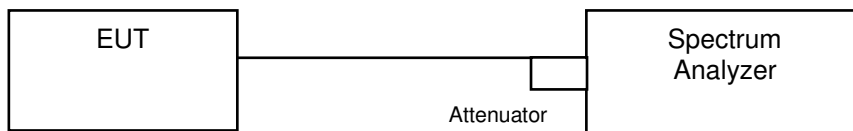

4.5.3 Test Instruments

Refer to section 4.1.2 to get information of above instrument.

4.5.4 Test Procedure

For U-NII-1 band:

Using method SA-1

1. Set span to encompass the entire emission bandwidth (EBW) of the signal.
2. Set RBW = 1 MHz, Set VBW ≥ 3 MHz, Detector = RMS
3. Sweep time = auto, trigger set to "free run".
4. Trace average at least 100 traces in power averaging mode.
5. Record the max value

For U-NII-3:

1. Set span to encompass the entire emission bandwidth (EBW) of the signal.
2. Set RBW = 300 kHz, Set VBW ≥ 1 MHz, Detector = RMS
3. Use the peak marker function to determine the maximum power level in any 300 kHz band segment within the fundamental EBW.
4. Scale the observed power level to an equivalent value in 500 kHz by adjusting (reducing) the measured power by a bandwidth correction factor (BWCF) where $BWCF = 10\log(500\text{ kHz}/300\text{ kHz})$
5. Sweep time = auto, trigger set to "free run".
6. Trace average at least 100 traces in power averaging mode.
7. Record the max value

4.5.5 Deviation from Test Standard

No deviation.

4.5.6 EUT Operating Condition

Same as Item 4.3.6.

4.5.7 Test Results (Mode 1)

For U-NII-1:

CDD Mode

802.11a

Chan.	Chan. Freq. (MHz)	PSD (dBm/MHz)				Total Power Density (dBm/MHz)	MAX. Limit (dBm/MHz)	Pass / Fail
		Chain 0	Chain 1	Chain 2	Chain 3			
36	5180	9.09	8.44	8.16	9.00	14.71	15.25	Pass
40	5200	9.58	8.78	8.57	9.69	15.20	15.25	Pass
48	5240	9.34	8.67	8.46	9.42	15.01	15.25	Pass

- Note:** 1. Method a) of power density measurement of KDB 662911 is using for calculating total power density. Total power density is summing entire spectra across corresponding frequency bins on the various outputs by computer.
2. Directional gain = 7.75dBi > 6dBi, so the power density limit shall be reduced to $17-(7.75-6) = 15.25$ dBm.

802.11ac (VHT20)

Chan.	Chan. Freq. (MHz)	PSD (dBm/MHz)				Total Power Density (dBm/MHz)	MAX. Limit (dBm/MHz)	Pass / Fail
		Chain 0	Chain 1	Chain 2	Chain 3			
36	5180	9.22	8.85	8.88	9.02	15.02	15.25	Pass
40	5200	9.18	9.05	7.41	9.22	14.80	15.25	Pass
48	5240	9.21	9.22	7.39	9.29	14.87	15.25	Pass

- Note:** 1. Method a) of power density measurement of KDB 662911 is using for calculating total power density. Total power density is summing entire spectra across corresponding frequency bins on the various outputs by computer.
2. Directional gain = 7.75dBi > 6dBi, so the power density limit shall be reduced to $17-(7.75-6) = 15.25$ dBm.

802.11ac (VHT40)

Chan.	Chan. Freq. (MHz)	PSD (dBm/MHz)				Total Power Density (dBm/MHz)	MAX. Limit (dBm/MHz)	Pass / Fail
		Chain 0	Chain 1	Chain 2	Chain 3			
38	5190	4.23	4.13	3.98	4.71	10.29	15.25	Pass
46	5230	8.64	7.40	8.24	7.99	14.11	15.25	Pass

- Note:** 1. Method a) of power density measurement of KDB 662911 is using for calculating total power density. Total power density is summing entire spectra across corresponding frequency bins on the various outputs by computer.
2. Directional gain = 7.75dBi > 6dBi, so the power density limit shall be reduced to $17-(7.75-6) = 15.25$ dBm.

802.11ac (VHT80)

Chan.	Chan. Freq. (MHz)	PSD (dBm/MHz)				Total Power Density (dBm/MHz)	MAX. Limit (dBm/MHz)	Pass / Fail
		Chain 0	Chain 1	Chain 2	Chain 3			
42	5210	-0.37	-0.82	-0.05	0.33	5.81	15.25	Pass

- Note:** 1. Method a) of power density measurement of KDB 662911 is using for calculating total power density. Total power density is summing entire spectra across corresponding frequency bins on the various outputs by computer.
2. Directional gain = 7.75dBi > 6dBi, so the power density limit shall be reduced to $17 - (7.75 - 6) = 15.25\text{dBm}$.

802.11ac (VHT80+80)

Chan.	Chan. Freq. (MHz)	PSD (dBm/MHz)				Total Power Density (dBm/MHz)	MAX. Limit (dBm/MHz)	Pass / Fail
		Chain 0	Chain 1	Chain 2	Chain 3			
42+ 155	5210	1.47	1.11	-	-	4.30	17	Pass
	5775	Test results refer to U_NII-3 data						

- Note:** 1. Method a) of power density measurement of KDB 662911 is using for calculating total power density. Total power density is summing entire spectra across corresponding frequency bins on the various outputs by computer.
2. Directional gain = $2\text{dBi} + 10\log(2) = 5.01\text{dBi} < 6\text{dBi}$, so the power density limit shall not be reduced.

Spectrum Plot of Worst Value

802.11a / Chain 3 : CH40

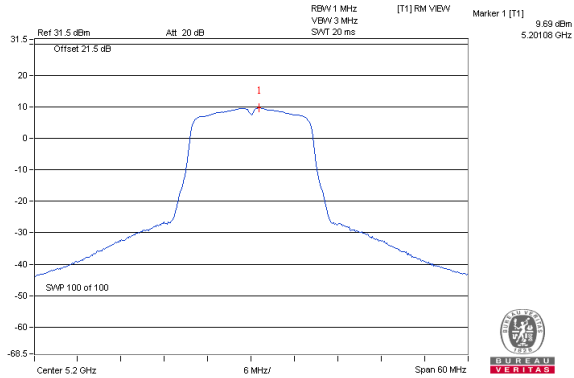

802.11ac (VHT20) / Chain 3 : CH48

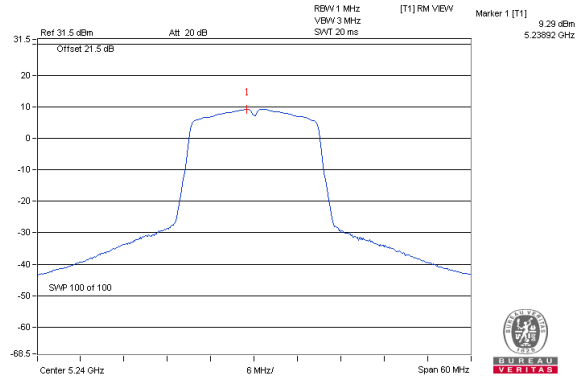

802.11ac (VHT40) / Chain 0: CH46

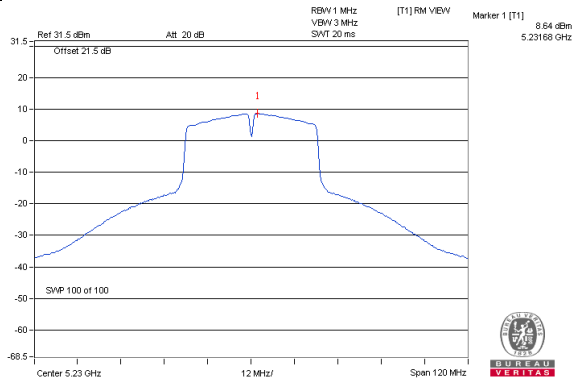

802.11ac (VHT80) / Chain 3 : CH42

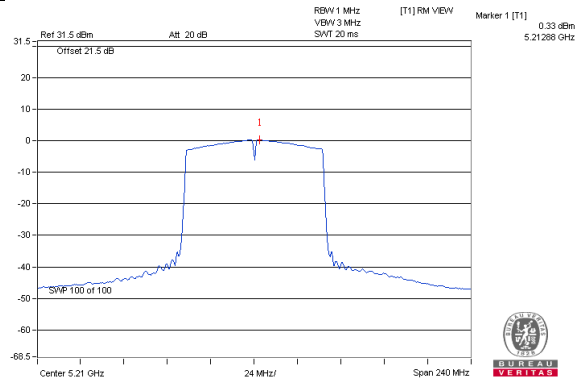

802.11ac (VHT80+80) / Chain 0: CH42

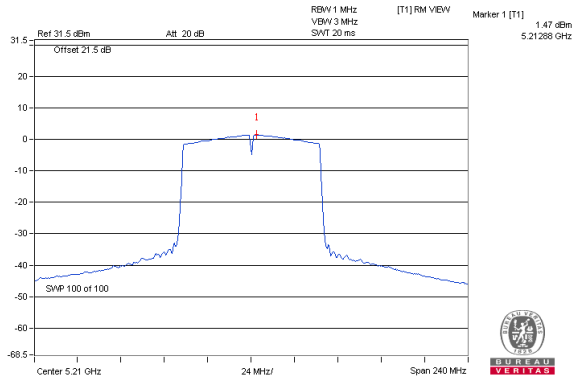

For U-NII-3:

802.11a

TX chain	Channel	Freq. (MHz)	PSD (dBm/300kHz)	PSD (dBm/500kHz)	10 log (N=4) dB	Total PSD (dBm/500kHz)	Limit (dBm/500kHz)	Pass /Fail
0	149	5745	3.39	5.61	6.02	11.63	28.25	Pass
	157	5785	3.88	6.10	6.02	12.12	28.25	Pass
	165	5825	3.23	5.45	6.02	11.47	28.25	Pass
1	149	5745	2.76	4.98	6.02	11.00	28.25	Pass
	157	5785	3.57	5.79	6.02	11.81	28.25	Pass
	165	5825	2.99	5.21	6.02	11.23	28.25	Pass
2	149	5745	3.25	5.47	6.02	11.49	28.25	Pass
	157	5785	3.31	5.53	6.02	11.55	28.25	Pass
	165	5825	3.04	5.26	6.02	11.28	28.25	Pass
3	149	5745	1.63	3.85	6.02	9.87	28.25	Pass
	157	5785	2.34	4.56	6.02	10.58	28.25	Pass
	165	5825	2.08	4.30	6.02	10.32	28.25	Pass

Note: 1. Directional gain = 7.75dBi > 6dBi, so the power density limit shall be reduced to $30 - (7.75 - 6) = 28.25$ dBm.

802.11ac (VHT20)

TX chain	Channel	Freq. (MHz)	PSD (dBm/300kHz)	PSD (dBm/500kHz)	10 log (N=4) dB	Total PSD (dBm/500kHz)	Limit (dBm/500kHz)	Pass /Fail
0	149	5745	4.04	6.26	6.02	12.28	28.25	Pass
	157	5785	3.55	5.77	6.02	11.79	28.25	Pass
	165	5825	2.89	5.11	6.02	11.13	28.25	Pass
1	149	5745	3.10	5.32	6.02	11.34	28.25	Pass
	157	5785	2.56	4.78	6.02	10.80	28.25	Pass
	165	5825	2.74	4.96	6.02	10.98	28.25	Pass
2	149	5745	2.98	5.20	6.02	11.22	28.25	Pass
	157	5785	3.21	5.43	6.02	11.45	28.25	Pass
	165	5825	2.82	5.04	6.02	11.06	28.25	Pass
3	149	5745	1.67	3.89	6.02	9.91	28.25	Pass
	157	5785	1.76	3.98	6.02	10.00	28.25	Pass
	165	5825	1.74	3.96	6.02	9.98	28.25	Pass

Note: 1. Directional gain = 7.75dBi > 6dBi, so the power density limit shall be reduced to $30-(7.75-6) = 28.25\text{dBm}$.

802.11ac (VHT40)

TX chain	Channel	Freq. (MHz)	PSD (dBm/300kHz)	PSD (dBm/500kHz)	10 log (N=4) dB	Total PSD (dBm/500kHz)	Limit (dBm/500kHz)	Pass /Fail
0	151	5755	-0.03	2.19	6.02	8.21	28.25	Pass
	159	5795	-0.06	2.16	6.02	8.18	28.25	Pass
1	151	5755	-0.68	1.54	6.02	7.56	28.25	Pass
	159	5795	-0.59	1.63	6.02	7.65	28.25	Pass
2	151	5755	-1.16	1.06	6.02	7.08	28.25	Pass
	159	5795	-0.24	1.98	6.02	8.00	28.25	Pass
3	151	5755	-2.22	0.00	6.02	6.02	28.25	Pass
	159	5795	-1.73	0.49	6.02	6.51	28.25	Pass

Note: 1. Directional gain = 7.75dBi > 6dBi, so the power density limit shall be reduced to $30-(7.75-6) = 28.25\text{dBm}$.

802.11ac (VHT80)

TX chain	Channel	Freq. (MHz)	PSD (dBm/300kHz)	PSD (dBm/500kHz)	10 log (N=4) dB	Total PSD (dBm/500kHz)	Limit (dBm/500kHz)	Pass /Fail
0	155	5775	-5.70	-3.48	6.02	2.54	28.25	Pass
1	155	5775	-5.98	-3.76	6.02	2.26	28.25	Pass
2	155	5775	-6.52	-4.30	6.02	1.72	28.25	Pass
3	155	5775	-7.47	-5.25	6.02	0.77	28.25	Pass

Note: 1. Directional gain = 7.75dBi > 6dBi, so the power density limit shall be reduced to $30 - (7.75 - 6) = 28.25$ dBm.

802.11ac (VHT80+80)

TX chain	Channel	Freq. (MHz)	PSD (dBm/300kHz)	PSD (dBm/500kHz)	10 log (N=2) dB	Total PSD (dBm/500kHz)	Limit (dBm/500kHz)	Pass /Fail
0	42	5210	Test results refer to U_NII-1 data					
1	42	5210	Test results refer to U_NII-1 data					
2	155	5775	-6.43	-4.21	3.01	-1.20	30.00	Pass
3	155	5775	-7.23	-5.01	3.01	-2.00	30.00	Pass

Note: 1. Directional gain = $2\text{dBi} + 10\log(2) = 5.01\text{dBi} < 6\text{dBi}$, so the power density limit shall not be reduced.

Spectrum Plot of Worst Value

802.11a / Chain 0 : CH157

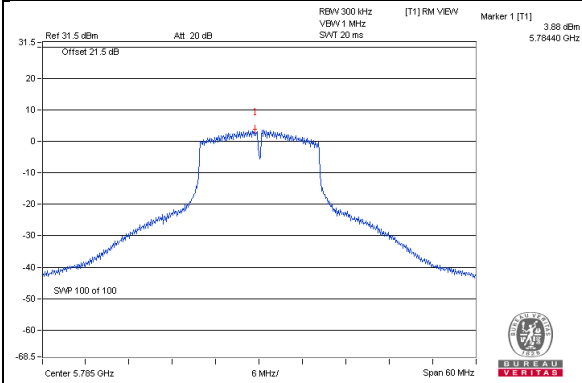

802.11ac (VHT20) / Chain 0 : CH149

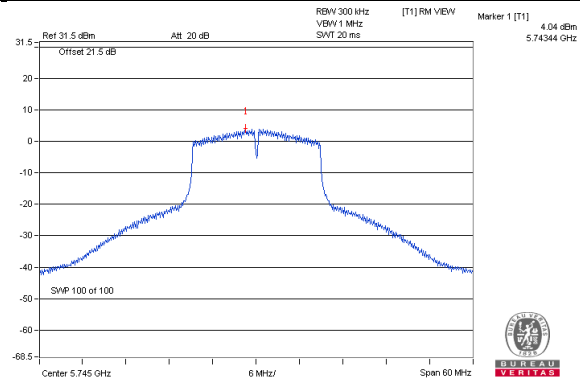

802.11ac (VHT40) / Chain 0 : CH151

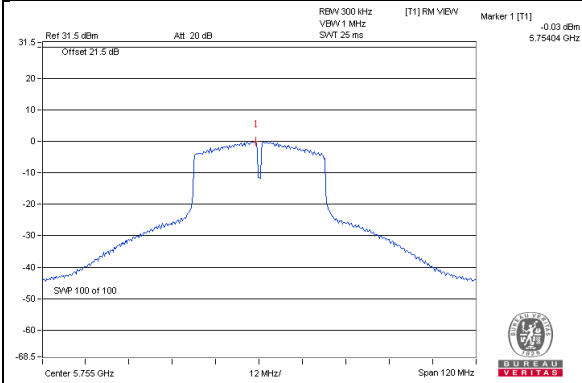

802.11ac (VHT80) / Chain 0 : CH155

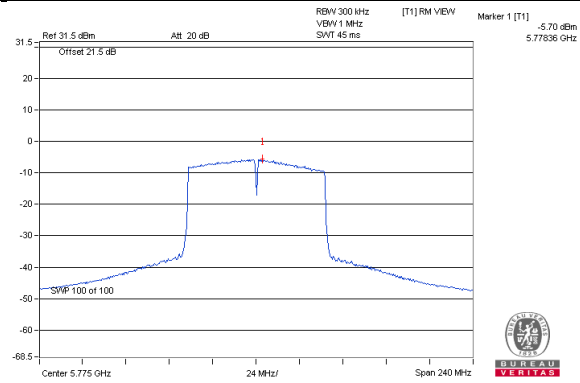

802.11ac (VHT80+80) / Chain 2 : CH155

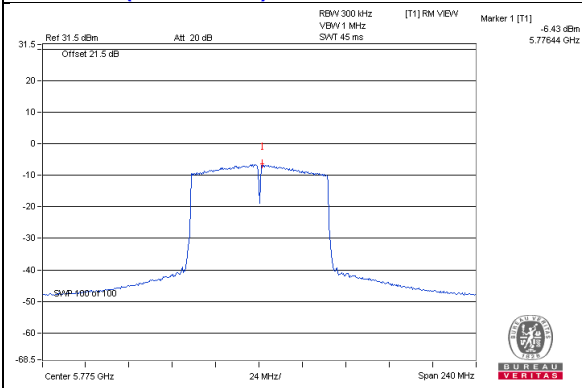

4.5.8 Test Results (Mode 2)

For U-NII-1:

CDD Mode

802.11a

Chan.	Chan. Freq. (MHz)	PSD (dBm/MHz)				Total Power Density (dBm/MHz)	MAX. Limit (dBm/MHz)	Pass / Fail
		Chain 0	Chain 1	Chain 2	Chain 3			
36	5180	5.94	6.05	5.82	6.43	12.09	12.10	Pass
40	5200	5.73	6.01	5.89	6.45	12.05	12.10	Pass
48	5240	5.95	5.93	6.01	6.17	12.04	12.10	Pass

- Note:** 1. Method a) of power density measurement of KDB 662911 is using for calculating total power density. Total power density is summing entire spectra across corresponding frequency bins on the various outputs by computer.
2. Directional gain = 10.9dBi > 6dBi, so the power density limit shall be reduced to $17-(10.9-6) = 12.10\text{dBm}$.

802.11ac (VHT20)

Chan.	Chan. Freq. (MHz)	PSD (dBm/MHz)				Total Power Density (dBm/MHz)	MAX. Limit (dBm/MHz)	Pass / Fail
		Chain 0	Chain 1	Chain 2	Chain 3			
36	5180	4.25	4.14	5.07	5.35	10.75	12.10	Pass
40	5200	5.28	5.25	5.28	5.41	11.33	12.10	Pass
48	5240	5.21	4.91	5.36	5.65	11.31	12.10	Pass

- Note:** 1. Method a) of power density measurement of KDB 662911 is using for calculating total power density. Total power density is summing entire spectra across corresponding frequency bins on the various outputs by computer.
2. Directional gain = 10.9dBi > 6dBi, so the power density limit shall be reduced to $17-(10.9-6) = 12.10\text{dBm}$.

802.11ac (VHT40)

Chan.	Chan. Freq. (MHz)	PSD (dBm/MHz)				Total Power Density (dBm/MHz)	MAX. Limit (dBm/MHz)	Pass / Fail
		Chain 0	Chain 1	Chain 2	Chain 3			
38	5190	0.66	0.25	0.75	1.79	6.92	12.10	Pass
46	5230	2.43	2.44	3.09	3.65	8.95	12.10	Pass

- Note:** 1. Method a) of power density measurement of KDB 662911 is using for calculating total power density. Total power density is summing entire spectra across corresponding frequency bins on the various outputs by computer.
2. Directional gain = 10.9dBi > 6dBi, so the power density limit shall be reduced to $17-(10.9-6) = 12.10\text{dBm}$.

802.11ac (VHT80)

Chan.	Chan. Freq. (MHz)	PSD (dBm/MHz)				Total Power Density (dBm/MHz)	MAX. Limit (dBm/MHz)	Pass / Fail
		Chain 0	Chain 1	Chain 2	Chain 3			
42	5210	-6.68	-7.04	-6.79	-6.16	-0.63	12.10	Pass

- Note:** 1. Method a) of power density measurement of KDB 662911 is using for calculating total power density. Total power density is summing entire spectra across corresponding frequency bins on the various outputs by computer.
2. Directional gain = 10.9dBi > 6dBi, so the power density limit shall be reduced to $17-(10.9-6) = 12.10\text{dBm}$.

802.11ac (VHT80+80)

Chan.	Chan. Freq. (MHz)	PSD (dBm/MHz)				Total Power Density (dBm/MHz)	MAX. Limit (dBm/MHz)	Pass / Fail
		Chain 0	Chain 1	Chain 2	Chain 3			
42+155	5210	-1.67	-1.74	-	-	1.31	14.99	Pass
	5775	Test results refer to U_NII-3 data						

- Note:** 1. Method a) of power density measurement of KDB 662911 is using for calculating total power density. Total power density is summing entire spectra across corresponding frequency bins on the various outputs by computer.
2. Directional gain = 2dBi + $10\log(2) = 8.01\text{dBi}$ > 6dBi, so the power density limit shall be reduced to $17-(8.01-6) = 14.99\text{dBm}$.

Spectrum Plot of Worst Value

802.11a / Chain 3 : CH40

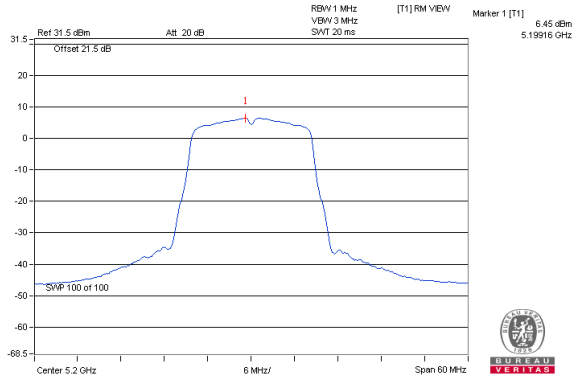

802.11ac (VHT20) / Chain 3 : CH48

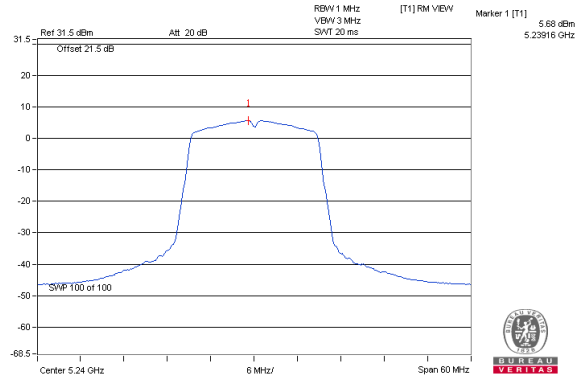

802.11ac (VHT40) / Chain 3 : CH46

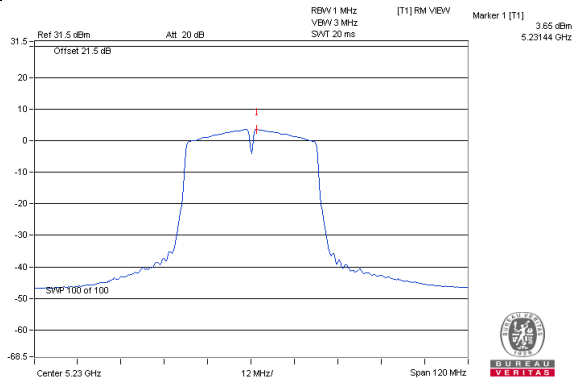

802.11ac (VHT80) / Chain 3 : CH42

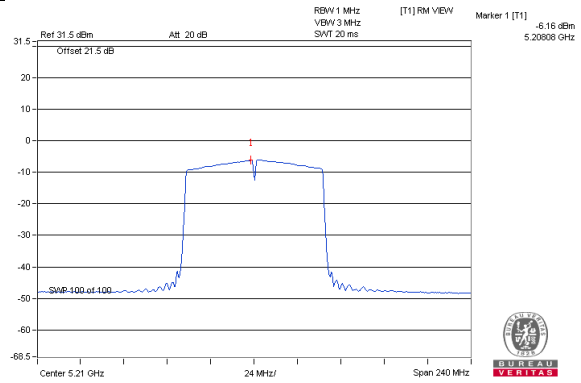

802.11ac (VHT80+80) / Chain 0 : CH42

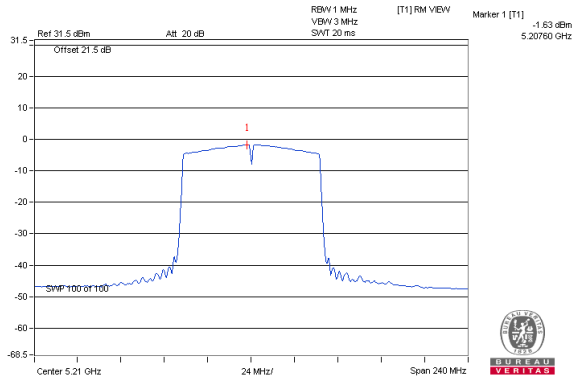

For U-NII-3:

802.11a

TX chain	Channel	Freq. (MHz)	PSD (dBm/300kHz)	PSD (dBm/500kHz)	10 log (N=4) dB	Total PSD (dBm/500kHz)	Limit (dBm/500kHz)	Pass /Fail
0	149	5745	1.83	4.05	6.02	10.07	25.10	Pass
	157	5785	2.34	4.56	6.02	10.58	25.10	Pass
	165	5825	0.96	3.18	6.02	9.20	25.10	Pass
1	149	5745	0.93	3.15	6.02	9.17	25.10	Pass
	157	5785	1.37	3.59	6.02	9.61	25.10	Pass
	165	5825	1.19	3.41	6.02	9.43	25.10	Pass
2	149	5745	0.48	2.70	6.02	8.72	25.10	Pass
	157	5785	1.79	4.01	6.02	10.03	25.10	Pass
	165	5825	2.45	4.67	6.02	10.69	25.10	Pass
3	149	5745	-0.56	1.66	6.02	7.68	25.10	Pass
	157	5785	-0.81	1.41	6.02	7.43	25.10	Pass
	165	5825	-0.32	1.90	6.02	7.92	25.10	Pass

Note: 1. Directional gain = 10.9dBi > 6dBi, so the power density limit shall be reduced to $30 - (10.9 - 6) = 25.10$ dBm.

802.11ac (VHT20)

TX chain	Channel	Freq. (MHz)	PSD (dBm/300kHz)	PSD (dBm/500kHz)	10 log (N=4) dB	Total PSD (dBm/500kHz)	Limit (dBm/500kHz)	Pass /Fail
0	149	5745	1.41	3.63	6.02	9.65	25.10	Pass
	157	5785	1.96	4.18	6.02	10.20	25.10	Pass
	165	5825	1.23	3.45	6.02	9.47	25.10	Pass
1	149	5745	0.09	2.31	6.02	8.33	25.10	Pass
	157	5785	0.82	3.04	6.02	9.06	25.10	Pass
	165	5825	0.74	2.96	6.02	8.98	25.10	Pass
2	149	5745	0.50	2.72	6.02	8.74	25.10	Pass
	157	5785	0.70	2.92	6.02	8.94	25.10	Pass
	165	5825	0.75	2.97	6.02	8.99	25.10	Pass
3	149	5745	-1.86	0.36	6.02	6.38	25.10	Pass
	157	5785	-0.73	1.49	6.02	7.51	25.10	Pass
	165	5825	0.03	2.25	6.02	8.27	25.10	Pass

Note: 1. Directional gain = 10.9dBi > 6dBi, so the power density limit shall be reduced to $30-(10.9-6) = 25.10\text{dBm}$.

802.11ac (VHT40)

TX chain	Channel	Freq. (MHz)	PSD (dBm/300kHz)	PSD (dBm/500kHz)	10 log (N=4) dB	Total PSD (dBm/500kHz)	Limit (dBm/500kHz)	Pass /Fail
0	151	5755	-3.03	-0.81	6.02	5.21	25.10	Pass
	159	5795	-2.58	-0.36	6.02	5.66	25.10	Pass
1	151	5755	-3.66	-1.44	6.02	4.58	25.10	Pass
	159	5795	-3.55	-1.33	6.02	4.69	25.10	Pass
2	151	5755	-3.24	-1.02	6.02	5.00	25.10	Pass
	159	5795	-3.17	-0.95	6.02	5.07	25.10	Pass
3	151	5755	-5.05	-2.83	6.02	3.19	25.10	Pass
	159	5795	-5.34	-3.12	6.02	2.90	25.10	Pass

Note: 1. Directional gain = 10.9dBi > 6dBi, so the power density limit shall be reduced to $30-(10.9-6) = 25.10\text{dBm}$.

802.11ac (VHT80)

TX chain	Channel	Freq. (MHz)	PSD (dBm/300kHz)	PSD (dBm/500kHz)	10 log (N=4) dB	Total PSD (dBm/500kHz)	Limit (dBm/500kHz)	Pass /Fail
0	155	5775	-9.88	-7.66	6.02	-1.64	25.10	Pass
1	155	5775	-10.32	-8.10	6.02	-2.08	25.10	Pass
2	155	5775	-10.83	-8.61	6.02	-2.59	25.10	Pass
3	155	5775	-11.48	-9.26	6.02	-3.24	25.10	Pass

Note: 1. Directional gain = 10.9dBi > 6dBi, so the power density limit shall be reduced to $30 - (10.9 - 6) = 25.10$ dBm.

802.11ac (VHT80+80)

TX chain	Channel	Freq. (MHz)	PSD (dBm/300kHz)	PSD (dBm/500kHz)	10 log (N=2) dB	Total PSD (dBm/500kHz)	Limit (dBm/500kHz)	Pass /Fail
0	42	5210	Test results refer to U_NII-1 data					
1	42	5210	Test results refer to U_NII-1 data					
2	155	5775	-10.38	-8.16	3.01	-5.15	27.99	Pass
3	155	5775	-10.39	-8.17	3.01	-5.16	27.99	Pass

Note: 1. Directional gain = 5dBi + $10 \log(2) = 8.01$ dBi > 6dBi, so the power density limit shall be reduced to $30 - (8.01 - 6) = 27.99$ dBm.

Spectrum Plot of Worst Value

802.11a / Chain 2 : CH165

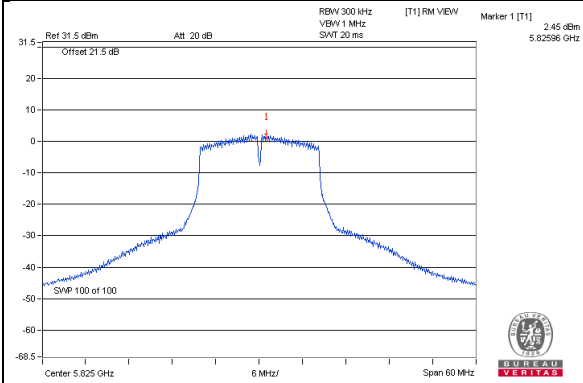

802.11ac (VHT20) / Chain 0 : CH157

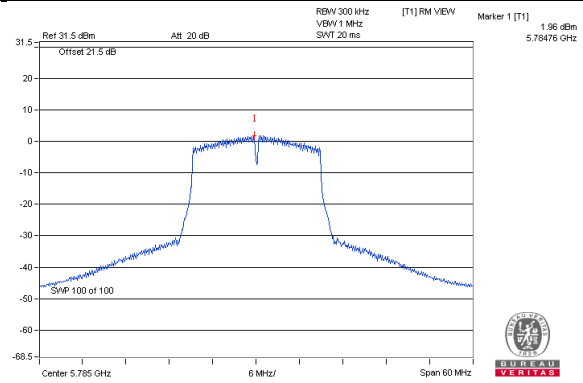

802.11ac (VHT40) / Chain 0: CH159

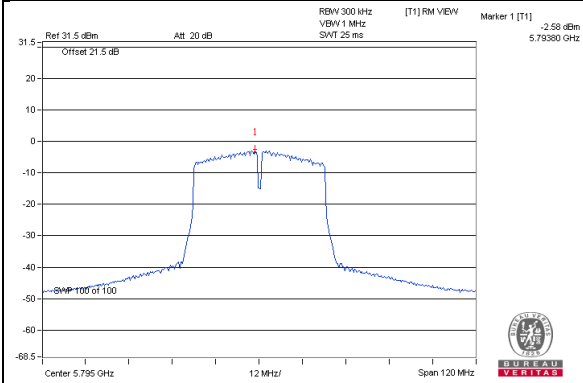

802.11ac (VHT80) / Chain 0 : CH155

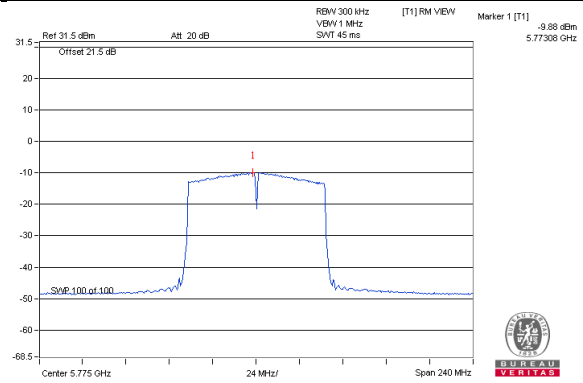

802.11ac (VHT80+80) / Chain 2: CH155

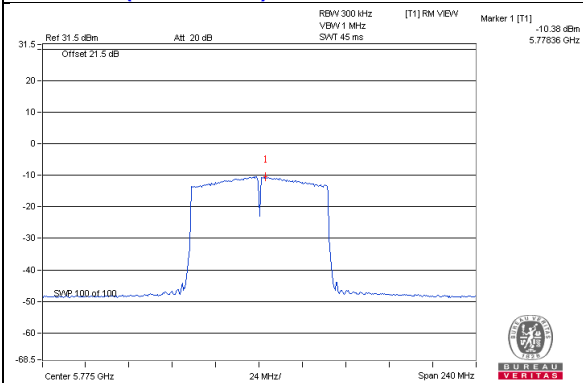

4.6 Frequency Stability Measurement

4.6.1 Limits of Frequency Stability Measurement

The frequency of the carrier signal shall be maintained within band of operation

4.6.2 Test Setup

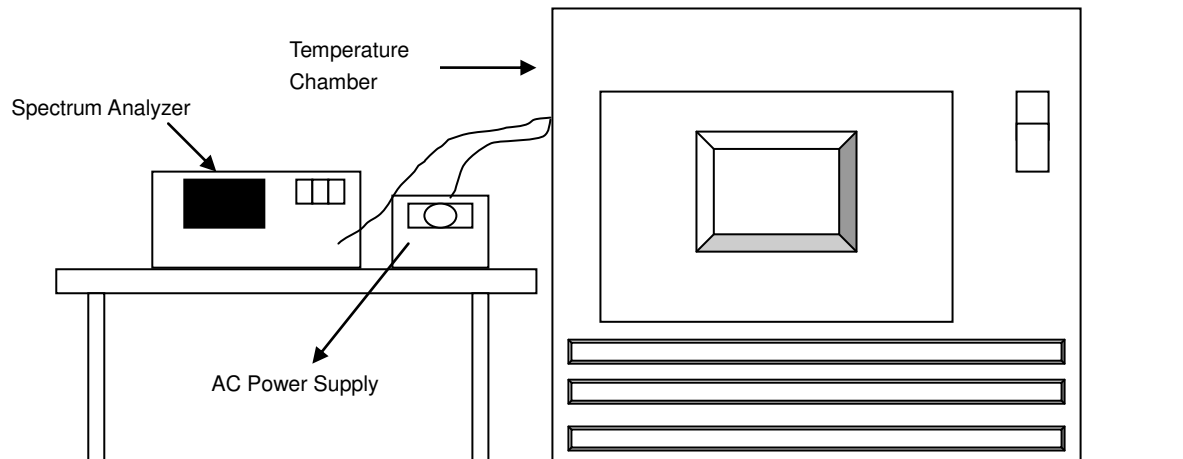

4.6.3 Test Instruments

Refer to section 4.1.2 to get information of above instrument.

4.6.4 Test Procedure

- The EUT was placed inside the environmental test chamber and powered by nominal AC voltage.
- Turn the EUT on and couple its output to a spectrum analyzer.
- Turn the EUT off and set the chamber to the highest temperature specified.
- Allow sufficient time (approximately 30 min) for the temperature of the chamber to stabilize, turn the EUT on and measure the operating frequency after 2, 5, and 10 Minutes.
- Repeat step 2 and 3 with the temperature chamber set to the lowest temperature.
- The test chamber was allowed to stabilize at +20 degree C for a minimum of 30 Minutes. The supply voltage was then adjusted on the EUT from 85% to 115% and the frequency record.

4.6.5 Deviation from Test Standard

No deviation.

4.6.6 EUT Operating Condition

Set the EUT transmit at un-modulation mode to test frequency stability.

4.6.7 Test Results

Frequency Stability Versus Temp.									
Operating Frequency: 5180 MHz									
TEMP. (°C)	Power Supply (Vac)	0 Minute		2 Minute		5 Minute		10 Minute	
		Measured Frequency (MHz)	Pass/Fail	Measured Frequency (MHz)	Pass/Fail	Measured Frequency (MHz)	Pass/Fail	Measured Frequency (MHz)	Pass/Fail
50	120	5179.9949	Pass	5179.9937	Pass	5179.9946	Pass	5179.9932	Pass
40	120	5180.0216	Pass	5180.0259	Pass	5180.0255	Pass	5180.0249	Pass
30	120	5179.9841	Pass	5179.9834	Pass	5179.9849	Pass	5179.9831	Pass
20	120	5180.0033	Pass	5180.0042	Pass	5180.0045	Pass	5180.0021	Pass
10	120	5179.9772	Pass	5179.9782	Pass	5179.9752	Pass	5179.9772	Pass
0	120	5180.0074	Pass	5180.0083	Pass	5180.0046	Pass	5180.0077	Pass
-10	120	5180.0125	Pass	5180.0153	Pass	5180.0139	Pass	5180.0141	Pass
-20	120	5179.9824	Pass	5179.978	Pass	5179.9819	Pass	5179.9791	Pass
-30	120	5179.9935	Pass	5179.9971	Pass	5179.9966	Pass	5179.9966	Pass

Frequency Stability Versus Voltage									
Operating Frequency: 5180 MHz									
TEMP. (°C)	Power Supply (Vac)	0 Minute		2 Minute		5 Minute		10 Minute	
		Measured Frequency (MHz)	Pass/Fail	Measured Frequency (MHz)	Pass/Fail	Measured Frequency (MHz)	Pass/Fail	Measured Frequency (MHz)	Pass/Fail
20	138	5180.0032	Pass	5180.0039	Pass	5180.0054	Pass	5180.0027	Pass
	120	5180.0033	Pass	5180.0042	Pass	5180.0045	Pass	5180.0021	Pass
	102	5180.0036	Pass	5180.0052	Pass	5180.005	Pass	5180.003	Pass

4.7 6dB Bandwidth Measurement

4.7.1 Limits of 6dB Bandwidth Measurement

The minimum of 6dB Bandwidth Measurement is 0.5MHz.

4.7.2 Test Setup

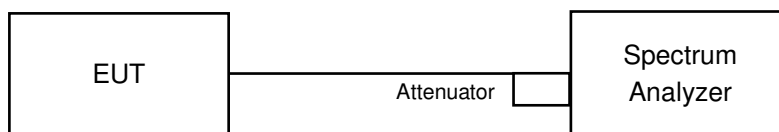

4.7.3 Test Instruments

Refer to section 4.1.2 to get information of above instrument.

4.7.4 Test Procedure

MEASUREMENT PROCEDURE REF

- Set resolution bandwidth (RBW) = 100kHz
- Set the video bandwidth (VBW) $\geq 3 \times$ RBW, Detector = Peak.
- Trace mode = max hold.
- Sweep = auto couple.
- Measure the maximum width of the emission that is constrained by the frequencies associated with the two amplitude points (upper and lower) that are attenuated by 6 dB relative to the maximum level measured in the fundamental emission

4.7.5 Deviation from Test Standard

No deviation.

4.7.6 EUT Operating Condition

The software provided by client to enable the EUT under transmission condition continuously at lowest, middle and highest channel frequencies individually.

4.7.7 Test Results

802.11a

Channel	Frequency (MHz)	6dB Bandwidth (MHz)				Minimum Limit (MHz)	Pass / Fail
		Chain 0	Chain 1	Chain 2	Chain 3		
149	5745	16.41	16.40	16.41	16.39	0.5	PASS
157	5785	16.44	16.41	16.42	16.42	0.5	PASS
165	5825	16.43	16.38	16.43	16.42	0.5	PASS

802.11ac (VHT20)

Channel	Frequency (MHz)	6dB Bandwidth (MHz)				Minimum Limit (MHz)	Pass / Fail
		Chain 0	Chain 1	Chain 2	Chain 3		
149	5745	17.69	17.66	17.68	17.68	0.5	PASS
157	5785	17.68	17.66	17.64	17.65	0.5	PASS
165	5825	17.66	17.64	17.65	17.66	0.5	PASS

802.11ac (VHT40)

Channel	Frequency (MHz)	6dB Bandwidth (MHz)				Minimum Limit (MHz)	Pass / Fail
		Chain 0	Chain 1	Chain 2	Chain 3		
151	5755	36.42	36.43	35.88	36.41	0.5	PASS
159	5795	36.45	36.29	36.46	36.45	0.5	PASS

802.11ac (VHT80)

Channel	Frequency (MHz)	6dB Bandwidth (MHz)				Minimum Limit (MHz)	Pass / Fail
		Chain 0	Chain 1	Chain 2	Chain 3		
155	5775	76.56	76.57	76.59	76.59	0.5	PASS

802.11ac (VHT80+80)

Channel	Frequency (MHz)	6dB Bandwidth (MHz)				Minimum Limit (MHz)	Pass / Fail
		Chain 0	Chain 1	Chain 2	Chain 3		
42+155	5210	-					
	5775	-	-	76.52	76.61	0.5	PASS

Spectrum Plot of Worst Value

802.11a / Chain 1 : CH165

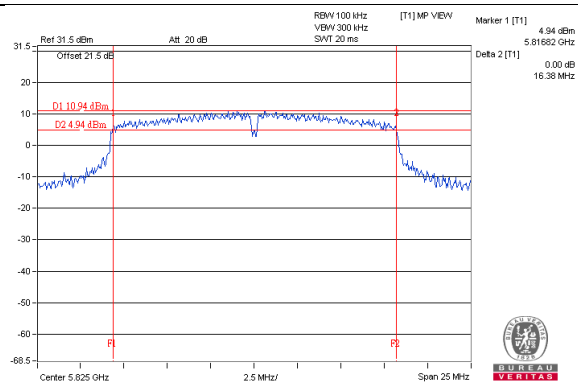

802.11ac (VHT20) / Chain 1 : CH165

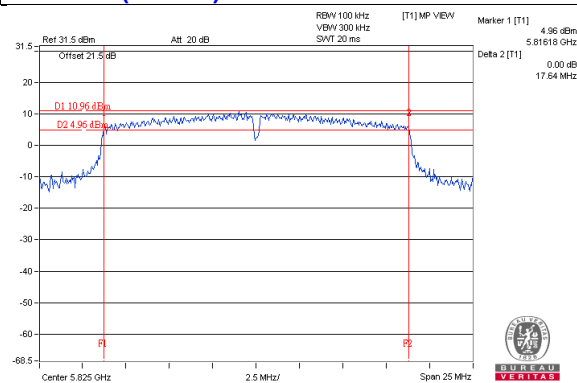

802.11ac (VHT40) / Chain 2: CH151

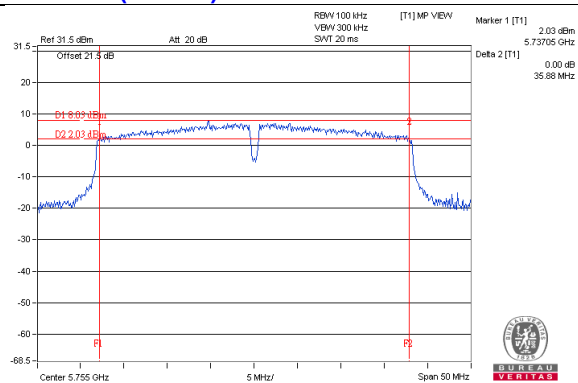

802.11ac (VHT80) / Chain 0 : CH155

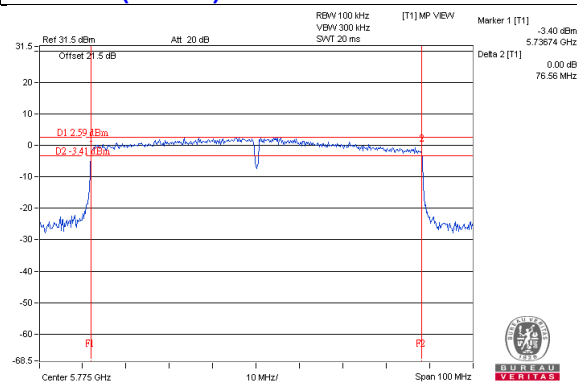

802.11ac (VHT80+80) / Chain 2: CH155

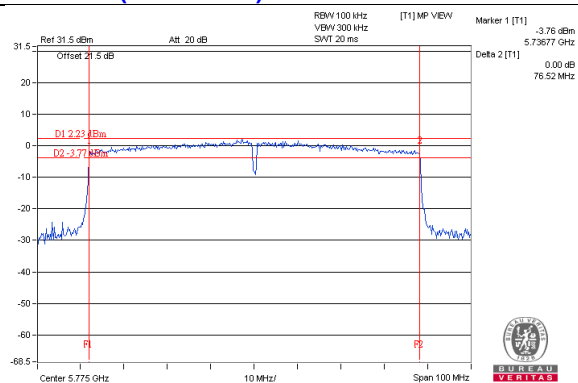

5 Pictures of Test Arrangements

Please refer to the attached file (Test Setup Photo).

Annex A- Radiated Out of Band Emission (OOBE) Measurement (For U-NII-3 band)

Annex A.1 (Mode 1)

802.11a

CH 149 5745 MHz

Horizontal

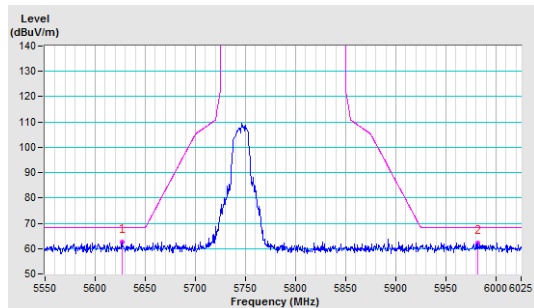

Vertical

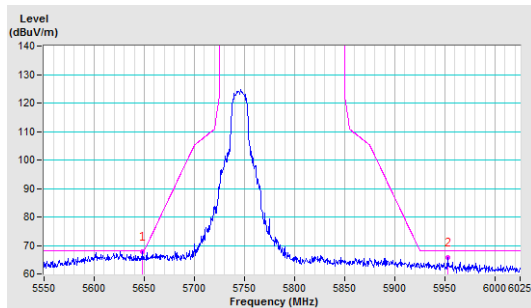

CH 157 5785 MHz

Horizontal

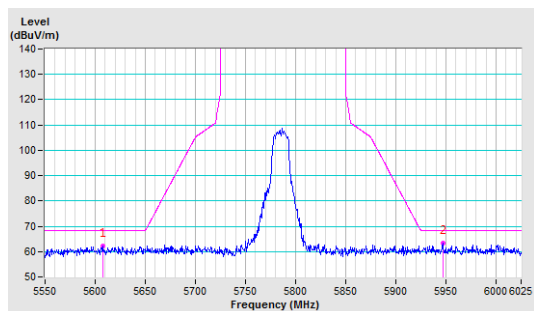

Vertical

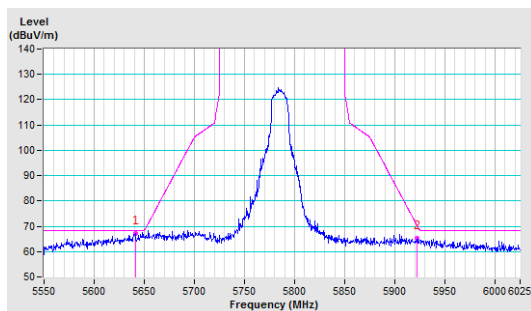

CH 165 5825 MHz

Horizontal

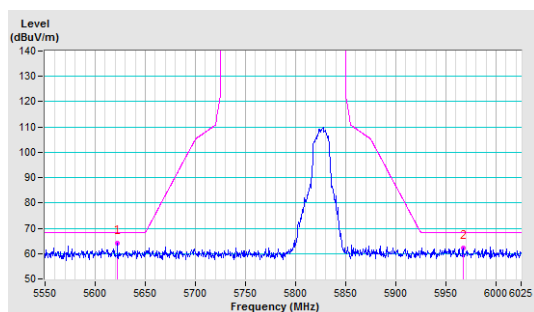

Vertical

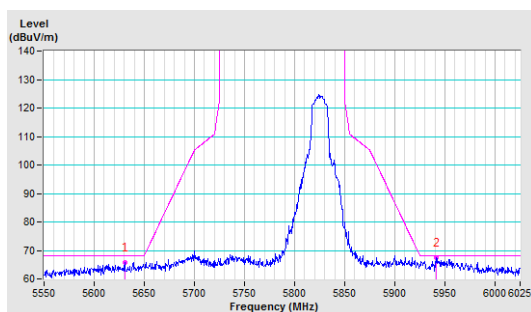

802.11ac (VHT20)

CH 149 5745 MHz

Horizontal

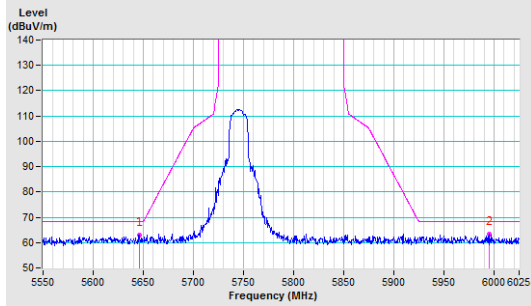

Vertical

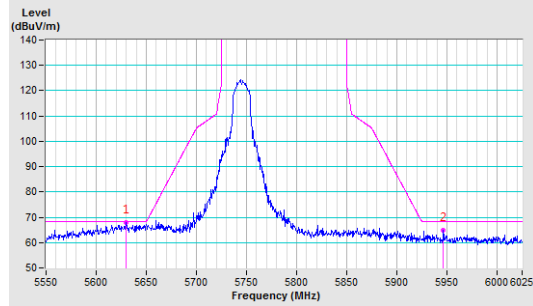

CH 157 5785 MHz

Horizontal

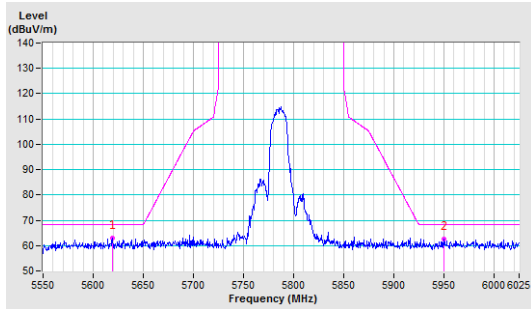

Vertical

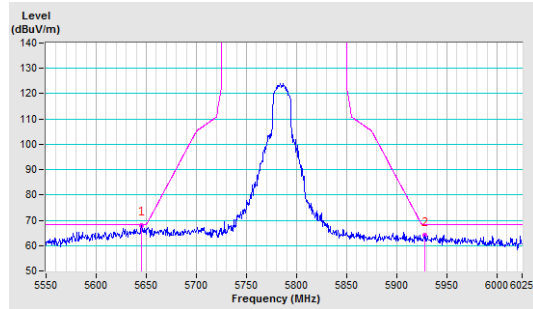

CH 165 5825 MHz

Horizontal

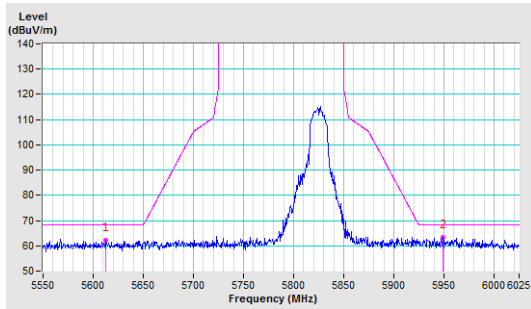

Vertical

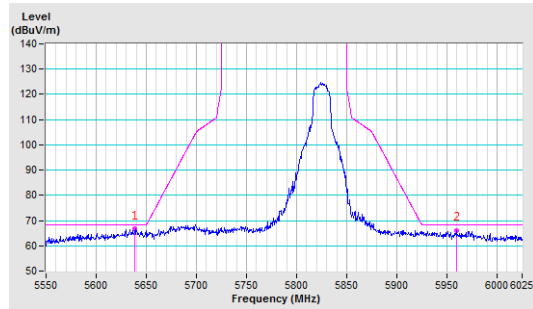

802.11ac (VHT40)

CH 151 5755 MHz

Horizontal

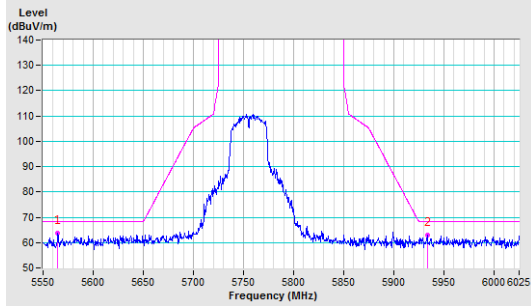

Vertical

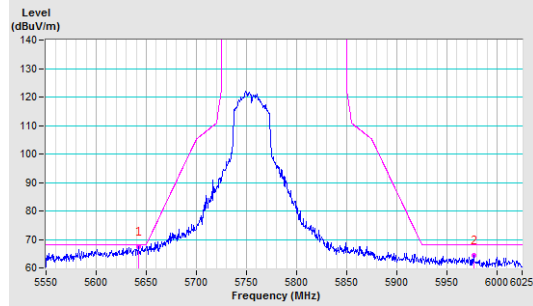

CH 159 5795 MHz

Horizontal

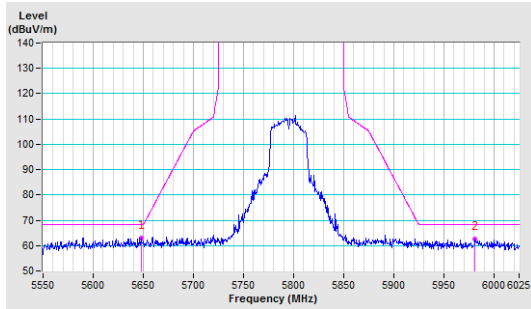

Vertical

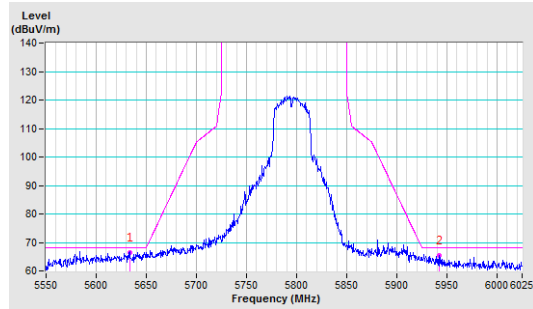

802.11ac (VHT80)

CH 155 5775 MHz

Horizontal

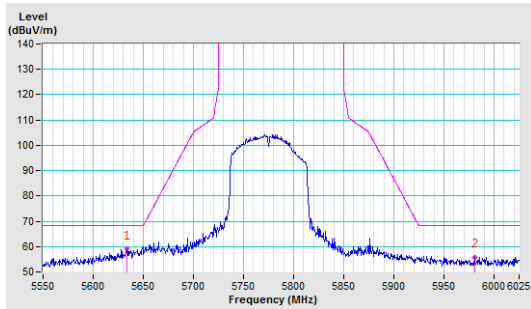

Vertical

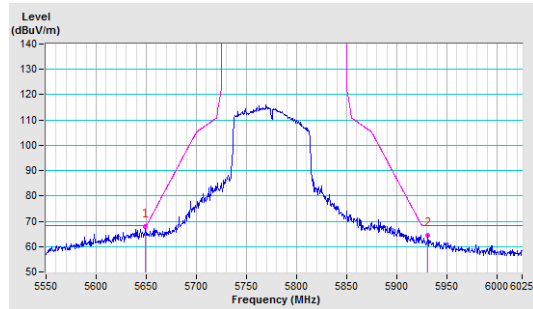

802.11ac (VHT80+80)

CH 42+155 5210+5775 MHz

Horizontal

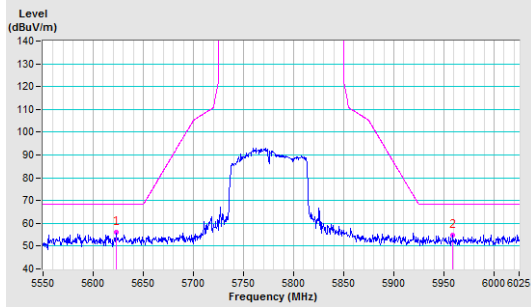

Vertical

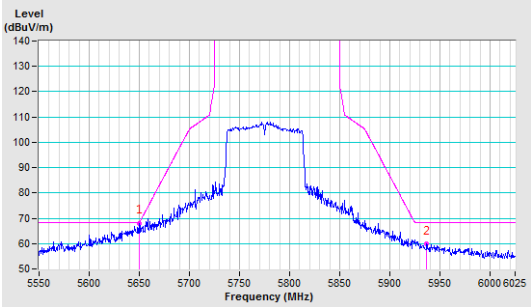

Annex A.2 (Mode 2)

802.11a

CH 149 5745 MHz

Horizontal

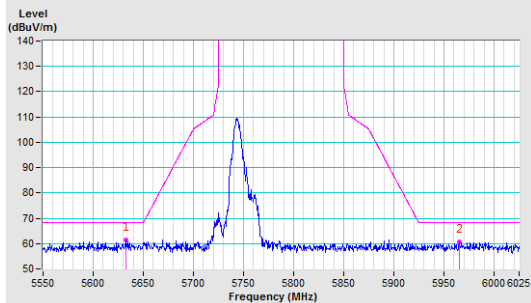

Vertical

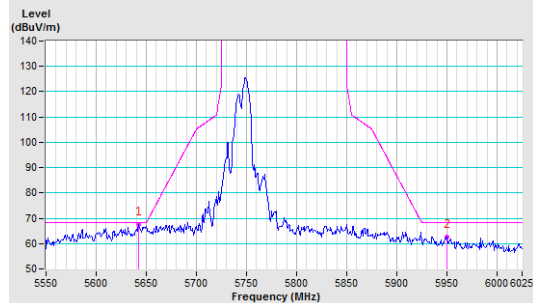

CH 157 5785 MHz

Horizontal

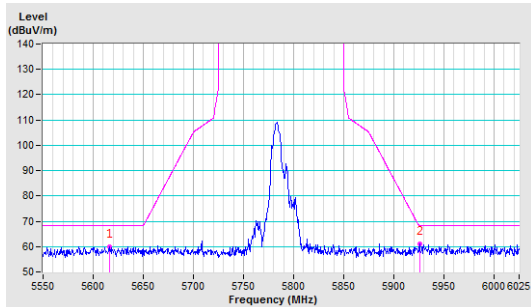

Vertical

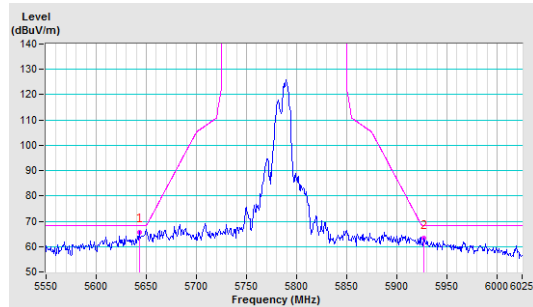

CH 165 5825 MHz

Horizontal

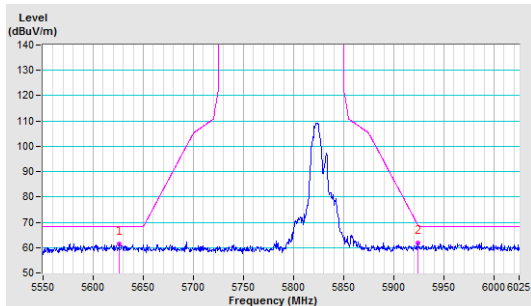

Vertical

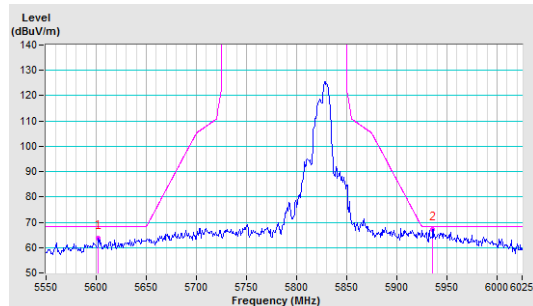

802.11ac (VHT20)

CH 149 5745 MHz

Horizontal

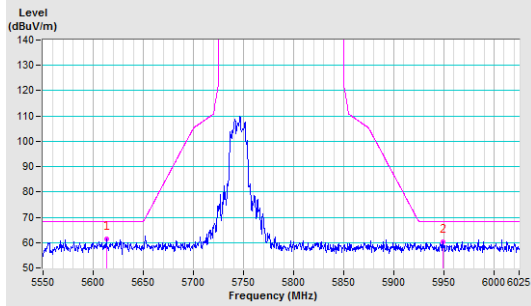

Vertical

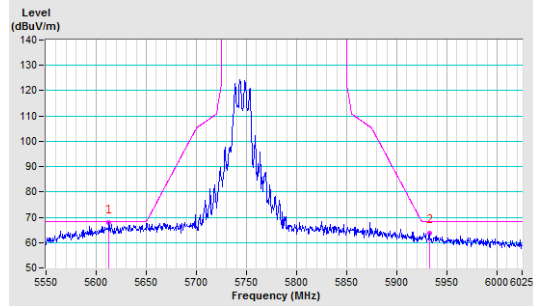

CH 157 5785 MHz

Horizontal

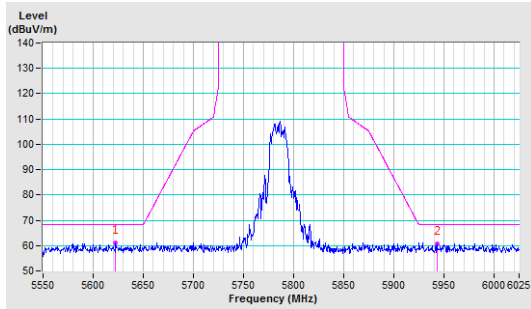

Vertical

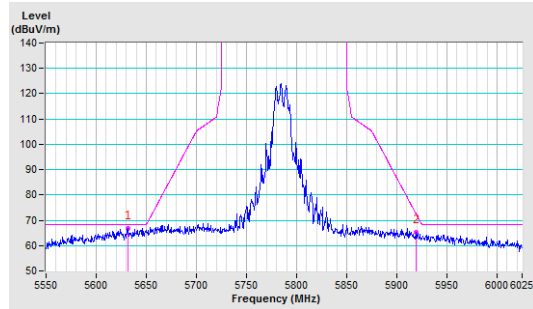

CH 165 5825 MHz

Horizontal

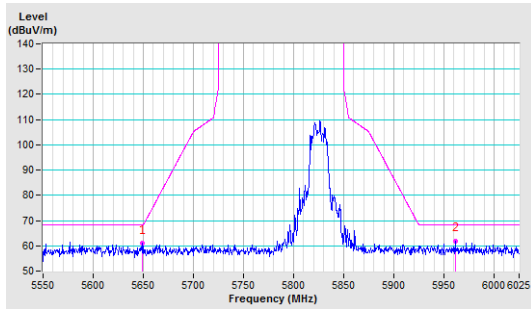

Vertical

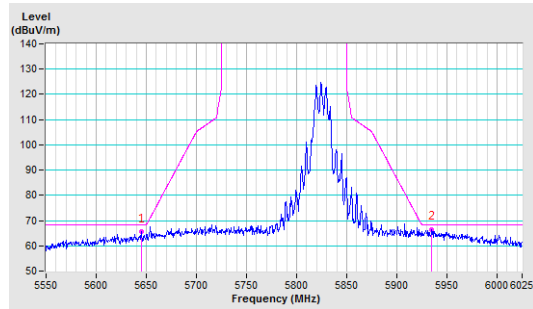

802.11ac (VHT40)

CH 151 5755 MHz

Horizontal

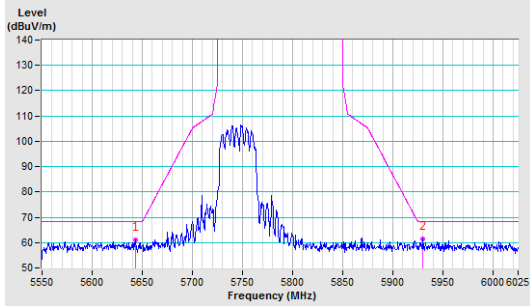

Vertical

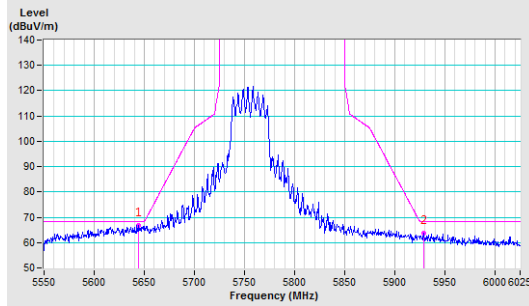

CH 159 5795 MHz

Horizontal

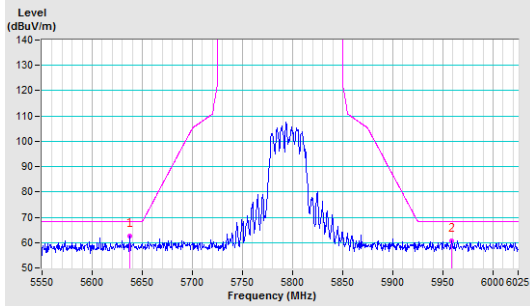

Vertical

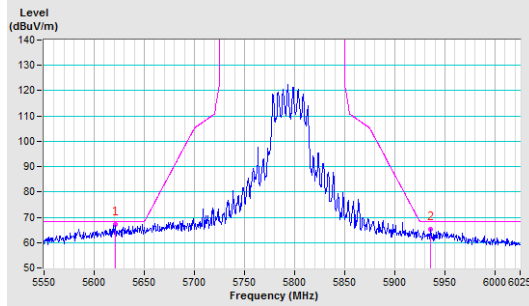

802.11ac (VHT80)

CH 155 5775 MHz

Horizontal

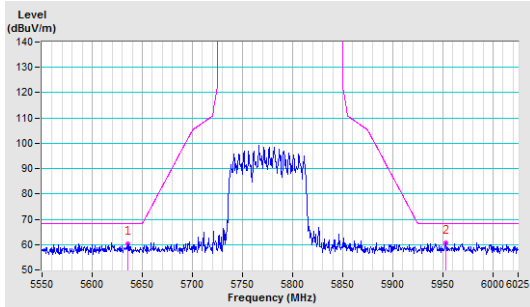

Vertical

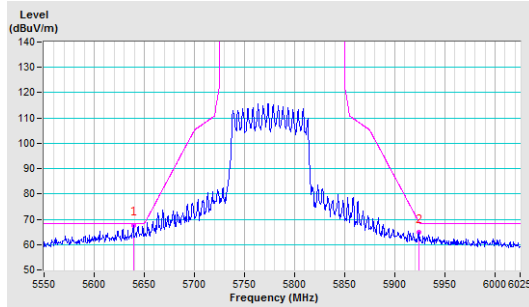

802.11ac (VHT80+80)

CH 42+155 5210+5775 MHz

Horizontal

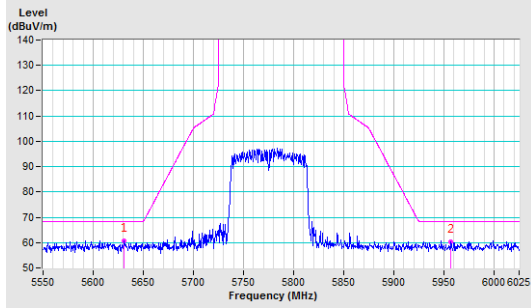

Vertical

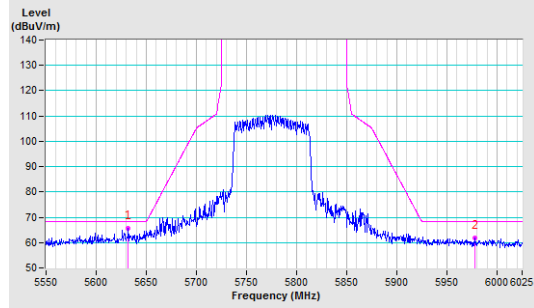

Appendix – Information on the Testing Laboratories

We, Bureau Veritas Consumer Products Services (H.K.) Ltd., Taoyuan Branch, were founded in 1988 to provide our best service in EMC, Radio, Telecom and Safety consultation. Our laboratories are accredited and approved according to ISO/IEC 17025.

If you have any comments, please feel free to contact us at the following:

Linko EMC/RF Lab

Tel: 886-2-26052180

Fax: 886-2-26051924

Hsin Chu EMC/RF/Telecom Lab

Tel: 886-3-6668565

Fax: 886-3-6668323

Hwa Ya EMC/RF/Safety Lab

Tel: 886-3-3183232

Fax: 886-3-3270892

Email: service.adt@tw.bureauveritas.com

Web Site: www.bureauveritas-adt.com

The address and road map of all our labs can be found in our web site also.

--- END ---