



User Manual

AC1750 Wi-Fi Router

DIR-869

Preface

D-Link reserves the right to revise this publication and to make changes in the content hereof without obligation to notify any person or organization of such revisions or changes.

Manual Revisions

Revision	Date	Description
1.00	January 27, 2016	Initial release

Trademarks

D-Link and the D-Link logo are trademarks or registered trademarks of D-Link Corporation or its subsidiaries in the United States or other countries. All other company or product names mentioned herein are trademarks or registered trademarks of their respective companies.

Apple®, Apple logo®, Safari®, iPhone®, iPad®, iPod touch® and Macintosh® are trademarks of Apple Inc., registered in the U.S. and other countries. App StoreSM is a service mark of Apple Inc.

Chrome™ browser, Google Play™ and Android™ are trademarks of Google Inc.

Internet Explorer®, Windows® and the Windows logo are trademarks of the Microsoft group of companies.

Copyright © 2016 by D-Link Corporation, Inc.

All rights reserved. This publication may not be reproduced, in whole or in part, without prior expressed written permission from D-Link Corporation, Inc.

Power Usage

This device is an Energy Related Product (ErP) with High Network Availability (HiNA), and automatically switches to a power-saving Network Standby mode within 1 minute of no packets being transmitted. It can also be turned off through a power switch to save energy when it is not needed.

Network Standby: TBD watts

Switched Off: TBD watts

Table of Contents

Preface	i	Home	29
Product Overview	1	Internet.....	29
Package Contents.....	1	DIR-869.....	30
System Requirements.....	2	Connected Clients.....	31
Introduction	3	Settings	32
Features.....	5	Wizard	32
Hardware Overview.....	6	Internet.....	32
Back Panel	6	IPv6	42
LED Indicator.....	7	Wireless.....	59
Operation Modes.....	8	Guest Zone.....	61
Router Mode.....	9	Network.....	62
Extender Mode	10	Features.....	64
Access Point Mode	11	QoS Engine.....	64
Installation	12	Firewall Settings.....	65
Before you Begin.....	12	IPv4/IPv6 Rules	67
Wireless Installation Considerations.....	13	Port Forwarding	68
Antenna Setup.....	14	Virtual Server	69
Manual Setup.....	15	Website Filter.....	70
Router Mode.....	15	Static Routes.....	71
Getting Started	18	IPv6	72
Router Mode	18	Dynamic DNS	73
QRS Mobile App.....	19	IPv6 Host	74
Setup Wizard	24	Management.....	75
Configuration - Router Mode	28	Time & Schedule	75
		Time	75
		Schedule	76

System Log.....	77
Admin	79
System	80
Upgrade	81
Statistics	82
Connect a Wireless Client to your Router	83
WPS Button.....	83
Windows® 10.....	84
Windows® 8.....	86
WPA/WPA2	86
WPS.....	88
Windows Vista®.....	92
WPA/WPA2	93
Troubleshooting	95
Wireless Basics	99
What is Wireless?.....	100
Tips.....	102
Wireless Modes.....	103
Networking Basics	104
Check your IP address.....	104
Statically Assign an IP address	105
Wireless Security	106
What is WPA?	106
Technical Specifications	107
Regulatory Statements	108

Package Contents



DIR-869 AC1750 Wi-Fi Router



Ethernet Cable



Power Adapter



WI-FI Configuration Note



Wall Mount Hardware

If any of the above items are missing, please contact your reseller.

Note: Using a power supply with a different voltage rating than the one included with the DIR-869 will cause damage and void the warranty for this product.

System Requirements

Network Requirements	<ul style="list-style-type: none">• An Ethernet-based cable or DSL modem• IEEE 802.11 ac/n/g/b/a wireless clients• 10/100 Ethernet
Web-based Configuration Utility Requirements	<p>Computer with the following:</p> <ul style="list-style-type: none">• Windows®, Macintosh, or Linux-based operating system• An installed Ethernet adapter <p>Browser Requirements:</p> <ul style="list-style-type: none">• Internet Explorer 11 or higher• Firefox 20 or higher• Safari 7 or higher• Chrome 25 or higher <p>Windows® Users: Make sure you have the latest version of Java installed. Visit www.java.com to download the latest version.</p>
QRS Mobile Requirements	<ul style="list-style-type: none">• iPhone®/iPad®/iPod Touch® (iOS 7.0 or higher)• Android™ device (2.3.3 or higher)

Introduction

The D-Link DIR-869 AC1750 Wi-Fi Router shares your Internet connection over a blazing-fast Gigabit Wireless AC connection of up to 1750 Mbps (Up to 1300 Mbps 5 GHz Wireless AC and up to 450 Mbps 2.4 GHz Wireless N)¹, using advanced AC technology to maximize the speed and range of your wireless signal. Equipped with one Gigabit WAN/Internet port and four Gigabit ports to provide speeds up to 10x faster than standard 10/100 ports, the DIR-869 creates the best networking experience to date. With the addition of Advanced Quality of Service (QoS), data streams are separated, which helps organize and prioritize your network traffic so your computers, game consoles, 3D/4K video streaming, gaming, and VoIP calls run smoother over both your wired and wireless network.

The DIR-869 features the strongest and most sensitive wireless radio we've ever built, offering four times the power of a typical wireless router², letting you blanket large areas or multi-story buildings with Wi-Fi. The DIR-869's superior design allows you to enjoy full motion, high definition video calls on your mobile device while moving around. The DIR-869 prepares your home to become a Connected Home by bringing Wi-Fi to places your old signal can't reach. A stronger Wi-Fi signal means you can install more wireless surveillance cameras, baby monitors, sensors, and alarms in the places where you need them.

Featuring a 3x3 MIMO antenna configuration, the DIR-869 offers better data rates, fewer dead-spots, more coverage, and higher reliability. Operating exclusively in the 5 GHz band, the DIR-869's 802.11ac wireless connections avoid crowded the 2.4 GHz band traffic, allowing you faster speeds while still maintaining backwards compatibility with older 802.11n/g/b devices.

Equipped with an easily accessible mode switch, the versatile DIR-869 can assist you in solving your unique networking challenges. In router mode, the DIR-869 operates as a traditional router, sharing your Internet connection. In Extender mode³, the DIR-869 connects and works with your existing networking equipment to extend the range and enhance the capabilities of your home or office network. This means you can bring Wi-Fi to places where your current signal doesn't reach, letting you move from room to room, office to office, floor to floor, or yard to yard without losing signal. Enjoy Wi-Fi on your porch, balcony, next to your pool, breakroom, the far end of your office, or in your basement. The DIR-869's extender mode prepares your home to become a Connected Home by allowing you to install more wireless surveillance cameras, baby monitors, sensors, and alarms in the places where you need them.

D-Link Intelligent QoS Technology helps to increase network efficiency by analyzing network traffic and prioritizing it in order of importance. This way, two-way video, voice chat, and online gaming, take priority over background network traffic such as a file downloads, ensuring you have optimal network performance.

The DIR-869 supports the latest wireless security features to help prevent unauthorized access, be it from over a wireless network or the Internet. Support for WPA™ and WPA2™ standards ensure that you will be able to use the best possible encryption regardless of your client devices. In addition, this router is equipped with a dual-active firewall (SPI and NAT) to prevent potential attacks over the Internet.

- 1 Maximum wireless signal rate derived from IEEE Standard 802.11a, 802.11g, 802.11n and 802.11ac specifications. Actual data throughput will vary. Network conditions and environmental factors, including volume of network traffic, building materials and construction, and network overhead, lower actual data throughput rate. Environmental conditions will adversely affect wireless signal range.
- 2 Determined by FCC regulation. Maximum wireless transmission power output is subject to regional radio frequency guidelines.
- 3 Extender Mode Access Point functionality available at launch, additional functionality available via firmware update in Q2 2016.

Features

- **Superior Wireless Networking** - The DIR-869 provides Gigabit wireless speeds of up to a combined 1750 Mbps (1300 Mbps 802.11ac 5 GHz, plus 450 Mbps 802.11n 2.4 GHz)¹. This capability rivals wired connections, allowing users to participate in real-time activities online, such as HD video communication, online gaming, and use mobile devices from anywhere in your home while still offering full 802.11n/g/b backward compatibility.
- **Extreme Wired LAN and WAN Networking** - With four 10/100/1000 Gigabit Ethernet LAN ports, and a 10/100/1000 Gigabit Ethernet WAN port, the DIR-869 has an enormous amount of bandwidth to take full advantage of the highest speed broadband connections available. Powered by a 1.0 GHz Dual Core CPU, the DIR-869 has the brains and the power to simultaneously stream multiple HD videos to set top boxes and mobile devices, participate in online gaming with consoles or PCs, run a cloud-enabled home surveillance system, and copy massive files without slowdowns, lag, or stuttering.
- **Advanced Firewall Features** - The web-based user interface displays a number of advanced network management features. Easily apply content filtering based on MAC address, URL, and/or domain name. Schedule these filters to be active on certain days or for a duration of hours or minutes.
- **Secure Multiple/Concurrent Sessions** - The DIR-869 can pass through VPN sessions. It supports multiple and concurrent IPsec and PPTP sessions, so users behind the DIR-869 can securely access corporate networks.
- **User-friendly Setup Wizard** - Through its easy-to-use web-based user interface or QRS (Mobile Quick Router Setup) App, the DIR-869 lets you quickly configure and secure your router to your specific settings in minutes.
- **Router or Extender Mode** - With the flick of a switch, you can easily set up your DIR-869 to operate as the core device of your network in Router Mode, or add your DIR-869 to an existing network using Extender Mode using Ethernet.²

¹ Maximum wireless signal rate derived from IEEE Standard 802.11a, 802.11g, 802.11n and 802.11ac specifications. Actual data throughput will vary. Network conditions and environmental factors, including volume of network traffic, building materials and construction, and network overhead, lower actual data throughput rate. Environmental conditions will adversely affect wireless signal range.

² Extender Mode Access Point functionality available at launch, additional functionality available via firmware update in Q2 2016.

Hardware Overview

Back Panel

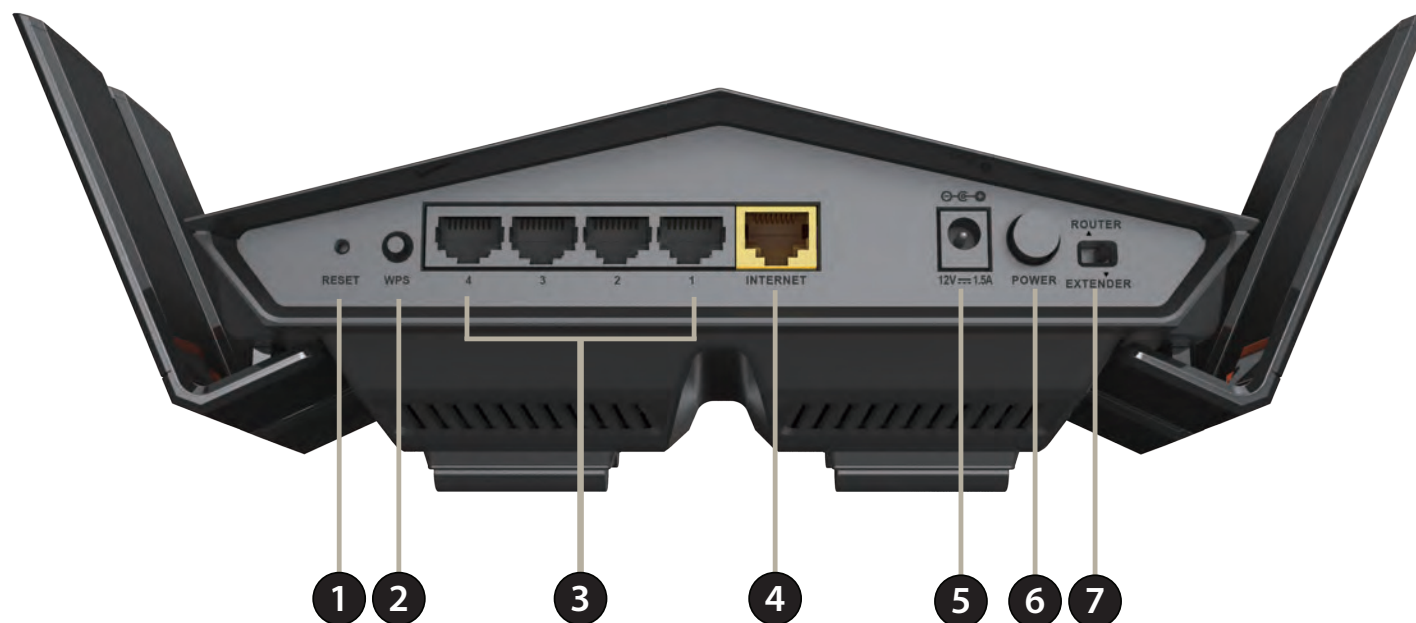

1	Reset Button	To reset the device to its factory default settings, use a paper clip press and hold the reset button for 3 seconds.
2	WPS	Press to start the WPS process and automatically create a secure connection to a WPS client.
3	LAN Ports (1-4)	Connect 10/100/1000 Ethernet devices such as computers, switches, storage (NAS) devices and game consoles.
4	Internet Port	Using an Ethernet cable, connect your broadband modem to this port.
5	Power Connector	Connector for the supplied power adapter.
6	Power Button	Press the power button to power the DIR-869 on and off.
7	Mode Switch	Select between Router and Extender modes. To change modes, move the switch to the desired position and after 5 seconds the router will reboot into the desired mode. Router is the default mode. Note: Extender Mode Access Point functionality available at launch, additional functionality available via firmware update in Q2 2016.

Hardware Overview

LED Indicator



1	Power LED	Solid White	A solid white light indicates that the device is powered on and healthy.
		Solid Orange	A solid orange light indicates that the device is booting or undergoing a factory reset.
		Blinking Orange	A blinking orange light indicates that the device is in recovery mode.
		Blinking White	A blinking white light indicates that WPS client search mode is active.

Operation Modes

The mode switch lets you choose how the DIR-869 operates. Select either **Router Mode** or **Extender Mode**.

- **Router Mode** shares your Internet connection. This is the factory default setting suitable for most users.
- **Extender Mode** extends your existing network.

Refer to the following pages for information on the DIR-869's operation modes. This information includes usage scenarios, cable diagrams, and network configuration information.



Note: Determine your desired type of operation and adjust the mode switch before you begin your installation. If the mode switch is adjusted while powered on, the DIR-869 will reboot into the new mode after five seconds.

Note: Extender Mode Access Point functionality available at launch, additional functionality available via firmware update in Q2 2016.

Router Mode

In **Router Mode**, the DIR-869 AC1750 Wi-Fi Router operates as the central device of your network. This is the most common type of installation and is the factory default mode switch setting suitable for most users. The DIR-869 connects to your cable modem, DSL modem, or other Internet source and shares your Internet connection with your wired and wireless devices.

Create a Home Network (Router Mode)

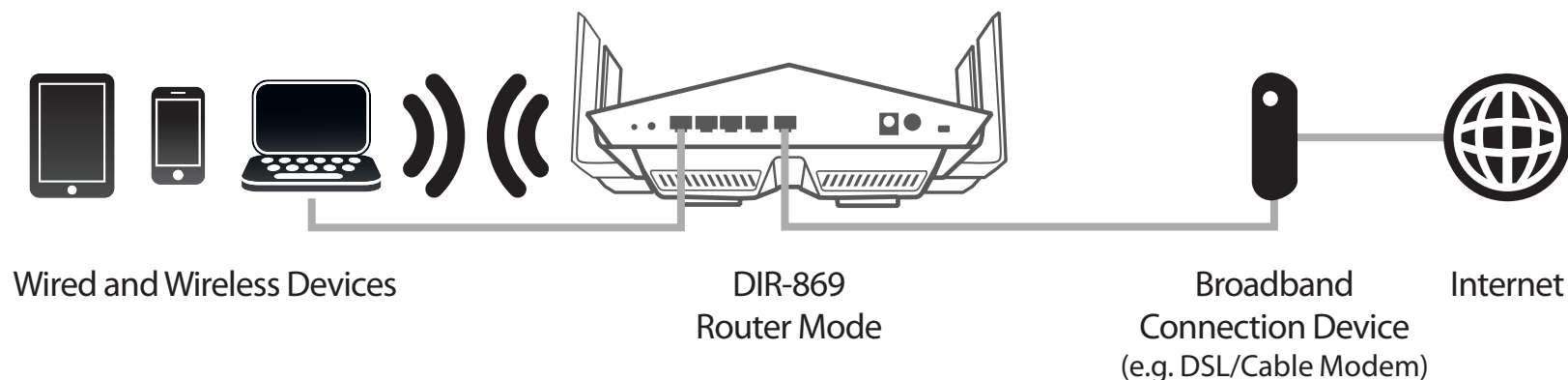

Use this mode for:

- Setting up a network for the first time.
- Replacing an existing router or network equipment.
- Adding a router to share a broadband connection which was previously connected to a single device.

Place your DIR-869 near your Broadband Internet Connection Device (e.g. DSL/Cable Modem) and connect via Ethernet cable.

Extender Mode

What is a Wireless Extender?

In **Extender Mode**, the DIR-869 AC1750 Wi-Fi Router operates in conjunction with your existing networking equipment to provide Wi-Fi for parts of your home or office that may have poor or no reception. Use this mode with an existing router which is sharing your Internet connection. Place the DIR-869 in an area where you wish to get Wi-Fi, but is reachable by Ethernet cables or Wireless signals from you uplink network.

Create a Wireless Network Using Ethernet (Access Point Mode)

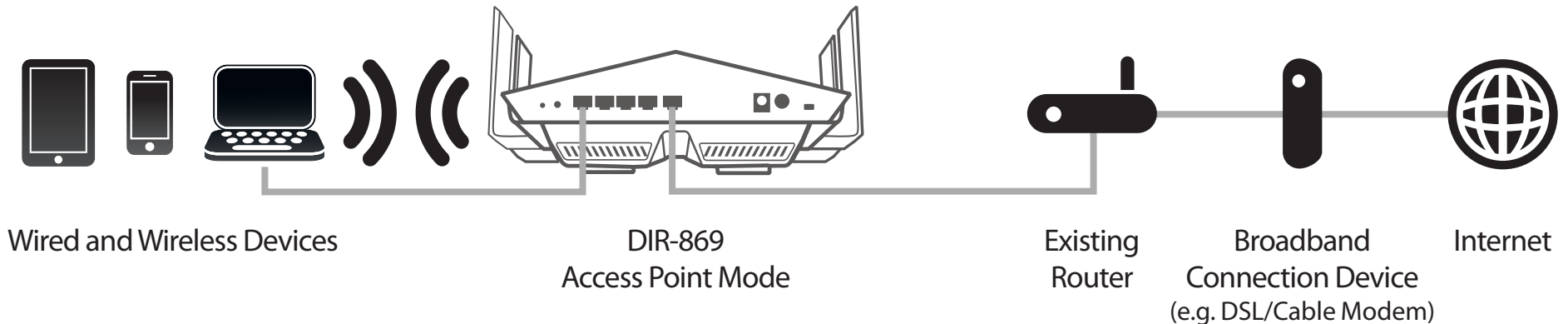

Extend Your Wireless Network Using Wi-Fi (Repeater Mode)

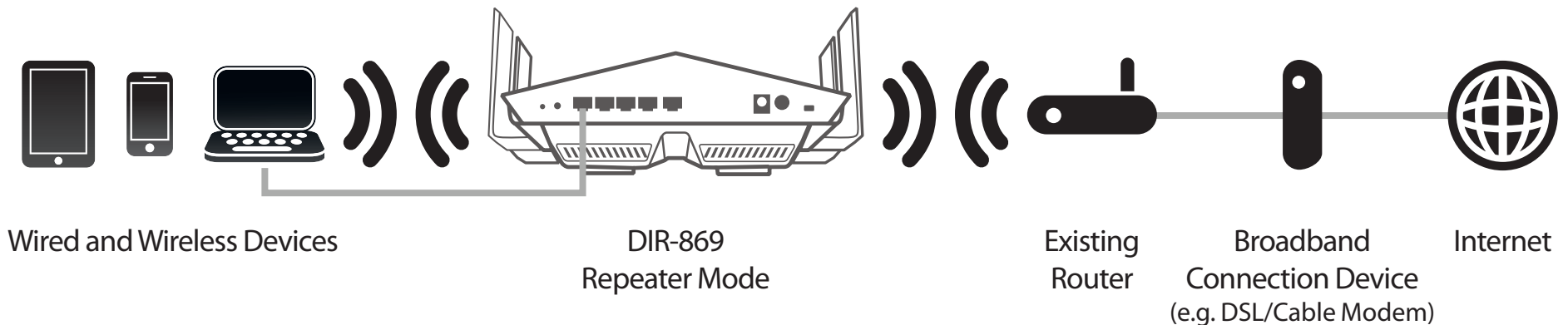

Note: Extend Your Wireless Network using Wi-Fi (Repeater Mode) available via firmware update in Q2 2016.

Access Point Mode

Create a Wireless Network using Ethernet

The DIR-869 operates as an Access Point when the mode switch is in the **Extender** position and an Ethernet cable is connected to the Internet Port from an uplink network. In Access Point Mode, the DIR-869 connects your wireless devices together, but does not provide routing functionality. It also allows a connected wired devices to connect to your other devices wirelessly. This can be useful if you already have an existing Internet router that does not have built-in wireless capabilities. The DIR-869 creates a new wireless network and devices connected via Wi-Fi and LAN ports obtain IP addresses from the existing router. Use a Gigabit capable Ethernet connection where possible to ensure the best networking experience.

Create a Wireless Network using Ethernet (Access Point Mode)

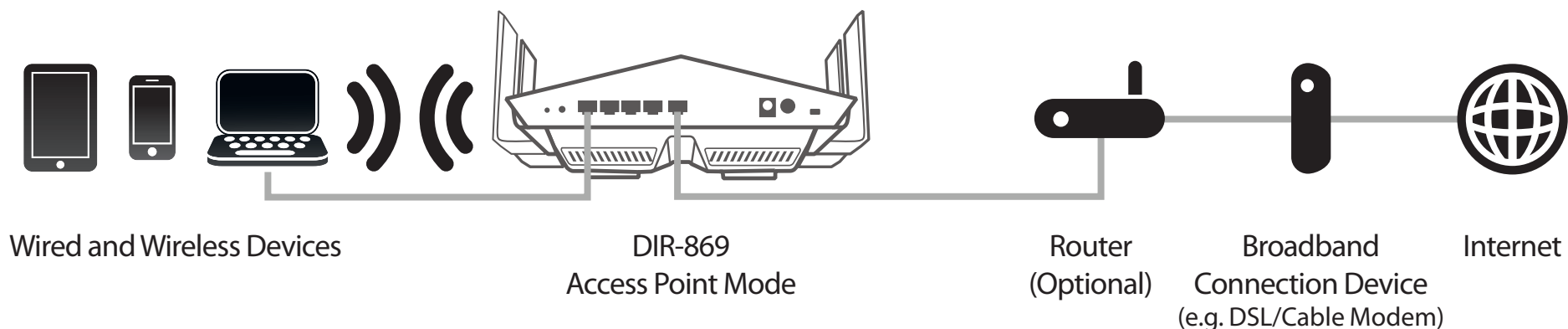

Use this mode for:

- Extending your current network.
- Bringing Wi-Fi to an area it doesn't currently reach.

Place your DIR-869 near the area you wish to bring Wi-Fi to and connect via Ethernet cable to your uplink network.

Note: Extending network to desired location via Ethernet may require purchase of additional cable.

Installation

This section will walk you through the installation process. Placement of the router is very important. Do not place the router in an enclosed area such as a closet, cabinet, attic, or garage.

Before you Begin

- Configure the router with the computer that was last connected directly to your Internet connection. Verify that it is connected to the Internet before connecting additional devices.
- If your ISP provided you with a modem/router combo, you will need to set it to “bridge” mode so the router can work properly. Please contact your ISP or refer to the user manual for your modem/router device.
- You can only use the Ethernet port on your modem. If you were using the USB connection before using the router, then you must turn off your modem, disconnect the USB cable and connect an Ethernet cable to the Internet port on the router, and then turn the modem back on. In some cases, you may need to call your Internet Service Provider (ISP) to change connection types (USB to Ethernet).
- If connecting to a DSL modem, make sure to have your DSL service information provided by your Internet Service Provider handy. This information is likely to include your DSL account's Username and Password. Your ISP may also supply you with additional WAN configuration settings which might be necessary to establish a connection.
- If you are connecting a considerable amount of networking equipment, it may be a good idea to take the time to label each cable or take a picture of your existing setup before making any changes.
- If you have DSL and are connecting via PPPoE, make sure you disable or uninstall any PPPoE software such as WinPoET, BroadJump, or EnterNet 300 from your computer or you will not be able to connect to the Internet.
- If you are using this device to extend the range of your existing wireless network, you may need to use trial and error to determine an acceptable placement location.

Wireless Installation Considerations

The D-Link wireless router lets you access your network using a wireless connection from virtually anywhere within the operating range of your wireless network. Keep in mind that the number, thickness and location of walls, ceilings, or other objects that the wireless signals must pass through may limit the range. Typical ranges vary depending on the types of materials and background RF (radio frequency) noise in your home or business. The key to maximizing wireless range is to follow these basic guidelines:

1. Keep the number of walls and ceilings between the D-Link router and other network devices to a minimum - each wall or ceiling can reduce your adapter's range from 3-90 feet (1-30 meters.) Position your devices so that the number of walls or ceilings is minimized.
2. Be aware of the direct line between network devices. A wall that is 1.5 feet thick (0.5 meters), at a 45-degree angle appears to be almost 3 feet (1 meter) thick. At a 2-degree angle it looks over 42 feet (14 meters) thick! Position devices so that the signal will travel straight through a wall or ceiling (instead of at an angle) for better reception.
3. Building materials make a difference. A solid metal door or aluminum studs may have a negative effect on range. Try to position access points, wireless routers, and computers so that the signal passes through drywall or open doorways. Materials and objects such as glass, steel, metal, walls with insulation, water (fish tanks), mirrors, file cabinets, brick, and concrete will degrade your wireless signal.
4. Keep your product away (at least 3-6 feet or 1-2 meters) from electrical devices or appliances that generate RF noise.
5. If you are using 2.4 GHz cordless phones or X-10 (wireless products such as ceiling fans, lights, and home security systems), your wireless connection may degrade dramatically or drop completely. Make sure your 2.4 GHz phone base is as far away from your wireless devices as possible. The base transmits a signal even if the phone is not in use.

Antenna Setup

The DIR-869 is designed to give you the fastest, most stable network connection possible. In order to maximize performance, fully extend the antennas to provide optimal wireless coverage. Keep the router in an open area for better wireless coverage.



Manual Setup

Router Mode

1. Inspect the mode switch to ensure that it is in the factory default **ROUTER** position. Adjust the switch if necessary.

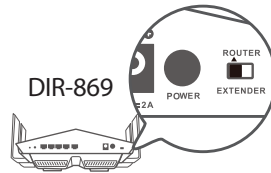

2. Position your DIR-869 near your Internet-connected modem. Place it in an open area for better wireless coverage.

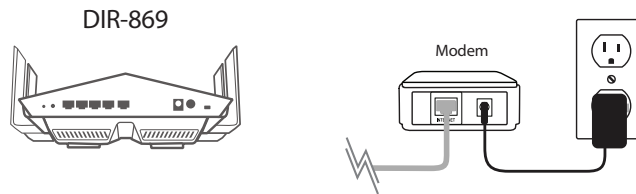

3. Turn off and unplug the power and Ethernet cable to your cable or DSL broadband modem. This is required. In some cases, you may need to turn it off for up to five minutes.

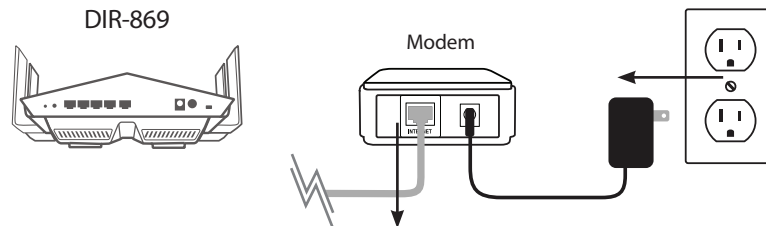

4. Use the included Ethernet cable to connect your modem to the yellow port labeled **INTERNET** on the router.

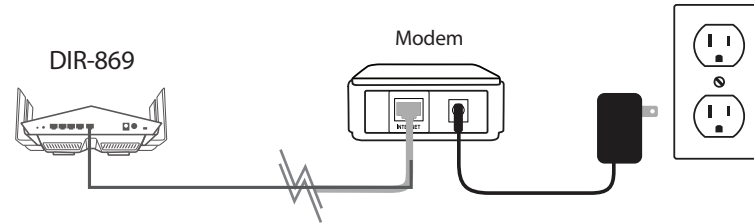

5. Turn on or plug your modem back in and wait approximately one minute before proceeding onward.

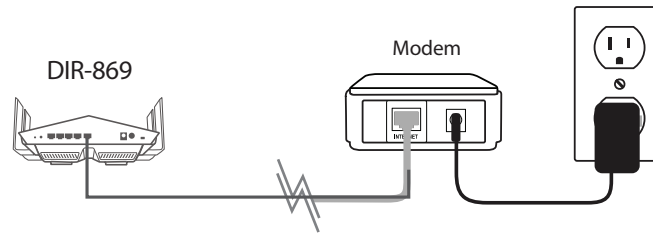

6. Connect the supplied power adapter to the router and a power outlet, press the power button, and wait approximately one minute until the LED indicator on the front of the device changes from orange to solid white.

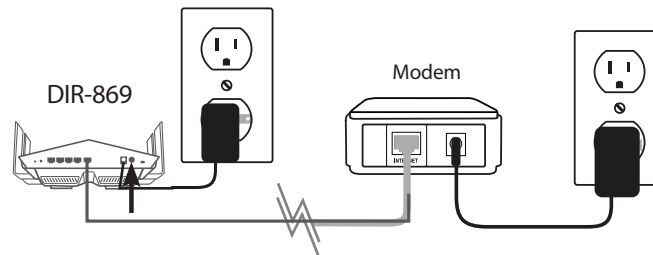

Note: This unit is to be used with power supply model MU18A2120150-A1 or 2ABB018F US.

7. If you are configuring the DIR-869 wirelessly from a PC, connect to a Wi-Fi network printed on the included Wi-Fi Configuration Card. You can also find the Wi-Fi network names and passwords printed on the label attached to the bottom your router.

If you are configuring the from a PC with a wired Ethernet connection, plug one end of an Ethernet cable into the port labeled 1 on the back of the router, and the other end into the Ethernet port on your computer.

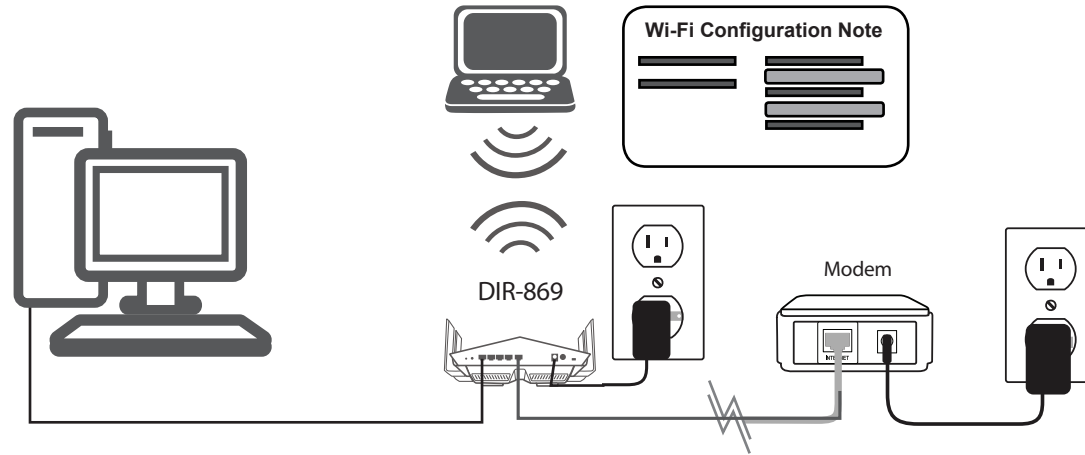

8. If you are connecting to a broadband service that uses a dynamic connection (not PPPoE), you may be online already. Try opening a web browser and connecting to a website. If the website does not load, proceed to **Getting Started on page 18**.

Getting Started

Router Mode

There are several different ways you can configure your router to connect to the Internet and connect to your clients:

- **QRS Mobile App** - Use your Android device, iPhone, iPad, or iPod touch to configure your router. Refer to page 19.
- **D-Link Setup Wizard** - This wizard will launch when you log into the router for the first time. Refer to page 24.
- **Manual Setup** - Log into the router and manually configure your router. Refer to page 28

QRS Mobile App

QRS Mobile app allows you to install and configure your router from your mobile device.

Note: The screenshots may be different depending on your mobile device's OS version.

Step 1

Search for the free **QRS Mobile** App on the iTunes Store or Google Play.



Step 2

Once your app is installed, you may now configure your router. Connect to the router wirelessly by going to your wireless utility on your device. Scan for the Wi-Fi name (SSID) as listed on the supplied info card. Select and then enter your Wi-Fi password.

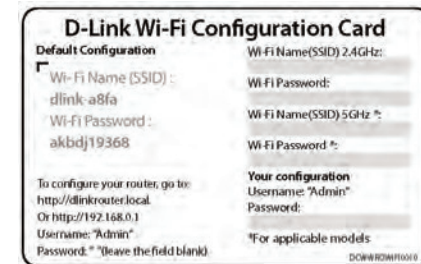

Step 3

Once you connect to the router, launch the QRS Mobile app from the Home screen of your device.

Note: The following steps show the Android interface of the QRS Mobile app. If you are using an iPhone, iPad, or iPod touch, the appearance may be different to that of the screenshots, but the process is the same.



Step 4

You will see the welcome screen. Tap **Start** to proceed, then enter your device password and tap **Log In**. Tap **Next** once the Operation Mode screen appears.

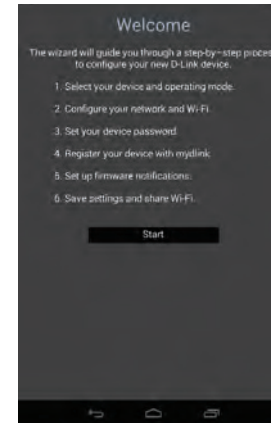

Step 5

At this point, please ensure that you the router is connected to a modem. Plug one end of the provided Ethernet cable into your DSL or cable modem, and plug the other end into the port marked INTERNET on the DIR-869. Tap **Next** to automatically detect your Internet connection and proceed to the next step.

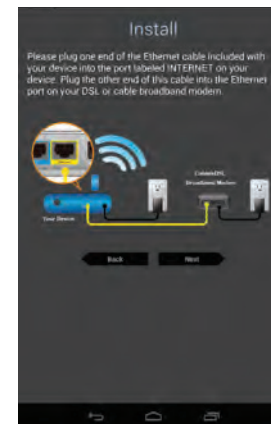

Step 6

You will be asked to configure your 2.4 GHz wireless network. Enter a network name (SSID) of your choice, or leave it unchanged to accept the default SSID.

Next, choose a Wi-Fi password of at least 8 characters. Any device trying to connect to the router wirelessly will need to enter this password the first time it connects.

Tap **Next** to configure your 5 GHz wireless network. When satisfied tap **Next** to proceed.



Step 7

Enter the administrator password of your choice. Unlike the Wi-Fi password, this password is only required when you need to configure the router. See **Configuration - Router Mode** on page 28 for details of when this password is used. Tap **Next** to proceed.

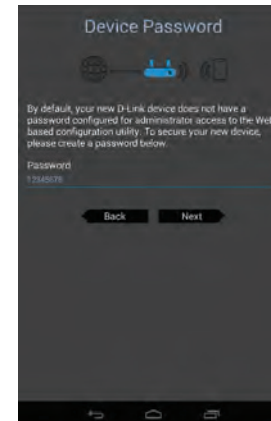

Step 8

If you wish to receive push notifications whenever a new firmware update is available, check the **Notify me when new firmware is available** box and tap **Next**.

Otherwise, just tap **Next** to proceed.

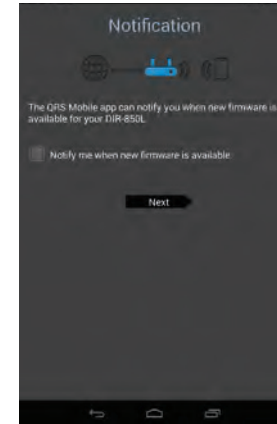

Step 10

You will be presented with a summary of your chosen settings. Tap **Save** to complete the setup.



Congratulations, your device has been successfully configured! You can share this information by tapping **Share By E-mail**, or tap **Finish** to exit the app.

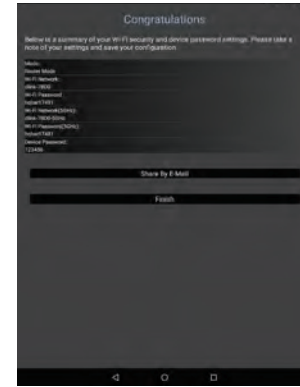

Setup Wizard

If this is your first time installing the router, open your web browser and enter **http://dlinkrouter.local/** in the address bar. Alternatively, enter the IP address of the router (default: **http://192.168.0.1**).

The wizard is designed to guide you through a step-by-step process to configure your new D-Link router and connect to the Internet.

Click **Next** to continue.

Please wait while your router detects your Internet connection type. If the router detects your Internet connection, you may need to enter your ISP information such as username and password.

If the router does not detect a valid Internet connection, a list of connection types to choose from will be displayed.

Select your Internet connection type (this information can be obtained from your Internet Service Provider) and click **Next** to continue.

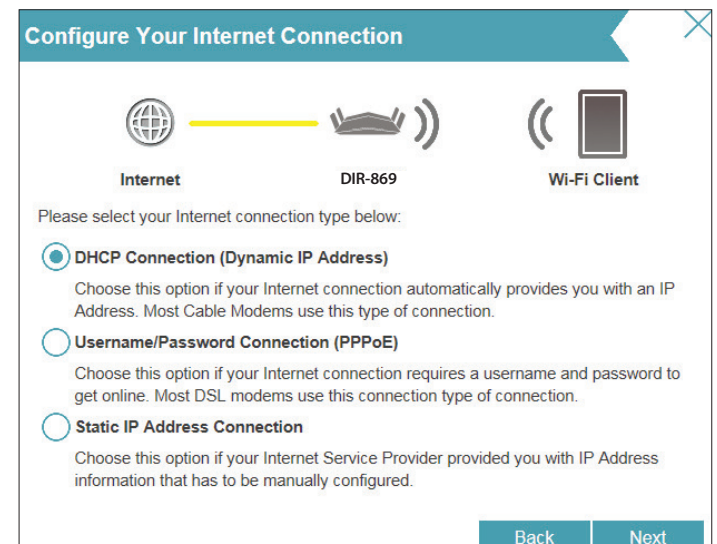
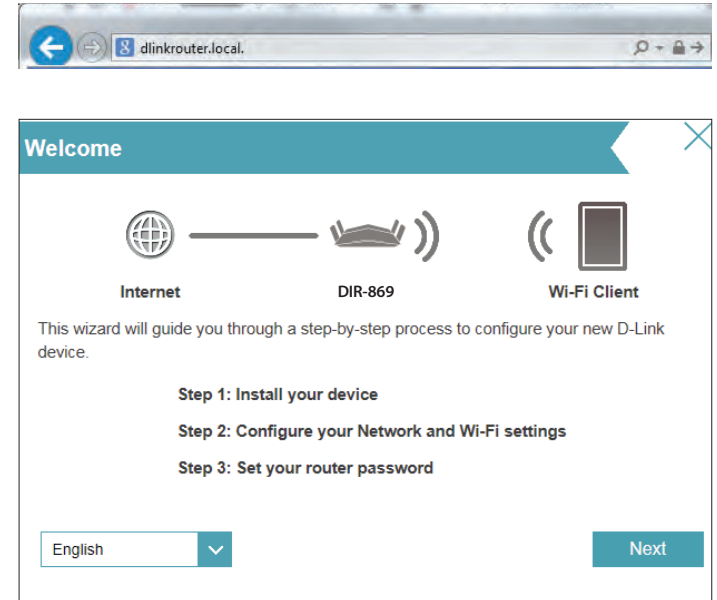

If the router detected or you selected **PPPoE**, enter your PPPoE username and password and click **Next** to continue.

Note: Make sure to remove your PPPoE software from your computer. The software is no longer needed and will not work through a router.

The screenshot shows the 'PPPoE' configuration screen. At the top, there is a teal header with the text 'PPPoE' and a close button. Below the header, there is a diagram showing 'Internet' (globe icon) connected to 'DIR-869' (router icon) which is connected to a 'Wi-Fi Client' (smartphone icon). Below the diagram, there is a text block: 'To setup this Internet connection, you will need to have a User Name from your Internet Service Provider. If you do not have this information, please contact your ISP.' Below this text are two input fields: 'Username:' and 'Password:'. At the bottom right, there are two buttons: 'Back' and 'Next'.

If the router detected or you selected **Static**, enter the IP and DNS settings supplied by your ISP. Click **Next** to continue.

The screenshot shows the 'Static IP' configuration screen. At the top, there is a teal header with the text 'Static IP' and a close button. Below the header, there is a diagram showing 'Internet' (globe icon) connected to 'DIR-869' (router icon) which is connected to a 'Wi-Fi Client' (smartphone icon). Below the diagram, there is a text block: 'To set up this connection you will need to have a complete list of IP information by your Internet Service Provider. If you have a Static IP connection and do not have this information, please contact your ISP.' Below this text are five input fields: 'IP Address:', 'Subnet Mask:', 'Gateway Address:', 'Primary DNS Address', and 'Secondary DNS Address'. At the bottom right, there are two buttons: 'Back' and 'Next'.

Create a Wi-Fi password (between 8-63 characters). Your wireless clients will need to have this passphrase or key entered to be able to connect to your wireless network.

Click **Next** to continue.

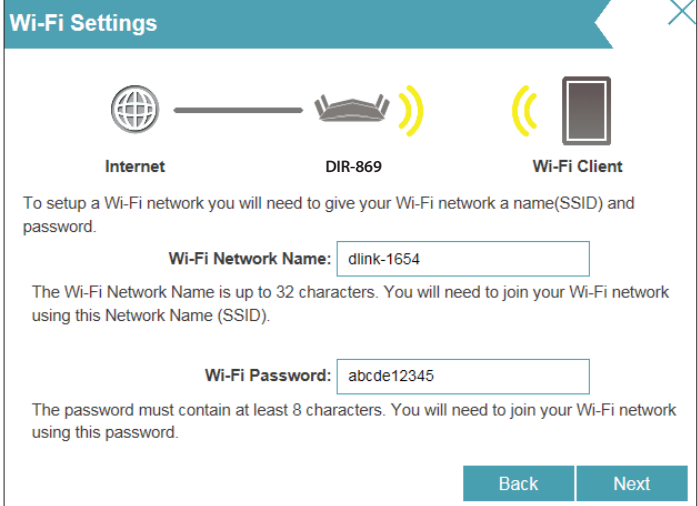

The screenshot shows the 'Wi-Fi Settings' configuration window. At the top, there is a teal header with the title 'Wi-Fi Settings' and a close button. Below the header, a diagram shows 'Internet' connected to 'DIR-869' (the router), which is then connected to a 'Wi-Fi Client' (a smartphone). The 'Wi-Fi Client' icon has yellow signal waves. Below the diagram, the text reads: 'To setup a Wi-Fi network you will need to give your Wi-Fi network a name(SSID) and password.' There are two input fields: 'Wi-Fi Network Name:' with the value 'dlink-1654' and 'Wi-Fi Password:' with the value 'abcde12345'. Below the password field, a note states: 'The password must contain at least 8 characters. You will need to join your Wi-Fi network using this password.' At the bottom right, there are two buttons: 'Back' and 'Next'.

In order to secure the router, please enter a new password. You will be prompted for this password every time you want to use the router's web configuration utility. Click **Next** to continue.

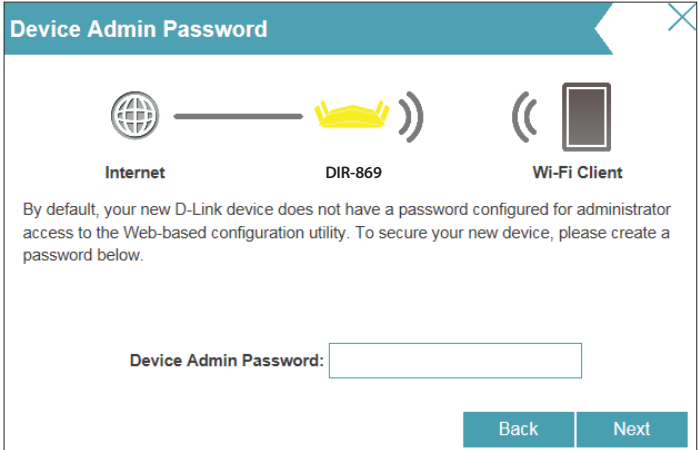

The screenshot shows the 'Device Admin Password' configuration window. It has a teal header with the title 'Device Admin Password' and a close button. Below the header, a diagram shows 'Internet' connected to 'DIR-869' (the router), which is then connected to a 'Wi-Fi Client' (a smartphone). The 'Wi-Fi Client' icon has yellow signal waves. Below the diagram, the text reads: 'By default, your new D-Link device does not have a password configured for administrator access to the Web-based configuration utility. To secure your new device, please create a password below.' There is one input field labeled 'Device Admin Password:'. At the bottom right, there are two buttons: 'Back' and 'Next'.

At the end of the wizard, you will be presented with a summary of your settings. Click **Next** to finalize the settings or **Back** to make changes.



At the end of the wizard, you will be presented with a final summary of your settings. Click **Finish** to close the wizard.



Configuration - Router Mode

To access the configuration utility, open a web-browser such as Internet Explorer and enter **http://dlinkrouter.local/** or you may also connect by typing the IP address of the router (by default this is **http://192.168.0.1**) in the address bar.

Enter your password. If you previously followed the setup wizard, please use the admin password you entered during the wizard. Otherwise, leave the password blank. Click **Log In** to proceed.

Note: If you cannot remember your password and cannot log in, press the reset/wps button on the back of the device for longer than 10 seconds to restore the router to its default settings.

The router's home page will open displaying its current connection status.

The bar at the top of the page has quick access to Settings and Management functions. You may quickly jump back Home at any time.

Note: The system will automatically log out after a period of inactivity.

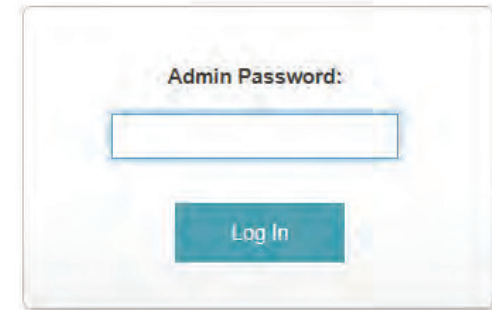

Home

The Home page displays the current status of the router in the form of an interactive diagram. You can click each icon to display information about each part of the network at the bottom of the screen. The menu bar at the top of the page will allow you to quickly navigate to other pages.

Internet

The Home page displays whether or not the router is currently connected to the Internet. If it is disconnected, click **Click to repair** to bring up the setup wizard, refer to page 24 for more information.



To bring up more details about your Internet connection, click on the **Internet** icon. Click **IPv4** or **IPv6** to see details of the IPv4 connection and IPv6 connection respectively.

Click **Release** to disconnect from the Internet. If you do this and wish to reconnect, click **Renew**.

To reconfigure the Internet settings, refer to page 32.

Internet

Cable Status:	Connected	MAC Address:	8C:72:20:15:16:57
Connection Type:	Dynamic IP (DHCP)	IP Address:	192.168.150.132
Network Status:	Connected	Subnet Mask:	255.255.255.0
Connection Uptime:	0 Day 0 Hour 13 Min 32 Sec	Default Gateway:	192.168.150.1
		Primary DNS Server:	192.168.150.1
		Secondary DNS Server:	Not Available

[Release IP Address](#) [Go to settings](#)

DIR-869

Click on the **DIR-869** icon to view details about the router and its wireless settings.

Here you can see the router's current Wi-Fi network name and password, as well as the router's MAC address, IPv4 address, and IPv6 address.

To reconfigure the network settings, either click **Go to settings** on the lower left, or click **Settings** (at the top of the page) and then **Network** on the menu that appears. For more information refer to page 62.

To reconfigure the wireless settings, either click **Go to settings**, on the lower right, or click **Settings** (at the top of the page) and then **Wireless** on the menu that appears. For more information refer to page 59.

The screenshot displays the D-Link DIR-869 web interface. At the top, there is a navigation bar with 'Home', 'Settings', 'Features', and 'Management' tabs. Below the navigation bar, a green status indicator shows 'Internet Connected'. A network diagram illustrates the connection between 'Internet', 'DIR-869', and 'Connected Clients: 1'. Below the diagram, the 'DIR-879' section provides detailed network and wireless settings.

Category	Parameter	Value
IPv4 Network	MAC Address:	6C:72:20:15:16:54
	Router IP Address:	192.168.0.1
	Subnet Mask:	255.255.255.0
IPv6 Network	Link-Local Address:	FE80:6E72:20FF:FE15:1654
	Router IPv6 Address:	/
	DHCP-PD:	Enabled
	Assigned Prefix:	Not Available
Wi-Fi	Status:	Enabled
	Wi-Fi Name (SSID):	dlink-1654
	Password:	abcde12345

Buttons for 'Go to settings' are located at the bottom right of the IPv4 and IPv6 sections.

Connected Clients

Click on the **Connected Clients** icon to view details about the router and its wireless settings.

On this page you can see all the clients currently connected to the router, and their IP addresses.

To edit each client's settings, click the pencil icon on the client you want to edit.

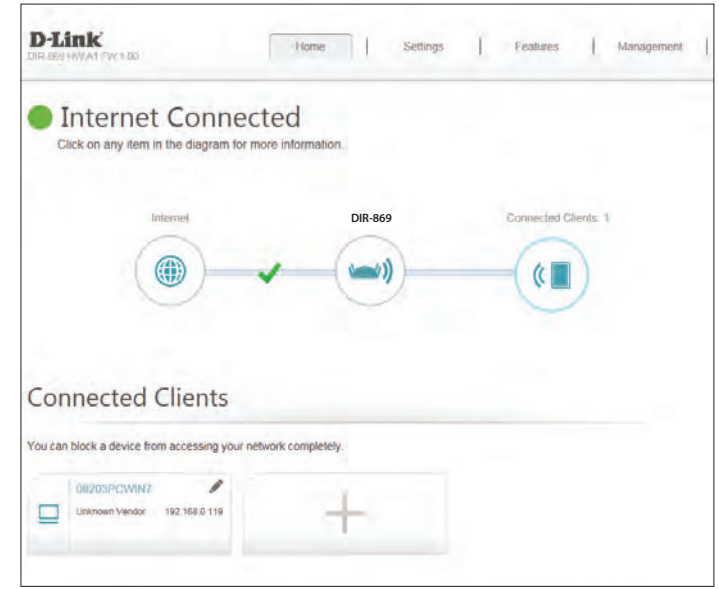

Name: Enter a custom name for this client.

Vendor: Displays the vendor of the device.

MAC Address: Displays the MAC address of the device.

IP Address: Displays the current IP address of this client.

Reserve IP: Enable to reserve this IP address for this client.

IP Address (Reserved): Specify an IP address for the DIR-869's DHCP server to assign.

Parental Control: Allow or Block access to the router.

Click **Save** when you are done.

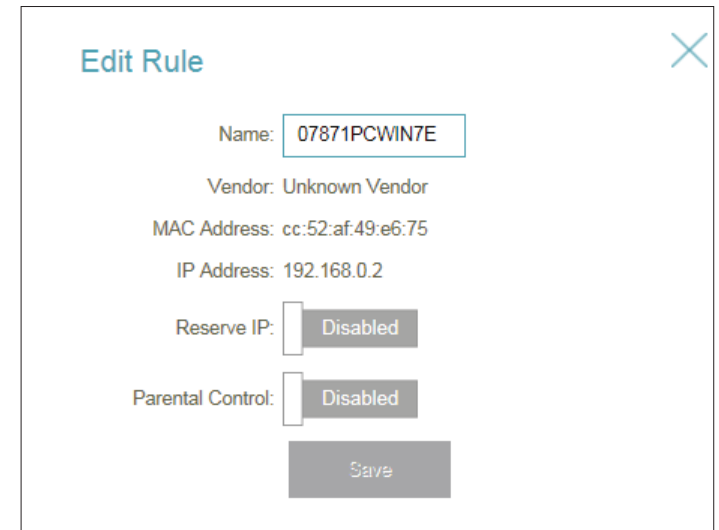

Settings Wizard

In the Settings menu on the bar on the top of the page, click **Wizard** to open the setup wizard. This is the same wizard that appears when you start the router for the first time. Refer to page 24 for details.

Internet

In the Settings menu on the bar on the top of the page, click **Internet** to see the Internet configuration options.

My Internet Connection Is: Choose your Internet connection type from the drop-down menu. You will be presented with the appropriate options for your connection type. Click **Advanced Settings...** to expand the list and see all of the options.

For **Dynamic IP (DHCP)** refer to page 33.

For **Static IP** refer to page 34.

For **PPPoE** refer to page 35.

For **PPTP** refer to page 37.

For **L2TP** refer to page 39.

For **DS-Lite** refer to page 41.

To configure an IPv6 connection, click the **IPv6** link. Refer to page 42.



Dynamic IP (DCHP)

Select **Dynamic IP (DHCP)** to obtain IP address information automatically from your Internet Service Provider (ISP). Select this option if your ISP does not specify and IP address to use.

Advanced Settings

Host Name: The host name is optional but may be required by some ISPs. Leave it blank if you are not sure.

Primary DNS Server: Enter the primary DNS server IP address assigned by your ISP. This address is usually obtained automatically from your ISP.

Secondary DNS Server: Enter the secondary DNS server IP address assigned by your ISP. This address is usually obtained automatically from your ISP.

MTU: Maximum Transmission Unit - you may need to change the MTU for optimal performance with your ISP.

MAC Address Clone: The default MAC address is set to the Internet port's physical interface MAC address on the router. You can use the drop-down menu to replace the Internet port's MAC address with the MAC address of a connected client.

Click **Save** when you are done.

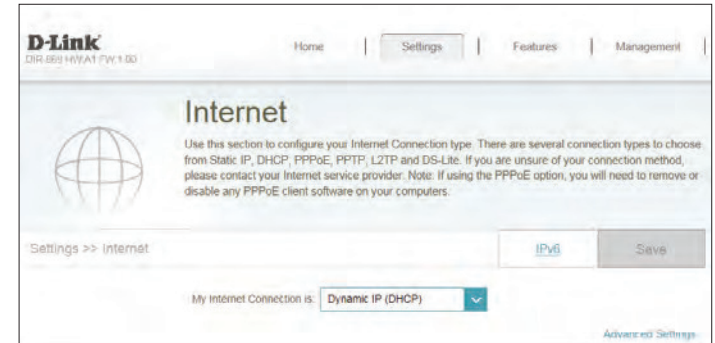

Host Name:	<input type="text" value="dlinkrouter"/>
Primary DNS Server:	<input type="text"/>
Secondary DNS Server:	<input type="text"/>
MTU:	<input type="text" value="Auto"/>
Mac Address Clone:	<input type="text"/> << MAC Address <input type="text"/>

Static IP

Select **Static IP** if your IP information is provided by your Internet Service Provider (ISP).

IP Address: Enter the IP address provided by your ISP.

Subnet Mask: Enter the subnet mask provided by your ISP.

Default Gateway: Enter the default gateway address provided by your ISP.

Primary DNS Server: Enter the primary DNS server IP address assigned by your ISP.

Advanced Settings

Secondary DNS Server: Enter the secondary DNS server IP address assigned by your ISP.

MTU: Maximum Transmission Unit - you may need to change the MTU for optimal performance with your ISP.

MAC Address Clone: The default MAC address is set to the Internet port's physical interface MAC address on the router. You can use drop-down menu to replace the Internet port's MAC address with the MAC address of a connected client.

Click **Save** when you are done.

The screenshot shows the D-Link DIR-869 Internet Settings page. The 'My Internet Connection is' dropdown menu is set to 'Static IP'. Below this, there are input fields for 'IP Address', 'Subnet Mask', 'Default Gateway', and 'Primary DNS Server'. A 'Save' button is visible in the top right corner of the settings area.

The screenshot shows the 'Advanced Settings' section of the D-Link Internet Settings page. It includes input fields for 'Secondary DNS Server', 'MTU' (set to 'Auto'), and 'Mac Address Clone' (set to '<< MAC Address').

PPPoE

Select **PPPoE** if your Internet connection requires you to enter a username and password. This information is provided by your Internet Service Provider (ISP).

Username: Enter the username provided by your ISP.

Password: Enter the password provided by your ISP.

Reconnect Mode: Select either **Always-on**, **On-Demand**, or **Manual**.

Maximum Idle Time: Enter a maximum idle time during which the Internet connection is maintained during inactivity. To disable this feature, enable Auto-reconnect.

Advanced Settings

Address Mode: Select **Static IP** if your ISP assigned you the IP address, subnet mask, gateway, and DNS server addresses. In most cases, select **Dynamic IP**.

Dynamic IP

IP Address: Enter the IP address provided by your ISP (Static IP only).

Service Name: Enter the ISP service name (optional).

Primary DNS Server: Enter the primary DNS server IP address assigned by your ISP.

Secondary DNS Server: Enter the secondary DNS server IP address assigned by your ISP.

MTU: Maximum Transmission Unit - you may need to change the MTU for optimal performance with your ISP. The recommended setting is **Auto**.

The screenshot shows the 'Internet' configuration page in the D-Link web interface. The 'My Internet Connection is' dropdown is set to 'PPPoE'. Below it are input fields for 'Username' and 'Password'. The 'Reconnect Mode' dropdown is set to 'On demand', and the 'Maximum Idle Time' is set to '5 minutes'. There are 'IPv6' and 'Save' buttons. A note at the top explains that PPPoE requires client software on computers.

The screenshot shows the 'Advanced Settings' section of the Internet configuration page. The 'Address Mode' dropdown is set to 'Dynamic IP'. There are input fields for 'Service Name', 'Primary DNS Server', and 'Secondary DNS Server'. The 'MTU' dropdown is set to 'Auto'. There is a 'Mac Address Clone' field with a dropdown menu set to '<< MAC Address'.

MAC Address Clone: The default MAC address is set to the Internet port's physical interface MAC address on the router. You can use the drop-down menu to replace the Internet port's MAC address with the MAC address of a connected client.

Static IP

IP Address: Enter the IP address provided by your ISP (Static IP only).

Service Name: Enter the ISP service name (optional).

Primary DNS Server: Enter the primary DNS server IP address assigned by your ISP.

Secondary DNS Server: Enter the secondary DNS server IP address assigned by your ISP.

MTU: Maximum Transmission Unit - you may need to change the MTU for optimal performance with your ISP.

MAC Address Clone: The default MAC address is set to the Internet port's physical interface MAC address on the router. You can use the drop-down menu to replace the Internet port's MAC address with the MAC address of a connected client.

Click **Save** when you are done.

The screenshot shows a configuration form for Static IP. The fields are: Address Mode (dropdown menu set to 'Static IP'), IP Address (text input), Service Name (text input), Primary DNS Server (text input), Secondary DNS Server (text input), MTU (dropdown menu set to 'Auto'), and Mac Address Clone (text input with a dropdown menu set to '<< MAC Address').

PPTP

Choose **PPTP** (Point-to-Point-Tunneling Protocol) if your Internet Service Provider (ISP) uses a PPTP connection. Your ISP will provide you with a username and password.

PPTP Server IP Address: Enter the PPTP server IP address provided by your ISP.

Username: Enter the username provided by your ISP.

Password: Enter the password provided by your ISP.

Reconnect Mode: Select either **Always-on**, **On-Demand**, or **Manual**.

Maximum Idle Time: Enter a maximum idle time during which the Internet connection is maintained during inactivity. To disable this feature, enable Auto-reconnect.

Advanced Settings

Address Mode: Select **Static IP** if your ISP assigned you the IP address, subnet mask, gateway, and DNS server addresses. In most cases, select **Dynamic IP**.

Dynamic IP

Primary DNS Server: Enter the primary DNS server IP address assigned by your ISP.

Secondary DNS Server: Enter the secondary DNS server IP address assigned by your ISP.

MTU: Maximum Transmission Unit - you may need to change the MTU for optimal performance with your ISP. The recommended setting is **Auto**.

The screenshot shows the 'Internet' configuration page in the D-Link DIR-869 web interface. The page title is 'Internet' and it includes a navigation menu with 'Home', 'Settings', 'Features', and 'Management'. Below the title, there is a globe icon and a note: 'Use this section to configure your Internet Connection type. There are several connection types to choose from: Static IP, DHCP, PPPoE, PPTP, L2TP and DS-Lite. If you are unsure of your connection method, please contact your Internet service provider. Note: If using the PPPoE option, you will need to remove or disable any PPPoE client software on your computers.' The main configuration area is titled 'Settings >> Internet' and includes a 'Save' button. The 'My Internet Connection is:' dropdown is set to 'PPTP'. Below this, there are input fields for 'PPTP Server IP Address:', 'Username:', and 'Password:'. The 'Reconnect Mode:' dropdown is set to 'On demand', and the 'Maximum Idle Time:' is set to '5 minutes'. There is an 'Advanced Settings' link at the bottom right.

The screenshot shows the 'Advanced Settings' section for the Internet configuration. It includes the following fields: 'Address Mode:' set to 'Dynamic IP', 'Primary DNS Server:', 'Secondary DNS Server:', and 'MTU:' set to 'Auto'.

Static IP

PPTP IP Address: Enter the IP address provided by your ISP (Static IP only).

PPTP Subnet Mask: Enter the subnet mask provided by your ISP (Static IP only).

PPTP Gateway IP Address: Enter the gateway IP address provided by your ISP (Static IP only).

Primary DNS Server: Enter the primary DNS server IP address assigned by your ISP.

Secondary DNS Server: Enter the secondary DNS server IP address assigned by your ISP.

MTU: Maximum Transmission Unit - you may need to change the MTU for optimal performance with your ISP.

Click **Save** when you are done.

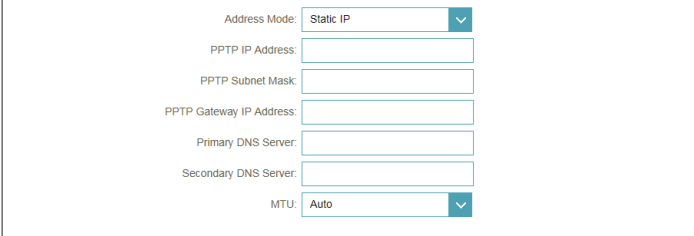

The screenshot shows a configuration form for Static IP. It includes the following fields and controls:

- Address Mode:** A dropdown menu with "Static IP" selected.
- PPTP IP Address:** An empty text input field.
- PPTP Subnet Mask:** An empty text input field.
- PPTP Gateway IP Address:** An empty text input field.
- Primary DNS Server:** An empty text input field.
- Secondary DNS Server:** An empty text input field.
- MTU:** A dropdown menu with "Auto" selected.

L2TP

Choose **L2TP** (Layer 2 Tunneling Protocol) if your Internet Service Provider (ISP) uses a L2TP connection. Your ISP will provide you with a username and password.

L2TP Server IP Address: Enter the L2TP server IP address provided by your ISP.

Username: Enter the username provided by your ISP.

Password: Enter the password provided by your ISP.

Reconnect Mode: Select either **Always-on**, **On-Demand**, or **Manual**.

Maximum Idle Time: Enter a maximum idle time during which the Internet connection is maintained during inactivity. To disable this feature, enable Auto-reconnect.

Advanced Settings

Address Mode: Select **Static IP** if your ISP assigned you the IP address, subnet mask, gateway, and DNS server addresses. In most cases, select **Dynamic IP**.

Dynamic IP

Primary DNS Server: Enter the primary DNS server IP address assigned by your ISP.

Secondary DNS Server: Enter the secondary DNS server IP address assigned by your ISP.

MTU: Maximum Transmission Unit - you may need to change the MTU for optimal performance with your ISP. The recommended setting is **Auto**.

The screenshot shows the 'Internet' configuration page in the D-Link web interface. The page title is 'Internet' and it includes a navigation bar with 'Home', 'Settings', 'Features', and 'Management'. Below the title, there is a globe icon and a brief instruction: 'Use this section to configure your Internet Connection type. There are several connection types to choose from: Static IP, DHCP, PPPoE, PPTP, L2TP and DS-Lite. If you are unsure of your connection method, please contact your Internet service provider. Note: If using the PPPoE option, you will need to remove or disable any PPPoE client software on your computers.' The main configuration area is titled 'Settings >> Internet' and includes a 'Save' button. The 'My Internet Connection is:' dropdown is set to 'L2TP'. Below this, there are input fields for 'L2TP Server IP Address', 'Username', and 'Password'. The 'Reconnect Mode' dropdown is set to 'On demand', and the 'Maximum Idle Time' is set to '5 minutes'. An 'Advanced Settings' link is visible at the bottom right of this section.

This screenshot shows the 'Advanced Settings' section for the Internet configuration. It includes three dropdown menus: 'Address Mode' set to 'Dynamic IP', 'Primary DNS Server' (empty), and 'Secondary DNS Server' (empty). Below these is an 'MTU' dropdown set to 'Auto'.

Static IP

L2TP IP Address: Enter the IP address provided by your ISP (Static IP only).

L2TP Subnet Mask: Enter the subnet mask provided by your ISP (Static IP only).

L2TP Gateway IP Address: Enter the gateway IP address provided by your ISP (Static IP only).

Primary DNS Server: Enter the primary DNS server IP address assigned by your ISP.

Secondary DNS Server: Enter the secondary DNS server IP address assigned by your ISP.

MTU: Maximum Transmission Unit - you may need to change the MTU for optimal performance with your ISP.

Click **Save** when you are done.

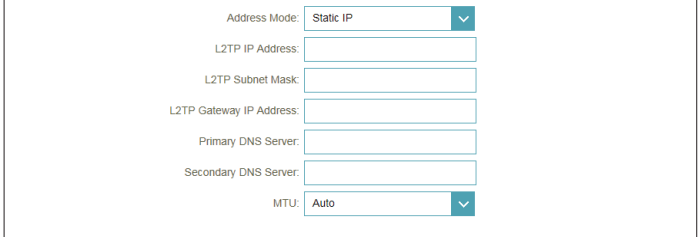

The screenshot shows a configuration form for Static IP. It includes the following fields and controls:

- Address Mode:** A dropdown menu with "Static IP" selected.
- L2TP IP Address:** An empty text input field.
- L2TP Subnet Mask:** An empty text input field.
- L2TP Gateway IP Address:** An empty text input field.
- Primary DNS Server:** An empty text input field.
- Secondary DNS Server:** An empty text input field.
- MTU:** A dropdown menu with "Auto" selected.

DS-Lite

DS-Lite is an IPv6 connection type. After selecting DS-Lite, the following parameters will be available for configuration:

Advanced Settings

DS-Lite Configuration: Select **DS-Lite DHCPv6** to let the router allocate the AFTR IPv6 address automatically. Select **Manual Configuration** to enter the AFTR IPv6 address manually.

DS-Lite DHCPv6

B4 IPv4 Address: Enter the B4 IPv4 address value used here.

WAN IPv6 Address: Once connected, the WAN IPv6 address will be displayed here.

IPv6 WAN Default Gateway: Once connected, the IPv6 WAN default gateway address will be displayed here.

Manual

AFTR IPv6 Address: Enter the AFTR IPv6 address used here.

B4 IPv4 Address: Enter the B4 IPv4 address value used here.

WAN IPv6 Address: Once connected, the WAN IPv6 address will be displayed here.

IPv6 WAN Default Gateway: Once connected, the IPv6 WAN default gateway address will be displayed here.

Click **Save** when you are done.

D-Link DIR-869 HW v1.00

Home | Settings | Features | Management

Internet

Use this section to configure your Internet Connection type. There are several connection types to choose from: Static IP, DHCP, PPPoE, PPTP, L2TP and DS-Lite. If you are unsure of your connection method, please contact your Internet service provider. Note: If using the PPPoE option, you will need to remove or disable any PPPoE client software on your computers.

Settings >> Internet

IPv6 Save

My Internet Connection is: **DS-Lite**

Advanced Settings

DS-Lite Configuration: **DS-Lite DHCPv6 Option**

B4 IPv4 Address: 192.0.0.0

WAN IPv6 Address: N/A

IPv6 WAN Default Gateway: N/A

DS-Lite Configuration: **Manual Configuration**

AFTR IPv6 Address:

B4 IPv4 Address: 192.0.0.0

WAN IPv6 Address: N/A

IPv6 WAN Default Gateway: N/A

IPv6

To configure an IPv6 connection, click the **IPv6** link. To return to the IPv4 settings, click **IPv4**.

My Internet Connection Is: Choose your IPv6 connection type from the drop-down menu. You will be presented with the appropriate options for your connection type. Click **Advanced Settings...** to expand the list and see all of the options.

For **Auto Detection** refer to page 43.

For **Static IPv6** refer to page 45.

For **Auto Configuration (SLAAC/DHCPv6)** refer to page 47.

For **PPPoE** refer to page 49.

For **IPv6 in IPv4 Tunnel** refer to page 52.

For **6 to 4** refer to page 54.

For **6rd** refer to page 56.

For **Local Connectivity Only** refer to page 58.

Auto Detection

This is a connection method where the ISP assigns your IPv6 address when your router requests one from the ISP's server. Some ISPs require you to make some settings on your side before your router can connect to the IPv6 Internet.

IPv6 DNS Settings

DNS Type: Select either **Obtain DNS server address automatically** or **Use the following DNS address**.

If **Use the following DNS address** is selected:

Primary DNS Server: If you selected **Use the following DNS address** above, enter the primary DNS server address.

Secondary DNS Server: If you selected **Use the following DNS address** above, enter the secondary DNS server address.

LAN IPv6 Address Settings

LAN IPv6 Address: Displays the router's LAN IPv6 Address link-local address.

LAN IPv6 Link-Local Address: Displays the router's LAN link-local address.

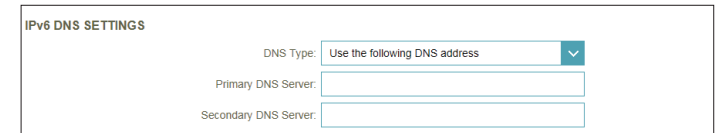
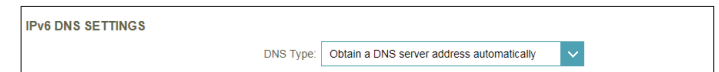
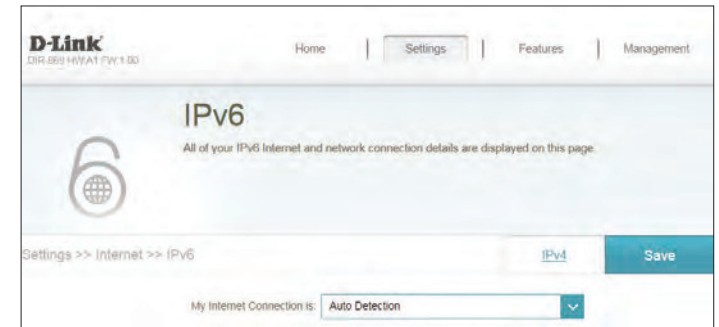

Advanced Settings - Address Autoconfiguration Settings

Enable Automatic IPv6 Address Assignment: Enable or disable the Automatic IPv6 Address Assignment feature.

Enable Automatic DHCP-PD in LAN: Enable or disable DHCP-PD for other IPv6 routers connected to the LAN interface.
Note: This feature requires a smaller subnet prefix than /64 (i.e. allowing for a larger address allocation), such as /63. Contact your ISP for more information.

Autoconfiguration Type: Select **SLAAC+RDNSS**, **SLAAC+Stateless DHCP**, or **Stateful DHCPv6**.

If you selected **Stateful DHCPv6** as the Autoconfiguration Type:

IPv6 Address Range (Start): Enter the starting IPv6 address for the DHCP server's IPv6 assignment.

IPv6 Address Range (End): Enter the ending IPv6 address for the DHCP server's IPv6 assignment.

Router Advertisement Lifetime: Enter the IPv6 address lifetime (in minutes).

Click **Save** when you are done.

ADDRESS AUTOCONFIGURATION SETTINGS

Enable Automatic IPv6 Address Assignment: Enabled

Enable Automatic DHCP-PD in LAN: Enabled

Autoconfiguration Type: SLAAC+RDNSS

Router Advertisement Lifetime: minutes

ADDRESS AUTOCONFIGURATION SETTINGS

Enable Automatic IPv6 Address Assignment: Enabled

Enable Automatic DHCP-PD in LAN: Enabled

Autoconfiguration Type: SLAAC+Stateless DHCP

Router Advertisement Lifetime: minutes

ADDRESS AUTOCONFIGURATION SETTINGS

Enable Automatic IPv6 Address Assignment: Enabled

Enable Automatic DHCP-PD in LAN: Enabled

Autoconfiguration Type: Stateful DHCPv6

IPv6 Address Range (Start): :00

IPv6 Address Range (End): :00

IPv6 Address Lifetime: minutes

Static IPv6

Select **Static IP** if your IPv6 information is provided by your Internet Service Provider (ISP).

Use Link-Local Address: Enable or disable link-local address use.

Default Gateway: Enter the default gateway for your IPv6 connection.

Primary DNS Server: Enter the primary DNS server address.

Secondary DNS Server: Enter the secondary DNS server address.

If **Use Link-Local Address** is disabled these additional parameters are available for configuration:

IPv6 Address: Enter the address supplied by your ISP.

Subnet Prefix Length: Enter the subnet prefix length supplied by your ISP.

LAN IPv6 Address Settings

LAN IPv6 Address: Enter the LAN (local) IPv6 address for the router.

LAN IPv6 Link-Local Address: Displays the router's LAN link-local address.

The screenshot shows the D-Link IPv6 configuration interface. At the top, there are navigation links for Home, Settings, Features, and Management. The main heading is 'IPv6' with a sub-heading: 'All of your IPv6 Internet and network connection details are displayed on this page'. Below this, there is a breadcrumb trail: 'Settings >> Internet >> IPv6'. A dropdown menu shows 'My Internet Connection is: Static IPv6'. A toggle switch for 'Use Link-Local Address' is set to 'Enabled'. Below this are input fields for 'Default Gateway', 'Primary DNS Server', and 'Secondary DNS Server'. A 'Save' button is visible on the right.

This screenshot shows the same configuration page but with 'Use Link-Local Address' set to 'Disabled'. In addition to the fields from the previous screenshot, there are now input fields for 'IPv6 Address', 'Subnet Prefix Length', 'Default Gateway', 'Primary DNS Server', and 'Secondary DNS Server'. The 'Save' button is still present.

This screenshot shows the 'LAN IPv6 ADDRESS SETTINGS' section. It contains an input field for 'LAN IPv6 Address' followed by '/64'. Below it, the text 'LAN IPv6 Link-Local Address: Not Available' is displayed. A link for 'Advanced Settings' is located at the bottom right of the section.

Advanced Settings - Address Autoconfiguration Settings

Enable Automatic IPv6 Address Assignment: Enable or disable the Automatic IPv6 Address Assignment feature.

Autoconfiguration Type: Select **SLAAC+RDNSS**, **SLAAC+Stateless DHCP**, or **Stateful DHCPv6**.

If you selected **Stateful DHCPv6** as the Autoconfiguration Type:

IPv6 Address Range (Start): Enter the starting IPv6 address for the DHCP server's IPv6 assignment.

IPv6 Address Range (End): Enter the ending IPv6 address for the DHCP server's IPv6 assignment.

Router Advertisement Lifetime: Enter the IPv6 address lifetime (in minutes).

Click **Save** when you are done.

ADDRESS AUTOCONFIGURATION SETTINGS

Enable Automatic IPv6 Address Assignment: Enabled

Autoconfiguration Type: SLAAC+RDNSS

Router Advertisement Lifetime: 60 minutes

ADDRESS AUTOCONFIGURATION SETTINGS

Enable Automatic IPv6 Address Assignment: Enabled

Autoconfiguration Type: SLAAC+Stateless DHCP

Router Advertisement Lifetime: 60 minutes

ADDRESS AUTOCONFIGURATION SETTINGS

Enable Automatic IPv6 Address Assignment: Enabled

Autoconfiguration Type: Stateful DHCPv6

IPv6 Address Range (Start): xxxx::00 3

IPv6 Address Range (End): xxxx::00 16

IPv6 Address Lifetime: 60 minutes

Auto Configuration (SLAAC/DHCPv6)

This is a connection method where the ISP assigns your IPv6 address when your router requests one from the ISP's server. Some ISPs require you to make some settings on your side before your router can connect to the IPv6 Internet.

IPv6 DNS Settings

DNS Type: Select either **Obtain DNS server address automatically** or **Use the following DNS address**.

If **Use the following DNS address** is selected:

Primary DNS Server: Enter the primary DNS server address.

Secondary DNS Server: Enter the secondary DNS server address.

LAN IPv6 Address Settings

Enable DHCP-PD: Enable or disable prefix delegation services.

LAN IPv6 Address: If you disabled DHCP-PD, enter the LAN (local) IPv6 address for the router.

LAN IPv6 Link-Local Address: Displays the router's LAN link-local address.

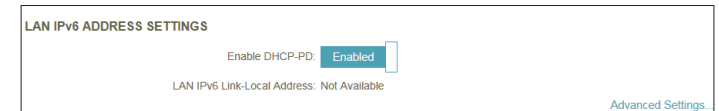
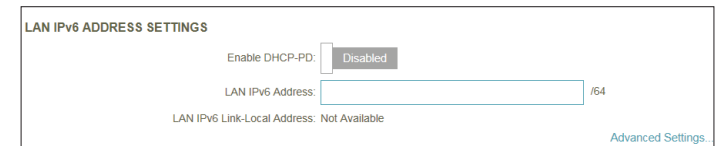
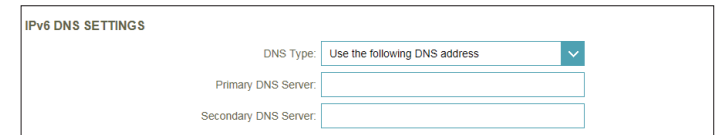
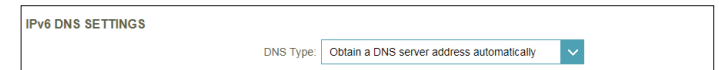
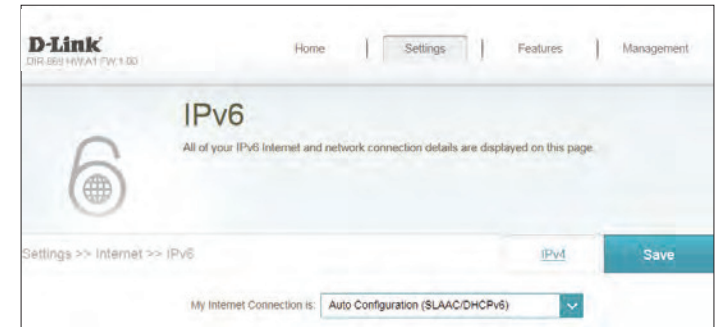

Advanced Settings - Address Autoconfiguration Settings

Enable Automatic IPv6 Address Assignment: Enable or disable the Automatic IPv6 Address Assignment feature.

If DHCP-PD is enabled in LAN IPv6 Address Settings:

Enable Automatic DHCP-PD in LAN: Enable or disable DHCP-PD for other IPv6 routers connected to the LAN interface. **Note:** *This feature requires a smaller subnet prefix than /64 (i.e. allowing for a larger address allocation), such as /63. Contact your ISP for more information.*

Autoconfiguration Type: Select **SLAAC+RDNSS**, **SLAAC+Stateless DHCP**, or **Stateful DHCPv6**.

If you selected **Stateful DHCPv6** as the Autoconfiguration Type:

IPv6 Address Range (Start): Enter the starting IPv6 address for the DHCP server's IPv6 assignment.

IPv6 Address Range (End): Enter the ending IPv6 address for the DHCP server's IPv6 assignment.

Router Advertisement Lifetime: Enter the IPv6 address lifetime (in minutes).

Click **Save** when you are done.

ADDRESS AUTOCONFIGURATION SETTINGS

Enable Automatic IPv6 Address Assignment: Enabled

Enable Automatic DHCP-PD in LAN: Enabled

Autoconfiguration Type: SLAAC+Stateless DHCP

Router Advertisement Lifetime: minutes

ADDRESS AUTOCONFIGURATION SETTINGS

Enable Automatic IPv6 Address Assignment: Enabled

Enable Automatic DHCP-PD in LAN: Enabled

Autoconfiguration Type: SLAAC+RDNSS

Router Advertisement Lifetime: minutes

ADDRESS AUTOCONFIGURATION SETTINGS

Enable Automatic IPv6 Address Assignment: Enabled

Enable Automatic DHCP-PD in LAN: Enabled

Autoconfiguration Type: Stateful DHCPv6

IPv6 Address Range (Start): xxxx::00

IPv6 Address Range (End): xxxx::00

IPv6 Address Lifetime: minutes

PPPoE

Select **PPPoE** if your Internet connection requires you to enter a username and password. This information is provided by your Internet Service Provider (ISP).

PPPoE Session: Choose **Share with IPv4** to re-use your IPv4 PPPoE username and password, or **Create a new session**.

Username: Enter the username provided by your ISP. (Create a new session only)

Password: Enter the password provided by your ISP. (Create a new session only)

Address Mode: Select **Static IP** if your ISP assigned you an IP address. In most cases, select **Dynamic IP**.

IP Address: Enter the IP address provided by your ISP. (Static IP only)

Service Name: Enter the ISP service name (optional).

Reconnect Mode: Select either **Always-on** or **Manual**.

MTU: Maximum Transmission Unit - you may need to change the MTU for optimal performance with your ISP.

Address Mode:

IP Address:

PPPoE Session:

Username:

Password:

Address Mode:

Service Name:

Reconnect Mode:

MTU: bytes

Address Mode:

IP Address:

Service Name:

Reconnect Mode:

MTU: bytes

IPv6 DNS Settings

DNS Type: Select either **Obtain DNS server address automatically** or **Use the following DNS address**.

If **Use the following DNS address** is selected:

Primary DNS Server: Enter the primary DNS server address.

Secondary DNS Server: Enter the secondary DNS server address.

LAN IPv6 Address Settings

Enable DHCP-PD: Enable or disable prefix delegation services. Dynamic IP only

LAN IPv6 Address: If DHCP-PD disabled or static address mode is selected, enter the LAN (local) IPv6 address for the router.

LAN IPv6 Link-Local Address: Displays the router's LAN link-local address.

IPv6 DNS SETTINGS

DNS Type: Obtain a DNS server address automatically

IPv6 DNS SETTINGS

DNS Type: Use the following DNS address

Primary DNS Server:

Secondary DNS Server:

LAN IPv6 ADDRESS SETTINGS

Enable DHCP-PD: Enabled

LAN IPv6 Link-Local Address: Not Available

[Advanced Settings...](#)

LAN IPv6 ADDRESS SETTINGS

Enable DHCP-PD: Disabled

LAN IPv6 Address: /64

LAN IPv6 Link-Local Address: Not Available

[Advanced Settings...](#)

Advanced Settings - Address Autoconfiguration Settings

Enable Automatic IPv6 Address Assignment: Enable or disable the Automatic IPv6 Address Assignment feature.

If **DHCP-PD** is available and enabled in LAN IPv6 Address Settings:

Enable Automatic DHCP-PD in LAN: Enable or disable DHCP-PD for other IPv6 routers connected to the LAN interface. **Note:** This feature requires a smaller subnet prefix than /64 (i.e. allowing for a larger address allocation), such as /63. Contact your ISP for more information.

Autoconfiguration Type: Select **SLAAC+RDNSS**, **SLAAC+Stateless DHCP**, or **Stateful DHCPv6**.

If you selected **Stateful DHCPv6** as the Autoconfiguration Type:

IPv6 Address Range (Start): Enter the starting IPv6 address for the DHCP server's IPv6 assignment.

IPv6 Address Range (End): Enter the ending IPv6 address for the DHCP server's IPv6 assignment.

Router Advertisement Lifetime: Enter the IPv6 address lifetime (in minutes).

Click **Save** when you are done.

ADDRESS AUTOCONFIGURATION SETTINGS

Enable Automatic IPv6 Address Assignment: Enabled

Enable Automatic DHCP-PD in LAN: Enabled

Autoconfiguration Type: SLAAC+Stateless DHCP

Router Advertisement Lifetime: 0 minutes

ADDRESS AUTOCONFIGURATION SETTINGS

Enable Automatic IPv6 Address Assignment: Enabled

Enable Automatic DHCP-PD in LAN: Enabled

Autoconfiguration Type: SLAAC+RDNSS

Router Advertisement Lifetime: 0 minutes

ADDRESS AUTOCONFIGURATION SETTINGS

Enable Automatic IPv6 Address Assignment: Enabled

Enable Automatic DHCP-PD in LAN: Enabled

Autoconfiguration Type: Stateful DHCPv6

IPv6 Address Range (Start): xxxx::00 3

IPv6 Address Range (End): xxxx::00 16

IPv6 Address Lifetime: 0 minutes

IPv6 in IPv4 Tunnel

The user can configure the IPv6 connection to run in IPv4 Tunnel mode. IPv6 over IPv4 tunnelling encapsulates IPv6 packets in IPv4 packets so that IPv6 packets can be sent over an IPv4 infrastructure.

Remote IPv4 Address: Enter the IPv4 remote address you will use.

Remote IPv6 Address: Enter the IPv6 remote address you will use.

Local IPv4 Address: Displays the current local IPv4 address.

Local IPv6 Address: Enter the IPv6 local address you will use.

Subnet Prefix Length: Enter the subnet prefix length supplied by your ISP.

IPv6 DNS Settings

DNS Type: Select either **Obtain DNS server address automatically** or **Use the following DNS address**.

If **Use the following DNS address** is selected:

Primary DNS Server: Enter the primary DNS server address.

Secondary DNS Server: Enter the secondary DNS server address.

The screenshot shows the D-Link IPv6 configuration interface. At the top, there are navigation links for Home, Settings, Features, and Management. The main heading is 'IPv6' with a sub-note: 'All of your IPv6 Internet and network connection details are displayed on this page.' Below this, the breadcrumb trail is 'Settings >> Internet >> IPv6'. A 'Save' button is visible on the right. The main configuration area is titled 'My Internet Connection is' and is set to 'IPv6 in IPv4 tunnel'. Below this, there are input fields for 'Remote IPv4 Address', 'Remote IPv6 Address', 'Local IPv4 Address' (pre-filled with '192.168.150.132'), 'Local IPv6 Address', and 'Subnet Prefix Length'.

This screenshot shows the 'IPv6 DNS SETTINGS' section. The 'DNS Type' dropdown menu is set to 'Obtain a DNS server address automatically'.

This screenshot shows the 'IPv6 DNS SETTINGS' section with the 'DNS Type' dropdown menu set to 'Use the following DNS address'. Below this, there are input fields for 'Primary DNS Server' and 'Secondary DNS Server'.

LAN IPv6 Address Settings

Enable DHCP-PD: Enable or disable prefix delegation services.

LAN IPv6 Address: If you disabled DHCP-PD, enter the LAN (local) IPv6 address for the router.

LAN IPv6 Link-Local Address: Displays the router's LAN link-local address.

Advanced Settings - Address Autoconfiguration Settings

Enable Automatic IPv6 Address Assignment: Enable or disable the Automatic IPv6 Address Assignment feature.

Autoconfiguration Type: Select **SLAAC+RDNSS**, **SLAAC+Stateless DHCP**, or **Stateful DHCPv6**.

If you selected **Stateful DHCPv6** as the Autoconfiguration Type:

IPv6 Address Range (Start): Enter the starting IPv6 address for the DHCP server's IPv6 assignment.

IPv6 Address Range (End): Enter the ending IPv6 address for the DHCP server's IPv6 assignment.

Router Advertisement Lifetime: Enter the IPv6 address lifetime (in minutes).

Click **Save** when you are done.

LAN IPv6 ADDRESS SETTINGS

Enable DHCP-PD: Enabled

LAN IPv6 Link-Local Address: Not Available

[Advanced Settings](#)

LAN IPv6 ADDRESS SETTINGS

Enable DHCP-PD: Disabled

LAN IPv6 Address:

LAN IPv6 Link-Local Address: Not Available

[Advanced Settings](#)

ADDRESS AUTOCONFIGURATION SETTINGS

Enable Automatic IPv6 Address Assignment: Enabled

Enable Automatic DHCP-PD in LAN: Enabled

Autoconfiguration Type: ▼

Router Advertisement Lifetime: minutes

ADDRESS AUTOCONFIGURATION SETTINGS

Enable Automatic IPv6 Address Assignment: Enabled

Enable Automatic DHCP-PD in LAN: Enabled

Autoconfiguration Type: ▼

Router Advertisement Lifetime: minutes

ADDRESS AUTOCONFIGURATION SETTINGS

Enable Automatic IPv6 Address Assignment: Enabled

Enable Automatic DHCP-PD in LAN: Enabled

Autoconfiguration Type: ▼

IPv6 Address Range (Start): xxxx :00

IPv6 Address Range (End): xxxx :00

IPv6 Address Lifetime: minutes

6to4

In this section the user can configure the IPv6 6 to 4 connection settings. 6to4 is an IPv6 address assignment and automatic tunnelling technology that is used to provide unicast IPv6 connectivity between IPv6 sites and hosts across the IPv4 Internet.

6to4 Address: Displays the 6 to 4 address.

6to4 Relay: Enter the 6 to 4 relay supplied by your ISP.

Primary DNS Server: Enter the primary DNS server address.

Secondary DNS Server: Enter the secondary DNS server address.

LAN IPv6 Address Settings

LAN IPv6 Address: Enter the LAN (local) IPv6 address for the router.

LAN IPv6 Link-Local Address: Displays the router's LAN link-local address.

The screenshot shows the D-Link IPv6 configuration interface. At the top, there is a navigation bar with 'Home', 'Settings', 'Features', and 'Management'. Below this, the 'IPv6' section is displayed, with a sub-header 'All of your IPv6 Internet and network connection details are displayed on this page.' The main configuration area is titled 'Settings >> Internet >> IPv6' and includes a 'Save' button. The 'My Internet Connection is' dropdown menu is set to '6to4'. Below this, the '6to4 Address' is shown as '192.168.150.132'. The '6to4 Relay' field contains '192.88.99.1'. There are empty input fields for 'Primary DNS Server' and 'Secondary DNS Server'. At the bottom, the 'LAN IPv6 ADDRESS SETTINGS' section shows 'LAN IPv6 Address: FFFF:FFFF:FFFF: [] :1:64' and 'LAN IPv6 Link-Local Address: Not Available'. An 'Advanced Settings' link is located at the bottom right.

Advanced Settings - Address Autoconfiguration Settings

Enable Automatic IPv6 Address Assignment: Enable or disable the Automatic IPv6 Address Assignment feature.

Autoconfiguration Type: Select **SLAAC+RDNSS**, **SLAAC+Stateless DHCP**, or **Stateful DHCPv6**.

If you selected **Stateful DHCPv6** as the Autoconfiguration Type:

IPv6 Address Range (Start): Enter the starting IPv6 address for the DHCP server's IPv6 assignment.

IPv6 Address Range (End): Enter the ending IPv6 address for the DHCP server's IPv6 assignment.

Router Advertisement Lifetime: Enter the IPv6 address lifetime (in minutes).

Click **Save** when you are done.

ADDRESS AUTOCONFIGURATION SETTINGS

Enable Automatic IPv6 Address Assignment: Enabled

Enable Automatic DHCP-PD in LAN: Enabled

Autoconfiguration Type: SLAAC+Stateless DHCP

Router Advertisement Lifetime: minutes

ADDRESS AUTOCONFIGURATION SETTINGS

Enable Automatic IPv6 Address Assignment: Enabled

Enable Automatic DHCP-PD in LAN: Enabled

Autoconfiguration Type: SLAAC+RDNSS

Router Advertisement Lifetime: minutes

ADDRESS AUTOCONFIGURATION SETTINGS

Enable Automatic IPv6 Address Assignment: Enabled

Enable Automatic DHCP-PD in LAN: Enabled

Autoconfiguration Type: Stateful DHCPv6

IPv6 Address Range (Start): xxxx::00

IPv6 Address Range (End): xxxx::00

IPv6 Address Lifetime: minutes

6rd

In this section the user can configure the IPv6 6rd connection settings.

Assign IPv6 Prefix: Currently unsupported.

Primary DNS Server: Enter the primary DNS server address.

Secondary DNS Server: Enter the secondary DNS server address.

6rd Manual Configuration

Enable Hub and Spoke Mode: Enable if you want to minimize the number of routes to the destination by using a hub and spoke method of networking.

6rd Configuration: Choose the **6rd DHCPv4 Option** to automatically discover and populate the data values, or **Manual Configuration** to enter the settings yourself.

If you selected **Manual configuration**

6rd IPv6 Prefix: Enter the 6rd IPv6 prefix and mask length supplied by your ISP.

WAN IPv4 Address Displays the router's IPv4 address.

6rd Border Relay IPv4 Address: Enter the 6rd border relay IPv4 address settings supplied by your ISP.

LAN IPv6 Address Settings

LAN IPv6 Address: Displays the router's LAN IPv6 Address link-local address.

LAN IPv6 Link-Local Address: Displays the router's LAN link-local address.

The screenshot shows the D-Link IPv6 configuration interface. At the top, there are navigation links for Home, Settings, Features, and Management. The main heading is 'IPv6' with a sub-heading: 'All of your IPv6 internet and network connection details are displayed on this page.' Below this, there's a breadcrumb trail: 'Settings >> Internet >> IPv6'. A 'Save' button is visible. The 'My Internet Connection is:' dropdown is set to '6rd'. There are input fields for 'Assign IPv6 Prefix', 'Primary DNS Server', and 'Secondary DNS Server'. The '6RD MANUAL CONFIGURATION' section has 'Enable Hub and Spoke Mode' set to 'Enabled' and '6rd Configuration' set to '6rd DHCPv4 Option'.

This is a close-up of the '6RD MANUAL CONFIGURATION' section. It shows 'Enable Hub and Spoke Mode' as a toggle switch set to 'Enabled'. Below it, the '6rd Configuration' dropdown menu is set to '6rd DHCPv4 Option'.

This is another close-up of the '6RD MANUAL CONFIGURATION' section. Here, '6rd Configuration' is set to 'Manual Configuration'. Below this, there are input fields for '6rd IPv6 Prefix' (with a mask length of 32), 'WAN IPv4 Address' (with a default of 192.168.1.50/16), and '6rd Border Relay IPv4 Address'.

This screenshot shows the 'LAN IPv6 ADDRESS SETTINGS' section. It displays two status messages: 'LAN IPv6 Address: Not Available' and 'LAN IPv6 Link-Local Address: Not Available'. There is a link for 'Advanced Settings' at the bottom right.

Advanced Settings - Address Autoconfiguration Settings

Enable Automatic IPv6 Address Assignment: Enable or disable the Automatic IPv6 Address Assignment feature.

Autoconfiguration Type: Select **SLAAC+RDNSS**, **SLAAC+Stateless DHCP**, or **Stateful DHCPv6**.

If you selected **Stateful DHCPv6** as the Autoconfiguration Type:

IPv6 Address Range (Start): Enter the starting IPv6 address for the DHCP server's IPv6 assignment.

IPv6 Address Range (End): Enter the ending IPv6 address for the DHCP server's IPv6 assignment.

Router Advertisement Lifetime: Enter the IPv6 address lifetime (in minutes).

Click **Save** when you are done.

ADDRESS AUTOCONFIGURATION SETTINGS

Enable Automatic IPv6 Address Assignment: Enabled

Autoconfiguration Type: SLAAC+RDNSS

Router Advertisement Lifetime: 60 minutes

ADDRESS AUTOCONFIGURATION SETTINGS

Enable Automatic IPv6 Address Assignment: Enabled

Autoconfiguration Type: SLAAC+Stateless DHCP

Router Advertisement Lifetime: 60 minutes

ADDRESS AUTOCONFIGURATION SETTINGS

Enable Automatic IPv6 Address Assignment: Enabled

Autoconfiguration Type: Stateful DHCPv6

IPv6 Address Range (Start): xxxx::00 3

IPv6 Address Range (End): xxxx::00 16

IPv6 Address Lifetime: 60 minutes

Local Connectivity Only

Local Connectivity Only allows you to set up an IPv6 connection that will not connect to the Internet.

Advanced Settings

IPv6 ULA Settings

Enable ULA: Click here to enable Unique Local IPv6 Unicast Addresses settings.

If you selected **Enable ULA** and **Disabled Default ULA Prefix:**

ULA Prefix: Enter your own ULA prefix.

Current IPv6 ULA Settings

Current ULA Prefix: Displays the current ULA prefix.

LAN IPv6 ULA: Displays the LAN's IPv ULA.

Click **Save** when you are done.

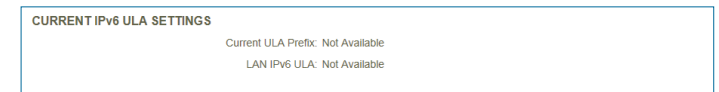
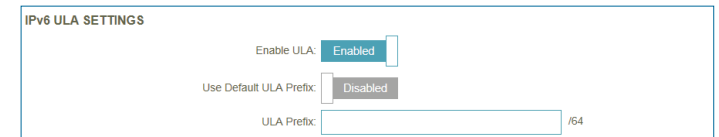
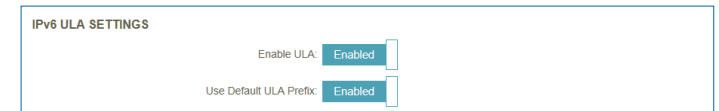

Wireless

From this page you can configure your wireless network settings.

2.4GHz

Status: Enable or disable the 2.4GHz wireless network.

Wi-Fi Name (SSID): Create a name for your wireless network using up to 32 characters.

Password: Create a password to use for wireless security.

Advanced Settings

Security Mode: Choose **None**, **WEP**, or **WPA/WPA2-(Personal)** (recommended).

802.11 Mode: Select the desired wireless networking standards to use. The available options are **Mixed 802.11b/g/n**, **Mixed 802.11g/n**, **802.11n only**.

Wi-Fi Channel: Select the desired channel. The default is **Auto** (recommended).

Transmission Power: Select the desired wireless transmission power.

Channel Width: Select **Auto 20/40** if you are using both 802.11n and non-802.11n devices, or select **20 MHz** if you are not using any 802.11n devices.

HT20/40 Coexistence: Enable or disable HT20/40 Coexistence.

Visibility Status: The default setting is **Visible**. Select **Invisible** if you do not want to broadcast the SSID of your wireless network.

Schedule: Use the drop-down menu to select the time schedule that the rule will be enabled on. The schedule may be set to **Always Enable**, or you can create your own schedules in the **Schedules** section. Refer to page 76 for more information.

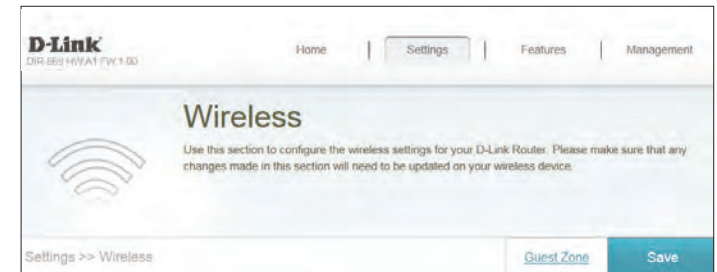

2.4GHz

Status: Enabled

Wi-Fi Name (SSID):

Password:

[Advanced Settings...](#)

Security Mode:

802.11 Mode:

Wi-Fi Channel:

Transmission Power:

Channel Width:

HT20/40 Coexistence: Enabled

Visibility Status:

Schedule:

5GHz

Status: Enable or disable the 2.4GHz wireless network.

Wi-Fi Name (SSID): Create a name for your wireless network using up to 32 characters.

Password: Create a password to use for wireless security.

Advanced Settings

Security Mode: Choose **None**, **WEP**, or **WPA/WPA2-(Personal)** (recommended).

802.11 Mode: Select the desired wireless networking standards to use. The available options are **Mixed 802.11a/n/ac**, **Mixed 802.11n/ac**, **802.11ac only**, **Mixed 802.11a/n**, **Mixed 802.11n only**, or **802.11a only**

Wi-Fi Channel: Select the desired channel. The default is **Auto** (recommended).

Transmission Power: Select the desired wireless transmission power.

Channel Width: These options will change depending upon the selected 802.11 Mode. Select **Auto 20/40/80** if you are using 802.11ac, 802.11n, and 802.11a devices, select **Auto 20/40** if you are using 802.11n and 802.11a devices, or select **20 MHz** if you are only using 802.11a devices.

Visibility Status: The default setting is **Visible**. Select **Invisible** if you do not want to broadcast the SSID of your wireless network.

Schedule: Use the drop-down menu to select the time schedule that the rule will be enabled on. The schedule may be set to **Always Enable**, or you can create your own schedules in the **Schedules** section. Refer to page 76 for more information.

Click **Save** when you are done.

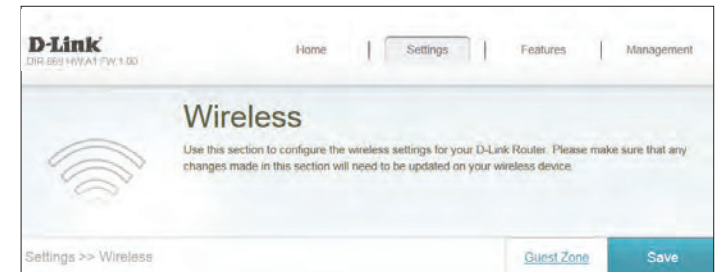

5GHz	
Status:	<input checked="" type="checkbox"/> Enabled
Wi-Fi Name (SSID):	<input type="text" value="dlink-1654-5GHz"/>
Password:	<input type="text" value="abcde12345"/>
Advanced Settings	
Security Mode:	<input type="text" value="WPA/WPA2-Personal"/>
802.11 Mode:	<input type="text" value="Mixed 802.11a/n/ac"/>
Wi-Fi Channel:	<input type="text" value="Auto"/>
Transmission Power:	<input type="text" value="High"/>
Channel Width:	<input type="text" value="Auto 20/40/80 MHz"/>
Visibility Status:	<input type="text" value="Visible"/>
Schedule:	<input type="text" value="Always Enable"/>

Guest Zone

The guest zone feature will allow you to create temporary zones that can be used by guests to access the Internet. These zones will be separate from your main wireless network. You may configure different zones for the 2.4 GHz and 5 GHz wireless bands.

In the Settings menu on the bar on the top of the page, click **Wireless**, then click the **Guest Zone** link. Click **Advanced Settings...** to expand the list and see all of the options. The following options apply to both the 2.4 GHz and the 5 GHz wireless frequency bands:

Status: Enable or disable the guest zone for each wireless frequency band.

Wi-Fi Name (SSID): Enter a wireless network name (SSID) that is different from your main wireless network.

Password: Create a password to use for wireless security. Wireless clients will need to enter this password to successfully connect to the guest zone.

Home Network Access

Internet Access Only: Enabling this option will confine connectivity to the Internet, disallowing guests from accessing other local network devices.

Click **Save** when you are done.

The screenshot shows the D-Link DIR-869 WebUI interface for configuring the Guest Zone. The page title is "Guest Zone" and it includes a navigation bar with "Home", "Settings", "Features", and "Management". A breadcrumb trail shows "Settings >> Wireless >> Guest Zone". The main content area has a "Status" dropdown set to "Enabled", a "Wi-Fi Name (SSID)" field containing "dlink-guest", and a "Password" field. Below this is a "Home Network Access" section with an "Internet Access Only" dropdown set to "Enabled". A "Save" button is located in the top right corner.

Network

This section will allow you to change the local network settings of the router and to configure the DHCP settings. In the Settings menu on the bar on the top of the page, click **Network**. Click **Advanced Settings...** to expand the list and see all of the options.

Network Settings

LAN IP Address: Enter the IP address of the router. The default IP address is **192.168.0.1**. If you change the IP address, once you click **Save**, you will need to enter the new IP address in your browser to get back into the configuration utility

Subnet Mask: Enter the subnet mask of the router. The default subnet mask is **255.255.255.0**.

Management Link: The default address to access the router's configuration is **http://dlinkrouter.local/**. Here, you can replace **dlinkrouter** with a name of your choice.

Local Domain Name: Enter the domain name (optional).

Enable DNS Relay: Disable to transfer the DNS server information from your ISP to your computers. If enabled, your computers will use the router for a DNS server.

The screenshot shows the D-Link Network Settings page. At the top, there is a navigation bar with 'Home', 'Settings', 'Features', and 'Management'. The 'Settings' menu is selected. Below the navigation bar, the page title is 'Network'. A small icon of a computer monitor is shown next to the title. Below the icon, there is a brief instruction: 'Use this section to configure the network settings for your device. You can enter a name for your device in the management link field, and use the link to access web UI in a web browser. Recommend to change the management link if there are more than one D-Link devices within the network.' Below this instruction, there is a 'Settings >> Network' breadcrumb and a 'Save' button. The main content area is titled 'Network Settings' and contains several input fields: 'LAN IP Address' with the value '192.168.0.1', 'Subnet Mask' with the value '255.255.255.0', 'Management Link' with the value 'http://dlinkrouter.local', 'Local Domain Name' (empty), and 'Enable DNS Relay' with a dropdown menu set to 'Enabled'. There is also a link for 'Advanced Settings' in the bottom right corner.

Advanced Settings - DHCP Server

Status: Enable or disable the DHCP server.

DHCP IP Address Range: Enter the starting and ending IP addresses for the DHCP server's IP assignment.

Note: *If you statically (manually) assign IP addresses to your computers or devices, make sure the IP addresses are outside of this range or you may have an IP conflict.*

DHCP Lease Time: Enter the length of time for the IP address lease in minutes.

Always Broadcast: Enable this feature to broadcast your networks DHCP server to LAN/WLAN clients.

Advanced Settings

WAN Port Speed: You may set the port speed of the Internet port to 10 Mbps, 100 Mbps, 1000 Mbps, or Auto (recommended).

UPnP: Enable or disable Universal Plug and Play (UPnP). UPnP provides compatibility with networking equipment, software and peripherals.

IPv4 Multicast Stream: Enable to allow IPv4 multicast traffic to pass through the router from the Internet.

IPv6 Multicast Stream: Enable to allow IPv6 multicast traffic to pass through the router from the Internet.

Click **Save** when you are done.

The screenshot shows the DHCP Server configuration interface. The 'DHCP Server' section includes a 'Status' dropdown set to 'Enabled', a 'DHCP IP Address Range' field with '192.168.0.' on the left, '100' in the middle, 'to', '192.168.0.', and '199' on the right. Below this is a 'DHCP Lease Time' field set to '10080' minutes, and an 'Always Broadcast' dropdown set to 'Disabled' with a note '(compatibility for some DHCP Clients)'. The 'Advanced Settings' section includes a 'WAN Port Speed' dropdown set to 'Auto', a 'UPnP' dropdown set to 'Enabled', an 'IPv4 Multicast Streams' dropdown set to 'Disabled', and an 'IPv6 Multicast Streams' dropdown set to 'Enabled'.

Features

QoS Engine

This section will allow you to prioritize particular clients over others, so that those clients receive higher bandwidth. For example, if one client is streaming a movie and another is downloading a non-urgent file, you might wish to assign the former device a higher priority than the latter so that the movie streaming is not disrupted by the traffic of the other devices on the network.

In the Features menu on the bar on the top of the page, click **QoS Engine**.

Under All Devices, you will see device cards representing each connected client. If some are off-screen, you can use the < and > buttons to scroll through the cards.

A maximum of **one** device can be assigned **Highest** priority.

A maximum of **two** devices can be assigned **High** priority.

A maximum of **eight** devices can be assigned **Medium** priority.

If no devices are explicitly assigned a priority, they will all be treated with equal priority. If some devices are not assigned a priority and others are, the unassigned devices will be treated with the lowest priority.

To assign a priority level to a device, drag the device card from the All Devices list over an empty slot and release the mouse button. The card will remain in the slot. If you want to remove a priority assignment from a device and return it to the All Devices list, click the cross icon in the top right of the device card.

Click **Save** when you are done.

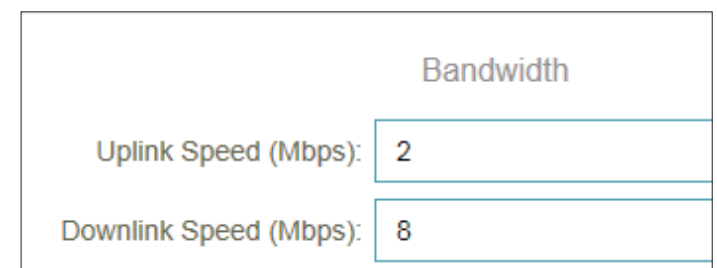

Firewall Settings

The router's firewall protects your network from malicious attacks over the Internet. In the Features menu on the bar on the top of the page, click **Firewall Settings**. Click **Advanced Settings...** to expand the list and see all of the options.

Enable DMZ: Enable or disable Demilitarized Zone (DMZ). This completely exposes the client to threats over the Internet, and is not recommended in ordinary situations.

DMZ IP Address: If you enabled DMZ, enter the IP address of the client you wish to expose, or use the drop-down menu to quickly select it.

Enable SPI IPv4: Enabling Stateful Packet Inspection (SPI) helps to prevent cyber attacks by validating that the traffic passing through the session conforms to the protocol.

Enable Anti-Spoof Checking: Enable this feature to protect your network from certain kinds of "spoofing" attacks.

IPv6 Simple Security: Enable or disable IPv6 simple security.

IPv6 Ingress Filtering: Enable or disable IPv6 ingress filtering.

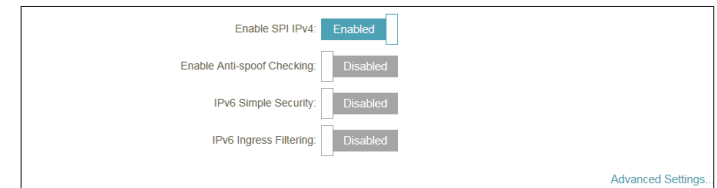

Advanced Settings - Application Level Gateway (ALG) Configuration

PPTP: Allows multiple machines on the LAN to connect to their corporate network using the PPTP protocol.

IPSec (VPN): Allows multiple VPN clients to connect to their corporate network using IPSec. Some VPN clients support traversal of IPSec through NAT. This Application Level Gateway (ALG) may interfere with the operation of such VPN clients. If you are having trouble connecting with your corporate network, try turning this ALG off. Please check with the system administrator of your corporate network whether your VPN client supports NAT traversal.

RTSP: Allows applications that uses Real Time Streaming Protocol (RTSP) to receive streaming media from the Internet.

SIP: Allows devices and applications using VoIP (Voice over IP) to communicate across NAT. Some VoIP applications and devices have the ability to discover NAT devices and work around them. This ALG may interfere with the operation of such devices. If you are having trouble making VoIP calls, try turning this ALG off.

Click **Save** when you are done.

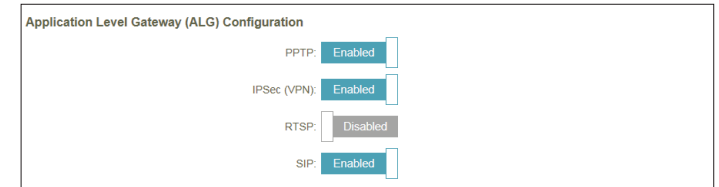

IPv4/IPv6 Rules

The IPv4/IPv6 Rules section is an advanced option that lets you configure what kind of traffic is allowed to pass through the network. To configure the IPv4 rules, from the Firewall Settings page click **IPv4 Rules**. To configure IPv6 rules, from the Firewall Settings page click **IPv6 Rules**. To return to the main Firewall Settings page, click **Security Check**.

To begin, use the drop-down menu to select whether you want to **ALLOW** or **DENY** the rules you create. You can also choose to turn filtering **OFF**.

If you wish to remove a rule, click on its trash can icon in the Delete column. If you wish to edit a rule, click on its pencil icon in the Edit column. If you wish to create a new rule, click the **Add Rules** button. Click **Save** when you are done. If you edit or create a rule, the following options will appear:

Name: Enter a name for the rule.

Source IP Address Range: Enter the source IP address range that the rule will apply to, and using the drop-down menu, specify whether it is a **WAN** or **LAN** IP address.

Destination IP Address Range: Enter the destination IP address range that the rule will apply to, and using the drop-down menu, specify whether it is a **WAN** or **LAN** IP address.

Port Range: Select the protocol of the traffic to allow or deny (**Any**, **TCP**, or **UDP**) and then enter the range of ports that the rule will apply to.

Schedule: Use the drop-down menu to select the time schedule that the rule will be enabled on. The schedule may be set to **Always Enable**, or you can create your own schedules in the **Schedules** section. Refer to page 76 for more information.

Click **Apply** when you are done.

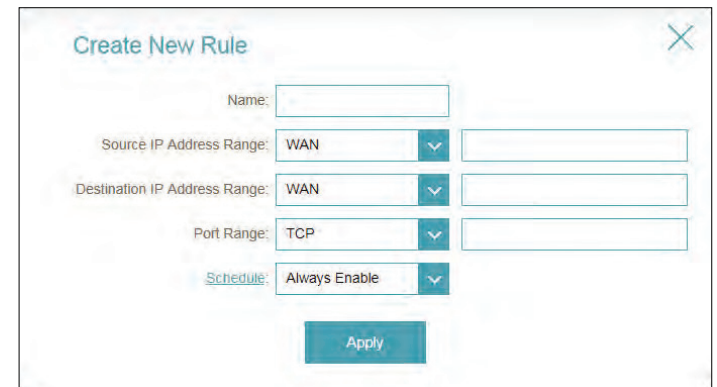
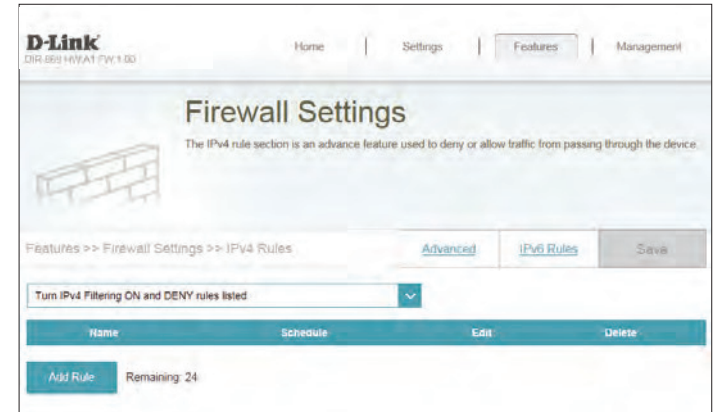

Port Forwarding

Port forwarding allows you to specify a port or range of ports to open for specific devices on the network. This might be necessary for certain applications to connect through the router. In the Features menu on the bar on the top of the page, click **Port Forwarding**.

If you wish to remove a rule, click on its trash can icon in the Delete column. If you wish to edit a rule, click on its pencil icon in the Edit column. If you wish to create a new rule, click the **Add Rules** button. Click **Save** when you are done. If you edit or create a rule, the following options will appear:

Name: Enter a name for the rule.

Local IP: Enter the IP address of the computer on your local network that you want to allow the incoming service to. Alternatively, select the device from the drop-down menu.

TCP Port: Enter the TCP ports that you want to open. You can enter a single port or a range of ports. Separate ports with a comma (for example: 24,1009,3000-4000).

UDP Port: Enter the UDP ports that you want to open. You can enter a single port or a range of ports. Separate ports with a comma (for example: 24,1009,3000-4000).

Schedule: Use the drop-down menu to select the time schedule that the rule will be enabled on. The schedule may be set to **Always Enable**, or you can create your own schedules in the **Schedules** section. Refer to page 76 for more information.

Click **Apply** when you are done.

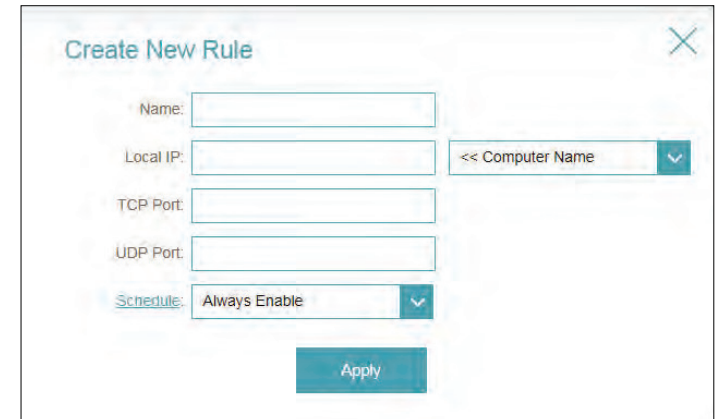
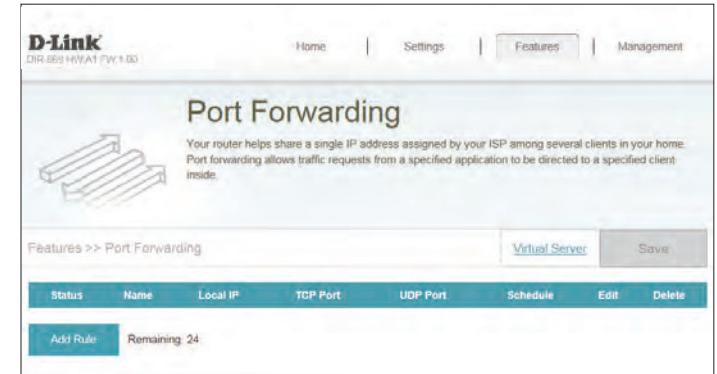

Virtual Server

The virtual server allows you to specify a single public port on your router for redirection to an internal LAN IP Address and Private LAN port. To configure the virtual server, from the Port Forwarding page click **Virtual Server**. To return to the main Port Forwarding page, click **Port Forwarding**.

If you wish to remove a rule, click on its trashcan icon in the Delete column. If you wish to edit a rule, click on its pencil icon in the Edit column. If you wish to create a new rule, click the **Add Rules** button. Click **Save** when you are done. If you edit or create a rule, the following options will appear:

Name: Enter a name for the rule. Alternatively, select the protocol/Application from the drop-down menu.

Local IP: Enter the IP address of the computer on your local network that you want to allow the incoming service to. Alternatively, select the device from the drop-down menu.

Protocol: Select the protocol of the traffic to allow or deny (**TCP**, **UDP**, **Both**, or **Other**).

Protocol Number: If you entered **Other** above, enter the protocol number.

External Port: Enter the public port you want to open.

Internal Port: Enter the private port you want to open.

Schedule: Use the drop-down menu to select the time schedule that the rule will be enabled on. The schedule may be set to **Always Enable**, or you can create your own schedules in the **Schedules** section. Refer to page 76 for more information.

Click **Apply** when you are done.

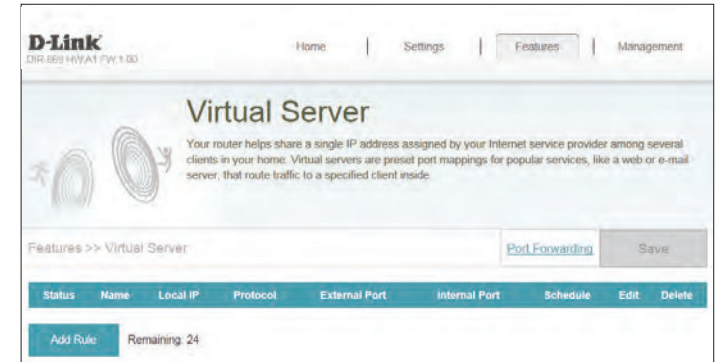

Create New Rule
✕

Name: << Application Name ▼

Local IP: << Computer Name ▼

Protocol: TCP ▼

External Port:

Internal Port:

Schedule: Always Enable ▼

Apply

Website Filter

The website filter settings allow you to block access to certain web sites. You can either create a list of sites to block, or create a list of sites to allow (with all other sites being blocked).

In the Features menu on the bar on the top of the page, click **Website Filter**.

If you want to create a list of sites to block, select **DENY computers access to ONLY these sites** from the drop-down menu. All other sites will be accessible. If you want to specify a list of sites to allow, select **ALLOW computers access to ONLY these sites** from the drop-down menu. All other sites will be blocked.

You may specify a maximum of fifteen web sites. To add a new site to the list, click **Create New Rule**. Next, under Website URL/Domain enter the URL or domain. If you wish to remove a rule, click on its trashcan icon in the Delete column. If you wish to edit a rule, simply replace the URL or domain.

Click **Save** when you are done.

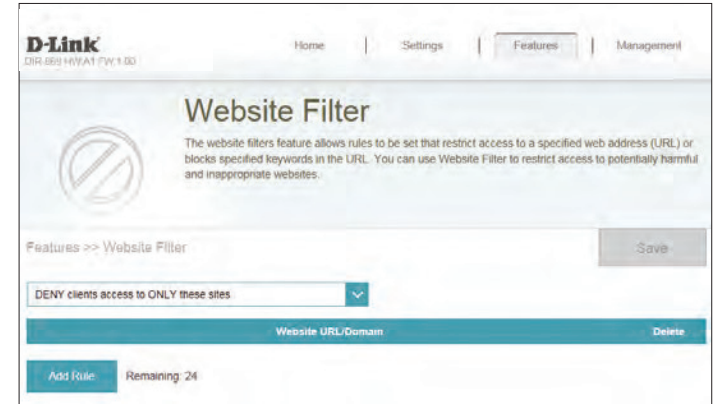

Static Routes

The Static Routes section allows you to define custom routes to control how data traffic is moved around your network.

In the Features menu on the bar on the top of the page, click **Static Routes**. To configure IPv6 rules, click **IPv6** and refer to page 72. To return to the main IPv4 static routes page, click **IPv4**.

If you wish to remove a rule, click on its trash can icon in the Delete column. If you wish to edit a rule, click on its pencil icon in the Edit column. If you wish to create a new rule, click the **Add Rules** button. Click **Save** when you are done. If you edit or create a rule, the following options will appear:

Name: Enter a name for the rule.

Destination Network: Enter the IP address of packets that will take this route.

Mask: Enter the netmask of the route.

Gateway: Enter your next hop gateway to be taken if this route is used.

Metric: The route metric is a value from 1 to 16 that indicates the cost of using this route. A value 1 is the lowest cost and 15 is the highest cost.

Interface: Select the interface that the IP packet must use to transit out of the router when this route is used.

Click **Apply** when you are done.

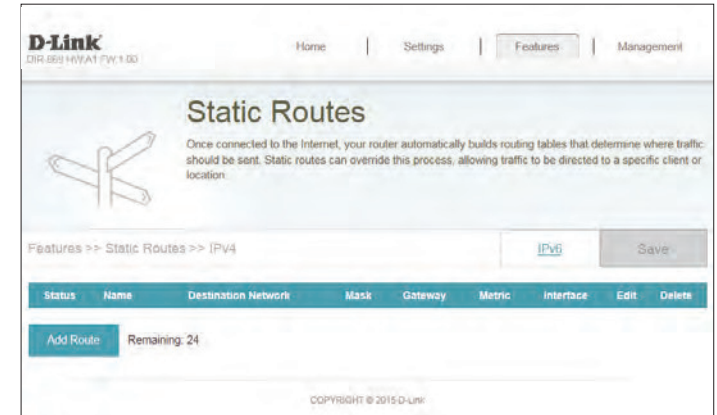

IPv6

To configure IPv6 rules, on the Static Routes page click **IPv6**. To return to the main IPv4 static routes page, click **IPv4**.

If you wish to remove a rule, click on its trash can icon in the Delete column. If you wish to edit a rule, click on its pencil icon in the Edit column. If you wish to create a new rule, click the **Add Rules** button. Click **Save** when you are done. If you edit or create a rule, the following options will appear:

Name: Enter a name for the rule.

DestNetwork: This is the IP address of the router used to reach the specified destination.

PrefixLen: Enter the IPv6 address prefix length of the packets that will take this route.

Gateway: Enter your next hop gateway to be taken if this route is used.

Metric: Enter the metric value for this rule here.

Interface: Select the interface that the IP packet must use to transit out of the router when this route is used.

Click **Apply** when you are done.

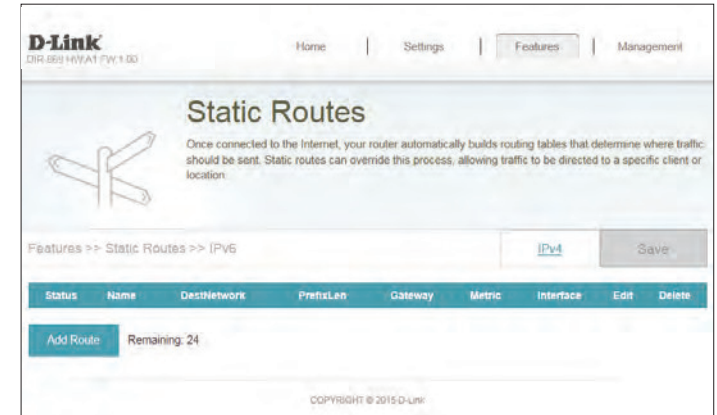

Dynamic DNS

Most Internet Service Providers (ISPs) assign dynamic (changing) IP addresses. Using a dynamic DNS service provider, people can enter your domain name in their web browser to connect to your server no matter what your IP address is.

In the Features menu on the bar on the top of the page, click **Dynamic DNS**.

Enable Dynamic DNS: Enabling dynamic DNS will reveal further configuration options.

Status: Displays the current dynamic DNS connection status.

Server Address: Enter the address of your dynamic DNS server, or select one from the drop-down menu.

Host Name: Enter the host name that you registered with your dynamic DNS service provider.

User Name: Enter your dynamic DNS username.

Password: Enter your dynamic DNS password.

Time Out: Enter a timeout time (in hours).

Click **Save** when you are done.

At the bottom of the page are the IPv6 host settings. To configure an IPv6 dynamic DNS host, refer to page 74.

The screenshot shows the D-Link Dynamic DNS configuration interface. At the top, there's a navigation bar with 'Home', 'Settings', 'Features', and 'Management'. The main heading is 'Dynamic DNS'. Below it, a brief description explains the service. The configuration area includes a 'Save' button in the top right. A toggle for 'Enable Dynamic DNS' is set to 'Enabled'. The 'Status' is 'Disconnected'. The 'Server Address' is a dropdown menu currently showing 'dyndns.com'. Below this are input fields for 'Host Name', 'User Name', and 'Password'. The 'Time Out' is set to '24' hours. At the bottom, there's a table with columns: 'Status', 'Host Name', 'IPv6 Address', 'Edit', and 'Delete'. An 'Add Record' button is next to 'Remaining: 10'. The footer contains 'COPYRIGHT © 2015 D-Link'.

IPv6 Host

The IPv6 host settings are found at the bottom of the Dynamic DNS page.

If you wish to remove a rule, click on its trash can icon in the Delete column. If you wish to edit a rule, click on its pencil icon in the Edit column. If you wish to create a new rule, click the **Add Rules** button. Click **Save** when you are done. If you edit or create a rule, the following options will appear:

Host Name: Enter the host name that you registered with your dynamic DNS service provider.

IPv6 Address: Enter the IPv6 address of the dynamic DNS server. Alternatively, select the server device in the drop-down menu.

Click **Apply** when you are done.

The screenshot shows the D-Link Dynamic DNS configuration interface. At the top, there are navigation links for Home, Settings, Features, and Management. The main heading is 'Dynamic DNS' with a brief description. Below this, there's a 'Save' button. The configuration section includes a toggle for 'Enable Dynamic DNS' which is currently 'Enabled'. The 'Status' is 'Disconnected'. The 'Server Address' is set to 'dyndns.com' with a dropdown menu. There are input fields for 'Host Name', 'User Name', and 'Password'. The 'Time Out' is set to '24' hours. At the bottom, there's a table with columns: Status, Host Name, IPv6 Address, Edit, and Delete. An 'Add Record' button is present with a 'Remaining: 10' indicator.

The screenshot shows a 'Create New Record' dialog box. It has a close button (X) in the top right corner. There are three input fields: 'Host Name', 'IPv6 Address', and a dropdown menu for server selection, which currently shows '<< Computer Name'. An 'Apply' button is located at the bottom center of the dialog.

Management Time & Schedule Time

The Time page allows you to configure, update, and maintain the correct time on the internal system clock. From here you can set the time zone, the Network Time Protocol (NTP) server, and enable or disable daylight saving time.

In the Management menu on the bar on the top of the page, click **Time & Schedule**.

Time Configuration

Time Zone: Select your time zone from the drop-down menu.

Time: Displays the current date and time of the router.

Daylight Saving: Enable or disable daylight saving time.

Automatic Time Configuration

Update Time Using an NTP Server: Enable or disable to allow an NTP server on the Internet to synchronize the time and date with your router. If you enable this option, select an NTP server from the drop-down menu. To configure the router's time and date manually, disable this option and use the drop-down menus that appear to input the time and date.

Click **Save** when you are done.

To configure and manage your schedules, click **Schedule** and refer to page 76.

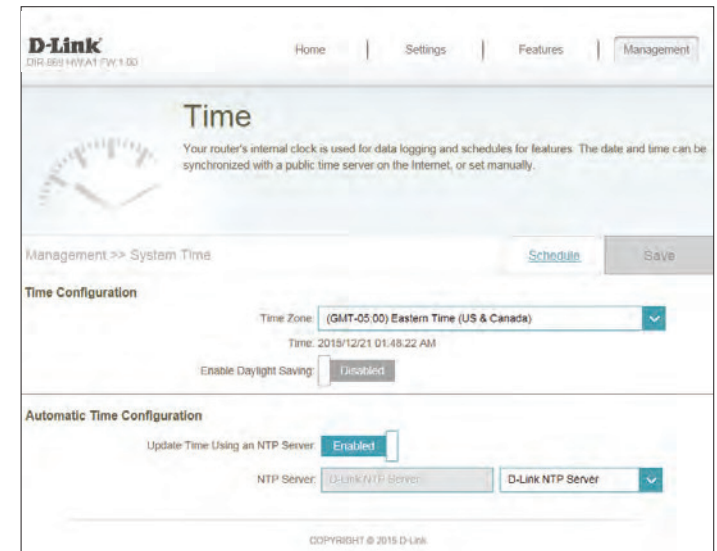

Need Update disable
Screenshot

Schedule

Some configuration rules can be set according to a pre-configured schedule. To create, edit, or delete schedules, from the Time page click **Schedule**. To return to the Time page, click **Time**.

If you wish to remove a rule, click on its trash can icon in the Delete column. If you wish to edit a rule, click on its pencil icon in the Edit column. If you wish to create a new rule, click the **Add Rules** button. Click **Save** when you are done. If you edit or create a rule, the following screen will appear:

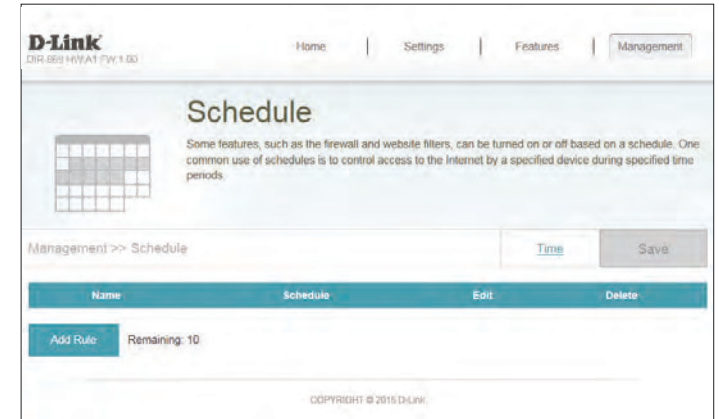

First, enter the name of your schedule in the **Name** field.

Each box represents one hour, with the time at the top of each column. To add a time period to the schedule, simply click on the start hour and drag to the end hour. You can add multiple days to the schedule, but only one period per day.

To remove a time period from the schedule, click on the cross icon.

Click **Apply** when you are done.

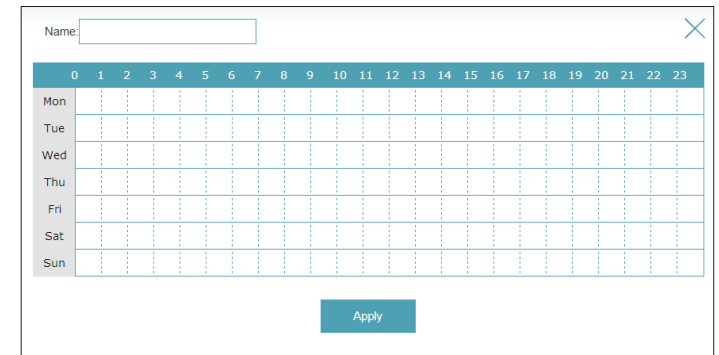

System Log

The router keeps a running log of events. This log can be sent to a Syslog server, and sent to your email address. In the Management menu on the bar on the top of the page, click **System Log**.

SysLog Settings

Enable Logging to Syslog Server: Check this box to send the router logs to a SysLog Server. If this is disabled, there will be no other options on this page.

Syslog Server IP Address: Enter the IP address for the Syslog server. If the Syslog server is connected to the router, select it from the drop-down menu to automatically populate the field.

Email Settings

Enable Email Notification: If you want the logs to be automatically sent to an email address, enable this option.

From E-mail Address: Enter the email address your SysLog messages will be sent from.

To E-mail Address: Enter the email address your SysLog messages will be sent to.

SMTP Server Address: Enter your SMTP server address.

The screenshot shows the D-Link System Log configuration interface. At the top, there are navigation links for Home, Settings, and Management. The main heading is 'System Log' with a sub-heading: 'On-board diagnostics run continually in the background to monitor the health of your router. The results are recorded in the system log if it is enabled. This info can be used to diagnose common problems or help Customer Support resolve issues more quickly.' Below this, there is a 'Save' button. The configuration is divided into three sections: 'SysLog Settings', 'E-mail Settings', and 'E-mail Log When Full or On Schedule'. In the 'SysLog Settings' section, 'Enable Logging to Syslog Server' is checked, and the 'SysLog Server IP Address' field is empty. In the 'E-mail Settings' section, 'Enable E-mail Notification' is checked, and the 'SMTP Server Port' is set to 25. In the 'E-mail Log When Full or On Schedule' section, 'Send When Log Full' and 'Send on Schedule' are checked, and the 'Schedule' is set to 'Always Enable'.

SMTP Server Port: Enter your SMTP server port.

Enable Authentication: Check this box if your SMTP server requires authentication.

Account Name: Enter your SMTP account name.

Password Enter your SMTP account name's password.

E-mail Log When Full or On Schedule

Send On Schedule: If email notification is enabled, this option will set the router to send the log by email when the log is fully.

Schedule: This option can be enabled to send an email according to a preconfigured schedule. See below.

If you enable **On Schedule** is enabled, use the drop-down menu to select the time schedule that the rule will be enabled on. The schedule may be set to **Always Enable**, or you can create your own schedules in the **Schedules** section. Refer to page 76 for more information.

Click **Save** when you are done.

E-mail Settings

Enable E-mail Notification: Enabled

From E-mail Address:

To E-mail Address:

SMTP Server Address:

SMTP Server Port:

Enable Authentication: Enabled

Account Name:

Password:

E-mail Log When Full or On Schedule

Send When Log Full: Enabled

Send on Schedule: Enabled

Schedule:

Admin

This page will allow you to change the administrator (Admin) password and enable remote management.

In the Management menu on the bar on the top of the page, click **Admin**.
To load, save, or reset settings, or reboot the router, click **System** and refer to page 80.

Admin Password

Password: Enter a new password for the administrator account. You will need to enter this password whenever you configure the router using a web browser.

Enable Graphical Authentication (CAPTCHA): Enables a challenge-response test to require users to type letters or numbers from a distorted image displayed on the screen to prevent online hackers and unauthorized users from gaining access to your router's network settings.

Administration

Enable HTTPS Server: Check to enable HTTPS to connect to the router securely. Instead of using **http://dlinkrouter.local./**, you must use **https://dlinkrouter.local./** in order to connect to the router.

Enable Remote Management: Remote management allows the DIR-869 to be configured from the Internet by a web browser. A password is still required to access the web management interface.

Remote Admin Port: The port number used to access the DIR-869 is used in the URL. Example: **http://x.x.x.x:8080** where x.x.x.x is the Internet IP address of the DIR-869 and 8080 is the port used for the web management interface.
Note: If you enabled **HTTPS Server** and wish to access the router remotely and securely, you must enter **https://** at the beginning of the address.

Click **Save** when you are done.

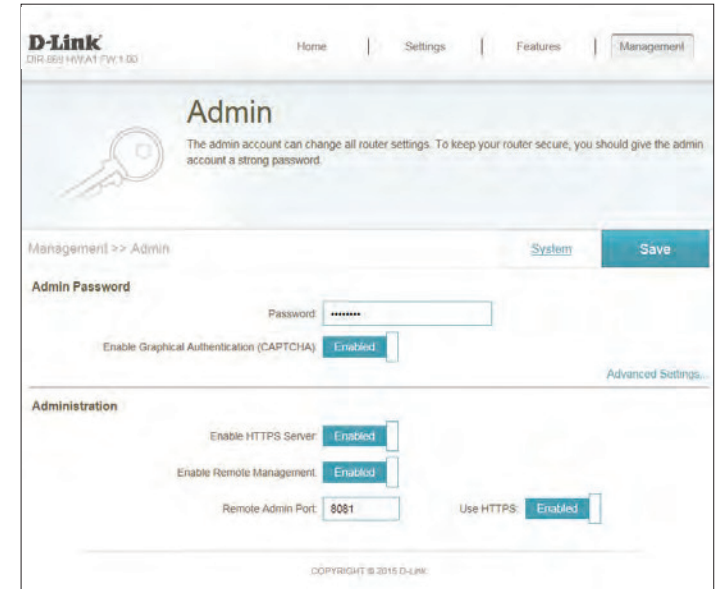

System

This page allows you to save the router's current configuration, load a previously saved configuration, reset the router to its factory default settings, or reboot the router.

From the Admin page, click **System**. To return to the Admin page, click **Admin**.

Sytem

Save Settings To Local Hard Drive: This option will save the current router configuration settings to a file on your computer.

Load Settings From Local Hard Drive: This option will load a previously saved router configuration file. This will overwrite the router's current configuration.

Restore To Factory Default Settings: This option will restore all configuration settings back to the settings that were in effect at the time the router was shipped from the factory. Any settings that have not been saved will be lost, including any rules that you have created. If you want to save the current router configuration settings, use the **Save Settings To Local Hard Drive** button above.

Reboot The Device: Click to reboot the router immediately.

Click **Save** when you are done.

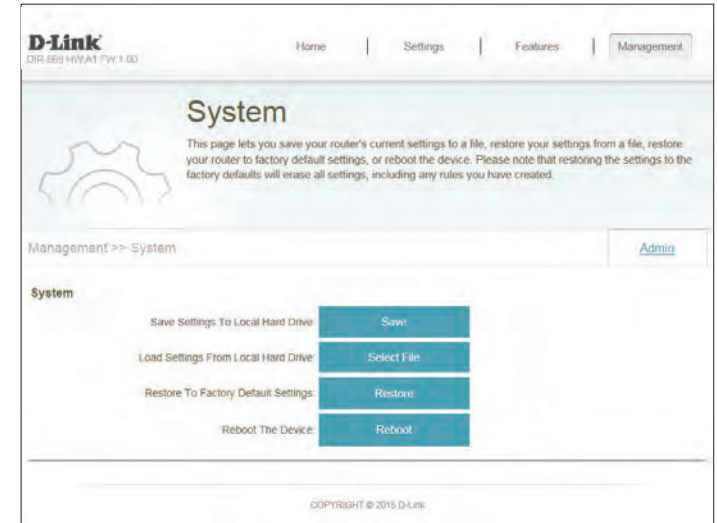

Upgrade

This page will allow you to upgrade the router's firmware or language pack, either automatically or manually. To manually upgrade the firmware or language pack, you must first download the relevant file from <http://support.dlink.com>.

In the Management menu on the bar on the top of the page, click **Upgrade**.

Firmware

Firmware Information: The current firmware's version and date will be displayed.

Check for New Firmware: Click this button to prompt the router to automatically check for a new firmware version. If a newer version is found, it will prompt you to install it.

Upgrade Manually

Upgrade Firmware: If you wish to upgrade manually, first download the firmware file you wish to upgrade to. Next, click the **Upgrade Firmware** button and browse to the file to install the new firmware. You can also browse to a language pack file to install a new language pack.

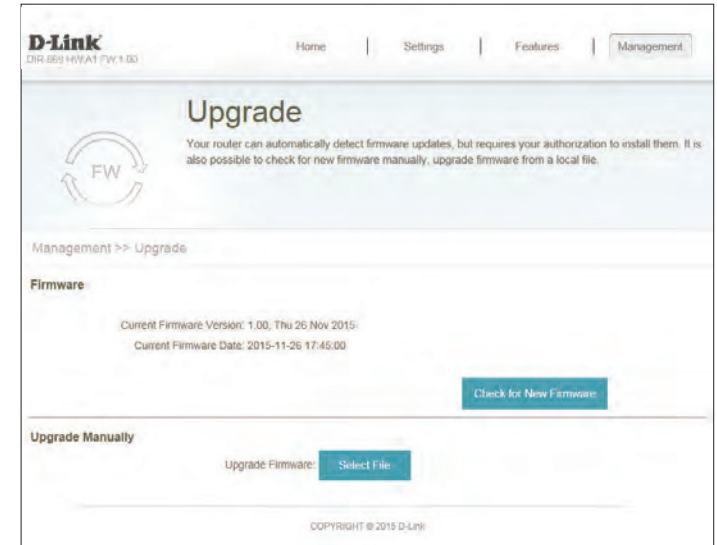

Statistics

On the Statistics page you can view the amount of packets that pass through the router on the WAN, LAN, and wireless segments.

In the Management menu on the bar on the top of the page, click **Statistics**.

You can view the **Internet**, **LAN**, **Wi-Fi 2.4 GHz**, or **Wi-Fi 5 GHz** by clicking on the respective tabs at the top. The graph will update in real time. To clear the information on the graph, click **Clear**.

The traffic counter will reset if the device is rebooted.

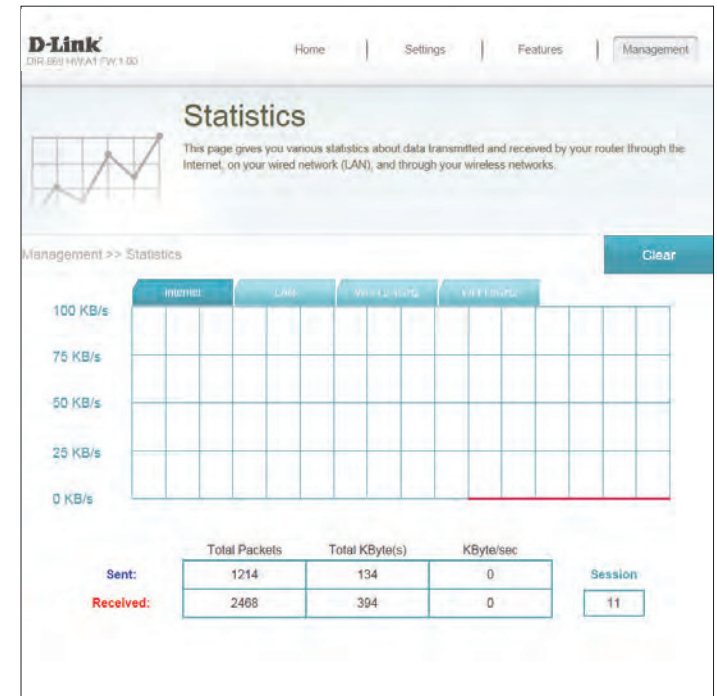

Connect a Wireless Client to your Router

WPS Button

The easiest and most secure way to connect your wireless devices to the router is with WPS (Wi-Fi Protected Setup). Most wireless devices such as wireless adapters, media players, Blu-ray DVD players, wireless printers and cameras will have a WPS button (or a software utility with WPS) that you can press to connect to the DIR-869 router. Please refer to your user manual for the wireless device you want to connect to make sure you understand how to enable WPS. Once you know, follow the steps below:

Step 1 - Press the WPS button on the DIR-869 for about 1 second. The LED on the front will start to blink.



Step 2 - Within 2 minutes, press the WPS button on your wireless device (or launch the software utility and start the WPS process).

Step 3 - Allow up to 1 minute for your connection to be configured. Once the Internet light stops blinking, you will be connected and your wireless connection will be secure with WPA2.

Windows® 10

When connecting to the DIR-869 wirelessly for the first time, you will need to input the wireless network name (SSID) and Wi-Fi password (security key) of the device you are connecting to. If your product has a Wi-Fi configuration card, you can find the default network name and Wi-Fi password here. Otherwise refer to the product label for the default Wi-Fi network SSID and password, or enter the Wi-Fi credentials set during the product configuration.

To join an existing network, locate the wireless network icon in the taskbar, next to the time display and click on it.

Clicking on this icon will display a list of wireless networks which are within range of your computer. Select the desired network by clicking on the SSID.



Wireless Icon

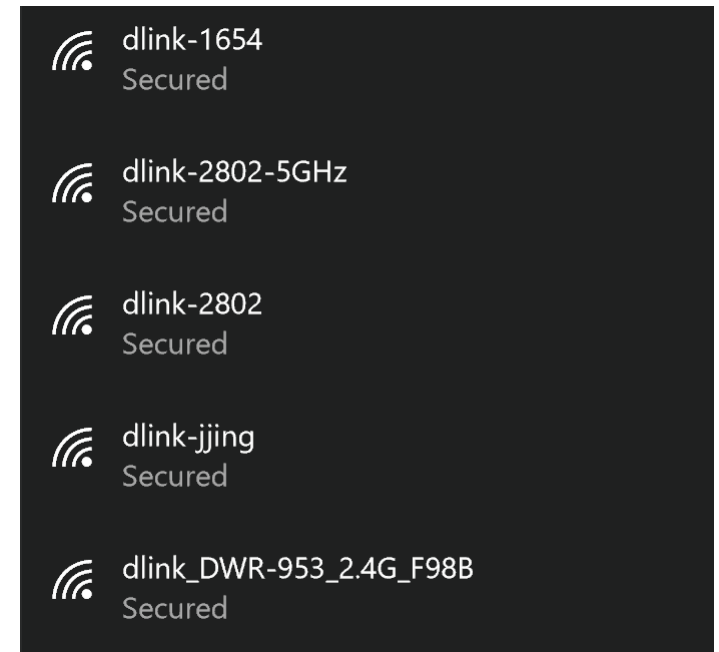

To connect to the SSID, click **Connect**.

To automatically connect with the router when your device next detects the SSID, click the **Connect Automatically** check box.

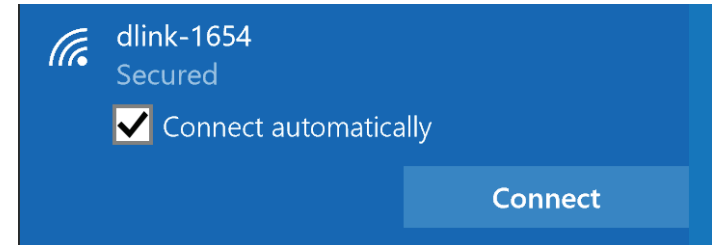

You will then be prompted to enter the Wi-Fi password (network security key) for the wireless network. Enter the password into the box and click **Next** to connect to the network. Your computer will now automatically connect to this wireless network when it is detected.

You can also use Wi-Fi Protected Setup (WPS) to connect to the router. Press the WPS button on your D-Link device and you will be automatically connected.

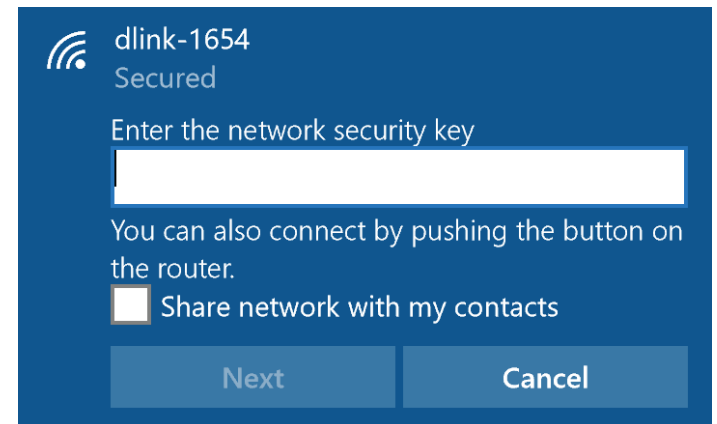

Windows® 8

WPA/WPA2

It is recommended that you enable wireless security (WPA/WPA2) on your wireless router or access point before configuring your wireless adapter. If you are joining an existing network, you will need to know the security key (Wi-Fi password) being used.

To join an existing network, locate the wireless network icon in the taskbar next to the time display.



Clicking on this icon will display a list of wireless networks that are within connecting proximity of your computer. Select the desired network by clicking on the network name.

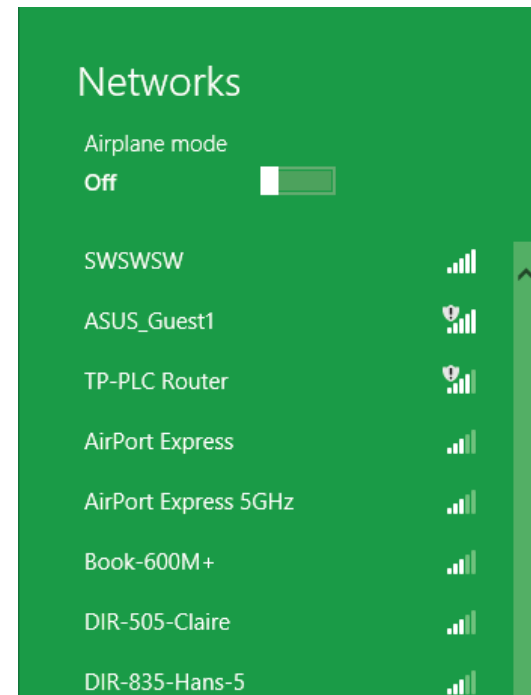

You will then be prompted to enter the network security key (Wi-Fi password) for the wireless network. Enter the password into the box and click **Next**.

If you wish to use Wi-Fi Protected Setup (WPS) to connect to the router, you can also press the WPS button on your router during this step to enable the WPS function.

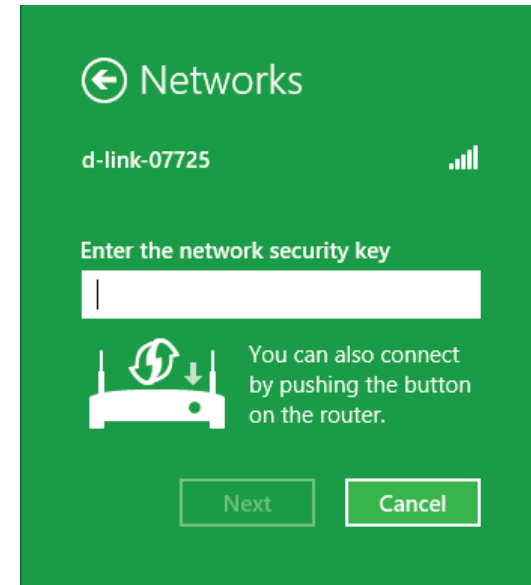

When you have established a successful connection to a wireless network, the word **Connected** will appear next to the name of the network to which you are connected to.

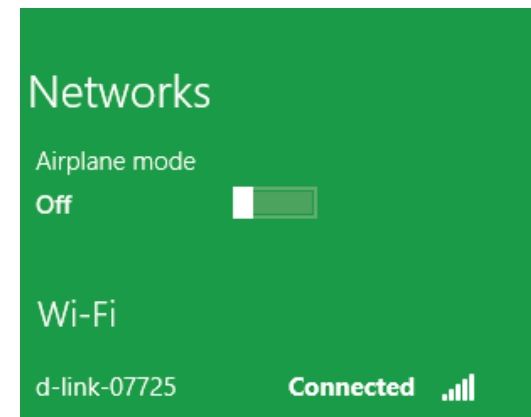

WPS

The WPS feature of the DIR-869 can be configured using Windows® 7. Carry out the following steps to use Windows® 7 to configure the WPS feature:

1. Click the **Start** button and select **Computer** from the Start menu.

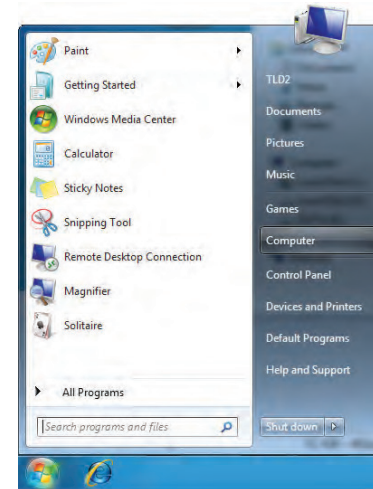

2. Click **Network** on the left side.

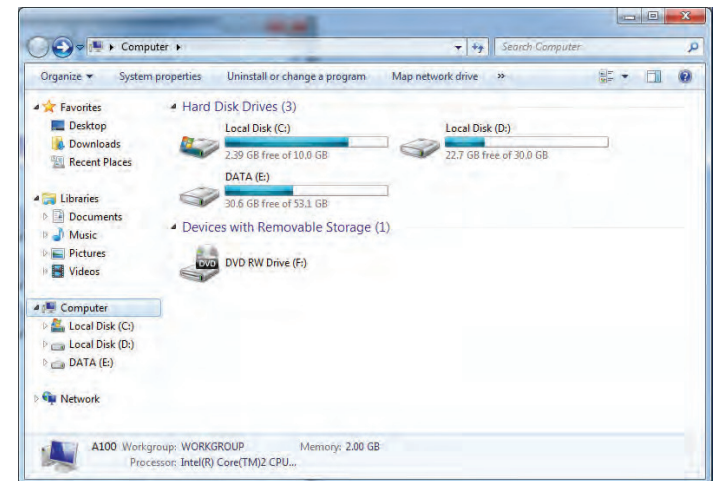

3. Double-click the DIR-869.

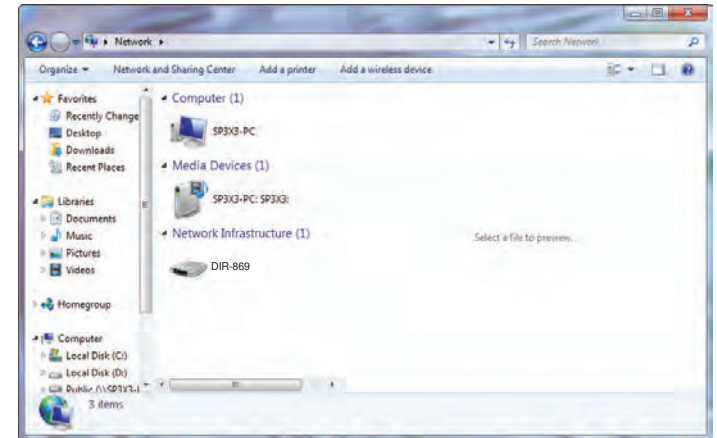

4. Input the WPS PIN number (on the router label) in the **Setup** > **Wireless Setup** menu in the Router's Web UI) and click **Next**.

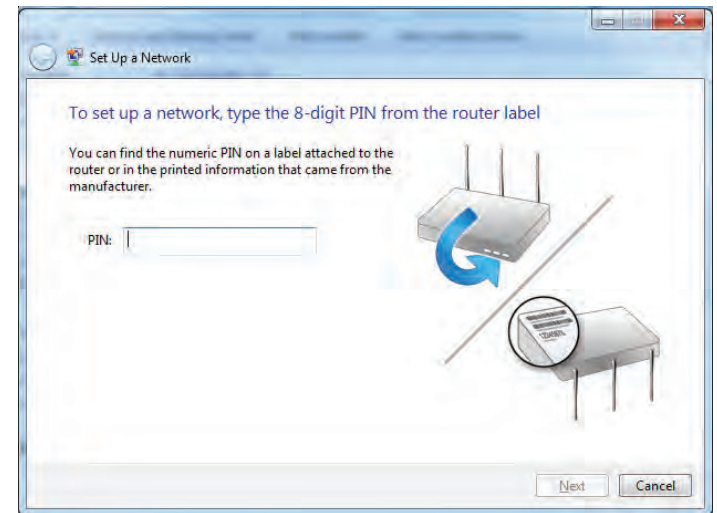

5. Type a name to identify the network.

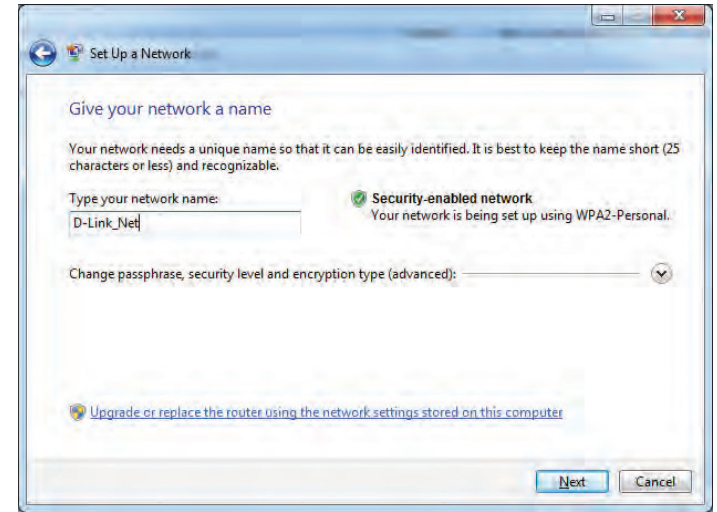

6. To configure advanced settings, click the  icon.

Click **Next** to continue.

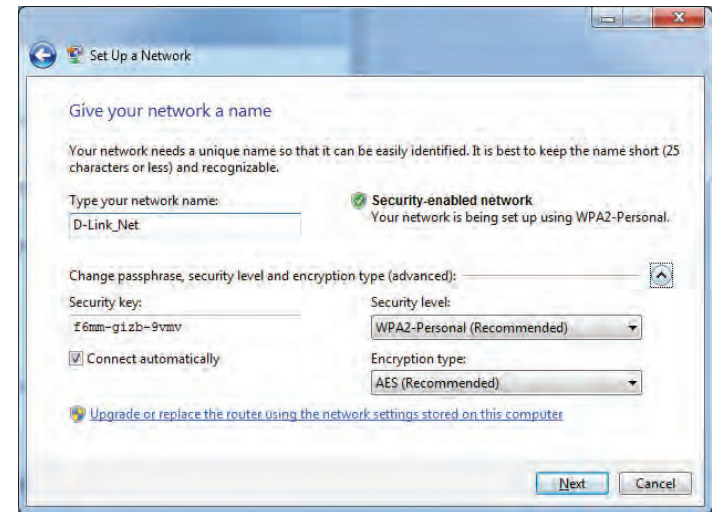

7. The following window appears while the Router is being configured.

Wait for the configuration to complete.

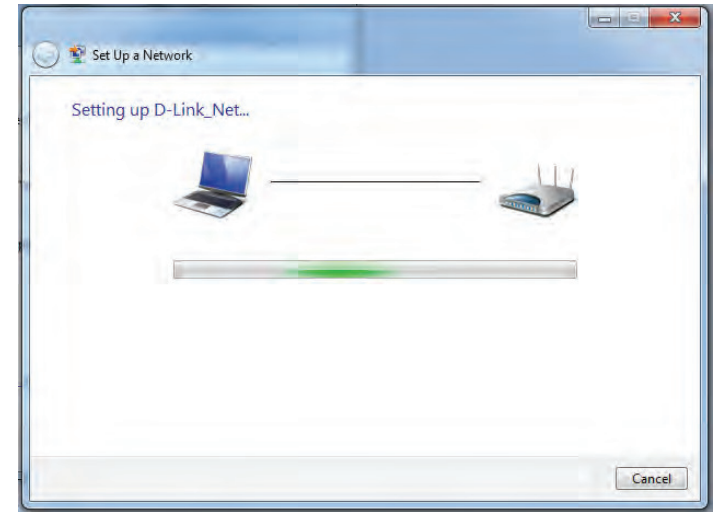

8. The following window informs you that WPS on the router has been set up successfully.

Make a note of the security key as you may need to provide this security key if adding an older wireless device to the network in the future.

9. Click **Close** to complete WPS setup.

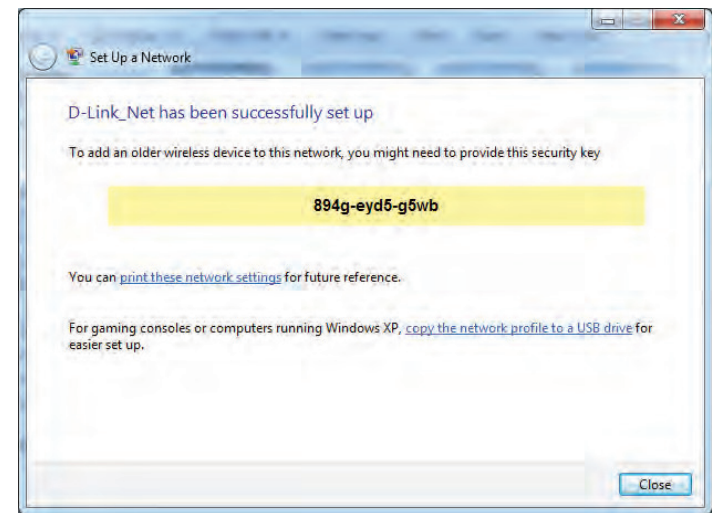

Windows Vista®

Windows Vista® users may use the built-in wireless utility. If you are using another company's wireless utility, please refer to the user manual of your wireless adapter for help connecting to a wireless network. Most wireless utilities will have a "site survey" option similar to the Windows Vista® utility as seen below.

If you receive the **Wireless Networks Detected** bubble, click on the center of the bubble to access the utility.

or

Right-click on the wireless computer icon in your system tray (lower-right corner next to the time). Select **Connect to a network**.

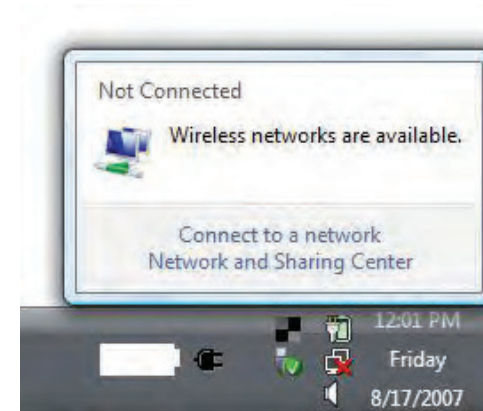

The utility will display any available wireless networks in your area. Click on a network (displayed using the SSID) and click the **Connect** button.

If you get a good signal but cannot access the Internet, check you TCP/IP settings for your wireless adapter. Refer to the **Networking Basics** section in this manual for more information.

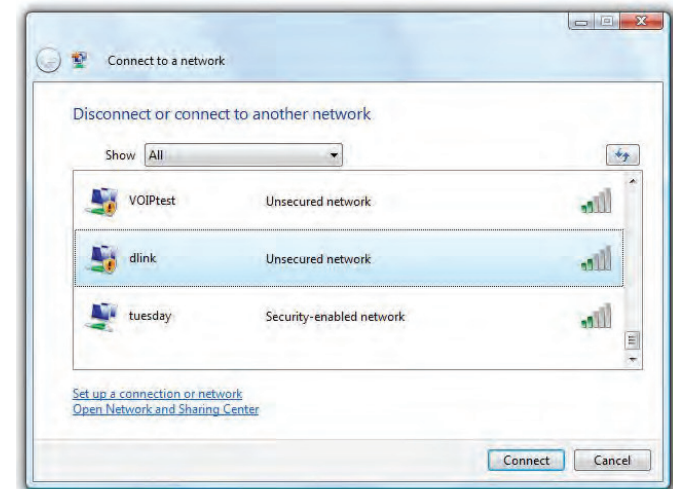

WPA/WPA2

It is recommended that you enable wireless security (WPA/WPA2) on your wireless router or access point before configuring your wireless adapter. If you are joining an existing network, you will need to know the security key or passphrase being used.

1. Open the Windows Vista® Wireless Utility by right-clicking on the wireless computer icon in your system tray (lower right corner of screen). Select **Connect to a network**.

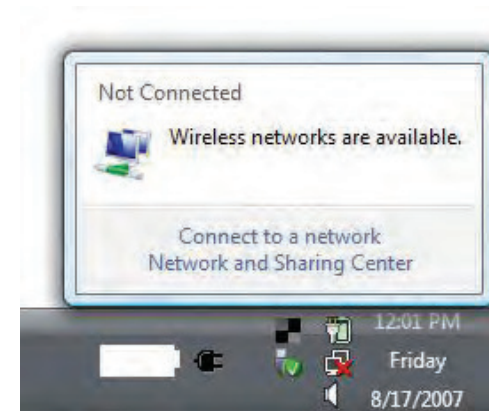

2. Highlight the Wi-Fi name (SSID) you would like to connect to and click **Connect**.

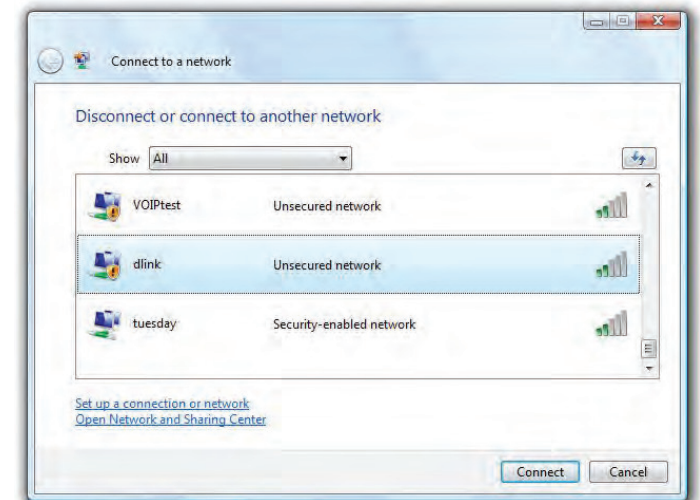

3. Enter the same security key or passphrase (Wi-Fi password) that is on your router and click **Connect**.

It may take 20-30 seconds to connect to the wireless network. If the connection fails, please verify that the security settings are correct. The key or passphrase must be exactly the same as the one on the wireless router.



Troubleshooting

This chapter provides solutions to problems that can occur during the installation and operation of the DIR-869. Read the following descriptions if you are having problems. The examples below are illustrated in Windows® XP. If you have a different operating system, the screenshots on your computer will look similar to these examples.

1. Why can't I access the web-based configuration utility?

When entering the IP address of the D-Link router (**192.168.0.1** for example), you are not connecting to a website, nor do you have to be connected to the Internet. The device has the utility built-in to a ROM chip in the device itself. Your computer must be on the same IP subnet to connect to the web-based utility.

- Make sure you have an updated Java-enabled web browser. We recommend the following:
 - Microsoft Internet Explorer® 7 or higher
 - Mozilla Firefox 3.5 or higher
 - Google™ Chrome 8 or higher
 - Apple Safari 4 or higher
- Verify physical connectivity by checking for solid link lights on the device. If you do not get a solid link light, try using a different cable, or connect to a different port on the device if possible. If the computer is turned off, the link light may not be on.
- Disable any Internet security software running on the computer. Software firewalls such as ZoneAlarm, BLACKICE, Sygate, Norton Personal Firewall, and Windows® XP firewall may block access to the configuration pages. Check the help files included with your firewall software for more information on disabling or configuring it.

- Configure your Internet settings:
 - Go to **Start > Settings > Control Panel**. Double-click the **Internet Options** icon. From the **Security** tab, click the button to restore the settings to their defaults.
 - Click the **Connection** tab and set the dial-up option to Never Dial a Connection. Click the LAN Settings button. Make sure nothing is checked. Click **OK**.
 - Go to the **Advanced** tab and click the button to restore these settings to their defaults. Click **OK** three times.
 - Close your web browser (if open) and open it.
- Access the web management. Open your web browser and enter the IP address of your D-Link router in the address bar. This should open the login page for your web management.
- If you still cannot access the configuration, unplug the power to the router for 10 seconds and plug back in. Wait about 30 seconds and try accessing the configuration. If you have multiple computers, try connecting using a different computer.

2. What can I do if I forgot my password?

If you forgot your password, you must reset your router. This process will change all your settings back to the factory defaults.

To reset the router, locate the reset button (hole) on the rear panel of the unit. With the router powered on, use a paperclip to hold the button down for 10 seconds. Release the button and the router will go through its reboot process. Wait about 30 seconds to access the router. The default IP address is **192.168.0.1**. When logging in, leave the password box empty.

3. Why can't I connect to certain sites or send and receive emails when connecting through my router?

If you are having a problem sending or receiving email, or connecting to secure sites such as eBay, banking sites, and Hotmail, we suggest lowering the MTU in increments of ten (Ex. 1492, 1482, 1472, etc).

To find the proper MTU Size, you'll have to do a special ping of the destination you're trying to go to. A destination could be another computer, or a URL.

- Click on **Start** and then click **Run**.
- Windows® 95, 98, and Me users type in **command** (Windows® NT, 2000, XP, Vista®, and 7 users type in **cmd**) and press **Enter** (or click **OK**).
- Once the window opens, you'll need to do a special ping. Use the following syntax:

ping [url] [-f] [-l] [MTU value]

Example: **ping yahoo.com -f -l 1472**

```
C:\>ping yahoo.com -f -l 1482
Pinging yahoo.com [66.94.234.13] with 1482 bytes of data:
Packet needs to be fragmented but DF set.
Packet needs to be fragmented but DF set.
Packet needs to be fragmented but DF set.
Packet needs to be fragmented but DF set.
Ping statistics for 66.94.234.13:
    Packets: Sent = 4, Received = 0, Lost = 4 (100% loss),
    Approximate round trip times in milli-seconds:
        Minimum = 0ms, Maximum = 0ms, Average = 0ms
C:\>ping yahoo.com -f -l 1472
Pinging yahoo.com [66.94.234.13] with 1472 bytes of data:
Reply from 66.94.234.13: bytes=1472 time=93ms TTL=52
Reply from 66.94.234.13: bytes=1472 time=109ms TTL=52
Reply from 66.94.234.13: bytes=1472 time=125ms TTL=52
Reply from 66.94.234.13: bytes=1472 time=203ms TTL=52
Ping statistics for 66.94.234.13:
    Packets: Sent = 4, Received = 4, Lost = 0 (0% loss),
    Approximate round trip times in milli-seconds:
        Minimum = 93ms, Maximum = 203ms, Average = 132ms
C:\>
```

You should start at 1472 and work your way down by 10 each time. Once you get a reply, go up by 2 until you get a fragmented packet. Take that value and add 28 to the value to account for the various TCP/IP headers. For example, let's say that 1452 was the proper value, the actual MTU size would be 1480, which is the optimum for the network we're working with ($1452+28=1480$).

Once you find your MTU, you can now configure your router with the proper MTU size.

To change the MTU rate on your router follow the steps below:

- Open your browser, enter the IP address of your router (192.168.0.1) and click **OK**.
- Enter your username (admin) and password (blank by default). Click **OK** to enter the web configuration page for the device.
- Click on **Setup** and then click **Manual Configure**.
- To change the MTU, enter the number in the MTU field and click **Save Settings** to save your settings.
- Test your email. If changing the MTU does not resolve the problem, continue changing the MTU in increments of ten.

Wireless Basics

D-Link wireless products are based on industry standards to provide easy-to-use and compatible high-speed wireless connectivity within your home, business, or public access wireless networks. Strictly adhering to the IEEE standard, the D-Link wireless family of products will allow you to securely access the data you want, when, and where you want it. You will be able to enjoy the freedom that wireless networking delivers.

A wireless local area network (WLAN) is a cellular computer network that transmits and receives data with radio signals instead of wires. Wireless LANs are used increasingly in both home and office environments, and public areas such as airports, coffee shops and universities. Innovative ways to utilize WLAN technology are helping people work, and communicate more efficiently. Increased mobility and the absence of cabling and other fixed infrastructure have proven to be beneficial for many users.

Wireless users can use the same applications they use on a wired network. Wireless adapter cards used on laptop and desktop systems support the same protocols as Ethernet adapter cards.

Under many circumstances, it may be desirable for mobile network devices to link to a conventional Ethernet LAN in order to use servers, printers or an Internet connection supplied through the wired LAN. A wireless router is a device used to provide this link.

What is Wireless?

Wireless or Wi-Fi technology is another way of connecting your computer to the network without using wires. Wi-Fi uses radio frequency to connect wirelessly so you have the freedom to connect computers anywhere in your home or office network.

Why D-Link Wireless?

D-Link is the worldwide leader and award winning designer, developer, and manufacturer of networking products. D-Link delivers the performance you need at a price you can afford. D-Link has all the products you need to build your network.

How does wireless work?

Wireless works similarly to how cordless phones work, through radio signals that transmit data from one point A to point B. But wireless technology has restrictions as to how you can access the network. You must be within the wireless network range area to be able to connect your computer. There are two different types of wireless networks: Wireless Local Area Network (WLAN), and Wireless Personal Area Network (WPAN).

Wireless Local Area Network (WLAN)

In a wireless local area network, a device called an Access Point (AP) connects computers to the network. The access point has a small antenna attached to it, which allows it to transmit data back and forth over radio signals. With an indoor access point the signal can travel up to 300 feet. With an outdoor access point the signal can reach out up to 30 miles to serve places like manufacturing plants, industrial locations, university and high school campuses, airports, golf courses, and many other outdoor venues.

Wireless Personal Area Network (WPAN)

Bluetooth is the industry standard wireless technology used for WPAN. Bluetooth devices in WPAN operate in a range up to 30 feet away.

Compared to WLAN the speed and wireless operation range are both less than WLAN, but in return it doesn't use nearly as much power. This makes it ideal for personal devices, such as mobile phones, PDAs, headphones, laptops, speakers, and other devices that operate on batteries.

Who uses wireless?

Wireless technology has become so popular in recent years that almost everyone is using it, whether it's for home, office, business, D-Link has a wireless solution for it.

Home Uses/Benefits

- Gives everyone at home broadband access
- Surf the web, check email, instant message, etc.
- Gets rid of the cables around the house
- Simple and easy to use

Small Office and Home Office Uses/Benefits

- Stay on top of everything at home as you would at office
- Remotely access your office network from home
- Share Internet connection and printer with multiple computers
- No need to dedicate office space

Where is wireless used?

Wireless technology is expanding everywhere, not just at home or office. People like the freedom of mobility and it's becoming so popular that more and more public facilities now provide wireless access to attract people. The wireless connection in public places is usually called "hotspots".

Using a D-Link CardBus adapter with your laptop, you can access the hotspot to connect to the Internet from remote locations like: airports, hotels, coffee shops, libraries, restaurants, and convention centers.

Wireless network is easy to setup, but if you're installing it for the first time it could be quite a task not knowing where to start. That's why we've put together a few setup steps and tips to help you through the process of setting up a wireless network.

Tips

Here are a few things to keep in mind, when you install a wireless network.

Centralize your router or access point

Make sure you place the router/access point in a centralized location within your network for the best performance. Try to place the router/access point as high as possible in the room, so the signal gets dispersed throughout your home. If you have a two-story home, you may need a repeater to boost the signal to extend the range.

Eliminate Interference

Place home appliances such as cordless telephones, microwaves, and televisions as far away as possible from the router/access point. This would significantly reduce any interference that the appliances might cause since they operate on same frequency.

Security

Don't let your next-door neighbors or intruders connect to your wireless network. Secure your wireless network by turning on the WPA or WEP security feature on the router. Refer to the product manual for detail information on how to set it up.

Wireless Modes

There are basically two modes of networking:

- **Infrastructure** – All wireless clients will connect to an access point or wireless router.
- **Ad-hoc** – Directly connecting to another computer for peer-to-peer communication using wireless network adapters on each computer, such as two or more DIR-869 wireless network CardBus adapters.

An Infrastructure network contains an access point or wireless router. All the wireless devices, or clients, will connect to the wireless router or access point.

An Ad-hoc network contains only clients, such as laptops with wireless CardBus adapters. All the adapters must be in Ad-hoc mode to communicate.

Networking Basics

Check your IP address

After you install your new D-Link adapter, by default, the TCP/IP settings should be set to obtain an IP address from a DHCP server (i.e. wireless router) automatically. To verify your IP address, please follow the steps below.

Click on **Start > Run**. In the run box type **cmd** and click **OK**. (Windows® 7/Vista® users type **cmd** in the **Start Search** box.)

At the prompt, type **ipconfig** and press **Enter**.

This will display the IP address, subnet mask, and the default gateway of your adapter.

If the address is 0.0.0.0, check your adapter installation, security settings, and the settings on your router. Some firewall software programs may block a DHCP request on newly installed adapters.

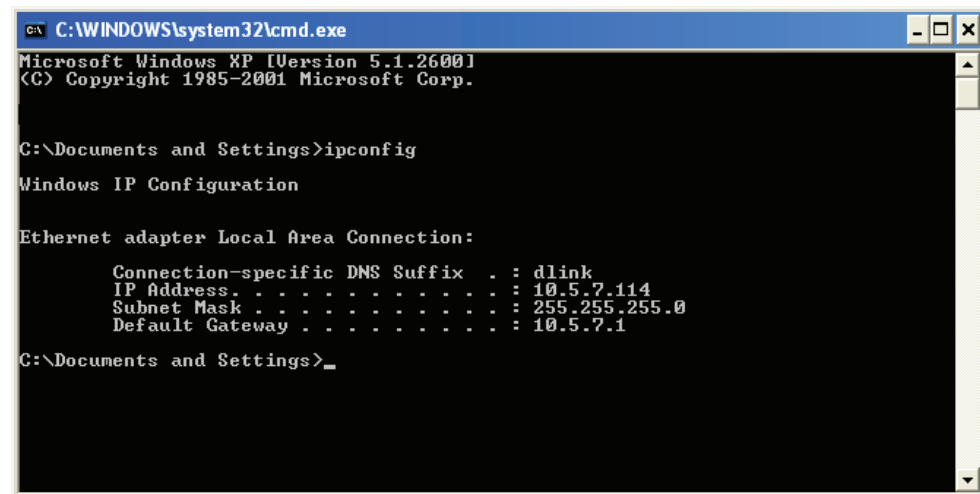

```
C:\WINDOWS\system32\cmd.exe
Microsoft Windows XP [Version 5.1.2600]
(C) Copyright 1985-2001 Microsoft Corp.

C:\Documents and Settings>ipconfig

Windows IP Configuration

Ethernet adapter Local Area Connection:

    Connection-specific DNS Suffix  . : dlink
    IP Address . . . . . : 10.5.7.114
    Subnet Mask . . . . . : 255.255.255.0
    Default Gateway . . . . . : 10.5.7.1

C:\Documents and Settings>_
```

Statically Assign an IP address

If you are not using a DHCP capable gateway/router, or you need to assign a static IP address, please follow the steps below:

Step 1

- Windows® 7 - Click on **Start > Control Panel > Network and Internet > Network and Sharing Center.**
- Windows Vista® - Click on **Start > Control Panel > Network and Internet > Network and Sharing Center > Manage Network Connections.**
- Windows® XP - Click on **Start > Control Panel > Network Connections.**
- Windows® 2000 - From the desktop, right-click **My Network Places > Properties.**

Step 2

Right-click on the **Local Area Connection** which represents your network adapter and select **Properties.**

Step 3

Highlight **Internet Protocol (TCP/IP)** and click **Properties.**

Step 4

Click **Use the following IP address** and enter an IP address that is on the same subnet as your network or the LAN IP address on your router.

Example: If the router's LAN IP address is 192.168.0.1, make your IP address 192.168.0.X where X is a number between 2 and 99. Make sure that the number you choose is not in use on the network. Set the Default Gateway the same as the LAN IP address of your router (I.E. 192.168.0.1).

Set Primary DNS the same as the LAN IP address of your router (192.168.0.1). The Secondary DNS is not needed or you may enter a DNS server from your ISP.

Step 5

Click **OK** twice to save your settings.

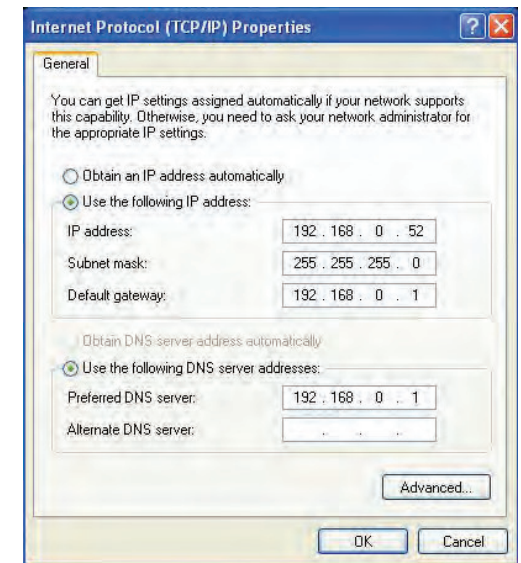

Wireless Security

This section will show you the different levels of security you can use to protect your data from intruders. The DIR-869 offers the following types of security:

- WPA2 (Wi-Fi Protected Access 2)
- WPA (Wi-Fi Protected Access)
- WPA2-PSK (Pre-Shared Key)
- WPA-PSK (Pre-Shared Key)

What is WPA?

WPA (Wi-Fi Protected Access), is a Wi-Fi standard that was designed to improve the security features of WEP (Wired Equivalent Privacy).

The 2 major improvements over WEP:

- Improved data encryption through the Temporal Key Integrity Protocol (TKIP). TKIP scrambles the keys using a hashing algorithm and by adding an integrity-checking feature, ensures that the keys haven't been tampered with. WPA2 is based on 802.11i and uses Advanced Encryption Standard (AES) instead of TKIP.
- User authentication, which is generally missing in WEP, through the extensible authentication protocol (EAP). WEP regulates access to a wireless network based on a computer's hardware-specific MAC address, which is relatively simple to be sniffed out and stolen. EAP is built on a more secure public-key encryption system to ensure that only authorized network users can access the network.

WPA-PSK/WPA2-PSK uses a passphrase or key to authenticate your wireless connection. The key is an alpha-numeric password between 8 and 63 characters long. The password can include symbols (!?*&_) and spaces. This key must be the exact same key entered on your wireless router or access point.

WPA/WPA2 incorporates user authentication through the Extensible Authentication Protocol (EAP). EAP is built on a more secure public key encryption system to ensure that only authorized network users can access the network.

Technical Specifications

Hardware Specifications

- LAN Interface: Four 10/100/1000 Mbps LAN ports
- WAN Interface: One 10/100/1000 Mbps Internet port
- Wireless Interface (2.4 GHz): IEEE 802.11n/g/b
- Wireless Interface (5 GHz): IEEE 802.11 ac/n/a

Operating Voltage

- Input: 100~240 V AC, 50~60 Hz
- Output: 12 V DC, 1.5 A

Temperature

- Operating: 0 ~ 40 °C (32 ~ 104 °F)
- Non-Operating: -20 ~ 65 °C (-20 ~ 149 °F)

Humidity

- Operating: 10% - 90% non-condensing
- Non-Operating: 5% - 95% non-condensing

Wireless Frequency Range

- IEEE 802.11a: 5150 MHz~5250 MHz, 5725 MHz~5850 MHz
- IEEE 802.11b: 2400 MHz~2483.5 MHz
- IEEE 802.11g: 2400 MHz~2483.5 MHz
- IEEE 802.11n: 2400 MHz~2483.5 MHz, 5150 MHz~5250 MHz, 5725 MHz~5850 MHz
- IEEE 802.11ac: 5150 MHz~5250 MHz, 5725 MHz~5850 MHz

Wireless Bandwidth Rate

- IEEE 802.11a: 54, 48, 36, 24, 18, 12, 9, and 6 Mbps
- IEEE 802.11b: 11, 5.5, 2, and 1 Mbps

- IEEE 802.11g: 54, 48, 36, 24, 18, 12, 9, and 6 Mbps
- IEEE 802.11n: 6.5 to 450 Mbps
- IEEE 802.11ac: 6.5 to 1300 Mbps

Antenna Type

- Four external antennas

Wireless Security

- 64/128bit WEP, WPA/WPA2-Personal, WPS-PBC

EMI/EMC Certification

- CE
- FCC
- IC
- BSMI
- CCC

RF Certification

- CE
- FCC
- IC
- NCC

Safety Certification

- CSA
- CCC
- BSMI

Dimensions & Weight

- 221.52 x 160.15 x 60.36 mm (8.72 x 6.30 x 2.38 inches)
- 432 g (15.24 ounces)

Regulatory Statements

Federal Communication Commission Interference Statement

This equipment has been tested and found to comply with the limits for a Class B digital device, pursuant to Part 15 of the FCC Rules. These limits are designed to provide reasonable protection against harmful interference in a residential installation. This equipment generates, uses and can radiate radio frequency energy and, if not installed and used in accordance with the instructions, may cause harmful interference to radio communications. However, there is no guarantee that interference will not occur in a particular installation. If this equipment does cause harmful interference to radio or television reception, which can be determined by turning the equipment off and on, the user is encouraged to try to correct the interference by one of the following measures:

- Reorient or relocate the receiving antenna.
- Increase the separation between the equipment and receiver.
- Connect the equipment into an outlet on a circuit different from that to which the receiver is connected.
- Consult the dealer or an experienced radio/TV technician for help.

Non-modifications Statement:

Any changes or modifications not expressly approved by the party responsible for compliance could void the user's authority to operate this equipment.

Caution:

This device complies with Part 15 of the FCC Rules. Operation is subject to the following two conditions:

- (1) This device may not cause harmful interference, and
- (2) this device must accept any interference received, including interference that may cause undesired operation.

For product available in the USA/Canada market, only channel 1~11 can be operated. Selection of other channels is not possible. This device and its antenna(s) must not be co-located or operating in conjunction with any other antenna or transmitter except in accordance with FCC multi-transmitter product procedures.

Note

The country code selection is for non-USA models only and is not available to all USA models. Per FCC regulations, all WiFi product marketed in the USA must be fixed to USA operational channels only.

It is restricted to indoor environments only.

IMPORTANT NOTICE:

FCC Radiation Exposure Statement

This equipment complies with FCC radiation exposure limits set forth for an uncontrolled environment. This equipment should be installed and operated with minimum distance 20 cm between the radiator and your body.

Industry Canada Statement:

This device complies with Industry Canada licence-exempt RSS standard(s). Operation is subject to the following two conditions:

- (1) this device may not cause interference, and
- (2) this device must accept any interference, including interference that may cause undesired operation of the device.

Le présent appareil est conforme aux CNR d'Industrie Canada applicables aux appareils radio exempts de licence. L'exploitation est autorisée aux deux conditions suivantes:

- (1) l'appareil ne doit pas produire de brouillage, et
- (2) l'utilisateur de l'appareil doit accepter tout brouillage radioélectrique subi, même si le brouillage est susceptible d'en compromettre le fonctionnement.

For product available in the USA/Canada market, only channel 1~11 can be operated. Selection of other channels is not possible.

Pour les produits disponibles aux États-Unis / Canada du marché, seul le canal 1 à 11 peuvent être exploités. Sélection d'autres canaux n'est pas possible.

This device and its antenna(s) must not be co-located or operating in conjunction with any other antenna or transmitter except in accordance with IC multi-transmitter product procedures.

Cet appareil et son antenne (s) ne doit pas être co-localisés ou fonctionnement en association avec une autre antenne ou transmetteur.

The device for operation in the band 5150-5250 MHz is only for indoor use to reduce the potential for harmful interference to co-channel mobile satellite systems;

Les dispositifs fonctionnant dans la bande 5150-5250 MHz sont réservés uniquement pour une utilisation à l'intérieur afin de réduire les risques de brouillage préjudiciable aux systèmes de satellites mobiles utilisant les mêmes canaux;

The maximum antenna gain permitted for devices in the band 5725-5850 MHz shall be such that the equipment still complies with the e.i.r.p. limits specified for point-to-point and non-point-to-point operation as appropriate;

Pour les dispositifs munis d'antennes amovibles, le gain maximal d'antenne permis (pour les dispositifs utilisant la bande de 5725 à 5850 MHz) doit être conforme à la limite de la p.i.r.e. spécifiée pour l'exploitation point à point et l'exploitation non point à point, selon le cas;

Radiation Exposure Statement

This equipment complies with IC RSS-102 radiation exposure limits set forth for an uncontrolled environment. This equipment should be installed and operated with minimum distance 20 cm between the radiator and your body.

Déclaration d'exposition aux radiations

Cet équipement est conforme aux limites d'exposition aux rayonnements IC établies pour un environnement non contrôlé. Cet équipement doit être installé et utilisé avec un minimum de 20 cm de distance entre la source de rayonnement et votre corps.

This radio transmitter DIR-869A1 has been approved by Industry Canada to operate with the antenna types listed below with the maximum permissible gain and required antenna impedance for each antenna type indicated. Antenna types not included in this list, having a gain greater than the maximum gain indicated for that type, are strictly prohibited for use with this device.

Le présent émetteur radio DIR-869A1 a été approuvé par Industrie Canada pour fonctionner avec les types d'antenne énumérés ci-dessous et ayant un gain admissible maximal et l'impédance requise pour chaque type d'antenne. Les types d'antenne non inclus dans cette liste, ou dont le gain est supérieur au gain maximal indiqué, sont strictement interdits pour l'exploitation de l'émetteur.

Table for Filed Antenna

Ant.	Brand	Model Name	Antenna Type	Connector	2.4 G Gain (dBi)	5 G Gain (dBi)
1	Nienyi	NYS1811	PCB Antenna	5G ipex/2.4G Stripped	3 dBi	3 dBi
2	Nienyi	NYS1812	PCB Antenna	5G ipex/2.4G Stripped	3 dBi	3 dBi
3	Nienyi	NYS1813	PCB Antenna	ipex	3 dBi	3 dBi
4	Nienyi	NYS1814	PCB Antenna	Stripped	2.5 dBi	2.5 dBi