

## FCC Test Report

**Report No.:** RF170815E02-1

**FCC ID:** KA2IR867A1

**Test Model:** DIR-867

**Received Date:** Jan. 16, 2017

**Test Date:** Mar. 20 to Aug. 31, 2017

**Issued Date:** Oct. 30, 2017

**Applicant:** D-Link Corporation

**Address:** 17595 Mt. Herrmann Street Fountain Valley, CA92708 USA

**Issued By:** Bureau Veritas Consumer Products Services (H.K.) Ltd., Taoyuan Branch  
Hsin Chu Laboratory

**Lab Address:** E-2, No.1, Li Hsin 1st Road, Hsinchu Science Park, Hsinchu City 300,  
Taiwan R.O.C.

**Test Location:** E-2, No.1, Li Hsin 1st Road, Hsinchu Science Park, Hsinchu City 300,  
Taiwan R.O.C.



This report is for your exclusive use. Any copying or replication of this report to or for any other person or entity, or use of our name or trademark, is permitted only with our prior written permission. This report sets forth our findings solely with respect to the test samples identified herein. The results set forth in this report are not indicative or representative of the quality or characteristics of the lot from which a test sample was taken or any similar or identical product unless specifically and expressly noted. Our report includes all of the tests requested by you and the results thereof based upon the information that you provided to us. You have 60 days from date of issuance of this report to notify us of any material error or omission caused by our negligence, provided, however, that such notice shall be in writing and shall specifically address the issue you wish to raise. A failure to raise such issue within the prescribed time shall constitute your unqualified acceptance of the completeness of this report, the tests conducted and the correctness of the report contents. Unless specific mention, the uncertainty of measurement has been explicitly taken into account to declare the compliance or non-compliance to the specification. The report must not be used by the client to claim product certification, approval, or endorsement by TAF or any government agencies.

## Table of Contents

<b>Release Control Record</b> .....	<b>4</b>
<b>1 Certificate of Conformity</b> .....	<b>5</b>
<b>2 Summary of Test Results</b> .....	<b>6</b>
2.1 Measurement Uncertainty .....	6
2.2 Modification Record .....	6
<b>3 General Information</b> .....	<b>7</b>
3.1 General Description of EUT .....	7
3.2 Description of Test Modes .....	10
3.2.1 Test Mode Applicability and Tested Channel Detail .....	11
3.3 Duty Cycle of Test Signal .....	13
3.4 Description of Support Units .....	14
3.4.1 Configuration of System under Test .....	15
3.5 General Description of Applied Standard .....	16
<b>4 Test Types and Results</b> .....	<b>17</b>
4.1 Radiated Emission and Bandedge Measurement .....	17
4.1.1 Limits of Radiated Emission and Bandedge Measurement .....	17
4.1.2 Test Instruments .....	18
4.1.3 Test Procedure .....	20
4.1.4 Deviation from Test Standard .....	20
4.1.5 Test Setup .....	21
4.1.6 EUT Operating Condition .....	22
4.1.7 Test Results .....	23
4.2 Conducted Emission Measurement .....	42
4.2.1 Limits of Conducted Emission Measurement .....	42
4.2.2 Test Instruments .....	42
4.2.3 Test Procedure .....	43
4.2.4 Deviation from Test Standard .....	43
4.2.5 Test Setup .....	43
4.2.6 EUT Operating Condition .....	43
4.2.7 Test Results (Mode 1) .....	44
4.2.8 Test Results (Mode 2) .....	46
4.3 Transmit Power Measurement .....	48
4.3.1 Limits of Transmit Power Measurement .....	48
4.3.2 Test Setup .....	48
4.3.3 Test Instruments .....	48
4.3.4 Test Procedure .....	48
4.3.5 Deviation from Test Standard .....	48
4.3.6 EUT Operating Condition .....	48
4.3.7 Test Result .....	49
4.4 Occupied Bandwidth Measurement .....	51
4.4.1 Test Setup .....	51
4.4.2 Test Instruments .....	51
4.4.3 Test Procedure .....	51
4.4.4 Test Results .....	52
4.5 Peak Power Spectral Density Measurement .....	58
4.5.1 Limits of Peak Power Spectral Density Measurement .....	58
4.5.2 Test Setup .....	58
4.5.3 Test Instruments .....	58
4.5.4 Test Procedure .....	58
4.5.5 Deviation from Test Standard .....	59
4.5.6 EUT Operating Condition .....	59
4.5.7 Test Results .....	60
4.6 Frequency Stability Measurement .....	66

4.6.1	Limits of Frequency Stability Measurement .....	66
4.6.2	Test Setup.....	66
4.6.3	Test Instruments .....	66
4.6.4	Test Procedure .....	66
4.6.5	Deviation from Test Standard .....	66
4.6.6	EUT Operating Condition .....	66
4.6.7	Test Results .....	67
4.7	6dB Bandwidth Measurement .....	68
4.7.1	Limits of 6dB Bandwidth Measurement.....	68
4.7.2	Test Setup.....	68
4.7.3	Test Instruments .....	68
4.7.4	Test Procedure .....	68
4.7.5	Deviation from Test Standard .....	68
4.7.6	EUT Operating Condition .....	68
4.7.7	Test Results .....	69
<b>5</b>	<b>Pictures of Test Arrangements.....</b>	<b>71</b>
	<b>Annex A- Radiated Out of Band Emission (OOBE) Measurement (For U-NII-3 band) .....</b>	<b>72</b>
	<b>Annex A.1 (Mode 1).....</b>	<b>72</b>
	<b>Appendix – Information on the Testing Laboratories .....</b>	<b>76</b>

### Release Control Record

Issue No.	Description	Date Issued
RF170815E02-1	Original release.	Oct. 30, 2017

## 1 Certificate of Conformity

**Product:** AC1750 MU-MIMO Wi-Fi Gigabit Router

**Brand:** D-Link

**Test Model:** DIR-867

**Sample Status:** ENGINEERING SAMPLE

**Applicant:** D-Link Corporation

**Test Date:** Mar. 20 to Aug. 31, 2017

**Standard:** 47 CFR FCC Part 15, Subpart E (Section 15.407)  
ANSI C63.10: 2013

The above equipment has been tested by **Bureau Veritas Consumer Products Services (H.K.) Ltd., Taoyuan Branch**, and found compliance with the requirement of the above standards. The test record, data evaluation & Equipment Under Test (EUT) configurations represented herein are true and accurate accounts of the measurements of the sample's EMC characteristics under the conditions specified in this report.

**Prepared by :**  \_\_\_\_\_, **Date:** \_\_\_\_\_ Oct. 30, 2017  
Wendy Wu / Specialist

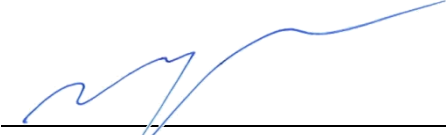
**Approved by :**  \_\_\_\_\_, **Date:** \_\_\_\_\_ Oct. 30, 2017  
May Chen / Manager

## 2 Summary of Test Results

47 CFR FCC Part 15, Subpart E (Section 15.407)			
FCC Clause	Test Item	Result	Remarks
15.407(b)(6)	AC Power Conducted Emissions	Pass	Meet the requirement of limit. Minimum passing margin is -13.39dB at 0.39219MHz.
15.407(b) (1/2/3/4(i/ii)/6)	Radiated Emissions & Band Edge Measurement*	Pass	Meet the requirement of limit. Minimum passing margin is -0.1dB at 5150.00MHz.
15.407(a)(1/2/3)	Max Average Transmit Power	Pass	Meet the requirement of limit.
---	Occupied Bandwidth Measurement	-	Reference only.
15.407(a)(1/2/3)	Peak Power Spectral Density	Pass	Meet the requirement of limit.
15.407(e)	6dB bandwidth	Pass	Meet the requirement of limit. (U-NII-3 Band only)
15.407(g)	Frequency Stability	Pass	Meet the requirement of limit.
15.203	Antenna Requirement	Pass	Antenna connector is i-pex not a standard connector.

\*For U-NII-3 band compliance with rule part 15.407(b)(4)(i), the OOB test plots were recorded in Annex A.

### 2.1 Measurement Uncertainty

Where relevant, the following measurement uncertainty levels have been estimated for tests performed on the EUT as specified in CISPR 16-4-2:

Measurement	Frequency	Expanded Uncertainty (k=2) (±)
Conducted Emissions at mains ports	150kHz ~ 30MHz	1.84 dB
Radiated Emissions up to 1 GHz	30MHz ~ 1GHz	5.30 dB
Radiated Emissions above 1 GHz	1GHz ~ 6GHz	5.16 dB
	6GHz ~ 18GHz	4.91 dB
	18GHz ~ 40GHz	5.30 dB

### 2.2 Modification Record

There were no modifications required for compliance.

### 3 General Information

#### 3.1 General Description of EUT

Product	AC1750 MU-MIMO Wi-Fi Gigabit Router
Brand	D-Link
Test Model	DIR-867
Status of EUT	ENGINEERING SAMPLE
Power Supply Rating	DC 12V from power adapter
Modulation Type	CCK, DQPSK, DBPSK for DSSS 64QAM, 16QAM, QPSK, BPSK for OFDM 256QAM for OFDM in 11ac mode and VHT20/40 in 2.4GHz band
Modulation Technology	DSSS, OFDM
Transfer Rate	802.11b: up to 11Mbps 802.11a/g: up to 54Mbps 802.11n: up to 450Mbps 802.11ac: up to 1300Mbps
Operating Frequency	<b>2.4GHz:</b> 2.412GHz ~ 2.462GHz <b>5GHz:</b> 5.18GHz ~ 5.24GHz, 5.745GHz ~ 5.825GHz
Number of Channel	<b>2.4GHz:</b> 802.11b, 802.11g, 802.11n (HT20), VHT20: 11 802.11n (HT40), VHT40: 7 <b>5GHz:</b> 802.11a, 802.11n (HT20), 802.11ac (VHT20): 9 802.11n (HT40), 802.11ac (VHT40): 4 802.11ac (VHT80): 2
Output Power	<b>2.4GHz:</b> 600.792mW <b>5GHz:</b> <b>5.18GHz ~ 5.24GHz:</b> <b>CDD Mode:</b> 235.054mW <b>Beamforming Mode:</b> 225.152mW <b>5.745GHz ~ 5.825GHz:</b> <b>CDD Mode:</b> 549.499mW <b>Beamforming Mode:</b> 255.134mW
Antenna Type	Refer to Note
Antenna Connector	Refer to Note
Accessory Device	Adapter x 1
Data Cable Supplied	NA

Note:

1. Simultaneously transmission condition.

Condition	Technology	
1	WLAN (2.4GHz)	WLAN (5GHz)

**Note:** The emission of the simultaneous operation has been evaluated and no non-compliance was found.

2. The EUT must be supplied with a power adapter as following table:

No	Brand	Model No.	Spec.
1	Frecom	F18L7-120150SPAU	AC Input: 100-240V, 0.6A, 50/60Hz DC Output: 12V, 1.5A DC Output cable: unshielded, 1.2m
2	Shenzhen Gongjin Electronics Co., Ltd	S18B72-120A150-C4	AC Input: 100-240V, 0.7A, 50/60Hz DC Output: 12V, 1.5A DC Output cable: unshielded, 1.1m

Note: From the above adapters, the worst radiated test was found in **Adapter 1**. Therefore only the test data of the modes were recorded in this report.

3. The antennas provided to the EUT, please refer to the following table:

Antenna No.	Brand	Model	Ant. Gain(dBi) Including cable loss	Frequency range (MHz)	Antenna Type	Connector Type	Cable Length (mm)
1	RF link	RF21C02116A	4.75	2400~2483.5	Dipole	i-pex	130
			4.96	5150~5850			
2		RF21C02546A	4.75	2400~2483.5	Dipole	i-pex	130
			4.96	5150~5850			
3		RF21C02547A	5	2400~2483.5	Dipole	i-pex	160
4		RF21C02547A	5	5150~5850	Dipole	i-pex	160



4. The EUT incorporates a MIMO function.

2.4GHz Band			
MODULATION MODE	DATA RATE (MCS)	TX & RX CONFIGURATION	
802.11b	1 ~ 11Mbps	3TX	3RX
802.11g	6 ~ 54Mbps	3TX	3RX
802.11n (HT20)	MCS 0~7	3TX	3RX
	MCS 8~15	3TX	3RX
	MCS 16~23	3TX	3RX
802.11n (HT40)	MCS 0~7	3TX	3RX
	MCS 8~15	3TX	3RX
	MCS 16~23	3TX	3RX
VHT20	MCS 0~8, Nss=1	3TX	3RX
	MCS 0~8, Nss=2	3TX	3RX
	MCS 0~9, Nss=3	3TX	3RX
VHT40	MCS0~9 Nss=1	3TX	3RX
	MCS0~9 Nss=2	3TX	3RX
	MCS0~9 Nss=3	3TX	3RX
5GHz Band			
MODULATION MODE	DATA RATE (MCS)	TX & RX CONFIGURATION	
802.11a	6 ~ 54Mbps	3TX	3RX
802.11n (HT20)	MCS 0~7	3TX	3RX
	MCS 8~15	3TX	3RX
	MCS 16~23	3TX	3RX
802.11n (HT40)	MCS 0~7	3TX	3RX
	MCS 8~15	3TX	3RX
	MCS 16~23	3TX	3RX
802.11ac (VHT20)	MCS 0~8, Nss=1	3TX	3RX
	MCS 0~8, Nss=2	3TX	3RX
	MCS 0~9, Nss=3	3TX	3RX
802.11ac (VHT40)	MCS 0~9, Nss=1	3TX	3RX
	MCS 0~9, Nss=2	3TX	3RX
	MCS 0~9, Nss=3	3TX	3RX
802.11ac (VHT80)	MCS 0~9, Nss=1	3TX	3RX
	MCS 0~9, Nss=2	3TX	3RX
	MCS 0~9, Nss=3	3TX	3RX

Note:

1. All of modulation mode support beamforming function except 802.11a/b/g modulation mode.
2. The EUT support Beamforming and CDD mode, therefore both mode were investigated and the worst case scenario was identified. The worst case data were presented in test report.
3. The modulation and bandwidth are similar for 802.11n mode for 20MHz (40MHz) and 802.11ac mode for 20MHz (40MHz), therefore investigated worst case to representative mode in test report. (Final test mode refer section 3.2.1)

5. The above EUT information is declared by manufacturer and for more detailed features description, please refer to the manufacturer's specifications or user's manual.

### 3.2 Description of Test Modes

#### FOR 5180 ~ 5240MHz

4 channels are provided for 802.11a, 802.11n (HT20), 802.11ac (VHT20):

Channel	Frequency	Channel	Frequency
36	5180MHz	44	5220MHz
40	5200MHz	48	5240MHz

2 channels are provided for 802.11n (HT40), 802.11ac (VHT40):

Channel	Frequency	Channel	Frequency
38	5190MHz	46	5230MHz

1 channel is provided for 802.11ac (VHT80):

Channel	Frequency
42	5210MHz

#### FOR 5745 ~ 5825MHz:

5 channels are provided for 802.11a, 802.11n (HT20), 802.11ac (VHT20):

Channel	Frequency	Channel	Frequency
149	5745MHz	161	5805MHz
153	5765MHz	165	5825MHz
157	5785MHz		

2 channels are provided for 802.11n (HT40), 802.11ac (VHT40):

Channel	Frequency	Channel	Frequency
151	5755MHz	159	5795MHz

1 channel is provided for 802.11ac (VHT80):

Channel	Frequency
155	5775MHz

### 3.2.1 Test Mode Applicability and Tested Channel Detail

EUT Configure Mode	Applicable To				Description
	RE $\geq$ 1G	RE<1G	PLC	APCM	
1	√	√	√	√	Adapter 1
2	-	-	√	-	Adapter 2

Where **RE $\geq$ 1G**: Radiated Emission above 1GHz      **RE<1G**: Radiated Emission below 1GHz  
**PLC**: Power Line Conducted Emission      **APCM**: Antenna Port Conducted Measurement

**NOTE:**

1. The EUT had been pre-tested on the positioned of each 2 axis. The worst case was found when positioned on **X-plane(below 1GHz) & Y-plane(above 1GHz)**.
2. "-" means no effect.

#### **Radiated Emission Test (Above 1GHz):**

- Pre-Scan has been conducted to determine the worst-case mode from all possible combinations between available modulations, data rates and antenna ports (if EUT with antenna diversity architecture).
- Following channel(s) was (were) selected for the final test as listed below.

CDD Mode						
Mode	FREQ. Band (MHz)	Available Channel	Tested Channel	Modulation Technology	Modulation Type	Data Rate (Mbps)
802.11a	5180-5240	36 to 48	36, 40, 48	OFDM	BPSK	6
802.11ac (VHT20)		36 to 48	36, 40, 48	OFDM	BPSK	6.5
802.11ac (VHT40)		38 to 46	38, 46	OFDM	BPSK	13.5
802.11ac (VHT80)		42	42	OFDM	BPSK	29.3
802.11a	5745-5825	149 to 165	149, 157, 165	OFDM	BPSK	6
802.11ac (VHT20)		149 to 165	149, 157, 165	OFDM	BPSK	6.5
802.11ac (VHT40)		151 to 159	151, 159	OFDM	BPSK	13.5
802.11ac (VHT80)		155	155	OFDM	BPSK	29.3

#### **Radiated Emission Test (Below 1GHz):**

- Pre-Scan has been conducted to determine the worst-case mode from all possible combinations between available modulations, data rates and antenna ports (if EUT with antenna diversity architecture).
- Following channel(s) was (were) selected for the final test as listed below.

CDD Mode						
Mode	FREQ. Band (MHz)	Available Channel	Tested Channel	Modulation Technology	Modulation Type	Data Rate (Mbps)
802.11a	5180-5240	36 to 48	157	OFDM	BPSK	6
	5745-5825	149 to 165				

### Power Line Conducted Emission Test:

- Pre-Scan has been conducted to determine the worst-case mode from all possible combinations between available modulations, data rates and antenna ports (if EUT with antenna diversity architecture).
- Following channel(s) was (were) selected for the final test as listed below.

CDD Mode						
Mode	FREQ. Band (MHz)	Available Channel	Tested Channel	Modulation Technology	Modulation Type	Data Rate (Mbps)
802.11a	5180-5240	36 to 48	157	OFDM	BPSK	6
	5745-5825	149 to 165				

### Antenna Port Conducted Measurement:

- This item includes all test value of each mode, but only includes spectrum plot of worst value of each mode.
- Pre-Scan has been conducted to determine the worst-case mode from all possible combinations between available modulations, data rates and antenna ports (if EUT with antenna diversity architecture).
- Following channel(s) was (were) selected for the final test as listed below.

CDD Mode						
Mode	FREQ. Band (MHz)	Available Channel	Tested Channel	Modulation Technology	Modulation Type	Data Rate (Mbps)
802.11a	5180-5240	36 to 48	36, 40, 48	OFDM	BPSK	6
802.11ac (VHT20)		36 to 48	36, 40, 48	OFDM	BPSK	6.5
802.11ac (VHT40)		38 to 46	38, 46	OFDM	BPSK	13.5
802.11ac (VHT80)		42	42	OFDM	BPSK	29.3
802.11a	5745-5825	149 to 165	149, 157, 165	OFDM	BPSK	6
802.11ac (VHT20)		149 to 165	149, 157, 165	OFDM	BPSK	6.5
802.11ac (VHT40)		151 to 159	151, 159	OFDM	BPSK	13.5
802.11ac (VHT80)		155	155	OFDM	BPSK	29.3
Beamforming Mode (Output power only)						
Mode	FREQ. Band (MHz)	Available Channel	Tested Channel	Modulation Technology	Modulation Type	Data Rate (Mbps)
802.11ac (VHT20)	5180-5240	36 to 48	36, 40, 48	OFDM	BPSK	6.5
802.11ac (VHT40)		38 to 46	38, 46	OFDM	BPSK	13.5
802.11ac (VHT80)		42	42	OFDM	BPSK	29.3
802.11ac (VHT20)	5745-5825	149 to 165	149, 157, 165	OFDM	BPSK	6.5
802.11ac (VHT40)		151 to 159	151, 159	OFDM	BPSK	13.5
802.11ac (VHT80)		155	155	OFDM	BPSK	29.3

### Test Condition:

Applicable To	Environmental Conditions	Input Power	Tested By
RE $\geq$ 1G	25deg. C, 66%RH	120Vac, 60Hz	Jyunchun Lin
RE $<$ 1G	25deg. C, 72%RH	120Vac, 60Hz	Weiwei Lo
PLC	21deg. C, 75%RH	120Vac, 60Hz	Weiwei Lo
APCM	24deg. C, 63%RH	120Vac, 60Hz	Anderson Chen

### 3.3 Duty Cycle of Test Signal

Duty cycle of test signal is 100 %, duty factor is not required.

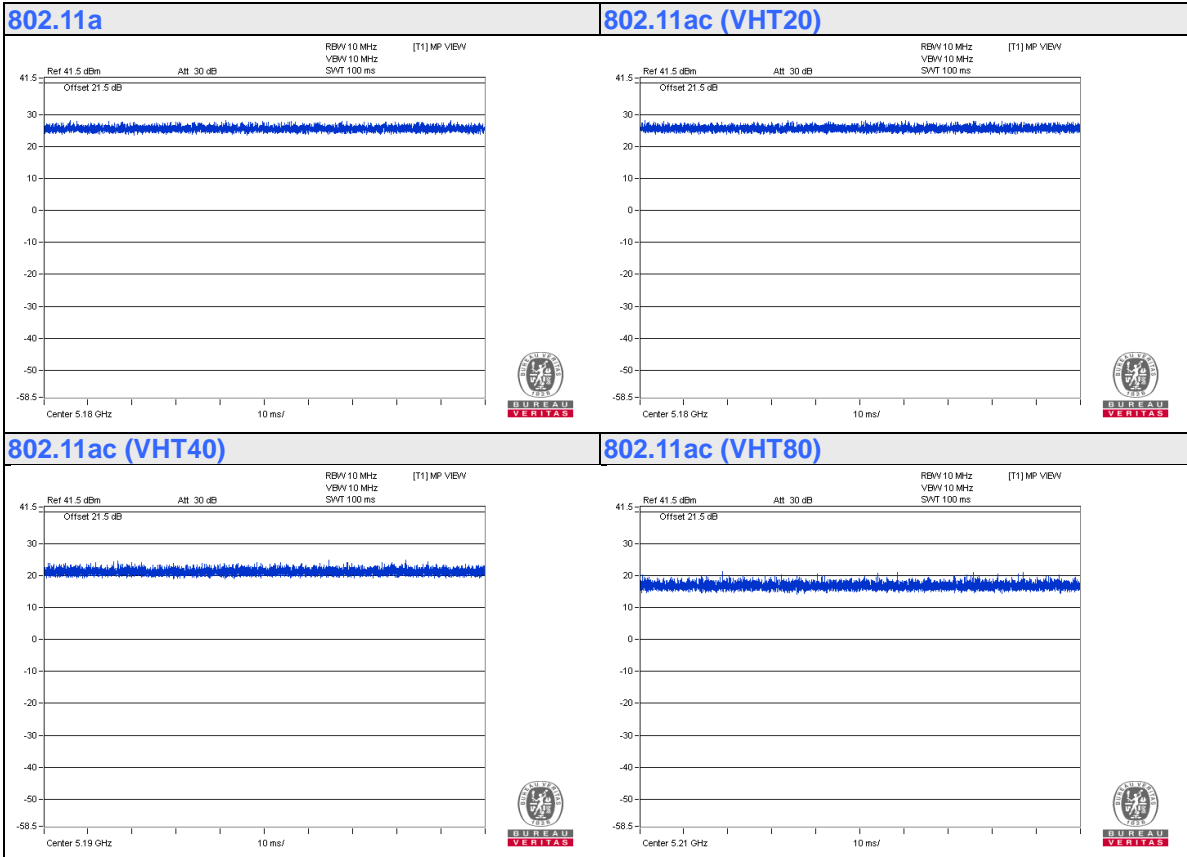

### 3.4 Description of Support Units

The EUT has been tested as an independent unit together with other necessary accessories or support units. The following support units or accessories were used to form a representative test configuration during the tests.

ID	Product	Brand	Model No.	Serial No.	FCC ID	Remarks
A.	Laptop	DELL	E5430	4YV4VY1	FCC DoC	Provided by Lab
B.	Laptop	DELL	E5430	HYV4VY1	FCC DoC	Provided by Lab

Note:

1. All power cords of the above support units are non-shielded (1.8m).

ID	Descriptions	Qty.	Length (m)	Shielding (Yes/No)	Cores (Qty.)	Remarks
1.	DC Cable	1	1.2(For adapter 1) 1.1(For adapter 2)	No	0	Supplied by client
2.	RJ-45 Cable	1	10	No	0	Provided by Lab
3.	RJ-45 Cable	1	10	No	0	Provided by Lab

### 3.4.1 Configuration of System under Test

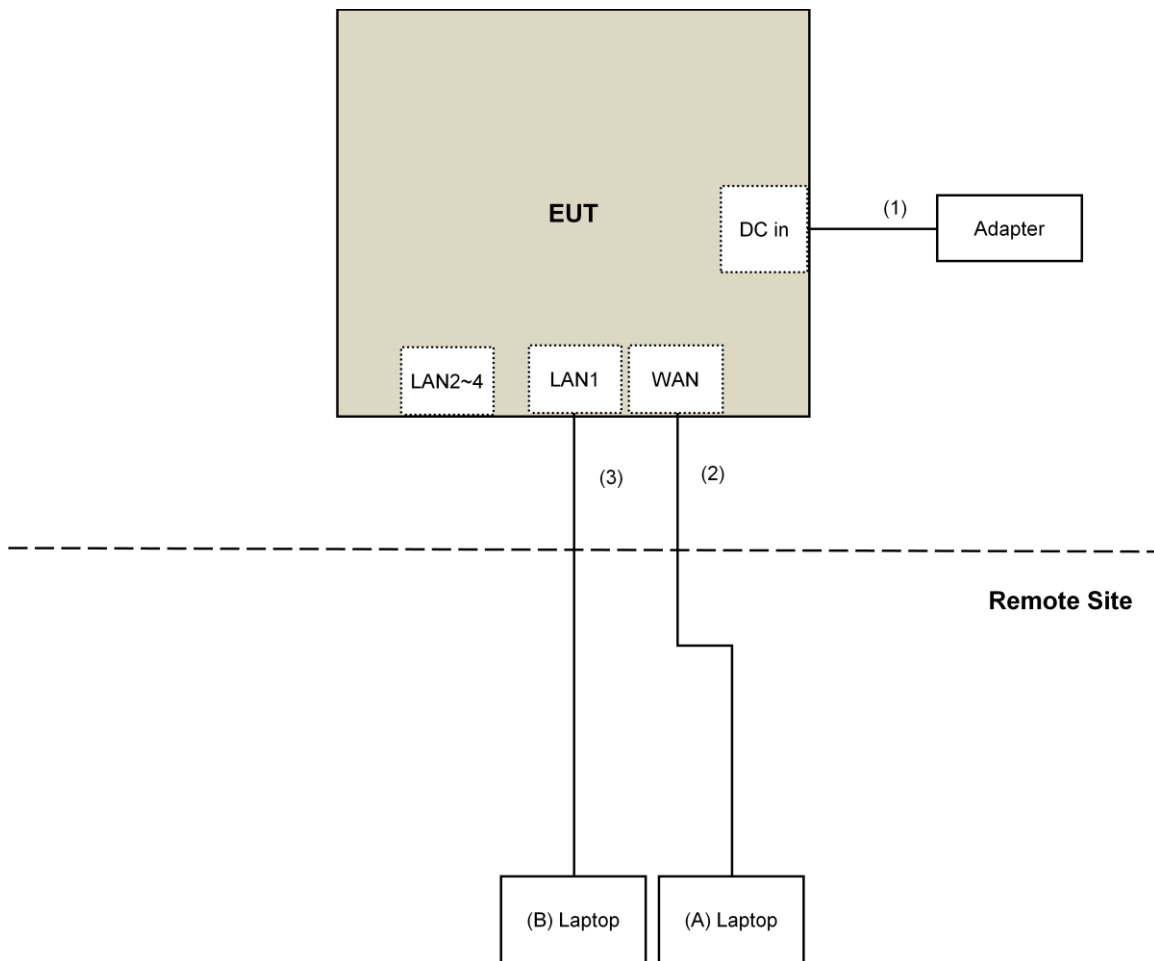

### 3.5 General Description of Applied Standard

The EUT is a RF Product. According to the specifications of the manufacturer, it must comply with the requirements of the following standards:

**FCC Part 15, Subpart E (15.407)**  
**KDB 789033 D02 General UNII Test Procedure New Rules v01r04**  
**KDB 662911 D01 Multiple Transmitter Output v02r01**  
**ANSI C63.10-2013**

All test items have been performed and recorded as per the above standards.

**NOTE:** The EUT has been verified to comply with the requirements of FCC Part 15, Subpart B, Class B (DoC). The test report has been issued separately.



## 4 Test Types and Results

### 4.1 Radiated Emission and Bandedge Measurement

#### 4.1.1 Limits of Radiated Emission and Bandedge Measurement

Radiated emissions which fall in the restricted bands must comply with the radiated emission limits specified as below table.

Frequencies (MHz)	Field Strength (microvolts/meter)	Measurement Distance (meters)
0.009 ~ 0.490	2400/F(kHz)	300
0.490 ~ 1.705	24000/F(kHz)	30
1.705 ~ 30.0	30	30
30 ~ 88	100	3
88 ~ 216	150	3
216 ~ 960	200	3
Above 960	500	3

#### NOTE:

1. The lower limit shall apply at the transition frequencies.
2. Emission level (dBuV/m) = 20 log Emission level (uV/m).
3. For frequencies above 1000MHz, the field strength limits are based on average detector, however, the peak field strength of any emission shall not exceed the maximum permitted average limits, specified above by more than 20dB under any condition of modulation.

Limits of unwanted emission out of the restricted bands

Applicable To		Limit	
789033 D02 General UNII Test Procedure New Rules v01r04		Field Strength at 3m	
		PK:74 (dBuV/m)	AV:54 (dBuV/m)
Frequency Band	Applicable To	EIRP Limit	Equivalent Field Strength at 3m
5150~5250 MHz	15.407(b)(1)	PK:-27 (dBm/MHz)	PK:68.2(dBuV/m)
5250~5350 MHz	15.407(b)(2)		
5470~5725 MHz	15.407(b)(3)		
5725~5850 MHz	<input checked="" type="checkbox"/> 15.407(b)(4)(i)	PK:-27 (dBm/MHz) <sup>*1</sup> PK:10 (dBm/MHz) <sup>*2</sup> PK:15.6 (dBm/MHz) <sup>*3</sup> PK:27 (dBm/MHz) <sup>*4</sup>	PK: 68.2(dBuV/m) <sup>*1</sup> PK:105.2 (dBuV/m) <sup>*2</sup> PK: 110.8(dBuV/m) <sup>*3</sup> PK:122.2 (dBuV/m) <sup>*4</sup>
	<input type="checkbox"/> 15.407(b)(4)(ii)	Emission limits in section 15.247(d)	
<sup>*1</sup> beyond 75 MHz or more above of the band edge.		<sup>*2</sup> below the band edge increasing linearly to 10 dBm/MHz at 25 MHz above.	
<sup>*3</sup> below the band edge increasing linearly to a level of 15.6 dBm/MHz at 5 MHz above.		<sup>*4</sup> from 5 MHz above or below the band edge increasing linearly to a level of 27 dBm/MHz at the band edge.	

#### Note:

The following formula is used to convert the equipment isotropic radiated power (eirp) to field strength:

$$E = \frac{1000000\sqrt{30P}}{3} \mu\text{V/m, where } P \text{ is the eirp (Watts).}$$

## 4.1.2 Test Instruments

## Below 1GHz:

DESCRIPTION & MANUFACTURER	MODEL NO.	SERIAL NO.	CALIBRATED DATE	CALIBRATED UNTIL
Test Receiver Keysight	N9038A	MY54450088	July 20, 2016	July 19, 2017
Pre-Amplifier <sup>(*)</sup> EMCI	EMC001340	980142	Jan. 20, 2016	Jan. 19, 2018
Loop Antenna <sup>(*)</sup> Electro-Metrics	EM-6879	264	Dec. 16, 2016	Dec. 15, 2018
RF Cable	NA	LOOPCAB-001 LOOPCAB-002	Jan. 17, 2017	Jan. 16, 2018
Pre-Amplifier Mini-Circuits	ZFL-1000VH2B	AMP-ZFL-01	Nov. 10, 2016	Nov. 09, 2017
Trilog Broadband Antenna SCHWARZBECK	VULB 9168	9168-406	Dec. 13, 2016	Dec. 12, 2017
RF Cable	8D	966-4-1 966-4-2 966-4-3	Apr. 02, 2016	Apr. 01, 2017
Fixed attenuator Mini-Circuits	UNAT-5+	PAD-3m-4-01	Oct. 05, 2016	Oct. 04, 2017
Software	ADT_Radiated_V8.7.08	NA	NA	NA
Antenna Tower & Turn Table Max-Full	MF-7802	MF780208410	NA	NA

**Note:**

1. The calibration interval of the above test instruments is 12 months and the calibrations are traceable to NML/ROC and NIST/USA.
2. \*The calibration interval of the above test instruments is 24 months and the calibrations are traceable to NML/ROC and NIST/USA.
3. The test was performed in 966 Chamber No. 4.
4. The FCC Designation Number is TW2022.
5. The CANADA Site Registration No. is 20331-2
6. Loop antenna was used for all emissions below 30 MHz.
7. Tested Date: Mar. 20, 2017.

**For Other Test:**

DESCRIPTION & MANUFACTURER	MODEL NO.	SERIAL NO.	CALIBRATED DATE	CALIBRATED UNTIL
Test Receiver Keysight	N9038A	MY54450088	July 08, 2017	July 07, 2018
Horn_Antenna SCHWARZBECK	BBHA 9120D	9120D-783	Dec. 27, 2016	Dec. 26, 2017
Pre-Amplifier EMCI	EMC12630SE	980385	Feb. 02, 2017	Feb. 01, 2018
RF Cable	EMC104-SM-SM-1200	160923	Feb. 02, 2017	Feb. 01, 2018
	EMC104-SM-SM-2000	150318	Mar. 29, 2017	Mar. 28, 2018
	EMC104-SM-SM-5000	150321	Mar. 29, 2017	Mar. 28, 2018
Pre-Amplifier EMCI	EMC184045SE	980387	Feb. 02, 2017	Feb. 01, 2018
Horn_Antenna SCHWARZBECK	BBHA 9170	BBHA9170608	Dec. 15, 2016	Dec. 14, 2017
RF Cable	SUCOFLEX 102	36432/2 36433/2	Jan. 15, 2017	Jan. 14, 2018
Software	ADT_Radiated_V8.7.08	NA	NA	NA
Antenna Tower & Turn Table Max-Full	MF-7802	MF780208410	NA	NA
Boresight Antenna Fixture	FBA-01	FBA-SIP02	NA	NA
Spectrum Analyzer R&S	FSV40	100964	July 1, 2017	June 30, 2018
Power meter Anritsu	ML2495A	1014008	May 11, 2017	May 10, 2018
Power sensor Anritsu	MA2411B	0917122	May 11, 2017	May 10, 2018
AC Power Source Extech Electronics	6205	1440452	NA	NA
Temperature & Humidity Chamber Giant Force	GTH-150-40-SP-AR	MAA0812-008	Jan. 11, 2017	Jan. 10, 2018
Digital Multimeter FLUKE	87III	73680266	Nov. 10, 2016	Nov. 09, 2017

**Note:**

1. The calibration interval of the above test instruments is 12 months and the calibrations are traceable to NML/ROC and NIST/USA.
2. \*The calibration interval of the above test instruments is 24 months and the calibrations are traceable to NML/ROC and NIST/USA.
3. The test was performed in 966 Chamber No. 4.
4. The FCC Designation Number is TW2022.
5. The CANADA Site Registration No. is 20331-2
5. Loop antenna was used for all emissions below 30 MHz.
7. Tested Date: Aug. 30 to 31, 2017

#### 4.1.3 Test Procedure

##### **For Radiated emission below 30MHz**

- a. The EUT was placed on the top of a rotating table 0.8 meters above the ground at a 3 meter chamber room. The table was rotated 360 degrees to determine the position of the highest radiation.
- b. The EUT was set 3 meters away from the interference-receiving antenna, which was mounted on the top of a variable-height antenna tower.
- c. Both X and Y axes of the antenna are set to make the measurement.
- d. For each suspected emission, the EUT was arranged to its worst case and the rotatable table was turned from 0 degrees to 360 degrees to find the maximum reading.
- e. The test-receiver system was set to Quasi-Peak Detect Function and Specified Bandwidth with Maximum Hold Mode.

##### **NOTE:**

1. The resolution bandwidth and video bandwidth of test receiver/spectrum analyzer is 9kHz at frequency below 30MHz.

##### **For Radiated emission above 30MHz**

- a. The EUT was placed on the top of a rotating table 0.8 meters (for 30MHz ~ 1GHz) / 1.5 meters (for above 1GHz) above the ground at 3 meter chamber room for test. The table was rotated 360 degrees to determine the position of the highest radiation.
- b. The EUT was set 3 meters away from the interference-receiving antenna, which was mounted on the top of a variable-height antenna tower.
- c. The height of antenna is varied from one meter to four meters above the ground to determine the maximum value of the field strength. Both horizontal and vertical polarizations of the antenna are set to make the measurement.
- d. For each suspected emission, the EUT was arranged to its worst case and then the antenna was tuned to heights from 1 meter to 4 meters and the rotatable table was turned from 0 degrees to 360 degrees to find the maximum reading.
- e. The test-receiver system was set to quasi-peak detect function and specified bandwidth with maximum hold mode when the test frequency is below 1 GHz.
- f. The test-receiver system was set to peak and average detect function and specified bandwidth with maximum hold mode when the test frequency is above 1 GHz. If the peak reading value also meets average limit, measurement with the average detector is unnecessary.

##### **Note:**

1. The resolution bandwidth and video bandwidth of test receiver/spectrum analyzer is 120kHz for Quasi-peak detection (QP) at frequency below 1GHz.
2. The resolution bandwidth of test receiver/spectrum analyzer is 1 MHz and the video bandwidth is 3 MHz for Peak detection (PK) at frequency above 1GHz.
3. The resolution bandwidth of test receiver/spectrum analyzer is 1MHz and the video bandwidth is  $\geq 1/T$  (Duty cycle < 98%) or 10Hz (Duty cycle  $\geq 98\%$ ) for Average detection (AV) at frequency above 1GHz.
4. All modes of operation were investigated and the worst-case emissions are reported.

#### 4.1.4 Deviation from Test Standard

No deviation.

#### 4.1.5 Test Setup

##### For Radiated emission below 30MHz

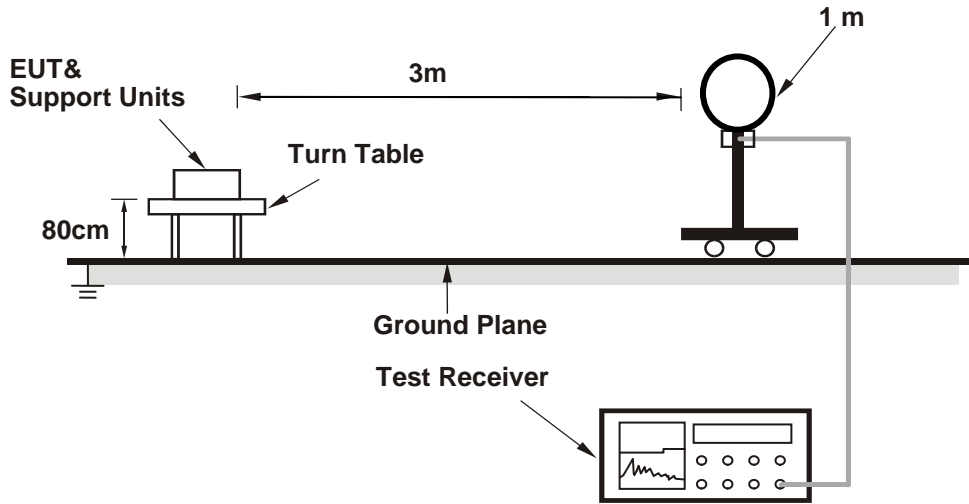

##### For Radiated emission 30MHz to 1GHz

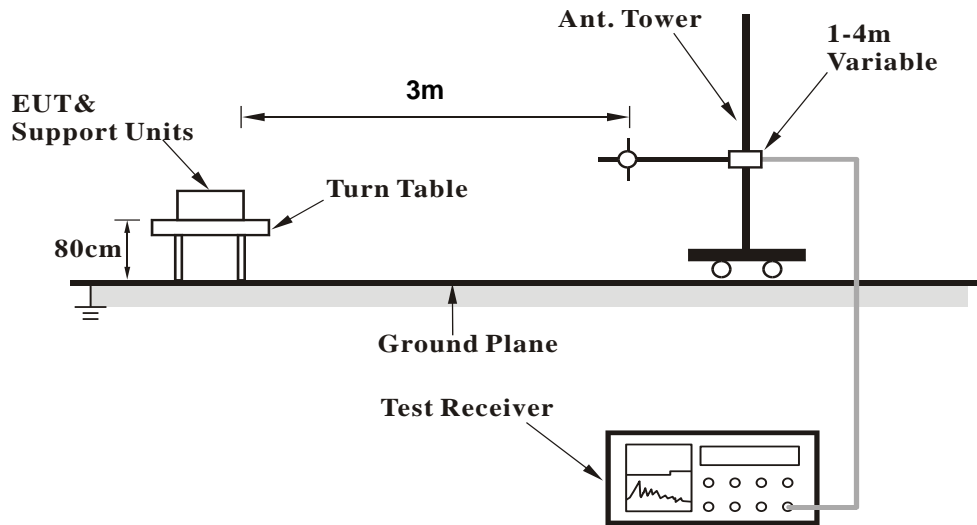

### For Radiated emission above 1GHz

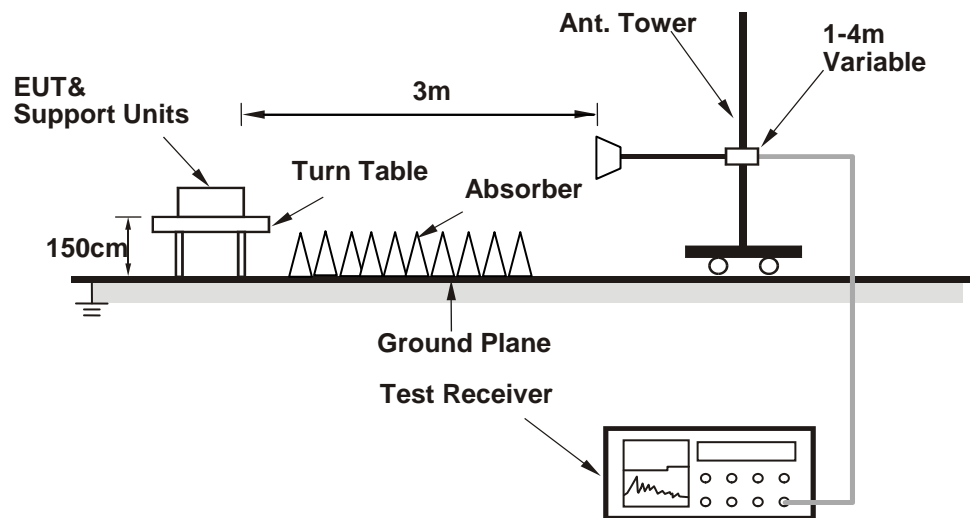

For the actual test configuration, please refer to the attached file (Test Setup Photo).

#### 4.1.6 EUT Operating Condition

- a. Connected the EUT with the Laptop which is placed on remote site.
- b. Controlling software (MT7615 QA 0.0.1.73) has been activated to set the EUT on specific status.

## 4.1.7 Test Results

## Above 1GHz Data:

## 802.11a

<b>CHANNEL</b>	TX Channel 36	<b>DETECTOR FUNCTION</b>	Peak (PK)
<b>FREQUENCY RANGE</b>	1GHz ~ 40GHz		Average (AV)

ANTENNA POLARITY & TEST DISTANCE: HORIZONTAL AT 3 M								
NO.	FREQ. (MHz)	EMISSION LEVEL (dBuV/m)	LIMIT (dBuV/m)	MARGIN (dB)	ANTENNA HEIGHT (m)	TABLE ANGLE (Degree)	RAW VALUE (dBuV)	CORRECTION FACTOR (dB/m)
1	5150.00	52.8 PK	74.0	-21.2	1.21 H	15	48.8	4.0
2	5150.00	41.8 AV	54.0	-12.2	1.21 H	15	37.8	4.0
3	*5180.00	100.4 PK			1.21 H	15	96.4	4.0
4	*5180.00	91.2 AV			1.21 H	15	87.2	4.0
5	#10360.00	55.5 PK	74.0	-18.5	1.01 H	174	41.9	13.6
6	#10360.00	43.0 AV	54.0	-11.0	1.01 H	174	29.4	13.6
7	15540.00	54.3 PK	74.0	-19.7	1.97 H	205	41.1	13.2
8	15540.00	41.9 AV	54.0	-12.1	1.97 H	205	28.7	13.2

ANTENNA POLARITY & TEST DISTANCE: VERTICAL AT 3 M								
NO.	FREQ. (MHz)	EMISSION LEVEL (dBuV/m)	LIMIT (dBuV/m)	MARGIN (dB)	ANTENNA HEIGHT (m)	TABLE ANGLE (Degree)	RAW VALUE (dBuV)	CORRECTION FACTOR (dB/m)
1	5150.00	64.4 PK	74.0	-9.6	1.54 V	140	60.4	4.0
2	<b>5150.00</b>	<b>53.9 AV</b>	<b>54.0</b>	<b>-0.1</b>	<b>1.54 V</b>	<b>140</b>	<b>49.9</b>	<b>4.0</b>
3	*5180.00	123.9 PK			1.54 V	140	119.9	4.0
4	*5180.00	114.7 AV			1.54 V	140	110.7	4.0
5	#10360.00	56.5 PK	74.0	-17.5	1.50 V	187	42.9	13.6
6	#10360.00	43.9 AV	54.0	-10.1	1.50 V	187	30.3	13.6
7	15540.00	53.5 PK	74.0	-20.5	1.23 V	360	40.3	13.2
8	15540.00	41.3 AV	54.0	-12.7	1.23 V	360	28.1	13.2

## REMARKS:

- Emission Level(dBuV/m) = Raw Value(dBuV) + Correction Factor(dB/m)
- Correction Factor(dB/m) = Antenna Factor(dB/m) + Cable Factor(dB) – Pre-Amplifier Factor(dB)
- The other emission levels were very low against the limit.
- Margin value = Emission Level – Limit value
- " \* ": Fundamental frequency.
- " # ": The radiated frequency is out of the restricted band.

<b>CHANNEL</b>	TX Channel 40	<b>DETECTOR FUNCTION</b>	Peak (PK)
<b>FREQUENCY RANGE</b>	1GHz ~ 40GHz		Average (AV)

**ANTENNA POLARITY & TEST DISTANCE: HORIZONTAL AT 3 M**

NO.	FREQ. (MHz)	EMISSION LEVEL (dBuV/m)	LIMIT (dBuV/m)	MARGIN (dB)	ANTENNA HEIGHT (m)	TABLE ANGLE (Degree)	RAW VALUE (dBuV)	CORRECTION FACTOR (dB/m)
1	5150.00	50.1 PK	74.0	-23.9	1.21 H	39	46.1	4.0
2	5150.00	39.2 AV	54.0	-14.8	1.21 H	39	35.2	4.0
3	*5200.00	100.1 PK			1.21 H	39	96.1	4.0
4	*5200.00	90.7 AV			1.21 H	39	86.7	4.0
5	#10400.00	54.9 PK	74.0	-19.1	1.05 H	173	41.3	13.6
6	#10400.00	42.4 AV	54.0	-11.6	1.05 H	173	28.8	13.6
7	15600.00	53.9 PK	74.0	-20.1	1.97 H	225	40.5	13.4
8	15600.00	41.9 AV	54.0	-12.1	1.97 H	225	28.5	13.4

**ANTENNA POLARITY & TEST DISTANCE: VERTICAL AT 3 M**

NO.	FREQ. (MHz)	EMISSION LEVEL (dBuV/m)	LIMIT (dBuV/m)	MARGIN (dB)	ANTENNA HEIGHT (m)	TABLE ANGLE (Degree)	RAW VALUE (dBuV)	CORRECTION FACTOR (dB/m)
1	5150.00	56.8 PK	74.0	-17.2	1.51 V	135	52.8	4.0
2	5150.00	47.3 AV	54.0	-6.7	1.51 V	135	43.3	4.0
3	*5200.00	123.8 PK			1.51 V	135	119.8	4.0
4	*5200.00	114.5 AV			1.51 V	135	110.5	4.0
5	#10400.00	55.7 PK	74.0	-18.3	1.49 V	178	42.1	13.6
6	#10400.00	43.3 AV	54.0	-10.7	1.49 V	178	29.7	13.6
7	15600.00	54.0 PK	74.0	-20.0	1.35 V	351	40.6	13.4
8	15600.00	41.6 AV	54.0	-12.4	1.35 V	351	28.2	13.4

**REMARKS:**

1. Emission Level(dBuV/m) = Raw Value(dBuV) + Correction Factor(dB/m)
2. Correction Factor(dB/m) = Antenna Factor(dB/m) + Cable Factor(dB) – Pre-Amplifier Factor(dB)
3. The other emission levels were very low against the limit.
4. Margin value = Emission Level – Limit value
5. " \* ": Fundamental frequency.
6. " # ": The radiated frequency is out of the restricted band.



<b>CHANNEL</b>	TX Channel 48	<b>DETECTOR FUNCTION</b>	Peak (PK)
<b>FREQUENCY RANGE</b>	1GHz ~ 40GHz		Average (AV)

**ANTENNA POLARITY & TEST DISTANCE: HORIZONTAL AT 3 M**

NO.	FREQ. (MHz)	EMISSION LEVEL (dBuV/m)	LIMIT (dBuV/m)	MARGIN (dB)	ANTENNA HEIGHT (m)	TABLE ANGLE (Degree)	RAW VALUE (dBuV)	CORRECTION FACTOR (dB/m)
1	5150.00	48.8 PK	74.0	-25.2	1.29 H	27	44.8	4.0
2	5150.00	36.8 AV	54.0	-17.2	1.29 H	27	32.8	4.0
3	*5240.00	100.4 PK			1.29 H	27	96.2	4.2
4	*5240.00	91.0 AV			1.29 H	27	86.8	4.2
5	5350.00	47.7 PK	74.0	-26.3	1.29 H	27	43.3	4.4
6	5350.00	35.8 AV	54.0	-18.2	1.29 H	27	31.4	4.4
7	#10480.00	56.1 PK	74.0	-17.9	1.05 H	196	42.4	13.7
8	#10480.00	43.7 AV	54.0	-10.3	1.05 H	196	30.0	13.7
9	15720.00	55.2 PK	74.0	-18.8	1.97 H	218	41.2	14.0
10	15720.00	42.8 AV	54.0	-11.2	1.97 H	218	28.8	14.0

**ANTENNA POLARITY & TEST DISTANCE: VERTICAL AT 3 M**

NO.	FREQ. (MHz)	EMISSION LEVEL (dBuV/m)	LIMIT (dBuV/m)	MARGIN (dB)	ANTENNA HEIGHT (m)	TABLE ANGLE (Degree)	RAW VALUE (dBuV)	CORRECTION FACTOR (dB/m)
1	5150.00	53.6 PK	74.0	-20.4	1.54 V	139	49.6	4.0
2	5150.00	43.5 AV	54.0	-10.5	1.54 V	139	39.5	4.0
3	*5240.00	124.9 PK			1.54 V	139	120.7	4.2
4	*5240.00	115.0 AV			1.54 V	139	110.8	4.2
5	5350.00	53.4 PK	74.0	-20.6	1.54 V	139	49.0	4.4
6	5350.00	43.3 AV	54.0	-10.7	1.54 V	139	38.9	4.4
7	#10480.00	55.4 PK	74.0	-18.6	1.47 V	173	41.7	13.7
8	#10480.00	43.5 AV	54.0	-10.5	1.47 V	173	29.8	13.7
9	15720.00	53.5 PK	74.0	-20.5	1.30 V	351	39.5	14.0
10	15720.00	41.1 AV	54.0	-12.9	1.30 V	351	27.1	14.0

**REMARKS:**

1. Emission Level(dBuV/m) = Raw Value(dBuV) + Correction Factor(dB/m)
2. Correction Factor(dB/m) = Antenna Factor(dB/m) + Cable Factor(dB) – Pre-Amplifier Factor(dB)
3. The other emission levels were very low against the limit.
4. Margin value = Emission Level – Limit value
5. " \* ": Fundamental frequency.
6. " # ": The radiated frequency is out of the restricted band.

<b>CHANNEL</b>	TX Channel 149	<b>DETECTOR FUNCTION</b>	Peak (PK)
<b>FREQUENCY RANGE</b>	1GHz ~ 40GHz		Average (AV)

**ANTENNA POLARITY & TEST DISTANCE: HORIZONTAL AT 3 M**

NO.	FREQ. (MHz)	EMISSION LEVEL (dBuV/m)	LIMIT (dBuV/m)	MARGIN (dB)	ANTENNA HEIGHT (m)	TABLE ANGLE (Degree)	RAW VALUE (dBuV)	CORRECTION FACTOR (dB/m)
1	*5745.00	107.7 PK			1.52 H	344	102.7	5.0
2	*5745.00	99.9 AV			1.52 H	344	94.9	5.0
3	11490.00	57.8 PK	74.0	-16.2	1.69 H	183	43.7	14.1
4	11490.00	45.5 AV	54.0	-8.5	1.69 H	183	31.4	14.1
5	#17235.00	57.1 PK	74.0	-16.9	3.12 H	58	38.8	18.3
6	#17235.00	46.7 AV	54.0	-7.3	3.12 H	58	28.4	18.3

**ANTENNA POLARITY & TEST DISTANCE: VERTICAL AT 3 M**

NO.	FREQ. (MHz)	EMISSION LEVEL (dBuV/m)	LIMIT (dBuV/m)	MARGIN (dB)	ANTENNA HEIGHT (m)	TABLE ANGLE (Degree)	RAW VALUE (dBuV)	CORRECTION FACTOR (dB/m)
1	*5745.00	125.7 PK			1.82 V	5	120.7	5.0
2	*5745.00	116.7 AV			1.82 V	5	111.7	5.0
3	11490.00	58.2 PK	74.0	-15.8	2.81 V	165	44.1	14.1
4	11490.00	46.0 AV	54.0	-8.0	2.81 V	165	31.9	14.1
5	#17235.00	57.1 PK	74.0	-16.9	2.12 V	313	38.8	18.3
6	#17235.00	48.4 AV	54.0	-5.6	2.12 V	313	30.1	18.3

**REMARKS:**

1. Emission Level(dBuV/m) = Raw Value(dBuV) + Correction Factor(dB/m)
2. Correction Factor(dB/m) = Antenna Factor(dB/m) + Cable Factor(dB) – Pre-Amplifier Factor(dB)
3. The other emission levels were very low against the limit.
4. Margin value = Emission Level – Limit value
5. " \* ": Fundamental frequency.
6. " # ": The radiated frequency is out of the restricted band.

<b>CHANNEL</b>	TX Channel 157	<b>DETECTOR FUNCTION</b>	Peak (PK)
<b>FREQUENCY RANGE</b>	1GHz ~ 40GHz		Average (AV)

**ANTENNA POLARITY & TEST DISTANCE: HORIZONTAL AT 3 M**

NO.	FREQ. (MHz)	EMISSION LEVEL (dBuV/m)	LIMIT (dBuV/m)	MARGIN (dB)	ANTENNA HEIGHT (m)	TABLE ANGLE (Degree)	RAW VALUE (dBuV)	CORRECTION FACTOR (dB/m)
1	*5785.00	107.8 PK			1.45 H	345	102.8	5.0
2	*5785.00	100.0 AV			1.45 H	345	95.0	5.0
3	11570.00	57.0 PK	74.0	-17.0	1.58 H	178	43.0	14.0
4	11570.00	44.7 AV	54.0	-9.3	1.58 H	178	30.7	14.0
5	#17355.00	56.9 PK	74.0	-17.1	3.16 H	39	38.0	18.9
6	#17355.00	46.3 AV	54.0	-7.7	3.16 H	39	27.4	18.9

**ANTENNA POLARITY & TEST DISTANCE: VERTICAL AT 3 M**

NO.	FREQ. (MHz)	EMISSION LEVEL (dBuV/m)	LIMIT (dBuV/m)	MARGIN (dB)	ANTENNA HEIGHT (m)	TABLE ANGLE (Degree)	RAW VALUE (dBuV)	CORRECTION FACTOR (dB/m)
1	*5785.00	124.9 PK			1.80 V	10	119.9	5.0
2	*5785.00	116.1 AV			1.80 V	10	111.1	5.0
3	11570.00	58.0 PK	74.0	-16.0	2.72 V	178	44.0	14.0
4	11570.00	46.1 AV	54.0	-7.9	2.72 V	178	32.1	14.0
5	#17355.00	56.9 PK	74.0	-17.1	2.09 V	280	38.0	18.9
6	#17355.00	48.3 AV	54.0	-5.7	2.09 V	280	29.4	18.9

**REMARKS:**

1. Emission Level(dBuV/m) = Raw Value(dBuV) + Correction Factor(dB/m)
2. Correction Factor(dB/m) = Antenna Factor(dB/m) + Cable Factor(dB) – Pre-Amplifier Factor(dB)
3. The other emission levels were very low against the limit.
4. Margin value = Emission Level – Limit value
5. " \* ": Fundamental frequency.
6. " # ": The radiated frequency is out of the restricted band.

<b>CHANNEL</b>	TX Channel 165	<b>DETECTOR FUNCTION</b>	Peak (PK)
<b>FREQUENCY RANGE</b>	1GHz ~ 40GHz		Average (AV)

**ANTENNA POLARITY & TEST DISTANCE: HORIZONTAL AT 3 M**

NO.	FREQ. (MHz)	EMISSION LEVEL (dBuV/m)	LIMIT (dBuV/m)	MARGIN (dB)	ANTENNA HEIGHT (m)	TABLE ANGLE (Degree)	RAW VALUE (dBuV)	CORRECTION FACTOR (dB/m)
1	*5825.00	108.9 PK			1.58 H	360	103.7	5.2
2	*5825.00	100.7 AV			1.58 H	360	95.5	5.2
3	11650.00	56.9 PK	74.0	-17.1	1.63 H	163	42.8	14.1
4	11650.00	44.7 AV	54.0	-9.3	1.63 H	163	30.6	14.1
5	#17475.00	57.2 PK	74.0	-16.8	3.08 H	68	37.5	19.7
6	#17475.00	46.7 AV	54.0	-7.3	3.08 H	68	27.0	19.7

**ANTENNA POLARITY & TEST DISTANCE: VERTICAL AT 3 M**

NO.	FREQ. (MHz)	EMISSION LEVEL (dBuV/m)	LIMIT (dBuV/m)	MARGIN (dB)	ANTENNA HEIGHT (m)	TABLE ANGLE (Degree)	RAW VALUE (dBuV)	CORRECTION FACTOR (dB/m)
1	*5825.00	125.7 PK			1.80 V	5	120.5	5.2
2	*5825.00	116.4 AV			1.80 V	5	111.2	5.2
3	11650.00	57.1 PK	74.0	-16.9	2.75 V	186	43.0	14.1
4	11650.00	45.2 AV	54.0	-8.8	2.75 V	186	31.1	14.1
5	#17475.00	57.8 PK	74.0	-16.2	2.03 V	301	38.1	19.7
6	#17475.00	49.1 AV	54.0	-4.9	2.03 V	301	29.4	19.7

**REMARKS:**

1. Emission Level(dBuV/m) = Raw Value(dBuV) + Correction Factor(dB/m)
2. Correction Factor(dB/m) = Antenna Factor(dB/m) + Cable Factor(dB) – Pre-Amplifier Factor(dB)
3. The other emission levels were very low against the limit.
4. Margin value = Emission Level – Limit value
5. " \* ": Fundamental frequency.
6. " # ": The radiated frequency is out of the restricted band.

**802.11ac (VHT20)**

<b>CHANNEL</b>	TX Channel 36	<b>DETECTOR FUNCTION</b>	Peak (PK)
<b>FREQUENCY RANGE</b>	1GHz ~ 40GHz		Average (AV)

**ANTENNA POLARITY & TEST DISTANCE: HORIZONTAL AT 3 M**

NO.	FREQ. (MHz)	EMISSION LEVEL (dBuV/m)	LIMIT (dBuV/m)	MARGIN (dB)	ANTENNA HEIGHT (m)	TABLE ANGLE (Degree)	RAW VALUE (dBuV)	CORRECTION FACTOR (dB/m)
1	5150.00	51.1 PK	74.0	-22.9	1.14 H	22	47.1	4.0
2	5150.00	42.0 AV	54.0	-12.0	1.14 H	22	38.0	4.0
3	*5180.00	97.3 PK			1.14 H	22	93.3	4.0
4	*5180.00	86.6 AV			1.14 H	22	82.6	4.0
5	#10360.00	56.8 PK	74.0	-17.2	1.00 H	176	43.2	13.6
6	#10360.00	44.0 AV	54.0	-10.0	1.00 H	176	30.4	13.6
7	15540.00	54.0 PK	74.0	-20.0	1.87 H	224	40.8	13.2
8	15540.00	41.9 AV	54.0	-12.1	1.87 H	224	28.7	13.2

**ANTENNA POLARITY & TEST DISTANCE: VERTICAL AT 3 M**

NO.	FREQ. (MHz)	EMISSION LEVEL (dBuV/m)	LIMIT (dBuV/m)	MARGIN (dB)	ANTENNA HEIGHT (m)	TABLE ANGLE (Degree)	RAW VALUE (dBuV)	CORRECTION FACTOR (dB/m)
1	5150.00	62.4 PK	74.0	-11.6	1.50 V	358	58.4	4.0
2	<b>5150.00</b>	<b>53.9 AV</b>	<b>54.0</b>	<b>-0.1</b>	<b>1.50 V</b>	<b>358</b>	<b>49.9</b>	<b>4.0</b>
3	*5180.00	121.0 PK			1.50 V	358	117.0	4.0
4	*5180.00	110.5 AV			1.50 V	358	106.5	4.0
5	#10360.00	55.6 PK	74.0	-18.4	1.49 V	175	42.0	13.6
6	#10360.00	43.5 AV	54.0	-10.5	1.49 V	175	29.9	13.6
7	15540.00	53.0 PK	74.0	-21.0	1.39 V	360	39.8	13.2
8	15540.00	40.8 AV	54.0	-13.2	1.39 V	360	27.6	13.2

**REMARKS:**

- Emission Level(dBuV/m) = Raw Value(dBuV) + Correction Factor(dB/m)
- Correction Factor(dB/m) = Antenna Factor(dB/m) + Cable Factor(dB) – Pre-Amplifier Factor(dB)
- The other emission levels were very low against the limit.
- Margin value = Emission Level – Limit value
- " \* ": Fundamental frequency.
- " # ": The radiated frequency is out of the restricted band.

<b>CHANNEL</b>	TX Channel 40	<b>DETECTOR FUNCTION</b>	Peak (PK)
<b>FREQUENCY RANGE</b>	1GHz ~ 40GHz		Average (AV)

**ANTENNA POLARITY & TEST DISTANCE: HORIZONTAL AT 3 M**

NO.	FREQ. (MHz)	EMISSION LEVEL (dBuV/m)	LIMIT (dBuV/m)	MARGIN (dB)	ANTENNA HEIGHT (m)	TABLE ANGLE (Degree)	RAW VALUE (dBuV)	CORRECTION FACTOR (dB/m)
1	5150.00	50.5 PK	74.0	-23.5	1.23 H	30	46.5	4.0
2	5150.00	39.5 AV	54.0	-14.5	1.23 H	30	35.5	4.0
3	*5200.00	99.3 PK			1.23 H	30	95.3	4.0
4	*5200.00	88.4 AV			1.23 H	30	84.4	4.0
5	#10400.00	55.3 PK	74.0	-18.7	1.10 H	156	41.7	13.6
6	#10400.00	42.6 AV	54.0	-11.4	1.10 H	156	29.0	13.6
7	15600.00	53.7 PK	74.0	-20.3	1.88 H	212	40.3	13.4
8	15600.00	41.3 AV	54.0	-12.7	1.88 H	212	27.9	13.4

**ANTENNA POLARITY & TEST DISTANCE: VERTICAL AT 3 M**

NO.	FREQ. (MHz)	EMISSION LEVEL (dBuV/m)	LIMIT (dBuV/m)	MARGIN (dB)	ANTENNA HEIGHT (m)	TABLE ANGLE (Degree)	RAW VALUE (dBuV)	CORRECTION FACTOR (dB/m)
1	5150.00	57.3 PK	74.0	-16.7	1.34 V	360	53.3	4.0
2	5150.00	47.6 AV	54.0	-6.4	1.34 V	360	43.6	4.0
3	*5200.00	121.5 PK			1.34 V	360	117.5	4.0
4	*5200.00	111.1 AV			1.34 V	360	107.1	4.0
5	#10400.00	55.0 PK	74.0	-19.0	1.51 V	174	41.4	13.6
6	#10400.00	42.8 AV	54.0	-11.2	1.51 V	174	29.2	13.6
7	15600.00	52.7 PK	74.0	-21.3	1.34 V	360	39.3	13.4
8	15600.00	40.5 AV	54.0	-13.5	1.34 V	360	27.1	13.4

**REMARKS:**

1. Emission Level(dBuV/m) = Raw Value(dBuV) + Correction Factor(dB/m)
2. Correction Factor(dB/m) = Antenna Factor(dB/m) + Cable Factor(dB) – Pre-Amplifier Factor(dB)
3. The other emission levels were very low against the limit.
4. Margin value = Emission Level – Limit value
5. " \* ": Fundamental frequency.
6. " # ": The radiated frequency is out of the restricted band.

<b>CHANNEL</b>	TX Channel 48	<b>DETECTOR FUNCTION</b>	Peak (PK)
<b>FREQUENCY RANGE</b>	1GHz ~ 40GHz		Average (AV)

**ANTENNA POLARITY & TEST DISTANCE: HORIZONTAL AT 3 M**

NO.	FREQ. (MHz)	EMISSION LEVEL (dBuV/m)	LIMIT (dBuV/m)	MARGIN (dB)	ANTENNA HEIGHT (m)	TABLE ANGLE (Degree)	RAW VALUE (dBuV)	CORRECTION FACTOR (dB/m)
1	5150.00	48.6 PK	74.0	-25.4	1.27 H	26	44.6	4.0
2	5150.00	36.9 AV	54.0	-17.1	1.27 H	26	32.9	4.0
3	*5240.00	97.9 PK			1.27 H	26	93.7	4.2
4	*5240.00	87.6 AV			1.27 H	26	83.4	4.2
5	5350.00	48.6 PK	74.0	-25.4	1.27 H	26	44.2	4.4
6	5350.00	36.5 AV	54.0	-17.5	1.27 H	26	32.1	4.4
7	#10480.00	55.6 PK	74.0	-18.4	1.09 H	195	41.9	13.7
8	#10480.00	43.0 AV	54.0	-11.0	1.09 H	195	29.3	13.7
9	15720.00	53.2 PK	74.0	-20.8	1.90 H	239	39.2	14.0
10	15720.00	41.3 AV	54.0	-12.7	1.90 H	239	27.3	14.0

**ANTENNA POLARITY & TEST DISTANCE: VERTICAL AT 3 M**

NO.	FREQ. (MHz)	EMISSION LEVEL (dBuV/m)	LIMIT (dBuV/m)	MARGIN (dB)	ANTENNA HEIGHT (m)	TABLE ANGLE (Degree)	RAW VALUE (dBuV)	CORRECTION FACTOR (dB/m)
1	5150.00	54.0 PK	74.0	-20.0	1.32 V	360	50.0	4.0
2	5150.00	43.7 AV	54.0	-10.3	1.32 V	360	39.7	4.0
3	*5240.00	121.8 PK			1.32 V	360	117.6	4.2
4	*5240.00	111.1 AV			1.32 V	360	106.9	4.2
5	5350.00	53.3 PK	74.0	-20.7	1.32 V	360	48.9	4.4
6	5350.00	43.1 AV	54.0	-10.9	1.32 V	360	38.7	4.4
7	#10480.00	56.0 PK	74.0	-18.0	1.49 V	181	42.3	13.7
8	#10480.00	43.9 AV	54.0	-10.1	1.49 V	181	30.2	13.7
9	15720.00	53.4 PK	74.0	-20.6	1.31 V	357	39.4	14.0
10	15720.00	41.0 AV	54.0	-13.0	1.31 V	357	27.0	14.0

**REMARKS:**

1. Emission Level(dBuV/m) = Raw Value(dBuV) + Correction Factor(dB/m)
2. Correction Factor(dB/m) = Antenna Factor(dB/m) + Cable Factor(dB) – Pre-Amplifier Factor(dB)
3. The other emission levels were very low against the limit.
4. Margin value = Emission Level – Limit value
5. " \* ": Fundamental frequency.
6. " # ": The radiated frequency is out of the restricted band.

<b>CHANNEL</b>	TX Channel 149	<b>DETECTOR FUNCTION</b>	Peak (PK)
<b>FREQUENCY RANGE</b>	1GHz ~ 40GHz		Average (AV)

**ANTENNA POLARITY & TEST DISTANCE: HORIZONTAL AT 3 M**

NO.	FREQ. (MHz)	EMISSION LEVEL (dBuV/m)	LIMIT (dBuV/m)	MARGIN (dB)	ANTENNA HEIGHT (m)	TABLE ANGLE (Degree)	RAW VALUE (dBuV)	CORRECTION FACTOR (dB/m)
1	*5745.00	110.0 PK			1.54 H	341	105.0	5.0
2	*5745.00	100.1 AV			1.54 H	341	95.1	5.0
3	11490.00	56.7 PK	74.0	-17.3	1.59 H	154	42.6	14.1
4	11490.00	44.6 AV	54.0	-9.4	1.59 H	154	30.5	14.1
5	#17235.00	57.3 PK	74.0	-16.7	3.16 H	62	39.0	18.3
6	#17235.00	46.8 AV	54.0	-7.2	3.16 H	62	28.5	18.3

**ANTENNA POLARITY & TEST DISTANCE: VERTICAL AT 3 M**

NO.	FREQ. (MHz)	EMISSION LEVEL (dBuV/m)	LIMIT (dBuV/m)	MARGIN (dB)	ANTENNA HEIGHT (m)	TABLE ANGLE (Degree)	RAW VALUE (dBuV)	CORRECTION FACTOR (dB/m)
1	*5745.00	125.7 PK			2.04 V	205	120.7	5.0
2	*5745.00	116.6 AV			2.04 V	205	111.6	5.0
3	11490.00	57.2 PK	74.0	-16.8	2.78 V	174	43.1	14.1
4	11490.00	44.9 AV	54.0	-9.1	2.78 V	174	30.8	14.1
5	#17235.00	57.0 PK	74.0	-17.0	2.19 V	318	38.7	18.3
6	#17235.00	47.9 AV	54.0	-6.1	2.19 V	318	29.6	18.3

**REMARKS:**

1. Emission Level(dBuV/m) = Raw Value(dBuV) + Correction Factor(dB/m)
2. Correction Factor(dB/m) = Antenna Factor(dB/m) + Cable Factor(dB) – Pre-Amplifier Factor(dB)
3. The other emission levels were very low against the limit.
4. Margin value = Emission Level – Limit value
5. " \* ": Fundamental frequency.
6. " # ": The radiated frequency is out of the restricted band.



<b>CHANNEL</b>	TX Channel 157	<b>DETECTOR FUNCTION</b>	Peak (PK)
<b>FREQUENCY RANGE</b>	1GHz ~ 40GHz		Average (AV)

**ANTENNA POLARITY & TEST DISTANCE: HORIZONTAL AT 3 M**

NO.	FREQ. (MHz)	EMISSION LEVEL (dBuV/m)	LIMIT (dBuV/m)	MARGIN (dB)	ANTENNA HEIGHT (m)	TABLE ANGLE (Degree)	RAW VALUE (dBuV)	CORRECTION FACTOR (dB/m)
1	*5785.00	109.7 PK			1.50 H	331	104.7	5.0
2	*5785.00	100.3 AV			1.50 H	331	95.3	5.0
3	11570.00	57.7 PK	74.0	-16.3	1.60 H	146	43.7	14.0
4	11570.00	45.6 AV	54.0	-8.4	1.60 H	146	31.6	14.0
5	#17355.00	56.6 PK	74.0	-17.4	3.10 H	42	37.7	18.9
6	#17355.00	46.0 AV	54.0	-8.0	3.10 H	42	27.1	18.9

**ANTENNA POLARITY & TEST DISTANCE: VERTICAL AT 3 M**

NO.	FREQ. (MHz)	EMISSION LEVEL (dBuV/m)	LIMIT (dBuV/m)	MARGIN (dB)	ANTENNA HEIGHT (m)	TABLE ANGLE (Degree)	RAW VALUE (dBuV)	CORRECTION FACTOR (dB/m)
1	*5785.00	125.7 PK			1.80 V	360	120.7	5.0
2	*5785.00	116.3 AV			1.80 V	360	111.3	5.0
3	11570.00	57.0 PK	74.0	-17.0	2.73 V	141	43.0	14.0
4	11570.00	45.2 AV	54.0	-8.8	2.73 V	141	31.2	14.0
5	#17355.00	56.4 PK	74.0	-17.6	2.03 V	311	37.5	18.9
6	#17355.00	47.7 AV	54.0	-6.3	2.03 V	311	28.8	18.9

**REMARKS:**

1. Emission Level(dBuV/m) = Raw Value(dBuV) + Correction Factor(dB/m)
2. Correction Factor(dB/m) = Antenna Factor(dB/m) + Cable Factor(dB) – Pre-Amplifier Factor(dB)
3. The other emission levels were very low against the limit.
4. Margin value = Emission Level – Limit value
5. " \* ": Fundamental frequency.
6. " # ": The radiated frequency is out of the restricted band.

<b>CHANNEL</b>	TX Channel 165	<b>DETECTOR FUNCTION</b>	Peak (PK)
<b>FREQUENCY RANGE</b>	1GHz ~ 40GHz		Average (AV)

**ANTENNA POLARITY & TEST DISTANCE: HORIZONTAL AT 3 M**

NO.	FREQ. (MHz)	EMISSION LEVEL (dBuV/m)	LIMIT (dBuV/m)	MARGIN (dB)	ANTENNA HEIGHT (m)	TABLE ANGLE (Degree)	RAW VALUE (dBuV)	CORRECTION FACTOR (dB/m)
1	*5825.00	110.5 PK			1.42 H	336	105.3	5.2
2	*5825.00	100.9 AV			1.42 H	336	95.7	5.2
3	11650.00	57.8 PK	74.0	-16.2	1.56 H	158	43.7	14.1
4	11650.00	45.3 AV	54.0	-8.7	1.56 H	158	31.2	14.1
5	#17475.00	57.9 PK	74.0	-16.1	3.12 H	76	38.2	19.7
6	#17475.00	47.1 AV	54.0	-6.9	3.12 H	76	27.4	19.7

**ANTENNA POLARITY & TEST DISTANCE: VERTICAL AT 3 M**

NO.	FREQ. (MHz)	EMISSION LEVEL (dBuV/m)	LIMIT (dBuV/m)	MARGIN (dB)	ANTENNA HEIGHT (m)	TABLE ANGLE (Degree)	RAW VALUE (dBuV)	CORRECTION FACTOR (dB/m)
1	*5825.00	126.2 PK			1.74 V	7	121.0	5.2
2	*5825.00	116.2 AV			1.74 V	7	111.0	5.2
3	11650.00	57.8 PK	74.0	-16.2	2.79 V	169	43.7	14.1
4	11650.00	45.8 AV	54.0	-8.2	2.79 V	169	31.7	14.1
5	#17475.00	56.9 PK	74.0	-17.1	2.12 V	300	37.2	19.7
6	#17475.00	48.5 AV	54.0	-5.5	2.12 V	300	28.8	19.7

**REMARKS:**

1. Emission Level(dBuV/m) = Raw Value(dBuV) + Correction Factor(dB/m)
2. Correction Factor(dB/m) = Antenna Factor(dB/m) + Cable Factor(dB) – Pre-Amplifier Factor(dB)
3. The other emission levels were very low against the limit.
4. Margin value = Emission Level – Limit value
5. " \* ": Fundamental frequency.
6. " # ": The radiated frequency is out of the restricted band.

**802.11ac (VHT40)**

<b>CHANNEL</b>	TX Channel 38	<b>DETECTOR FUNCTION</b>	Peak (PK)
<b>FREQUENCY RANGE</b>	1GHz ~ 40GHz		Average (AV)

**ANTENNA POLARITY & TEST DISTANCE: HORIZONTAL AT 3 M**

NO.	FREQ. (MHz)	EMISSION LEVEL (dBuV/m)	LIMIT (dBuV/m)	MARGIN (dB)	ANTENNA HEIGHT (m)	TABLE ANGLE (Degree)	RAW VALUE (dBuV)	CORRECTION FACTOR (dB/m)
1	5150.00	54.8 PK	74.0	-19.2	1.32 H	18	50.8	4.0
2	5150.00	42.5 AV	54.0	-11.5	1.32 H	18	38.5	4.0
3	*5190.00	94.6 PK			1.32 H	18	90.6	4.0
4	*5190.00	85.5 AV			1.32 H	18	81.5	4.0
5	5350.00	47.2 PK	74.0	-26.8	1.32 H	18	42.8	4.4
6	5350.00	37.1 AV	54.0	-16.9	1.32 H	18	32.7	4.4
7	#10380.00	55.6 PK	74.0	-18.4	1.00 H	184	42.0	13.6
8	#10380.00	43.1 AV	54.0	-10.9	1.00 H	184	29.5	13.6
9	15570.00	53.3 PK	74.0	-20.7	1.85 H	230	40.0	13.3
10	15570.00	41.2 AV	54.0	-12.8	1.85 H	230	27.9	13.3

**ANTENNA POLARITY & TEST DISTANCE: VERTICAL AT 3 M**

NO.	FREQ. (MHz)	EMISSION LEVEL (dBuV/m)	LIMIT (dBuV/m)	MARGIN (dB)	ANTENNA HEIGHT (m)	TABLE ANGLE (Degree)	RAW VALUE (dBuV)	CORRECTION FACTOR (dB/m)
1	5150.00	66.0 PK	74.0	-8.0	1.47 V	357	62.0	4.0
2	5150.00	53.7 AV	54.0	-0.3	1.47 V	357	49.7	4.0
3	*5190.00	117.4 PK			1.47 V	357	113.4	4.0
4	*5190.00	108.5 AV			1.47 V	357	104.5	4.0
5	5350.00	58.7 PK	74.0	-15.3	1.47 V	357	54.3	4.4
6	5350.00	48.7 AV	54.0	-5.3	1.47 V	357	44.3	4.4
7	#10380.00	55.2 PK	74.0	-18.8	1.40 V	168	41.6	13.6
8	#10380.00	43.0 AV	54.0	-11.0	1.40 V	168	29.4	13.6
9	15570.00	54.2 PK	74.0	-19.8	1.33 V	349	40.9	13.3
10	15570.00	41.6 AV	54.0	-12.4	1.33 V	349	28.3	13.3

**REMARKS:**

1. Emission Level(dBuV/m) = Raw Value(dBuV) + Correction Factor(dB/m)
2. Correction Factor(dB/m) = Antenna Factor(dB/m) + Cable Factor(dB) – Pre-Amplifier Factor(dB)
3. The other emission levels were very low against the limit.
4. Margin value = Emission Level – Limit value
5. " \* ": Fundamental frequency.
6. " # ": The radiated frequency is out of the restricted band.

<b>CHANNEL</b>	TX Channel 46	<b>DETECTOR FUNCTION</b>	Peak (PK)
<b>FREQUENCY RANGE</b>	1GHz ~ 40GHz		Average (AV)

**ANTENNA POLARITY & TEST DISTANCE: HORIZONTAL AT 3 M**

NO.	FREQ. (MHz)	EMISSION LEVEL (dBuV/m)	LIMIT (dBuV/m)	MARGIN (dB)	ANTENNA HEIGHT (m)	TABLE ANGLE (Degree)	RAW VALUE (dBuV)	CORRECTION FACTOR (dB/m)
1	5150.00	52.4 PK	74.0	-21.6	1.24 H	32	48.4	4.0
2	5150.00	41.9 AV	54.0	-12.1	1.24 H	32	37.9	4.0
3	*5230.00	97.3 PK			1.24 H	32	93.1	4.2
4	*5230.00	89.4 AV			1.24 H	32	85.2	4.2
5	5350.00	51.2 PK	74.0	-22.8	1.24 H	32	46.8	4.4
6	5350.00	39.1 AV	54.0	-14.9	1.24 H	32	34.7	4.4
7	#10460.00	55.0 PK	74.0	-19.0	1.09 H	173	41.3	13.7
8	#10460.00	42.4 AV	54.0	-11.6	1.09 H	173	28.7	13.7
9	15690.00	54.4 PK	74.0	-19.6	1.94 H	234	40.4	14.0
10	15690.00	42.1 AV	54.0	-11.9	1.94 H	234	28.1	14.0

**ANTENNA POLARITY & TEST DISTANCE: VERTICAL AT 3 M**

NO.	FREQ. (MHz)	EMISSION LEVEL (dBuV/m)	LIMIT (dBuV/m)	MARGIN (dB)	ANTENNA HEIGHT (m)	TABLE ANGLE (Degree)	RAW VALUE (dBuV)	CORRECTION FACTOR (dB/m)
1	5150.00	64.3 PK	74.0	-9.7	1.44 V	359	60.3	4.0
2	5150.00	53.8 AV	54.0	-0.2	1.44 V	359	49.8	4.0
3	*5230.00	118.4 PK			1.44 V	359	114.2	4.2
4	*5230.00	110.8 AV			1.44 V	359	106.6	4.2
5	5350.00	63.1 PK	74.0	-10.9	1.44 V	359	58.7	4.4
6	5350.00	51.2 AV	54.0	-2.8	1.44 V	359	46.8	4.4
7	#10460.00	55.4 PK	74.0	-18.6	1.44 V	163	41.7	13.7
8	#10460.00	43.7 AV	54.0	-10.3	1.44 V	163	30.0	13.7
9	15690.00	52.6 PK	74.0	-21.4	1.41 V	342	38.6	14.0
10	15690.00	40.6 AV	54.0	-13.4	1.41 V	342	26.6	14.0

**REMARKS:**

1. Emission Level(dBuV/m) = Raw Value(dBuV) + Correction Factor(dB/m)
2. Correction Factor(dB/m) = Antenna Factor(dB/m) + Cable Factor(dB) – Pre-Amplifier Factor(dB)
3. The other emission levels were very low against the limit.
4. Margin value = Emission Level – Limit value
5. " \* ": Fundamental frequency.
6. " # ": The radiated frequency is out of the restricted band.

<b>CHANNEL</b>	TX Channel 151	<b>DETECTOR FUNCTION</b>	Peak (PK)
<b>FREQUENCY RANGE</b>	1GHz ~ 40GHz		Average (AV)

**ANTENNA POLARITY & TEST DISTANCE: HORIZONTAL AT 3 M**

NO.	FREQ. (MHz)	EMISSION LEVEL (dBuV/m)	LIMIT (dBuV/m)	MARGIN (dB)	ANTENNA HEIGHT (m)	TABLE ANGLE (Degree)	RAW VALUE (dBuV)	CORRECTION FACTOR (dB/m)
1	*5755.00	106.1 PK			2.20 H	334	101.1	5.0
2	*5755.00	97.4 AV			2.20 H	334	92.4	5.0
3	11510.00	57.2 PK	74.0	-16.8	1.59 H	134	43.2	14.0
4	11510.00	44.9 AV	54.0	-9.1	1.59 H	134	30.9	14.0
5	#17265.00	58.0 PK	74.0	-16.0	3.16 H	43	39.5	18.5
6	#17265.00	47.0 AV	54.0	-7.0	3.16 H	43	28.5	18.5

**ANTENNA POLARITY & TEST DISTANCE: VERTICAL AT 3 M**

NO.	FREQ. (MHz)	EMISSION LEVEL (dBuV/m)	LIMIT (dBuV/m)	MARGIN (dB)	ANTENNA HEIGHT (m)	TABLE ANGLE (Degree)	RAW VALUE (dBuV)	CORRECTION FACTOR (dB/m)
1	*5755.00	121.6 PK			2.11 V	200	116.6	5.0
2	*5755.00	112.9 AV			2.11 V	200	107.9	5.0
3	11510.00	57.4 PK	74.0	-16.6	2.81 V	175	43.4	14.0
4	11510.00	45.3 AV	54.0	-8.7	2.81 V	175	31.3	14.0
5	#17265.00	57.0 PK	74.0	-17.0	2.17 V	292	38.5	18.5
6	#17265.00	48.5 AV	54.0	-5.5	2.17 V	292	30.0	18.5

**REMARKS:**

1. Emission Level(dBuV/m) = Raw Value(dBuV) + Correction Factor(dB/m)
2. Correction Factor(dB/m) = Antenna Factor(dB/m) + Cable Factor(dB) – Pre-Amplifier Factor(dB)
3. The other emission levels were very low against the limit.
4. Margin value = Emission Level – Limit value
5. " \* ": Fundamental frequency.
6. " # ": The radiated frequency is out of the restricted band.

<b>CHANNEL</b>	TX Channel 159	<b>DETECTOR FUNCTION</b>	Peak (PK)
<b>FREQUENCY RANGE</b>	1GHz ~ 40GHz		Average (AV)

**ANTENNA POLARITY & TEST DISTANCE: HORIZONTAL AT 3 M**

NO.	FREQ. (MHz)	EMISSION LEVEL (dBuV/m)	LIMIT (dBuV/m)	MARGIN (dB)	ANTENNA HEIGHT (m)	TABLE ANGLE (Degree)	RAW VALUE (dBuV)	CORRECTION FACTOR (dB/m)
1	*5795.00	107.2 PK			2.11 H	325	102.1	5.1
2	*5795.00	98.2 AV			2.11 H	325	93.1	5.1
3	11590.00	57.9 PK	74.0	-16.1	1.59 H	165	43.9	14.0
4	11590.00	45.6 AV	54.0	-8.4	1.59 H	165	31.6	14.0
5	#17385.00	58.2 PK	74.0	-15.8	3.07 H	76	39.1	19.1
6	#17385.00	47.3 AV	54.0	-6.7	3.07 H	76	28.2	19.1

**ANTENNA POLARITY & TEST DISTANCE: VERTICAL AT 3 M**

NO.	FREQ. (MHz)	EMISSION LEVEL (dBuV/m)	LIMIT (dBuV/m)	MARGIN (dB)	ANTENNA HEIGHT (m)	TABLE ANGLE (Degree)	RAW VALUE (dBuV)	CORRECTION FACTOR (dB/m)
1	*5795.00	123.1 PK			1.96 V	211	118.0	5.1
2	*5795.00	113.6 AV			1.96 V	211	108.5	5.1
3	11590.00	57.7 PK	74.0	-16.3	2.72 V	179	43.7	14.0
4	11590.00	45.8 AV	54.0	-8.2	2.72 V	179	31.8	14.0
5	#17385.00	57.0 PK	74.0	-17.0	2.18 V	328	37.9	19.1
6	#17385.00	48.6 AV	54.0	-5.4	2.18 V	328	29.5	19.1

**REMARKS:**

1. Emission Level(dBuV/m) = Raw Value(dBuV) + Correction Factor(dB/m)
2. Correction Factor(dB/m) = Antenna Factor(dB/m) + Cable Factor(dB) – Pre-Amplifier Factor(dB)
3. The other emission levels were very low against the limit.
4. Margin value = Emission Level – Limit value
5. " \* ": Fundamental frequency.
6. " # ": The radiated frequency is out of the restricted band.

**802.11ac (VHT80)**

<b>CHANNEL</b>	TX Channel 42	<b>DETECTOR FUNCTION</b>	Peak (PK)
<b>FREQUENCY RANGE</b>	1GHz ~ 40GHz		Average (AV)

**ANTENNA POLARITY & TEST DISTANCE: HORIZONTAL AT 3 M**

NO.	FREQ. (MHz)	EMISSION LEVEL (dBuV/m)	LIMIT (dBuV/m)	MARGIN (dB)	ANTENNA HEIGHT (m)	TABLE ANGLE (Degree)	RAW VALUE (dBuV)	CORRECTION FACTOR (dB/m)
1	5150.00	51.3 PK	74.0	-22.7	1.26 H	44	47.3	4.0
2	5150.00	43.0 AV	54.0	-11.0	1.26 H	44	39.0	4.0
3	*5210.00	89.6 PK			1.26 H	44	85.5	4.1
4	*5210.00	81.6 AV			1.26 H	44	77.5	4.1
5	5350.00	46.8 PK	74.0	-27.2	1.26 H	44	42.4	4.4
6	5350.00	36.1 AV	54.0	-17.9	1.26 H	44	31.7	4.4
7	#10420.00	55.3 PK	74.0	-18.7	1.05 H	176	41.7	13.6
8	#10420.00	42.7 AV	54.0	-11.3	1.05 H	176	29.1	13.6
9	15630.00	53.1 PK	74.0	-20.9	1.91 H	229	39.5	13.6
10	15630.00	41.1 AV	54.0	-12.9	1.91 H	229	27.5	13.6

**ANTENNA POLARITY & TEST DISTANCE: VERTICAL AT 3 M**

NO.	FREQ. (MHz)	EMISSION LEVEL (dBuV/m)	LIMIT (dBuV/m)	MARGIN (dB)	ANTENNA HEIGHT (m)	TABLE ANGLE (Degree)	RAW VALUE (dBuV)	CORRECTION FACTOR (dB/m)
1	5150.00	62.4 PK	74.0	-11.6	1.45 V	8	58.4	4.0
2	<b>5150.00</b>	<b>53.9 AV</b>	<b>54.0</b>	<b>-0.1</b>	<b>1.45 V</b>	<b>8</b>	<b>49.9</b>	<b>4.0</b>
3	*5210.00	110.8 PK			1.45 V	8	106.7	4.1
4	*5210.00	103.0 AV			1.45 V	8	98.9	4.1
5	5350.00	58.3 PK	74.0	-15.7	1.45 V	8	53.9	4.4
6	5350.00	47.4 AV	54.0	-6.6	1.45 V	8	43.0	4.4
7	#10420.00	56.3 PK	74.0	-17.7	1.45 V	161	42.7	13.6
8	#10420.00	44.1 AV	54.0	-9.9	1.45 V	161	30.5	13.6
9	15630.00	53.4 PK	74.0	-20.6	1.34 V	360	39.8	13.6
10	15630.00	41.4 AV	54.0	-12.6	1.34 V	360	27.8	13.6

**REMARKS:**

- Emission Level(dBuV/m) = Raw Value(dBuV) + Correction Factor(dB/m)
- Correction Factor(dB/m) = Antenna Factor(dB/m) + Cable Factor(dB) – Pre-Amplifier Factor(dB)
- The other emission levels were very low against the limit.
- Margin value = Emission Level – Limit value
- " \* ": Fundamental frequency.
- " # ": The radiated frequency is out of the restricted band.

<b>CHANNEL</b>	TX Channel 155	<b>DETECTOR FUNCTION</b>	Peak (PK)
<b>FREQUENCY RANGE</b>	1GHz ~ 40GHz		Average (AV)

**ANTENNA POLARITY & TEST DISTANCE: HORIZONTAL AT 3 M**

NO.	FREQ. (MHz)	EMISSION LEVEL (dBuV/m)	LIMIT (dBuV/m)	MARGIN (dB)	ANTENNA HEIGHT (m)	TABLE ANGLE (Degree)	RAW VALUE (dBuV)	CORRECTION FACTOR (dB/m)
1	*5775.00	98.6 PK			1.46 H	219	93.6	5.0
2	*5775.00	91.3 AV			1.46 H	219	86.3	5.0
3	11550.00	57.8 PK	74.0	-16.2	1.63 H	157	43.8	14.0
4	11550.00	45.5 AV	54.0	-8.5	1.63 H	157	31.5	14.0
5	#17325.00	58.0 PK	74.0	-16.0	3.10 H	81	39.4	18.6
6	#17325.00	46.5 AV	54.0	-7.5	3.10 H	81	27.9	18.6

**ANTENNA POLARITY & TEST DISTANCE: VERTICAL AT 3 M**

NO.	FREQ. (MHz)	EMISSION LEVEL (dBuV/m)	LIMIT (dBuV/m)	MARGIN (dB)	ANTENNA HEIGHT (m)	TABLE ANGLE (Degree)	RAW VALUE (dBuV)	CORRECTION FACTOR (dB/m)
1	*5775.00	114.2 PK			2.11 V	211	109.2	5.0
2	*5775.00	106.6 AV			2.11 V	211	101.6	5.0
3	11550.00	56.8 PK	74.0	-17.2	2.83 V	159	42.8	14.0
4	11550.00	44.6 AV	54.0	-9.4	2.83 V	159	30.6	14.0
5	#17325.00	56.6 PK	74.0	-17.4	2.15 V	323	38.0	18.6
6	#17325.00	48.1 AV	54.0	-5.9	2.15 V	323	29.5	18.6

**REMARKS:**

1. Emission Level(dBuV/m) = Raw Value(dBuV) + Correction Factor(dB/m)
2. Correction Factor(dB/m) = Antenna Factor(dB/m) + Cable Factor(dB) – Pre-Amplifier Factor(dB)
3. The other emission levels were very low against the limit.
4. Margin value = Emission Level – Limit value
5. " \* ": Fundamental frequency.
6. " # ": The radiated frequency is out of the restricted band.



**Below 1GHz Data:**  
**802.11a**

<b>CHANNEL</b>	TX Channel 157	<b>DETECTOR FUNCTION</b>	Quasi-Peak (QP)
<b>FREQUENCY RANGE</b>	9kHz ~ 1GHz		

**ANTENNA POLARITY & TEST DISTANCE: HORIZONTAL AT 3 M**

NO.	FREQ. (MHz)	EMISSION LEVEL (dBuV/m)	LIMIT (dBuV/m)	MARGIN (dB)	ANTENNA HEIGHT (m)	TABLE ANGLE (Degree)	RAW VALUE (dBuV)	CORRECTION FACTOR (dB/m)
1	66.28	29.0 QP	40.0	-11.0	3.00 H	117	39.2	-10.2
2	106.70	32.8 QP	43.5	-10.7	3.00 H	298	44.6	-11.8
3	148.58	31.7 QP	43.5	-11.8	2.00 H	281	40.2	-8.5
4	250.02	27.8 QP	46.0	-18.2	1.00 H	56	37.8	-10.0
5	500.01	31.0 QP	46.0	-15.0	2.00 H	325	33.7	-2.7
6	750.03	31.5 QP	46.0	-14.5	2.00 H	261	29.6	1.9

**ANTENNA POLARITY & TEST DISTANCE: VERTICAL AT 3 M**

NO.	FREQ. (MHz)	EMISSION LEVEL (dBuV/m)	LIMIT (dBuV/m)	MARGIN (dB)	ANTENNA HEIGHT (m)	TABLE ANGLE (Degree)	RAW VALUE (dBuV)	CORRECTION FACTOR (dB/m)
1	98.48	31.4 QP	43.5	-12.1	1.00 V	298	44.6	-13.2
2	108.84	33.3 QP	43.5	-10.2	1.00 V	227	44.8	-11.5
3	250.02	22.2 QP	46.0	-23.8	1.00 V	354	32.2	-10.0
4	500.01	35.5 QP	46.0	-10.5	1.00 V	360	38.2	-2.7
5	750.01	28.6 QP	46.0	-17.4	1.00 V	222	26.7	1.9
6	988.80	31.9 QP	54.0	-22.1	1.00 V	360	27.1	4.8

**REMARKS:**

1. Emission Level(dBuV/m) = Raw Value(dBuV) + Correction Factor(dB/m)
2. Correction Factor(dB/m) = Antenna Factor(dB/m) + Cable Factor(dB) – Pre-Amplifier Factor(dB)
3. The other emission levels were very low against the limit.
4. Margin value = Emission Level – Limit value

## 4.2 Conducted Emission Measurement

### 4.2.1 Limits of Conducted Emission Measurement

Frequency (MHz)	Conducted Limit (dBuV)	
	Quasi-peak	Average
0.15 - 0.5	66 - 56	56 - 46
0.50 - 5.0	56	46
5.0 - 30.0	60	50

Note: 1. The lower limit shall apply at the transition frequencies.

2. The limit decreases in line with the logarithm of the frequency in the range of 0.15 to 0.50MHz.

### 4.2.2 Test Instruments

DESCRIPTION & MANUFACTURER	MODEL NO.	SERIAL NO.	CALIBRATED DATE	CALIBRATED UNTIL
Test Receiver R&S	ESCS 30	847124/029	Oct. 24, 2016	Oct. 23, 2017
Line-Impedance Stabilization Network (for EUT) R&S	ESH3-Z5	848773/004	Oct. 26, 2016	Oct. 25, 2017
Line-Impedance Stabilization Network (for Peripheral) R&S	ENV216	100072	June 13, 2016	June 12, 2017
50 ohms Terminator	N/A	EMC-02	Sep. 29, 2016	Sep. 28, 2017
RF Cable	5D-FB	COCCAB-001	Sep. 30, 2016	Sep. 29, 2017
10 dB PAD Mini-Circuits	HAT-10+	CONATT-004	June 20, 2016	June 19, 2017
Software BVADT	BVADT_Cond_ V7.3.7.4	NA	NA	NA

**Note:**

1. The calibration interval of the above test instruments are 12 months and the calibrations are traceable to NML/ROC and NIST/USA.
2. The test was performed in Shielded Room No. 1.
- 3 Tested Date: Mar. 20, 2017.

#### 4.2.3 Test Procedure

- The EUT was placed 0.4 meters from the conducting wall of the shielded room with EUT being connected to the power mains through a line impedance stabilization network (LISN). Other support units were connected to the power mains through another LISN. The two LISNs provide 50 ohm/ 50uH of coupling impedance for the measuring instrument.
- Both lines of the power mains connected to the EUT were checked for maximum conducted interference.
- The frequency range from 150kHz to 30MHz was searched. Emission levels under (Limit - 20dB) was not recorded.

**NOTE:** All modes of operation were investigated and the worst-case emissions are reported.

#### 4.2.4 Deviation from Test Standard

No deviation.

#### 4.2.5 Test Setup

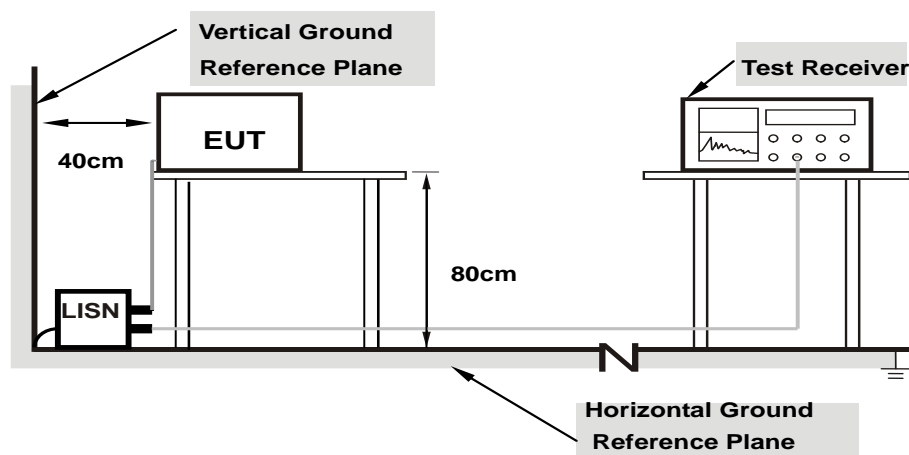

**Note: 1.Support units were connected to second LISN.**

For the actual test configuration, please refer to the attached file (Test Setup Photo).

#### 4.2.6 EUT Operating Condition

Same as 4.1.6.

## 4.2.7 Test Results (Mode 1)

Phase	Line (L)	Detector Function	Quasi-Peak (QP) / Average (AV)
-------	----------	-------------------	--------------------------------

Phase Of Power : Line (L)										
No	Frequency (MHz)	Correction Factor (dB)	Reading Value (dBuV)		Emission Level (dBuV)		Limit (dBuV)		Margin (dB)	
			Q.P.	AV.	Q.P.	AV.	Q.P.	AV.	Q.P.	AV.
1	0.15781	10.20	41.29	26.63	51.49	36.83	65.58	55.58	-14.09	-18.75
2	0.19297	10.20	32.17	8.52	42.37	18.72	63.91	53.91	-21.54	-35.19
3	0.26719	10.21	28.58	15.38	38.79	25.59	61.20	51.20	-22.41	-25.61
4	0.41953	10.24	32.09	19.22	42.33	29.46	57.46	47.46	-15.13	-18.00
5	0.87266	10.29	24.81	17.92	35.10	28.21	56.00	46.00	-20.90	-17.79
6	7.12500	10.53	29.84	23.60	40.37	34.13	60.00	50.00	-19.63	-15.87

## Remarks:

1. Q.P. and AV. are abbreviations of quasi-peak and average individually.
2. The emission levels of other frequencies were very low against the limit.
3. Margin value = Emission level – Limit value
4. Correction factor = Insertion loss + Cable loss
5. Emission Level = Correction Factor + Reading Value

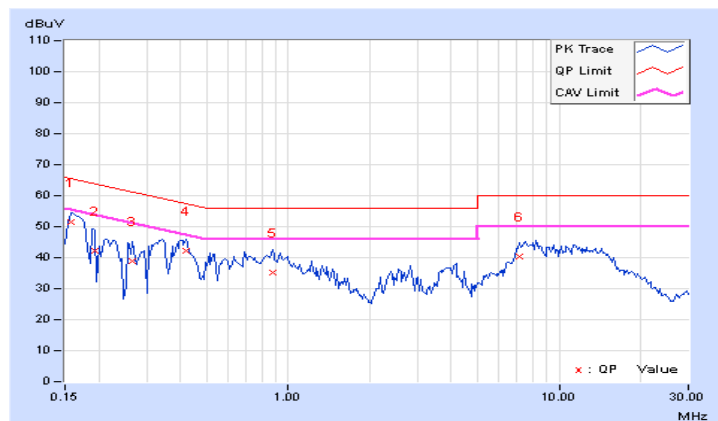

Phase	Neutral (N)	Detector Function	Quasi-Peak (QP) / Average (AV)
-------	-------------	-------------------	--------------------------------

Phase Of Power : Neutral (N)										
No	Frequency (MHz)	Correction Factor (dB)	Reading Value (dBuV)		Emission Level (dBuV)		Limit (dBuV)		Margin (dB)	
			Q.P.	AV.	Q.P.	AV.	Q.P.	AV.	Q.P.	AV.
1	0.15781	10.19	42.14	26.79	52.33	36.98	65.58	55.58	-13.25	-18.60
2	0.18906	10.17	31.77	8.88	41.94	19.05	64.08	54.08	-22.14	-35.03
3	0.26719	10.19	28.44	15.40	38.63	25.59	61.20	51.20	-22.57	-25.61
<b>4</b>	<b>0.39219</b>	<b>10.24</b>	<b>32.47</b>	<b>24.39</b>	<b>42.71</b>	<b>34.63</b>	<b>58.02</b>	<b>48.02</b>	<b>-15.31</b>	<b>-13.39</b>
5	0.98594	10.26	25.88	19.15	36.14	29.41	56.00	46.00	-19.86	-16.59
6	7.53516	10.46	30.54	24.12	41.00	34.58	60.00	50.00	-19.00	-15.42

**Remarks:**

1. Q.P. and AV. are abbreviations of quasi-peak and average individually.
2. The emission levels of other frequencies were very low against the limit.
3. Margin value = Emission level – Limit value
4. Correction factor = Insertion loss + Cable loss
5. Emission Level = Correction Factor + Reading Value

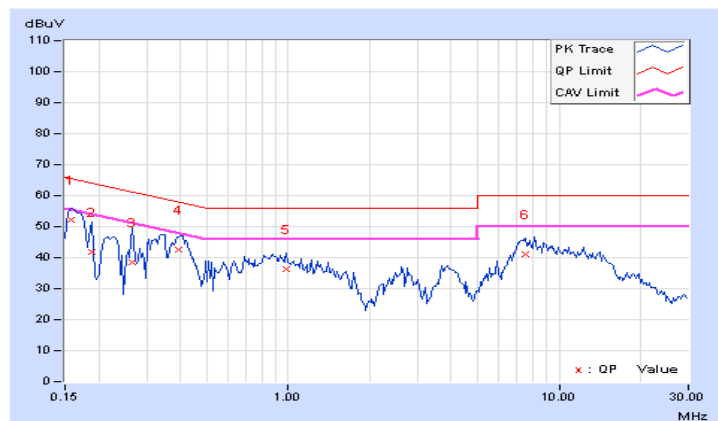

#### 4.2.8 Test Results (Mode 2)

Phase	Line (L)	Detector Function	Quasi-Peak (QP) / Average (AV)
-------	----------	-------------------	--------------------------------

Phase Of Power : Line (L)										
No	Frequency (MHz)	Correction Factor (dB)	Reading Value (dBuV)		Emission Level (dBuV)		Limit (dBuV)		Margin (dB)	
			Q.P.	AV.	Q.P.	AV.	Q.P.	AV.	Q.P.	AV.
1	0.15781	10.20	29.12	20.69	39.32	30.89	65.58	55.58	-26.26	-24.69
2	0.19687	10.20	26.44	16.20	36.64	26.40	63.74	53.74	-27.10	-27.34
3	0.34531	10.23	24.68	22.29	34.91	32.52	59.07	49.07	-24.16	-16.55
4	2.88672	10.30	16.01	4.31	26.31	14.61	56.00	46.00	-29.69	-31.39
5	3.64063	10.31	20.01	10.01	30.32	20.32	56.00	46.00	-25.68	-25.68
6	20.08594	11.70	17.99	9.86	29.69	21.56	60.00	50.00	-30.31	-28.44

**Remarks:**

1. Q.P. and AV. are abbreviations of quasi-peak and average individually.
2. The emission levels of other frequencies were very low against the limit.
3. Margin value = Emission level – Limit value
4. Correction factor = Insertion loss + Cable loss
5. Emission Level = Correction Factor + Reading Value

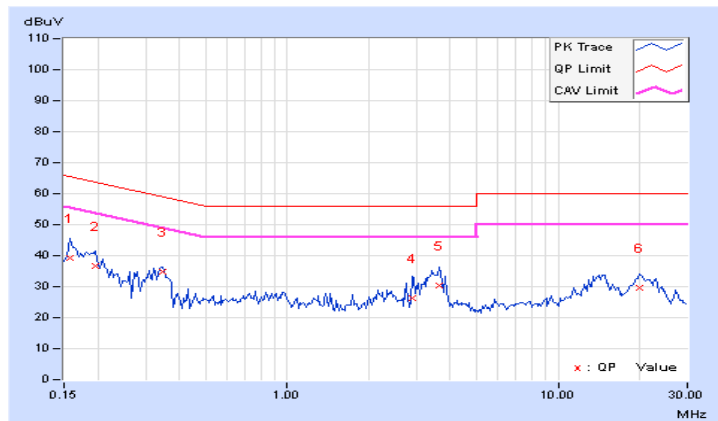

Phase	Neutral (N)	Detector Function	Quasi-Peak (QP) / Average (AV)
-------	-------------	-------------------	--------------------------------

Phase Of Power : Neutral (N)										
No	Frequency (MHz)	Correction Factor (dB)	Reading Value (dBuV)		Emission Level (dBuV)		Limit (dBuV)		Margin (dB)	
			Q.P.	AV.	Q.P.	AV.	Q.P.	AV.	Q.P.	AV.
1	0.15391	10.19	29.32	20.29	39.51	30.48	65.79	55.79	-26.28	-25.31
2	0.18906	10.17	27.14	21.56	37.31	31.73	64.08	54.08	-26.77	-22.35
3	0.26328	10.19	16.26	6.36	26.45	16.55	61.33	51.33	-34.88	-34.78
4	2.66406	10.28	16.73	7.63	27.01	17.91	56.00	46.00	-28.99	-28.09
5	3.48438	10.24	22.75	13.19	32.99	23.43	56.00	46.00	-23.01	-22.57
6	14.74219	11.07	18.68	13.02	29.75	24.09	60.00	50.00	-30.25	-25.91

**Remarks:**

1. Q.P. and AV. are abbreviations of quasi-peak and average individually.
2. The emission levels of other frequencies were very low against the limit.
3. Margin value = Emission level – Limit value
4. Correction factor = Insertion loss + Cable loss
5. Emission Level = Correction Factor + Reading Value

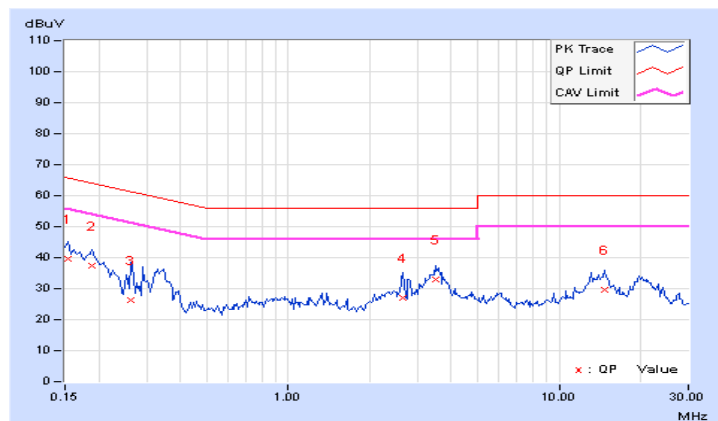

### 4.3 Transmit Power Measurement

#### 4.3.1 Limits of Transmit Power Measurement

Operation Band	EUT Category		Limit
U-NII-1		Outdoor Access Point	1 Watt (30 dBm) (Max. e.i.r.p $\leq$ 125mW(21 dBm) at any elevation angle above 30 degrees as measured from the horizon)
		Fixed point-to-point Access Point	1 Watt (30 dBm)
	√	Indoor Access Point	1 Watt (30 dBm)
		Mobile and Portable client device	250mW (24 dBm)
U-NII-2A			250mW (24 dBm) or 11 dBm+10 log B*
U-NII-2C			250mW (24 dBm) or 11 dBm+10 log B*
U-NII-3		√	1 Watt (30 dBm)

\*B is the 26 dB emission bandwidth in megahertz

Per KDB 662911 Method of conducted output power measurement on IEEE 802.11 devices,

Array Gain = 0 dB (i.e., no array gain) for  $N_{ANT} \leq 4$ ;

Array Gain = 0 dB (i.e., no array gain) for channel widths  $\geq 40$  MHz for any  $N_{ANT}$ ;

Array Gain =  $5 \log(N_{ANT}/N_{SS})$  dB or 3 dB, whichever is less for 20-MHz channel widths with  $N_{ANT} \geq 5$ .

For power measurements on all other devices: Array Gain =  $10 \log(N_{ANT}/N_{SS})$  dB.

#### 4.3.2 Test Setup

#### 4.3.3 Test Instruments

Refer to section 4.1.2 to get information of above instrument.

#### 4.3.4 Test Procedure

Method PM is used to perform output power measurement, trigger and gating function of wide band power meter is enabled to measure max output power of TX on burst. Duty factor is not added to measured value.

#### 4.3.5 Deviation from Test Standard

No deviation.

#### 4.3.6 EUT Operating Condition

The software provided by client to enable the EUT under transmission condition continuously at lowest, middle and highest channel frequencies individually.



#### 4.3.7 Test Result

#### CDD Mode

#### 802.11a

Chan.	Chan. Freq. (MHz)	Maximum Conducted Power (dBm)			Total Power (mW)	Total Power (dBm)	Limit (dBm)	Pass / Fail
		Chain 0	Chain 1	Chain 2				
36	5180	19.05	18.87	18.82	233.651	23.69	30.00	Pass
40	5200	19.03	18.90	18.89	235.054	23.71	30.00	Pass
48	5240	18.99	18.70	18.95	231.905	23.65	30.00	Pass
149	5745	22.94	21.96	22.27	522.48	27.18	30.00	Pass
157	5785	23.13	22.16	22.54	549.499	27.40	30.00	Pass
165	5825	22.31	22.23	22.68	522.678	27.18	30.00	Pass

#### 802.11ac (VHT20)

Chan.	Chan. Freq. (MHz)	Maximum Conducted Power (dBm)			Total Power (mW)	Total Power (dBm)	Limit (dBm)	Pass / Fail
		Chain 0	Chain 1	Chain 2				
36	5180	17.36	17.25	17.48	163.514	22.14	30.00	Pass
40	5200	18.19	18.11	18.47	200.938	23.03	30.00	Pass
48	5240	18.22	18.06	18.40	199.53	23.00	30.00	Pass
149	5745	22.52	21.54	21.84	473.967	26.76	30.00	Pass
157	5785	22.91	22.10	22.35	529.406	27.24	30.00	Pass
165	5825	22.33	22.23	22.75	526.476	27.21	30.00	Pass

#### 802.11ac (VHT40)

Chan.	Chan. Freq. (MHz)	Maximum Conducted Power (dBm)			Total Power (mW)	Total Power (dBm)	Limit (dBm)	Pass / Fail
		Chain 0	Chain 1	Chain 2				
38	5190	16.45	16.19	16.71	132.629	21.23	30.00	Pass
46	5230	18.76	18.37	19.10	225.152	23.52	30.00	Pass
151	5755	21.82	21.01	21.36	415.011	26.18	30.00	Pass
159	5795	21.96	21.11	21.69	433.729	26.37	30.00	Pass

#### 802.11ac (VHT80)

Chan.	Chan. Freq. (MHz)	Maximum Conducted Power (dBm)			Total Power (mW)	Total Power (dBm)	Limit (dBm)	Pass / Fail
		Chain 0	Chain 1	Chain 2				
42	5210	12.63	12.37	12.80	54.636	17.37	30.00	Pass
155	5775	18.42	17.78	17.54	186.235	22.70	30.00	Pass

## Beamforming Mode

### 802.11ac (VHT20)

Chan.	Chan. Freq. (MHz)	Maximum Conducted Power (dBm)			Total Power (mW)	Total Power (dBm)	Limit (dBm)	Pass / Fail
		Chain 0	Chain 1	Chain 2				
36	5180	17.36	17.25	17.48	163.514	22.14	26.26	Pass
40	5200	18.19	18.11	18.47	200.938	23.03	26.26	Pass
48	5240	18.22	18.06	18.40	199.53	23.00	26.26	Pass
149	5745	19.62	18.64	18.92	242.719	23.85	26.26	Pass
157	5785	19.64	18.72	18.92	244.501	23.88	26.26	Pass
165	5825	19.09	19.27	19.42	253.122	24.03	26.26	Pass

**NOTE:** Directional gain =  $10 \log[(10^{G0/20} + 10^{G1/20} + 10^{G2/20})^2 / 3]$  = 9.74dBi > 6dBi, so the power limit shall be reduced to  $30 - (9.74 - 6) = 26.26$ dBm.

### 802.11ac (VHT40)

Chan.	Chan. Freq. (MHz)	Maximum Conducted Power (dBm)			Total Power (mW)	Total Power (dBm)	Limit (dBm)	Pass / Fail
		Chain 0	Chain 1	Chain 2				
38	5190	16.45	16.19	16.71	132.629	21.23	26.26	Pass
46	5230	18.76	18.37	19.10	225.152	23.52	26.26	Pass
151	5755	19.66	18.95	19.25	255.134	24.07	26.26	Pass
159	5795	18.26	17.37	17.64	179.64	22.54	26.26	Pass

**NOTE:** Directional gain =  $10 \log[(10^{G0/20} + 10^{G1/20} + 10^{G2/20})^2 / 3]$  = 9.74dBi > 6dBi, so the power limit shall be reduced to  $30 - (9.74 - 6) = 26.26$ dBm.

### 802.11ac (VHT80)

Chan.	Chan. Freq. (MHz)	Maximum Conducted Power (dBm)			Total Power (mW)	Total Power (dBm)	Limit (dBm)	Pass / Fail
		Chain 0	Chain 1	Chain 2				
42	5210	12.63	12.37	12.80	54.636	17.37	26.26	Pass
155	5775	18.42	17.78	17.54	186.235	22.70	26.26	Pass

**NOTE:** Directional gain =  $10 \log[(10^{G0/20} + 10^{G1/20} + 10^{G2/20})^2 / 3]$  = 9.74dBi > 6dBi, so the power limit shall be reduced to  $30 - (9.74 - 6) = 26.26$ dBm.

## 4.4 Occupied Bandwidth Measurement

### 4.4.1 Test Setup

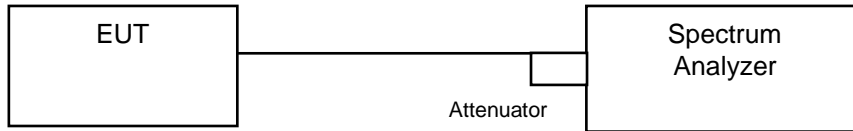

### 4.4.2 Test Instruments

Refer to section 4.1.2 to get information of above instrument.

### 4.4.3 Test Procedure

The transmitter output was connected to the spectrum analyzer through an attenuator. The bandwidth of the fundamental frequency was measured by spectrum analyzer with resolution bandwidth in the range of 1% to 5% of the anticipated emission bandwidth, and a video bandwidth at least 3x the resolution bandwidth and set the detector to SAMPLE. The width of a frequency band such that, below the lower and above the upper frequency limits, the mean powers emitted are each equal to a specified percentage 0.5 %of the total mean power of a given emission.

#### 4.4.4 Test Results

##### 802.11a

Channel	Channel Frequency (MHz)	Occupied Bandwidth (MHz)		
		Chain 0	Chain 1	Chain 2
36	5180	16.68	16.56	16.56
40	5200	16.44	16.68	16.80
48	5240	16.56	16.56	16.68
149	5745	17.16	16.80	17.04
157	5785	17.28	17.16	17.16
165	5825	17.16	17.40	17.28

##### 802.11ac (VHT20)

Channel	Channel Frequency (MHz)	Occupied Bandwidth (MHz)		
		Chain 0	Chain 1	Chain 2
36	5180	17.64	17.76	17.88
40	5200	17.88	17.76	17.76
48	5240	17.64	17.76	17.64
149	5745	18.36	17.88	17.76
157	5785	18.36	18.00	18.12
165	5825	18.00	18.00	17.88

##### 802.11ac (VHT40)

Channel	Channel Frequency (MHz)	Occupied Bandwidth (MHz)		
		Chain 0	Chain 1	Chain 2
38	5190	36.24	36.24	36.24
46	5230	36.72	36.48	36.72
151	5755	37.20	36.72	36.48
159	5795	36.96	36.72	36.96

##### 802.11ac (VHT80)

Channel	Channel Frequency (MHz)	Occupied Bandwidth (MHz)		
		Chain 0	Chain 1	Chain 2
42	5210	75.84	76.32	75.36
155	5775	75.84	75.84	75.84

### Spectrum Plot of Worst Value

**802.11a / Chain 1 : CH165**

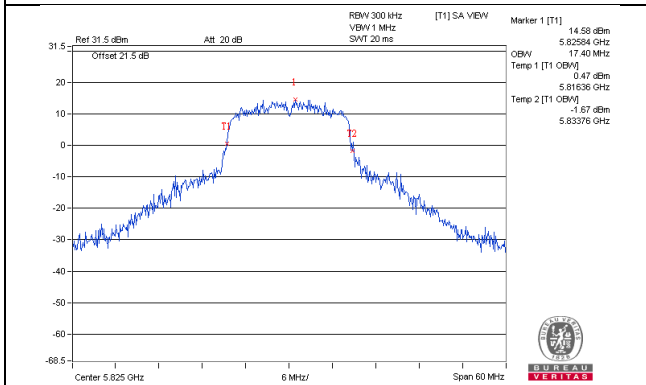

**802.11ac (VHT20) / Chain 0 : CH149**

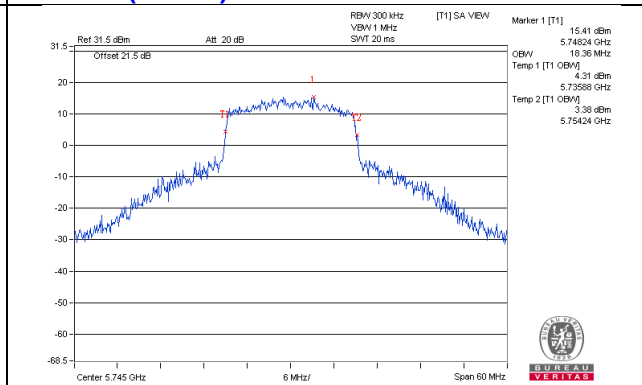

**802.11ac (VHT40) / Chain 0 : CH151**

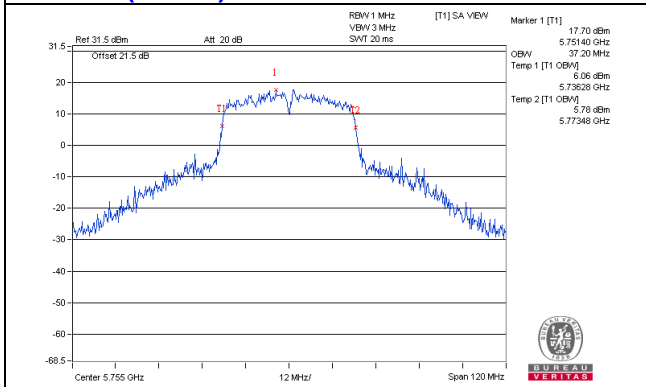

**802.11ac (VHT80) / Chain 1 : CH42**

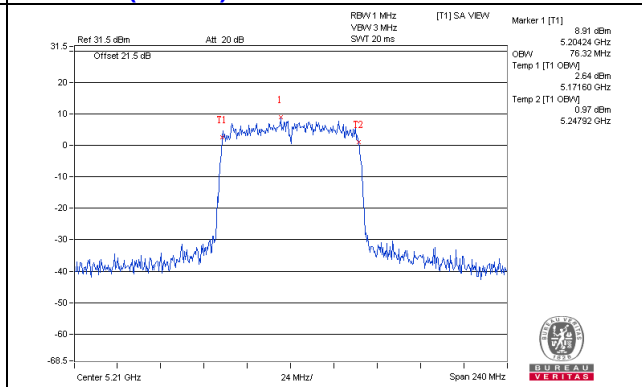

**Spectrum Plot for near by DFS band  
(DFS is required, if 99% OCP straddle into U-NII-2A band)**

**802.11a / Chain 0 : CH48**

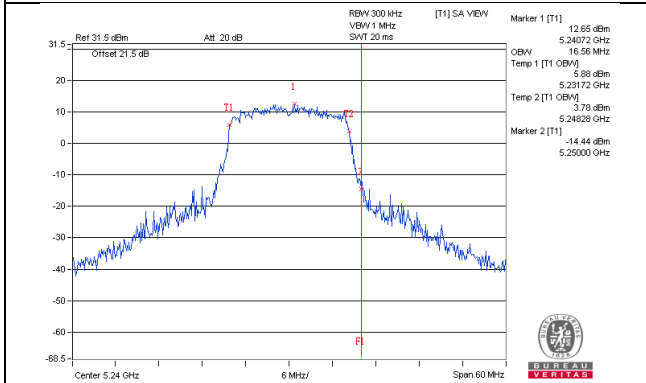

**802.11a / Chain 1 : CH48**

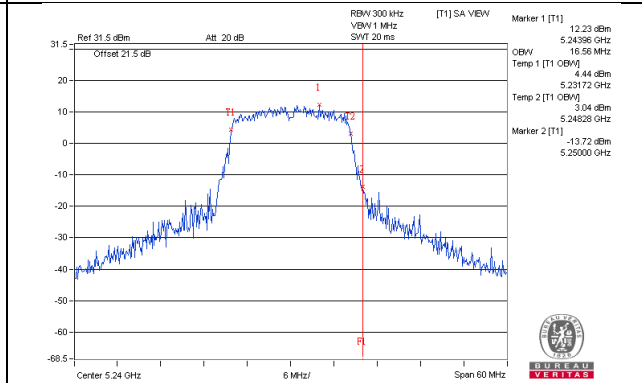

**802.11a / Chain 2 : CH48**

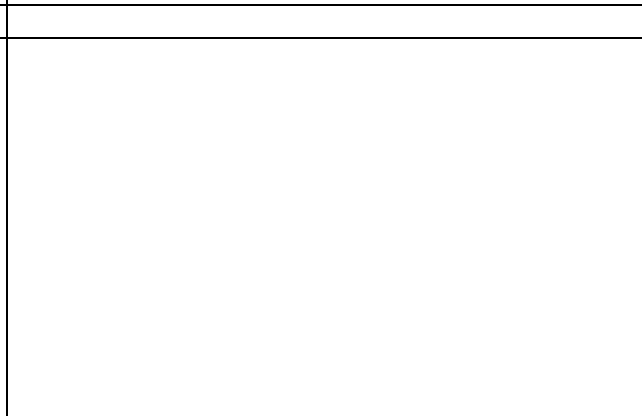
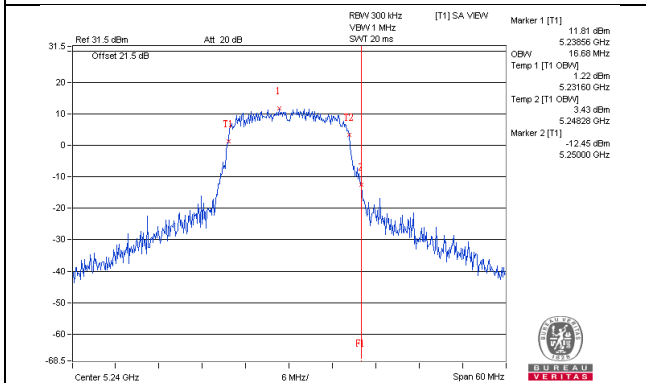

**802.11ac (VHT20) / Chain 0 : CH48**

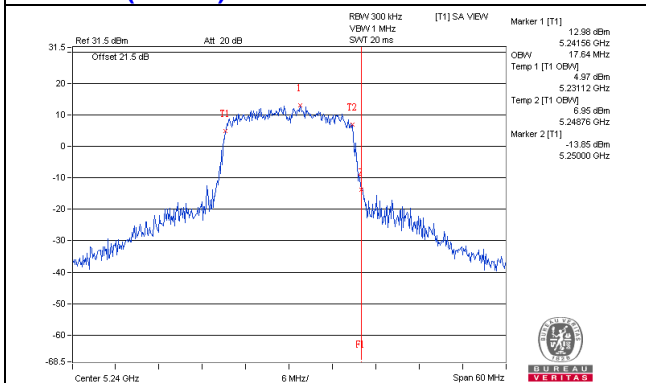

**802.11ac (VHT20) / Chain 1 : CH48**

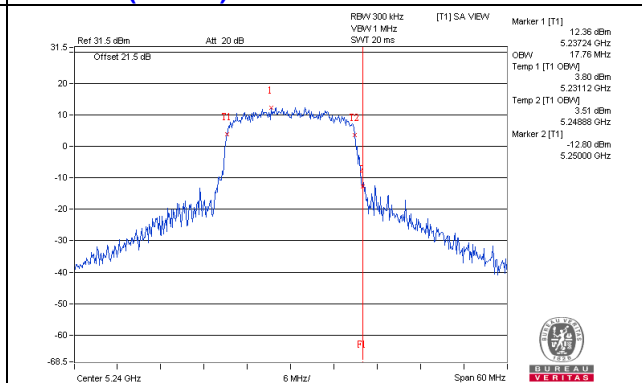

**802.11ac (VHT20) / Chain 2 : CH48**

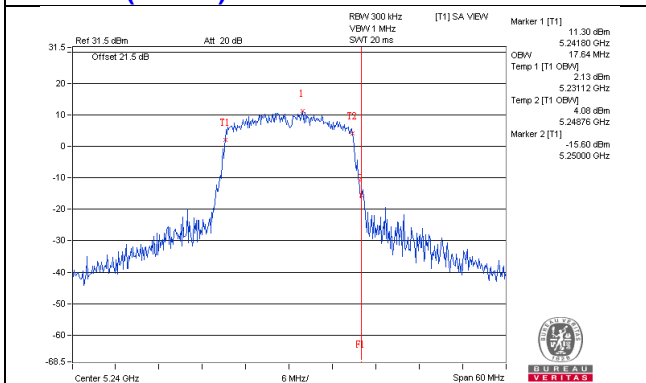



### Spectrum Plot for near by DFS band (DFS is required, if 99% OCP straddle into U-NII-2C band)

**802.11a / Chain 0 : CH149**

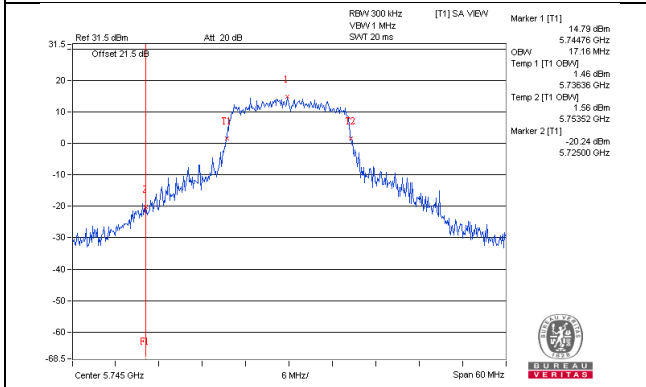

**802.11a / Chain 1 : CH149**

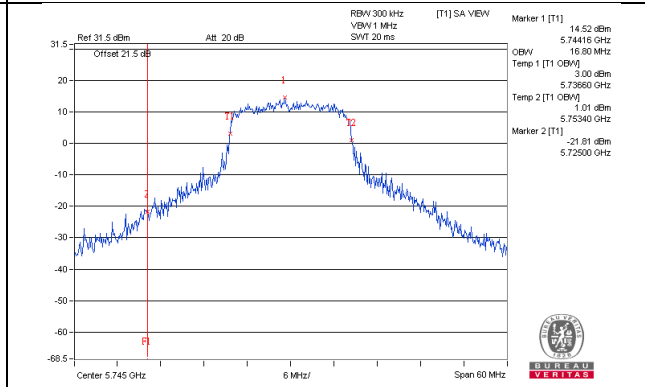

**802.11a / Chain 2 : CH149**

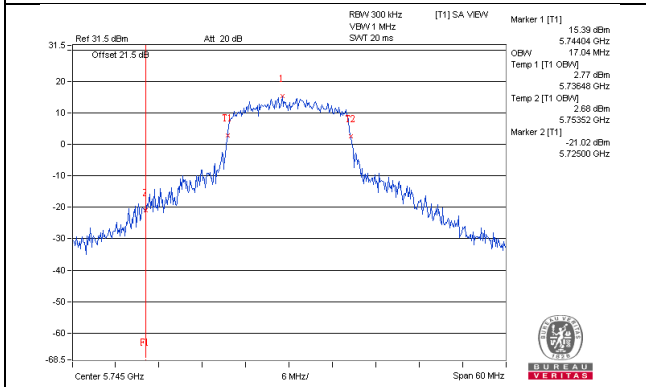

**802.11ac (VHT20) / Chain 0 : CH149**

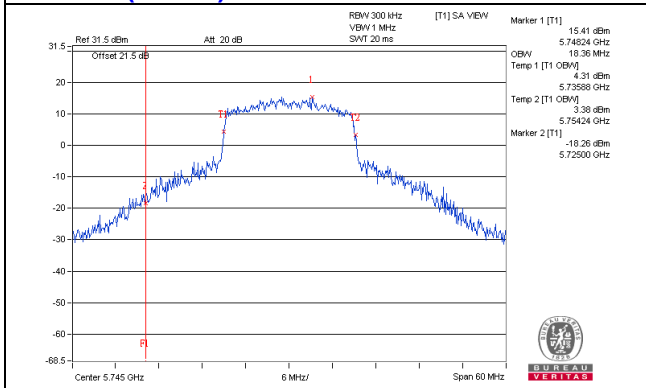

**802.11ac (VHT20) / Chain 1 : CH149**

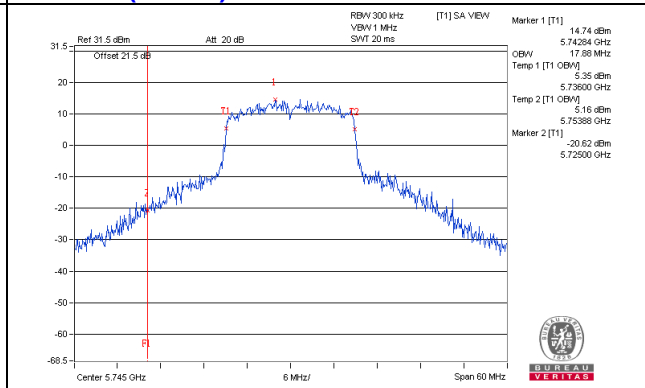

**802.11ac (VHT20) / Chain 2 : CH149**

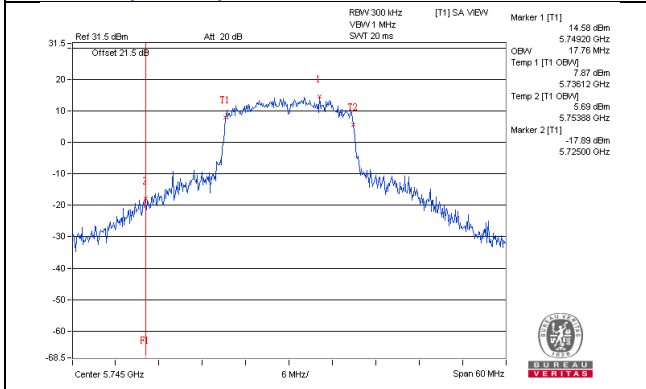



### Spectrum Plot for near by DFS band (DFS is required, if 99% OCP straddle into U-NII-2C band)

**802.11ac (VHT40) / Chain 0 : CH151**

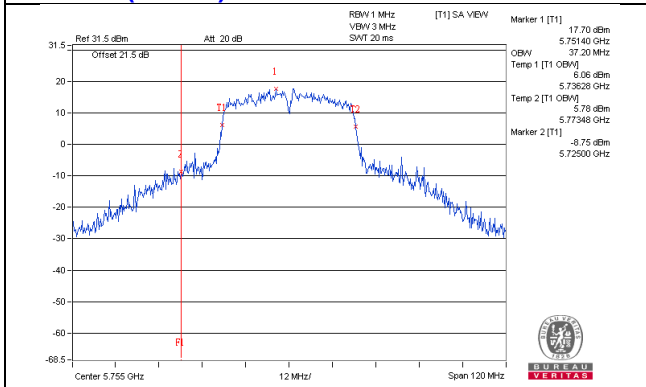

**802.11ac (VHT40) / Chain 1 : CH151**

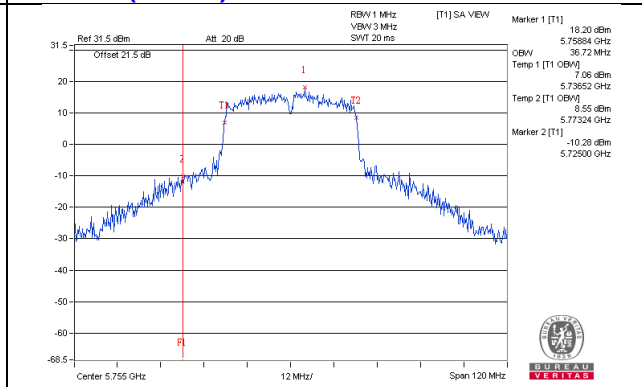

**802.11ac (VHT40) / Chain 2 : CH151**

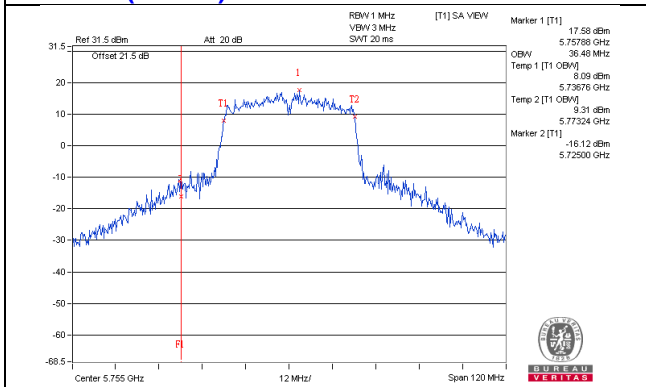

**802.11ac (VHT80) / Chain 0 : CH155**

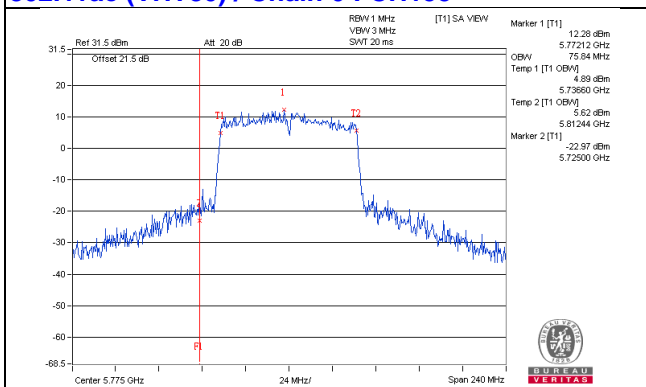

**802.11ac (VHT80) / Chain 1 : CH155**

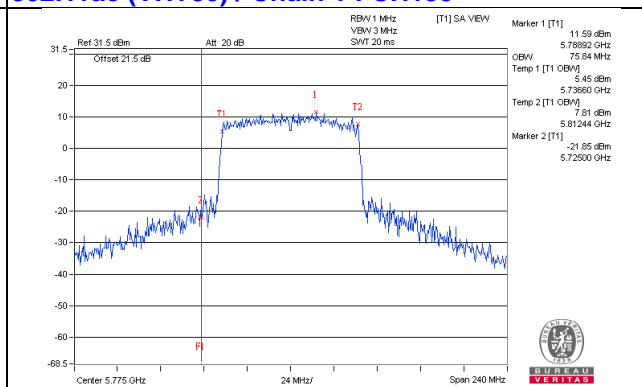

**802.11ac (VHT80) / Chain 2 : CH155**

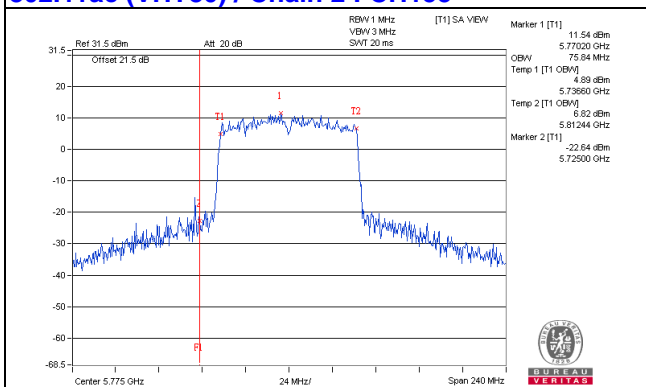

## 4.5 Peak Power Spectral Density Measurement

### 4.5.1 Limits of Peak Power Spectral Density Measurement

Operation Band	EUT Category		Limit
U-NII-1		Outdoor Access Point	17dBm/ MHz
		Fixed point-to-point Access Point	
	√	Indoor Access Point	
		Mobile and Portable client device	11dBm/ MHz
U-NII-2A	---		11dBm/ MHz
U-NII-2C	---		11dBm/ MHz
U-NII-3	√		30dBm/ 500kHz

### 4.5.2 Test Setup

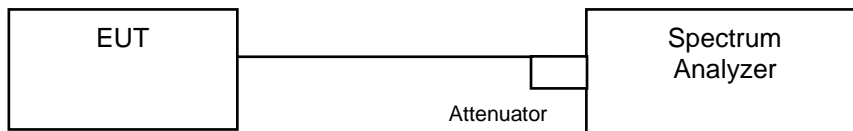

### 4.5.3 Test Instruments

Refer to section 4.1.2 to get information of above instrument.

### 4.5.4 Test Procedure

#### For U-NII-1 band:

Using method SA-1

1. Set span to encompass the entire emission bandwidth (EBW) of the signal.
2. Set RBW = 1 MHz, Set VBW ≥ 3 MHz, Detector = RMS
3. Sweep time = auto, trigger set to “free run”.
4. Trace average at least 100 traces in power averaging mode.
5. Record the max value

#### For U-NII-3:

1. Set span to encompass the entire emission bandwidth (EBW) of the signal.
2. Set RBW = 300 kHz, Set VBW ≥ 1 MHz, Detector = RMS
3. Use the peak marker function to determine the maximum power level in any 300 kHz band segment within the fundamental EBW.
4. Scale the observed power level to an equivalent value in 500 kHz by adjusting (reducing) the measured power by a bandwidth correction factor (BWCF) where  $BWCF = 10\log(500\text{ kHz}/300\text{ kHz})$
5. Sweep time = auto, trigger set to “free run”.
6. Trace average at least 100 traces in power averaging mode.
7. Record the max value

#### 4.5.5 Deviation from Test Standard

No deviation.

#### 4.5.6 EUT Operating Condition

Same as Item 4.3.6.

#### 4.5.7 Test Results

#### For U-NII-1:

#### CDD Mode

#### 802.11a

Chan.	Chan. Freq. (MHz)	PSD (dBm/MHz)			Total Power Density (dBm/MHz)	MAX. Limit (dBm/MHz)	Pass / Fail
		Chain 0	Chain 1	Chain 2			
36	5180	5.94	6.05	5.82	10.71	13.26	Pass
40	5200	5.73	6.01	5.89	10.65	13.26	Pass
48	5240	5.95	5.93	6.01	10.73	13.26	Pass

- Note:** 1. Method a) of power density measurement of KDB 662911 is using for calculating total power density. Total power density is summing entire spectra across corresponding frequency bins on the various outputs by computer.
2. Directional gain =  $10 \log[(10^{G0/20} + 10^{G1/20} + 10^{G2/20})^2 / 3] = 9.74\text{dBi} > 6\text{dBi}$ , so the power density limit shall be reduced to  $17-(9.74-6) = 13.26\text{dBm}$ .

#### 802.11ac (VHT20)

Chan.	Chan. Freq. (MHz)	PSD (dBm/MHz)			Total Power Density (dBm/MHz)	MAX. Limit (dBm/MHz)	Pass / Fail
		Chain 0	Chain 1	Chain 2			
36	5180	4.25	4.14	5.07	9.28	13.26	Pass
40	5200	5.28	5.25	5.28	10.04	13.26	Pass
48	5240	5.21	4.91	5.36	9.94	13.26	Pass

- Note:** 1. Method a) of power density measurement of KDB 662911 is using for calculating total power density. Total power density is summing entire spectra across corresponding frequency bins on the various outputs by computer.
2. Directional gain =  $10 \log[(10^{G0/20} + 10^{G1/20} + 10^{G2/20})^2 / 3] = 9.74\text{dBi} > 6\text{dBi}$ , so the power density limit shall be reduced to  $17-(9.74-6) = 13.26\text{dBm}$ .

#### 802.11ac (VHT40)

Chan.	Chan. Freq. (MHz)	PSD (dBm/MHz)			Total Power Density (dBm/MHz)	MAX. Limit (dBm/MHz)	Pass / Fail
		Chain 0	Chain 1	Chain 2			
38	5190	0.66	0.25	0.75	5.33	13.26	Pass
46	5230	2.43	2.44	3.09	7.44	13.26	Pass

- Note:** 1. Method a) of power density measurement of KDB 662911 is using for calculating total power density. Total power density is summing entire spectra across corresponding frequency bins on the various outputs by computer.
2. Directional gain =  $10 \log[(10^{G0/20} + 10^{G1/20} + 10^{G2/20})^2 / 3] = 9.74\text{dBi} > 6\text{dBi}$ , so the power density limit shall be reduced to  $17-(9.74-6) = 13.26\text{dBm}$ .

### 802.11ac (VHT80)

Chan.	Chan. Freq. (MHz)	PSD (dBm/MHz)			Total Power Density (dBm/MHz)	MAX. Limit (dBm/MHz)	Pass / Fail
		Chain 0	Chain 1	Chain 2			
42	5210	-6.68	-7.04	-6.79	-2.06	13.26	Pass

- Note:** 1. Method a) of power density measurement of KDB 662911 is using for calculating total power density. Total power density is summing entire spectra across corresponding frequency bins on the various outputs by computer.
2. Directional gain =  $10 \log[(10^{G_0/20} + 10^{G_1/20} + 10^{G_2/20})^2 / 3] = 9.74\text{dBi} > 6\text{dBi}$ , so the power density limit shall be reduced to  $17 - (9.74 - 6) = 13.26\text{dBm}$ .

### Spectrum Plot of Worst Value

**802.11a / Chain 1 : CH36**

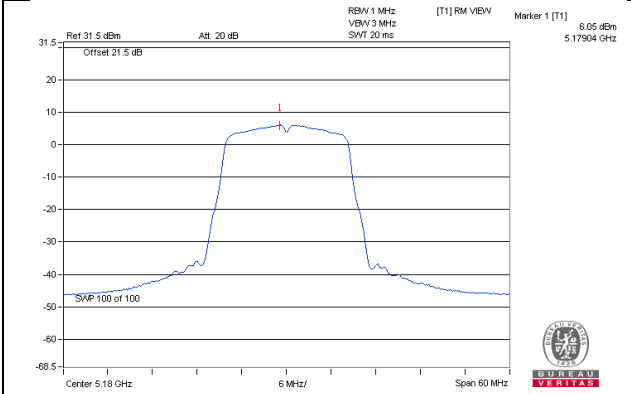

**802.11ac (VHT20) / Chain 0 : CH40**

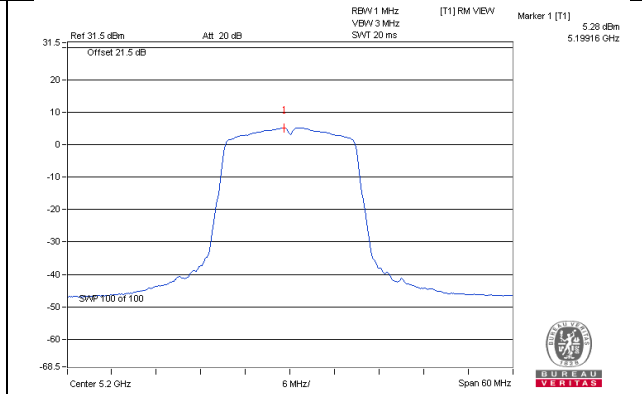

**802.11ac (VHT40) / Chain 2: CH46**

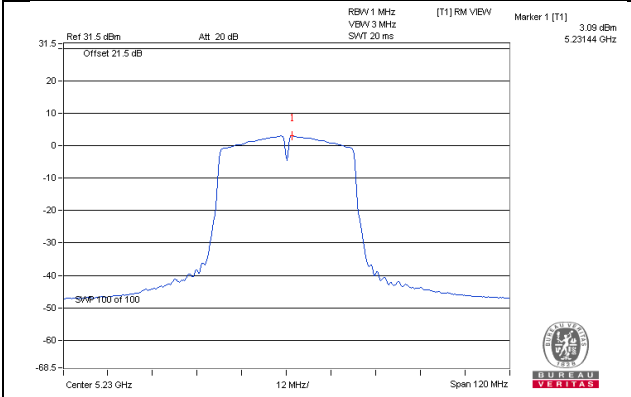

**802.11ac (VHT80) / Chain 0 : CH42**

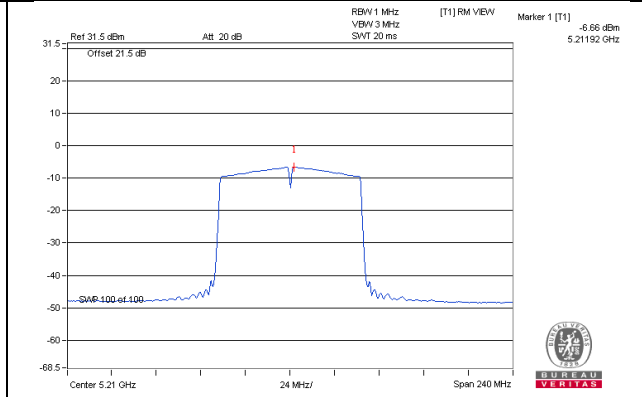

**For U-NII-3:**
**802.11a**

TX chain	Channel	Freq. (MHz)	PSD (dBm/300kHz)	PSD (dBm/500kHz)	10 log (N=3) dB	Total PSD (dBm/500kHz)	Limit (dBm/500kHz)	Pass /Fail
0	149	5745	1.83	4.05	4.77	8.82	26.26	Pass
	157	5785	2.34	4.56	4.77	9.33	26.26	Pass
	165	5825	0.96	3.18	4.77	7.95	26.26	Pass
1	149	5745	0.93	3.15	4.77	7.92	26.26	Pass
	157	5785	1.37	3.59	4.77	8.36	26.26	Pass
	165	5825	1.19	3.41	4.77	8.18	26.26	Pass
2	149	5745	0.48	2.70	4.77	7.47	26.26	Pass
	157	5785	1.79	4.01	4.77	8.78	26.26	Pass
	165	5825	2.45	4.67	4.77	9.44	26.26	Pass

Note: 1. Directional gain =  $10 \log[(10^{G0/20} + 10^{G1/20} + 10^{G2/20})^2 / 3] = 9.74\text{dBi} > 6\text{dBi}$ , so the power density limit shall be reduced to  $30-(9.74-6) = 26.26\text{dBm}$ .

**802.11ac (VHT20)**

TX chain	Channel	Freq. (MHz)	PSD (dBm/300kHz)	PSD (dBm/500kHz)	10 log (N=3) dB	Total PSD (dBm/500kHz)	Limit (dBm/500kHz)	Pass /Fail
0	149	5745	1.41	3.63	4.77	8.40	26.26	Pass
	157	5785	1.96	4.18	4.77	8.95	26.26	Pass
	165	5825	1.23	3.45	4.77	8.22	26.26	Pass
1	149	5745	0.09	2.31	4.77	7.08	26.26	Pass
	157	5785	0.82	3.04	4.77	7.81	26.26	Pass
	165	5825	0.74	2.96	4.77	7.73	26.26	Pass
2	149	5745	0.50	2.72	4.77	7.49	26.26	Pass
	157	5785	0.70	2.92	4.77	7.69	26.26	Pass
	165	5825	0.75	2.97	4.77	7.74	26.26	Pass

Note: 1. Directional gain =  $10 \log[(10^{G0/20} + 10^{G1/20} + 10^{G2/20})^2 / 3] = 9.74\text{dBi} > 6\text{dBi}$ , so the power density limit shall be reduced to  $30-(9.74-6) = 26.26\text{dBm}$ .

### 802.11ac (VHT40)

TX chain	Channel	Freq. (MHz)	PSD (dBm/300kHz)	PSD (dBm/500kHz)	10 log (N=3) dB	Total PSD (dBm/500kHz)	Limit (dBm/500kHz)	Pass /Fail
0	151	5755	-3.03	-0.81	4.77	3.96	26.26	Pass
	159	5795	-2.58	-0.36	4.77	4.41	26.26	Pass
1	151	5755	-3.66	-1.44	4.77	3.33	26.26	Pass
	159	5795	-3.55	-1.33	4.77	3.44	26.26	Pass
2	151	5755	-3.24	-1.02	4.77	3.75	26.26	Pass
	159	5795	-3.17	-0.95	4.77	3.82	26.26	Pass

Note: 1. Directional gain =  $10 \log[(10^{G0/20} + 10^{G1/20} + 10^{G2/20})^2 / 3] = 9.74\text{dBi} > 6\text{dBi}$ , so the power density limit shall be reduced to  $30-(9.74-6) = 26.26\text{dBm}$ .

### 802.11ac (VHT80)

TX chain	Channel	Freq. (MHz)	PSD (dBm/300kHz)	PSD (dBm/500kHz)	10 log (N=3) dB	Total PSD (dBm/500kHz)	Limit (dBm/500kHz)	Pass /Fail
0	155	5775	-9.88	-7.66	4.77	-2.89	26.26	Pass
1	155	5775	-10.32	-8.10	4.77	-3.33	26.26	Pass
2	155	5775	-10.83	-8.61	4.77	-3.84	26.26	Pass

Note: 1. Directional gain =  $10 \log[(10^{G0/20} + 10^{G1/20} + 10^{G2/20})^2 / 3] = 9.74\text{dBi} > 6\text{dBi}$ , so the power density limit shall be reduced to  $30-(9.74-6) = 26.26\text{dBm}$ .



### Spectrum Plot of Worst Value

**802.11a / Chain 2 : CH165**

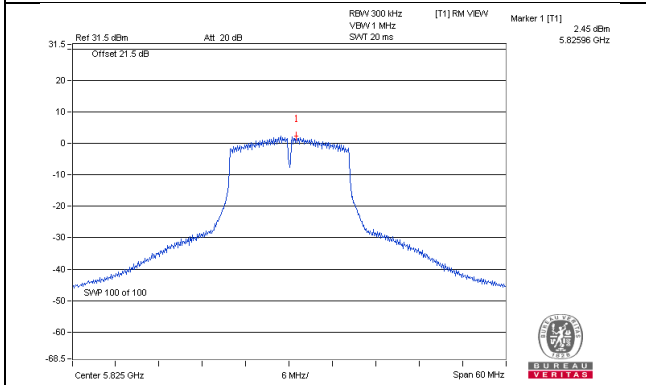

**802.11ac (VHT20) / Chain 0 : CH157**

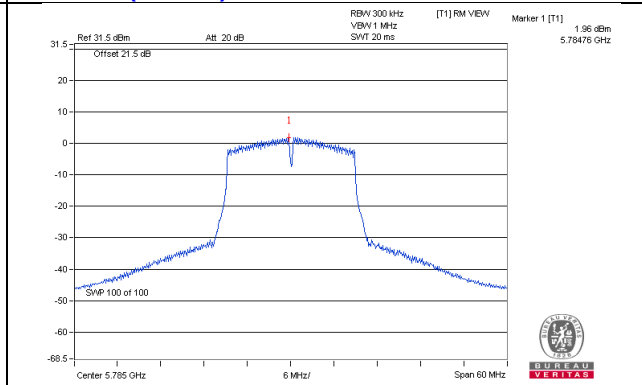

**802.11ac (VHT40) / Chain 0: CH159**

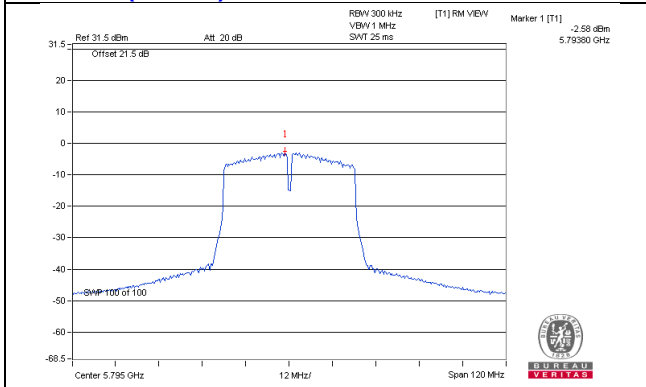

**802.11ac (VHT80) / Chain 0 : CH155**

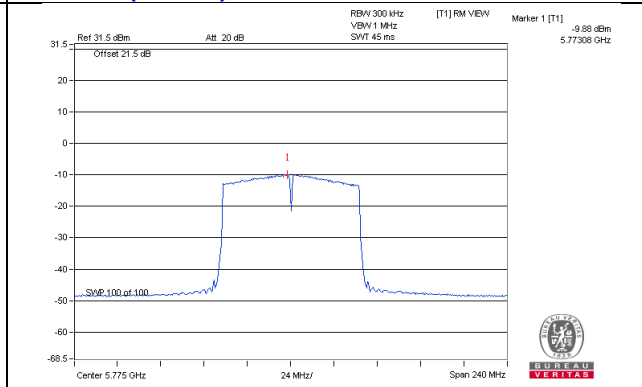

## 4.6 Frequency Stability Measurement

### 4.6.1 Limits of Frequency Stability Measurement

The frequency of the carrier signal shall be maintained within band of operation

### 4.6.2 Test Setup

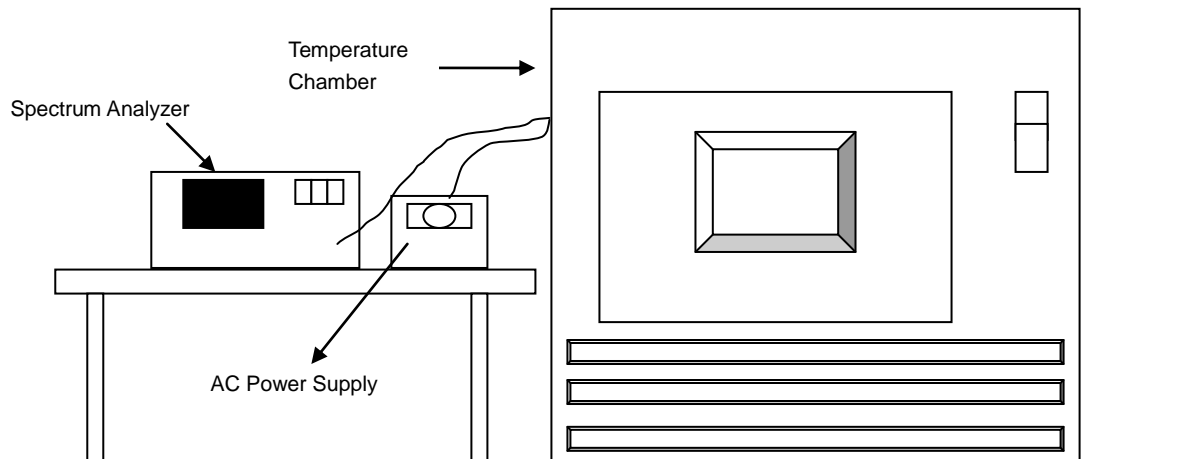

### 4.6.3 Test Instruments

Refer to section 4.1.2 to get information of above instrument.

### 4.6.4 Test Procedure

- The EUT was placed inside the environmental test chamber and powered by nominal AC voltage.
- Turn the EUT on and couple its output to a spectrum analyzer.
- Turn the EUT off and set the chamber to the highest temperature specified.
- Allow sufficient time (approximately 30 min) for the temperature of the chamber to stabilize, turn the EUT on and measure the operating frequency after 2, 5, and 10 Minutes.
- Repeat step 2 and 3 with the temperature chamber set to the lowest temperature.
- The test chamber was allowed to stabilize at +20 degree C for a minimum of 30 Minutes. The supply voltage was then adjusted on the EUT from 85% to 115% and the frequency record.

### 4.6.5 Deviation from Test Standard

No deviation.

### 4.6.6 EUT Operating Condition

Set the EUT transmit at un-modulation mode to test frequency stability.

#### 4.6.7 Test Results

Frequency Stability Versus Temp.									
Operating Frequency: 5180 MHz									
TEMP. (°C)	Power Supply (Vac)	0 Minute		2 Minute		5 Minute		10 Minute	
		Measured Frequency (MHz)	Pass/Fail	Measured Frequency (MHz)	Pass/Fail	Measured Frequency (MHz)	Pass/Fail	Measured Frequency (MHz)	Pass/Fail
50	120	5179.9949	Pass	5179.9937	Pass	5179.9946	Pass	5179.9932	Pass
40	120	5180.0216	Pass	5180.0259	Pass	5180.0255	Pass	5180.0249	Pass
30	120	5179.9841	Pass	5179.9834	Pass	5179.9849	Pass	5179.9831	Pass
20	120	5180.0033	Pass	5180.0042	Pass	5180.0045	Pass	5180.0021	Pass
10	120	5179.9772	Pass	5179.9782	Pass	5179.9752	Pass	5179.9772	Pass
0	120	5180.0074	Pass	5180.0083	Pass	5180.0046	Pass	5180.0077	Pass
-10	120	5180.0125	Pass	5180.0153	Pass	5180.0139	Pass	5180.0141	Pass
-20	120	5179.9824	Pass	5179.978	Pass	5179.9819	Pass	5179.9791	Pass
-30	120	5179.9935	Pass	5179.9971	Pass	5179.9966	Pass	5179.9966	Pass

Frequency Stability Versus Voltage									
Operating Frequency: 5180 MHz									
TEMP. (°C)	Power Supply (Vac)	0 Minute		2 Minute		5 Minute		10 Minute	
		Measured Frequency (MHz)	Pass/Fail	Measured Frequency (MHz)	Pass/Fail	Measured Frequency (MHz)	Pass/Fail	Measured Frequency (MHz)	Pass/Fail
20	138	5180.0032	Pass	5180.0039	Pass	5180.0054	Pass	5180.0027	Pass
	120	5180.0033	Pass	5180.0042	Pass	5180.0045	Pass	5180.0021	Pass
	102	5180.0036	Pass	5180.0052	Pass	5180.005	Pass	5180.003	Pass

## 4.7 6dB Bandwidth Measurement

### 4.7.1 Limits of 6dB Bandwidth Measurement

The minimum of 6dB Bandwidth Measurement is 0.5MHz.

### 4.7.2 Test Setup

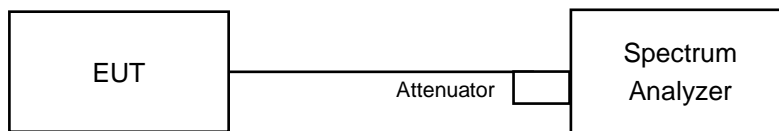

### 4.7.3 Test Instruments

Refer to section 4.1.2 to get information of above instrument.

### 4.7.4 Test Procedure

#### MEASUREMENT PROCEDURE REF

- a. Set resolution bandwidth (RBW) = 100kHz
- b. Set the video bandwidth (VBW)  $\geq 3 \times$  RBW, Detector = Peak.
- c. Trace mode = max hold.
- d. Sweep = auto couple.
- e. Measure the maximum width of the emission that is constrained by the frequencies associated with the two amplitude points (upper and lower) that are attenuated by 6 dB relative to the maximum level measured in the fundamental emission

### 4.7.5 Deviation from Test Standard

No deviation.

### 4.7.6 EUT Operating Condition

The software provided by client to enable the EUT under transmission condition continuously at lowest, middle and highest channel frequencies individually.

#### 4.7.7 Test Results

##### 802.11a

Channel	Frequency (MHz)	6dB Bandwidth (MHz)			Minimum Limit (MHz)	Pass / Fail
		Chain 0	Chain 1	Chain 2		
149	5745	16.41	16.40	16.41	0.5	PASS
157	5785	16.44	16.41	16.42	0.5	PASS
165	5825	16.43	16.38	16.43	0.5	PASS

##### 802.11ac (VHT20)

Channel	Frequency (MHz)	6dB Bandwidth (MHz)			Minimum Limit (MHz)	Pass / Fail
		Chain 0	Chain 1	Chain 2		
149	5745	17.69	17.66	17.68	0.5	PASS
157	5785	17.68	17.66	17.64	0.5	PASS
165	5825	17.66	17.64	17.65	0.5	PASS

##### 802.11ac (VHT40)

Channel	Frequency (MHz)	6dB Bandwidth (MHz)			Minimum Limit (MHz)	Pass / Fail
		Chain 0	Chain 1	Chain 2		
151	5755	36.42	36.43	35.88	0.5	PASS
159	5795	36.45	36.29	36.46	0.5	PASS

##### 802.11ac (VHT80)

Channel	Frequency (MHz)	6dB Bandwidth (MHz)			Minimum Limit (MHz)	Pass / Fail
		Chain 0	Chain 1	Chain 2		
155	5775	76.56	76.57	76.59	0.5	PASS

### Spectrum Plot of Worst Value

**802.11a / Chain 1 : CH165**

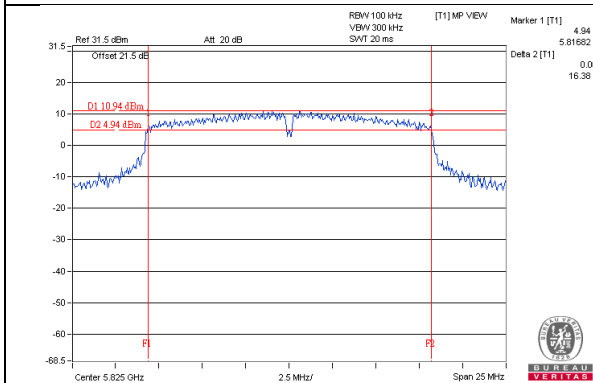

**802.11ac (VHT20) / Chain 1 : CH165**

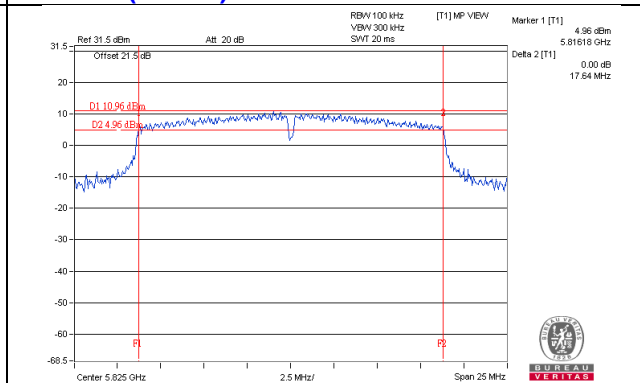

**802.11ac (VHT40) / Chain 2: CH151**

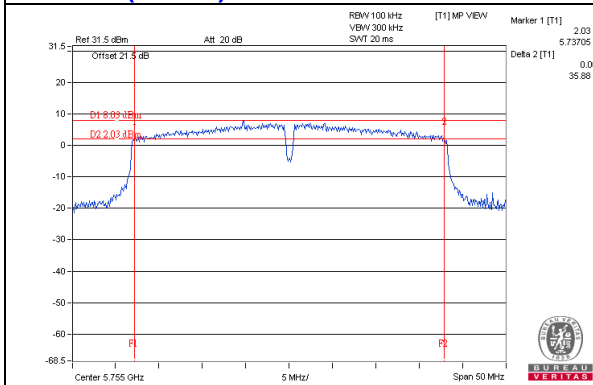

**802.11ac (VHT80) / Chain 0 : CH155**

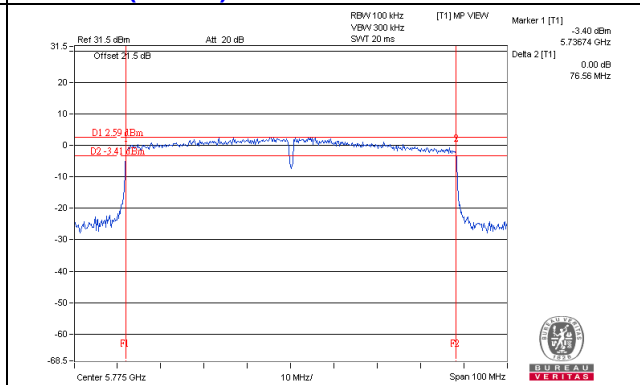

## 5 Pictures of Test Arrangements

Please refer to the attached file (Test Setup Photo).

# Annex A- Radiated Out of Band Emission (OOBE) Measurement (For U-NII-3 band)

## Annex A.1 (Mode 1)

802.11a

**CH 149 5745 MHz**

**Horizontal**

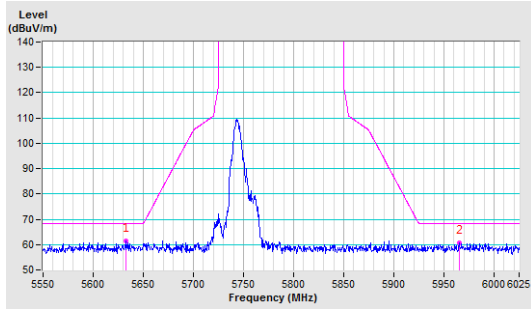

**Vertical**

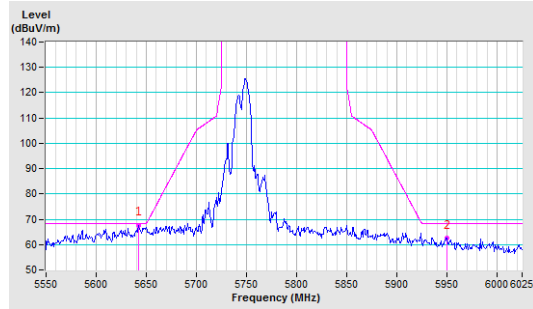

**CH 157 5785 MHz**

**Horizontal**

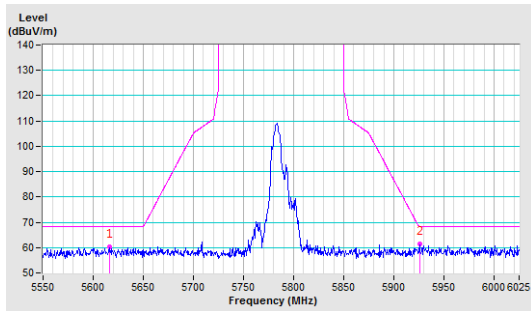

**Vertical**

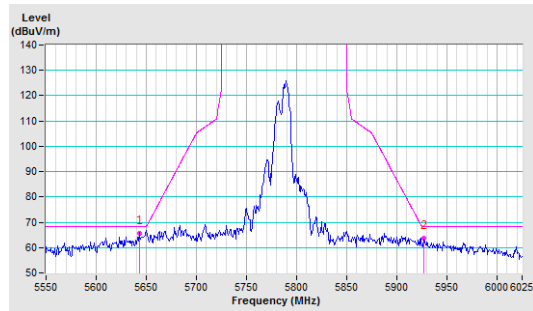

**CH 165 5825 MHz**

**Horizontal**

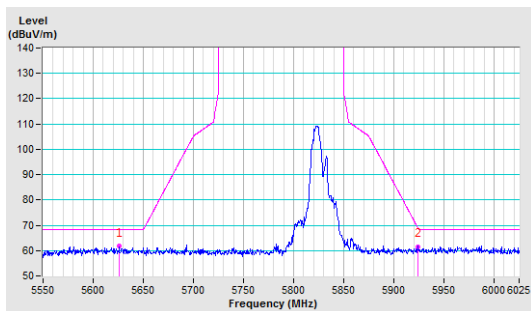

**Vertical**

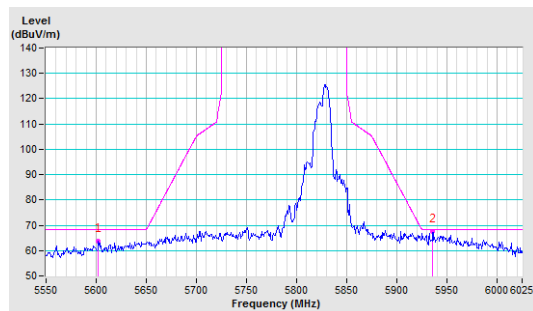



### 802.11ac (VHT20)

#### CH 149 5745 MHz

Horizontal

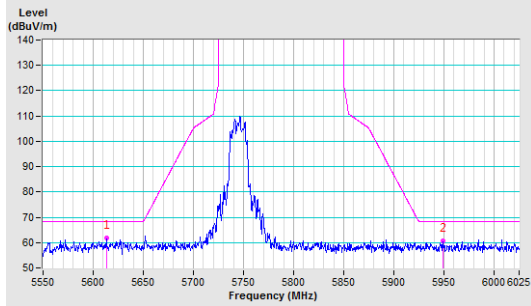

Vertical

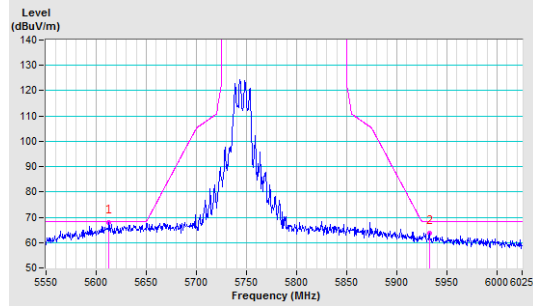

#### CH 157 5785 MHz

Horizontal

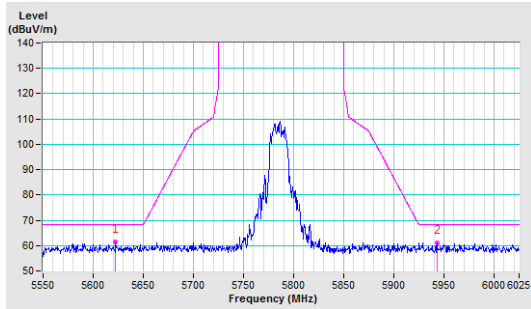

Vertical

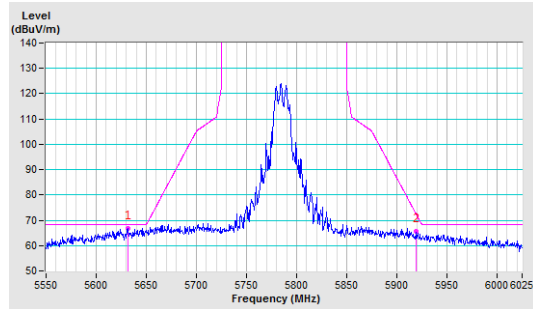

#### CH 165 5825 MHz

Horizontal

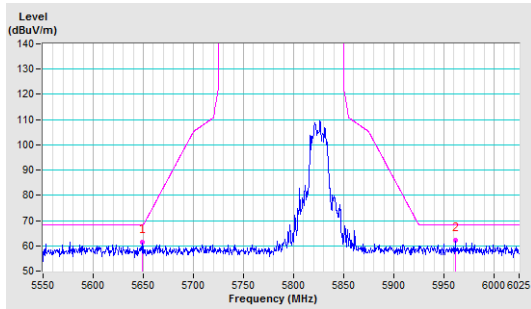

Vertical

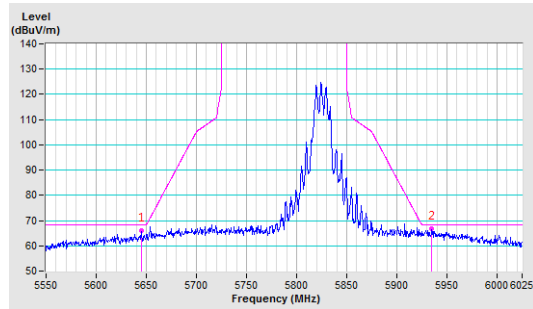

802.11ac (VHT40)

CH 151 5755 MHz

Horizontal

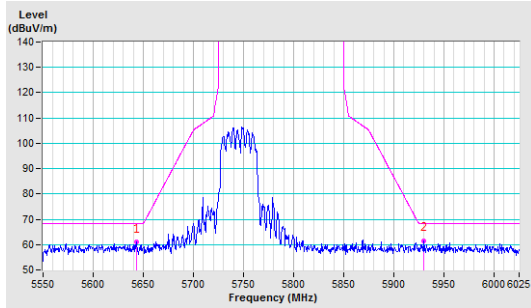

Vertical

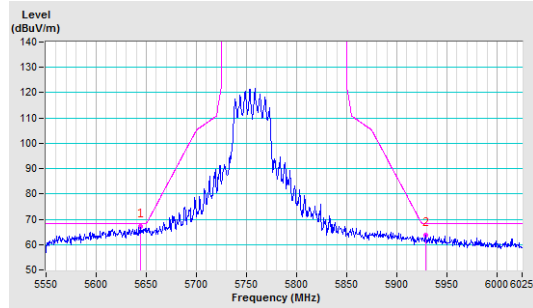

CH 159 5795 MHz

Horizontal

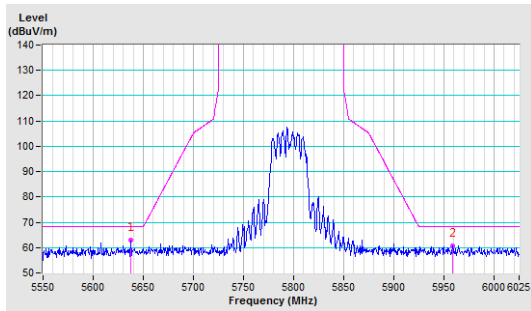

Vertical

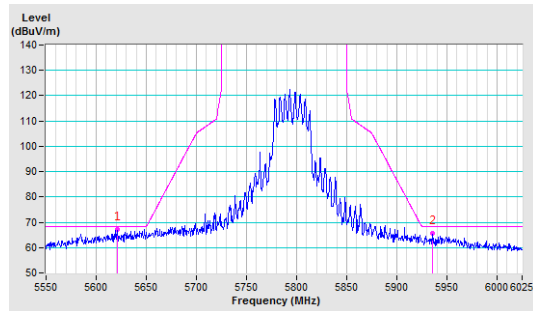

802.11ac (VHT80)

CH 155 5775 MHz

Horizontal

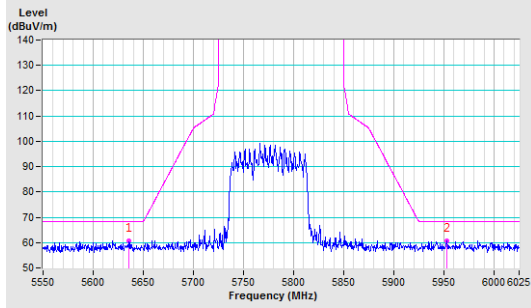

Vertical

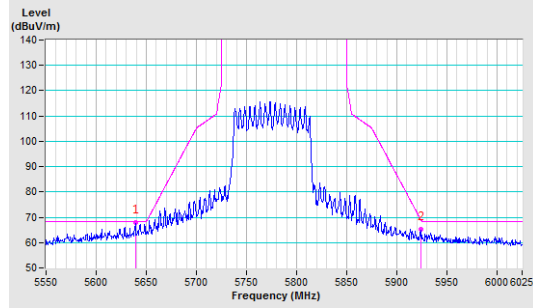

## Appendix – Information on the Testing Laboratories

We, Bureau Veritas Consumer Products Services (H.K.) Ltd., Taoyuan Branch, were founded in 1988 to provide our best service in EMC, Radio, Telecom and Safety consultation. Our laboratories are accredited and approved according to ISO/IEC 17025.

If you have any comments, please feel free to contact us at the following:

**Linko EMC/RF Lab**

Tel: 886-2-26052180

Fax: 886-2-26051924

**Hsin Chu EMC/RF/Telecom Lab**

Tel: 886-3-6668565

Fax: 886-3-6668323

**Hwa Ya EMC/RF/Safety Lab**

Tel: 886-3-3183232

Fax: 886-3-3270892

**Email:** [service.adt@tw.bureauveritas.com](mailto:service.adt@tw.bureauveritas.com)

**Web Site:** [www.bureauveritas-adt.com](http://www.bureauveritas-adt.com)

The address and road map of all our labs can be found in our web site also.

--- END ---