

FCC Test Report

Report No.: RF17829E16-1

FCC ID: KA2IR853A1

Test Model: DIR-853

Received Date: Aug. 29, 2017

Test Date: Nov. 27 to 29, 2017

Issued Date: Jan. 02, 2018

Applicant: D-Link Corporation

Address: 17595 Mt. Herrmann Street Fountain Valley, CA92708 USA

Issued By: Bureau Veritas Consumer Products Services (H.K.) Ltd., Taoyuan Branch
Hsin Chu Laboratory

Lab Address: E-2, No.1, Li Hsin 1st Road, Hsinchu Science Park, Hsinchu City 300,
Taiwan R.O.C.

Test Location : E-2, No.1, Li Hsin 1st Road, Hsinchu Science Park, Hsinchu City 300,
Taiwan R.O.C.

**FCC Registration /
Designation Number:** 723255 / TW2022



This report is for your exclusive use. Any copying or replication of this report to or for any other person or entity, or use of our name or trademark, is permitted only with our prior written permission. This report sets forth our findings solely with respect to the test samples identified herein. The results set forth in this report are not indicative or representative of the quality or characteristics of the lot from which a test sample was taken or any similar or identical product unless specifically and expressly noted. Our report includes all of the tests requested by you and the results thereof based upon the information that you provided to us. You have 60 days from date of issuance of this report to notify us of any material error or omission caused by our negligence, provided, however, that such notice shall be in writing and shall specifically address the issue you wish to raise. A failure to raise such issue within the prescribed time shall constitute your unqualified acceptance of the completeness of this report, the tests conducted and the correctness of the report contents. Unless specific mention, the uncertainty of measurement has been explicitly taken into account to declare the compliance or non-compliance to the specification. The report must not be used by the client to claim product certification, approval, or endorsement by TAF or any government agencies.

Table of Contents

Release Control Record	4
1 Certificate of Conformity	5
2 Summary of Test Results	6
2.1 Measurement Uncertainty	6
2.2 Modification Record	6
3 General Information	7
3.1 General Description of EUT	7
3.2 Description of Test Modes	9
3.2.1 Test Mode Applicability and Tested Channel Detail	10
3.3 Duty Cycle of Test Signal	12
3.4 Description of Support Units	13
3.4.1 Configuration of System under Test	13
3.5 General Description of Applied Standard	14
4 Test Types and Results	15
4.1 Radiated Emission and Bandedge Measurement	15
4.1.1 Limits of Radiated Emission and Bandedge Measurement	15
4.1.2 Test Instruments	16
4.1.3 Test Procedure	18
4.1.4 Deviation from Test Standard	18
4.1.5 Test Setup	19
4.1.6 EUT Operating Condition	20
4.1.7 Test Results	21
4.2 Conducted Emission Measurement	40
4.2.1 Limits of Conducted Emission Measurement	40
4.2.2 Test Instruments	40
4.2.3 Test Procedure	41
4.2.4 Deviation from Test Standard	41
4.2.5 Test Setup	41
4.2.6 EUT Operating Condition	41
4.2.7 Test Results	42
4.3 Transmit Power Measurement	44
4.3.1 Limits of Transmit Power Measurement	44
4.3.2 Test Setup	44
4.3.3 Test Instruments	44
4.3.4 Test Procedure	44
4.3.5 Deviation from Test Standard	44
4.3.6 EUT Operating Condition	44
4.3.7 Test Result	45
4.4 Occupied Bandwidth Measurement	47
4.4.1 Test Setup	47
4.4.2 Test Instruments	47
4.4.3 Test Procedure	47
4.4.4 Test Results	48
4.5 Peak Power Spectral Density Measurement	52
4.5.1 Limits of Peak Power Spectral Density Measurement	52
4.5.2 Test Setup	52
4.5.3 Test Instruments	52
4.5.4 Test Procedure	53
4.5.5 Deviation from Test Standard	53
4.5.6 EUT Operating Condition	53
4.5.7 Test Results	54
4.6 Frequency Stability Measurement	60
4.6.1 Limits of Frequency Stability Measurement	60

4.6.2	Test Setup.....	60
4.6.3	Test Instruments	60
4.6.4	Test Procedure	60
4.6.5	Deviation from Test Standard	60
4.6.6	EUT Operating Condition	60
4.6.7	Test Results	61
4.7	6dB Bandwidth Measurement	62
4.7.1	Limits of 6dB Bandwidth Measurement.....	62
4.7.2	Test Setup.....	62
4.7.3	Test Instruments	62
4.7.4	Test Procedure	62
4.7.5	Deviation from Test Standard	62
4.7.6	EUT Operating Condition	62
4.7.7	Test Results	63
5	Pictures of Test Arrangements.....	65
	Annex A- Radiated Out of Band Emission (OOBE) Measurement (For U-NII-3 band)	66
	Appendix – Information on the Testing Laboratories	70

Release Control Record

Issue No.	Description	Date Issued
RF17829E16-1	Original release.	Jan. 02, 2018

1 Certificate of Conformity

Product: AC1300 MU-MIMO Wi-Fi Gigabit Router

Brand: D-Link

Test Model: DIR-853

Sample Status: ENGINEERING SAMPLE

Applicant: D-Link Corporation

Test Date: Nov. 27 to 29, 2017

Standard: 47 CFR FCC Part 15, Subpart E (Section 15.407)
ANSI C63.10: 2013

The above equipment has been tested by **Bureau Veritas Consumer Products Services (H.K.) Ltd., Taoyuan Branch**, and found compliance with the requirement of the above standards. The test record, data evaluation & Equipment Under Test (EUT) configurations represented herein are true and accurate accounts of the measurements of the sample's EMC characteristics under the conditions specified in this report.

Prepared by : Cindy Hsin , **Date:** Jan. 02, 2018
Cindy Hsin / Specialist

Approved by : May Chen , **Date:** Jan. 02, 2018
May Chen / Manager

2 Summary of Test Results

47 CFR FCC Part 15, Subpart E (Section 15.407)			
FCC Clause	Test Item	Result	Remarks
15.407(b)(6)	AC Power Conducted Emissions	Pass	Meet the requirement of limit. Minimum passing margin is -15.80dB at 0.36094MHz.
15.407(b) (1/2/3/4(i/ii)/6)	Radiated Emissions & Band Edge Measurement*	Pass	Meet the requirement of limit. Minimum passing margin is -0.1dB at 5150.00MHz, 10480.00MHz, 17235.00MHz, 17475.00MHz, 17355.00MHz.
15.407(a)(1/2/3)	Max Average Transmit Power	Pass	Meet the requirement of limit.
---	Occupied Bandwidth Measurement	-	Reference only.
15.407(a)(1/2/3)	Peak Power Spectral Density	Pass	Meet the requirement of limit.
15.407(e)	6dB bandwidth	Pass	Meet the requirement of limit. (U-NII-3 Band only)
15.407(g)	Frequency Stability	Pass	Meet the requirement of limit.
15.203	Antenna Requirement	Pass	Antenna connector is i-pex(MHF) not a standard connector.

*For U-NII-3 band compliance with rule part 15.407(b)(4)(i), the OOB test plots were recorded in Annex A.

2.1 Measurement Uncertainty

Where relevant, the following measurement uncertainty levels have been estimated for tests performed on the EUT as specified in CISPR 16-4-2:

Measurement	Frequency	Expanded Uncertainty (k=2) (±)
Conducted Emissions at mains ports	150kHz ~ 30MHz	1.84 dB
Radiated Emissions up to 1 GHz	30MHz ~ 1GHz	5.30 dB
Radiated Emissions above 1 GHz	1GHz ~ 6GHz	5.16 dB
	6GHz ~ 18GHz	4.91 dB
	18GHz ~ 40GHz	5.30 dB

2.2 Modification Record

There were no modifications required for compliance.

3 General Information

3.1 General Description of EUT

Product	AC1300 MU-MIMO Wi-Fi Gigabit Router
Brand	D-Link
Test Model	DIR-853
Status of EUT	ENGINEERING SAMPLE
Power Supply Rating	12Vdc from power adapter
Modulation Type	CCK, DQPSK, DBPSK for DSSS 64QAM, 16QAM, QPSK, BPSK for OFDM 256QAM for OFDM in 11ac mode and 2.4GHz
Modulation Technology	DSSS, OFDM
Transfer Rate	802.11b: up to 11Mbps 802.11a/g: up to 54Mbps 802.11n: up to 300Mbps 802.11ac: up to 866.7Mbps
Operating Frequency	2.4GHz: 2.412 ~ 2.462GHz 5GHz: 5.18GHz ~ 5.24GHz, 5.745GHz ~ 5.825GHz
Number of Channel	2.4GHz: 802.11b, 802.11g, 802.11n (HT20), VHT20: 11 802.11n (HT40), VHT40: 7 5GHz: 802.11a, 802.11n (HT20), 802.11ac (VHT20): 9 802.11n (HT40), 802.11ac (VHT40): 4 802.11ac (VHT80): 2
Output Power	2.4GHz: 876.611mW 5GHz: CDD Mode 5.18 ~ 5.24GHz: 622.476 mW 5.745 ~ 5.825GHz 232.946 mW Beamforming Mode 5.18 ~ 5.24GHz: 622.476 mW 5.745 ~ 5.825GHz 232.946 mW
Antenna Type	Refer to Note
Antenna Connector	Refer to Note
Accessory Device	Adapter x 1
Data Cable Supplied	NA

Note:

1. Simultaneously transmission condition.

Condition	Technology	
1	WLAN 2.4GHz	WLAN 5GHz

Note: The emission of the simultaneous operation has been evaluated and no non-compliance was found.

2. The antennas provided to the EUT, please refer to the following table:

2.4GHz				
Antenna No.	Antenna Net Gain (dBi)	Frequency rang (GHz)	Antenna type	Connector type
1	5	2.4 ~ 2.4835	Dipole	i-pex(MHF)
2	5	2.4 ~ 2.4835	Dipole	i-pex(MHF)
5GHz				
Antenna No.	Antenna Net Gain (dBi)	Frequency rang (GHz)	Antenna type	Connector type
1	5	5.15 ~ 5.85	Dipole	i-pex(MHF)
2	5	5.15 ~ 5.85	Dipole	i-pex(MHF)

3. The EUT could be supplied with a power adaper as below table:

Brand	Model No.	Spec.
Shenzhen Gongjin Electronics Co., Ltd	S18B72-120A150-C4	Input: 100-240Vac, 0.7A, 50/60Hz Output: 12Vdc, 1.5A Power cord (Unshielded, 1.1m)

4. The EUT incorporates a MIMO function.

2.4GHz Band			
MODULATION MODE	DATA RATE (MCS)	TX & RX CONFIGURATION	
802.11b	1 ~ 11Mbps	2TX	2RX
802.11g	6 ~ 54Mbps	2TX	2RX
802.11n (HT20)	MCS 0~7	2TX	2RX
	MCS 8~15	2TX	2RX
802.11n (HT40)	MCS 0~7	2TX	2RX
	MCS 8~15	2TX	2RX
VHT20	MCS0~8 Nss=1	2TX	2RX
	MCS0~8 Nss=2	2TX	2RX
VHT 40	MCS0~9 Nss=1	2TX	2RX
	MCS0~9 Nss=2	2TX	2RX
5GHz Band			
MODULATION MODE	DATA RATE (MCS)	TX & RX CONFIGURATION	
802.11a	6 ~ 54Mbps	2TX	2RX
802.11n (HT20)	MCS 0~7	2TX	2RX
	MCS 8~15	2TX	2RX
802.11n (HT40)	MCS 0~7	2TX	2RX
	MCS 8~15	2TX	2RX
802.11ac (VHT20)	MCS0~8 Nss=1	2TX	2RX
	MCS0~8 Nss=2	2TX	2RX
802.11ac (VHT40)	MCS0~8 Nss=1	2TX	2RX
	MCS0~8 Nss=2	2TX	2RX
802.11ac (VHT80)	MCS0~8 Nss=1	2TX	2RX
	MCS0~8 Nss=2	2TX	2RX

Note:

- All of modulation mode support beamforming function except 2.4GHz and 802.11a modulation mode.
- The EUT support Beamforming and CDD mode, therefore both mode were investigated and the worst case scenario was identified. The worst case data were presented in test report.
- The modulation and bandwidth are similar for 802.11n mode for 20MHz (40MHz) and 802.11ac mode for 20MHz (40MHz), therefore investigated worst case to representative mode in test report. (Final test mode refer section 3.2.1)

5. The above EUT information is declared by manufacturer and for more detailed features description, please refer to the manufacturer's specifications or user's manual.

3.2 Description of Test Modes

FOR 5180 ~ 5240MHz

4 channels are provided for 802.11a, 802.11n (HT20), 802.11ac (VHT20):

Channel	Frequency	Channel	Frequency
36	5180MHz	44	5220MHz
40	5200MHz	48	5240MHz

2 channels are provided for 802.11n (HT40), 802.11ac (VHT40):

Channel	Frequency	Channel	Frequency
38	5190MHz	46	5230MHz

1 channel is provided for 802.11ac (VHT80):

Channel	Frequency
42	5210MHz

FOR 5745 ~ 5825MHz:

5 channels are provided for 802.11a, 802.11n (HT20), 802.11ac (VHT20):

Channel	Frequency	Channel	Frequency
149	5745MHz	161	5805MHz
153	5765MHz	165	5825MHz
157	5785MHz		

2 channels are provided for 802.11n (HT40), 802.11ac (VHT40):

Channel	Frequency	Channel	Frequency
151	5755MHz	159	5795MHz

1 channel is provided for 802.11ac (VHT80):

Channel	Frequency
155	5775MHz

3.2.1 Test Mode Applicability and Tested Channel Detail

EUT Configure Mode	Applicable To				Description
	RE \geq 1G	RE $<$ 1G	PLC	APCM	
-	√	√	√	√	-

Where **RE \geq 1G**: Radiated Emission above 1GHz

RE $<$ 1G: Radiated Emission below 1GHz

PLC: Power Line Conducted Emission

APCM: Antenna Port Conducted Measurement

NOTE: The EUT had been pre-tested on the positioned of each 2 axis. The worst case was found when positioned on **Y-plane**.

Radiated Emission Test (Above 1GHz):

- Pre-Scan has been conducted to determine the worst-case mode from all possible combinations between available modulations, data rates and antenna ports (if EUT with antenna diversity architecture).
- Following channel(s) was (were) selected for the final test as listed below.

CDD Mode						
Mode	FREQ. Band (MHz)	Available Channel	Tested Channel	Modulation Technology	Modulation Type	Data Rate (Mbps)
802.11a	5180-5240	36 to 48	36, 40, 48	OFDM	BPSK	6
802.11ac (VHT20)		36 to 48	36, 40, 48	OFDM	BPSK	6.5
802.11ac (VHT40)		38 to 46	38, 46	OFDM	BPSK	13.5
802.11ac (VHT80)		42	42	OFDM	BPSK	29.3
802.11a	5745-5825	149 to 165	149, 157, 165	OFDM	BPSK	6
802.11ac (VHT20)		149 to 165	149, 157, 165	OFDM	BPSK	6.5
802.11ac (VHT40)		151 to 159	151, 159	OFDM	BPSK	13.5
802.11ac (VHT80)		155	155	OFDM	BPSK	29.3

Radiated Emission Test (Below 1GHz):

- Pre-Scan has been conducted to determine the worst-case mode from all possible combinations between available modulations, data rates and antenna ports (if EUT with antenna diversity architecture).
- Following channel(s) was (were) selected for the final test as listed below.

CDD Mode						
Mode	FREQ. Band (MHz)	Available Channel	Tested Channel	Modulation Technology	Modulation Type	Data Rate (Mbps)
802.11ac (VHT20)	5180-5240 5745-5825	36 to 48 149 to 165	40	OFDM	BPSK	6.5

Power Line Conducted Emission Test:

- Pre-Scan has been conducted to determine the worst-case mode from all possible combinations between available modulations, data rates and antenna ports (if EUT with antenna diversity architecture).
- Following channel(s) was (were) selected for the final test as listed below.

CDD Mode						
Mode	FREQ. Band (MHz)	Available Channel	Tested Channel	Modulation Technology	Modulation Type	Data Rate (Mbps)
802.11ac (VHT20)	5180-5240 5745-5825	36 to 48 149 to 165	40	OFDM	BPSK	6.5

Antenna Port Conducted Measurement:

- This item includes all test value of each mode, but only includes spectrum plot of worst value of each mode.
- Pre-Scan has been conducted to determine the worst-case mode from all possible combinations between available modulations, data rates and antenna ports (if EUT with antenna diversity architecture).
- Following channel(s) was (were) selected for the final test as listed below.

CDD Mode						
Mode	FREQ. Band (MHz)	Available Channel	Tested Channel	Modulation Technology	Modulation Type	Data Rate (Mbps)
802.11a	5180-5240	36 to 48	36, 40, 48	OFDM	BPSK	6
802.11ac (VHT20)		36 to 48	36, 40, 48	OFDM	BPSK	6.5
802.11ac (VHT40)		38 to 46	38, 46	OFDM	BPSK	13.5
802.11ac (VHT80)		42	42	OFDM	BPSK	29.3
802.11a	5745-5825	149 to 165	149, 157, 165	OFDM	BPSK	6
802.11ac (VHT20)		149 to 165	149, 157, 165	OFDM	BPSK	6.5
802.11ac (VHT40)		151 to 159	151, 159	OFDM	BPSK	13.5
802.11ac (VHT80)		155	155	OFDM	BPSK	29.3
Beamforming Mode (Output power only)						
Mode	FREQ. Band (MHz)	Available Channel	Tested Channel	Modulation Technology	Modulation Type	Data Rate (Mbps)
802.11ac (VHT20)	5180-5240	36 to 48	36, 40, 48	OFDM	BPSK	6.5
802.11ac (VHT40)		38 to 46	38, 46	OFDM	BPSK	13.5
802.11ac (VHT80)		42	42	OFDM	BPSK	29.3
802.11ac (VHT20)	5745-5825	149 to 165	149, 157, 165	OFDM	BPSK	6.5
802.11ac (VHT40)		151 to 159	151, 159	OFDM	BPSK	13.5
802.11ac (VHT80)		155	155	OFDM	BPSK	29.3

Test Condition:

Applicable To	Environmental Conditions	Input Power	Tested By
RE \geq 1G	23deg. C, 65%RH	120Vac, 60Hz	Jyunchun Lin
RE $<$ 1G	24deg. C, 64%RH	120Vac, 60Hz	Jyunchun Lin
PLC	25deg. C, 58%RH	120Vac, 60Hz	Andy Ho
APCM	25deg. C, 60%RH	120Vac, 60Hz	Robert Cheng

3.3 Duty Cycle of Test Signal

If duty cycle of test signal is < 98%, duty factor shall be considered.

802.11a: Duty cycle = 1.394/1.724 = 0.809, Duty factor = $10 \cdot \log(1/0.809) = 0.92$

802.11ac (VHT20): Duty cycle = 1.293/1.639 = 0.789, Duty factor = $10 \cdot \log(1/0.789) = 1.03$

802.11ac (VHT40): Duty cycle = 0.633/0.956 = 0.662, Duty factor = $10 \cdot \log(1/0.662) = 1.79$

802.11ac (VHT80): Duty cycle = 1.053/1.116 = 0.944, Duty factor = $10 \cdot \log(1/0.944) = 0.25$

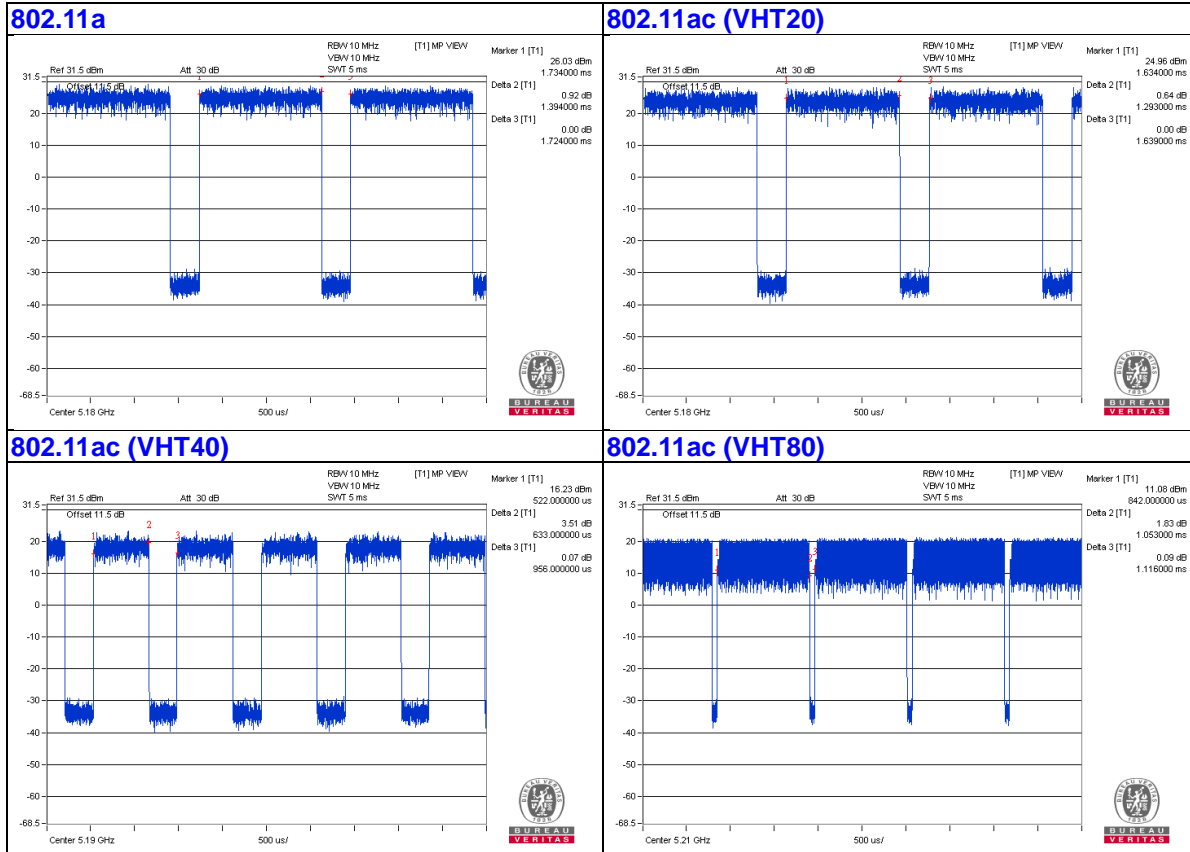

3.4 Description of Support Units

The EUT has been tested as an independent unit together with other necessary accessories or support units. The following support units or accessories were used to form a representative test configuration during the tests.

ID	Product	Brand	Model No.	Serial No.	FCC ID	Remarks
A.	Laptop	DELL	E5430	4YV4VY1	FCC DoC	Provided by Lab
B.	Laptop	DELL	E5430	HYV4VY1	FCC DoC	Provided by Lab
C.	USB Disk	Transcend	16GB	NA	NA	Provided by Lab

Note:

1. All power cords of the above support units are non-shielded (1.8m).

ID	Descriptions	Qty.	Length (m)	Shielding (Yes/No)	Cores (Qty.)	Remarks
1.	RJ-45 Cable	1	10	No	0	Provided by Lab
2.	RJ-45 Cable	1	10	No	0	Provided by Lab
3.	DC Cable	1	1.1	No	0	Supplied by client

3.4.1 Configuration of System under Test

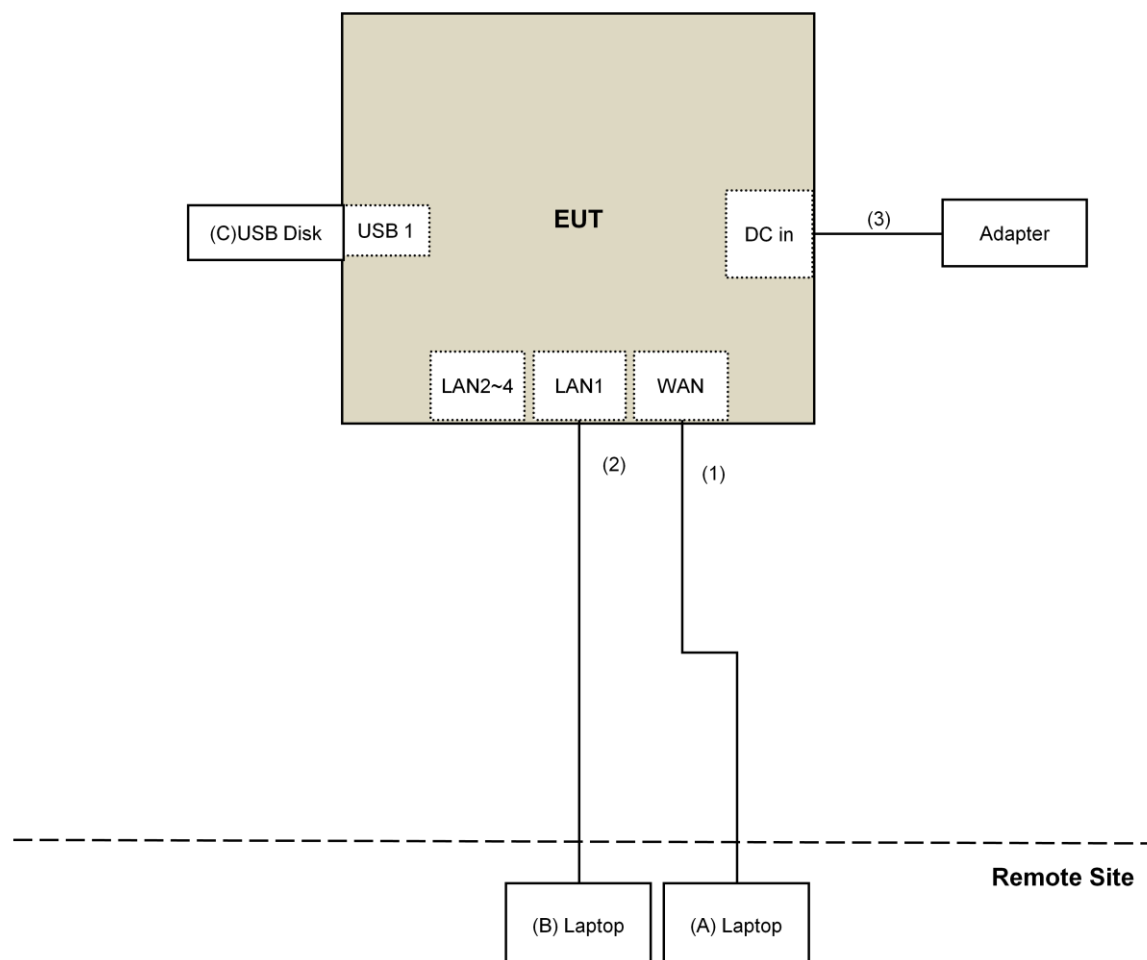

3.5 General Description of Applied Standard

The EUT is a RF Product. According to the specifications of the manufacturer, it must comply with the requirements of the following standards:

FCC Part 15, Subpart E (15.407)
KDB 789033 D02 General UNII Test Procedure New Rules v01r04
KDB 662911 D01 Multiple Transmitter Output v02r01
ANSI C63.10-2013

All test items have been performed and recorded as per the above standards.

NOTE: The EUT has been verified to comply with the requirements of FCC Part 15, Subpart B, Class B (DoC). The test report has been issued separately.

4 Test Types and Results

4.1 Radiated Emission and Bandedge Measurement

4.1.1 Limits of Radiated Emission and Bandedge Measurement

Radiated emissions which fall in the restricted bands must comply with the radiated emission limits specified as below table.

Frequencies (MHz)	Field Strength (microvolts/meter)	Measurement Distance (meters)
0.009 ~ 0.490	2400/F(kHz)	300
0.490 ~ 1.705	24000/F(kHz)	30
1.705 ~ 30.0	30	30
30 ~ 88	100	3
88 ~ 216	150	3
216 ~ 960	200	3
Above 960	500	3

NOTE:

1. The lower limit shall apply at the transition frequencies.
2. Emission level (dBuV/m) = 20 log Emission level (uV/m).
3. For frequencies above 1000MHz, the field strength limits are based on average detector, however, the peak field strength of any emission shall not exceed the maximum permitted average limits, specified above by more than 20dB under any condition of modulation.

Limits of unwanted emission out of the restricted bands

Applicable To		Limit	
789033 D02 General UNII Test Procedure New Rules v01r04		Field Strength at 3m	
		PK:74 (dBuV/m)	AV:54 (dBuV/m)
Frequency Band	Applicable To	EIRP Limit	Equivalent Field Strength at 3m
5150~5250 MHz	15.407(b)(1)	PK:-27 (dBm/MHz)	PK:68.2(dBuV/m)
5250~5350 MHz	15.407(b)(2)		
5470~5725 MHz	15.407(b)(3)		
5725~5850 MHz	<input checked="" type="checkbox"/> 15.407(b)(4)(i)	PK:-27 (dBm/MHz) ^{*1} PK:10 (dBm/MHz) ^{*2} PK:15.6 (dBm/MHz) ^{*3} PK:27 (dBm/MHz) ^{*4}	PK: 68.2(dBuV/m) ^{*1} PK:105.2 (dBuV/m) ^{*2} PK: 110.8(dBuV/m) ^{*3} PK:122.2 (dBuV/m) ^{*4}
	<input type="checkbox"/> 15.407(b)(4)(ii)	Emission limits in section 15.247(d)	
^{*1} beyond 75 MHz or more above of the band edge.		^{*2} below the band edge increasing linearly to 10 dBm/MHz at 25 MHz above.	
^{*3} below the band edge increasing linearly to a level of 15.6 dBm/MHz at 5 MHz above.		^{*4} from 5 MHz above or below the band edge increasing linearly to a level of 27 dBm/MHz at the band edge.	

Note:

The following formula is used to convert the equipment isotropic radiated power (eirp) to field strength:

$$E = \frac{1000000\sqrt{30P}}{3} \mu\text{V/m, where } P \text{ is the eirp (Watts).}$$

4.1.2 Test Instruments

DESCRIPTION & MANUFACTURER	MODEL NO.	SERIAL NO.	CALIBRATED DATE	CALIBRATED UNTIL
Test Receiver Keysight	N9038A	MY54450088	July 08, 2017	July 07, 2018
Pre-Amplifier ^(*) EMCI	EMC001340	980142	Jan. 20, 2016	Jan. 19, 2018
Loop Antenna ^(*) Electro-Metrics	EM-6879	264	Dec. 16, 2016	Dec. 15, 2018
RF Cable	NA	LOOPCAB-001 LOOPCAB-002	Jan. 17, 2017	Jan. 16, 2018
Pre-Amplifier Mini-Circuits	ZFL-1000VH2B	AMP-ZFL-01	Nov. 09, 2017	Nov. 08, 2018
Trilog Broadband Antenna SCHWARZBECK	VULB 9168	9168-406	Dec. 13, 2016	Dec. 12, 2017
RF Cable	8D	966-4-1 966-4-2 966-4-3	Apr. 01, 2017	Mar. 31, 2018
Fixed attenuator Mini-Circuits	UNAT-5+	PAD-3m-4-01	Oct. 03, 2017	Oct. 02, 2018
Horn_Antenna SCHWARZBECK	BBHA 9120D	9120D-783	Dec. 27, 2016	Dec. 26, 2017
Pre-Amplifier EMCI	EMC12630SE	980385	Feb. 02, 2017	Feb. 01, 2018
RF Cable	EMC104-SM-SM-1200 EMC104-SM-SM-2000 EMC104-SM-SM-5000	160923 150318 150321	Feb. 02, 2017 Mar. 29, 2017 Mar. 29, 2017	Feb. 01, 2018 Mar. 28, 2018 Mar. 28, 2018
Pre-Amplifier EMCI	EMC184045SE	980387	Feb. 02, 2017	Feb. 01, 2018
Horn_Antenna SCHWARZBECK	BBHA 9170	BBHA9170608	Dec. 15, 2016	Dec. 14, 2017
RF Cable	SUCOFLEX 102	36432/2 36433/2	Jan. 15, 2017	Jan. 14, 2018
Software	ADT_Radiated_V8.7.08	NA	NA	NA
Antenna Tower & Turn Table Max-Full	MF-7802	MF780208410	NA	NA
Boresight Antenna Fixture	FBA-01	FBA-SIP02	NA	NA
Spectrum Analyzer R&S	FSv40	100964	July 1, 2017	June 30, 2018
Power meter Anritsu	ML2495A	1014008	May 11, 2017	May 10, 2018
Power sensor Anritsu	MA2411B	0917122	May 11, 2017	May 10, 2018
AC Power Source Extech Electronics	6205	1440452	NA	NA
Temperature & Humidity Chamber Giant Force	GTH-150-40-SP-AR	MAA0812-008	Jan. 11, 2017	Jan. 10, 2018
True RMS Clamp Meter FLUKE	325	31130711WS	May 29, 2017	May 28, 2018

Note:

1. The calibration interval of the above test instruments is 12 months and the calibrations are traceable to NML/ROC and NIST/USA.
2. *The calibration interval of the above test instruments is 24 months and the calibrations are traceable to NML/ROC and NIST/USA.
3. The test was performed in 966 Chamber No. 4.
4. The CANADA Site Registration No. is 20331-2
5. Loop antenna was used for all emissions below 30 MHz.
6. Tested Date: Nov. 27, 2017

4.1.3 Test Procedure

For Radiated emission below 30MHz

- a. The EUT was placed on the top of a rotating table 0.8 meters above the ground at a 3 meter chamber room. The table was rotated 360 degrees to determine the position of the highest radiation.
- b. The EUT was set 3 meters away from the interference-receiving antenna, which was mounted on the top of a variable-height antenna tower.
- c. Both X and Y axes of the antenna are set to make the measurement.
- d. For each suspected emission, the EUT was arranged to its worst case and the rotatable table was turned from 0 degrees to 360 degrees to find the maximum reading.
- e. The test-receiver system was set to Quasi-Peak Detect Function and Specified Bandwidth with Maximum Hold Mode.

NOTE:

1. The resolution bandwidth and video bandwidth of test receiver/spectrum analyzer is 9kHz at frequency below 30MHz.

For Radiated emission above 30MHz

- a. The EUT was placed on the top of a rotating table 0.8 meters (for 30MHz ~ 1GHz) / 1.5 meters (for above 1GHz) above the ground at 3 meter chamber room for test. The table was rotated 360 degrees to determine the position of the highest radiation.
- b. The EUT was set 3 meters away from the interference-receiving antenna, which was mounted on the top of a variable-height antenna tower.
- c. The height of antenna is varied from one meter to four meters above the ground to determine the maximum value of the field strength. Both horizontal and vertical polarizations of the antenna are set to make the measurement.
- d. For each suspected emission, the EUT was arranged to its worst case and then the antenna was tuned to heights from 1 meter to 4 meters and the rotatable table was turned from 0 degrees to 360 degrees to find the maximum reading.
- e. The test-receiver system was set to quasi-peak detect function and specified bandwidth with maximum hold mode when the test frequency is below 1 GHz.
- f. The test-receiver system was set to peak and average detect function and specified bandwidth with maximum hold mode when the test frequency is above 1 GHz. If the peak reading value also meets average limit, measurement with the average detector is unnecessary.

Note:

1. The resolution bandwidth and video bandwidth of test receiver/spectrum analyzer is 120kHz for Quasi-peak detection (QP) at frequency below 1GHz.
2. The resolution bandwidth of test receiver/spectrum analyzer is 1 MHz and the video bandwidth is 3 MHz for Peak detection (PK) at frequency above 1GHz.
3. The resolution bandwidth of test receiver/spectrum analyzer is 1MHz and the video bandwidth is $\geq 1/T$ (Duty cycle < 98%) or 10Hz (Duty cycle $\geq 98\%$) for Average detection (AV) at frequency above 1GHz.
4. All modes of operation were investigated and the worst-case emissions are reported.

4.1.4 Deviation from Test Standard

No deviation.

4.1.5 Test Setup

For Radiated emission below 30MHz

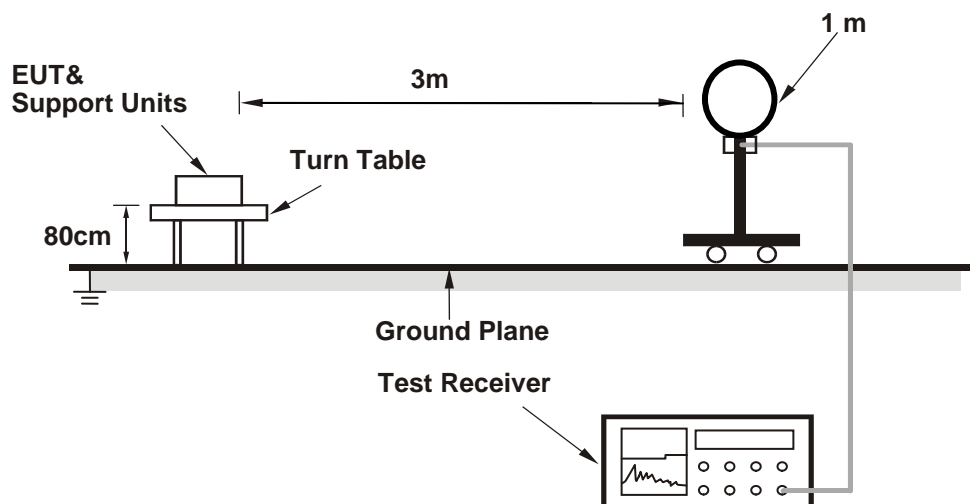

For Radiated emission 30MHz to 1GHz

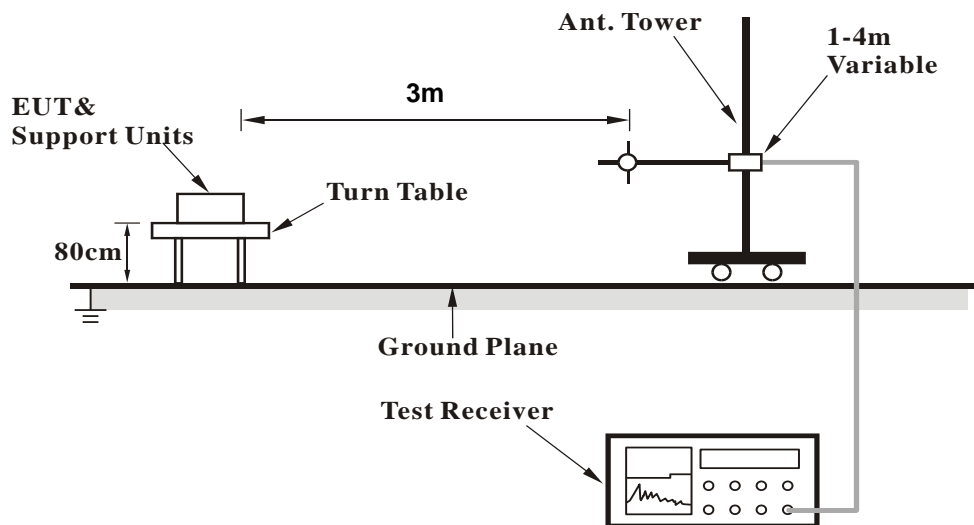

For Radiated emission above 1GHz

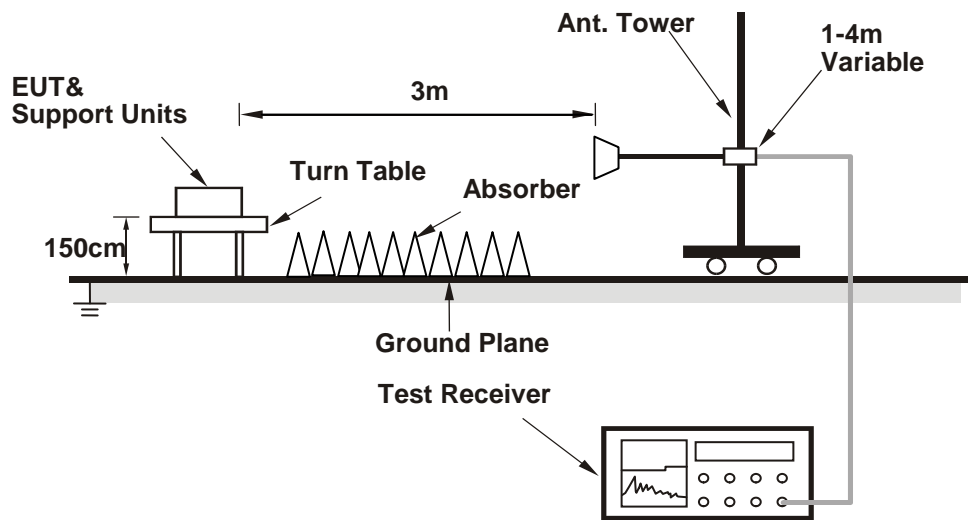

For the actual test configuration, please refer to the attached file (Test Setup Photo).

4.1.6 EUT Operating Condition

- a. Connected the EUT with the Laptop which is placed on remote site.
- b. Controlling software (QATool V1.84) has been activated to set the EUT on specific status.

4.1.7 Test Results

Above 1GHz Data:

802.11a

CHANNEL	TX Channel 36	DETECTOR FUNCTION	Peak (PK)
FREQUENCY RANGE	1GHz ~ 40GHz		Average (AV)

ANTENNA POLARITY & TEST DISTANCE: HORIZONTAL AT 3 M

NO.	FREQ. (MHz)	EMISSION LEVEL (dBuV/m)	LIMIT (dBuV/m)	MARGIN (dB)	ANTENNA HEIGHT (m)	TABLE ANGLE (Degree)	RAW VALUE (dBuV)	CORRECTION FACTOR (dB/m)
1	5150.00	61.2 PK	74.0	-12.8	1.87 H	239	57.2	4.0
2	5150.00	42.6 AV	54.0	-11.4	1.87 H	239	38.6	4.0
3	*5180.00	106.7 PK			1.87 H	239	102.7	4.0
4	*5180.00	98.0 AV			1.87 H	239	94.0	4.0
5	#10360.00	66.8 PK	74.0	-7.2	1.87 H	318	53.2	13.6
6	#10360.00	53.5 AV	54.0	-0.5	1.87 H	318	39.9	13.6
7	15540.00	61.9 PK	74.0	-12.1	1.81 H	66	48.7	13.2
8	15540.00	46.5 AV	54.0	-7.5	1.81 H	66	33.3	13.2

ANTENNA POLARITY & TEST DISTANCE: VERTICAL AT 3 M

NO.	FREQ. (MHz)	EMISSION LEVEL (dBuV/m)	LIMIT (dBuV/m)	MARGIN (dB)	ANTENNA HEIGHT (m)	TABLE ANGLE (Degree)	RAW VALUE (dBuV)	CORRECTION FACTOR (dB/m)
1	5150.00	71.7 PK	74.0	-2.3	1.50 V	199	67.7	4.0
2	5150.00	53.9 AV	54.0	-0.1	1.50 V	199	49.9	4.0
3	*5180.00	119.0 PK			1.50 V	210	115.0	4.0
4	*5180.00	110.0 AV			1.50 V	210	106.0	4.0
5	#10360.00	59.8 PK	74.0	-14.2	3.10 V	14	46.2	13.6
6	#10360.00	46.0 AV	54.0	-8.0	3.10 V	14	32.4	13.6
7	15540.00	59.6 PK	74.0	-14.4	1.67 V	14	46.4	13.2
8	15540.00	44.5 AV	54.0	-9.5	1.67 V	14	31.3	13.2

REMARKS:

1. Emission Level(dBuV/m) = Raw Value(dBuV) + Correction Factor(dB/m)
2. Correction Factor(dB/m) = Antenna Factor(dB/m) + Cable Factor(dB) – Pre-Amplifier Factor(dB)
3. The other emission levels were very low against the limit.
4. Margin value = Emission Level – Limit value
5. " * ": Fundamental frequency.
6. " # ": The radiated frequency is out of the restricted band.

CHANNEL	TX Channel 40	DETECTOR FUNCTION	Peak (PK)
FREQUENCY RANGE	1GHz ~ 40GHz		Average (AV)

ANTENNA POLARITY & TEST DISTANCE: HORIZONTAL AT 3 M

NO.	FREQ. (MHz)	EMISSION LEVEL (dBuV/m)	LIMIT (dBuV/m)	MARGIN (dB)	ANTENNA HEIGHT (m)	TABLE ANGLE (Degree)	RAW VALUE (dBuV)	CORRECTION FACTOR (dB/m)
1	5150.00	60.5 PK	74.0	-13.5	1.91 H	224	56.5	4.0
2	5150.00	42.8 AV	54.0	-11.2	1.91 H	224	38.8	4.0
3	*5200.00	107.8 PK			1.91 H	224	103.8	4.0
4	*5200.00	98.8 AV			1.91 H	224	94.8	4.0
5	5350.00	58.4 PK	74.0	-15.6	1.91 H	224	54.0	4.4
6	5350.00	41.5 AV	54.0	-12.5	1.91 H	224	37.1	4.4
7	#10400.00	67.8 PK	74.0	-6.2	1.81 H	317	54.2	13.6
8	#10400.00	53.8 AV	54.0	-0.2	1.81 H	317	40.2	13.6
9	15600.00	63.4 PK	74.0	-10.6	1.81 H	25	50.0	13.4
10	15600.00	49.9 AV	54.0	-4.1	1.81 H	25	36.5	13.4

ANTENNA POLARITY & TEST DISTANCE: VERTICAL AT 3 M

NO.	FREQ. (MHz)	EMISSION LEVEL (dBuV/m)	LIMIT (dBuV/m)	MARGIN (dB)	ANTENNA HEIGHT (m)	TABLE ANGLE (Degree)	RAW VALUE (dBuV)	CORRECTION FACTOR (dB/m)
1	5150.00	69.4 PK	74.0	-4.6	1.50 V	339	65.4	4.0
2	5150.00	53.9 AV	54.0	-0.1	1.50 V	339	49.9	4.0
3	*5200.00	121.0 PK			1.50 V	339	117.0	4.0
4	*5200.00	111.3 AV			1.50 V	339	107.3	4.0
5	5350.00	65.2 PK	74.0	-8.8	1.50 V	339	60.8	4.4
6	5350.00	52.2 AV	54.0	-1.8	1.50 V	339	47.8	4.4
7	#10400.00	60.5 PK	74.0	-13.5	3.05 V	15	46.9	13.6
8	#10400.00	46.9 AV	54.0	-7.1	3.05 V	15	33.3	13.6
9	15600.00	61.6 PK	74.0	-12.4	1.72 V	28	48.2	13.4
10	15600.00	47.3 AV	54.0	-6.7	1.72 V	28	33.9	13.4

REMARKS:

1. Emission Level(dBuV/m) = Raw Value(dBuV) + Correction Factor(dB/m)
2. Correction Factor(dB/m) = Antenna Factor(dB/m) + Cable Factor(dB) – Pre-Amplifier Factor(dB)
3. The other emission levels were very low against the limit.
4. Margin value = Emission Level – Limit value
5. " * ": Fundamental frequency.
6. " # ": The radiated frequency is out of the restricted band.

CHANNEL	TX Channel 48	DETECTOR FUNCTION	Peak (PK)
FREQUENCY RANGE	1GHz ~ 40GHz		Average (AV)

ANTENNA POLARITY & TEST DISTANCE: HORIZONTAL AT 3 M

NO.	FREQ. (MHz)	EMISSION LEVEL (dBuV/m)	LIMIT (dBuV/m)	MARGIN (dB)	ANTENNA HEIGHT (m)	TABLE ANGLE (Degree)	RAW VALUE (dBuV)	CORRECTION FACTOR (dB/m)
1	*5240.00	108.4 PK			1.94 H	219	104.2	4.2
2	*5240.00	99.2 AV			1.94 H	219	95.0	4.2
3	5350.00	56.7 PK	74.0	-17.3	1.94 H	219	52.3	4.4
4	5350.00	40.8 AV	54.0	-13.2	1.94 H	219	36.4	4.4
5	#10480.00	67.1 PK	74.0	-6.9	1.83 H	318	53.4	13.7
6	#10480.00	53.9 AV	54.0	-0.1	1.83 H	318	40.2	13.7
7	15720.00	63.3 PK	74.0	-10.7	1.84 H	29	49.3	14.0
8	15720.00	49.6 AV	54.0	-4.4	1.84 H	29	35.6	14.0

ANTENNA POLARITY & TEST DISTANCE: VERTICAL AT 3 M

NO.	FREQ. (MHz)	EMISSION LEVEL (dBuV/m)	LIMIT (dBuV/m)	MARGIN (dB)	ANTENNA HEIGHT (m)	TABLE ANGLE (Degree)	RAW VALUE (dBuV)	CORRECTION FACTOR (dB/m)
1	*5240.00	120.5 PK			1.50 V	340	116.3	4.2
2	*5240.00	111.0 AV			1.50 V	340	106.8	4.2
3	5350.00	63.5 PK	74.0	-10.5	1.50 V	340	59.1	4.4
4	5350.00	51.5 AV	54.0	-2.5	1.50 V	340	47.1	4.4
5	#10480.00	60.6 PK	74.0	-13.4	3.06 V	6	46.9	13.7
6	#10480.00	47.0 AV	54.0	-7.0	3.06 V	6	33.3	13.7
7	15720.00	61.0 PK	74.0	-13.0	1.67 V	29	47.0	14.0
8	15720.00	46.9 AV	54.0	-7.1	1.67 V	29	32.9	14.0

REMARKS:

1. Emission Level(dBuV/m) = Raw Value(dBuV) + Correction Factor(dB/m)
2. Correction Factor(dB/m) = Antenna Factor(dB/m) + Cable Factor(dB) – Pre-Amplifier Factor(dB)
3. The other emission levels were very low against the limit.
4. Margin value = Emission Level – Limit value
5. " * ": Fundamental frequency.
6. " # ": The radiated frequency is out of the restricted band.

CHANNEL	TX Channel 149	DETECTOR FUNCTION	Peak (PK)
FREQUENCY RANGE	1GHz ~ 40GHz		Average (AV)

ANTENNA POLARITY & TEST DISTANCE: HORIZONTAL AT 3 M

NO.	FREQ. (MHz)	EMISSION LEVEL (dBuV/m)	LIMIT (dBuV/m)	MARGIN (dB)	ANTENNA HEIGHT (m)	TABLE ANGLE (Degree)	RAW VALUE (dBuV)	CORRECTION FACTOR (dB/m)
1	#5649.00	55.4 PK	68.2	-12.8	1.43 H	115	50.6	4.8
2	*5745.00	102.8 PK			1.43 H	115	97.8	5.0
3	*5745.00	93.2 AV			1.43 H	115	88.2	5.0
4	#5969.73	55.2 PK	68.2	-13.0	1.43 H	115	49.7	5.5
5	11490.00	63.7 PK	74.0	-10.3	1.87 H	59	49.6	14.1
6	11490.00	50.4 AV	54.0	-3.6	1.87 H	59	36.3	14.1
7	#17235.00	65.9 PK	74.0	-8.1	1.71 H	35	47.6	18.3
8	#17235.00	53.9 AV	54.0	-0.1	1.71 H	35	35.6	18.3

ANTENNA POLARITY & TEST DISTANCE: VERTICAL AT 3 M

NO.	FREQ. (MHz)	EMISSION LEVEL (dBuV/m)	LIMIT (dBuV/m)	MARGIN (dB)	ANTENNA HEIGHT (m)	TABLE ANGLE (Degree)	RAW VALUE (dBuV)	CORRECTION FACTOR (dB/m)
1	#5640.65	58.8 PK	68.2	-9.4	1.50 V	336	54.0	4.8
2	*5745.00	113.5 PK			1.50 V	336	108.5	5.0
3	*5745.00	104.0 AV			1.50 V	336	99.0	5.0
4	#5968.14	54.1 PK	68.2	-14.1	1.50 V	336	48.6	5.5
5	11490.00	56.9 PK	74.0	-17.1	3.07 V	18	42.8	14.1
6	11490.00	44.7 AV	54.0	-9.3	3.07 V	18	30.6	14.1
7	#17235.00	63.9 PK	74.0	-10.1	1.73 V	44	45.6	18.3
8	#17235.00	51.7 AV	54.0	-2.3	1.73 V	44	33.4	18.3

REMARKS:

1. Emission Level(dBuV/m) = Raw Value(dBuV) + Correction Factor(dB/m)
2. Correction Factor(dB/m) = Antenna Factor(dB/m) + Cable Factor(dB) – Pre-Amplifier Factor(dB)
3. The other emission levels were very low against the limit.
4. Margin value = Emission Level – Limit value
5. " * ": Fundamental frequency.
6. " # ": The radiated frequency is out of the restricted band.

CHANNEL	TX Channel 157	DETECTOR FUNCTION	Peak (PK)
FREQUENCY RANGE	1GHz ~ 40GHz		Average (AV)

ANTENNA POLARITY & TEST DISTANCE: HORIZONTAL AT 3 M

NO.	FREQ. (MHz)	EMISSION LEVEL (dBuV/m)	LIMIT (dBuV/m)	MARGIN (dB)	ANTENNA HEIGHT (m)	TABLE ANGLE (Degree)	RAW VALUE (dBuV)	CORRECTION FACTOR (dB/m)
1	#5623.51	54.6 PK	68.2	-13.6	1.29 H	115	49.9	4.7
2	*5785.00	102.2 PK			1.29 H	115	97.2	5.0
3	*5785.00	92.8 AV			1.29 H	115	87.8	5.0
4	#5942.27	55.6 PK	68.2	-12.6	1.29 H	115	50.2	5.4
5	11570.00	63.6 PK	74.0	-10.4	1.81 H	56	49.6	14.0
6	11570.00	50.3 AV	54.0	-3.7	1.81 H	56	36.3	14.0
7	#17355.00	65.5 PK	74.0	-8.5	1.71 H	36	46.6	18.9
8	#17355.00	53.5 AV	54.0	-0.5	1.71 H	36	34.6	18.9

ANTENNA POLARITY & TEST DISTANCE: VERTICAL AT 3 M

NO.	FREQ. (MHz)	EMISSION LEVEL (dBuV/m)	LIMIT (dBuV/m)	MARGIN (dB)	ANTENNA HEIGHT (m)	TABLE ANGLE (Degree)	RAW VALUE (dBuV)	CORRECTION FACTOR (dB/m)
1	#5627.44	56.7 PK	68.2	-11.5	1.50 V	351	52.0	4.7
2	*5785.00	113.8 PK			1.50 V	351	108.8	5.0
3	*5785.00	104.1 AV			1.50 V	351	99.1	5.0
4	#5930.06	55.1 PK	68.2	-13.1	1.50 V	351	49.7	5.4
5	11570.00	56.6 PK	74.0	-17.4	3.13 V	18	42.6	14.0
6	11570.00	44.3 AV	54.0	-9.7	3.13 V	18	30.3	14.0
7	#17355.00	63.8 PK	74.0	-10.2	1.72 V	32	44.9	18.9
8	#17355.00	51.3 AV	54.0	-2.7	1.72 V	32	32.4	18.9

REMARKS:

1. Emission Level(dBuV/m) = Raw Value(dBuV) + Correction Factor(dB/m)
2. Correction Factor(dB/m) = Antenna Factor(dB/m) + Cable Factor(dB) – Pre-Amplifier Factor(dB)
3. The other emission levels were very low against the limit.
4. Margin value = Emission Level – Limit value
5. " * ": Fundamental frequency.
6. " # ": The radiated frequency is out of the restricted band.

CHANNEL	TX Channel 165	DETECTOR FUNCTION	Peak (PK)
FREQUENCY RANGE	1GHz ~ 40GHz		Average (AV)

ANTENNA POLARITY & TEST DISTANCE: HORIZONTAL AT 3 M

NO.	FREQ. (MHz)	EMISSION LEVEL (dBuV/m)	LIMIT (dBuV/m)	MARGIN (dB)	ANTENNA HEIGHT (m)	TABLE ANGLE (Degree)	RAW VALUE (dBuV)	CORRECTION FACTOR (dB/m)
1	#5622.68	54.3 PK	68.2	-13.9	1.30 H	115	49.6	4.7
2	*5825.00	102.6 PK			1.30 H	115	97.4	5.2
3	*5825.00	93.0 AV			1.30 H	115	87.8	5.2
4	#5926.88	55.7 PK	68.2	-12.5	1.30 H	115	50.3	5.4
5	11650.00	64.9 PK	74.0	-9.1	1.81 H	56	50.8	14.1
6	11650.00	51.8 AV	54.0	-2.2	1.81 H	56	37.7	14.1
7	#17475.00	66.1 PK	74.0	-7.9	1.71 H	45	46.4	19.7
8	#17475.00	53.9 AV	54.0	-0.1	1.71 H	45	34.2	19.7

ANTENNA POLARITY & TEST DISTANCE: VERTICAL AT 3 M

NO.	FREQ. (MHz)	EMISSION LEVEL (dBuV/m)	LIMIT (dBuV/m)	MARGIN (dB)	ANTENNA HEIGHT (m)	TABLE ANGLE (Degree)	RAW VALUE (dBuV)	CORRECTION FACTOR (dB/m)
1	#5638.78	56.1 PK	68.2	-12.1	1.50 V	351	51.3	4.8
2	*5825.00	113.1 PK			1.50 V	351	107.9	5.2
3	*5825.00	103.8 AV			1.50 V	351	98.6	5.2
4	#5928.63	56.3 PK	68.2	-11.9	1.50 V	351	50.9	5.4
5	11650.00	56.5 PK	74.0	-17.5	3.11 V	32	42.4	14.1
6	11650.00	43.9 AV	54.0	-10.1	3.11 V	32	29.8	14.1
7	#17475.00	64.1 PK	74.0	-9.9	1.73 V	31	44.4	19.7
8	#17475.00	51.5 AV	54.0	-2.5	1.73 V	31	31.8	19.7

REMARKS:

1. Emission Level(dBuV/m) = Raw Value(dBuV) + Correction Factor(dB/m)
2. Correction Factor(dB/m) = Antenna Factor(dB/m) + Cable Factor(dB) – Pre-Amplifier Factor(dB)
3. The other emission levels were very low against the limit.
4. Margin value = Emission Level – Limit value
5. " * ": Fundamental frequency.
6. " # ": The radiated frequency is out of the restricted band.

802.11ac (VHT20)

CHANNEL	TX Channel 36	DETECTOR FUNCTION	Peak (PK)
FREQUENCY RANGE	1GHz ~ 40GHz		Average (AV)

ANTENNA POLARITY & TEST DISTANCE: HORIZONTAL AT 3 M								
NO.	FREQ. (MHz)	EMISSION LEVEL (dBuV/m)	LIMIT (dBuV/m)	MARGIN (dB)	ANTENNA HEIGHT (m)	TABLE ANGLE (Degree)	RAW VALUE (dBuV)	CORRECTION FACTOR (dB/m)
1	5150.00	56.5 PK	74.0	-17.5	1.87 H	254	52.5	4.0
2	5150.00	42.8 AV	54.0	-11.2	1.87 H	254	38.8	4.0
3	*5180.00	105.3 PK			1.87 H	254	101.3	4.0
4	*5180.00	96.1 AV			1.87 H	254	92.1	4.0
5	#10360.00	65.9 PK	74.0	-8.1	1.87 H	318	52.3	13.6
6	#10360.00	52.5 AV	54.0	-1.5	1.87 H	318	38.9	13.6
7	15540.00	61.3 PK	74.0	-12.7	1.76 H	29	48.1	13.2
8	15540.00	48.0 AV	54.0	-6.0	1.76 H	29	34.8	13.2

ANTENNA POLARITY & TEST DISTANCE: VERTICAL AT 3 M								
NO.	FREQ. (MHz)	EMISSION LEVEL (dBuV/m)	LIMIT (dBuV/m)	MARGIN (dB)	ANTENNA HEIGHT (m)	TABLE ANGLE (Degree)	RAW VALUE (dBuV)	CORRECTION FACTOR (dB/m)
1	5150.00	66.9 PK	74.0	-7.1	1.50 V	203	62.9	4.0
2	5150.00	53.9 AV	54.0	-0.1	1.50 V	203	49.9	4.0
3	*5180.00	117.3 PK			1.50 V	203	113.3	4.0
4	*5180.00	108.0 AV			1.50 V	203	104.0	4.0
5	#10360.00	59.2 PK	74.0	-14.8	3.05 V	27	45.6	13.6
6	#10360.00	45.6 AV	54.0	-8.4	3.05 V	27	32.0	13.6
7	15540.00	59.4 PK	74.0	-14.6	1.67 V	5	46.2	13.2
8	15540.00	44.3 AV	54.0	-9.7	1.67 V	5	31.1	13.2

REMARKS:

- Emission Level(dBuV/m) = Raw Value(dBuV) + Correction Factor(dB/m)
- Correction Factor(dB/m) = Antenna Factor(dB/m) + Cable Factor(dB) – Pre-Amplifier Factor(dB)
- The other emission levels were very low against the limit.
- Margin value = Emission Level – Limit value
- " * ": Fundamental frequency.
- " # ": The radiated frequency is out of the restricted band.

CHANNEL	TX Channel 40	DETECTOR FUNCTION	Peak (PK)
FREQUENCY RANGE	1GHz ~ 40GHz		Average (AV)

ANTENNA POLARITY & TEST DISTANCE: HORIZONTAL AT 3 M

NO.	FREQ. (MHz)	EMISSION LEVEL (dBuV/m)	LIMIT (dBuV/m)	MARGIN (dB)	ANTENNA HEIGHT (m)	TABLE ANGLE (Degree)	RAW VALUE (dBuV)	CORRECTION FACTOR (dB/m)
1	5150.00	55.4 PK	74.0	-18.6	1.86 H	255	51.4	4.0
2	5150.00	42.8 AV	54.0	-11.2	1.86 H	255	38.8	4.0
3	*5200.00	108.1 PK			1.86 H	255	104.1	4.0
4	*5200.00	98.9 AV			1.86 H	255	94.9	4.0
5	5350.00	53.0 PK	74.0	-21.0	1.86 H	255	48.6	4.4
6	5350.00	41.1 AV	54.0	-12.9	1.86 H	255	36.7	4.4
7	#10400.00	66.6 PK	74.0	-7.4	1.87 H	318	53.0	13.6
8	#10400.00	53.8 AV	54.0	-0.2	1.87 H	318	40.2	13.6
9	15600.00	66.5 PK	74.0	-7.5	1.71 H	29	53.1	13.4
10	15600.00	53.5 AV	54.0	-0.5	1.71 H	29	40.1	13.4

ANTENNA POLARITY & TEST DISTANCE: VERTICAL AT 3 M

NO.	FREQ. (MHz)	EMISSION LEVEL (dBuV/m)	LIMIT (dBuV/m)	MARGIN (dB)	ANTENNA HEIGHT (m)	TABLE ANGLE (Degree)	RAW VALUE (dBuV)	CORRECTION FACTOR (dB/m)
1	5150.00	65.9 PK	74.0	-8.1	1.50 V	221	61.9	4.0
2	5150.00	53.2 AV	54.0	-0.8	1.50 V	221	49.2	4.0
3	*5200.00	120.0 PK			1.50 V	221	116.0	4.0
4	*5200.00	110.8 AV			1.50 V	221	106.8	4.0
5	5350.00	62.9 PK	74.0	-11.1	1.50 V	221	58.5	4.4
6	5350.00	51.3 AV	54.0	-2.7	1.50 V	221	46.9	4.4
7	#10400.00	60.3 PK	74.0	-13.7	3.02 V	6	46.7	13.6
8	#10400.00	46.7 AV	54.0	-7.3	3.02 V	6	33.1	13.6
9	15600.00	62.2 PK	74.0	-11.8	1.63 V	21	48.8	13.4
10	15600.00	48.2 AV	54.0	-5.8	1.63 V	21	34.8	13.4

REMARKS:

- Emission Level(dBuV/m) = Raw Value(dBuV) + Correction Factor(dB/m)
- Correction Factor(dB/m) = Antenna Factor(dB/m) + Cable Factor(dB) – Pre-Amplifier Factor(dB)
- The other emission levels were very low against the limit.
- Margin value = Emission Level – Limit value
- " * ": Fundamental frequency.
- " # ": The radiated frequency is out of the restricted band.

CHANNEL	TX Channel 48	DETECTOR FUNCTION	Peak (PK)
FREQUENCY RANGE	1GHz ~ 40GHz		Average (AV)

ANTENNA POLARITY & TEST DISTANCE: HORIZONTAL AT 3 M

NO.	FREQ. (MHz)	EMISSION LEVEL (dBuV/m)	LIMIT (dBuV/m)	MARGIN (dB)	ANTENNA HEIGHT (m)	TABLE ANGLE (Degree)	RAW VALUE (dBuV)	CORRECTION FACTOR (dB/m)
1	*5240.00	108.7 PK			1.92 H	260	104.5	4.2
2	*5240.00	99.2 AV			1.92 H	260	95.0	4.2
3	5350.00	55.1 PK	74.0	-18.9	1.92 H	260	50.7	4.4
4	5350.00	42.5 AV	54.0	-11.5	1.92 H	260	38.1	4.4
5	#10480.00	67.1 PK	74.0	-6.9	1.90 H	318	53.4	13.7
6	#10480.00	53.9 AV	54.0	-0.1	1.90 H	318	40.2	13.7
7	15720.00	64.2 PK	74.0	-9.8	1.71 H	29	50.2	14.0
8	15720.00	51.0 AV	54.0	-3.0	1.71 H	29	37.0	14.0

ANTENNA POLARITY & TEST DISTANCE: VERTICAL AT 3 M

NO.	FREQ. (MHz)	EMISSION LEVEL (dBuV/m)	LIMIT (dBuV/m)	MARGIN (dB)	ANTENNA HEIGHT (m)	TABLE ANGLE (Degree)	RAW VALUE (dBuV)	CORRECTION FACTOR (dB/m)
1	*5240.00	120.7 PK			1.50 V	221	116.5	4.2
2	*5240.00	111.0 AV			1.50 V	221	106.8	4.2
3	5350.00	65.3 PK	74.0	-8.7	1.50 V	221	60.9	4.4
4	5350.00	53.1 AV	54.0	-0.9	1.50 V	221	48.7	4.4
5	#10480.00	61.4 PK	74.0	-12.6	3.03 V	19	47.7	13.7
6	#10480.00	47.5 AV	54.0	-6.5	3.03 V	19	33.8	13.7
7	15720.00	61.5 PK	74.0	-12.5	1.62 V	39	47.5	14.0
8	15720.00	47.1 AV	54.0	-6.9	1.62 V	39	33.1	14.0

REMARKS:

- Emission Level(dBuV/m) = Raw Value(dBuV) + Correction Factor(dB/m)
- Correction Factor(dB/m) = Antenna Factor(dB/m) + Cable Factor(dB) – Pre-Amplifier Factor(dB)
- The other emission levels were very low against the limit.
- Margin value = Emission Level – Limit value
- " * ": Fundamental frequency.
- " # ": The radiated frequency is out of the restricted band.

CHANNEL	TX Channel 149	DETECTOR FUNCTION	Peak (PK)
FREQUENCY RANGE	1GHz ~ 40GHz		Average (AV)

ANTENNA POLARITY & TEST DISTANCE: HORIZONTAL AT 3 M

NO.	FREQ. (MHz)	EMISSION LEVEL (dBuV/m)	LIMIT (dBuV/m)	MARGIN (dB)	ANTENNA HEIGHT (m)	TABLE ANGLE (Degree)	RAW VALUE (dBuV)	CORRECTION FACTOR (dB/m)
1	#5637.21	55.0 PK	68.2	-13.2	1.19 H	115	50.2	4.8
2	*5745.00	103.3 PK			1.19 H	115	98.3	5.0
3	*5745.00	93.1 AV			1.19 H	115	88.1	5.0
4	#5959.28	54.8 PK	68.2	-13.4	1.19 H	115	49.3	5.5
5	11490.00	60.8 PK	74.0	-13.2	1.81 H	55	46.7	14.1
6	11490.00	50.0 AV	54.0	-4.0	1.81 H	55	35.9	14.1
7	#17235.00	66.4 PK	74.0	-7.6	1.71 H	34	48.1	18.3
8	#17235.00	53.8 AV	54.0	-0.2	1.71 H	34	35.5	18.3

ANTENNA POLARITY & TEST DISTANCE: VERTICAL AT 3 M

NO.	FREQ. (MHz)	EMISSION LEVEL (dBuV/m)	LIMIT (dBuV/m)	MARGIN (dB)	ANTENNA HEIGHT (m)	TABLE ANGLE (Degree)	RAW VALUE (dBuV)	CORRECTION FACTOR (dB/m)
1	#5650.08	58.6 PK	68.3	-9.7	1.50 V	336	53.9	4.7
2	*5745.00	114.5 PK			1.50 V	336	109.5	5.0
3	*5745.00	104.6 AV			1.50 V	336	99.6	5.0
4	#5981.29	54.8 PK	68.2	-13.4	1.50 V	336	49.2	5.6
5	11490.00	56.2 PK	74.0	-17.8	3.05 V	13	42.1	14.1
6	11490.00	44.3 AV	54.0	-9.7	3.05 V	13	30.2	14.1
7	#17235.00	63.5 PK	74.0	-10.5	1.69 V	36	45.2	18.3
8	#17235.00	51.3 AV	54.0	-2.7	1.69 V	36	33.0	18.3

REMARKS:

1. Emission Level(dBuV/m) = Raw Value(dBuV) + Correction Factor(dB/m)
2. Correction Factor(dB/m) = Antenna Factor(dB/m) + Cable Factor(dB) – Pre-Amplifier Factor(dB)
3. The other emission levels were very low against the limit.
4. Margin value = Emission Level – Limit value
5. " * ": Fundamental frequency.
6. " # ": The radiated frequency is out of the restricted band.

CHANNEL	TX Channel 157	DETECTOR FUNCTION	Peak (PK)
FREQUENCY RANGE	1GHz ~ 40GHz		Average (AV)

ANTENNA POLARITY & TEST DISTANCE: HORIZONTAL AT 3 M

NO.	FREQ. (MHz)	EMISSION LEVEL (dBuV/m)	LIMIT (dBuV/m)	MARGIN (dB)	ANTENNA HEIGHT (m)	TABLE ANGLE (Degree)	RAW VALUE (dBuV)	CORRECTION FACTOR (dB/m)
1	#5635.38	55.5 PK	68.2	-12.7	1.20 H	119	50.7	4.8
2	*5785.00	103.2 PK			1.20 H	115	98.2	5.0
3	*5785.00	93.0 AV			1.20 H	115	88.0	5.0
4	#5975.11	55.1 PK	68.2	-13.1	1.20 H	119	49.6	5.5
5	11570.00	64.5 PK	74.0	-9.5	1.84 H	56	50.5	14.0
6	11570.00	51.9 AV	54.0	-2.1	1.84 H	56	37.9	14.0
7	#17355.00	66.7 PK	74.0	-7.3	1.71 H	44	47.8	18.9
8	#17355.00	53.9 AV	54.0	-0.1	1.71 H	44	35.0	18.9

ANTENNA POLARITY & TEST DISTANCE: VERTICAL AT 3 M

NO.	FREQ. (MHz)	EMISSION LEVEL (dBuV/m)	LIMIT (dBuV/m)	MARGIN (dB)	ANTENNA HEIGHT (m)	TABLE ANGLE (Degree)	RAW VALUE (dBuV)	CORRECTION FACTOR (dB/m)
1	#5648.27	58.3 PK	68.2	-9.9	1.50 V	337	53.5	4.8
2	*5785.00	114.2 PK			1.50 V	337	109.2	5.0
3	*5785.00	104.3 AV			1.50 V	337	99.3	5.0
4	#5953.36	56.0 PK	68.2	-12.2	1.50 V	337	50.6	5.4
5	11570.00	57.2 PK	74.0	-16.8	3.06 V	13	43.2	14.0
6	11570.00	44.9 AV	54.0	-9.1	3.06 V	13	30.9	14.0
7	#17355.00	64.1 PK	74.0	-9.9	1.73 V	57	45.2	18.9
8	#17355.00	51.6 AV	54.0	-2.4	1.73 V	57	32.7	18.9

REMARKS:

1. Emission Level(dBuV/m) = Raw Value(dBuV) + Correction Factor(dB/m)
2. Correction Factor(dB/m) = Antenna Factor(dB/m) + Cable Factor(dB) – Pre-Amplifier Factor(dB)
3. The other emission levels were very low against the limit.
4. Margin value = Emission Level – Limit value
5. " * ": Fundamental frequency.
6. " # ": The radiated frequency is out of the restricted band.

CHANNEL	TX Channel 165	DETECTOR FUNCTION	Peak (PK)
FREQUENCY RANGE	1GHz ~ 40GHz		Average (AV)

ANTENNA POLARITY & TEST DISTANCE: HORIZONTAL AT 3 M

NO.	FREQ. (MHz)	EMISSION LEVEL (dBuV/m)	LIMIT (dBuV/m)	MARGIN (dB)	ANTENNA HEIGHT (m)	TABLE ANGLE (Degree)	RAW VALUE (dBuV)	CORRECTION FACTOR (dB/m)
1	#5633.18	55.1 PK	68.2	-13.1	1.20 H	113	50.3	4.8
2	*5825.00	102.6 PK			1.20 H	113	97.4	5.2
3	*5825.00	92.2 AV			1.20 H	113	87.0	5.2
4	#6021.44	56.0 PK	68.2	-12.2	1.20 H	113	50.3	5.7
5	11650.00	64.8 PK	74.0	-9.2	1.81 H	56	50.7	14.1
6	11650.00	52.0 AV	54.0	-2.0	1.81 H	56	37.9	14.1
7	#17475.00	66.5 PK	74.0	-7.5	1.71 H	44	46.8	19.7
8	#17475.00	53.8 AV	54.0	-0.2	1.71 H	44	34.1	19.7

ANTENNA POLARITY & TEST DISTANCE: VERTICAL AT 3 M

NO.	FREQ. (MHz)	EMISSION LEVEL (dBuV/m)	LIMIT (dBuV/m)	MARGIN (dB)	ANTENNA HEIGHT (m)	TABLE ANGLE (Degree)	RAW VALUE (dBuV)	CORRECTION FACTOR (dB/m)
1	#5651.22	57.1 PK	69.1	-12.0	1.50 V	338	52.4	4.7
2	*5825.00	114.0 PK			1.50 V	338	108.8	5.2
3	*5825.00	103.9 AV			1.50 V	338	98.7	5.2
4	#5925.56	56.7 PK	68.2	-11.5	1.50 V	338	51.3	5.4
5	11650.00	57.3 PK	74.0	-16.7	3.07 V	5	43.2	14.1
6	11650.00	44.8 AV	54.0	-9.2	3.07 V	5	30.7	14.1
7	#17475.00	64.0 PK	74.0	-10.0	1.78 V	37	44.3	19.7
8	#17475.00	51.7 AV	54.0	-2.3	1.78 V	37	32.0	19.7

REMARKS:

1. Emission Level(dBuV/m) = Raw Value(dBuV) + Correction Factor(dB/m)
2. Correction Factor(dB/m) = Antenna Factor(dB/m) + Cable Factor(dB) – Pre-Amplifier Factor(dB)
3. The other emission levels were very low against the limit.
4. Margin value = Emission Level – Limit value
5. " * ": Fundamental frequency.
6. " # ": The radiated frequency is out of the restricted band.

802.11ac (VHT40)

CHANNEL	TX Channel 38	DETECTOR FUNCTION	Peak (PK)
FREQUENCY RANGE	1GHz ~ 40GHz		Average (AV)

ANTENNA POLARITY & TEST DISTANCE: HORIZONTAL AT 3 M

NO.	FREQ. (MHz)	EMISSION LEVEL (dBuV/m)	LIMIT (dBuV/m)	MARGIN (dB)	ANTENNA HEIGHT (m)	TABLE ANGLE (Degree)	RAW VALUE (dBuV)	CORRECTION FACTOR (dB/m)
1	5150.00	66.9 PK	74.0	-7.1	1.90 H	254	62.9	4.0
2	5150.00	43.2 AV	54.0	-10.8	1.90 H	254	39.2	4.0
3	*5190.00	100.4 PK			1.90 H	254	96.4	4.0
4	*5190.00	90.6 AV			1.90 H	254	86.6	4.0
5	5350.00	51.5 PK	74.0	-22.5	1.90 H	254	47.1	4.4
6	5350.00	39.2 AV	54.0	-14.8	1.90 H	254	34.8	4.4
7	#10380.00	60.7 PK	74.0	-13.3	1.84 H	305	47.1	13.6
8	#10380.00	47.5 AV	54.0	-6.5	1.84 H	305	33.9	13.6
9	15570.00	54.6 PK	74.0	-19.4	1.73 H	23	41.3	13.3
10	15570.00	42.1 AV	54.0	-11.9	1.73 H	23	28.8	13.3

ANTENNA POLARITY & TEST DISTANCE: VERTICAL AT 3 M

NO.	FREQ. (MHz)	EMISSION LEVEL (dBuV/m)	LIMIT (dBuV/m)	MARGIN (dB)	ANTENNA HEIGHT (m)	TABLE ANGLE (Degree)	RAW VALUE (dBuV)	CORRECTION FACTOR (dB/m)
1	5150.00	67.6 PK	74.0	-6.4	1.50 V	348	63.6	4.0
2	5150.00	53.9 AV	54.0	-0.1	1.50 V	348	49.9	4.0
3	*5190.00	112.3 PK			1.50 V	348	108.3	4.0
4	*5190.00	102.4 AV			1.50 V	348	98.4	4.0
5	5350.00	57.5 PK	74.0	-16.5	1.50 V	348	53.1	4.4
6	5350.00	46.6 AV	54.0	-7.4	1.50 V	348	42.2	4.4
7	#10380.00	55.1 PK	74.0	-18.9	3.02 V	3	41.5	13.6
8	#10380.00	41.2 AV	54.0	-12.8	3.02 V	3	27.6	13.6
9	15570.00	52.8 PK	74.0	-21.2	1.64 V	10	39.5	13.3
10	15570.00	40.5 AV	54.0	-13.5	1.64 V	10	27.2	13.3

REMARKS:

- Emission Level(dBuV/m) = Raw Value(dBuV) + Correction Factor(dB/m)
- Correction Factor(dB/m) = Antenna Factor(dB/m) + Cable Factor(dB) – Pre-Amplifier Factor(dB)
- The other emission levels were very low against the limit.
- Margin value = Emission Level – Limit value
- " * ": Fundamental frequency.
- " # ": The radiated frequency is out of the restricted band.

CHANNEL	TX Channel 46	DETECTOR FUNCTION	Peak (PK)
FREQUENCY RANGE	1GHz ~ 40GHz		Average (AV)

ANTENNA POLARITY & TEST DISTANCE: HORIZONTAL AT 3 M

NO.	FREQ. (MHz)	EMISSION LEVEL (dBuV/m)	LIMIT (dBuV/m)	MARGIN (dB)	ANTENNA HEIGHT (m)	TABLE ANGLE (Degree)	RAW VALUE (dBuV)	CORRECTION FACTOR (dB/m)
1	5150.00	57.9 PK	74.0	-16.1	1.94 H	260	53.9	4.0
2	5150.00	43.6 AV	54.0	-10.4	1.94 H	260	39.6	4.0
3	*5230.00	106.2 PK			1.94 H	260	102.0	4.2
4	*5230.00	96.7 AV			1.94 H	260	92.5	4.2
5	5350.00	55.0 PK	74.0	-19.0	1.94 H	260	50.6	4.4
6	5350.00	42.5 AV	54.0	-11.5	1.94 H	260	38.1	4.4
7	#10460.00	64.2 PK	74.0	-9.8	1.87 H	317	50.5	13.7
8	#10460.00	51.2 AV	54.0	-2.8	1.87 H	317	37.5	13.7
9	15690.00	59.0 PK	74.0	-15.0	1.71 H	29	45.0	14.0
10	15690.00	46.3 AV	54.0	-7.7	1.71 H	29	32.3	14.0

ANTENNA POLARITY & TEST DISTANCE: VERTICAL AT 3 M

NO.	FREQ. (MHz)	EMISSION LEVEL (dBuV/m)	LIMIT (dBuV/m)	MARGIN (dB)	ANTENNA HEIGHT (m)	TABLE ANGLE (Degree)	RAW VALUE (dBuV)	CORRECTION FACTOR (dB/m)
1	5150.00	67.8 PK	74.0	-6.2	1.50 V	211	63.8	4.0
2	5150.00	53.9 AV	54.0	-0.1	1.50 V	211	49.9	4.0
3	*5230.00	117.5 PK			1.50 V	211	113.3	4.2
4	*5230.00	108.4 AV			1.50 V	211	104.2	4.2
5	5350.00	64.7 PK	74.0	-9.3	1.50 V	211	60.3	4.4
6	5350.00	52.8 AV	54.0	-1.2	1.50 V	211	48.4	4.4
7	#10460.00	59.0 PK	74.0	-15.0	3.03 V	9	45.3	13.7
8	#10460.00	45.2 AV	54.0	-8.8	3.03 V	9	31.5	13.7
9	15690.00	57.0 PK	74.0	-17.0	1.63 V	15	43.0	14.0
10	15690.00	44.6 AV	54.0	-9.4	1.63 V	15	30.6	14.0

REMARKS:

- Emission Level(dBuV/m) = Raw Value(dBuV) + Correction Factor(dB/m)
- Correction Factor(dB/m) = Antenna Factor(dB/m) + Cable Factor(dB) – Pre-Amplifier Factor(dB)
- The other emission levels were very low against the limit.
- Margin value = Emission Level – Limit value
- " * ": Fundamental frequency.
- " # ": The radiated frequency is out of the restricted band.

CHANNEL	TX Channel 151	DETECTOR FUNCTION	Peak (PK)
FREQUENCY RANGE	1GHz ~ 40GHz		Average (AV)

ANTENNA POLARITY & TEST DISTANCE: HORIZONTAL AT 3 M

NO.	FREQ. (MHz)	EMISSION LEVEL (dBuV/m)	LIMIT (dBuV/m)	MARGIN (dB)	ANTENNA HEIGHT (m)	TABLE ANGLE (Degree)	RAW VALUE (dBuV)	CORRECTION FACTOR (dB/m)
1	#5596.32	56.9 PK	68.2	-11.3	1.20 H	110	52.3	4.6
2	*5755.00	102.9 PK			1.20 H	110	97.9	5.0
3	*5755.00	93.0 AV			1.20 H	110	88.0	5.0
4	#5927.95	56.1 PK	68.2	-12.1	1.20 H	110	50.7	5.4
5	11510.00	66.7 PK	74.0	-7.3	1.83 H	57	52.7	14.0
6	11510.00	52.7 AV	54.0	-1.3	1.83 H	57	38.7	14.0
7	#17265.00	68.2 PK	74.0	-5.8	1.71 H	42	49.7	18.5
8	#17265.00	53.6 AV	54.0	-0.4	1.71 H	42	35.1	18.5

ANTENNA POLARITY & TEST DISTANCE: VERTICAL AT 3 M

NO.	FREQ. (MHz)	EMISSION LEVEL (dBuV/m)	LIMIT (dBuV/m)	MARGIN (dB)	ANTENNA HEIGHT (m)	TABLE ANGLE (Degree)	RAW VALUE (dBuV)	CORRECTION FACTOR (dB/m)
1	#5649.68	60.5 PK	68.2	-7.7	1.50 V	351	55.7	4.8
2	*5755.00	114.3 PK			1.50 V	351	109.3	5.0
3	*5755.00	104.2 AV			1.50 V	351	99.2	5.0
4	#5939.76	56.7 PK	68.2	-11.5	1.50 V	351	51.3	5.4
5	11510.00	57.1 PK	74.0	-16.9	3.10 V	18	43.1	14.0
6	11510.00	44.8 AV	54.0	-9.2	3.10 V	18	30.8	14.0
7	#17265.00	64.0 PK	74.0	-10.0	1.68 V	68	45.5	18.5
8	#17265.00	51.5 AV	54.0	-2.5	1.68 V	68	33.0	18.5

REMARKS:

1. Emission Level(dBuV/m) = Raw Value(dBuV) + Correction Factor(dB/m)
2. Correction Factor(dB/m) = Antenna Factor(dB/m) + Cable Factor(dB) – Pre-Amplifier Factor(dB)
3. The other emission levels were very low against the limit.
4. Margin value = Emission Level – Limit value
5. " * ": Fundamental frequency.
6. " # ": The radiated frequency is out of the restricted band.

CHANNEL	TX Channel 159	DETECTOR FUNCTION	Peak (PK)
FREQUENCY RANGE	1GHz ~ 40GHz		Average (AV)

ANTENNA POLARITY & TEST DISTANCE: HORIZONTAL AT 3 M

NO.	FREQ. (MHz)	EMISSION LEVEL (dBuV/m)	LIMIT (dBuV/m)	MARGIN (dB)	ANTENNA HEIGHT (m)	TABLE ANGLE (Degree)	RAW VALUE (dBuV)	CORRECTION FACTOR (dB/m)
1	#5595.51	55.5 PK	68.2	-12.7	1.20 H	114	50.9	4.6
2	*5795.00	103.2 PK			1.20 H	114	98.1	5.1
3	*5795.00	93.2 AV			1.20 H	114	88.1	5.1
4	#5982.07	55.3 PK	68.2	-12.9	1.20 H	114	49.7	5.6
5	11590.00	68.4 PK	74.0	-5.6	1.83 H	58	54.4	14.0
6	11590.00	53.8 AV	54.0	-0.2	1.83 H	58	39.8	14.0
7	#17385.00	66.8 PK	74.0	-7.2	1.71 H	44	47.7	19.1
8	#17385.00	52.7 AV	54.0	-1.3	1.71 H	44	33.6	19.1

ANTENNA POLARITY & TEST DISTANCE: VERTICAL AT 3 M

NO.	FREQ. (MHz)	EMISSION LEVEL (dBuV/m)	LIMIT (dBuV/m)	MARGIN (dB)	ANTENNA HEIGHT (m)	TABLE ANGLE (Degree)	RAW VALUE (dBuV)	CORRECTION FACTOR (dB/m)
1	#5621.27	59.5 PK	68.2	-8.7	1.50 V	351	54.8	4.7
2	*5795.00	113.9 PK			1.50 V	352	108.8	5.1
3	*5795.00	103.9 AV			1.50 V	352	98.8	5.1
4	#5938.68	57.4 PK	68.2	-10.8	1.50 V	351	52.0	5.4
5	11590.00	57.8 PK	74.0	-16.2	3.07 V	4	43.8	14.0
6	11590.00	45.4 AV	54.0	-8.6	3.07 V	4	31.4	14.0
7	#17385.00	64.5 PK	74.0	-9.5	1.69 V	58	45.4	19.1
8	#17385.00	52.0 AV	54.0	-2.0	1.69 V	58	32.9	19.1

REMARKS:

1. Emission Level(dBuV/m) = Raw Value(dBuV) + Correction Factor(dB/m)
2. Correction Factor(dB/m) = Antenna Factor(dB/m) + Cable Factor(dB) – Pre-Amplifier Factor(dB)
3. The other emission levels were very low against the limit.
4. Margin value = Emission Level – Limit value
5. " * ": Fundamental frequency.
6. " # ": The radiated frequency is out of the restricted band.

802.11ac (VHT80)

CHANNEL	TX Channel 42	DETECTOR FUNCTION	Peak (PK)
FREQUENCY RANGE	1GHz ~ 40GHz		Average (AV)

ANTENNA POLARITY & TEST DISTANCE: HORIZONTAL AT 3 M

NO.	FREQ. (MHz)	EMISSION LEVEL (dBuV/m)	LIMIT (dBuV/m)	MARGIN (dB)	ANTENNA HEIGHT (m)	TABLE ANGLE (Degree)	RAW VALUE (dBuV)	CORRECTION FACTOR (dB/m)
1	5150.00	55.1 PK	74.0	-18.9	1.92 H	268	51.1	4.0
2	5150.00	43.5 AV	54.0	-10.5	1.92 H	268	39.5	4.0
3	*5210.00	96.5 PK			1.92 H	268	92.4	4.1
4	*5210.00	87.1 AV			1.92 H	268	83.0	4.1
5	5350.00	51.7 PK	74.0	-22.3	1.92 H	268	47.3	4.4
6	5350.00	39.3 AV	54.0	-14.7	1.92 H	268	34.9	4.4
7	#10420.00	57.9 PK	74.0	-16.1	1.86 H	317	44.3	13.6
8	#10420.00	45.5 AV	54.0	-8.5	1.86 H	317	31.9	13.6
9	15630.00	51.8 PK	74.0	-22.2	1.74 H	11	38.2	13.6
10	15630.00	38.2 AV	54.0	-15.8	1.74 H	11	24.6	13.6

ANTENNA POLARITY & TEST DISTANCE: VERTICAL AT 3 M

NO.	FREQ. (MHz)	EMISSION LEVEL (dBuV/m)	LIMIT (dBuV/m)	MARGIN (dB)	ANTENNA HEIGHT (m)	TABLE ANGLE (Degree)	RAW VALUE (dBuV)	CORRECTION FACTOR (dB/m)
1	5150.00	64.6 PK	74.0	-9.4	1.50 V	331	60.6	4.0
2	5150.00	53.9 AV	54.0	-0.1	1.50 V	331	49.9	4.0
3	*5210.00	107.6 PK			1.50 V	331	103.5	4.1
4	*5210.00	98.2 AV			1.50 V	331	94.1	4.1
5	5350.00	58.6 PK	74.0	-15.4	1.50 V	331	54.2	4.4
6	5350.00	46.3 AV	54.0	-7.7	1.50 V	331	41.9	4.4
7	#10420.00	52.2 PK	74.0	-21.8	3.02 V	0	38.6	13.6
8	#10420.00	38.5 AV	54.0	-15.5	3.02 V	0	24.9	13.6
9	15630.00	51.2 PK	74.0	-22.8	1.61 V	25	37.6	13.6
10	15630.00	37.9 AV	54.0	-16.1	1.61 V	25	24.3	13.6

REMARKS:

- Emission Level(dBuV/m) = Raw Value(dBuV) + Correction Factor(dB/m)
- Correction Factor(dB/m) = Antenna Factor(dB/m) + Cable Factor(dB) – Pre-Amplifier Factor(dB)
- The other emission levels were very low against the limit.
- Margin value = Emission Level – Limit value
- " * ": Fundamental frequency.
- " # ": The radiated frequency is out of the restricted band.

CHANNEL	TX Channel 155	DETECTOR FUNCTION	Peak (PK)
FREQUENCY RANGE	1GHz ~ 40GHz		Average (AV)

ANTENNA POLARITY & TEST DISTANCE: HORIZONTAL AT 3 M

NO.	FREQ. (MHz)	EMISSION LEVEL (dBuV/m)	LIMIT (dBuV/m)	MARGIN (dB)	ANTENNA HEIGHT (m)	TABLE ANGLE (Degree)	RAW VALUE (dBuV)	CORRECTION FACTOR (dB/m)
1	#5622.08	56.7 PK	68.2	-11.5	1.20 H	119	52.0	4.7
2	*5775.00	101.2 PK			1.20 H	119	96.2	5.0
3	*5775.00	91.5 AV			1.20 H	119	86.5	5.0
4	#5936.80	55.4 PK	68.2	-12.8	1.20 H	119	50.0	5.4
5	11550.00	65.4 PK	74.0	-8.6	1.83 H	56	51.4	14.0
6	11550.00	51.6 AV	54.0	-2.4	1.83 H	56	37.6	14.0
7	#17325.00	64.7 PK	74.0	-9.3	1.71 H	35	46.1	18.6
8	#17325.00	53.7 AV	54.0	-0.3	1.71 H	35	35.1	18.6

ANTENNA POLARITY & TEST DISTANCE: VERTICAL AT 3 M

NO.	FREQ. (MHz)	EMISSION LEVEL (dBuV/m)	LIMIT (dBuV/m)	MARGIN (dB)	ANTENNA HEIGHT (m)	TABLE ANGLE (Degree)	RAW VALUE (dBuV)	CORRECTION FACTOR (dB/m)
1	#5648.87	60.5 PK	68.2	-7.7	1.50 V	344	55.7	4.8
2	*5775.00	111.0 PK			1.50 V	344	106.0	5.0
3	*5775.00	101.8 AV			1.50 V	344	96.8	5.0
4	#5926.20	57.4 PK	68.2	-10.8	1.50 V	344	52.0	5.4
5	11550.00	57.7 PK	74.0	-16.3	3.08 V	9	43.7	14.0
6	11550.00	45.2 AV	54.0	-8.8	3.08 V	9	31.2	14.0
7	#17325.00	64.9 PK	74.0	-9.1	1.71 V	42	46.3	18.6
8	#17325.00	52.4 AV	54.0	-1.6	1.71 V	42	33.8	18.6

REMARKS:

1. Emission Level(dBuV/m) = Raw Value(dBuV) + Correction Factor(dB/m)
2. Correction Factor(dB/m) = Antenna Factor(dB/m) + Cable Factor(dB) – Pre-Amplifier Factor(dB)
3. The other emission levels were very low against the limit.
4. Margin value = Emission Level – Limit value
5. " * ": Fundamental frequency.
6. " # ": The radiated frequency is out of the restricted band.

Below 1GHz Data:

802.11ac (VHT20)

CHANNEL	TX Channel 40	DETECTOR FUNCTION	Quasi-Peak (QP)
FREQUENCY RANGE	9kHz ~ 1GHz		

ANTENNA POLARITY & TEST DISTANCE: HORIZONTAL AT 3 M								
NO.	FREQ. (MHz)	EMISSION LEVEL (dBuV/m)	LIMIT (dBuV/m)	MARGIN (dB)	ANTENNA HEIGHT (m)	TABLE ANGLE (Degree)	RAW VALUE (dBuV)	CORRECTION FACTOR (dB/m)
1	37.61	36.6 QP	40.0	-3.4	1.00 H	241	44.9	-8.3
2	143.56	32.1 QP	43.5	-11.4	2.00 H	92	40.1	-8.0
3	188.55	32.7 QP	43.5	-10.8	2.00 H	360	43.2	-10.5
4	250.00	39.4 QP	46.0	-6.6	1.00 H	244	48.7	-9.3
5	454.64	33.1 QP	46.0	-12.9	2.00 H	193	36.3	-3.2
6	500.01	35.7 QP	46.0	-10.3	1.50 H	334	38.3	-2.6

ANTENNA POLARITY & TEST DISTANCE: VERTICAL AT 3 M								
NO.	FREQ. (MHz)	EMISSION LEVEL (dBuV/m)	LIMIT (dBuV/m)	MARGIN (dB)	ANTENNA HEIGHT (m)	TABLE ANGLE (Degree)	RAW VALUE (dBuV)	CORRECTION FACTOR (dB/m)
1	88.20	35.2 QP	43.5	-8.3	1.50 V	181	49.2	-14.0
2	250.00	35.5 QP	46.0	-10.5	2.00 V	229	44.8	-9.3
3	461.46	32.8 QP	46.0	-13.2	1.00 V	104	35.9	-3.1
4	500.01	35.6 QP	46.0	-10.4	1.00 V	299	38.2	-2.6
5	818.83	35.6 QP	46.0	-10.4	1.00 V	125	32.7	2.9
6	1000.00	37.1 QP	54.0	-16.9	1.00 V	233	31.8	5.3

REMARKS:

1. Emission Level(dBuV/m) = Raw Value(dBuV) + Correction Factor(dB/m)
2. Correction Factor(dB/m) = Antenna Factor(dB/m) + Cable Factor(dB) – Pre-Amplifier Factor(dB)
3. The other emission levels were very low against the limit.
4. Margin value = Emission Level – Limit value

4.2 Conducted Emission Measurement

4.2.1 Limits of Conducted Emission Measurement

Frequency (MHz)	Conducted Limit (dBuV)	
	Quasi-peak	Average
0.15 - 0.5	66 - 56	56 - 46
0.50 - 5.0	56	46
5.0 - 30.0	60	50

Note: 1. The lower limit shall apply at the transition frequencies.

2. The limit decreases in line with the logarithm of the frequency in the range of 0.15 to 0.50MHz.

4.2.2 Test Instruments

DESCRIPTION & MANUFACTURER	MODEL NO.	SERIAL NO.	CALIBRATED DATE	CALIBRATED UNTIL
Test Receiver R&S	ESCS 30	847124/029	Nov. 01, 2017	Oct. 31, 2018
Line-Impedance Stabilization Network (for EUT) R&S	ESH3-Z5	848773/004	Nov. 15, 20167	Nov. 14, 2018
Line-Impedance Stabilization Network (for Peripheral) R&S	ENV216	100072	June 03, 2017	June 02, 2018
50 ohms Terminator	N/A	EMC-02	Sep. 22, 2017	Sep. 21, 2018
RF Cable	5D-FB	COCCAB-001	Sep. 29, 2017	Sep. 28, 2018
10 dB PAD Mini-Circuits	HAT-10+	CONATT-004	June 18, 2017	June 17, 2018
Software BVADT	BVADT_Cond_ V7.3.7.4	NA	NA	NA

Note:

1. The calibration interval of the above test instruments are 12 months and the calibrations are traceable to NML/ROC and NIST/USA.
2. The test was performed in Shielded Room No. 1.
3. Tested Date: Nov. 29, 2017

4.2.3 Test Procedure

- The EUT was placed 0.4 meters from the conducting wall of the shielded room with EUT being connected to the power mains through a line impedance stabilization network (LISN). Other support units were connected to the power mains through another LISN. The two LISNs provide 50 ohm/ 50uH of coupling impedance for the measuring instrument.
- Both lines of the power mains connected to the EUT were checked for maximum conducted interference.
- The frequency range from 150kHz to 30MHz was searched. Emission levels under (Limit - 20dB) was not recorded.

NOTE: All modes of operation were investigated and the worst-case emissions are reported.

4.2.4 Deviation from Test Standard

No deviation.

4.2.5 Test Setup

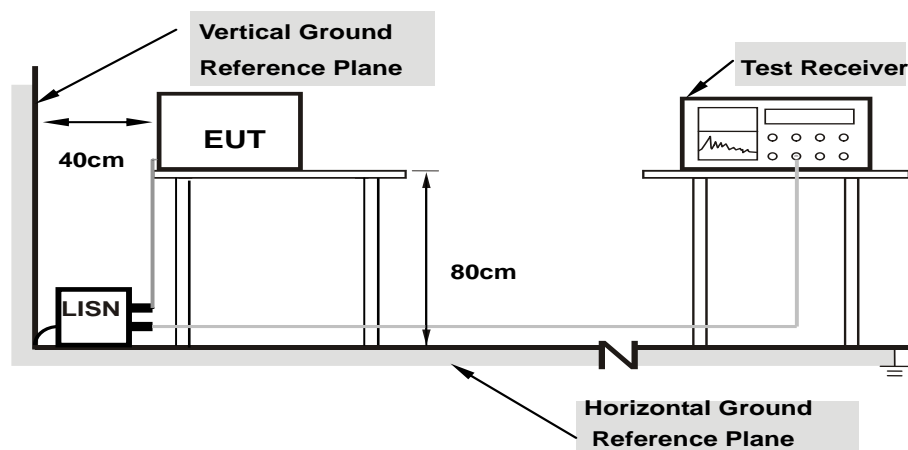

Note: 1.Support units were connected to second LISN.

For the actual test configuration, please refer to the attached file (Test Setup Photo).

4.2.6 EUT Operating Condition

Same as 4.1.6.

4.2.7 Test Results

Phase	Line (L)	Detector Function	Quasi-Peak (QP) / Average (AV)
-------	----------	-------------------	--------------------------------

No	Freq. [MHz]	Corr.	Reading Value		Emission Level		Limit		Margin	
		Factor (dB)	[dB (uV)]		[dB (uV)]		[dB (uV)]		(dB)	
		Q.P.	AV.	Q.P.	AV.	Q.P.	AV.	Q.P.	AV.	
1	0.15000	10.09	38.88	22.55	48.97	32.64	66.00	56.00	-17.03	-23.36
2	0.16953	10.08	34.58	16.49	44.66	26.57	64.98	54.98	-20.32	-28.41
3	0.34922	10.11	25.54	19.65	35.65	29.76	58.98	48.98	-23.33	-19.22
4	6.36328	10.53	22.15	16.24	32.68	26.77	60.00	50.00	-27.32	-23.23
5	10.23828	10.81	22.10	17.32	32.91	28.13	60.00	50.00	-27.09	-21.87
6	18.00000	11.43	15.12	9.66	26.55	21.09	60.00	50.00	-33.45	-28.91

REMARKS:

1. Q.P. and AV. are abbreviations of quasi-peak and average individually.
2. The emission levels of other frequencies were very low against the limit.
3. Margin value = Emission level - Limit value
4. Correction factor = Insertion loss + Cable loss
5. Emission Level = Correction Factor + Reading Value.

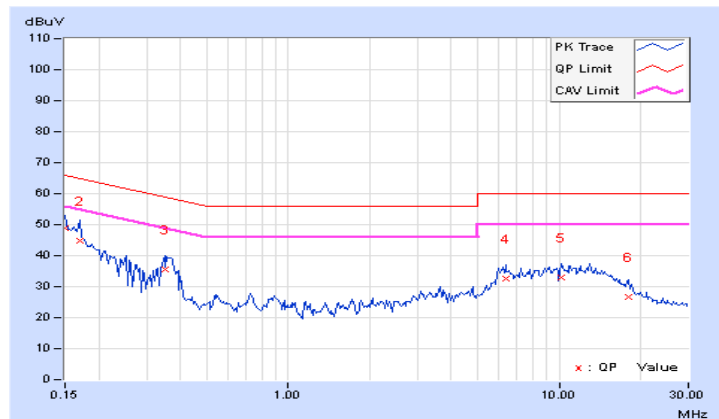

Phase	Neutral (N)	Detector Function	Quasi-Peak (QP) / Average (AV)
-------	-------------	-------------------	--------------------------------

No	Freq. [MHz]	Corr.	Reading Value		Emission Level		Limit		Margin	
		Factor	[dB (uV)]		[dB (uV)]		[dB (uV)]		(dB)	
	(dB)	Q.P.	AV.	Q.P.	AV.	Q.P.	AV.	Q.P.	AV.	
1	0.15391	10.07	37.43	24.20	47.50	34.27	65.79	55.79	-18.29	-21.52
2	0.17734	10.06	32.42	19.25	42.48	29.31	64.61	54.61	-22.13	-25.30
3	0.36094	10.10	27.32	22.81	37.42	32.91	58.71	48.71	-21.29	-15.80
4	1.61328	10.18	15.16	10.95	25.34	21.13	56.00	46.00	-30.66	-24.87
5	6.41016	10.44	21.13	16.07	31.57	26.51	60.00	50.00	-28.43	-23.49
6	11.25391	10.79	21.66	16.15	32.45	26.94	60.00	50.00	-27.55	-23.06

REMARKS:

1. Q.P. and AV. are abbreviations of quasi-peak and average individually.
2. The emission levels of other frequencies were very low against the limit.
3. Margin value = Emission level - Limit value
4. Correction factor = Insertion loss + Cable loss
5. Emission Level = Correction Factor + Reading Value.

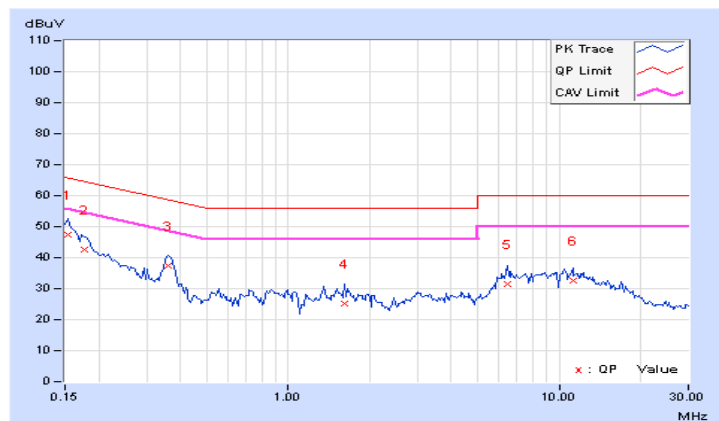

4.3 Transmit Power Measurement

4.3.1 Limits of Transmit Power Measurement

Operation Band	EUT Category		Limit
U-NII-1		Outdoor Access Point	1 Watt (30 dBm) (Max. e.i.r.p \leq 125mW(21 dBm) at any elevation angle above 30 degrees as measured from the horizon)
		Fixed point-to-point Access Point	1 Watt (30 dBm)
	√	Indoor Access Point	1 Watt (30 dBm)
		Mobile and Portable client device	250mW (24 dBm)
U-NII-2A			250mW (24 dBm) or 11 dBm+10 log B*
U-NII-2C			250mW (24 dBm) or 11 dBm+10 log B*
U-NII-3		√	1 Watt (30 dBm)

*B is the 26 dB emission bandwidth in megahertz

Per KDB 662911 Method of conducted output power measurement on IEEE 802.11 devices,

Array Gain = 0 dB (i.e., no array gain) for $N_{ANT} \leq 4$;

Array Gain = 0 dB (i.e., no array gain) for channel widths ≥ 40 MHz for any N_{ANT} ;

Array Gain = $5 \log(N_{ANT}/N_{SS})$ dB or 3 dB, whichever is less for 20-MHz channel widths with $N_{ANT} \geq 5$.

For power measurements on all other devices: Array Gain = $10 \log(N_{ANT}/N_{SS})$ dB.

4.3.2 Test Setup

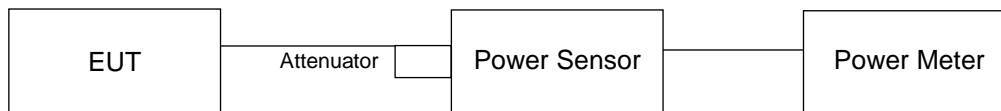

4.3.3 Test Instruments

Refer to section 4.1.2 to get information of above instrument.

4.3.4 Test Procedure

Method PM is used to perform output power measurement, trigger and gating function of wide band power meter is enabled to measure max output power of TX on burst. Duty factor is not added to measured value.

4.3.5 Deviation from Test Standard

No deviation.

4.3.6 EUT Operating Condition

The software provided by client to enable the EUT under transmission condition continuously at lowest, middle and highest channel frequencies individually.

4.3.7 Test Result

CDD Mode

802.11a

Chan.	Chan. Freq. (MHz)	Average Power (dBm)		Total Power (mW)	Total Power (dBm)	Limit (dBm)	Pass / Fail
		Chain 0	Chain 1				
36	5180	22.42	22.52	353.231	25.48	30	Pass
40	5200	23.85	23.98	492.696	26.93	30	Pass
48	5240	23.36	23.23	427.148	26.31	30	Pass
149	5745	15.73	15.65	74.139	18.70	30	Pass
157	5785	16.01	15.96	79.348	19.00	30	Pass
165	5825	16.13	16.18	82.515	19.17	30	Pass

802.11ac (VHT20)

Chan.	Chan. Freq. (MHz)	Average Power (dBm)		Total Power (mW)	Total Power (dBm)	Limit (dBm)	Pass / Fail
		Chain 0	Chain 1				
36	5180	22.10	22.17	326.997	25.15	30	Pass
40	5200	24.84	25.02	622.476	27.94	30	Pass
48	5240	24.85	24.69	599.934	27.78	30	Pass
149	5745	16.92	16.94	98.635	19.94	30	Pass
157	5785	17.42	17.37	109.784	20.41	30	Pass
165	5825	16.96	17.03	100.125	20.01	30	Pass

802.11ac (VHT40)

Chan.	Chan. Freq. (MHz)	Average Power (dBm)		Total Power (mW)	Total Power (dBm)	Limit (dBm)	Pass / Fail
		Chain 0	Chain 1				
38	5190	18.19	18.17	131.532	21.19	30	Pass
46	5230	24.51	24.27	549.789	27.40	30	Pass
151	5755	19.72	19.60	184.957	22.67	30	Pass
159	5795	20.80	20.52	232.946	23.67	30	Pass

802.11ac (VHT80)

Chan.	Chan. Freq. (MHz)	Average Power (dBm)		Total Power (mW)	Total Power (dBm)	Limit (dBm)	Pass / Fail
		Chain 0	Chain 1				
42	5210	16.64	16.93	95.449	19.80	30	Pass
155	5775	20.22	20.02	205.658	23.13	30	Pass

Beamforming Mode

802.11ac (VHT20)

Chan.	Chan. Freq. (MHz)	Average Power (dBm)		Total Power (mW)	Total Power (dBm)	Limit (dBm)	Pass / Fail
		Chain 0	Chain 1				
36	5180	22.10	22.17	326.997	25.15	27.99	Pass
40	5200	24.84	25.02	622.476	27.94	27.99	Pass
48	5240	24.85	24.69	599.934	27.78	27.99	Pass
149	5745	16.92	16.94	98.635	19.94	27.99	Pass
157	5785	17.42	17.37	109.784	20.41	27.99	Pass
165	5825	16.96	17.03	100.125	20.01	27.99	Pass

Note: Directional gain = $5\text{dBi} + 10\log(2) = 8.01\text{dBi} > 6\text{dBi}$, so the power limit shall be reduced to $30 - (8.01 - 6) = 27.99\text{dBm}$.

802.11ac (VHT40)

Chan.	Chan. Freq. (MHz)	Average Power (dBm)		Total Power (mW)	Total Power (dBm)	Limit (dBm)	Pass / Fail
		Chain 0	Chain 1				
38	5190	18.19	18.17	131.532	21.19	27.99	Pass
46	5230	24.51	24.27	549.789	27.40	27.99	Pass
151	5755	19.72	19.60	184.957	22.67	27.99	Pass
159	5795	20.80	20.52	232.946	23.67	27.99	Pass

Note: Directional gain = $5\text{dBi} + 10\log(2) = 8.01\text{dBi} > 6\text{dBi}$, so the power limit shall be reduced to $30 - (8.01 - 6) = 27.99\text{dBm}$.

802.11ac (VHT80)

Chan.	Chan. Freq. (MHz)	Average Power (dBm)		Total Power (mW)	Total Power (dBm)	Limit (dBm)	Pass / Fail
		Chain 0	Chain 1				
42	5210	16.64	16.93	95.449	19.80	27.99	Pass
155	5775	20.22	20.02	205.658	23.13	27.99	Pass

Note: Directional gain = $5\text{dBi} + 10\log(2) = 8.01\text{dBi} > 6\text{dBi}$, so the power limit shall be reduced to $30 - (8.01 - 6) = 27.99\text{dBm}$.

4.4 Occupied Bandwidth Measurement

4.4.1 Test Setup

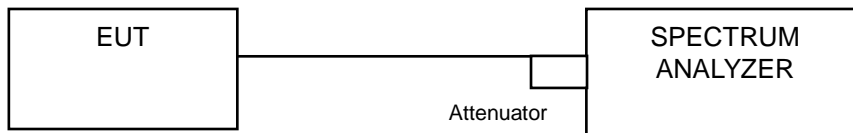

4.4.2 Test Instruments

Refer to section 4.1.2 to get information of above instrument.

4.4.3 Test Procedure

The transmitter output was connected to the spectrum analyzer through an attenuator. The bandwidth of the fundamental frequency was measured by spectrum analyzer with resolution bandwidth in the range of 1% to 5% of the anticipated emission bandwidth, and a video bandwidth at least 3x the resolution bandwidth and set the detector to SAMPLE. The width of a frequency band such that, below the lower and above the upper frequency limits, the mean powers emitted are each equal to a specified percentage 0.5 %of the total mean power of a given emission.

4.4.4 Test Results

CDD Mode

802.11a

Channel	Channel Frequency (MHz)	Occupied Bandwidth (MHz)	
		Chain 0	Chain 1
36	5180	16.68	16.68
40	5200	17.16	16.92
48	5240	16.80	16.80
149	5745	16.44	16.44
157	5785	16.44	16.56
165	5825	16.56	16.44

802.11ac (VHT20)

Channel	Channel Frequency (MHz)	Occupied Bandwidth (MHz)	
		Chain 0	Chain 1
36	5180	17.76	17.76
40	5200	18.36	19.44
48	5240	18.24	18.84
149	5745	17.52	17.64
157	5785	17.64	17.64
165	5825	17.64	17.64

802.11ac (VHT40)

Channel	Channel Frequency (MHz)	Occupied Bandwidth (MHz)	
		Chain 0	Chain 1
38	5190	36.24	36.24
46	5230	37.20	36.96
151	5755	36.24	36.24
159	5795	36.48	36.24

802.11ac (VHT80)

Channel	Channel Frequency (MHz)	Occupied Bandwidth (MHz)	
		Chain 0	Chain 1
42	5210	74.88	74.40
155	5775	75.36	75.36

Spectrum Plot of Worst Value

802.11a_Chain0 / CH 40

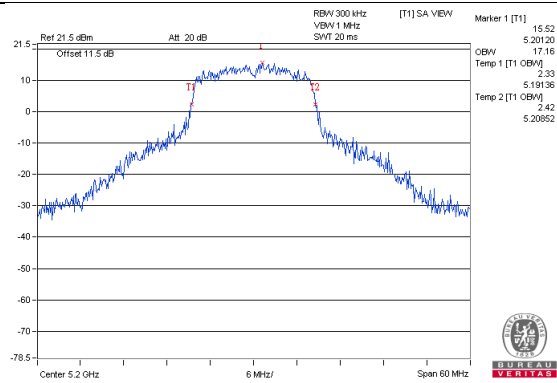

802.11ac (VHT20)_Chain1 / CH 40

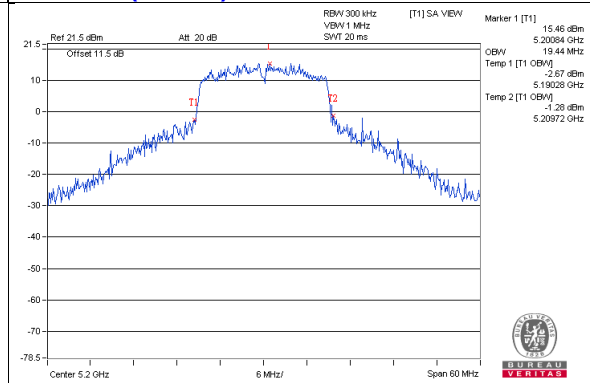

802.11ac (VHT40)_Chain0 / CH 46

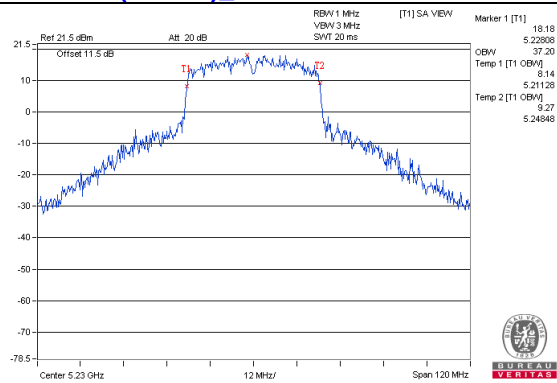

802.11ac (VHT80)_Chain1 / CH 155

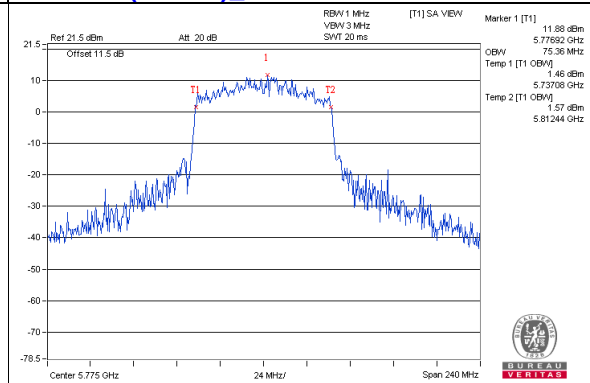

Spectrum Plot for near by DFS band (DFS is required, if 99% OCP straddle into U-NII-2A band)

802.11a_Chain0 / CH48

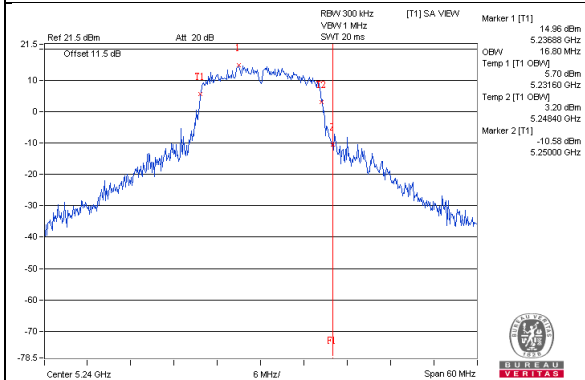

802.11a_Chain1 / CH48

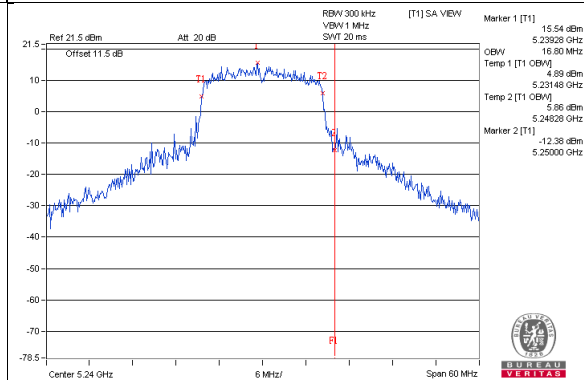

802.11ac(VHT20)_Chain0 / CH48

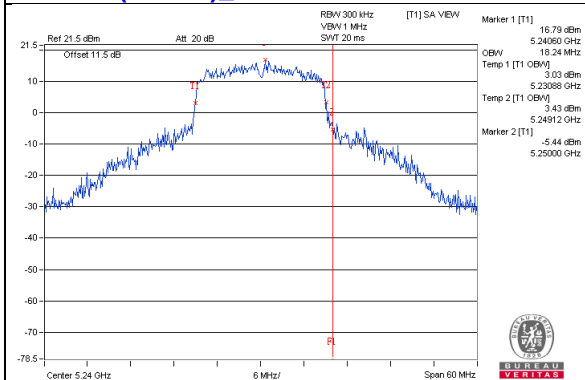

802.11ac(VHT20)_Chain1 / CH48

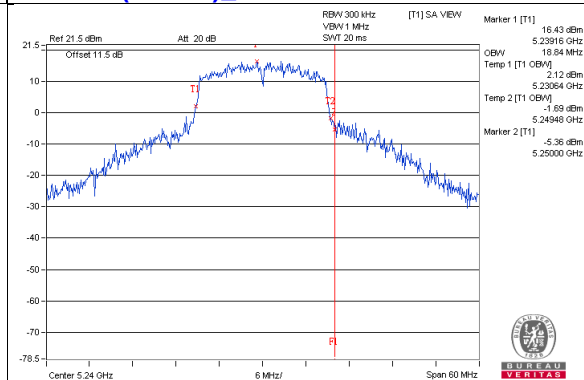

802.11ac(VHT40)_Chain0 / CH46

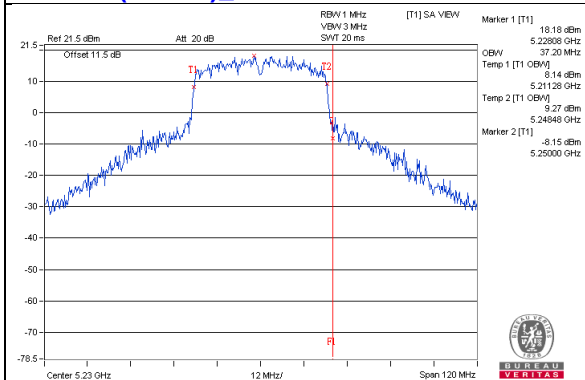

802.11ac(VHT40)_Chain1 / CH46

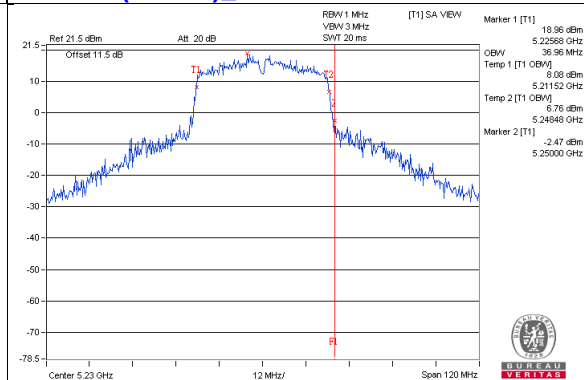

802.11ac(VHT80)_Chain0 / CH42

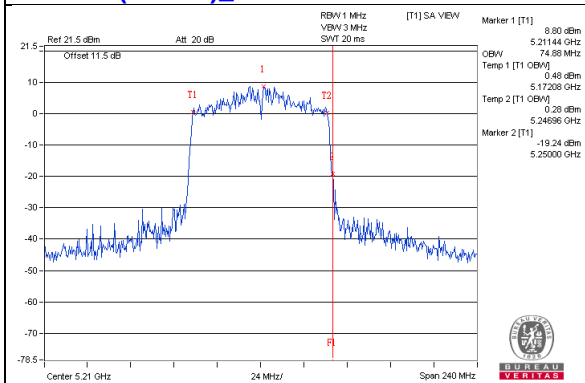

802.11ac(VHT80)_Chain1 / CH42

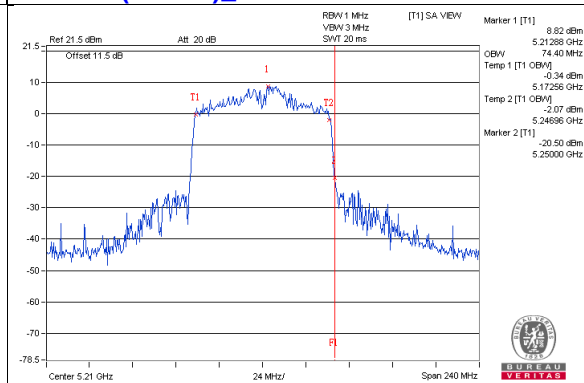

Spectrum Plot for near by DFS band (DFS is required, if 99% OCP straddle into U-NII-2C band)

802.11a_Chain0 / CH149

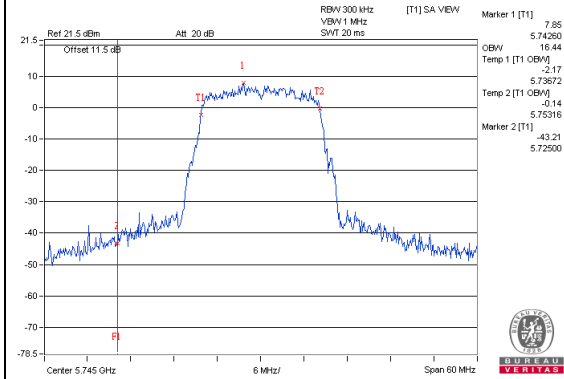

802.11a_Chain1 / CH149

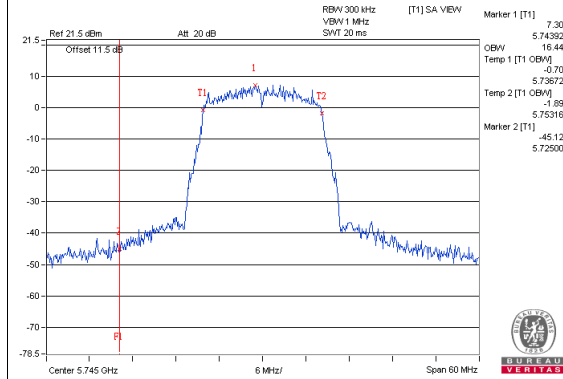

802.11ac(VHT20)_Chain0 / CH149

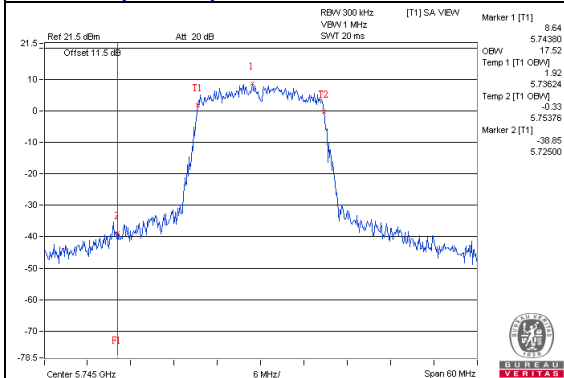

802.11ac(VHT20)_Chain1 / CH149

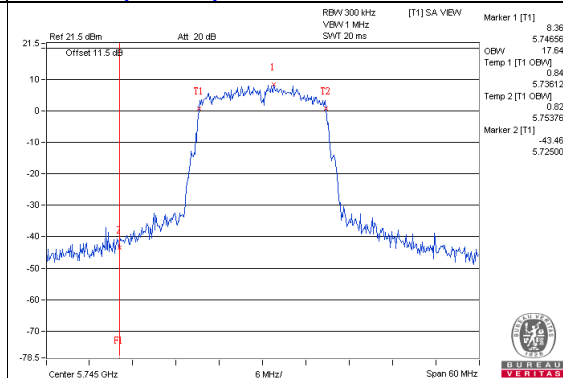

802.11ac(VHT40)_Chain0 / CH151

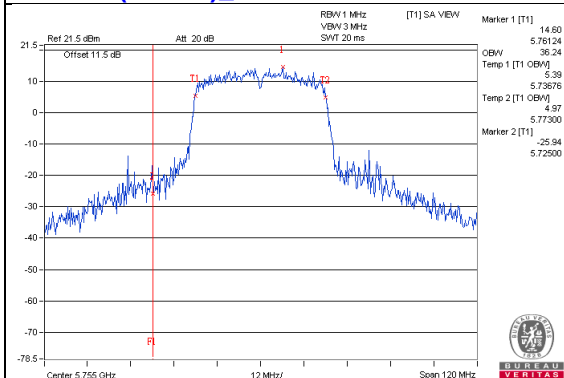

802.11ac(VHT40)_Chain1 / CH151

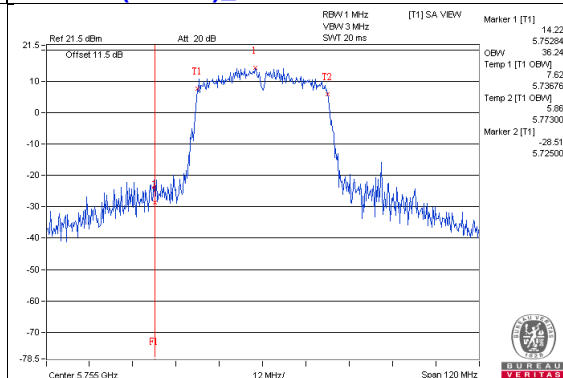

802.11ac(VHT80)_Chain0 / CH155

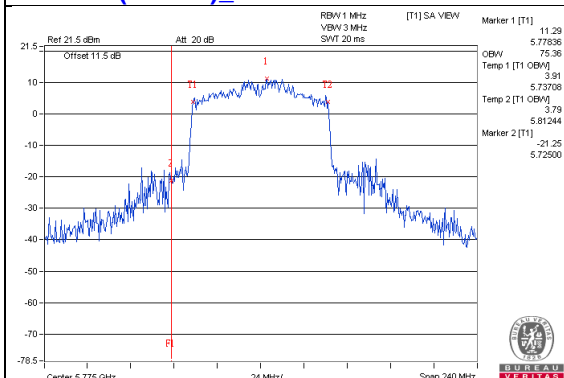

802.11ac(VHT80)_Chain1 / CH155

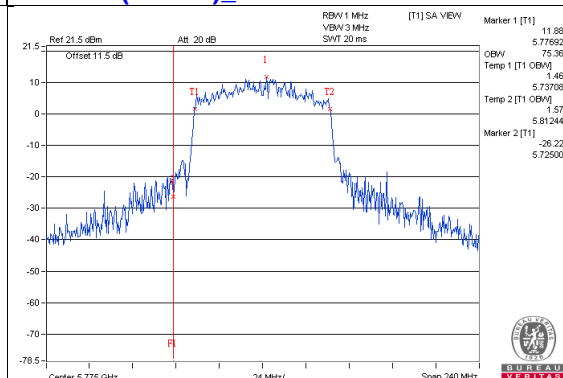

4.5 Peak Power Spectral Density Measurement

4.5.1 Limits of Peak Power Spectral Density Measurement

Operation Band	EUT Category		Limit
U-NII-1		Outdoor Access Point	17dBm/ MHz
		Fixed point-to-point Access Point	
	√	Indoor Access Point	11dBm/ MHz
		Mobile and Portable client device	
U-NII-2A			11dBm/ MHz
U-NII-2C			11dBm/ MHz
U-NII-3	√		30dBm/ 500kHz

4.5.2 Test Setup

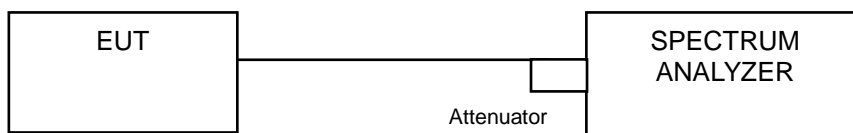

4.5.3 Test Instruments

Refer to section 4.1.2 to get information of above instrument.

4.5.4 Test Procedure

For U-NII-1:

Using method SA-2

1. Set span to encompass the entire emission bandwidth (EBW) of the signal.
2. Set RBW = 1 MHz, Set VBW \geq 3 MHz, Detector = RMS
3. Sweep time = auto, trigger set to "free run".
4. Trace average at least 100 traces in power averaging mode.
5. Record the max value and add 10 log (1/duty cycle)

For U-NII-3:

1. Set span to encompass the entire emission bandwidth (EBW) of the signal.
2. Set RBW = 300 kHz, Set VBW \geq 1 MHz, Detector = RMS
3. Use the peak marker function to determine the maximum power level in any 300 kHz band segment within the fundamental EBW.
4. Scale the observed power level to an equivalent value in 500 kHz by adjusting (reducing) the measured power by a bandwidth correction factor (BWCF) where $BWCF = 10\log(500 \text{ kHz}/300\text{kHz})$
5. Sweep time = auto, trigger set to "free run".
6. Trace average at least 100 traces in power averaging mode.
7. Record the max value and add 10 log (1/duty cycle)

4.5.5 Deviation from Test Standard

No deviation.

4.5.6 EUT Operating Condition

Same as Item 4.3.6.

4.5.7 Test Results

CDD Mode

For U-NII-1:

802.11a

Chan.	Chan. Freq. (MHz)	PSD W/O Duty Factor (dBm)		Duty Factor (dB)	Total PSD With Duty Factor (dBm)	MAX. Limit (dBm)	Pass / Fail
		Chain 0	Chain 1				
36	5180	4.57	5.59	0.92	9.04	14.99	Pass
40	5200	2.63	1.64	0.92	6.10	14.99	Pass
48	5240	9.02	8.94	0.92	12.91	14.99	Pass

- Note:**
- Method a) of power density measurement of KDB 662911 is using for calculating total power density. Total power density is summing entire spectra across corresponding frequency bins on the various outputs by computer.
 - Directional gain = $5\text{dBi} + 10\log(2) = 8.01\text{dBi} > 6\text{dBi}$, so the power density limit shall be reduced to $17 - (8.01 - 6) = 14.99\text{dBm}$.
 - Refer to section 3.3 for duty cycle spectrum plot.

802.11ac (VHT20)

Chan.	Chan. Freq. (MHz)	PSD W/O Duty Factor (dBm)		Duty Factor (dB)	Total PSD With Duty Factor (dBm)	MAX. Limit (dBm)	Pass / Fail
		Chain 0	Chain 1				
36	5180	5.75	5.63	1.03	9.73	14.99	Pass
40	5200	2.05	2.80	1.03	6.48	14.99	Pass
48	5240	6.46	5.97	1.03	10.26	14.99	Pass

- Note:**
- Method a) of power density measurement of KDB 662911 is using for calculating total power density. Total power density is summing entire spectra across corresponding frequency bins on the various outputs by computer.
 - Directional gain = $5\text{dBi} + 10\log(2) = 8.01\text{dBi} > 6\text{dBi}$, so the power density limit shall be reduced to $17 - (8.01 - 6) = 14.99\text{dBm}$.
 - Refer to section 3.3 for duty cycle spectrum plot.

802.11ac (VHT40)

Chan.	Chan. Freq. (MHz)	PSD W/O Duty Factor (dBm)		Duty Factor (dB)	Total PSD With Duty Factor (dBm)	MAX. Limit (dBm)	Pass / Fail
		Chain 0	Chain 1				
38	5190	-10.94	-11.38	1.79	-6.35	14.99	Pass
46	5230	0.49	1.04	1.79	5.57	14.99	Pass

- Note:**
- Method a) of power density measurement of KDB 662911 is using for calculating total power density. Total power density is summing entire spectra across corresponding frequency bins on the various outputs by computer.
 - Directional gain = $5\text{dBi} + 10\log(2) = 8.01\text{dBi} > 6\text{dBi}$, so the power density limit shall be reduced to $17 - (8.01 - 6) = 14.99\text{dBm}$.
 - Refer to section 3.3 for duty cycle spectrum plot.

802.11ac (VHT80)

Chan.	Chan. Freq. (MHz)	PSD W/O Duty Factor (dBm)		Duty Factor (dB)	Total PSD With Duty Factor (dBm)	MAX. Limit (dBm)	Pass / Fail
		Chain 0	Chain 1				
42	5210	-2.17	-1.46	0.25	1.46	14.99	Pass

- Note:**
- Method a) of power density measurement of KDB 662911 is using for calculating total power density. Total power density is summing entire spectra across corresponding frequency bins on the various outputs by computer.
 - Directional gain = $5\text{dBi} + 10\log(2) = 8.01\text{dBi} > 6\text{dBi}$, so the power density limit shall be reduced to $17 - (8.01 - 6) = 14.99\text{dBm}$.
 - Refer to section 3.3 for duty cycle spectrum plot.

Spectrum Plot of Worst Value

802.11a_Chain 0 / CH 48

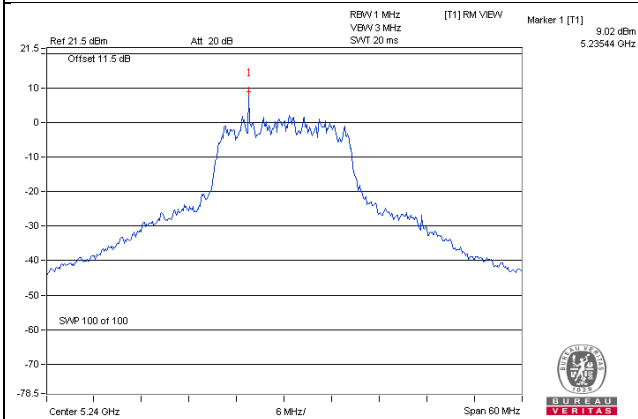

802.11ac (VHT20)_Chain 0 / CH 8

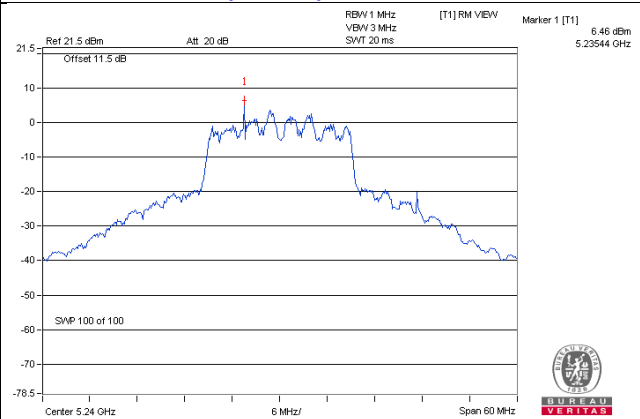

802.11ac (VHT40)_Chain 1 / CH 46

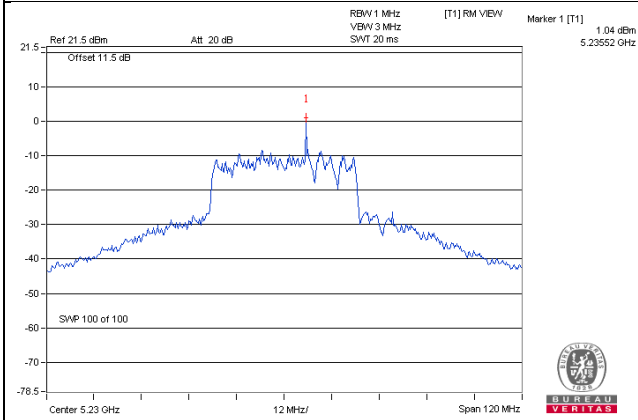

802.11ac (VHT80)_Chain 1 / CH 42

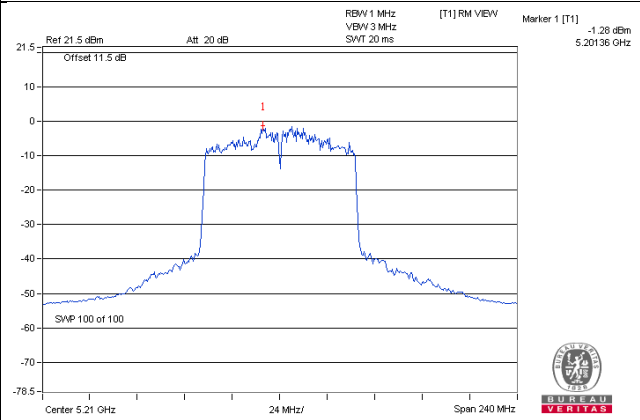

For U-NII-3:
802.11a

TX chain	Chan.	Chan. Freq. (MHz)	PSD W/O Duty Factor		10 log (N=2) dB	Duty Factor (dB)	Total PSD With Duty Factor (dBm/500kHz)	Limit (dBm/500kHz)	Pass /Fail
			(dBm/300kHz)	(dBm/500kHz)					
0	149	5745	-11.41	-9.19	3.01	0.92	-5.26	27.99	Pass
	157	5785	-8.95	-6.73	3.01	0.92	-2.80	27.99	Pass
	165	5825	-10.11	-7.89	3.01	0.92	-3.96	27.99	Pass
1	149	5745	-10.25	-8.03	3.01	0.92	-4.10	27.99	Pass
	157	5785	-12.64	-10.42	3.01	0.92	-6.49	27.99	Pass
	165	5825	-10.99	-8.77	3.01	0.92	-4.84	27.99	Pass

Note: 1. Directional gain = $5\text{dBi} + 10\log(2) = 8.01\text{dBi} > 6\text{dBi}$, so the power density limit shall be reduced to $30 - (8.01 - 6) = 27.99\text{dBm}$.

2. Refer to section 3.3 for duty cycle spectrum plot.

802.11ac (VHT20)

TX chain	Chan.	Chan. Freq. (MHz)	PSD W/O Duty Factor		10 log (N=2) dB	Duty Factor (dB)	Total PSD With Duty Factor (dBm/500kHz)	Limit (dBm/500kHz)	Pass /Fail
			(dBm/300kHz)	(dBm/500kHz)					
0	149	5745	-10.90	-8.68	3.01	1.03	-4.64	27.99	Pass
	157	5785	-9.91	-7.69	3.01	1.03	-3.65	27.99	Pass
	165	5825	-9.68	-7.46	3.01	1.03	-3.42	27.99	Pass
1	149	5745	-9.84	-7.62	3.01	1.03	-3.58	27.99	Pass
	157	5785	-9.84	-7.62	3.01	1.03	-3.58	27.99	Pass
	165	5825	-9.68	-7.46	3.01	1.03	-3.42	27.99	Pass

Note: 1. Directional gain = $5\text{dBi} + 10\log(2) = 8.01\text{dBi} > 6\text{dBi}$, so the power density limit shall be reduced to $30 - (8.01 - 6) = 27.99\text{dBm}$.

2. Refer to section 3.3 for duty cycle spectrum plot.

802.11ac (VHT40)

TX chain	Chan.	Chan. Freq. (MHz)	PSD W/O Duty Factor		10 log (N=2) dB	Duty Factor (dB)	Total PSD With Duty Factor (dBm/500kHz)	Limit (dBm/500kHz)	Pass /Fail
			(dBm/300kHz)	(dBm/500kHz)					
0	151	5755	-8.24	-6.02	3.01	1.79	-1.22	27.99	Pass
	159	5795	-12.63	-10.41	3.01	1.79	-5.61	27.99	Pass
1	151	5755	-8.19	-5.97	3.01	1.79	-1.17	27.99	Pass
	159	5795	-12.90	-10.68	3.01	1.79	-5.88	27.99	Pass

Note: 1. Directional gain = $5\text{dBi} + 10\log(2) = 8.01\text{dBi} > 6\text{dBi}$, so the power density limit shall be reduced to $30-(8.01-6) = 27.99\text{dBm}$.

2. Refer to section 3.3 for duty cycle spectrum plot.

802.11ac (VHT80)

TX chain	Chan.	Chan. Freq. (MHz)	PSD W/O Duty Factor		10 log (N=2) dB	Duty Factor (dB)	Total PSD With Duty Factor (dBm/500kHz)	Limit (dBm/500kHz)	Pass /Fail
			(dBm/300kHz)	(dBm/500kHz)					
0	155	5775	-6.63	-4.41	3.01	0.25	-1.15	27.99	Pass
1	155	5775	-6.17	-3.95	3.01	0.25	-0.69	27.99	Pass

Note: 1. Directional gain = $5\text{dBi} + 10\log(2) = 8.01\text{dBi} > 6\text{dBi}$, so the power density limit shall be reduced to $30-(8.01-6) = 27.99\text{dBm}$.

2. Refer to section 3.3 for duty cycle spectrum plot.

Spectrum Plot of Worst Value

802.11a – Chain 0: CH 157

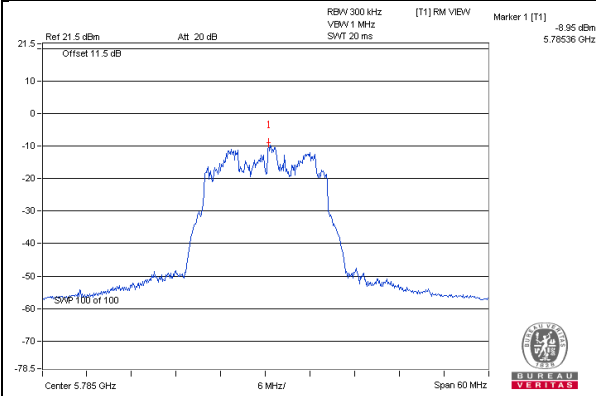

802.11ac (VHT20) – Chain 1: CH 165

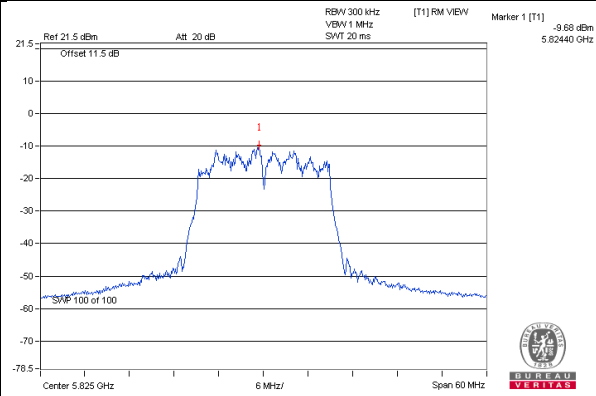

802.11ac (VHT40) – Chain 1: CH 151

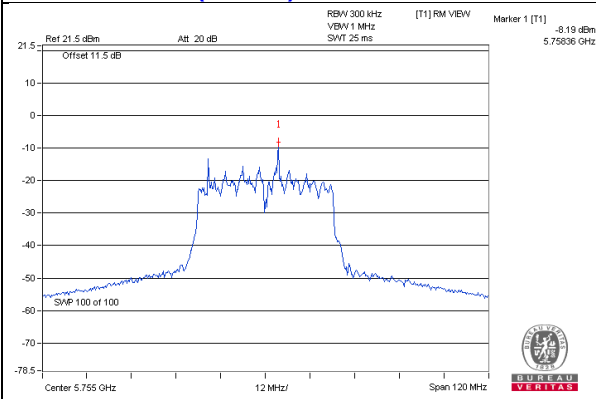

802.11ac (VHT80) – Chain 1: CH 155

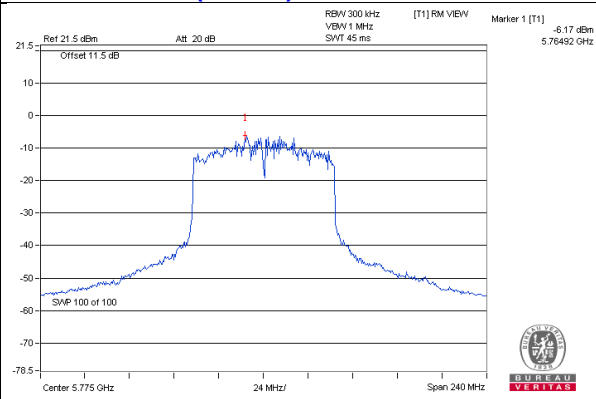

4.6 Frequency Stability Measurement

4.6.1 Limits of Frequency Stability Measurement

The frequency of the carrier signal shall be maintained within band of operation

4.6.2 Test Setup

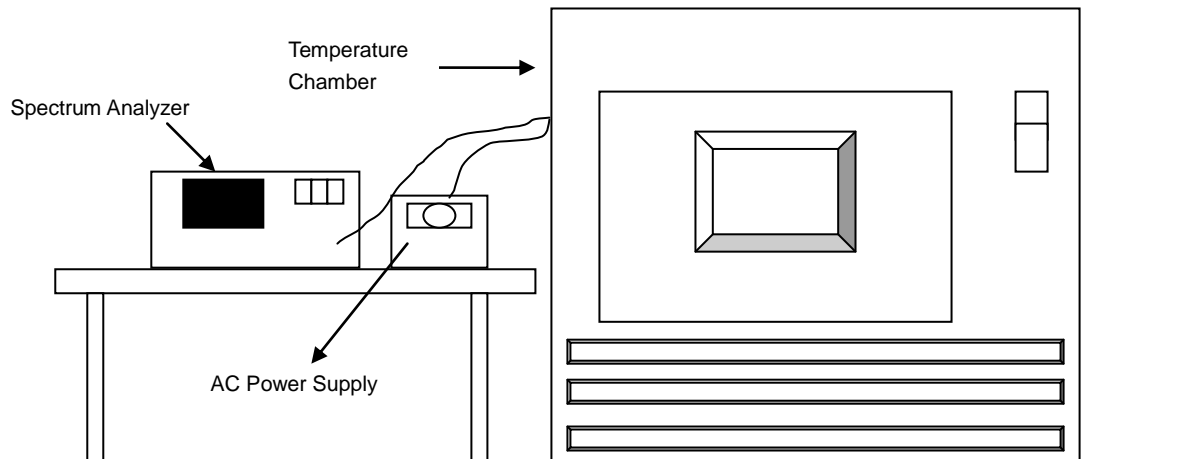

4.6.3 Test Instruments

Refer to section 4.1.2 to get information of above instrument.

4.6.4 Test Procedure

- The EUT was placed inside the environmental test chamber and powered by nominal AC voltage.
- Turn the EUT on and couple its output to a spectrum analyzer.
- Turn the EUT off and set the chamber to the highest temperature specified.
- Allow sufficient time (approximately 30 min) for the temperature of the chamber to stabilize, turn the EUT on and measure the operating frequency after 2, 5, and 10 Minutes.
- Repeat step 2 and 3 with the temperature chamber set to the lowest temperature.
- The test chamber was allowed to stabilize at +20 degree C for a minimum of 30 Minutes. The supply voltage was then adjusted on the EUT from 85% to 115% and the frequency record.

4.6.5 Deviation from Test Standard

No deviation.

4.6.6 EUT Operating Condition

Set the EUT transmit at un-modulation mode to test frequency stability.

4.6.7 Test Results

Frequency Stability Versus Temp.									
Operating Frequency: 5180 MHz									
TEMP. (°C)	Power Supply (Vac)	0 Minute		2 Minutes		5 Minutes		10 Minutes	
		Measured Frequency (MHz)	Pass/Fail	Measured Frequency (MHz)	Pass/Fail	Measured Frequency (MHz)	Pass/Fail	Measured Frequency (MHz)	Pass/Fail
50	120	5180.0228	PASS	5180.023	PASS	5180.023	PASS	5180.0249	PASS
40	120	5180.004	PASS	5180.0027	PASS	5180.0044	PASS	5180.0059	PASS
30	120	5179.993	PASS	5179.9915	PASS	5179.9933	PASS	5179.9911	PASS
20	120	5179.9864	PASS	5179.9887	PASS	5179.9853	PASS	5179.9871	PASS
10	120	5179.9846	PASS	5179.9833	PASS	5179.9854	PASS	5179.9828	PASS
0	120	5179.9889	PASS	5179.9897	PASS	5179.987	PASS	5179.9906	PASS
-10	120	5180.01	PASS	5180.0095	PASS	5180.0105	PASS	5180.0095	PASS
-20	120	5179.9832	PASS	5179.9831	PASS	5179.9853	PASS	5179.9856	PASS
-30	120	5179.983	PASS	5179.9813	PASS	5179.9845	PASS	5179.9844	PASS

Frequency Stability Versus Voltage									
Operating Frequency: 5180 MHz									
TEMP. (°C)	Power Supply (Vac)	0 Minute		2 Minutes		5 Minutes		10 Minutes	
		Measured Frequency (MHz)	Pass/Fail	Measured Frequency (MHz)	Pass/Fail	Measured Frequency (MHz)	Pass/Fail	Measured Frequency (MHz)	Pass/Fail
20	138	5179.9859	PASS	5179.9885	PASS	5179.9862	PASS	5179.9878	PASS
	120	5179.9864	PASS	5179.9887	PASS	5179.9853	PASS	5179.9871	PASS
	102	5179.9867	PASS	5179.9895	PASS	5179.9854	PASS	5179.9868	PASS

4.7 6dB Bandwidth Measurement

4.7.1 Limits of 6dB Bandwidth Measurement

The minimum of 6dB Bandwidth Measurement is 0.5MHz.

4.7.2 Test Setup

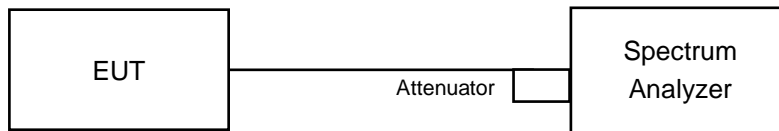

4.7.3 Test Instruments

Refer to section 4.1.2 to get information of above instrument.

4.7.4 Test Procedure

MEASUREMENT PROCEDURE REF

- Set resolution bandwidth (RBW) = 100kHz
- Set the video bandwidth (VBW) $\geq 3 \times$ RBW, Detector = Peak.
- Trace mode = max hold.
- Sweep = auto couple.
- Measure the maximum width of the emission that is constrained by the frequencies associated with the two amplitude points (upper and lower) that are attenuated by 6 dB relative to the maximum level measured in the fundamental emission

4.7.5 Deviation from Test Standard

No deviation.

4.7.6 EUT Operating Condition

The software provided by client to enable the EUT under transmission condition continuously at lowest, middle and highest channel frequencies individually.

4.7.7 Test Results

CDD Mode

802.11a

Channel	Frequency (MHz)	6dB Bandwidth (MHz)		Minimum Limit (MHz)	Pass / Fail
		Chain 0	Chain 1		
149	5745	15.19	15.37	0.5	PASS
157	5785	15.15	15.34	0.5	PASS
165	5825	15.06	15.39	0.5	PASS

802.11ac (VHT20)

Channel	Frequency (MHz)	6dB Bandwidth (MHz)		Minimum Limit (MHz)	Pass / Fail
		Chain 0	Chain 1		
149	5745	15.19	15.52	0.5	PASS
157	5785	15.16	15.18	0.5	PASS
165	5825	15.18	15.14	0.5	PASS

802.11ac (VHT40)

Channel	Frequency (MHz)	6dB Bandwidth (MHz)		Minimum Limit (MHz)	Pass / Fail
		Chain 0	Chain 1		
151	5755	35.25	35.23	0.5	PASS
159	5795	35.19	35.25	0.5	PASS

802.11ac (VHT80)

Channel	Frequency (MHz)	6dB Bandwidth (MHz)		Minimum Limit (MHz)	Pass / Fail
		Chain 0	Chain 1		
155	5775	74.05	75.29	0.5	PASS

Spectrum Plot of Worst Value

802.11a_Chain 0 / CH 165

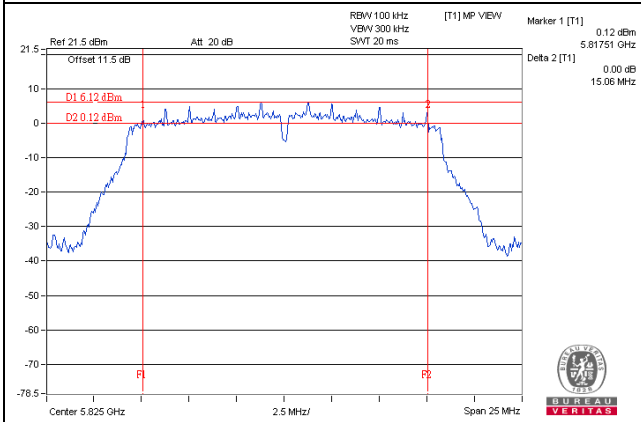

802.11ac (VHT20)_Chain 0 / CH 165

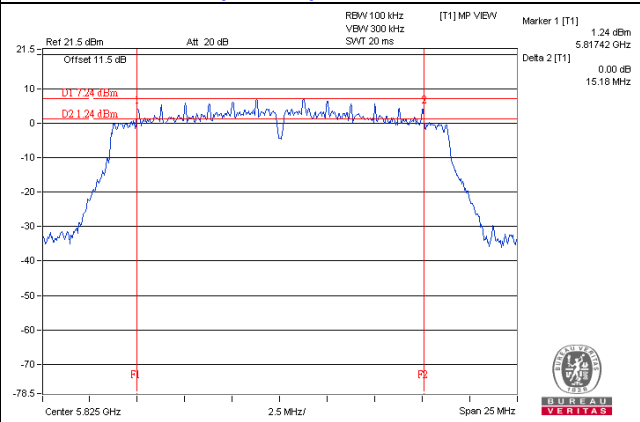

802.11ac (VHT40)_Chain 0 / CH 159

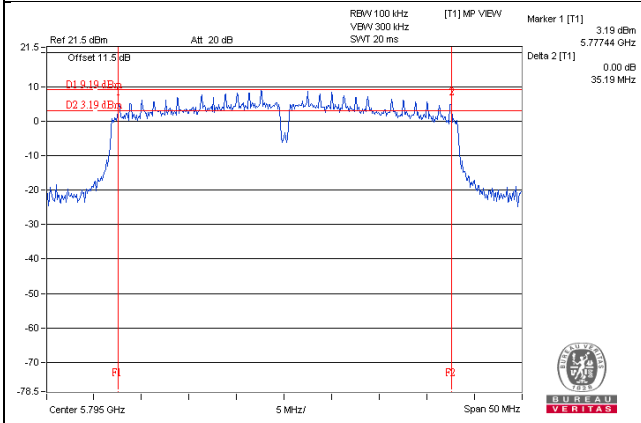

802.11ac (VHT80)_Chain 0 / CH 155

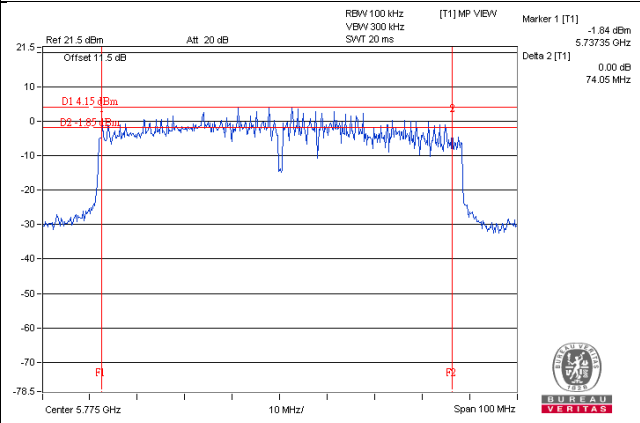

5 Pictures of Test Arrangements

Please refer to the attached file (Test Setup Photo).

Annex A- Radiated Out of Band Emission (OOBE) Measurement (For U-NII-3 band)

802.11a

CH 149 5745 MHz

Horizontal

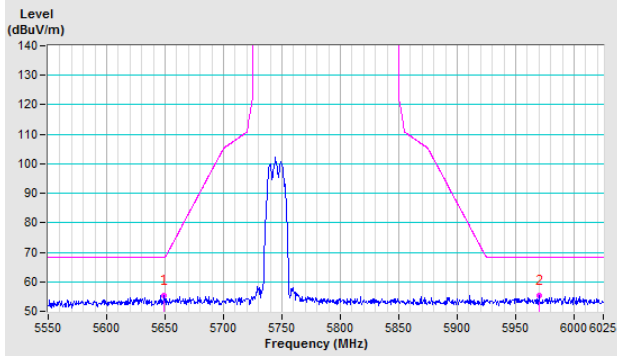

Vertical

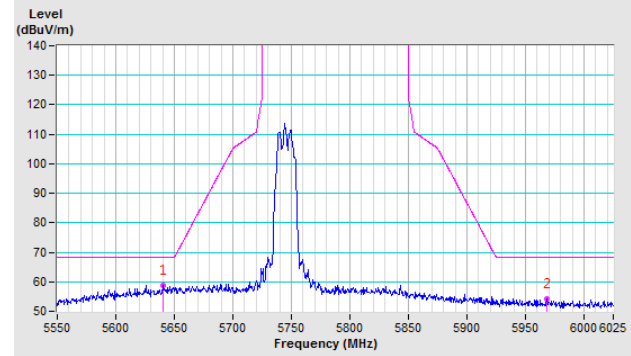

CH 157 5785 MHz

Horizontal

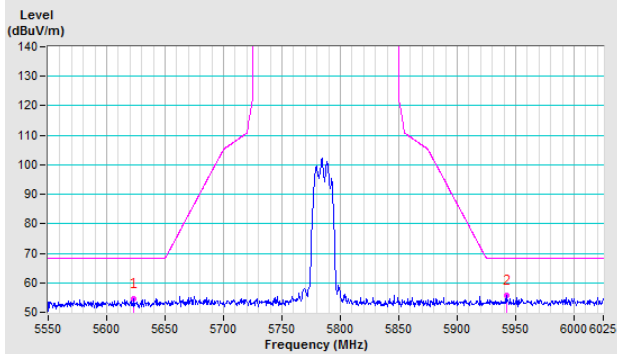

Vertical

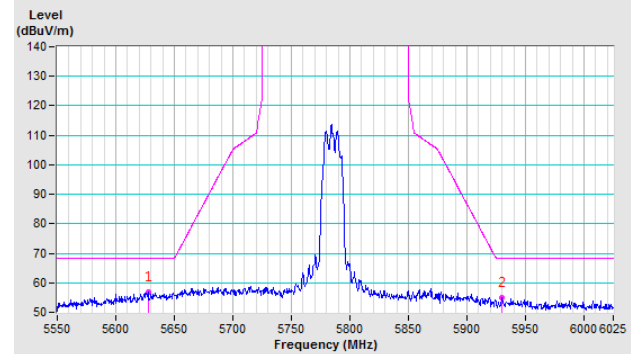

CH 165 5825 MHz

Horizontal

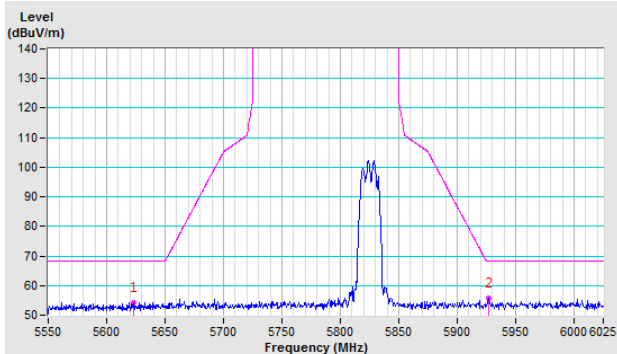

Vertical

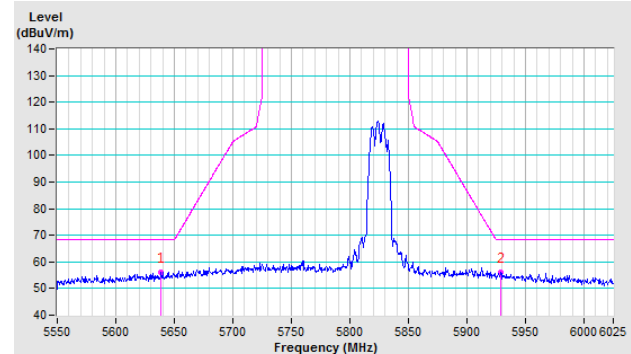

802.11ac (VHT20)

CH 149 5745 MHz

Horizontal

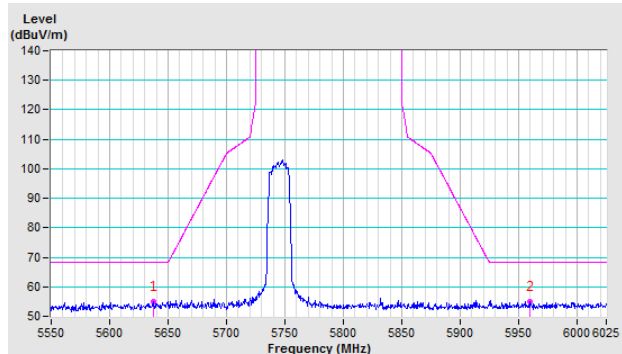

Vertical

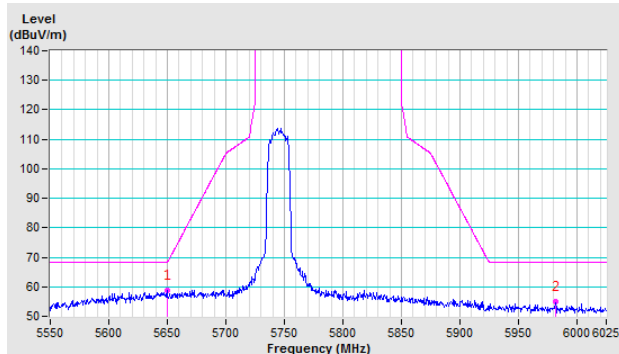

CH 157 5785 MHz

Horizontal

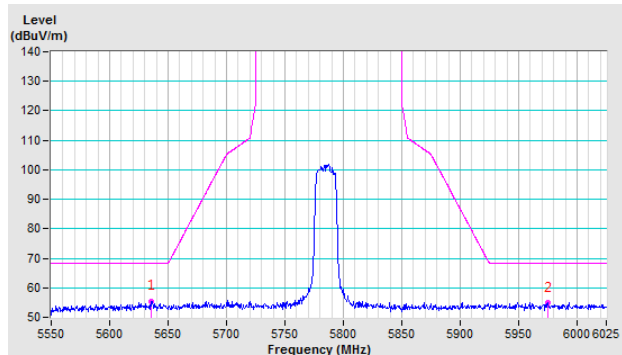

Vertical

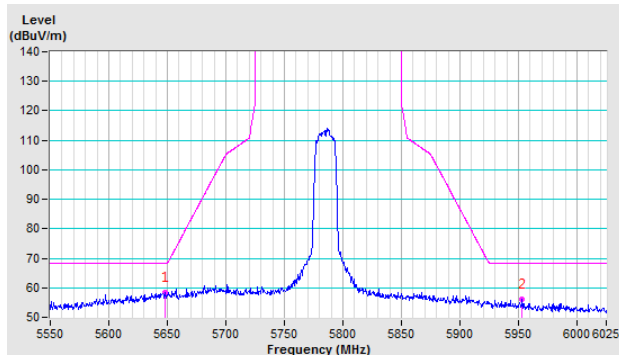

CH 165 5825 MHz

Horizontal

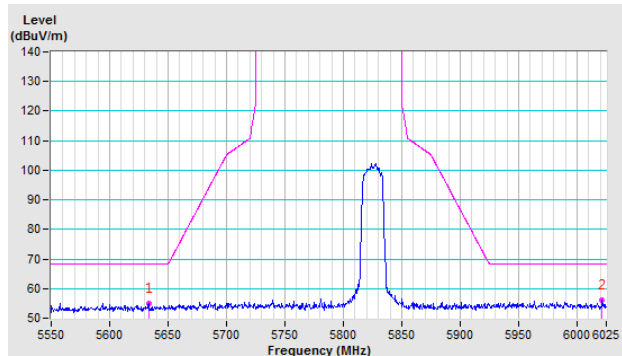

Vertical

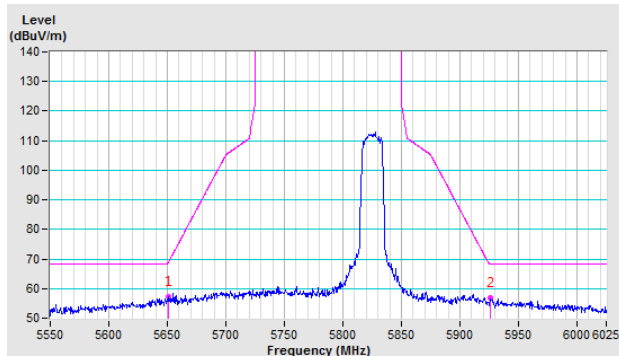

802.11ac (VHT40)

CH 151 5755 MHz

Horizontal

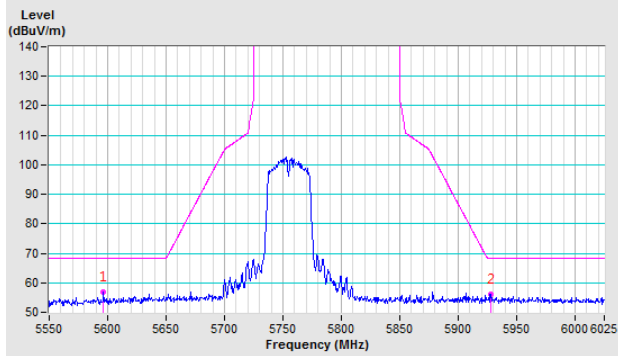

Vertical

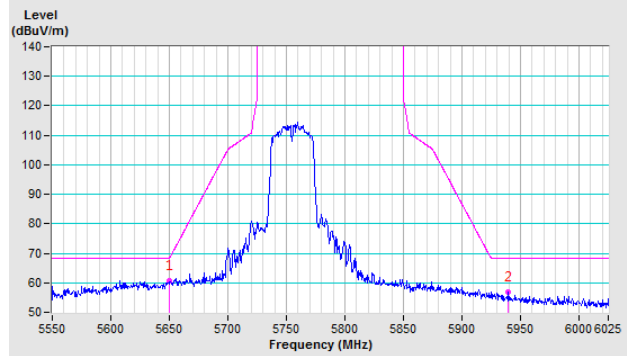

CH 159 5795 MHz

Horizontal

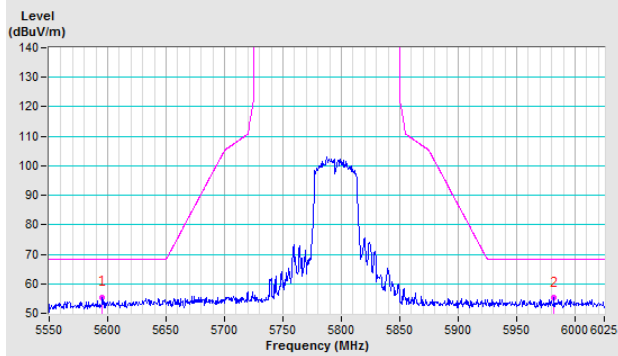

Vertical

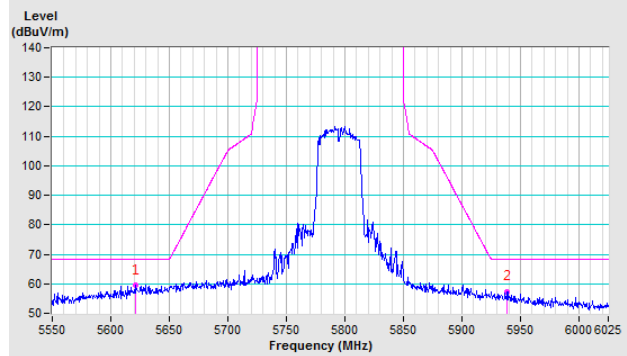

802.11ac (VHT80)

CH 155 5775 MHz

Horizontal

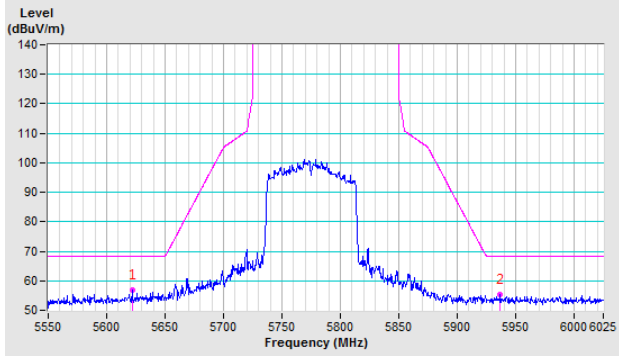

Vertical

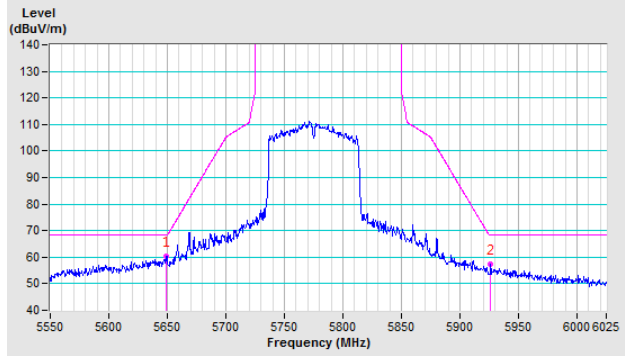

Appendix – Information on the Testing Laboratories

We, Bureau Veritas Consumer Products Services (H.K.) Ltd., Taoyuan Branch, were founded in 1988 to provide our best service in EMC, Radio, Telecom and Safety consultation. Our laboratories are FCC recognized accredited test firms and accredited according to ISO/IEC 17025.

If you have any comments, please feel free to contact us at the following:

Linko EMC/RF Lab

Tel: 886-2-26052180

Fax: 886-2-26051924

Hsin Chu EMC/RF/Telecom Lab

Tel: 886-3-6668565

Fax: 886-3-6668323

Hwa Ya EMC/RF/Safety Lab

Tel: 886-3-3183232

Fax: 886-3-3270892

Email: service.adt@tw.bureauveritas.com

Web Site: www.bureauveritas-adt.com

The address and road map of all our labs can be found in our web site also.

--- END ---