



FCC TEST REPORT (15.247)

REPORT NO.: RF130207E02

MODEL NO.: DIR-850L

FCC ID: KA2IR850LA1

RECEIVED: Feb. 07, 2013

TESTED: Feb. 08 to 19, 2013

ISSUED: Feb. 22, 2013

APPLICANT: D-Link Corporation

ADDRESS: No.289, Sinhu 3rd Rd., Neihu District, Taipei
City 114, Taiwan, R.O.C.

ISSUED BY: Bureau Veritas Consumer Products Services
(H.K.) Ltd., Taoyuan Branch Hsin Chu Laboratory

LAB ADDRESS : No. 81-1, Lu Liao Keng, 9th Ling, Wu Lung Tsuen,
Chiung Lin Hsiang, Hsin Chu Hsien 307, Taiwan,
R.O.C.

TEST LOCATION (1): No. 81-1, Lu Liao Keng, 9th Ling, Wu Lung Tsuen,
Chiung Lin Hsiang, Hsin Chu Hsien 307, Taiwan,
R.O.C.

TEST LOCATION (2): No. 49, Ln. 206, Wende Rd., Shangshan Tsuen,
Chiung Lin Hsiang, Hsin Chu Hsien 307, Taiwan,
R.O.C.

This report should not be used by the client to claim product certification, approval, or endorsement by TAF or any government agencies.



This report is for your exclusive use. Any copying or replication of this report to or for any other person or entity, or use of our name or trademark, is permitted only with our prior written permission. This report sets forth our findings solely with respect to the test samples identified herein. The results set forth in this report are not indicative or representative of the quality or characteristics of the lot from which a test sample was taken or any similar or identical product unless specifically and expressly noted. Our report includes all of the tests requested by you and the results thereof based upon the information that you provided to us. You have 60 days from date of issuance of this report to notify us of any material error or omission caused by our negligence, provided, however, that such notice shall be in writing and shall specifically address the issue you wish to raise. A failure to raise such issue within the prescribed time shall constitute your unqualified acceptance of the completeness of this report, the tests conducted and the correctness of the report contents. Unless specific mention, the uncertainty of measurement has been explicitly taken into account to declare the compliance or non-compliance to the specification



A D T

Table of Contents

RELEASE CONTROL RECORD	5
1. CERTIFICATION	6
2. SUMMARY OF TEST RESULTS	7
2.1 MEASUREMENT UNCERTAINTY	8
3. GENERAL INFORMATION	9
3.1 GENERAL DESCRIPTION OF EUT	9
3.2 DESCRIPTION OF TEST MODES	13
3.2.1 TEST MODE APPLICABILITY AND TESTED CHANNEL DETAIL	14
3.3 GENERAL DESCRIPTION OF APPLIED STANDARDS	17
3.4 DESCRIPTION OF SUPPORT UNITS	18
3.5 CONFIGURATION OF SYSTEM UNDER TEST	19
4. TEST TYPES AND RESULTS (FOR 2.4GHz, 2.400 ~ 2.4835GHz Band)	20
4.1 CONDUCTED EMISSION MEASUREMENT	20
4.1.1 LIMITS OF CONDUCTED EMISSION MEASUREMENT	20
4.1.2 TEST INSTRUMENTS	20
4.1.3 TEST PROCEDURES	21
4.1.4 DEVIATION FROM TEST STANDARD	21
4.1.5 TEST SETUP	21
4.1.6 EUT OPERATING CONDITIONS	22
4.1.7 TEST RESULTS (MODE 1)	23
4.1.8 TEST RESULTS (MODE 2)	25
4.2 RADIATED EMISSION AND BANDEDGE MEASUREMENT	27
4.2.1 LIMITS OF RADIATED EMISSION AND BANDEDGE MEASUREMENT	27
4.2.2 TEST INSTRUMENTS	28
4.2.3 TEST PROCEDURES	29
4.2.4 DEVIATION FROM TEST STANDARD	29
4.2.5 TEST SETUP	30
4.2.6 EUT OPERATING CONDITIONS	30
4.2.7 TEST RESULTS	31
4.3 6dB BANDWIDTH MEASUREMENT	44
4.3.1 LIMITS OF 6dB BANDWIDTH MEASUREMENT	44
4.3.2 TEST INSTRUMENTS	44
4.3.3 TEST PROCEDURE	44
4.3.4 DEVIATION FROM TEST STANDARD	44
4.3.5 TEST SETUP	44
4.3.6 EUT OPERATING CONDITIONS	44
4.3.7 TEST RESULTS	45
4.4 CONDUCTED OUTPUT POWER MEASUREMENT	46
4.4.1 LIMITS OF MAXIMUM PEAK OUTPUT POWER MEASUREMENT	46
4.4.2 INSTRUMENTS	46
4.4.3 TEST PROCEDURES	46
4.4.4 DEVIATION FROM TEST STANDARD	47
4.4.5 TEST SETUP	47
4.4.6 EUT OPERATING CONDITIONS	47
4.4.7 TEST RESULTS	48
4.5 POWER SPECTRAL DENSITY MEASUREMENT	49
4.5.1 LIMITS OF POWER SPECTRAL DENSITY MEASUREMENT	49
4.5.2 TEST INSTRUMENTS	49
4.5.3 TEST PROCEDURE	49
4.5.4 DEVIATION FROM TEST STANDARD	49



A D T

4.5.5	TEST SETUP	49
4.5.6	EUT OPERATING CONDITION	49
4.5.7	TEST RESULTS	50
4.6	CONDUCTED OUT-BAND EMISSION MEASUREMENT	52
4.6.1	LIMITS OF CONDUCTED OUT-BAND EMISSION MEASUREMENT	52
4.6.2	TEST INSTRUMENTS	52
4.6.3	TEST PROCEDURE	52
4.6.4	DEVIATION FROM TEST STANDARD	53
4.6.5	TEST SETUP	53
4.6.6	EUT OPERATING CONDITION	53
4.6.7	TEST RESULTS	53
5.	TEST TYPES AND RESULTS (FOR 5GHz, 5.725~5.850GHz Band)	62
5.1	CONDUCTED EMISSION MEASUREMENT	62
5.1.1	LIMITS OF CONDUCTED EMISSION MEASUREMENT	62
5.1.2	TEST INSTRUMENTS	62
5.1.3	TEST PROCEDURES	63
5.1.4	DEVIATION FROM TEST STANDARD	63
5.1.5	TEST SETUP	63
5.1.6	EUT OPERATING CONDITIONS	64
5.1.7	TEST RESULTS (MODE 1)	65
5.1.8	TEST RESULTS (MODE 2)	67
5.2	RADIATED AND BANDEDGE EMISSION MEASUREMENT	69
5.2.1	LIMITS OF RADIATED AND BANDEDGE EMISSION MEASUREMENT	69
5.2.2	TEST INSTRUMENTS	70
5.2.3	TEST PROCEDURES	71
5.2.4	DEVIATION FROM TEST STANDARD	71
5.2.5	TEST SETUP	72
5.2.6	EUT OPERATING CONDITIONS	72
5.2.7	TEST RESULTS	73
5.3	6dB BANDWIDTH MEASUREMENT	83
5.3.1	LIMITS OF 6dB BANDWIDTH MEASUREMENT	83
5.3.2	TEST INSTRUMENTS	83
5.3.3	TEST PROCEDURE	83
5.3.4	DEVIATION FROM TEST STANDARD	83
5.3.5	TEST SETUP	83
5.3.6	EUT OPERATING CONDITIONS	83
5.3.7	TEST RESULTS	84
5.4	CONDUCTED OUTPUT POWER MEASUREMENT	85
5.4.1	LIMITS OF CONDUCTED OUTPUT POWER MEASUREMENT	85
5.4.2	INSTRUMENTS	85
5.4.3	TEST PROCEDURES	86
5.4.4	DEVIATION FROM TEST STANDARD	86
5.4.5	TEST SETUP	87
5.4.6	EUT OPERATING CONDITIONS	87
5.4.7	TEST RESULTS	88
5.5	POWER SPECTRAL DENSITY MEASUREMENT	89
5.5.1	LIMITS OF POWER SPECTRAL DENSITY MEASUREMENT	89
5.5.2	TEST INSTRUMENTS	89
5.5.3	TEST PROCEDURE	89
5.5.4	DEVIATION FROM TEST STANDARD	89
5.5.5	TEST SETUP	89
5.5.6	EUT OPERATING CONDITION	89



A D T

5.5.7	TEST RESULTS	90
5.6	CONDUCTED OUT-BAND EMISSION MEASUREMENT	92
5.6.1	LIMITS OF CONDUCTED OUT-BAND EMISSION MEASUREMENT	92
5.6.2	TEST INSTRUMENTS	92
5.6.3	TEST PROCEDURE	92
5.6.4	DEVIATION FROM TEST STANDARD	93
5.6.5	TEST SETUP	93
5.6.6	EUT OPERATING CONDITION	93
5.6.7	TEST RESULTS	93
6.	PHOTOGRAPHS OF THE TEST CONFIGURATION	101
7.	INFORMATION ON THE TESTING LABORATORIES	102
8.	APPENDIX A - MODIFICATIONS RECORDERS FOR ENGINEERING CHANGES TO THE EUT BY THE LAB	103



A D T

RELEASE CONTROL RECORD

ISSUE NO.	REASON FOR CHANGE	DATE ISSUED
RF130207E02	Original release	Feb. 22, 2013



A D T

1. CERTIFICATION

PRODUCT: Wireless AC1200 Dual Band Gigabit Cloud Router
BRAND NAME: D-Link
MODEL NO.: DIR-850L
TEST SAMPLE: R&D SAMPLE
APPLICANT: D-Link Corporation
TESTED: Feb. 08 to 19, 2013
STANDARDS: FCC Part 15, Subpart C (Section 15.247)
ANSI C63.10-2009

The above equipment (Model: DIR-850L) has been tested by **Bureau Veritas Consumer Products Services (H.K.) Ltd., Taoyuan Branch**, and found compliance with the requirement of the above standards. The test record, data evaluation & Equipment Under Test (EUT) configurations represented herein are true and accurate accounts of the measurements of the sample's EMC characteristics under the conditions specified in this report.

PREPARED BY : Phoenix Huang , **DATE:** Feb. 22, 2013
(Phoenix Huang, Specialist)

APPROVED BY : May Chen , **DATE:** Feb. 22, 2013
(May Chen, Deputy Manager)



A D T

2. SUMMARY OF TEST RESULTS

The EUT has been tested according to the following specifications:

For 2.4GHz, 2400~2483.5MHz Band

APPLIED STANDARD: FCC PART 15, SUBPART C (SECTION 15.247)			
STANDARD SECTION	TEST TYPE	RESULT	REMARK
15.207	AC Power Conducted Emission	PASS	Meet the requirement of limit. Minimum passing margin is -13.43dB at 0.16172MHz
15.247(d) 15.209	Radiated Emissions	PASS	Meet the requirement of limit. Minimum passing margin is -0.5dB at 2483.50MHz
15.247(d)	Band Edge Measurement	PASS	Meet the requirement of limit.
15.247(a)(2)	6dB bandwidth	PASS	Meet the requirement of limit.
15.247(b)	Conducted Output power	PASS	Meet the requirement of limit.
15.247(e)	Power Spectral Density	PASS	Meet the requirement of limit.
15.203	Antenna Requirement	PASS	No antenna connector is used.

For 5GHz, 5725~5850MHz Band

APPLIED STANDARD: FCC PART 15, SUBPART C (SECTION 15.247)			
STANDARD SECTION	TEST TYPE	RESULT	REMARK
15.207	AC Power Conducted Emission	PASS	Meet the requirement of limit. Minimum passing margin is -14.45dB at 0.15753MHz
15.247(d) 15.209	Radiated Emissions	PASS	Meet the requirement of limit. Minimum passing margin is -7.4dB at 11650.0MHz
15.247(d)	Band Edge Measurement	PASS	Meet the requirement of limit.
15.247(a)(2)	6dB bandwidth	PASS	Meet the requirement of limit.
15.247(b)	Conducted Output power	PASS	Meet the requirement of limit.
15.247(e)	Power Spectral Density	PASS	Meet the requirement of limit.
15.203	Antenna Requirement	PASS	Antenna connector is IPEX not a standard connector.

NOTE: The EUT was operating in 2.400 ~ 2.4835GHz, 5.15~5.25GHz and 5.725~5.850GHz frequencies band. This report was recorded the RF parameters including 2.400 ~ 2.4835GHz and 5.725~5.850GHz. For the 5.15~5.25GHz RF parameters was recorded in another test report.



A D T

2.1 MEASUREMENT UNCERTAINTY

Where relevant, the following measurement uncertainty levels have been estimated for tests performed on the EUT as specified in CISPR 16-4-2:

This uncertainty represents an expanded uncertainty expressed at approximately the 95% confidence level using a coverage factor of $k=2$.

Measurement	Value
Conducted emissions	2.98 dB
Radiated emissions (30MHz-1GHz)	5.63 dB
Radiated emissions (1GHz -6GHz)	3.73 dB
Radiated emissions (6GHz -18GHz)	3.90 dB
Radiated emissions (18GHz -40GHz)	4.11 dB



A D T

3. GENERAL INFORMATION

3.1 GENERAL DESCRIPTION OF EUT

PRODUCT	Wireless AC1200 Dual Band Gigabit Cloud Router
MODEL NO.	DIR-850L
POWER SUPPLY	DC 12V from power adapter
MODULATION TYPE	CCK, DQPSK, DBPSK for DSSS 64QAM, 16QAM, QPSK, BPSK for OFDM 256QAM for OFDM in 11ac mode only.
MODULATION TECHNOLOGY	DSSS,OFDM
TRANSFER RATE	802.11b: up to 11Mbps 802.11a / g: up to 54Mbps 802.11n: up to 450Mbps 802.11ac: up to 866.7Mbps
OPERATING FREQUENCY	For 15.407 802.11a/n/ac: 5.18 ~ 5.24GHz
	For 15.247 802.11b/g/n: 2.412 ~ 2.462GHz 802.11a/n/ac: 5.745 ~ 5.825GHz
NUMBER OF CHANNEL	For 15.407 4 for 802.11a, 802.11n (HT20), 802.11ac (VHT20) 2 for 802.11n (HT40), 802.11ac (VHT40) 1 for 802.11ac (VHT80)
	For 15.247 (2.4GHz) 11 for 802.11b, 802.11g, 802.11n (HT20) 7 for 802.11n (HT40) For 15.247 (5GHz) 5 for 802.11a, 802.11n (HT20), 802.11ac (VHT20) 2 for 802.11n (HT40), 802.11ac (VHT40) 1 for 802.11ac (VHT80)

MAXIMUM OUTPUT POWER	For 15.407 802.11a: 46.351mW 802.11n (HT20): 45.296mW 802.11n (HT40): 43.767mW 802.11ac (VHT80): 28.749mW For 15.247 (2.4GHz) 802.11b: 372.812mW 802.11g: 178.250mW 802.11n (HT20): 174.239mW 802.11n (HT40): 70.155mW For 15.247 (5GHz) 802.11a: 146.575mW 802.11n (HT20): 144.926mW 802.11n (HT40): 113.778mW 802.11ac (VHT80): 193.951mW
ANTENNA TYPE	Please see NOTE
DATA CABLE	NA
I/O PORTS	Refer to user's manual
ASSOCIATED DEVICES	Adapter x1

NOTE:

1. The EUT is a 2.4GHz & 5GHz WLAN device.
2. The EUT must be supplied with a power adapter and following two different models could be chosen as following table:

No	Brand	Model No.	Spec.	Plug
1	D-Link	SAG024F 4 US	Input: 100-240V, 0.8A, 47-63Hz Output: 12V, 2A DC output cable (Unshielded, 1.5m)	US
2	D-Link	AMS4-1202000FU	Input: 100-240V, 0.8A, 50-60Hz Output: 12V, 2A DC output cable (Unshielded, 1.5m)	US

Note: 1. For radiated emissions test, the EUT was pre-tested with above adapters 1 & 2, the worst case was found in adapter 1. Therefore only the test data of the adapter 1 was recorded in this report.

3. The antenna provided to the EUT, please refer to the following table:

For 2.4GHz								
Transmitter Circuit	Brand	Model	Antenna Type	Peak Gain (dBi) (Include cable loss)	Frequency range (MHz to MHz)	Connector Type	Cable Loss (dB)	Cable Length (cm)
Chain (1)	MAG.LA YERS	PCA-5010-2G4C1-A1	PCB Dipole	2.67	2400~2500	NA	NA	6.5
Chain (0)	Alpha	NA	Printed	2.94	2400~2500	NA	NA	5
For 5GHz								
Transmitter Circuit	Brand	Model	Antenna Type	Peak Gain (dBi) (Include cable loss)	Frequency range (MHz to MHz)	Connector Type	Cable Loss (dB)	Cable Length (cm)
Chain (1)	MAG.LA YERS	PCA-2010-5G0C1-A4	PCB Dipole	2.25	4900~5825	IPEX	NA	11
Chain (0)	MAG.LA YERS	PCA-2010-5G0C1-A4	PCB Dipole	2.25	4900~5825	IPEX	NA	11

4. The EUT incorporates a MIMO function without beam forming.

MODULATION MODE	TX/RX FUNCTION
802.11b	2Tx/2Rx
802.11g	2Tx/2Rx
802.11n (HT20) <2.4GHz>	2Tx/2Rx
802.11n (HT40) <2.4GHz>	2Tx/2Rx
802.11a	2Tx/2Rx
802.11n (HT20) <5GHz>	2Tx/2Rx
802.11n (HT40) <5GHz>	2Tx/2Rx
802.11ac (VHT20)	2Tx/2Rx
802.11ac (VHT40)	2Tx/2Rx
802.11ac (VHT80)	2Tx/2Rx

Note: The modulation and bandwidth are similar for 802.11n mode for 20MHz (40MHz) and 802.11ac mode for 20MHz (40MHz), therefore investigated worst case to representative mode in test report. (Final test mode refer section 3.2.1)

5. Conducted emission and radiated emission of the simultaneous operation (2.4GHz & 5GHz) has been evaluated and no non-compliance was found.

6. When the EUT operating in 802.11n, the software operation, which is defined by manufacturer, MCS (Modulation and Coding Schemes) from 0 to 15.



A D T

7. When the EUT operating in 802.11ac, the software operation, which is defined by manufacturer, MCS (Modulation and Coding Schemes) from 0 to 9.
8. The above EUT information was declared by the manufacturer and for more detailed features description, please refer to the manufacturer's specifications or User's Manual.

3.2 DESCRIPTION OF TEST MODES

Operated in 2400 ~ 2483.5MHz band:

11 channels are provided for 802.11b, 802.11g, 802.11n (HT20):

CHANNEL	FREQUENCY	CHANNEL	FREQUENCY
1	2412MHz	7	2442MHz
2	2417MHz	8	2447MHz
3	2422MHz	9	2452MHz
4	2427MHz	10	2457MHz
5	2432MHz	11	2462MHz
6	2437MHz		

7 channels are provided for 802.11n (HT40):

CHANNEL	FREQUENCY	CHANNEL	FREQUENCY
3	2422MHz	7	2442MHz
4	2427MHz	8	2447MHz
5	2432MHz	9	2452MHz
6	2437MHz		

Operated in 5725 ~ 5850MHz band:

5 channels are provided for 802.11a, 802.11n (HT20), 802.11ac (VHT20):

CHANNEL	FREQUENCY	CHANNEL	FREQUENCY
149	5745 MHz	161	5805 MHz
153	5765 MHz	165	5825 MHz
157	5785 MHz		

2 channels are provided for 802.11n (HT40), 802.11ac (VHT40):

CHANNEL	FREQUENCY
151	5755 MHz
159	5795 MHz

1 channel is provided for 802.11ac (VHT80):

CHANNEL	FREQUENCY
155	5775 MHz

3.2.1 TEST MODE APPLICABILITY AND TESTED CHANNEL DETAIL

EUT CONFIGURE MODE	APPLICABLE TO					DESCRIPTION
	PLC	RE < 1G	RE ≥ 1G	APCM	OB	
1	√	√	√	√	√	Adapter 1
2	√	-	-	-	-	Adapter 2

Where **PLC**: Power Line Conducted Emission **RE < 1G**: Radiated Emission below 1GHz
RE ≥ 1G: Radiated Emission above 1GHz **APCM**: Antenna Port Conducted Measurement
OB: Conducted Out-Band Emission Measurement

POWER LINE CONDUCTED EMISSION TEST:

- Pre-Scan has been conducted to determine the worst-case mode from all possible combinations between available modulations, data rates and antenna ports (if EUT with antenna diversity architecture).
- Following channel(s) was (were) selected for the final test as listed below.

MODE	AVAILABLE CHANNEL	TESTED CHANNEL	MODULATION TECHNOLOGY	MODULATION TYPE	DATA RATE (Mbps)
802.11b	1 to 11	6	DSSS	DBPSK	1
802.11a	149 to 165	157	OFDM	BPSK	6

RADIATED EMISSION TEST (BELOW 1 GHz):

- Pre-Scan has been conducted to determine the worst-case mode from all possible combinations between available modulations, data rates and antenna ports (if EUT with antenna diversity architecture).
- Following channel(s) was (were) selected for the final test as listed below.

MODE	AVAILABLE CHANNEL	TESTED CHANNEL	MODULATION TECHNOLOGY	MODULATION TYPE	DATA RATE (Mbps)
802.11b	1 to 11	6	DSSS	DBPSK	1
802.11a	149 to 165	157	OFDM	BPSK	6



RADIATED EMISSION TEST (ABOVE 1 GHz):

- Pre-Scan has been conducted to determine the worst-case mode from all possible combinations between available modulations, data rates and antenna ports (if EUT with antenna diversity architecture).
- Following channel(s) was (were) selected for the final test as listed below.

MODE	AVAILABLE CHANNEL	TESTED CHANNEL	MODULATION TECHNOLOGY	MODULATION TYPE	DATA RATE (Mbps)
802.11b	1 to 11	1, 6, 11	DSSS	DBPSK	1
802.11g	1 to 11	1, 6, 11	OFDM	BPSK	6
For 2.4 GHz 802.11n (HT20)	1 to 11	1, 6, 11	OFDM	BPSK	6.5
For 2.4 GHz 802.11n (HT40)	3 to 9	3, 6, 9	OFDM	BPSK	13.5
802.11a	149 to 165	149, 157, 165	OFDM	BPSK	6
For 5 GHz 802.11n (HT20)	149 to 165	149, 157, 165	OFDM	BPSK	6.5
For 5 GHz 802.11n (HT40)	151 to 159	151, 159	OFDM	BPSK	13.5
For 5 GHz 802.11ac (VHT80)	155	155	OFDM	BPSK	58.5

ANTENNA PORT CONDUCTED MEASUREMENT:

- Pre-Scan has been conducted to determine the worst-case mode from all possible combinations between available modulations, data rates and antenna ports (if EUT with antenna diversity architecture).
- Following channel(s) was (were) selected for the final test as listed below.

MODE	AVAILABLE CHANNEL	TESTED CHANNEL	MODULATION TECHNOLOGY	MODULATION TYPE	DATA RATE (Mbps)
802.11b	1 to 11	1, 6, 11	DSSS	DBPSK	1
802.11g	1 to 11	1, 6, 11	OFDM	BPSK	6
For 2.4 GHz 802.11n (HT20)	1 to 11	1, 6, 11	OFDM	BPSK	6.5
For 2.4 GHz 802.11n (HT40)	3 to 9	3, 6, 9	OFDM	BPSK	13.5
802.11a	149 to 165	149, 157, 165	OFDM	BPSK	6
For 5 GHz 802.11n (HT20)	149 to 165	149, 157, 165	OFDM	BPSK	6.5
For 5 GHz 802.11n (HT40)	151 to 159	151, 159	OFDM	BPSK	13.5
For 5 GHz 802.11ac (VHT80)	155	155	OFDM	BPSK	58.5



A D T

CONDUCTED OUT-BAND EMISSION MEASUREMENT:

- Pre-Scan has been conducted to determine the worst-case mode from all possible combinations between available modulations, data rates and antenna ports (if EUT with antenna diversity architecture).
- Following channel(s) was (were) selected for the final test as listed below.

MODE	AVAILABLE CHANNEL	TESTED CHANNEL	MODULATION TECHNOLOGY	MODULATION TYPE	DATA RATE (Mbps)
802.11b	1 to 11	1, 6, 11	DSSS	DBPSK	1
802.11g	1 to 11	1, 6, 11	OFDM	BPSK	6
For 2.4 GHz 802.11n (HT20)	1 to 11	1, 6, 11	OFDM	BPSK	6.5
For 2.4 GHz 802.11n (HT40)	3 to 9	3, 6, 9	OFDM	BPSK	13.5
802.11a	149 to 165	149, 157, 165	OFDM	BPSK	6
For 5 GHz 802.11n (HT20)	149 to 165	149, 157, 165	OFDM	BPSK	6.5
For 5 GHz 802.11n (HT40)	151 to 159	151, 159	OFDM	BPSK	13.5
For 5 GHz 802.11ac (VHT80)	155	155	OFDM	BPSK	58.5

TEST CONDITION:

APPLICABLE TO	ENVIRONMENTAL CONDITIONS	INPUT POWER	TESTED BY
PLC	21deg. C, 60%RH	120Vac, 60Hz	Scott Chen
RE<1G	23deg. C, 66%RH	120Vac, 60Hz	Robert Cheng
RE ³ 1G	23deg. C, 69%RH	120Vac, 60Hz	Amos Chuang
APCM	25deg. C, 60%RH	120Vac, 60Hz	Amos Chuang
OB	25deg. C, 60%RH	120Vac, 60Hz	Amos Chuang

3.3 GENERAL DESCRIPTION OF APPLIED STANDARDS

The EUT is a RF product. According to the specifications of the manufacturer, it must comply with the requirements of the following standards:

FCC Part 15, Subpart C. (15.247)

558074 D01 DTS Meas Guidance v02

662911 D01 Multiple Transmitter Output v01 r02

ANSI C63.10-2009

All test items have been performed and recorded as per the above standards.

Note: The EUT has been verified to comply with the requirements of FCC Part 15, Subpart B, Class B (DoC). The test report has been issued separately.



A D T

3.4 DESCRIPTION OF SUPPORT UNITS

The EUT has been tested as an independent unit together with other necessary accessories or support units. The following support units or accessories were used to form a representative test configuration during the tests.

NO.	PRODUCT	BRAND	MODEL NO.	SERIAL NO.	FCC ID
1	NOTEBOOK COMPUTER	DELL	PP32LA	FSLB32S	FCC DoC
2	NOTEBOOK COMPUTER	DELL	PP32LA	GSLB32S	FCC DoC
3	HUB	ZyXEL	ES-116P	S060H0200021 5	FCC DoC
4	iPod shuffle	Apple	MC749TA/A	CC4DMFJUDFD M	NA

NO.	SIGNAL CABLE DESCRIPTION OF THE ABOVE SUPPORT UNITS
1	UTP cable, 10m
2	UTP cable, 10m
3	UTP cable, 10m
4	USB cable, 0.1m

NOTE: All power cords of the above support units are non shielded (1.8m).

3.5 CONFIGURATION OF SYSTEM UNDER TEST

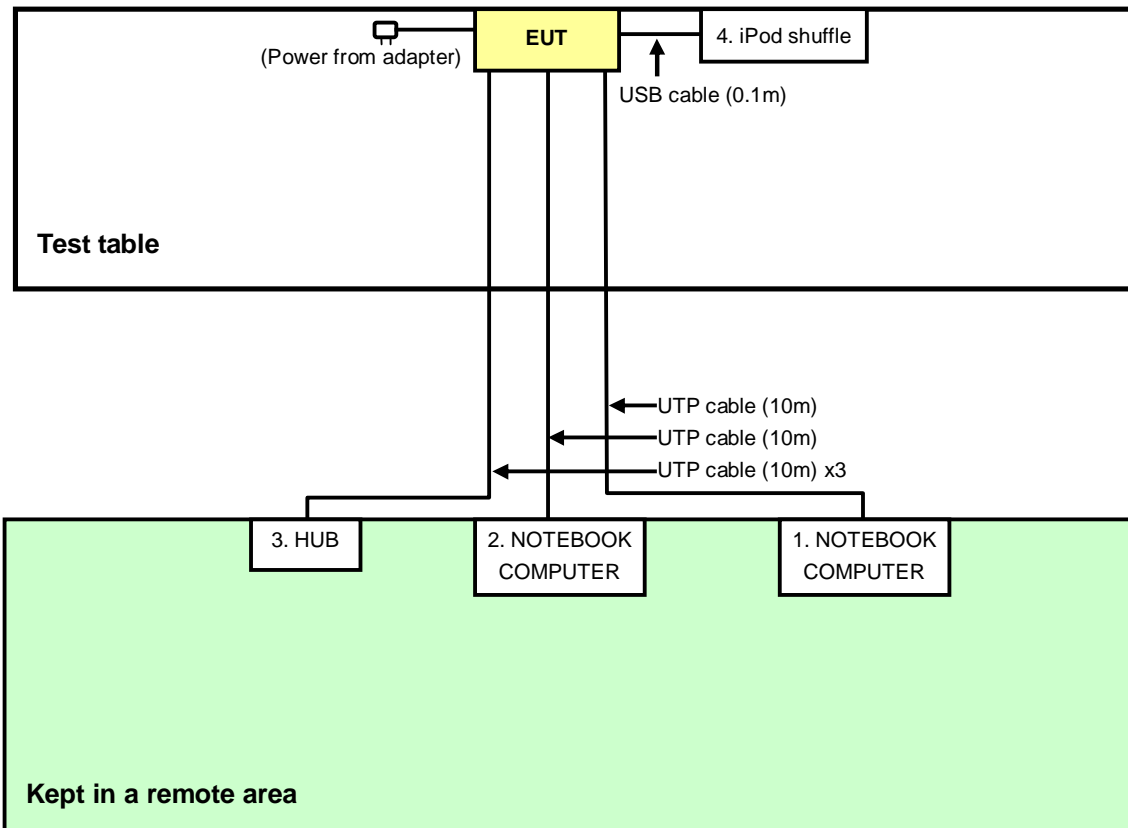

4. TEST TYPES AND RESULTS (FOR 2.4GHz, 2.400 ~ 2.4835GHz Band)

4.1 CONDUCTED EMISSION MEASUREMENT

4.1.1 LIMITS OF CONDUCTED EMISSION MEASUREMENT

FREQUENCY OF EMISSION (MHz)	CONDUCTED LIMIT (dB μ V)	
	Quasi-peak	Average
0.15-0.5	66 to 56	56 to 46
0.5-5	56	46
5-30	60	50

- NOTE:**
1. The lower limit shall apply at the transition frequencies.
 2. The limit decreases in line with the logarithm of the frequency in the range of 0.15 to 0.50 MHz.

4.1.2 TEST INSTRUMENTS

DESCRIPTION & MANUFACTURER	MODEL NO.	SERIAL NO.	CALIBRATED DATE	CALIBRATED UNTIL
Test Receiver	ESCS 30	100375	Mar. 12, 2012	Mar.11, 2013
Line-Impedance Stabilization Network (for EUT) SCHWARZBECK	NSLK8127	8127-522	Sep. 06, 2012	Sep. 05, 2013
Line-Impedance Stabilization Network (for Peripheral)	ENV216	100072	June 08,2012	June 07,2013
RF Cable (JYEBAO)	5DFB	COCCAB-001	Aug. 28, 2012	Aug. 27, 2013
50 ohms Terminator	50	EMC-3	Sep. 25, 2012	Sep. 24, 2013
Software ADT	BV ADT_Cond_V7.3.7.3	NA	NA	NA

Note:

1. The calibration interval of the above test instruments is 12 months and the calibrations are traceable to NML/ROC and NIST/USA.
2. The test was performed in Shielded Room No. C.
- 3 The VCCI Con C Registration No. is C-3611.
- 4 Tested Date: Feb. 08, 2013

4.1.3 TEST PROCEDURES

- a. The EUT was placed 0.4 meters from the conducting wall of the shielded room with EUT being connected to the power mains through a line impedance stabilization network (LISN). Other support units were connected to the power mains through another LISN.
- b. The two LISNs provide 50 ohm/ 50uH of coupling impedance for the measuring instrument.
- c. Both lines of the power mains connected to the EUT were checked for maximum conducted interference.
- d. The frequency range from 150kHz to 30MHz was searched. Emission levels under (Limit - 20dB) were not recorded.

NOTE:

1. The resolution bandwidth of test receiver is 9kHz for Quasi-peak detection (QP) & Average detection (AV).

4.1.4 DEVIATION FROM TEST STANDARD

No deviation

4.1.5 TEST SETUP

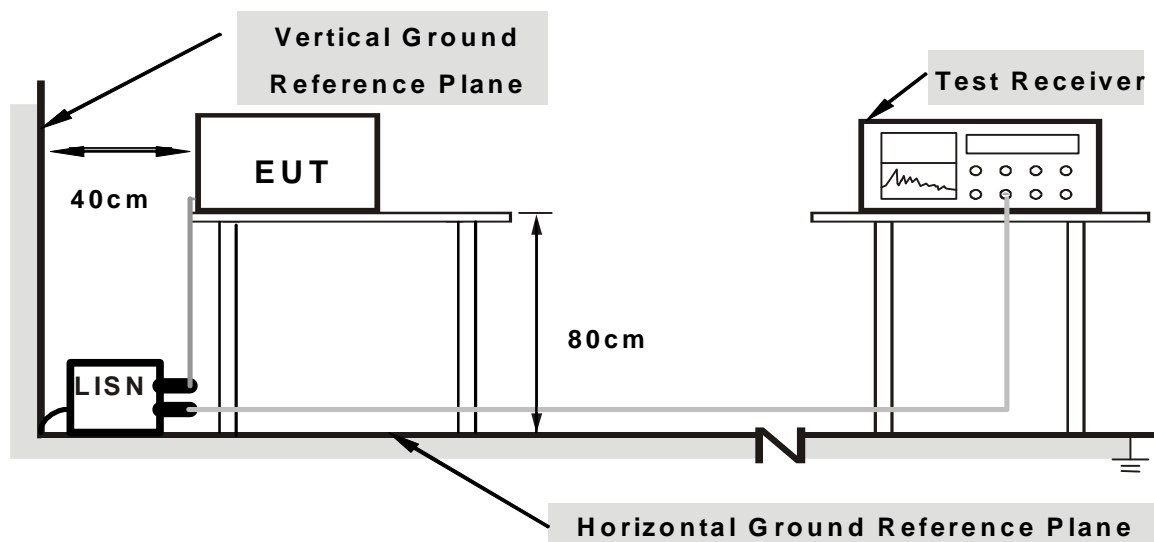

Note: 1. Support units were connected to second LISN.

For the actual test configuration, please refer to the related item – Photographs of the Test Configuration.

4.1.6 EUT OPERATING CONDITIONS

1. Connect the EUT with the support unit 1 (Notebook Computer) which is placed on a table in control room.
2. The communication partner run test program “MP TEST.exe (RTL819x 2.2.5)” to enable EUT under transmission/receiving condition continuously at specific channel frequency.

4.1.7 TEST RESULTS (MODE 1)

PHASE	Line (L)	DETECTOR FUNCTION	Quasi-Peak (QP) / Average (AV)
--------------	----------	--------------------------	--------------------------------

No	Freq. [MHz]	Corr. Factor (dB)	Reading Value [dB (uV)]		Emission Level [dB (uV)]		Limit [dB (uV)]		Margin (dB)	
			Q.P.	AV.	Q.P.	AV.	Q.P.	AV.	Q.P.	AV.
			1	0.15391	0.11	48.25	41.78	48.36	41.89	65.79
2	0.20469	0.12	39.27	28.84	39.39	28.96	63.42	53.42	-24.03	-24.46
3	0.41953	0.16	32.34	25.03	32.50	25.19	57.46	47.46	-24.96	-22.27
4	0.57969	0.17	25.55	18.60	25.72	18.77	56.00	46.00	-30.28	-27.23
5	3.86719	0.27	21.48	16.82	21.75	17.09	56.00	46.00	-34.25	-28.91
6	11.14453	0.60	26.17	21.19	26.77	21.79	60.00	50.00	-33.23	-28.21

REMARKS:

1. Q.P. and AV. are abbreviations of quasi-peak and average individually.
2. The emission levels of other frequencies were very low against the limit.
3. Margin value = Emission level - Limit value
4. Correction factor = Insertion loss + Cable loss
5. Emission Level = Correction Factor + Reading Value.

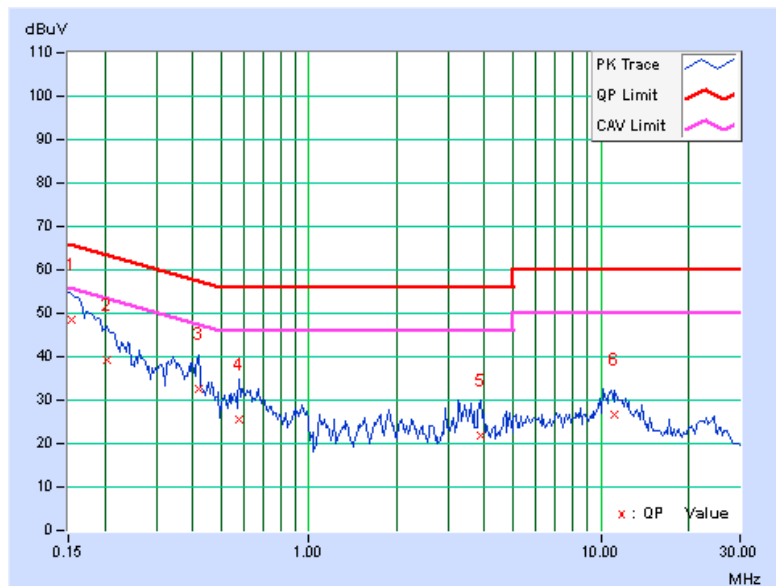

PHASE	Neutral (N)	DETECTOR FUNCTION	Quasi-Peak (QP) / Average (AV)
--------------	-------------	--------------------------	--------------------------------

No	Freq. [MHz]	Corr. Factor (dB)	Reading Value [dB (uV)]		Emission Level [dB (uV)]		Limit [dB (uV)]		Margin (dB)	
			Q.P.	AV.	Q.P.	AV.	Q.P.	AV.	Q.P.	AV.
	1	0.16172	0.09	51.42	41.86	51.51	41.95	65.38	55.38	-13.87
2	0.24375	0.11	40.07	32.44	40.18	32.55	61.97	51.97	-21.79	-19.42
3	0.38828	0.15	34.13	28.21	34.28	28.36	58.10	48.10	-23.82	-19.74
4	0.90781	0.17	24.74	20.75	24.91	20.92	56.00	46.00	-31.09	-25.08
5	3.66016	0.23	23.77	17.77	24.00	18.00	56.00	46.00	-32.00	-28.00
6	5.83203	0.29	21.81	16.91	22.10	17.20	60.00	50.00	-37.90	-32.80

REMARKS:

1. Q.P. and AV. are abbreviations of quasi-peak and average individually.
2. The emission levels of other frequencies were very low against the limit.
3. Margin value = Emission level - Limit value
4. Correction factor = Insertion loss + Cable loss
5. Emission Level = Correction Factor + Reading Value.

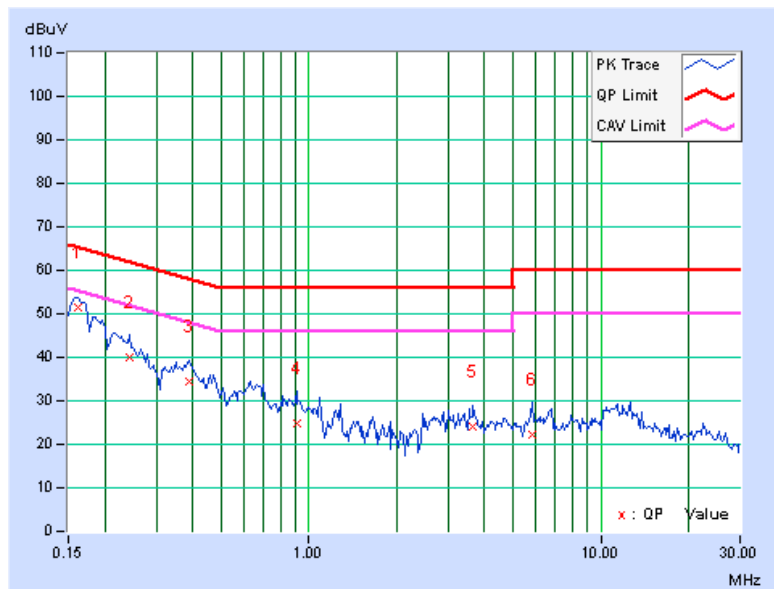



A D T

4.1.8 TEST RESULTS (MODE 2)

PHASE	Line (L)	DETECTOR FUNCTION	Quasi-Peak (QP) / Average (AV)
--------------	----------	--------------------------	--------------------------------

No	Freq. [MHz]	Corr. Factor (dB)	Reading Value [dB (uV)]		Emission Level [dB (uV)]		Limit [dB (uV)]		Margin (dB)	
			Q.P.	AV.	Q.P.	AV.	Q.P.	AV.	Q.P.	AV.
	1	0.17344	0.11	45.01	33.28	45.12	33.39	64.79	54.79	-19.67
2	0.22422	0.12	40.90	24.30	41.02	24.42	62.66	52.66	-21.64	-28.24
3	0.34531	0.15	39.75	27.34	39.90	27.49	59.07	49.07	-19.18	-21.59
4	0.92734	0.19	28.96	21.99	29.15	22.18	56.00	46.00	-26.85	-23.82
5	8.64453	0.49	32.32	27.09	32.81	27.58	60.00	50.00	-27.19	-22.42
6	15.17578	0.75	28.57	22.91	29.32	23.66	60.00	50.00	-30.68	-26.34

REMARKS:

1. Q.P. and AV. are abbreviations of quasi-peak and average individually.
2. The emission levels of other frequencies were very low against the limit.
3. Margin value = Emission level - Limit value
4. Correction factor = Insertion loss + Cable loss
5. Emission Level = Correction Factor + Reading Value.

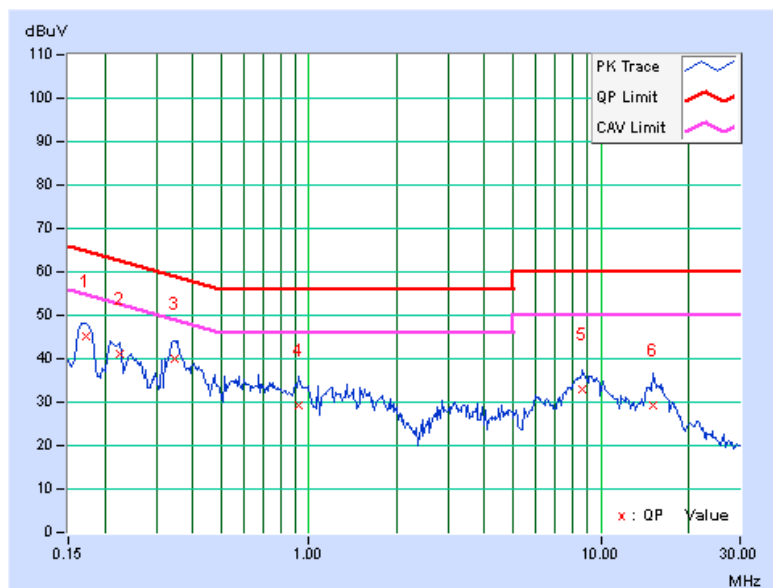

PHASE	Neutral (N)	DETECTOR FUNCTION	Quasi-Peak (QP) / Average (AV)
--------------	-------------	--------------------------	--------------------------------

No	Freq. [MHz]	Corr. Factor (dB)	Reading Value [dB (uV)]		Emission Level [dB (uV)]		Limit [dB (uV)]		Margin (dB)	
			Q.P.	AV.	Q.P.	AV.	Q.P.	AV.	Q.P.	AV.
	1	0.17344	0.09	44.38	33.55	44.47	33.64	64.79	54.79	-20.32
2	0.20859	0.10	39.29	28.28	39.39	28.38	63.26	53.26	-23.87	-24.88
3	0.34531	0.14	37.11	25.56	37.25	25.70	59.07	49.07	-21.83	-23.38
4	0.59141	0.16	26.81	17.89	26.97	18.05	56.00	46.00	-29.03	-27.95
5	1.68750	0.20	29.10	23.72	29.30	23.92	56.00	46.00	-26.70	-22.08
6	10.19922	0.42	35.20	30.60	35.62	31.02	60.00	50.00	-24.38	-18.98

REMARKS:

1. Q.P. and AV. are abbreviations of quasi-peak and average individually.
2. The emission levels of other frequencies were very low against the limit.
3. Margin value = Emission level - Limit value
4. Correction factor = Insertion loss + Cable loss
5. Emission Level = Correction Factor + Reading Value.

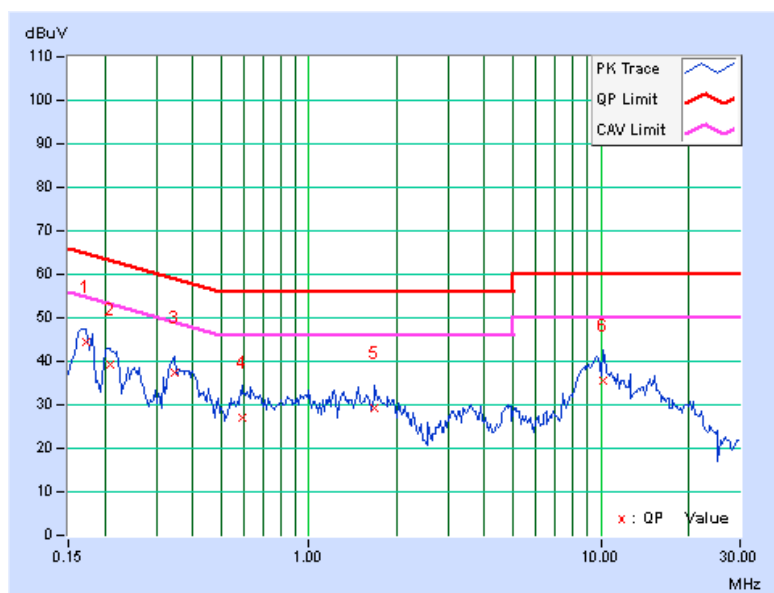

4.2 RADIATED EMISSION AND BANDEGE MEASUREMENT

4.2.1 LIMITS OF RADIATED EMISSION AND BANDEGE MEASUREMENT

Radiated emissions which fall in the restricted bands must comply with the radiated emission limits specified as below table. Other emissions shall be at least 30dB below the highest level of the desired power:

Frequencies (MHz)	Field strength (microvolts/meter)	Measurement distance (meters)
0.009-0.490	2400/F(kHz)	300
0.490-1.705	24000/F(kHz)	30
1.705-30.0	30	30
30-88	100	3
88-216	150	3
216-960	200	3
Above 960	500	3

NOTE:

1. The lower limit shall apply at the transition frequencies.
2. Emission level (dBuV/m) = 20 log Emission level (uV/m).
3. For frequencies above 1000MHz, the field strength limits are based on average detector, however, the peak field strength of any emission shall not exceed the maximum permitted average limits, specified above by more than 20dB under any condition of modulation.



A D T

4.2.2 TEST INSTRUMENTS

DESCRIPTION & MANUFACTURER	MODEL NO.	SERIAL NO.	CALIBRATED DATE	CALIBRATED UNTIL
Spectrum Analyzer Agilent	E4446A	MY48250254	July 09, 2012	July 08, 2013
Pre-Selector Agilent	N9039A	MY46520311	July 09, 2012	July 08, 2013
Signal Generator Agilent	N5181A	MY49060517	July 09, 2012	July 08, 2013
Pre-Amplifier Mini-Circuits	ZFL-1000VH2 B	AMP-ZFL-03	Nov. 14, 2012	Nov. 13, 2013
Pre-Amplifier Agilent	8449B	3008A02578	June 26, 2012	June 25, 2013
Pre-Amplifier SPACEK LABS	SLKKa-48-6	9K16	Nov. 14, 2012	Nov. 13, 2013
Trilog Broadband Antenna SCHWARZBECK	VULB 9168	9168-360	Apr. 09, 2012	Apr. 08, 2013
Horn_Antenna AISI	AIH.8018	0000320091110	Nov. 19, 2012	Nov. 18, 2013
Horn_Antenna SCHWARZBECK	BBHA 9170	9170-424	Oct. 12, 2012	Oct. 11, 2013
RF Cable	NA	RF104-201 RF104-203 RF104-204	Dec. 25, 2012	Dec. 24, 2013
RF Cable	NA	CHGCAB_001	Oct. 06, 2012	Oct. 05, 2013
Software	ADT_Radiated _V8.7.05	NA	NA	NA
Antenna Tower & Turn Table CT	NA	NA	NA	NA

Note:

1. The calibration interval of the above test instruments is 12 months and the calibrations are traceable to NML/ROC and NIST/USA.
2. The horn antenna, preamplifier (model: 8449B) are used only for the measurement of emission frequency above 1GHz if tested.
3. The test was performed in 966 Chamber No. G.
4. The FCC Site Registration No. is 966073.
5. The VCCI Site Registration No. is G-137.
6. The CANADA Site Registration No. is IC 7450H-2.
7. Tested Date: Feb. 19, 2013

4.2.3 TEST PROCEDURES

- a. The EUT was placed on the top of a rotating table 0.8 meters above the ground at 3 meter chamber room for test. The table was rotated 360 degrees to determine the position of the highest radiation.
- b. The EUT was set 3 meters away from the interference-receiving antenna, which was mounted on the top of a variable-height antenna tower.
- c. The height of antenna is varied from one meter to four meters above the ground to determine the maximum value of the field strength. Both horizontal and vertical polarizations of the antenna are set to make the measurement.
- d. For each suspected emission, the EUT was arranged to its worst case and then the antenna was tuned to heights from 1 meter to 4 meters and the rotatable table was turned from 0 degrees to 360 degrees to find the maximum reading.
- e. The test-receiver system was set to quasi-peak detect function and specified bandwidth with maximum hold mode when the test frequency is below 1 GHz.
- f. The test-receiver system was set to peak and average detect function and specified bandwidth with maximum hold mode when the test frequency is above 1 GHz. If the peak reading value also meets average limit, measurement with the average detector is unnecessary.

NOTE:

1. The resolution bandwidth and video bandwidth of test receiver/spectrum analyzer is 120kHz for Quasi-peak detection (QP) at frequency below 1GHz.
2. The resolution bandwidth of test receiver/spectrum analyzer is 1 MHz and the video bandwidth is 3 MHz for Peak detection (PK) at frequency above 1GHz.
3. The resolution bandwidth of test receiver/spectrum analyzer is 1 MHz and the video bandwidth is 10 Hz for Average detection (AV) at frequency above 1GHz.
4. All modes of operation were investigated and the worst-case emissions are reported.

4.2.4 DEVIATION FROM TEST STANDARD

No deviation

4.2.5 TEST SETUP

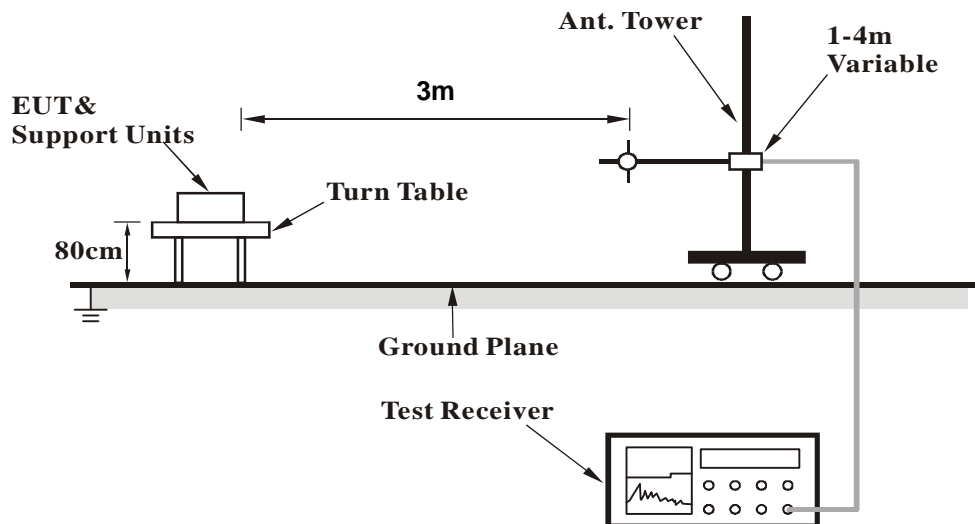

For the actual test configuration, please refer to the related item – Photographs of the Test Configuration.

4.2.6 EUT OPERATING CONDITIONS

Same as 4.1.6

4.2.7 TEST RESULTS

BELOW 1GHz WORST-CASE DATA

802.11b

CHANNEL	TX Channel 6	DETECTOR FUNCTION	Quasi-Peak (QP)
FREQUENCY RANGE	Below 1GHz		

ANTENNA POLARITY & TEST DISTANCE: HORIZONTAL AT 3 M								
NO.	FREQ. (MHz)	EMISSION LEVEL (dBuV/m)	LIMIT (dBuV/m)	MARGIN (dB)	ANTENNA HEIGHT (m)	TABLE ANGLE (Degree)	RAW VALUE (dBuV)	CORRECTION FACTOR (dB/m)
1	55.93	28.8 QP	40.0	-11.2	1.00 H	54	14.98	13.83
2	159.79	32.7 QP	43.5	-10.8	2.00 H	245	18.37	14.34
3	187.03	35.2 QP	43.5	-8.3	2.00 H	263	22.90	12.33
4	214.74	32.7 QP	43.5	-10.8	1.50 H	256	20.88	11.81
5	291.60	32.3 QP	46.0	-13.7	1.00 H	42	17.33	14.96
6	500.02	32.0 QP	46.0	-14.0	1.50 H	323	11.62	20.39
ANTENNA POLARITY & TEST DISTANCE: VERTICAL AT 3 M								
NO.	FREQ. (MHz)	EMISSION LEVEL (dBuV/m)	LIMIT (dBuV/m)	MARGIN (dB)	ANTENNA HEIGHT (m)	TABLE ANGLE (Degree)	RAW VALUE (dBuV)	CORRECTION FACTOR (dB/m)
1	37.28	31.5 QP	40.0	-8.5	1.00 V	298	18.10	13.41
2	93.00	31.3 QP	43.5	-12.2	1.50 V	295	22.36	8.98
3	187.38	31.9 QP	43.5	-11.6	1.00 V	280	19.59	12.30
4	228.00	31.1 QP	46.0	-14.9	1.00 V	8	18.67	12.39
5	624.96	28.5 QP	46.0	-17.5	1.50 V	334	5.49	22.97
6	750.01	29.4 QP	46.0	-16.6	1.50 V	282	4.52	24.91

REMARKS:

1. Emission level (dBuV/m) = Raw Value (dBuV) + Correction Factor (dB/m).
2. Correction Factor (dB/m) = Antenna Factor (dB/m) + Cable Factor (dB).
3. The other emission levels were very low against the limit.
4. Margin value = Emission level – Limit value.



A D T

ABOVE 1GHz DATA

802.11b

CHANNEL	TX Channel 1	DETECTOR FUNCTION	Peak (PK)
FREQUENCY RANGE	1GHz ~ 25GHz		Average (AV)

ANTENNA POLARITY & TEST DISTANCE: HORIZONTAL AT 3 M

NO.	FREQ. (MHz)	EMISSION LEVEL (dBuV/m)	LIMIT (dBuV/m)	MARGIN (dB)	ANTENNA HEIGHT (m)	TABLE ANGLE (Degree)	RAW VALUE (dBuV)	CORRECTION FACTOR (dB/m)
1	2390.00	61.9 PK	74.0	-12.1	1.00 H	140	29.12	32.78
2	2390.00	53.2 AV	54.0	-0.8	1.00 H	140	20.42	32.78
3	*2412.00	111.4 PK			1.02 H	161	78.56	32.84
4	*2412.00	108.7 AV			1.02 H	161	75.86	32.84
5	2483.50	61.9 PK	74.0	-12.1	1.21 H	156	28.87	33.03
6	2483.50	51.9 AV	54.0	-2.1	1.21 H	156	18.87	33.03
7	4824.00	51.3 PK	74.0	-22.7	1.49 H	99	9.03	42.27
8	4824.00	43.2 AV	54.0	-10.8	1.49 H	99	0.93	42.27

ANTENNA POLARITY & TEST DISTANCE: VERTICAL AT 3 M

NO.	FREQ. (MHz)	EMISSION LEVEL (dBuV/m)	LIMIT (dBuV/m)	MARGIN (dB)	ANTENNA HEIGHT (m)	TABLE ANGLE (Degree)	RAW VALUE (dBuV)	CORRECTION FACTOR (dB/m)
1	2390.00	58.6 PK	74.0	-15.4	1.05 V	145	25.82	32.78
2	2390.00	50.1 AV	54.0	-3.9	1.05 V	145	17.32	32.78
3	*2412.00	108.4 PK			1.04 V	140	75.56	32.84
4	*2412.00	106.7 AV			1.04 V	140	73.86	32.84
5	4824.00	48.5 PK	74.0	-25.5	1.00 V	153	6.23	42.27
6	4824.00	37.1 AV	54.0	-16.9	1.00 V	153	-5.17	42.27

REMARKS:

1. Emission level (dBuV/m) = Raw Value (dBuV) + Correction Factor (dB/m).
2. Correction Factor (dB/m) = Antenna Factor (dB/m) + Cable Factor (dB).
3. The other emission levels were very low against the limit.
4. Margin value = Emission level – Limit value.
5. " * ": Fundamental frequency.



A D T

CHANNEL	TX Channel 6	DETECTOR FUNCTION	Peak (PK)
FREQUENCY RANGE	1GHz ~ 25GHz		Average (AV)

ANTENNA POLARITY & TEST DISTANCE: HORIZONTAL AT 3 M

NO.	FREQ. (MHz)	EMISSION LEVEL (dBuV/m)	LIMIT (dBuV/m)	MARGIN (dB)	ANTENNA HEIGHT (m)	TABLE ANGLE (Degree)	RAW VALUE (dBuV)	CORRECTION FACTOR (dB/m)
1	2390.00	59.9 PK	74.0	-14.1	1.00 H	158	27.12	32.78
2	2390.00	48.6 AV	54.0	-5.4	1.00 H	158	15.82	32.78
3	*2437.00	117.2 PK			1.00 H	158	84.29	32.91
4	*2437.00	114.9 AV			1.00 H	158	81.99	32.91
5	2483.50	60.9 PK	74.0	-13.1	1.00 H	158	27.87	33.03
6	2483.50	48.7 AV	54.0	-5.3	1.00 H	158	15.67	33.03
7	4874.00	50.9 PK	74.0	-23.1	1.13 H	109	8.58	42.32
8	4874.00	41.6 AV	54.0	-12.4	1.13 H	109	-0.72	42.32
9	7311.00	57.3 PK	74.0	-16.7	1.26 H	70	10.35	46.95
10	7311.00	50.1 AV	54.0	-3.9	1.26 H	70	3.15	46.95

ANTENNA POLARITY & TEST DISTANCE: VERTICAL AT 3 M

NO.	FREQ. (MHz)	EMISSION LEVEL (dBuV/m)	LIMIT (dBuV/m)	MARGIN (dB)	ANTENNA HEIGHT (m)	TABLE ANGLE (Degree)	RAW VALUE (dBuV)	CORRECTION FACTOR (dB/m)
1	2390.00	58.2 PK	74.0	-15.8	1.06 V	141	25.42	32.78
2	2390.00	46.3 AV	54.0	-7.7	1.06 V	141	13.52	32.78
3	*2437.00	111.6 PK			1.06 V	141	78.69	32.91
4	*2437.00	109.4 AV			1.06 V	141	76.49	32.91
5	2483.50	58.8 PK	74.0	-15.2	1.06 V	141	25.77	33.03
6	2483.50	46.4 AV	54.0	-7.6	1.06 V	141	13.37	33.03
7	4874.00	50.9 PK	74.0	-23.1	1.11 V	131	8.58	42.32
8	4874.00	37.5 AV	54.0	-16.5	1.11 V	131	-4.82	42.32
9	7311.00	55.6 PK	74.0	-18.4	1.12 V	125	8.65	46.95
10	7311.00	43.5 AV	54.0	-10.5	1.12 V	125	-3.45	46.95

REMARKS:

1. Emission level (dBuV/m) = Raw Value (dBuV) + Correction Factor (dB/m).
2. Correction Factor (dB/m) = Antenna Factor (dB/m) + Cable Factor (dB).
3. The other emission levels were very low against the limit.
4. Margin value = Emission level – Limit value.
5. " * ": Fundamental frequency.



CHANNEL	TX Channel 11	DETECTOR FUNCTION	Peak (PK)
FREQUENCY RANGE	1GHz ~ 25GHz		Average (AV)

ANTENNA POLARITY & TEST DISTANCE: HORIZONTAL AT 3 M								
NO.	FREQ. (MHz)	EMISSION LEVEL (dBuV/m)	LIMIT (dBuV/m)	MARGIN (dB)	ANTENNA HEIGHT (m)	TABLE ANGLE (Degree)	RAW VALUE (dBuV)	CORRECTION FACTOR (dB/m)
1	*2462.00	111.8 PK			1.00 H	158	78.83	32.97
2	*2462.00	109.5 AV			1.00 H	158	76.53	32.97
3	2483.50	60.8 PK	74.0	-13.2	1.00 H	158	27.77	33.03
4	2483.50	53.1 AV	54.0	-0.9	1.00 H	158	20.07	33.03
5	4924.00	48.9 PK	74.0	-25.1	1.11 H	107	6.58	42.32
6	4924.00	40.9 AV	54.0	-13.1	1.11 H	107	-1.42	42.32
7	7386.00	50.5 PK	74.0	-23.5	1.00 H	155	3.31	47.19
8	7386.00	38.4 AV	54.0	-15.6	1.00 H	155	-8.79	47.19

ANTENNA POLARITY & TEST DISTANCE: VERTICAL AT 3 M								
NO.	FREQ. (MHz)	EMISSION LEVEL (dBuV/m)	LIMIT (dBuV/m)	MARGIN (dB)	ANTENNA HEIGHT (m)	TABLE ANGLE (Degree)	RAW VALUE (dBuV)	CORRECTION FACTOR (dB/m)
1	*2462.00	109.6 PK			1.08 V	140	76.63	32.97
2	*2462.00	107.6 AV			1.08 V	140	74.63	32.97
3	2483.50	61.8 PK	74.0	-12.2	1.04 V	145	28.77	33.03
4	2483.50	52.4 AV	54.0	-1.6	1.04 V	145	19.37	33.03
5	4924.00	50.6 PK	74.0	-23.4	1.11 V	130	8.28	42.32
6	4924.00	37.1 AV	54.0	-16.9	1.11 V	130	-5.22	42.32
7	7386.00	55.1 PK	74.0	-18.9	1.12 V	124	7.91	47.19
8	7386.00	43.1 AV	54.0	-10.9	1.12 V	124	-4.09	47.19

REMARKS:

1. Emission level (dBuV/m) = Raw Value (dBuV) + Correction Factor (dB/m).
2. Correction Factor (dB/m) = Antenna Factor (dB/m) + Cable Factor (dB).
3. The other emission levels were very low against the limit.
4. Margin value = Emission level – Limit value.
5. " * " : Fundamental frequency.



A D T

802.11g

CHANNEL	TX Channel 1	DETECTOR FUNCTION	Peak (PK)
FREQUENCY RANGE	1GHz ~ 25GHz		Average (AV)

ANTENNA POLARITY & TEST DISTANCE: HORIZONTAL AT 3 M

NO.	FREQ. (MHz)	EMISSION LEVEL (dBuV/m)	LIMIT (dBuV/m)	MARGIN (dB)	ANTENNA HEIGHT (m)	TABLE ANGLE (Degree)	RAW VALUE (dBuV)	CORRECTION FACTOR (dB/m)
1	2390.00	69.7 PK	74.0	-4.3	1.00 H	138	36.92	32.78
2	2390.00	53.3 AV	54.0	-0.7	1.00 H	138	20.52	32.78
3	*2412.00	111.3 PK			1.00 H	161	78.46	32.84
4	*2412.00	100.2 AV			1.00 H	161	67.36	32.84
5	4824.00	49.6 PK	74.0	-24.4	1.12 H	86	7.33	42.27
6	4824.00	41.3 AV	54.0	-12.7	1.12 H	86	-0.97	42.27

ANTENNA POLARITY & TEST DISTANCE: VERTICAL AT 3 M

NO.	FREQ. (MHz)	EMISSION LEVEL (dBuV/m)	LIMIT (dBuV/m)	MARGIN (dB)	ANTENNA HEIGHT (m)	TABLE ANGLE (Degree)	RAW VALUE (dBuV)	CORRECTION FACTOR (dB/m)
1	2390.00	59.8 PK	74.0	-14.2	1.10 V	140	27.02	32.78
2	2390.00	47.1 AV	54.0	-6.9	1.10 V	140	14.32	32.78
3	*2412.00	105.5 PK			1.10 V	140	72.66	32.84
4	*2412.00	96.6 AV			1.10 V	140	63.76	32.84
5	4824.00	49.6 PK	74.0	-24.4	1.13 V	142	7.33	42.27
6	4824.00	36.9 AV	54.0	-17.1	1.13 V	142	-5.37	42.27

REMARKS:

1. Emission level (dBuV/m) = Raw Value (dBuV) + Correction Factor (dB/m).
2. Correction Factor (dB/m) = Antenna Factor (dB/m) + Cable Factor (dB).
3. The other emission levels were very low against the limit.
4. Margin value = Emission level – Limit value.
5. " * ": Fundamental frequency.



A D T

CHANNEL	TX Channel 6	DETECTOR FUNCTION	Peak (PK)
FREQUENCY RANGE	1GHz ~ 25GHz		Average (AV)

ANTENNA POLARITY & TEST DISTANCE: HORIZONTAL AT 3 M

NO.	FREQ. (MHz)	EMISSION LEVEL (dBuV/m)	LIMIT (dBuV/m)	MARGIN (dB)	ANTENNA HEIGHT (m)	TABLE ANGLE (Degree)	RAW VALUE (dBuV)	CORRECTION FACTOR (dB/m)
1	2390.00	60.5 PK	74.0	-13.5	1.00 H	143	27.72	32.78
2	2390.00	48.4 AV	54.0	-5.6	1.00 H	143	15.62	32.78
3	*2437.00	114.0 PK			1.00 H	145	81.09	32.91
4	*2437.00	105.0 AV			1.00 H	145	72.09	32.91
5	2483.50	59.3 PK	74.0	-14.7	1.06 H	152	26.27	33.03
6	2483.50	48.3 AV	54.0	-5.7	1.06 H	152	15.27	33.03
7	4874.00	50.8 PK	74.0	-23.2	1.17 H	114	8.48	42.32
8	4874.00	41.5 AV	54.0	-12.5	1.17 H	114	-0.82	42.32
9	7311.00	51.5 PK	74.0	-22.5	1.00 H	149	4.55	46.95
10	7311.00	38.8 AV	54.0	-15.2	1.00 H	149	-8.15	46.95

ANTENNA POLARITY & TEST DISTANCE: VERTICAL AT 3 M

NO.	FREQ. (MHz)	EMISSION LEVEL (dBuV/m)	LIMIT (dBuV/m)	MARGIN (dB)	ANTENNA HEIGHT (m)	TABLE ANGLE (Degree)	RAW VALUE (dBuV)	CORRECTION FACTOR (dB/m)
1	2390.00	59.1 PK	74.0	-14.9	1.09 V	145	26.32	32.78
2	2390.00	46.3 AV	54.0	-7.7	1.09 V	145	13.52	32.78
3	*2437.00	110.3 PK			1.10 V	141	77.39	32.91
4	*2437.00	101.5 AV			1.10 V	141	68.59	32.91
5	2483.50	58.7 PK	74.0	-15.3	1.11 V	141	25.67	33.03
6	2483.50	46.1 AV	54.0	-7.9	1.11 V	141	13.07	33.03
7	4874.00	50.3 PK	74.0	-23.7	1.12 V	132	7.98	42.32
8	4874.00	37.4 AV	54.0	-16.6	1.12 V	132	-4.92	42.32
9	7311.00	55.7 PK	74.0	-18.3	1.11 V	125	8.75	46.95
10	7311.00	43.6 AV	54.0	-10.4	1.11 V	125	-3.35	46.95

REMARKS:

1. Emission level (dBuV/m) = Raw Value (dBuV) + Correction Factor (dB/m).
2. Correction Factor (dB/m) = Antenna Factor (dB/m) + Cable Factor (dB).
3. The other emission levels were very low against the limit.
4. Margin value = Emission level – Limit value.
5. " * ": Fundamental frequency.



A D T

CHANNEL	TX Channel 11	DETECTOR FUNCTION	Peak (PK)
FREQUENCY RANGE	1GHz ~ 25GHz		Average (AV)

ANTENNA POLARITY & TEST DISTANCE: HORIZONTAL AT 3 M

NO.	FREQ. (MHz)	EMISSION LEVEL (dBuV/m)	LIMIT (dBuV/m)	MARGIN (dB)	ANTENNA HEIGHT (m)	TABLE ANGLE (Degree)	RAW VALUE (dBuV)	CORRECTION FACTOR (dB/m)
1	*2462.00	111.2 PK			1.00 H	151	78.23	32.97
2	*2462.00	100.8 AV			1.00 H	151	67.83	32.97
3	2483.50	70.7 PK	74.0	-3.3	1.44 H	151	37.67	33.03
4	2483.50	53.1 AV	54.0	-0.9	1.44 H	151	20.07	33.03
5	4924.00	48.9 PK	74.0	-25.1	1.05 H	94	6.58	42.32
6	4924.00	41.1 AV	54.0	-12.9	1.05 H	94	-1.22	42.32
7	7386.00	51.0 PK	74.0	-23.0	1.02 H	143	3.81	47.19
8	7386.00	38.9 AV	54.0	-15.1	1.02 H	143	-8.29	47.19

ANTENNA POLARITY & TEST DISTANCE: VERTICAL AT 3 M

NO.	FREQ. (MHz)	EMISSION LEVEL (dBuV/m)	LIMIT (dBuV/m)	MARGIN (dB)	ANTENNA HEIGHT (m)	TABLE ANGLE (Degree)	RAW VALUE (dBuV)	CORRECTION FACTOR (dB/m)
1	*2462.00	106.1 PK			1.10 V	145	73.13	32.97
2	*2462.00	97.4 AV			1.10 V	145	64.43	32.97
3	2483.50	62.6 PK	74.0	-11.4	1.10 V	140	29.57	33.03
4	2483.50	48.5 AV	54.0	-5.5	1.10 V	140	15.47	33.03
5	4924.00	49.9 PK	74.0	-24.1	1.13 V	141	7.58	42.32
6	4924.00	37.1 AV	54.0	-16.9	1.13 V	141	-5.22	42.32
7	7386.00	55.2 PK	74.0	-18.8	1.11 V	126	8.01	47.19
8	7386.00	43.1 AV	54.0	-10.9	1.11 V	126	-4.09	47.19

REMARKS:

1. Emission level (dBuV/m) = Raw Value (dBuV) + Correction Factor (dB/m).
2. Correction Factor (dB/m) = Antenna Factor (dB/m) + Cable Factor (dB).
3. The other emission levels were very low against the limit.
4. Margin value = Emission level – Limit value.
5. " * ": Fundamental frequency.



A D T

802.11n (HT20)

CHANNEL	TX Channel 1	DETECTOR FUNCTION	Peak (PK)
FREQUENCY RANGE	1GHz ~ 25GHz		Average (AV)

ANTENNA POLARITY & TEST DISTANCE: HORIZONTAL AT 3 M

NO.	FREQ. (MHz)	EMISSION LEVEL (dBuV/m)	LIMIT (dBuV/m)	MARGIN (dB)	ANTENNA HEIGHT (m)	TABLE ANGLE (Degree)	RAW VALUE (dBuV)	CORRECTION FACTOR (dB/m)
1	2390.00	71.7 PK	74.0	-2.3	1.00 H	250	38.92	32.78
2	2390.00	53.1 AV	54.0	-0.9	1.00 H	250	20.32	32.78
3	*2412.00	110.9 PK			1.00 H	250	78.06	32.84
4	*2412.00	100.1 AV			1.00 H	250	67.26	32.84
5	4824.00	49.1 PK	74.0	-24.9	1.16 H	107	6.83	42.27
6	4824.00	41.2 AV	54.0	-12.8	1.16 H	107	-1.07	42.27

ANTENNA POLARITY & TEST DISTANCE: VERTICAL AT 3 M

NO.	FREQ. (MHz)	EMISSION LEVEL (dBuV/m)	LIMIT (dBuV/m)	MARGIN (dB)	ANTENNA HEIGHT (m)	TABLE ANGLE (Degree)	RAW VALUE (dBuV)	CORRECTION FACTOR (dB/m)
1	2390.00	59.1 PK	74.0	-14.9	1.10 V	140	26.32	32.78
2	2390.00	46.7 AV	54.0	-7.3	1.10 V	140	13.92	32.78
3	*2412.00	104.2 PK			1.04 V	140	71.36	32.84
4	*2412.00	95.2 AV			1.04 V	140	62.36	32.84
5	4824.00	50.1 PK	74.0	-23.9	1.13 V	140	7.83	42.27
6	4824.00	37.1 AV	54.0	-16.9	1.13 V	140	-5.17	42.27

REMARKS:

1. Emission level (dBuV/m) = Raw Value (dBuV) + Correction Factor (dB/m).
2. Correction Factor (dB/m) = Antenna Factor (dB/m) + Cable Factor (dB).
3. The other emission levels were very low against the limit.
4. Margin value = Emission level – Limit value.
5. " * ": Fundamental frequency.



A D T

CHANNEL	TX Channel 6	DETECTOR FUNCTION	Peak (PK)
FREQUENCY RANGE	1GHz ~ 25GHz		Average (AV)

ANTENNA POLARITY & TEST DISTANCE: HORIZONTAL AT 3 M

NO.	FREQ. (MHz)	EMISSION LEVEL (dBuV/m)	LIMIT (dBuV/m)	MARGIN (dB)	ANTENNA HEIGHT (m)	TABLE ANGLE (Degree)	RAW VALUE (dBuV)	CORRECTION FACTOR (dB/m)
1	2390.00	60.1 PK	74.0	-13.9	1.03 H	149	27.32	32.78
2	2390.00	48.0 AV	54.0	-6.0	1.03 H	149	15.22	32.78
3	*2437.00	116.1 PK			1.00 H	152	83.19	32.91
4	*2437.00	105.3 AV			1.00 H	152	72.39	32.91
5	2483.50	59.5 PK	74.0	-14.5	1.01 H	152	26.47	33.03
6	2483.50	48.2 AV	54.0	-5.8	1.01 H	152	15.17	33.03
7	4874.00	51.0 PK	74.0	-23.0	1.12 H	122	8.68	42.32
8	4874.00	38.5 AV	54.0	-15.5	1.12 H	122	-3.82	42.32
9	7311.00	57.6 PK	74.0	-16.4	1.00 H	145	10.65	46.95
10	7311.00	44.3 AV	54.0	-9.7	1.00 H	145	-2.65	46.95

ANTENNA POLARITY & TEST DISTANCE: VERTICAL AT 3 M

NO.	FREQ. (MHz)	EMISSION LEVEL (dBuV/m)	LIMIT (dBuV/m)	MARGIN (dB)	ANTENNA HEIGHT (m)	TABLE ANGLE (Degree)	RAW VALUE (dBuV)	CORRECTION FACTOR (dB/m)
1	2390.00	59.1 PK	74.0	-14.9	1.08 V	138	26.32	32.78
2	2390.00	45.8 AV	54.0	-8.2	1.08 V	138	13.02	32.78
3	*2437.00	109.9 PK			1.08 V	140	76.99	32.91
4	*2437.00	101.1 AV			1.08 V	140	68.19	32.91
5	2483.50	60.2 PK	74.0	-13.8	1.08 V	141	27.17	33.03
6	2483.50	46.1 AV	54.0	-7.9	1.08 V	141	13.07	33.03
7	4874.00	50.1 PK	74.0	-23.9	1.15 V	139	7.78	42.32
8	4874.00	37.8 AV	54.0	-16.2	1.15 V	139	-4.52	42.32
9	7311.00	56.1 PK	74.0	-17.9	1.14 V	141	9.15	46.95
10	7311.00	43.8 AV	54.0	-10.2	1.14 V	141	-3.15	46.95

REMARKS:

1. Emission level (dBuV/m) = Raw Value (dBuV) + Correction Factor (dB/m).
2. Correction Factor (dB/m) = Antenna Factor (dB/m) + Cable Factor (dB).
3. The other emission levels were very low against the limit.
4. Margin value = Emission level – Limit value.
5. " * ": Fundamental frequency.



A D T

CHANNEL	TX Channel 11	DETECTOR FUNCTION	Peak (PK)
FREQUENCY RANGE	1GHz ~ 25GHz		Average (AV)

ANTENNA POLARITY & TEST DISTANCE: HORIZONTAL AT 3 M

NO.	FREQ. (MHz)	EMISSION LEVEL (dBuV/m)	LIMIT (dBuV/m)	MARGIN (dB)	ANTENNA HEIGHT (m)	TABLE ANGLE (Degree)	RAW VALUE (dBuV)	CORRECTION FACTOR (dB/m)
1	*2462.00	111.0 PK			1.44 H	151	78.03	32.97
2	*2462.00	100.6 AV			1.44 H	151	67.63	32.97
3	2483.50	67.2 PK	74.0	-6.8	1.49 H	164	34.17	33.03
4	2483.50	53.5 AV	54.0	-0.5	1.49 H	164	20.47	33.03
5	4924.00	49.2 PK	74.0	-24.8	1.00 H	93	6.88	42.32
6	4924.00	36.5 AV	54.0	-17.5	1.00 H	93	-5.82	42.32
7	7386.00	51.5 PK	74.0	-22.5	1.03 H	146	4.31	47.19
8	7386.00	39.1 AV	54.0	-14.9	1.03 H	146	-8.09	47.19

ANTENNA POLARITY & TEST DISTANCE: VERTICAL AT 3 M

NO.	FREQ. (MHz)	EMISSION LEVEL (dBuV/m)	LIMIT (dBuV/m)	MARGIN (dB)	ANTENNA HEIGHT (m)	TABLE ANGLE (Degree)	RAW VALUE (dBuV)	CORRECTION FACTOR (dB/m)
1	*2462.00	104.2 PK			1.04 V	140	71.23	32.97
2	*2462.00	95.2 AV			1.04 V	140	62.23	32.97
3	2483.50	59.1 PK	74.0	-14.9	1.10 V	145	26.07	33.03
4	2483.50	47.1 AV	54.0	-6.9	1.10 V	145	14.07	33.03
5	4924.00	50.6 PK	74.0	-23.4	1.13 V	133	8.28	42.32
6	4924.00	37.4 AV	54.0	-16.6	1.13 V	133	-4.96	42.32
7	7386.00	55.3 PK	74.0	-18.7	1.14 V	136	8.11	47.19
8	7386.00	42.1 AV	54.0	-11.9	1.14 V	136	-5.09	47.19

REMARKS:

1. Emission level (dBuV/m) = Raw Value (dBuV) + Correction Factor (dB/m).
2. Correction Factor (dB/m) = Antenna Factor (dB/m) + Cable Factor (dB).
3. The other emission levels were very low against the limit.
4. Margin value = Emission level – Limit value.
5. " * " : Fundamental frequency.

802.11n (HT40)

CHANNEL	TX Channel 3	DETECTOR FUNCTION	Peak (PK)
FREQUENCY RANGE	1GHz ~ 25GHz		Average (AV)

ANTENNA POLARITY & TEST DISTANCE: HORIZONTAL AT 3 M

NO.	FREQ. (MHz)	EMISSION LEVEL (dBuV/m)	LIMIT (dBuV/m)	MARGIN (dB)	ANTENNA HEIGHT (m)	TABLE ANGLE (Degree)	RAW VALUE (dBuV)	CORRECTION FACTOR (dB/m)
1	2390.00	67.1 PK	74.0	-6.9	1.52 H	165	34.32	32.78
2	2390.00	53.3 AV	54.0	-0.7	1.52 H	165	20.52	32.78
3	*2422.00	102.7 PK			1.46 H	145	69.83	32.87
4	*2422.00	93.9 AV			1.46 H	145	61.03	32.87
5	4844.00	47.9 PK	74.0	-26.1	1.11 H	121	5.61	42.29
6	4844.00	36.1 AV	54.0	-17.9	1.11 H	121	-6.19	42.29
7	7266.00	50.6 PK	74.0	-23.4	1.10 H	119	3.79	46.81
8	7266.00	41.6 AV	54.0	-12.4	1.10 H	119	-5.21	46.81

ANTENNA POLARITY & TEST DISTANCE: VERTICAL AT 3 M

NO.	FREQ. (MHz)	EMISSION LEVEL (dBuV/m)	LIMIT (dBuV/m)	MARGIN (dB)	ANTENNA HEIGHT (m)	TABLE ANGLE (Degree)	RAW VALUE (dBuV)	CORRECTION FACTOR (dB/m)
1	2390.00	59.7 PK	74.0	-14.3	1.36 V	140	26.92	32.78
2	2390.00	48.2 AV	54.0	-5.8	1.36 V	140	15.42	32.78
3	*2422.00	100.3 PK			1.35 V	139	67.43	32.87
4	*2422.00	91.0 AV			1.35 V	139	58.13	32.87
5	4844.00	48.3 PK	74.0	-25.7	1.12 V	135	6.01	42.29
6	4844.00	36.2 AV	54.0	-17.8	1.12 V	135	-6.09	42.29
7	7266.00	51.1 PK	74.0	-22.9	1.09 V	141	4.29	46.81
8	7266.00	42.1 AV	54.0	-11.9	1.09 V	141	-4.71	46.81

REMARKS:

1. Emission level (dBuV/m) = Raw Value (dBuV) + Correction Factor (dB/m).
2. Correction Factor (dB/m) = Antenna Factor (dB/m) + Cable Factor (dB).
3. The other emission levels were very low against the limit.
4. Margin value = Emission level – Limit value.
5. " * ": Fundamental frequency.



A D T

CHANNEL	TX Channel 6	DETECTOR FUNCTION	Peak (PK)
FREQUENCY RANGE	1GHz ~ 25GHz		Average (AV)

ANTENNA POLARITY & TEST DISTANCE: HORIZONTAL AT 3 M

NO.	FREQ. (MHz)	EMISSION LEVEL (dBuV/m)	LIMIT (dBuV/m)	MARGIN (dB)	ANTENNA HEIGHT (m)	TABLE ANGLE (Degree)	RAW VALUE (dBuV)	CORRECTION FACTOR (dB/m)
1	*2437.00	105.0 PK			1.45 H	135	72.09	32.91
2	*2437.00	96.6 AV			1.45 H	135	63.69	32.91
3	2483.50	68.1 PK	74.0	-5.9	1.45 H	135	35.07	33.03
4	2483.50	53.1 AV	54.0	-0.9	1.45 H	135	20.07	33.03
5	4874.00	48.2 PK	74.0	-25.8	1.13 H	126	5.88	42.32
6	4874.00	36.2 AV	54.0	-17.8	1.13 H	126	-6.12	42.32
7	7311.00	50.3 PK	74.0	-23.7	1.13 H	111	3.35	46.95
8	7311.00	41.3 AV	54.0	-12.7	1.13 H	111	-5.65	46.95

ANTENNA POLARITY & TEST DISTANCE: VERTICAL AT 3 M

NO.	FREQ. (MHz)	EMISSION LEVEL (dBuV/m)	LIMIT (dBuV/m)	MARGIN (dB)	ANTENNA HEIGHT (m)	TABLE ANGLE (Degree)	RAW VALUE (dBuV)	CORRECTION FACTOR (dB/m)
1	*2437.00	101.8 PK			1.35 V	140	68.89	32.91
2	*2437.00	93.2 AV			1.35 V	140	60.29	32.91
3	2483.50	60.9 PK	74.0	-13.1	1.33 V	142	27.87	33.03
4	2483.50	49.3 AV	54.0	-4.7	1.33 V	142	16.27	33.03
5	4874.00	49.1 PK	74.0	-24.9	1.13 V	134	6.78	42.32
6	4874.00	36.5 AV	54.0	-17.5	1.13 V	134	-5.82	42.32
7	7311.00	51.3 PK	74.0	-22.7	1.10 V	121	4.35	46.95
8	7311.00	42.3 AV	54.0	-11.7	1.10 V	121	-4.65	46.95

REMARKS:

1. Emission level (dBuV/m) = Raw Value (dBuV) + Correction Factor (dB/m).
2. Correction Factor (dB/m) = Antenna Factor (dB/m) + Cable Factor (dB).
3. The other emission levels were very low against the limit.
4. Margin value = Emission level – Limit value.
5. " * ": Fundamental frequency.



A D T

CHANNEL	TX Channel 9	DETECTOR FUNCTION	Peak (PK)
FREQUENCY RANGE	1GHz ~ 25GHz		Average (AV)

ANTENNA POLARITY & TEST DISTANCE: HORIZONTAL AT 3 M

NO.	FREQ. (MHz)	EMISSION LEVEL (dBuV/m)	LIMIT (dBuV/m)	MARGIN (dB)	ANTENNA HEIGHT (m)	TABLE ANGLE (Degree)	RAW VALUE (dBuV)	CORRECTION FACTOR (dB/m)
1	*2452.00	102.3 PK			1.45 H	357	69.35	32.95
2	*2452.00	93.6 AV			1.45 H	357	60.65	32.95
3	2483.50	67.3 PK	74.0	-6.7	1.00 H	357	34.27	33.03
4	2483.50	53.2 AV	54.0	-0.8	1.00 H	357	20.17	33.03
5	4904.00	48.1 PK	74.0	-25.9	1.10 H	131	5.76	42.34
6	4904.00	36.1 AV	54.0	-17.9	1.10 H	131	-6.24	42.34
7	7356.00	50.9 PK	74.0	-23.1	1.16 H	116	3.81	47.09
8	7356.00	41.5 AV	54.0	-12.5	1.16 H	116	-5.59	47.09

ANTENNA POLARITY & TEST DISTANCE: VERTICAL AT 3 M

NO.	FREQ. (MHz)	EMISSION LEVEL (dBuV/m)	LIMIT (dBuV/m)	MARGIN (dB)	ANTENNA HEIGHT (m)	TABLE ANGLE (Degree)	RAW VALUE (dBuV)	CORRECTION FACTOR (dB/m)
1	*2452.00	100.7 PK			1.34 V	140	67.75	32.95
2	*2452.00	91.2 AV			1.34 V	140	58.25	32.95
3	2483.50	61.6 PK	74.0	-12.4	1.35 V	139	28.57	33.03
4	2483.50	50.1 AV	54.0	-3.9	1.35 V	139	17.07	33.03
5	4904.00	49.6 PK	74.0	-24.4	1.11 V	139	7.26	42.34
6	4904.00	36.4 AV	54.0	-17.6	1.11 V	139	-5.94	42.34
7	7356.00	51.2 PK	74.0	-22.8	1.08 V	145	4.11	47.09
8	7356.00	42.0 AV	54.0	-12.0	1.08 V	145	-5.09	47.09

REMARKS:

1. Emission level (dBuV/m) = Raw Value (dBuV) + Correction Factor (dB/m).
2. Correction Factor (dB/m) = Antenna Factor (dB/m) + Cable Factor (dB).
3. The other emission levels were very low against the limit.
4. Margin value = Emission level – Limit value.
5. " * ": Fundamental frequency.

4.3 6dB BANDWIDTH MEASUREMENT

4.3.1 LIMITS OF 6dB BANDWIDTH MEASUREMENT

The minimum of 6dB Bandwidth Measurement is 0.5 MHz.

4.3.2 TEST INSTRUMENTS

DESCRIPTION & MANUFACTURER	MODEL NO.	SERIAL NO.	CALIBRATED DATE	CALIBRATED UNTIL
R&S SPECTRUM ANALYZER	FSP40	100037	Nov. 01, 2012	Oct. 31, 2013

Note:

1. The calibration interval of the above test instruments is 12 months and the calibrations are traceable to NML/ROC and NIST/USA.
2. Tested date : Feb. 18, 2013

4.3.3 TEST PROCEDURE

1. Set resolution bandwidth (RBW) = approximately 1% of the emission bandwidth
2. Set the video bandwidth (VBW) $\geq 3 \times$ RBW, Detector = Peak.
3. Trace mode = max hold.
4. Sweep = auto couple.
5. Measure the maximum width of the emission that is constrained by the frequencies associated with the two amplitude points (upper and lower) that are attenuated by 6 dB relative to the maximum level measured in the fundamental emission

4.3.4 DEVIATION FROM TEST STANDARD

No deviation

4.3.5 TEST SETUP

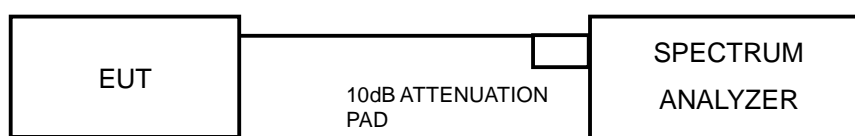

4.3.6 EUT OPERATING CONDITIONS

The software provided by client to enable the EUT under transmission condition continuously at lowest, middle and highest channel frequencies individually.



4.3.7 TEST RESULTS

802.11b

CHANNEL	CHANNEL FREQUENCY (MHz)	6dB BANDWIDTH (MHz)		MINIMUM LIMIT (MHz)	PASS / FAIL
		CHAIN 0	CHAIN 1		
1	2412	10.12	10.15	0.5	PASS
6	2437	10.11	10.17	0.5	PASS
11	2462	10.15	10.16	0.5	PASS

802.11g

CHANNEL	CHANNEL FREQUENCY (MHz)	6dB BANDWIDTH (MHz)		MINIMUM LIMIT (MHz)	PASS / FAIL
		CHAIN 0	CHAIN 1		
1	2412	16.63	16.60	0.5	PASS
6	2437	16.65	16.59	0.5	PASS
11	2462	16.60	16.59	0.5	PASS

802.11n (HT20)

CHANNEL	CHANNEL FREQUENCY (MHz)	6dB BANDWIDTH (MHz)		MINIMUM LIMIT (MHz)	PASS / FAIL
		CHAIN 0	CHAIN 1		
1	2412	17.83	17.84	0.5	PASS
6	2437	17.86	17.86	0.5	PASS
11	2462	17.84	17.84	0.5	PASS

802.11n (HT40)

CHANNEL	CHANNEL FREQUENCY (MHz)	6dB BANDWIDTH (MHz)		MINIMUM LIMIT (MHz)	PASS / FAIL
		CHAIN 0	CHAIN 1		
3	2422	36.54	36.56	0.5	PASS
6	2437	36.59	36.59	0.5	PASS
9	2452	36.57	36.57	0.5	PASS

4.4 CONDUCTED OUTPUT POWER MEASUREMENT

4.4.1 LIMITS OF MAXIMUM PEAK OUTPUT POWER MEASUREMENT

For systems using digital modulation in the 2400–2483.5 MHz band: 1 Watt (30dBm)

Per KDB 662911 D01 Multiple Transmitter Output v01r02 Method of conducted output power measurement on IEEE 802.11 devices,

Array Gain = 0 dB (i.e., no array gain) for NANT \leq 4;

Array Gain = 0 dB (i.e., no array gain) for channel widths \geq 40 MHz for any NANT;

Array Gain = 5 log(NANT/NSS) dB or 3 dB, whichever is less for 20-MHz channel widths with NANT \geq 5.

For power measurements on all other devices: Array Gain = 10 log(NANT/NSS) dB.

4.4.2 INSTRUMENTS

DESCRIPTION & MANUFACTURER	MODEL NO.	SERIAL NO.	CALIBRATED DATE	CALIBRATED UNTIL
Power Meter	ML2495A	0824006	May 10, 2012	May 09, 2013
Power Sensor	MA2411B	0738172	May 10, 2012	May 09, 2013

Note:

1. The calibration interval of the above test instruments is 12 months and the calibrations are traceable to NML/ROC and NIST/USA.
2. Tested date : Feb. 18, 2013

4.4.3 TEST PROCEDURES

The average power sensor was used on the output port of the EUT. A power meter was used to read the response of the average power sensor. Record the average power level.

4.4.4 DEVIATION FROM TEST STANDARD

No deviation.

4.4.5 TEST SETUP

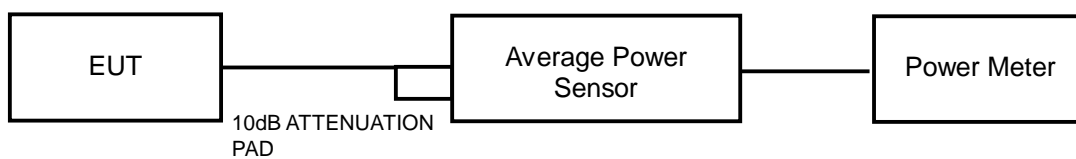

4.4.6 EUT OPERATING CONDITIONS

Same as Item 4.3.6



A D T

4.4.7 TEST RESULTS

802.11b

CHAN.	FREQ. (MHz)	AVERAGE POWER (dBm)		TOTAL POWER (mW)	TOTAL POWER (dBm)	LIMIT (dBm)	PASS / FAIL
		CHAIN 0	CHAIN 1				
1	2412	20.40	20.90	232.675	23.67	30	PASS
6	2437	22.90	22.50	372.812	25.71	30	PASS
11	2462	20.70	20.10	219.819	23.42	30	PASS

802.11g

CHAN.	FREQ. (MHz)	AVERAGE POWER (dBm)		TOTAL POWER (mW)	TOTAL POWER (dBm)	LIMIT (dBm)	PASS / FAIL
		CHAIN 0	CHAIN 1				
1	2412	15.50	15.30	69.365	18.41	30	PASS
6	2437	19.50	19.50	178.250	22.51	30	PASS
11	2462	15.90	15.20	72.018	18.57	30	PASS

802.11n (HT20)

CHAN.	FREQ. (MHz)	AVERAGE POWER (dBm)		TOTAL POWER (mW)	TOTAL POWER (dBm)	LIMIT (dBm)	PASS / FAIL
		CHAIN 0	CHAIN 1				
1	2412	13.90	13.50	46.934	16.71	30	PASS
6	2437	19.30	19.50	174.239	22.41	30	PASS
11	2462	13.70	13.50	45.829	16.61	30	PASS

802.11n (HT40)

CHAN.	FREQ. (MHz)	AVERAGE POWER (dBm)		TOTAL POWER (mW)	TOTAL POWER (dBm)	LIMIT (dBm)	PASS / FAIL
		CHAIN 0	CHAIN 1				
3	2422	13.60	13.60	45.818	16.61	30	PASS
6	2437	15.50	15.40	70.155	18.46	30	PASS
9	2452	13.20	12.70	39.514	15.97	30	PASS

4.5 POWER SPECTRAL DENSITY MEASUREMENT

4.5.1 LIMITS OF POWER SPECTRAL DENSITY MEASUREMENT

The Maximum of Power Spectral Density Measurement is 8dBm.

4.5.2 TEST INSTRUMENTS

DESCRIPTION & MANUFACTURER	MODEL NO.	SERIAL NO.	CALIBRATED DATE	CALIBRATED UNTIL
R&S Spectrum Analyzer	FSP40	100037	Nov. 01, 2012	Oct. 31, 2013

Note:

1. The calibration interval of the above test instruments is 12 months and the calibrations are traceable to NML/ROC and NIST/USA.
2. Tested date : Feb. 18, 2013

4.5.3 TEST PROCEDURE

1. Set the RBW = 3 kHz, VBW =10 kHz, Detector = power averaging (RMS) .
2. Ensure that the number of measurement points in the sweep $\geq 2 \times$ span/RBW
3. Sweep time = auto couple,
4. Employ trace averaging (RMS) mode over a minimum of 100 traces.
5. Use the peak marker function to determine the maximum amplitude level.

4.5.4 DEVIATION FROM TEST STANDARD

No deviation

4.5.5 TEST SETUP

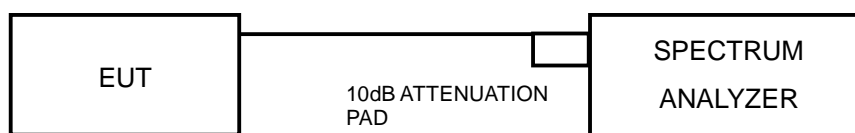

4.5.6 EUT OPERATING CONDITION

Same as Item 4.3.6



A D T

4.5.7 TEST RESULTS

802.11b

TX chain	Channel	FREQ. (MHz)	PSD (dBm/3kHz)	10 log (N=2) dB	Total PSD (dBm/3kHz)	Limit (dBm/3kHz)	PASS /FAIL
0	1	2412	-3.19	3.01	-0.18	8	PASS
	6	2437	-0.86	3.01	2.15	8	PASS
	11	2462	-3.31	3.01	-0.30	8	PASS
1	1	2412	-3.40	3.01	-0.39	8	PASS
	6	2437	-1.75	3.01	1.26	8	PASS
	11	2462	-3.67	3.01	-0.66	8	PASS

NOTE: Directional gain = $10 \log[(10^{G1/20} + 10^{G2/20})^2 / 2] = 5.95\text{dBi} < 6\text{dBi}$, so the power density limit shall not be reduced.

802.11g

TX chain	Channel	FREQ. (MHz)	PSD (dBm/3kHz)	10 log (N=2) dB	Total PSD (dBm/3kHz)	Limit (dBm/3kHz)	PASS /FAIL
0	1	2412	-11.07	3.01	-8.06	8	PASS
	6	2437	-6.83	3.01	-3.82	8	PASS
	11	2462	-11.23	3.01	-8.22	8	PASS
1	1	2412	-11.20	3.01	-8.19	8	PASS
	6	2437	-6.97	3.01	-3.96	8	PASS
	11	2462	-10.85	3.01	-7.84	8	PASS

NOTE: Directional gain = $10 \log[(10^{G1/20} + 10^{G2/20})^2 / 2] = 5.95\text{dBi} < 6\text{dBi}$, so the power density limit shall not be reduced.

802.11n (HT20)

TX chain	Channel	FREQ. (MHz)	PSD (dBm/3kHz)	10 log (N=2) dB	Total PSD (dBm/3kHz)	Limit (dBm/3kHz)	PASS /FAIL
0	1	2412	-13.39	3.01	-10.38	8	PASS
	6	2437	-6.78	3.01	-3.77	8	PASS
	11	2462	-13.09	3.01	-10.08	8	PASS
1	1	2412	-13.78	3.01	-10.77	8	PASS
	6	2437	-7.06	3.01	-4.05	8	PASS
	11	2462	-14.88	3.01	-11.87	8	PASS

NOTE: Directional gain = $10 \log[(10^{G1/20} + 10^{G2/20})^2 / 2] = 5.95\text{dBi} < 6\text{dBi}$, so the power density limit shall not be reduced.



A D T

802.11n (HT40)

TX chain	Channel	FREQ. (MHz)	PSD (dBm/3kHz)	10 log (N=2) dB	Total PSD (dBm/3kHz)	Limit (dBm/3kHz)	PASS /FAIL
0	3	2422	-16.39	3.01	-13.38	8	PASS
	6	2437	-15.10	3.01	-12.09	8	PASS
	9	2452	-15.98	3.01	-12.97	8	PASS
1	3	2422	-16.79	3.01	-13.78	8	PASS
	6	2437	-13.91	3.01	-10.90	8	PASS
	9	2452	-17.22	3.01	-14.21	8	PASS

NOTE: Directional gain = $10 \log[(10^{G1/20} + 10^{G2/20})^2 / 2] = 5.95\text{dBi} < 6\text{dBi}$, so the power density limit shall not be reduced.



A D T

4.6 CONDUCTED OUT-BAND EMISSION MEASUREMENT

4.6.1 LIMITS OF CONDUCTED OUT-BAND EMISSION MEASUREMENT

Below 30dB of the highest emission level of operating band (in 100kHz Resolution Bandwidth).

4.6.2 TEST INSTRUMENTS

DESCRIPTION & MANUFACTURER	MODEL NO.	SERIAL NO.	CALIBRATED DATE	CALIBRATED UNTIL
R&S Spectrum Analyzer	FSP40	100037	Nov. 01, 2012	Oct. 31, 2013

Note:

1. The calibration interval of the above test instruments is 12 months and the calibrations are traceable to NML/ROC and NIST/USA.
2. Tested date : Feb. 18, 2013

4.6.3 TEST PROCEDURE

Measurement Procedure - Reference Level

1. Set the RBW = 100 kHz.
2. Set the VBW \geq 300 kHz.
3. Detector = peak.
4. Sweep time = auto couple.
5. Trace mode = max hold.
6. Allow trace to fully stabilize.
7. Use the peak marker function to determine the maximum power level in any 100 kHz band segment within the fundamental EBW.

Measurement Procedure –Unwanted Emission Level

1. Set RBW = 100 kHz.
2. Set VBW \geq 300 kHz.
3. Set span to encompass the spectrum to be examined
4. Detector = peak.
5. Trace Mode = max hold.
6. Sweep = auto couple.

4.6.4 DEVIATION FROM TEST STANDARD

No deviation

4.6.5 TEST SETUP

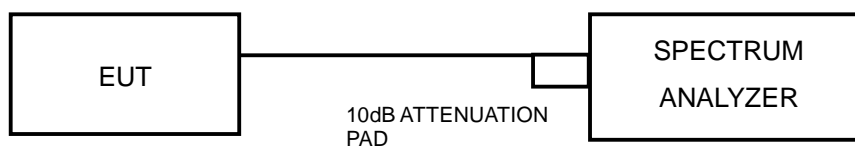

4.6.6 EUT OPERATING CONDITION

Same as Item 4.3.6

4.6.7 TEST RESULTS

The spectrum plots are attached on the following pages. D1 line indicates the highest level, and D2 line indicates the 30dB offset below D1. It shows compliance with the requirement.



A D T

802.11b:

Chain(0)

Maximum REF

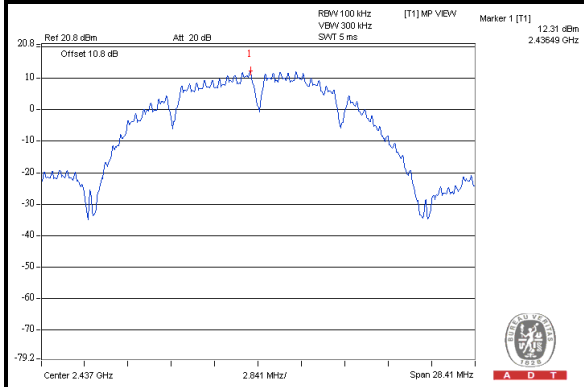

CH 1

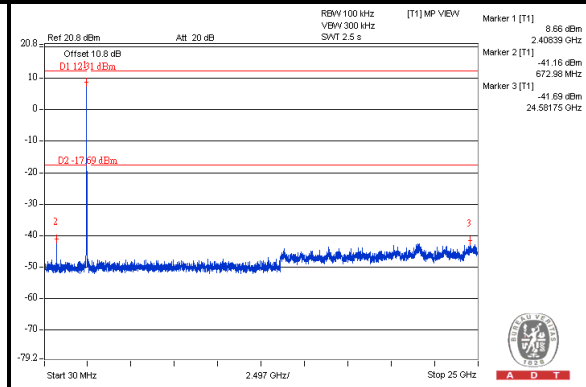

CH 6

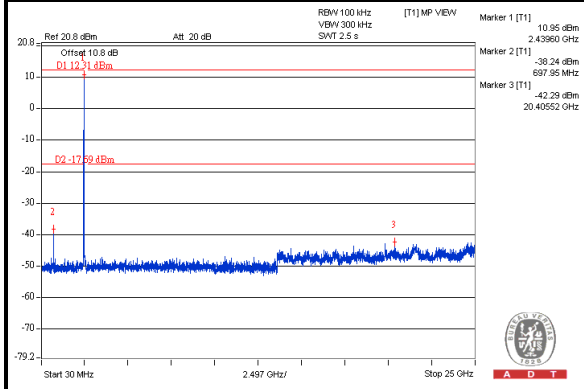

CH 11

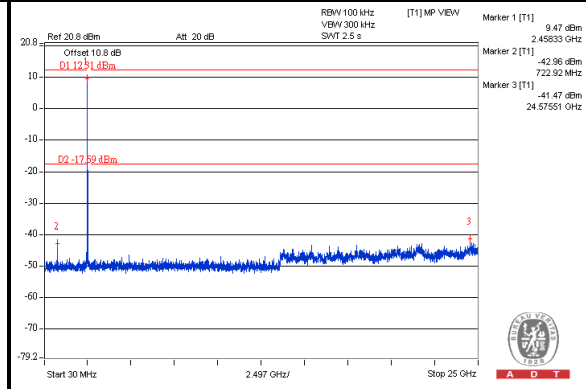



A D T

Chain(1)

Maximum REF

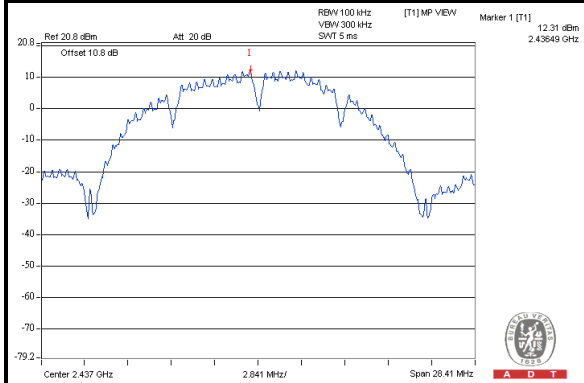

CH 1

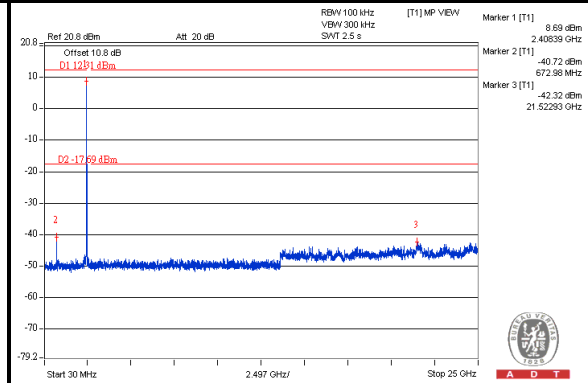

CH 6

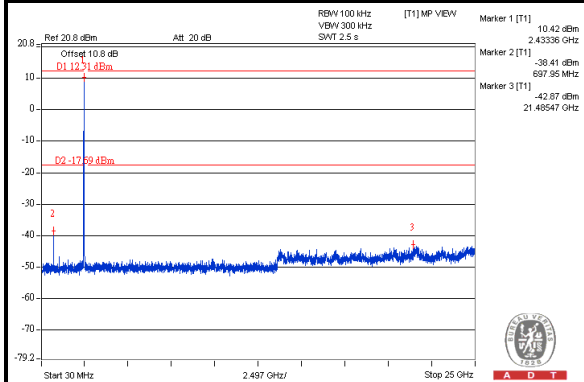

CH 11

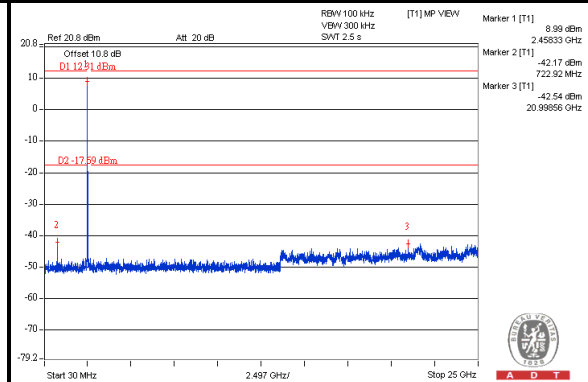



A D T

802.11g:

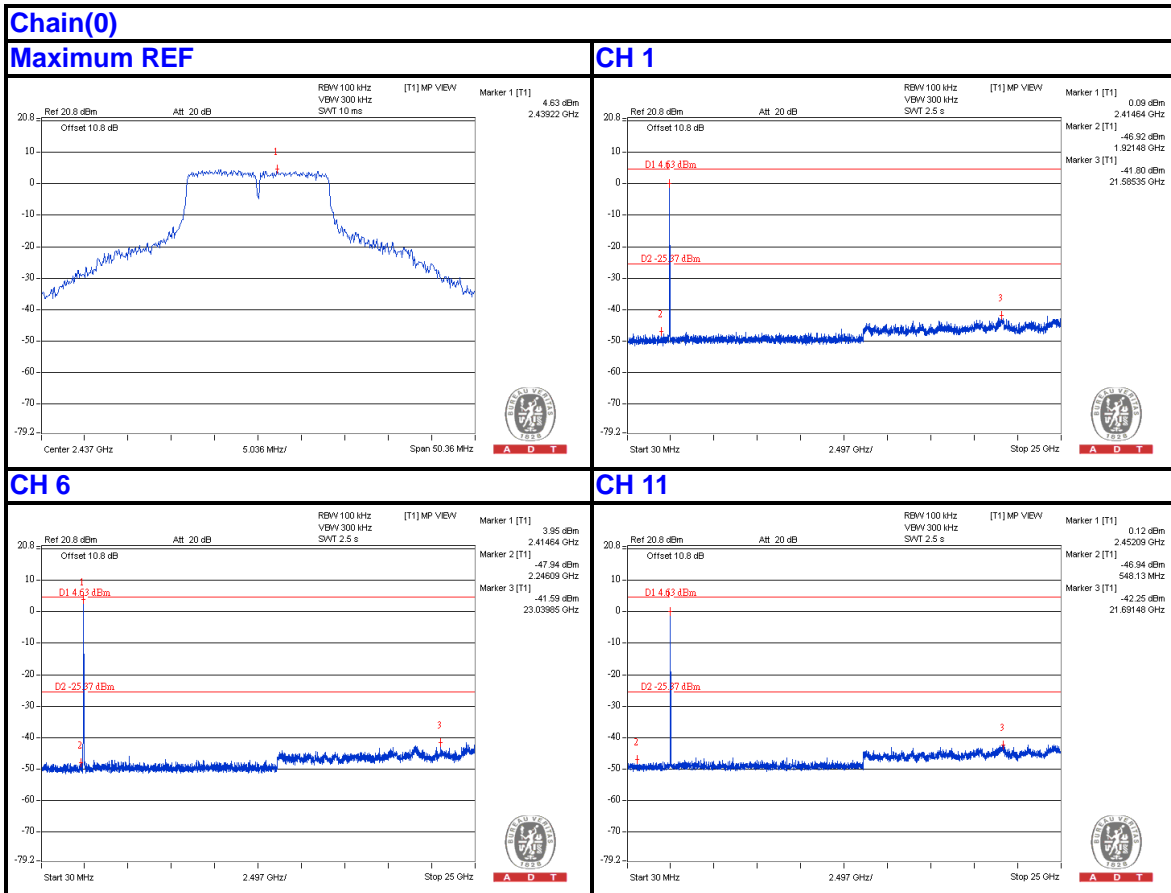



A D T

Chain(1)

Maximum REF

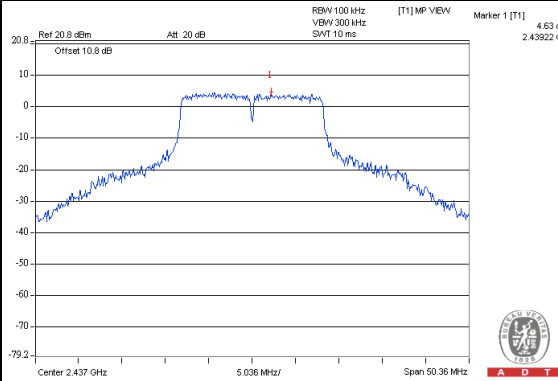

CH 1

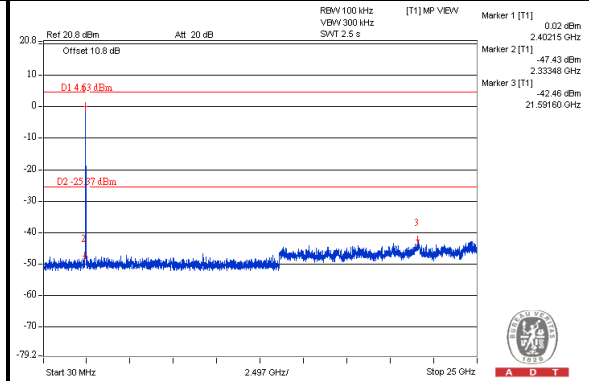

CH 6

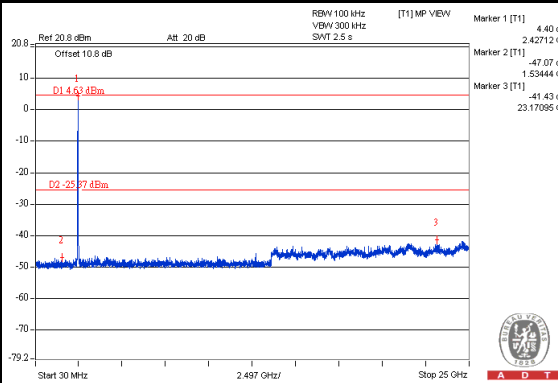

CH 11

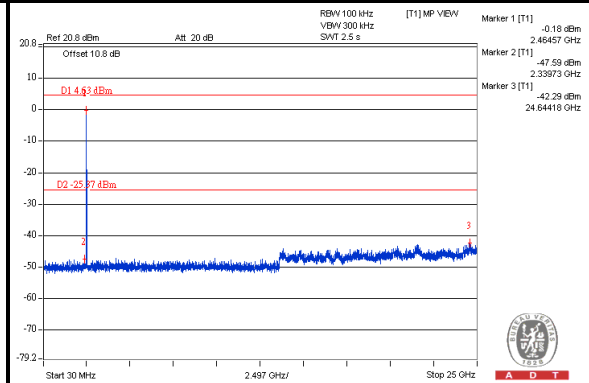



A D T

802.11n (HT20):

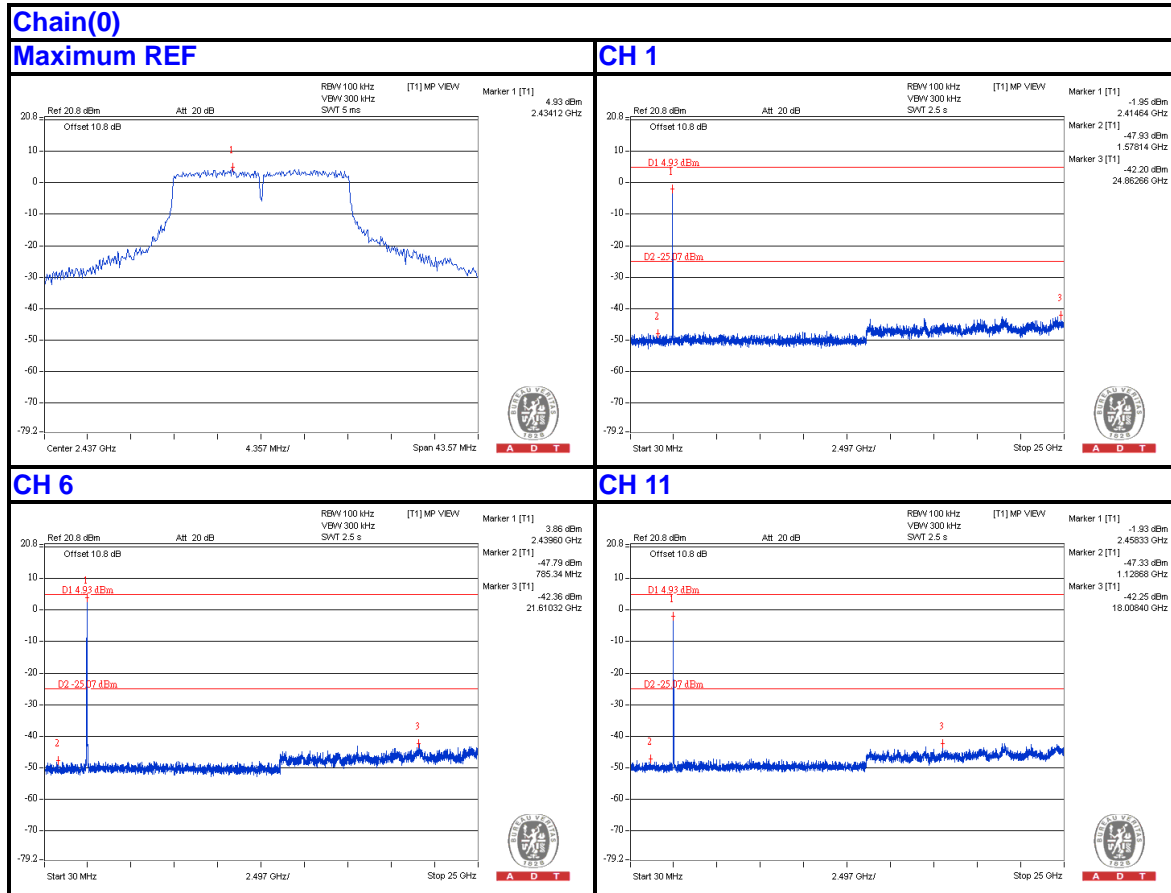



A D T

Chain(1)

Maximum REF

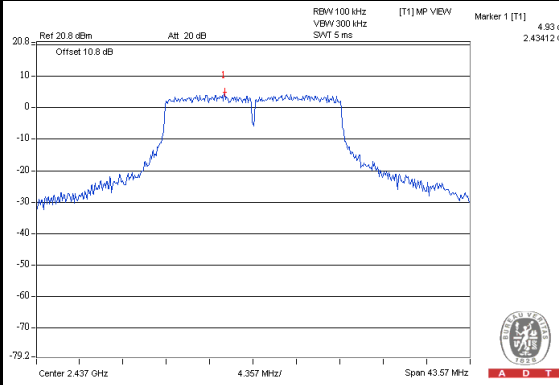

CH 1

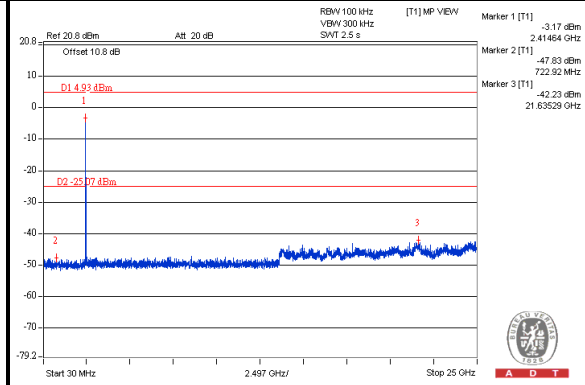

CH 6

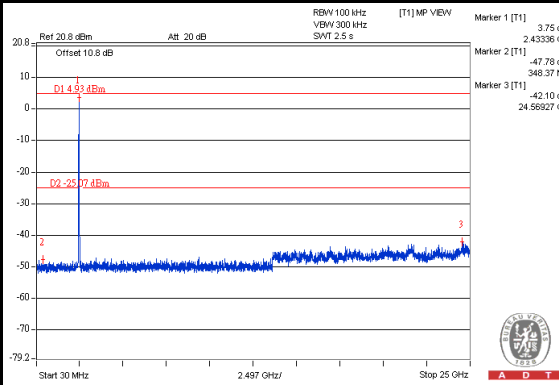

CH 11

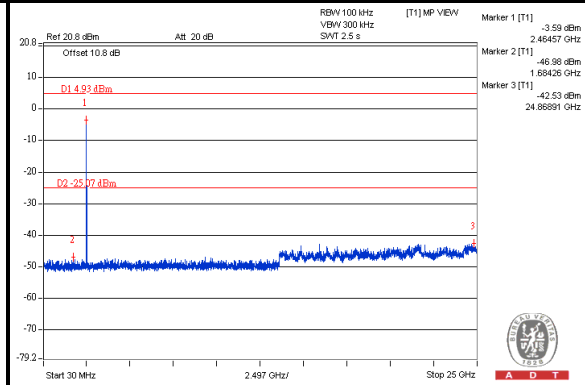



A D T

802.11n (HT40):

Chain(0)

Maximum REF

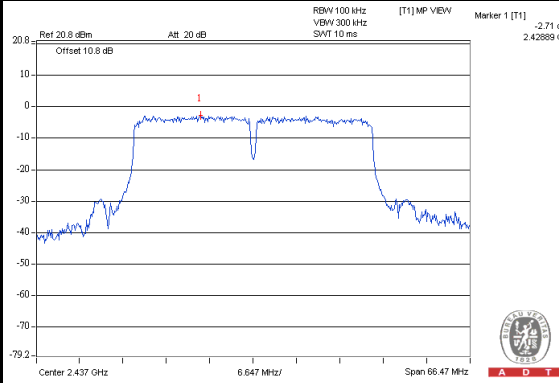

CH 3

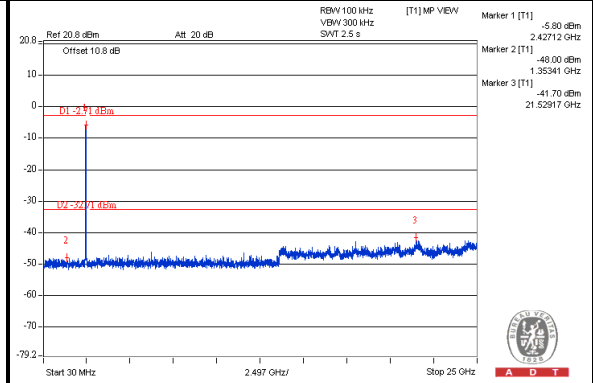

CH 6

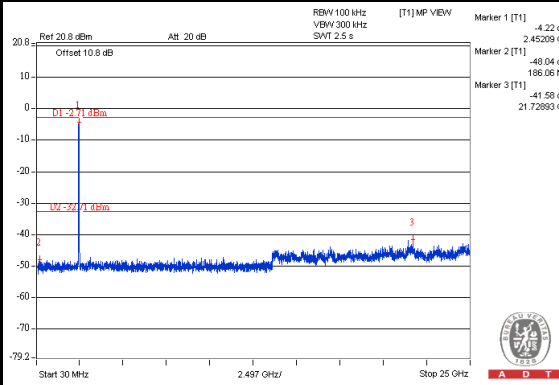

CH 9

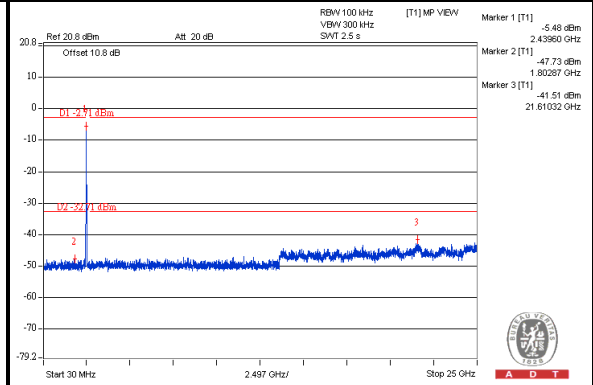



A D T

Chain(1)

Maximum REF

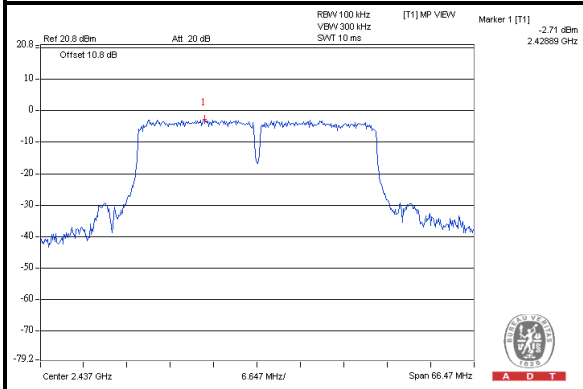

CH 3

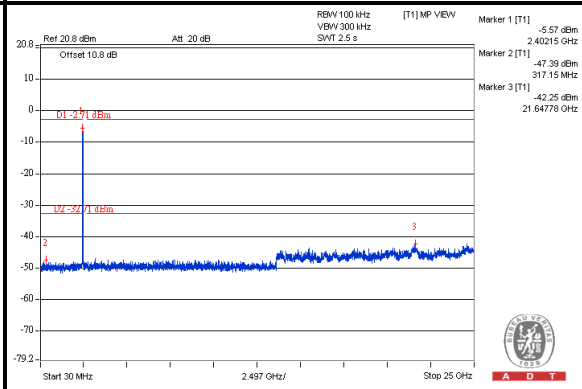

CH 6

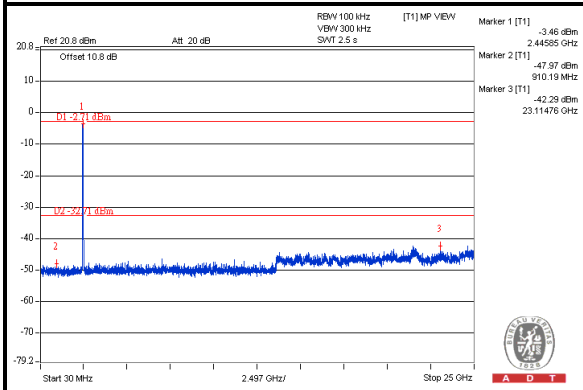

CH 9

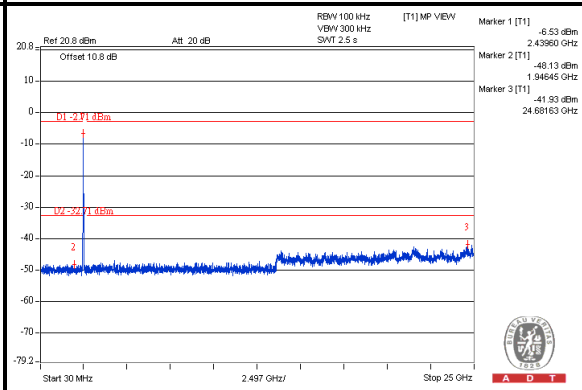



A D T

5. TEST TYPES AND RESULTS (FOR 5GHz, 5.725~5.850GHz Band)

5.1 CONDUCTED EMISSION MEASUREMENT

5.1.1 LIMITS OF CONDUCTED EMISSION MEASUREMENT

FREQUENCY OF EMISSION (MHz)	CONDUCTED LIMIT (dBµV)	
	Quasi-peak	Average
0.15-0.5	66 to 56	56 to 46
0.5-5	56	46
5-30	60	50

- NOTE:**
1. The lower limit shall apply at the transition frequencies.
 2. The limit decreases in line with the logarithm of the frequency in the range of 0.15 to 0.50 MHz.

5.1.2 TEST INSTRUMENTS

DESCRIPTION & MANUFACTURER	MODEL NO.	SERIAL NO.	CALIBRATED DATE	CALIBRATED UNTIL
Test Receiver	ESCS 30	100375	Mar. 12, 2012	Mar.11, 2013
Line-Impedance Stabilization Network (for EUT) SCHWARZBECK	NSLK8127	8127-522	Sep. 06, 2012	Sep. 05, 2013
Line-Impedance Stabilization Network (for Peripheral)	ENV216	100072	June 08,2012	June 07,2013
RF Cable (JYEBAO)	5DFB	COCCAB-001	Aug. 28, 2012	Aug. 27, 2013
50 ohms Terminator	50	EMC-3	Sep. 25, 2012	Sep. 24, 2013
Software ADT	BV ADT_Cond_V7.3.7.3	NA	NA	NA

Note:

1. The calibration interval of the above test instruments is 12 months and the calibrations are traceable to NML/ROC and NIST/USA.
2. The test was performed in Shielded Room No. C.
3. The VCCI Con C Registration No. is C-3611.
4. Tested Date: Feb. 08, 2013

5.1.3 TEST PROCEDURES

- a. The EUT was placed 0.4 meters from the conducting wall of the shielded room with EUT being connected to the power mains through a line impedance stabilization network (LISN). Other support units were connected to the power mains through another LISN.
- b. The two LISNs provide 50 ohm/ 50uH of coupling impedance for the measuring instrument.
- c. Both lines of the power mains connected to the EUT were checked for maximum conducted interference.
- d. The frequency range from 150kHz to 30MHz was searched. Emission levels under (Limit – 20dB) were not recorded.

NOTE:

1. The resolution bandwidth of test receiver is 9kHz for Quasi-peak detection (QP) & Average detection (AV).

5.1.4 DEVIATION FROM TEST STANDARD

No deviation

5.1.5 TEST SETUP

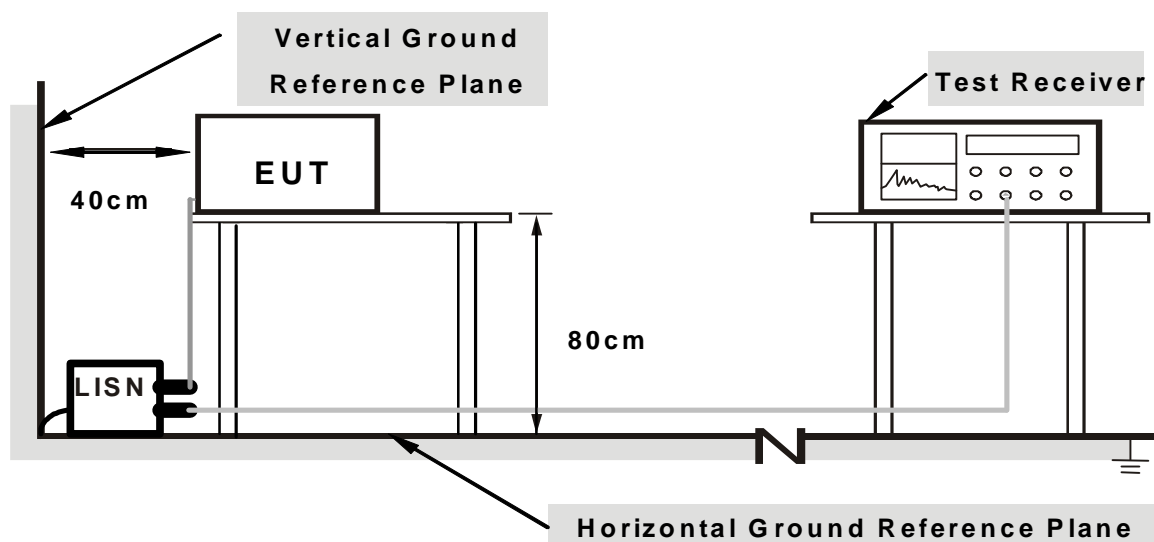

Note: 1. Support units were connected to second LISN.

For the actual test configuration, please refer to the related item – Photographs of the Test Configuration.

5.1.6 EUT OPERATING CONDITIONS

Same as the 4.1.6

5.1.7 TEST RESULTS (MODE 1)

PHASE	Line (L)	DETECTOR FUNCTION	Quasi-Peak (QP) / Average (AV)
--------------	----------	--------------------------	--------------------------------

No	Freq. [MHz]	Corr. Factor (dB)	Reading Value [dB (uV)]		Emission Level [dB (uV)]		Limit [dB (uV)]		Margin (dB)	
			Q.P.	AV.	Q.P.	AV.	Q.P.	AV.	Q.P.	AV.
	1	0.15753	0.11	51.04	40.64	51.15	40.75	65.59	55.59	-14.45
2	0.20859	0.12	42.75	30.09	42.87	30.21	63.26	53.26	-20.39	-23.05
3	0.40391	0.16	35.37	31.85	35.53	32.01	57.77	47.77	-22.24	-15.76
4	0.66563	0.17	25.30	16.50	25.47	16.67	56.00	46.00	-30.53	-29.33
5	3.12109	0.25	24.36	18.77	24.61	19.02	56.00	46.00	-31.39	-26.98
6	10.47266	0.58	25.45	20.53	26.03	21.11	60.00	50.00	-33.97	-28.89

REMARKS:

1. Q.P. and AV. are abbreviations of quasi-peak and average individually.
2. The emission levels of other frequencies were very low against the limit.
3. Margin value = Emission level - Limit value
4. Correction factor = Insertion loss + Cable loss
5. Emission Level = Correction Factor + Reading Value.

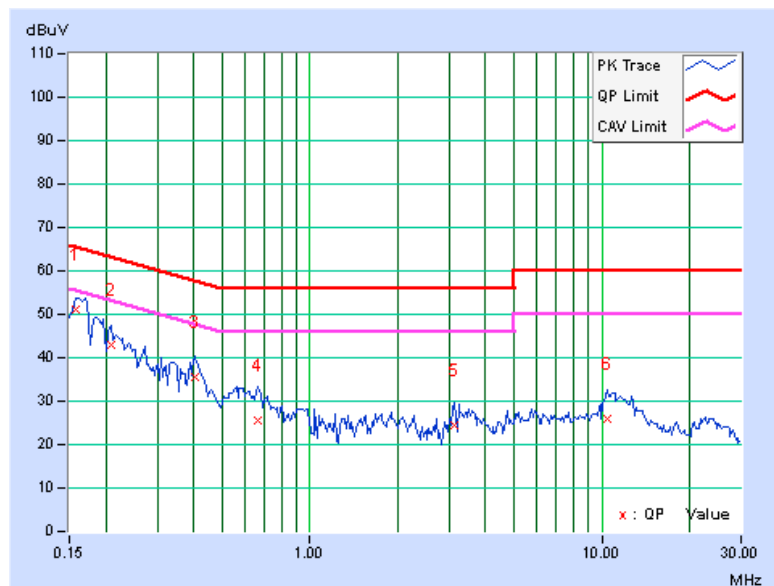

PHASE	Neutral (N)	DETECTOR FUNCTION	Quasi-Peak (QP) / Average (AV)
--------------	-------------	--------------------------	--------------------------------

No	Freq. [MHz]	Corr. Factor (dB)	Reading Value [dB (uV)]		Emission Level [dB (uV)]		Limit [dB (uV)]		Margin (dB)	
			Q.P.	AV.	Q.P.	AV.	Q.P.	AV.	Q.P.	AV.
	1	0.15781	0.09	50.71	40.28	50.80	40.37	65.58	55.58	-14.78
2	0.20469	0.10	41.43	25.40	41.53	25.50	63.42	53.42	-21.89	-27.92
3	0.38828	0.15	33.42	29.80	33.57	29.95	58.10	48.10	-24.53	-18.15
4	0.63828	0.16	27.15	21.38	27.31	21.54	56.00	46.00	-28.69	-24.46
5	3.45313	0.23	22.13	16.36	22.36	16.59	56.00	46.00	-33.64	-29.41
6	11.12891	0.44	23.80	18.88	24.24	19.32	60.00	50.00	-35.76	-30.68

REMARKS:

1. Q.P. and AV. are abbreviations of quasi-peak and average individually.
2. The emission levels of other frequencies were very low against the limit.
3. Margin value = Emission level - Limit value
4. Correction factor = Insertion loss + Cable loss
5. Emission Level = Correction Factor + Reading Value.

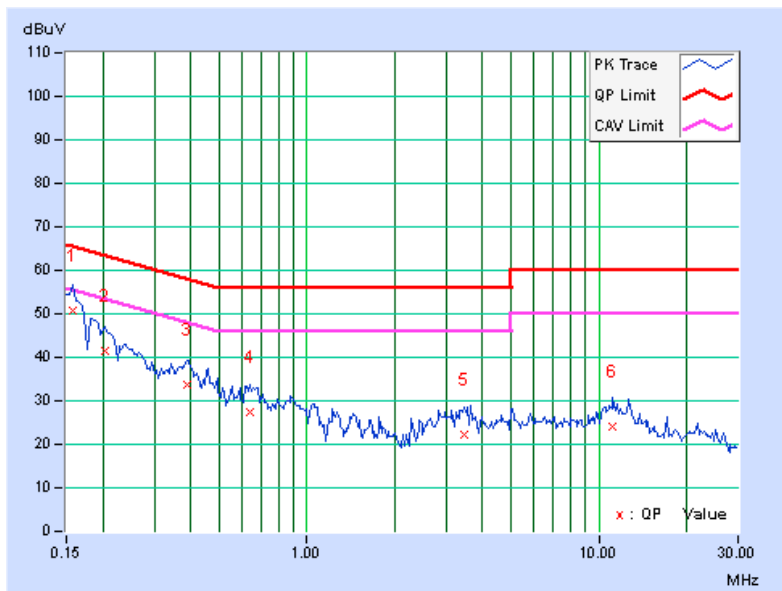

5.1.8 TEST RESULTS (MODE 2)

PHASE	Line (L)	DETECTOR FUNCTION	Quasi-Peak (QP) / Average (AV)
--------------	----------	--------------------------	--------------------------------

No	Freq. [MHz]	Corr. Factor (dB)	Reading Value		Emission Level		Limit		Margin	
			[dB (uV)]		[dB (uV)]		[dB (uV)]		(dB)	
			Q.P.	AV.	Q.P.	AV.	Q.P.	AV.	Q.P.	AV.
1	0.15000	0.11	45.95	22.52	46.06	22.63	66.00	56.00	-19.94	-33.37
2	0.16953	0.11	45.24	33.92	45.35	34.03	64.98	54.98	-19.63	-20.95
3	0.35313	0.15	40.14	30.09	40.29	30.24	58.89	48.89	-18.60	-18.65
4	0.93516	0.19	29.06	22.19	29.25	22.38	56.00	46.00	-26.75	-23.62
5	8.76563	0.50	31.96	26.89	32.46	27.39	60.00	50.00	-27.54	-22.61
6	14.80859	0.74	27.89	22.38	28.63	23.12	60.00	50.00	-31.37	-26.88

REMARKS:

1. Q.P. and AV. are abbreviations of quasi-peak and average individually.
2. The emission levels of other frequencies were very low against the limit.
3. Margin value = Emission level - Limit value
4. Correction factor = Insertion loss + Cable loss
5. Emission Level = Correction Factor + Reading Value.

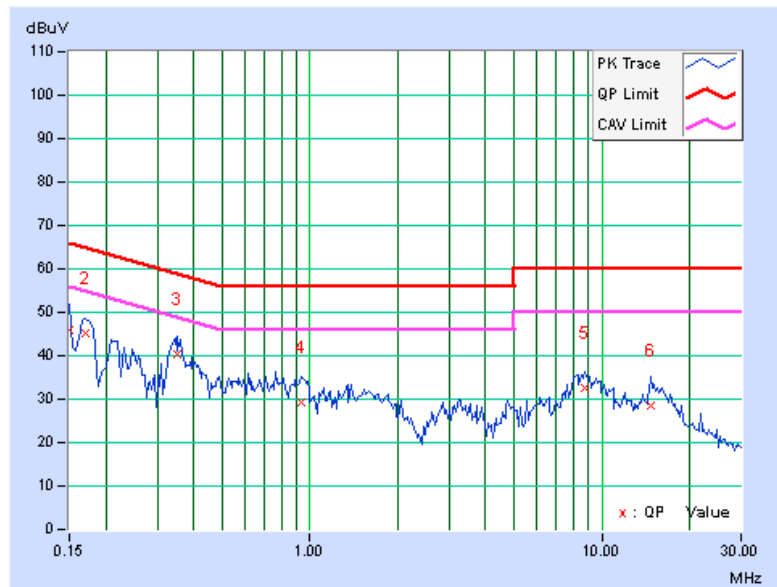

PHASE	Neutral (N)	DETECTOR FUNCTION	Quasi-Peak (QP) / Average (AV)
--------------	-------------	--------------------------	--------------------------------

No	Freq. [MHz]	Corr. Factor (dB)	Reading Value [dB (uV)]		Emission Level [dB (uV)]		Limit [dB (uV)]		Margin (dB)	
			Q.P.	AV.	Q.P.	AV.	Q.P.	AV.	Q.P.	AV.
	1	0.17344	0.09	44.66	34.03	44.75	34.12	64.79	54.79	-20.04
2	0.22422	0.11	36.42	24.63	36.53	24.74	62.66	52.66	-26.14	-27.93
3	0.35703	0.14	36.81	27.72	36.95	27.86	58.80	48.80	-21.85	-20.94
4	0.98594	0.17	27.06	20.28	27.23	20.45	56.00	46.00	-28.77	-25.55
5	1.76172	0.20	29.60	23.95	29.80	24.15	56.00	46.00	-26.20	-21.85
6	10.15234	0.42	35.50	31.19	35.92	31.61	60.00	50.00	-24.08	-18.39

REMARKS:

1. Q.P. and AV. are abbreviations of quasi-peak and average individually.
2. The emission levels of other frequencies were very low against the limit.
3. Margin value = Emission level - Limit value
4. Correction factor = Insertion loss + Cable loss
5. Emission Level = Correction Factor + Reading Value.

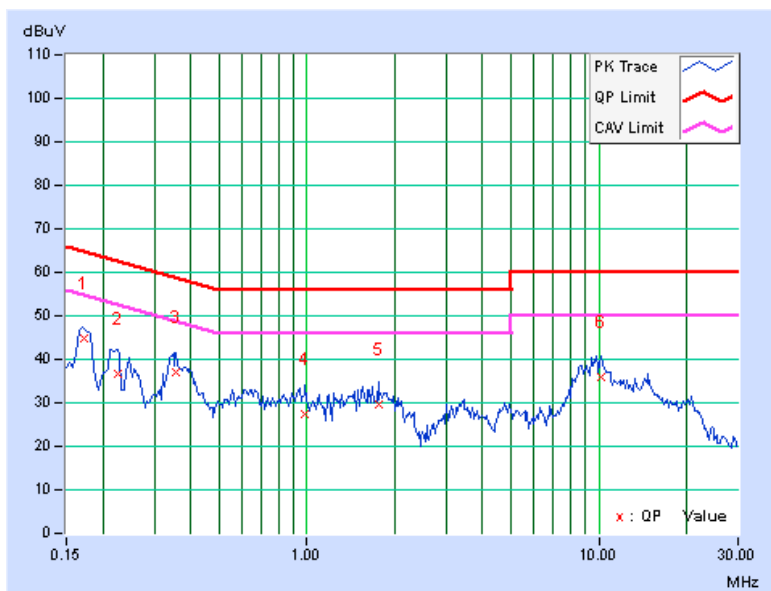



A D T

5.2 RADIATED AND BANDEGE EMISSION MEASUREMENT

5.2.1 LIMITS OF RADIATED AND BANDEGE EMISSION MEASUREMENT

Radiated emissions which fall in the restricted bands must comply with the radiated emission limits specified as below table. Other emissions shall be at least 30dB below the highest level of the desired power:

Frequencies (MHz)	Field strength (microvolts/meter)	Measurement distance (meters)
0.009-0.490	2400/F(kHz)	300
0.490-1.705	24000/F(kHz)	30
1.705-30.0	30	30
30-88	100	3
88-216	150	3
216-960	200	3
Above 960	500	3

NOTE:

1. The lower limit shall apply at the transition frequencies.
2. Emission level (dBuV/m) = 20 log Emission level (uV/m).
3. For frequencies above 1000MHz, the field strength limits are based on average detector, however, the peak field strength of any emission shall not exceed the maximum permitted average limits, specified above by more than 20dB under any condition of modulation.



A D T

5.2.2 TEST INSTRUMENTS

DESCRIPTION & MANUFACTURER	MODEL NO.	SERIAL NO.	CALIBRATED DATE	CALIBRATED UNTIL
Spectrum Analyzer Agilent	E4446A	MY48250254	July 09, 2012	July 08, 2013
Pre-Selector Agilent	N9039A	MY46520311	July 09, 2012	July 08, 2013
Signal Generator Agilent	N5181A	MY49060517	July 09, 2012	July 08, 2013
Pre-Amplifier Mini-Circuits	ZFL-1000VH2 B	AMP-ZFL-03	Nov. 14, 2012	Nov. 13, 2013
Pre-Amplifier Agilent	8449B	3008A02578	June 26, 2012	June 25, 2013
Pre-Amplifier SPACEK LABS	SLKKa-48-6	9K16	Nov. 14, 2012	Nov. 13, 2013
Trilog Broadband Antenna SCHWARZBECK	VULB 9168	9168-360	Apr. 09, 2012	Apr. 08, 2013
Horn_Antenna AISI	AIH.8018	0000320091110	Nov. 19, 2012	Nov. 18, 2013
Horn_Antenna SCHWARZBECK	BBHA 9170	9170-424	Oct. 12, 2012	Oct. 11, 2013
RF Cable	NA	RF104-201 RF104-203 RF104-204	Dec. 25, 2012	Dec. 24, 2013
RF Cable	NA	CHGCAB_001	Oct. 06, 2012	Oct. 05, 2013
Software	ADT_Radiated _V8.7.05	NA	NA	NA
Antenna Tower & Turn Table CT	NA	NA	NA	NA

Note:

1. The calibration interval of the above test instruments is 12 months and the calibrations are traceable to NML/ROC and NIST/USA.
2. The horn antenna, preamplifier (model: 8449B) are used only for the measurement of emission frequency above 1GHz if tested.
3. The test was performed in 966 Chamber No. G.
4. The FCC Site Registration No. is 966073.
5. The VCCI Site Registration No. is G-137.
6. The CANADA Site Registration No. is IC 7450H-2.
7. Tested Date: Feb. 19, 2013

5.2.3 TEST PROCEDURES

- a. The EUT was placed on the top of a rotating table 0.8 meters above the ground at 3 meter chamber room for test. The table was rotated 360 degrees to determine the position of the highest radiation.
- b. The EUT was set 3 meters away from the interference-receiving antenna, which was mounted on the top of a variable-height antenna tower.
- c. The height of antenna is varied from one meter to four meters above the ground to determine the maximum value of the field strength. Both horizontal and vertical polarizations of the antenna are set to make the measurement.
- d. For each suspected emission, the EUT was arranged to its worst case and then the antenna was tuned to heights from 1 meter to 4 meters and the rotatable table was turned from 0 degrees to 360 degrees to find the maximum reading.
- e. The test-receiver system was set to quasi-peak detect function and specified bandwidth with maximum hold mode when the test frequency is below 1 GHz.
- f. The test-receiver system was set to peak and average detect function and specified bandwidth with maximum hold mode when the test frequency is above 1 GHz. If the peak reading value also meets average limit, measurement with the average detector is unnecessary.

NOTE:

1. The resolution bandwidth and video bandwidth of test receiver/spectrum analyzer is 120kHz for Quasi-peak detection (QP) at frequency below 1GHz.
2. The resolution bandwidth of test receiver/spectrum analyzer is 1 MHz and the video bandwidth is 3 MHz for Peak detection (PK) at frequency above 1GHz.
3. The resolution bandwidth of test receiver/spectrum analyzer is 1 MHz and the video bandwidth is 10 Hz for Average detection (AV) at frequency above 1GHz.
4. All modes of operation were investigated and the worst-case emissions are reported.

5.2.4 DEVIATION FROM TEST STANDARD

No deviation

5.2.5 TEST SETUP

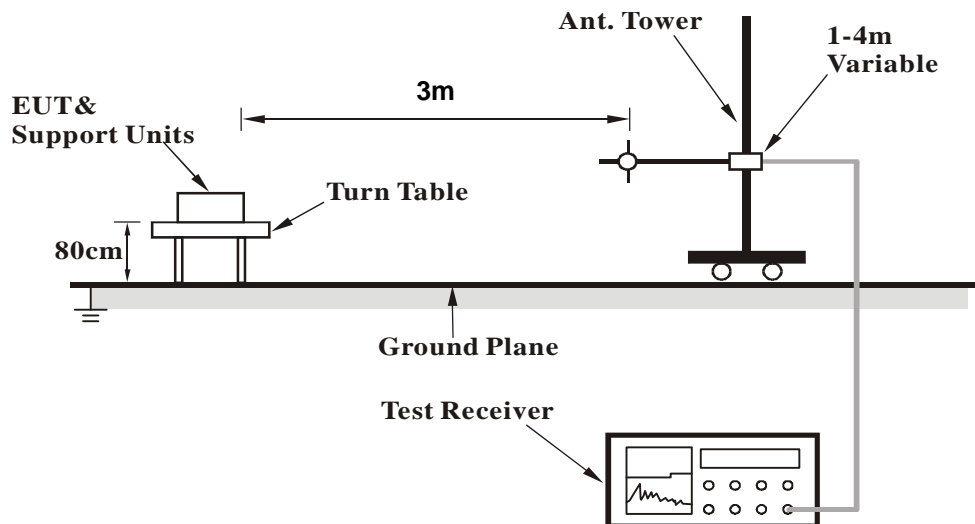

For the actual test configuration, please refer to the related item – Photographs of the Test Configuration.

5.2.6 EUT OPERATING CONDITIONS

Same as the 4.1.6



5.2.7 TEST RESULTS

BELOW 1GHz WORST-CASE DATA

802.11a

CHANNEL	TX Channel 157	DETECTOR FUNCTION	Quasi-Peak (QP)
FREQUENCY RANGE	Below 1GHz		

ANTENNA POLARITY & TEST DISTANCE: HORIZONTAL AT 3 M

NO.	FREQ. (MHz)	EMISSION LEVEL (dBuV/m)	LIMIT (dBuV/m)	MARGIN (dB)	ANTENNA HEIGHT (m)	TABLE ANGLE (Degree)	RAW VALUE (dBuV)	CORRECTION FACTOR (dB/m)
1	55.10	28.8 QP	40.0	-11.2	1.41 H	98	14.94	13.87
2	154.00	32.4 QP	43.5	-11.1	1.41 H	65	17.65	14.73
3	187.00	35.4 QP	43.5	-8.1	1.41 H	35	23.05	12.33
4	214.60	32.6 QP	43.5	-10.9	1.21 H	65	20.83	11.80
5	291.10	32.1 QP	46.0	-13.9	1.54 H	100	17.16	14.94
6	500.00	32.0 QP	46.0	-14.0	1.45 H	210	11.62	20.39

ANTENNA POLARITY & TEST DISTANCE: VERTICAL AT 3 M

NO.	FREQ. (MHz)	EMISSION LEVEL (dBuV/m)	LIMIT (dBuV/m)	MARGIN (dB)	ANTENNA HEIGHT (m)	TABLE ANGLE (Degree)	RAW VALUE (dBuV)	CORRECTION FACTOR (dB/m)
1	37.41	31.7 QP	40.0	-8.3	1.24 V	65	18.30	13.44
2	100.00	30.5 QP	43.5	-13.1	1.24 V	135	20.57	9.88
3	187.20	31.2 QP	43.5	-12.3	1.41 V	65	18.90	12.31
4	204.00	32.2 QP	43.5	-11.3	1.32 V	75	20.83	11.34
5	624.42	28.1 QP	46.0	-17.9	1.24 V	65	5.13	22.97
6	749.00	29.3 QP	46.0	-16.7	1.42 V	256	4.39	24.89

REMARKS:

1. Emission level (dBuV/m) = Raw Value (dBuV) + Correction Factor (dB/m).
2. Correction Factor (dB/m) = Antenna Factor (dB/m) + Cable Factor (dB).
3. The other emission levels were very low against the limit.
4. Margin value = Emission level – Limit value.



A D T

ABOVE 1GHz DATA

802.11a

CHANNEL	TX Channel 149	DETECTOR FUNCTION	Peak (PK)
FREQUENCY RANGE	1GHz ~ 40GHz		Average (AV)

ANTENNA POLARITY & TEST DISTANCE: HORIZONTAL AT 3 M

NO.	FREQ. (MHz)	EMISSION LEVEL (dBuV/m)	LIMIT (dBuV/m)	MARGIN (dB)	ANTENNA HEIGHT (m)	TABLE ANGLE (Degree)	RAW VALUE (dBuV)	CORRECTION FACTOR (dB/m)
1	*5745.00	113.7 PK			1.02 H	184	70.22	43.48
2	*5745.00	104.2 AV			1.02 H	184	60.72	43.48
3	11490.00	56.7 PK	74.0	-17.3	1.00 H	125	6.52	50.18
4	11490.00	45.4 AV	54.0	-8.6	1.00 H	125	-4.78	50.18

ANTENNA POLARITY & TEST DISTANCE: VERTICAL AT 3 M

NO.	FREQ. (MHz)	EMISSION LEVEL (dBuV/m)	LIMIT (dBuV/m)	MARGIN (dB)	ANTENNA HEIGHT (m)	TABLE ANGLE (Degree)	RAW VALUE (dBuV)	CORRECTION FACTOR (dB/m)
1	*5745.00	114.2 PK			1.19 V	88	70.72	43.48
2	*5745.00	105.3 AV			1.19 V	88	61.82	43.48
3	11490.00	57.2 PK	74.0	-16.8	1.05 V	116	7.02	50.18
4	11490.00	46.0 AV	54.0	-8.0	1.05 V	116	-4.18	50.18

REMARKS:

1. Emission level (dBuV/m) = Raw Value (dBuV) + Correction Factor (dB/m).
2. Correction Factor (dB/m) = Antenna Factor (dB/m) + Cable Factor (dB).
3. The other emission levels were very low against the limit.
4. Margin value = Emission level – Limit value.
5. " * " : Fundamental frequency.



A D T

CHANNEL	TX Channel 157	DETECTOR FUNCTION	Peak (PK)
FREQUENCY RANGE	1GHz ~ 40GHz		Average (AV)

ANTENNA POLARITY & TEST DISTANCE: HORIZONTAL AT 3 M

NO.	FREQ. (MHz)	EMISSION LEVEL (dBuV/m)	LIMIT (dBuV/m)	MARGIN (dB)	ANTENNA HEIGHT (m)	TABLE ANGLE (Degree)	RAW VALUE (dBuV)	CORRECTION FACTOR (dB/m)
1	*5785.00	113.7 PK			1.00 H	180	70.18	43.52
2	*5785.00	104.4 AV			1.00 H	180	60.88	43.52
3	11570.00	56.7 PK	74.0	-17.3	1.01 H	140	6.52	50.18
4	11570.00	45.5 AV	54.0	-8.5	1.01 H	140	-4.68	50.18

ANTENNA POLARITY & TEST DISTANCE: VERTICAL AT 3 M

NO.	FREQ. (MHz)	EMISSION LEVEL (dBuV/m)	LIMIT (dBuV/m)	MARGIN (dB)	ANTENNA HEIGHT (m)	TABLE ANGLE (Degree)	RAW VALUE (dBuV)	CORRECTION FACTOR (dB/m)
1	*5785.00	114.7 PK			1.23 V	98	71.18	43.52
2	*5785.00	105.6 AV			1.23 V	98	62.08	43.52
3	11570.00	55.5 PK	74.0	-18.5	1.00 V	101	5.32	50.18
4	11570.00	44.7 AV	54.0	-9.3	1.00 V	101	-5.48	50.18

REMARKS:

1. Emission level (dBuV/m) = Raw Value (dBuV) + Correction Factor (dB/m).
2. Correction Factor (dB/m) = Antenna Factor (dB/m) + Cable Factor (dB).
3. The other emission levels were very low against the limit.
4. Margin value = Emission level – Limit value.
5. " * ": Fundamental frequency.



A D T

CHANNEL	TX Channel 165	DETECTOR FUNCTION	Peak (PK)
FREQUENCY RANGE	1GHz ~ 40GHz		Average (AV)

ANTENNA POLARITY & TEST DISTANCE: HORIZONTAL AT 3 M

NO.	FREQ. (MHz)	EMISSION LEVEL (dBuV/m)	LIMIT (dBuV/m)	MARGIN (dB)	ANTENNA HEIGHT (m)	TABLE ANGLE (Degree)	RAW VALUE (dBuV)	CORRECTION FACTOR (dB/m)
1	*5825.00	113.1 PK			1.04 H	177	69.49	43.61
2	*5825.00	104.0 AV			1.04 H	177	60.39	43.61
3	11650.00	56.3 PK	74.0	-17.7	1.01 H	135	5.88	50.42
4	11650.00	45.3 AV	54.0	-8.7	1.01 H	135	-5.12	50.42

ANTENNA POLARITY & TEST DISTANCE: VERTICAL AT 3 M

NO.	FREQ. (MHz)	EMISSION LEVEL (dBuV/m)	LIMIT (dBuV/m)	MARGIN (dB)	ANTENNA HEIGHT (m)	TABLE ANGLE (Degree)	RAW VALUE (dBuV)	CORRECTION FACTOR (dB/m)
1	*5825.00	114.0 PK			1.22 V	95	70.39	43.61
2	*5825.00	105.2 AV			1.22 V	95	61.59	43.61
3	11650.00	56.1 PK	74.0	-17.9	1.06 V	75	5.68	50.42
4	11650.00	45.3 AV	54.0	-8.7	1.06 V	75	-5.12	50.42

REMARKS:

1. Emission level (dBuV/m) = Raw Value (dBuV) + Correction Factor (dB/m).
2. Correction Factor (dB/m) = Antenna Factor (dB/m) + Cable Factor (dB).
3. The other emission levels were very low against the limit.
4. Margin value = Emission level – Limit value.
5. " * ": Fundamental frequency.



A D T

802.11n (HT20)

CHANNEL	TX Channel 149	DETECTOR FUNCTION	Peak (PK)
FREQUENCY RANGE	1GHz ~ 40GHz		Average (AV)

ANTENNA POLARITY & TEST DISTANCE: HORIZONTAL AT 3 M

NO.	FREQ. (MHz)	EMISSION LEVEL (dBuV/m)	LIMIT (dBuV/m)	MARGIN (dB)	ANTENNA HEIGHT (m)	TABLE ANGLE (Degree)	RAW VALUE (dBuV)	CORRECTION FACTOR (dB/m)
1	*5745.00	113.8 PK			1.05 H	180	70.32	43.48
2	*5745.00	104.4 AV			1.05 H	180	60.92	43.48
3	11490.00	57.2 PK	74.0	-16.8	1.00 H	127	7.02	50.18
4	11490.00	45.6 AV	54.0	-8.4	1.00 H	127	-4.58	50.18

ANTENNA POLARITY & TEST DISTANCE: VERTICAL AT 3 M

NO.	FREQ. (MHz)	EMISSION LEVEL (dBuV/m)	LIMIT (dBuV/m)	MARGIN (dB)	ANTENNA HEIGHT (m)	TABLE ANGLE (Degree)	RAW VALUE (dBuV)	CORRECTION FACTOR (dB/m)
1	*5745.00	114.2 PK			1.28 V	107	70.72	43.48
2	*5745.00	105.1 AV			1.28 V	107	61.62	43.48
3	11490.00	56.9 PK	74.0	-17.1	1.00 V	104	6.72	50.18
4	11490.00	46.2 AV	54.0	-7.8	1.00 V	104	-3.98	50.18

REMARKS:

1. Emission level (dBuV/m) = Raw Value (dBuV) + Correction Factor (dB/m).
2. Correction Factor (dB/m) = Antenna Factor (dB/m) + Cable Factor (dB).
3. The other emission levels were very low against the limit.
4. Margin value = Emission level – Limit value.
5. " * ": Fundamental frequency.



A D T

CHANNEL	TX Channel 157	DETECTOR FUNCTION	Peak (PK)
FREQUENCY RANGE	1GHz ~ 40GHz		Average (AV)

ANTENNA POLARITY & TEST DISTANCE: HORIZONTAL AT 3 M

NO.	FREQ. (MHz)	EMISSION LEVEL (dBuV/m)	LIMIT (dBuV/m)	MARGIN (dB)	ANTENNA HEIGHT (m)	TABLE ANGLE (Degree)	RAW VALUE (dBuV)	CORRECTION FACTOR (dB/m)
1	*5785.00	114.3 PK			1.04 H	194	70.78	43.52
2	*5785.00	104.8 AV			1.04 H	194	61.28	43.52
3	11570.00	56.5 PK	74.0	-17.5	1.01 H	141	6.32	50.18
4	11570.00	45.2 AV	54.0	-8.8	1.01 H	141	-4.98	50.18

ANTENNA POLARITY & TEST DISTANCE: VERTICAL AT 3 M

NO.	FREQ. (MHz)	EMISSION LEVEL (dBuV/m)	LIMIT (dBuV/m)	MARGIN (dB)	ANTENNA HEIGHT (m)	TABLE ANGLE (Degree)	RAW VALUE (dBuV)	CORRECTION FACTOR (dB/m)
1	*5785.00	114.6 PK			1.34 V	107	71.08	43.52
2	*5785.00	105.3 AV			1.34 V	107	61.78	43.52
3	11570.00	56.3 PK	74.0	-17.7	1.00 V	118	6.12	50.18
4	11570.00	45.9 AV	54.0	-8.1	1.00 V	118	-4.28	50.18

REMARKS:

1. Emission level (dBuV/m) = Raw Value (dBuV) + Correction Factor (dB/m).
2. Correction Factor (dB/m) = Antenna Factor (dB/m) + Cable Factor (dB).
3. The other emission levels were very low against the limit.
4. Margin value = Emission level – Limit value.
5. " * ": Fundamental frequency.



A D T

CHANNEL	TX Channel 165	DETECTOR FUNCTION	Peak (PK)
FREQUENCY RANGE	1GHz ~ 40GHz		Average (AV)

ANTENNA POLARITY & TEST DISTANCE: HORIZONTAL AT 3 M

NO.	FREQ. (MHz)	EMISSION LEVEL (dBuV/m)	LIMIT (dBuV/m)	MARGIN (dB)	ANTENNA HEIGHT (m)	TABLE ANGLE (Degree)	RAW VALUE (dBuV)	CORRECTION FACTOR (dB/m)
1	*5825.00	114.8 PK			1.09 H	206	71.19	43.61
2	*5825.00	105.2 AV			1.09 H	206	61.59	43.61
3	11650.00	56.0 PK	74.0	-18.0	1.07 H	149	5.58	50.42
4	11650.00	44.8 AV	54.0	-9.2	1.07 H	149	-5.62	50.42

ANTENNA POLARITY & TEST DISTANCE: VERTICAL AT 3 M

NO.	FREQ. (MHz)	EMISSION LEVEL (dBuV/m)	LIMIT (dBuV/m)	MARGIN (dB)	ANTENNA HEIGHT (m)	TABLE ANGLE (Degree)	RAW VALUE (dBuV)	CORRECTION FACTOR (dB/m)
1	*5825.00	114.2 PK			1.40 V	106	70.59	43.61
2	*5825.00	105.1 AV			1.40 V	106	61.49	43.61
3	11650.00	57.4 PK	74.0	-16.6	1.00 V	110	6.98	50.42
4	11650.00	46.6 AV	54.0	-7.4	1.00 V	110	-3.82	50.42

REMARKS:

1. Emission level (dBuV/m) = Raw Value (dBuV) + Correction Factor (dB/m).
2. Correction Factor (dB/m) = Antenna Factor (dB/m) + Cable Factor (dB).
3. The other emission levels were very low against the limit.
4. Margin value = Emission level – Limit value.
5. " * ": Fundamental frequency.

802.11n (HT40)

CHANNEL	TX Channel 151	DETECTOR FUNCTION	Peak (PK)
FREQUENCY RANGE	1GHz ~ 40GHz		Average (AV)

ANTENNA POLARITY & TEST DISTANCE: HORIZONTAL AT 3 M								
NO.	FREQ. (MHz)	EMISSION LEVEL (dBuV/m)	LIMIT (dBuV/m)	MARGIN (dB)	ANTENNA HEIGHT (m)	TABLE ANGLE (Degree)	RAW VALUE (dBuV)	CORRECTION FACTOR (dB/m)
1	*5755.00	110.1 PK			1.12 H	194	66.62	43.48
2	*5755.00	101.1 AV			1.12 H	194	57.62	43.48
3	11510.00	55.9 PK	74.0	-18.1	1.04 H	159	5.73	50.17
4	11510.00	44.6 AV	54.0	-9.4	1.04 H	159	-5.57	50.17
ANTENNA POLARITY & TEST DISTANCE: VERTICAL AT 3 M								
NO.	FREQ. (MHz)	EMISSION LEVEL (dBuV/m)	LIMIT (dBuV/m)	MARGIN (dB)	ANTENNA HEIGHT (m)	TABLE ANGLE (Degree)	RAW VALUE (dBuV)	CORRECTION FACTOR (dB/m)
1	*5755.00	111.2 PK			1.41 V	114	67.72	43.48
2	*5755.00	102.4 AV			1.41 V	114	58.92	43.48
3	11510.00	55.6 PK	74.0	-18.4	1.04 V	94	5.43	50.17
4	11510.00	44.7 AV	54.0	-9.3	1.04 V	94	-5.47	50.17

REMARKS:

1. Emission level (dBuV/m) = Raw Value (dBuV) + Correction Factor (dB/m).
2. Correction Factor (dB/m) = Antenna Factor (dB/m) + Cable Factor (dB).
3. The other emission levels were very low against the limit.
4. Margin value = Emission level – Limit value.
5. " * ": Fundamental frequency.



A D T

CHANNEL	TX Channel 159	DETECTOR FUNCTION	Peak (PK)
FREQUENCY RANGE	1GHz ~ 40GHz		Average (AV)

ANTENNA POLARITY & TEST DISTANCE: HORIZONTAL AT 3 M

NO.	FREQ. (MHz)	EMISSION LEVEL (dBuV/m)	LIMIT (dBuV/m)	MARGIN (dB)	ANTENNA HEIGHT (m)	TABLE ANGLE (Degree)	RAW VALUE (dBuV)	CORRECTION FACTOR (dB/m)
1	*5795.00	110.0 PK			1.09 H	178	66.47	43.53
2	*5795.00	101.3 AV			1.09 H	178	57.77	43.53
3	11590.00	55.9 PK	74.0	-18.1	1.04 H	159	5.71	50.19
4	11590.00	44.8 AV	54.0	-9.2	1.04 H	159	-5.39	50.19

ANTENNA POLARITY & TEST DISTANCE: VERTICAL AT 3 M

NO.	FREQ. (MHz)	EMISSION LEVEL (dBuV/m)	LIMIT (dBuV/m)	MARGIN (dB)	ANTENNA HEIGHT (m)	TABLE ANGLE (Degree)	RAW VALUE (dBuV)	CORRECTION FACTOR (dB/m)
1	*5795.00	111.2 PK			1.42 V	118	67.67	43.53
2	*5795.00	102.2 AV			1.42 V	118	58.67	43.53
3	11590.00	55.6 PK	74.0	-18.4	1.02 V	77	5.41	50.19
4	11590.00	44.9 AV	54.0	-9.1	1.02 V	77	-5.29	50.19

REMARKS:

1. Emission level (dBuV/m) = Raw Value (dBuV) + Correction Factor (dB/m).
2. Correction Factor (dB/m) = Antenna Factor (dB/m) + Cable Factor (dB).
3. The other emission levels were very low against the limit.
4. Margin value = Emission level – Limit value.
5. " * ": Fundamental frequency.

802.11ac (VHT80)

CHANNEL	TX Channel 155	DETECTOR FUNCTION	Peak (PK)
FREQUENCY RANGE	1GHz ~ 40GHz		Average (AV)

ANTENNA POLARITY & TEST DISTANCE: HORIZONTAL AT 3 M								
NO.	FREQ. (MHz)	EMISSION LEVEL (dBuV/m)	LIMIT (dBuV/m)	MARGIN (dB)	ANTENNA HEIGHT (m)	TABLE ANGLE (Degree)	RAW VALUE (dBuV)	CORRECTION FACTOR (dB/m)
1	*5775.00	107.2 PK			1.09 H	110	63.69	43.51
2	*5775.00	97.8 AV			1.09 H	110	54.29	43.51
3	11550.00	56.0 PK	74.0	-18.0	1.06 H	149	5.82	50.18
4	11550.00	44.8 AV	54.0	-9.2	1.06 H	149	-5.38	50.18
ANTENNA POLARITY & TEST DISTANCE: VERTICAL AT 3 M								
NO.	FREQ. (MHz)	EMISSION LEVEL (dBuV/m)	LIMIT (dBuV/m)	MARGIN (dB)	ANTENNA HEIGHT (m)	TABLE ANGLE (Degree)	RAW VALUE (dBuV)	CORRECTION FACTOR (dB/m)
1	*5775.00	108.7 PK			1.47 V	104	65.19	43.51
2	*5775.00	99.1 AV			1.47 V	104	55.59	43.51
3	11550.00	55.1 PK	74.0	-18.9	1.00 V	110	4.92	50.18
4	11550.00	44.3 AV	54.0	-9.7	1.00 V	110	-5.88	50.18

REMARKS:

1. Emission level (dBuV/m) = Raw Value (dBuV) + Correction Factor (dB/m).
2. Correction Factor (dB/m) = Antenna Factor (dB/m) + Cable Factor (dB).
3. The other emission levels were very low against the limit.
4. Margin value = Emission level – Limit value.
5. " * ": Fundamental frequency.

5.3 6dB BANDWIDTH MEASUREMENT

5.3.1 LIMITS OF 6dB BANDWIDTH MEASUREMENT

The minimum of 6dB Bandwidth Measurement is 0.5 MHz.

5.3.2 TEST INSTRUMENTS

DESCRIPTION & MANUFACTURER	MODEL NO.	SERIAL NO.	CALIBRATED DATE	CALIBRATED UNTIL
R&S SPECTRUM ANALYZER	FSP40	100037	Nov. 01, 2012	Oct. 31, 2013

Note:

1. The calibration interval of the above test instruments is 12 months and the calibrations are traceable to NML/ROC and NIST/USA.
2. Tested date : Feb. 18, 2013

5.3.3 TEST PROCEDURE

1. Set resolution bandwidth (RBW) = approximately 1% of the emission bandwidth
2. Set the video bandwidth (VBW) $\geq 3 \times$ RBW, Detector = Peak.
3. Trace mode = max hold.
4. Sweep = auto couple.
5. Measure the maximum width of the emission that is constrained by the frequencies associated with the two amplitude points (upper and lower) that are attenuated by 6 dB relative to the maximum level measured in the fundamental emission

5.3.4 DEVIATION FROM TEST STANDARD

No deviation

5.3.5 TEST SETUP

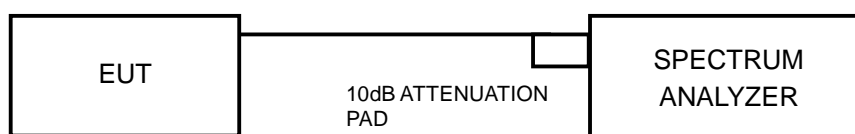

5.3.6 EUT OPERATING CONDITIONS

The software provided by client to enable the EUT under transmission condition continuously at lowest, middle and highest channel frequencies individually.



A D T

5.3.7 TEST RESULTS

802.11a

CHANNEL	CHANNEL FREQUENCY (MHz)	6dB BANDWIDTH (MHz)		MINIMUM LIMIT (MHz)	PASS / FAIL
		CHAIN 0	CHAIN 1		
149	5745	17.68	17.70	0.5	PASS
157	5785	17.69	17.69	0.5	PASS
165	5825	17.68	17.68	0.5	PASS

802.11n (HT20)

CHANNEL	CHANNEL FREQUENCY (MHz)	6dB BANDWIDTH (MHz)		MINIMUM LIMIT (MHz)	PASS / FAIL
		CHAIN 0	CHAIN 1		
149	5745	17.70	17.70	0.5	PASS
157	5785	17.69	17.68	0.5	PASS
165	5825	17.69	17.68	0.5	PASS

802.11n (HT40)

CHANNEL	CHANNEL FREQUENCY (MHz)	6dB BANDWIDTH (MHz)		MINIMUM LIMIT (MHz)	PASS / FAIL
		CHAIN 0	CHAIN 1		
151	5755	36.54	36.56	0.5	PASS
159	5795	36.50	36.53	0.5	PASS

802.11ac (VHT80)

CHANNEL	CHANNEL FREQUENCY (MHz)	6dB BANDWIDTH (MHz)		MINIMUM LIMIT (MHz)	PASS / FAIL
		CHAIN 0	CHAIN 1		
155	5775	76.54	76.52	0.5	PASS

5.4 CONDUCTED OUTPUT POWER MEASUREMENT

5.4.1 LIMITS OF CONDUCTED OUTPUT POWER MEASUREMENT

For systems using digital modulation in the 5725 –5850 MHz band: 1 Watt (30dBm)

Per KDB 662911 D01 Multiple Transmitter Output v01r02 Method of conducted output power measurement on IEEE 802.11 devices,

Array Gain = 0 dB (i.e., no array gain) for $NANT \leq 4$;

Array Gain = 0 dB (i.e., no array gain) for channel widths ≥ 40 MHz for any NANT;

Array Gain = $5 \log(NANT/NSS)$ dB or 3 dB, whichever is less for 20-MHz channel widths with $NANT \geq 5$.

For power measurements on all other devices: Array Gain = $10 \log(NANT/NSS)$ dB.

5.4.2 INSTRUMENTS

For 802.11a, 802.11n (HT20), 802.11n (HT40)

DESCRIPTION & MANUFACTURER	MODEL NO.	SERIAL NO.	CALIBRATED DATE	CALIBRATED UNTIL
Power Meter	ML2495A	0824006	May 10, 2012	May 09, 2013
Power Sensor	MA2411B	0738172	May 10, 2012	May 09, 2013

Note:

1. The calibration interval of the above test instruments is 12 months and the calibrations are traceable to NML/ROC and NIST/USA.
2. Tested date : Feb. 18, 2013

For 802.11ac (VHT80)

DESCRIPTION & MANUFACTURER	MODEL NO.	SERIAL NO.	CALIBRATED DATE	CALIBRATED UNTIL
R&S Spectrum Analyzer	FSP40	100037	Nov. 01, 2012	Oct. 31, 2013

Note:

1. The calibration interval of the above test instruments is 12 months and the calibrations are traceable to NML/ROC and NIST/USA.
2. Tested date : Feb. 18, 2013

5.4.3 TEST PROCEDURES

For 802.11a, 802.11n (HT20), 802.11n (HT40)

The average power sensor was used on the output port of the EUT. A power meter was used to read the response of the average power sensor. Record the average power level.

For 802.11ac (VHT80)

Follow FCC KDB 558074 DTS test procedure:
Measurement Procedure AVG1

1. Set the analyzer span to a minimum of 1.5 times the EBW.
2. Set RBW =1MHz.
3. Set the VBW $\geq 3 \times$ RBW.
4. Number of measurement points in the sweep $\geq 2 \times$ (span/RBW).
5. Sweep time = auto couple.
6. Detector = power averaging (RMS) or sample.
7. Employ trace averaging in power averaging (RMS) mode over a minimum of 100 traces.
8. Use the spectrum analyzer's integrated band power measurement function with band limits set equal to the EBW band edges.

5.4.4 DEVIATION FROM TEST STANDARD

No deviation.

5.4.5 TEST SETUP

For 802.11a, 802.11n (HT20), 802.11n (HT40)

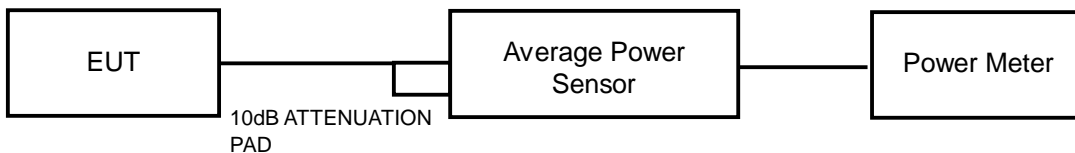

For 802.11ac (VHT80)

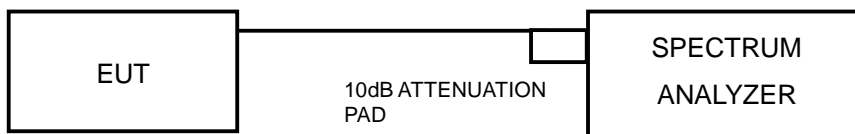

5.4.6 EUT OPERATING CONDITIONS

Same as Item 5.3.6



A D T

5.4.7 TEST RESULTS

802.11a

CHAN.	FREQ. (MHz)	AVERAGE POWER (dBm)		TOTAL POWER (mW)	TOTAL POWER (dBm)	LIMIT (dBm)	PASS / FAIL
		CHAIN 0	CHAIN 1				
149	5745	18.50	18.30	138.403	21.41	30	PASS
157	5785	18.70	18.60	146.575	21.66	30	PASS
165	5825	18.50	18.40	139.978	21.46	30	PASS

802.11n (HT20)

CHAN.	FREQ. (MHz)	AVERAGE POWER (dBm)		TOTAL POWER (mW)	TOTAL POWER (dBm)	LIMIT (dBm)	PASS / FAIL
		CHAIN 0	CHAIN 1				
149	5745	18.70	18.50	144.926	21.61	30	PASS
157	5785	18.50	18.40	139.978	21.46	30	PASS
165	5825	18.60	18.40	141.627	21.51	30	PASS

802.11n (HT40)

CHAN.	FREQ. (MHz)	AVERAGE POWER (dBm)		TOTAL POWER (mW)	TOTAL POWER (dBm)	LIMIT (dBm)	PASS / FAIL
		CHAIN 0	CHAIN 1				
151	5755	17.50	17.50	112.468	20.51	30	PASS
159	5795	17.60	17.50	113.778	20.56	30	PASS

802.11ac (VHT80)

CHAN.	FREQ. (MHz)	AVERAGE POWER (dBm)		TOTAL POWER (mW)	TOTAL POWER (dBm)	LIMIT (dBm)	PASS / FAIL
		CHAIN 0	CHAIN 1				
155	5775	20.10	19.62	193.951	22.88	30	PASS

5.5 POWER SPECTRAL DENSITY MEASUREMENT

5.5.1 LIMITS OF POWER SPECTRAL DENSITY MEASUREMENT

The Maximum of Power Spectral Density Measurement is 8dBm.

5.5.2 TEST INSTRUMENTS

DESCRIPTION & MANUFACTURER	MODEL NO.	SERIAL NO.	CALIBRATED DATE	CALIBRATED UNTIL
R&S Spectrum Analyzer	FSP40	100037	Nov. 01, 2012	Oct. 31, 2013

Note:

1. The calibration interval of the above test instruments is 12 months and the calibrations are traceable to NML/ROC and NIST/USA.
2. Tested date : Feb. 18, 2013

5.5.3 TEST PROCEDURE

1. Set the RBW = 3 kHz, VBW =10 kHz, Detector = power averaging (RMS) .
2. Ensure that the number of measurement points in the sweep $\geq 2 \times \text{span/RBW}$
3. Sweep time = auto couple,
4. Employ trace averaging (RMS) mode over a minimum of 100 traces.
5. Use the peak marker function to determine the maximum amplitude level.

5.5.4 DEVIATION FROM TEST STANDARD

No deviation

5.5.5 TEST SETUP

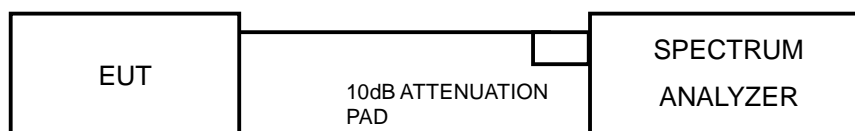

5.5.6 EUT OPERATING CONDITION

Same as Item 4.3.6



A D T

5.5.7 TEST RESULTS

802.11a

TX chain	Channel	FREQ. (MHz)	PSD (dBm/3kHz)	10 log (N=2) dB	Total PSD (dBm/3kHz)	Limit (dBm/3kHz)	PASS /FAIL
0	149	5745	-8.41	3.01	-5.40	8	PASS
	157	5785	-6.26	3.01	-3.25	8	PASS
	165	5825	-6.63	3.01	-3.62	8	PASS
1	149	5745	-8.34	3.01	-5.33	8	PASS
	157	5785	-6.92	3.01	-3.91	8	PASS
	165	5825	-7.78	3.01	-4.77	8	PASS

NOTE: Directional gain = $2\text{dBi} + 10\log(2) = 5.26\text{dBi} < 6\text{dBi}$, so the power density limit shall not be reduced.

802.11n (HT20)

TX chain	Channel	FREQ. (MHz)	PSD (dBm/3kHz)	10 log (N=2) dB	Total PSD (dBm/3kHz)	Limit (dBm/3kHz)	PASS /FAIL
0	149	5745	-7.99	3.01	-4.98	8	PASS
	157	5785	-5.50	3.01	-2.49	8	PASS
	165	5825	-6.69	3.01	-3.68	8	PASS
1	149	5745	-8.60	3.01	-5.59	8	PASS
	157	5785	-7.23	3.01	-4.22	8	PASS
	165	5825	-7.84	3.01	-4.83	8	PASS

NOTE: Directional gain = $2\text{dBi} + 10\log(2) = 5.26\text{dBi} < 6\text{dBi}$, so the power density limit shall not be reduced.



A D T

802.11n (HT40)

TX chain	Channel	FREQ. (MHz)	PSD (dBm/3kHz)	10 log (N=2) dB	Total PSD (dBm/3kHz)	Limit (dBm/3kHz)	PASS /FAIL
0	151	5755	-11.55	3.01	-8.54	8	PASS
	159	5795	-9.20	3.01	-6.19	8	PASS
1	151	5755	-12.49	3.01	-9.48	8	PASS
	159	5795	-10.63	3.01	-7.62	8	PASS

NOTE: Directional gain = $2\text{dBi} + 10\log(2) = 5.26\text{dBi} < 6\text{dBi}$, so the power density limit shall not be reduced.

802.11ac (VHT80)

TX chain	Channel	FREQ. (MHz)	PSD (dBm/3kHz)	10 log (N=2) dB	Total PSD (dBm/3kHz)	Limit (dBm/3kHz)	PASS /FAIL
0	155	5775	-14.94	3.01	-11.93	8	PASS
1	155	5775	-14.98	3.01	-11.97	8	PASS

NOTE: Directional gain = $2\text{dBi} + 10\log(2) = 5.26\text{dBi} < 6\text{dBi}$, so the power density limit shall not be reduced.

5.6 CONDUCTED OUT-BAND EMISSION MEASUREMENT

5.6.1 LIMITS OF CONDUCTED OUT-BAND EMISSION MEASUREMENT

Below 30dB of the highest emission level of operating band (in 100kHz Resolution Bandwidth).

5.6.2 TEST INSTRUMENTS

DESCRIPTION & MANUFACTURER	MODEL NO.	SERIAL NO.	CALIBRATED DATE	CALIBRATED UNTIL
R&S Spectrum Analyzer	FSP40	100037	Nov. 01, 2012	Oct. 31, 2013

Note:

1. The calibration interval of the above test instruments is 12 months and the calibrations are traceable to NML/ROC and NIST/USA.
2. Tested date : Feb. 18, 2013

5.6.3 TEST PROCEDURE

Measurement Procedure - Reference Level

1. Set the RBW = 100 kHz.
2. Set the VBW \geq 300 kHz.
3. Detector = peak.
4. Sweep time = auto couple.
5. Trace mode = max hold.
6. Allow trace to fully stabilize.
7. Use the peak marker function to determine the maximum power level in any 100 kHz band segment within the fundamental EBW.

Measurement Procedure –Unwanted Emission Level

1. Set RBW = 100 kHz.
2. Set VBW \geq 300 kHz.
3. Set span to encompass the spectrum to be examined
4. Detector = peak.
5. Trace Mode = max hold.
6. Sweep = auto couple.

5.6.4 DEVIATION FROM TEST STANDARD

No deviation

5.6.5 TEST SETUP

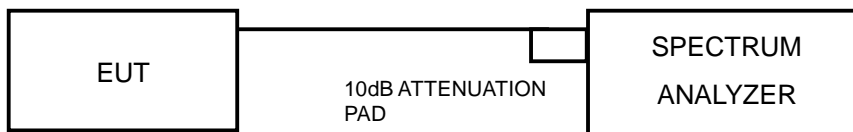

5.6.6 EUT OPERATING CONDITION

Same as Item 4.3.6

5.6.7 TEST RESULTS

The spectrum plots are attached on the following pages. D1 line indicates the highest level, and D2 line indicates the 30dB offset below D1. It shows compliance with the requirement.



A D T

802.11a

Chain(0)

Maximum REF

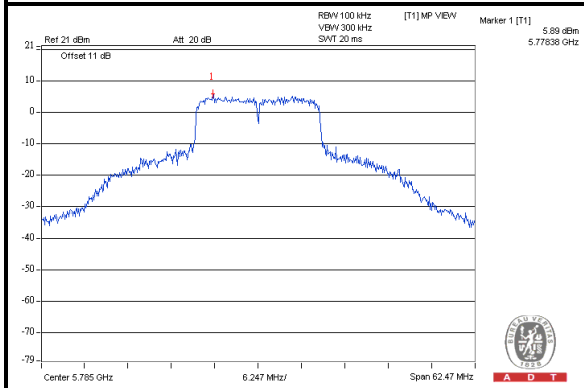

CH 149

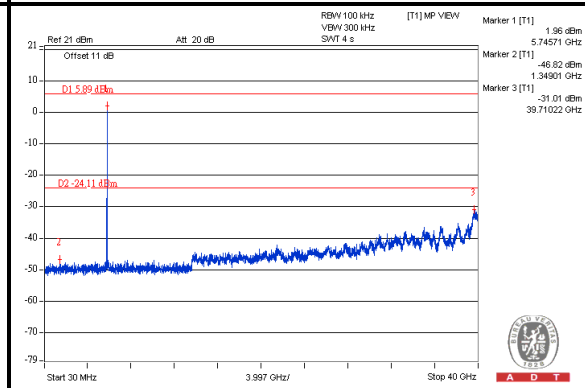

CH 157

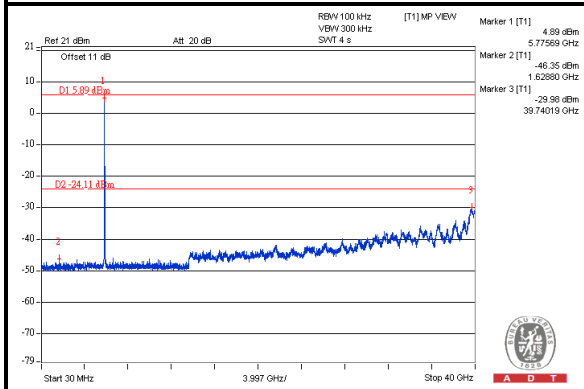

CH 165

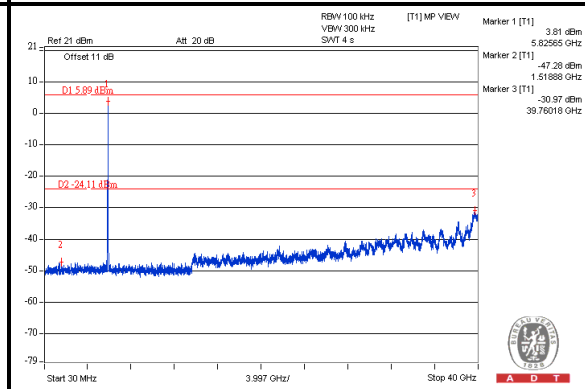



A D T

Chain(1)

Maximum REF

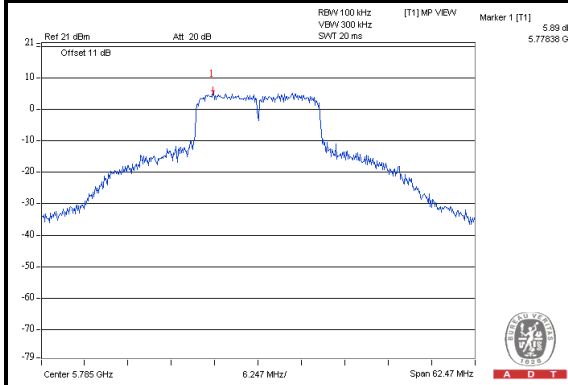

CH 149

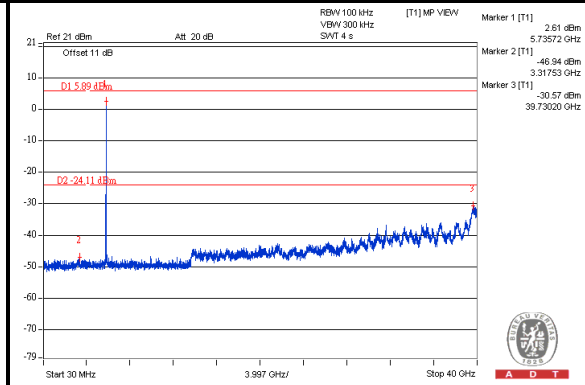

CH 157

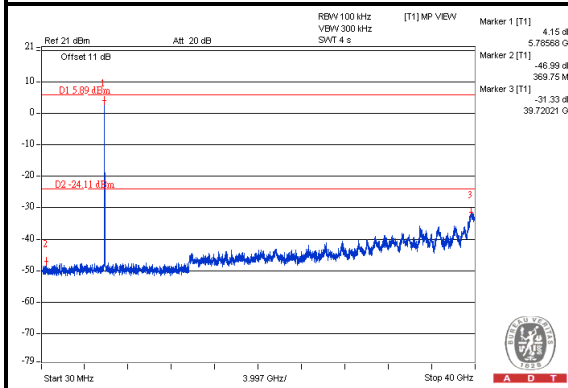

CH 165

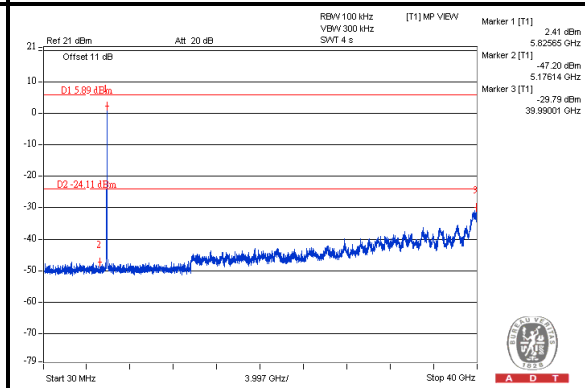



A D T

802.11n (HT20)

Chain(0)

Maximum REF

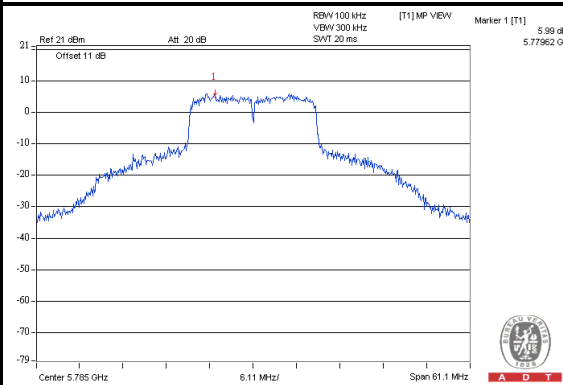

CH 149

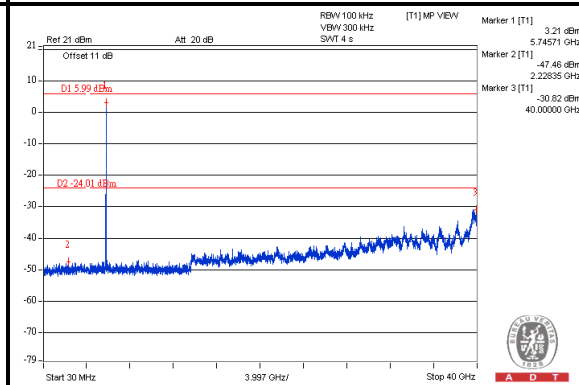

CH 157

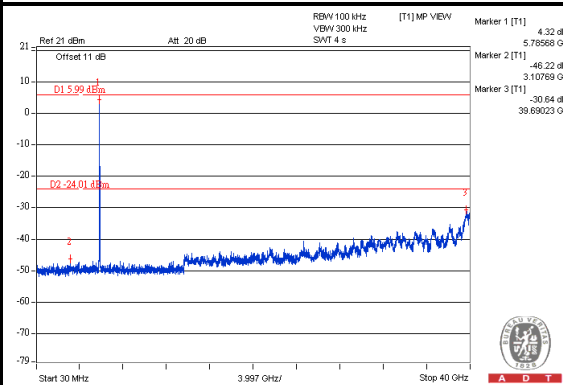

CH 165

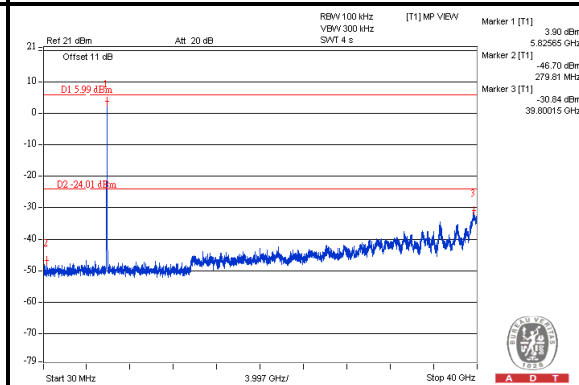



A D T

Chain(1)

Maximum REF

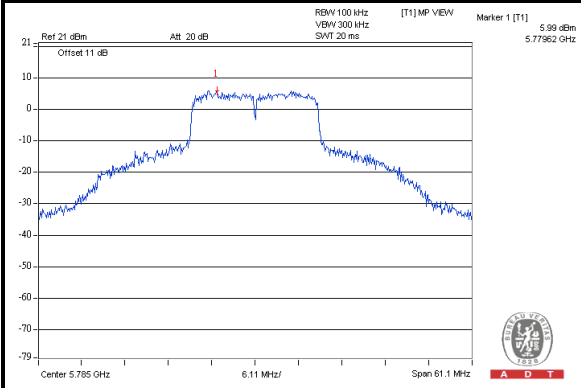

CH 149

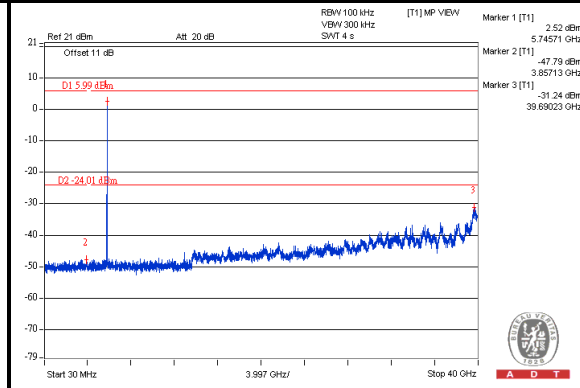

CH 157

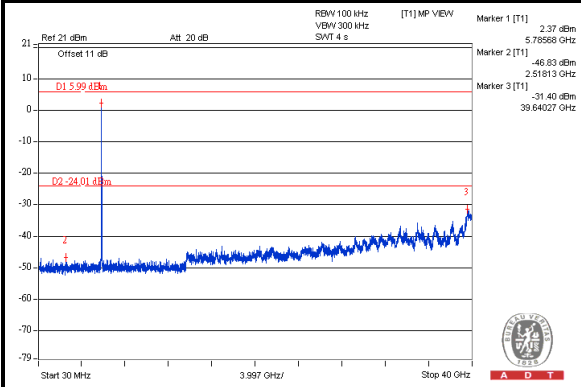

CH 165

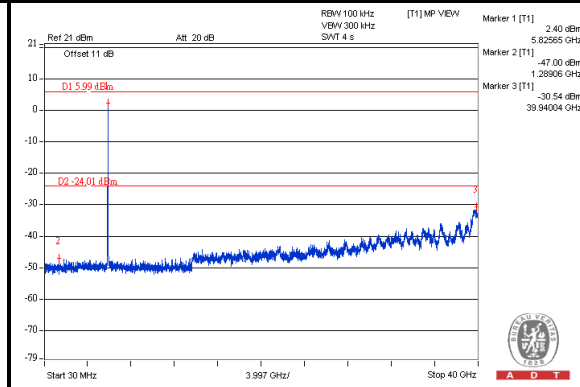



A D T

802.11n (HT40)

Chain(0)

Maximum REF

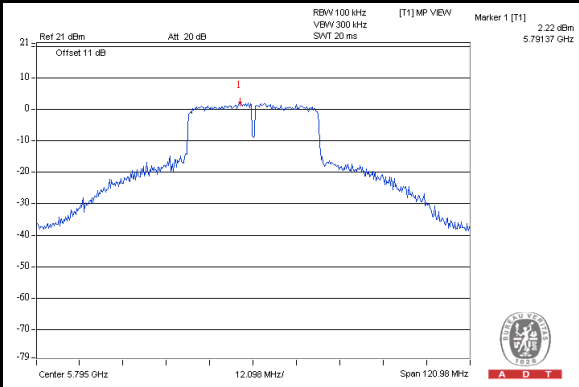

CH 151

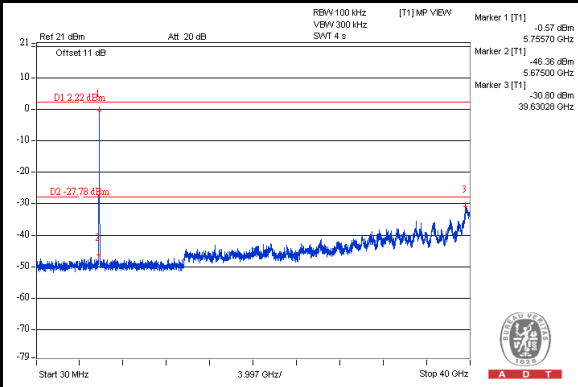

CH 159

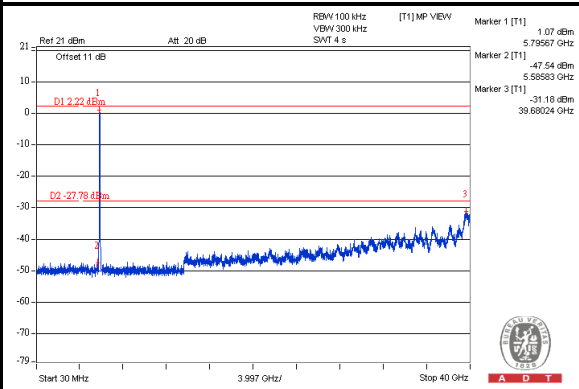



A D T

Chain(1)

Maximum REF

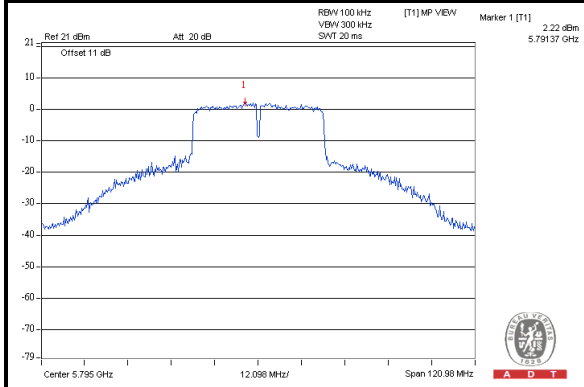

CH 151

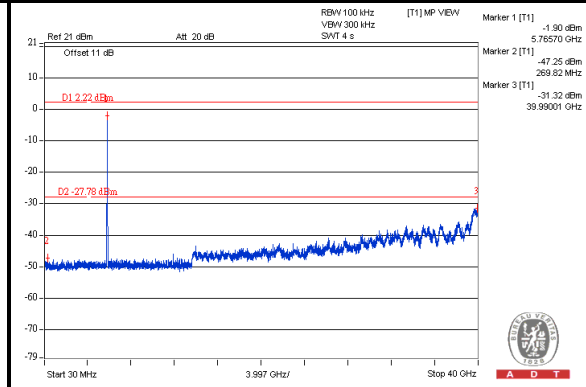

CH 159

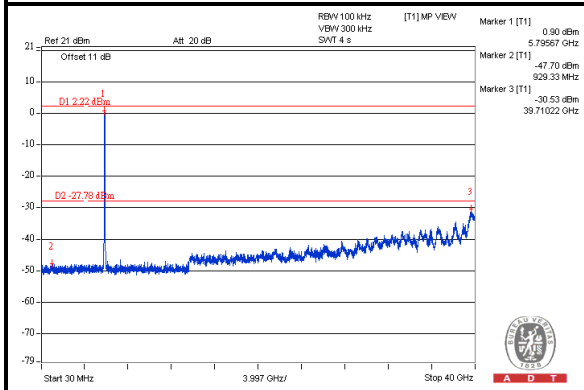



A D T

802.11ac (VHT80)

Chain(0)

Maximum REF

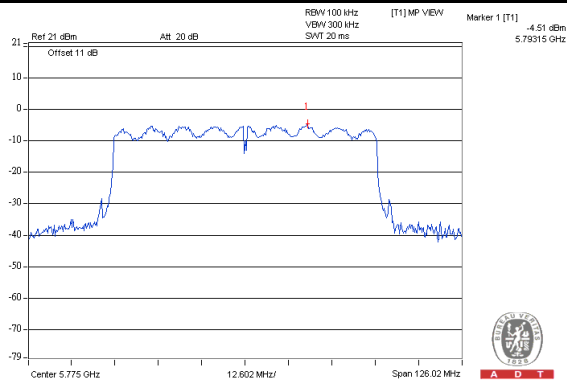

CH 155

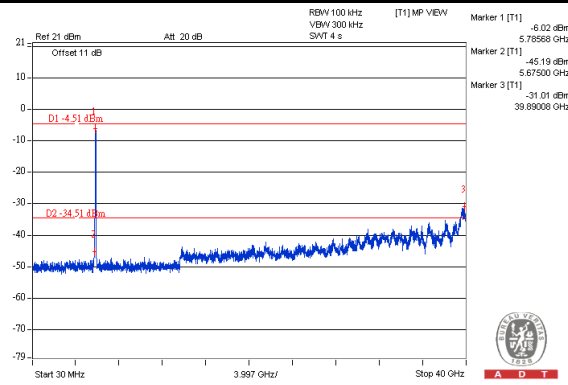

Chain(1)

Maximum REF

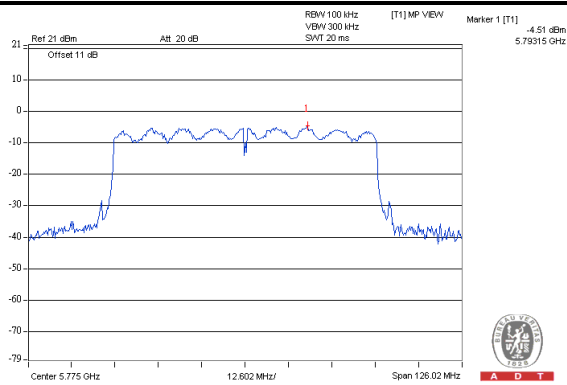

CH 155

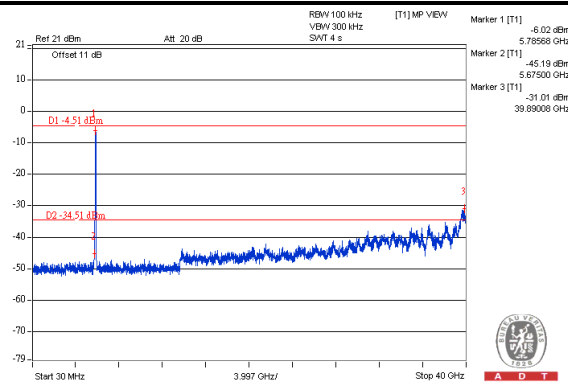



A D T

6. PHOTOGRAPHS OF THE TEST CONFIGURATION

Please refer to the attached file (Test Setup Photo).





7. INFORMATION ON THE TESTING LABORATORIES

We, Bureau Veritas Consumer Products Services (H.K.) Ltd., Taoyuan Branch, were founded in 1988 to provide our best service in EMC, Radio, Telecom and Safety consultation. Our laboratories are accredited and approved according to ISO/IEC 17025.

If you have any comments, please feel free to contact us at the following:

Linko EMC/RF Lab:

Tel: 886-2-26052180

Fax: 886-2-26052943

Hsin Chu EMC/RF Lab:

Tel: 886-3-5935343

Fax: 886-3-5935342

Hwa Ya EMC/RF/Safety/Telecom Lab:

Tel: 886-3-3183232

Fax: 886-3-3270892

Email: service.adt@tw.bureauveritas.com

Web Site: www.bureauveritas-adt.com

The address and road map of all our labs can be found in our web site also.



A D T

8. APPENDIX A - MODIFICATIONS RECORDERS FOR ENGINEERING CHANGES TO THE EUT BY THE LAB

No modifications were made to the EUT by the lab during the test.

--- END ---