



FCC TEST REPORT (15.407)

REPORT NO.: RF120305C07-1
MODEL NO.: DIR-826LMO1
FCC ID: KA2IR826LMO1
RECEIVED: Mar. 05, 2012
TESTED: Mar. 13 ~ Mar. 22, 2012
ISSUED: Mar. 26, 2012

APPLICANT: D-Link Corporation

ADDRESS: 17595 Mt. Herrmann, Fountain Valley, CA 92708,
U.S.A.

ISSUED BY: Bureau Veritas Consumer Products Services
(H.K.) Ltd., Taoyuan Branch

LAB ADDRESS: No. 47, 14th Ling, Chia Pau Vil., Lin Kou Dist.,
New Taipei City, Taiwan (R.O.C.)

TEST LOCATION: No. 19, Hwa Ya 2nd Rd, Wen Hwa Tsuen, Kwei
Shan Hsiang, Taoyuan Hsien 333, Taiwan, R.O.C.

This test report consists of 48 pages in total. It may be duplicated completely for legal use with the approval of the applicant. It should not be reproduced except in full, without the written approval of our laboratory. The client should not use it to claim product certification, approval or endorsement by TAF or any government agency. The test results in the report only apply to the tested sample.



TABLE OF CONTENTS

RELEASE CONTROL RECORD	4
1. CERTIFICATION	5
2. SUMMARY OF TEST RESULTS	6
2.1 MEASUREMENT UNCERTAINTY	6
3. GENERAL INFORMATION	7
3.1 GENERAL DESCRIPTION OF EUT	7
3.2 DESCRIPTION OF TEST MODES	8
3.2.1 TEST MODE APPLICABILITY AND TESTED CHANNEL DETAIL	9
3.3 DUTY CYCLE OF TEST SIGNAL	11
3.4 DESCRIPTION OF SUPPORT UNITS	11
3.4.1 CONFIGURATION OF SYSTEM UNDER TEST	11
3.5 GENERAL DESCRIPTION OF APPLIED STANDARDS	11
4. TEST TYPES AND RESULTS	13
4.1 RADIATED EMISSION AND BANDEDGE MEASUREMENT	13
4.1.1 LIMITS OF RADIATED EMISSION AND BANDEDGE MEASUREMENT	13
4.1.2 LIMITS OF UNWANTED EMISSION OUT OF THE RESTRICTED BANDS	13
4.1.3 TEST INSTRUMENTS	14
4.1.4 TEST PROCEDURES	15
4.1.5 DEVIATION FROM TEST STANDARD	15
4.1.6 TEST SETUP	16
4.1.7 EUT OPERATING CONDITION	16
4.1.8 TEST RESULTS	17
4.2 CONDUCTED EMISSION MEASUREMENT	26
4.2.1 LIMITS OF CONDUCTED EMISSION MEASUREMENT	26
4.2.2 TEST INSTRUMENTS	26
4.2.3 TEST PROCEDURES	27
4.2.4 DEVIATION FROM TEST STANDARD	27
4.2.5 TEST SETUP	27
4.2.6 EUT OPERATING CONDITIONS	27
4.2.7 TEST RESULTS	28
4.3 PEAK TRANSMIT POWER MEASUREMENT	30
4.3.1 LIMITS OF PEAK TRANSMIT POWER MEASUREMENT	30
4.3.2 TEST SETUP	30
4.3.3 TEST INSTRUMENTS	30
4.3.4 TEST PROCEDURE	31
4.3.5 DEVIATION FROM TEST STANDARD	31
4.3.6 EUT OPERATING CONDITIONS	31
4.3.7 TEST RESULTS	32
4.4 PEAK POWER SPECTRAL DENSITY MEASUREMENT	34
4.4.1 LIMITS OF PEAK POWER SPECTRAL DENSITY MEASUREMENT	34
4.4.2 TEST SETUP	34
4.4.3 TEST INSTRUMENTS	34
4.4.4 TEST PROCEDURES	34
4.4.5 DEVIATION FROM TEST STANDARD	34
4.4.6 EUT OPERATING CONDITIONS	34
4.4.7 TEST RESULTS	35
4.5 PEAK POWER EXCURSION MEASUREMENT	36



4.5.1	LIMITS OF PEAK POWER EXCURSION MEASUREMENT	36
4.5.2	TEST SETUP	36
4.5.3	TEST INSTRUMENTS	36
4.5.4	TEST PROCEDURE	36
4.5.5	DEVIATION FROM TEST STANDARD	36
4.5.6	EUT OPERATING CONDITIONS	36
4.5.7	TEST RESULTS	37
4.6	FREQUENCY STABILITY	43
4.6.1	LIMITS OF FREQUENCY STABILITY MEASUREMENT	43
4.6.2	TEST SETUP	43
4.6.3	TEST INSTRUMENTS	43
4.6.4	TEST PROCEDURE	44
4.6.5	DEVIATION FROM TEST STANDARD	44
4.6.6	EUT OPERATING CONDITION	44
4.6.7	TEST RESULTS	45
5.	PHOTOGRAPHS OF THE TEST CONFIGURATION	46
6.	INFORMATION ON THE TESTING LABORATORIES	47
7.	APPENDIX A - MODIFICATIONS RECORDERS FOR ENGINEERING CHANGES TO THE EUT BY THE LAB	48



A D T

RELEASE CONTROL RECORD

ISSUE NO.	REASON FOR CHANGE	DATE ISSUED
RF120305C07-1	Original release	Mar. 26, 2012



1. CERTIFICATION

PRODUCT: IEEE 802.11a/n Wireless PCIe Module
MODEL NO.: DIR-826LMO1
BRAND: D-Link
APPLICANT: D-Link Corporation
TESTED: Mar. 13 ~ Mar. 22, 2012
TEST SAMPLE: ENGINEERING SAMPLE
STANDARDS: **FCC Part 15, Subpart E (Section 15.407)**
ANSI C63.10-2009

The above equipment (model: DIR-826LMO1) has been tested by **Bureau Veritas Consumer Products Services (H.K.) Ltd., Taoyuan Branch**, and found compliance with the requirement of the above standards. The test record, data evaluation & Equipment Under Test (EUT) configurations represented herein are true and accurate accounts of the measurements of the sample's EMC characteristics under the conditions specified in this report.

PREPARED BY : Andrea Hsia , **DATE :** Mar. 26, 2012
Andrea Hsia / Specialist

APPROVED BY : Gary Chang , **DATE :** Mar. 26, 2012
Gary Chang / Technical Manager

2. SUMMARY OF TEST RESULTS

The EUT has been tested according to the following specifications:

APPLIED STANDARD: FCC PART 15, SUBPART E (SECTION 15.407)			
STANDARD SECTION	TEST TYPE	RESULT	REMARK
15.407(b)(6)	AC Power Conducted Emission	PASS	Meet the requirement of limit. Minimum passing margin is -9.12dB at 0.86094MHz.
15.407(b/1/2/3)(b)(6)	Spurious Emissions	PASS	Meet the requirement of limit. Minimum passing margin is -2.8dB at 37.78MHz.
15.407(a/1/2)	Peak Transmit Power	PASS	Meet the requirement of limit.
15.407(a)(6)	Peak Power Excursion	PASS	Meet the requirement of limit.
15.407(a/1/2)	Peak Power Spectral Density	PASS	Meet the requirement of limit.
15.407(g)	Frequency Stability	PASS	Meet the requirement of limit.
15.203	Antenna Requirement	PASS	Antenna connector is UFL not a standard connector.

2.1 MEASUREMENT UNCERTAINTY

Where relevant, the following measurement uncertainty levels have been estimated for tests performed on the EUT as specified in CISPR 16-4-2:

MEASUREMENT	FREQUENCY	UNCERTAINTY
Conducted emissions	9kHz~30MHz	2.44 dB
Radiated emissions	30MHz ~ 200MHz	2.93 dB
	200MHz ~1000MHz	2.95 dB
	1GHz ~ 18GHz	2.26 dB
	18GHz ~ 40GHz	1.94 dB

This uncertainty represents an expanded uncertainty expressed at approximately the 95% confidence level using a coverage factor of $k = 2$.

3. GENERAL INFORMATION

3.1 GENERAL DESCRIPTION OF EUT

EUT	IEEE 802.11a/n Wireless PCIe Module
MODEL NO.	DIR-826LMO1
POWER SUPPLY	3.3Vdc
MODULATION TYPE	64QAM, 16QAM, QPSK, BPSK
MODULATION TECHNOLOGY	OFDM
TRANSFER RATE	802.11a: 54.0/ 48.0/ 36.0/ 24.0/ 18.0/ 12.0/ 9.0/ 6.0Mbps 802.11n: up to 300.0Mbps
OPERATING FREQUENCY	5180.0 ~ 5240.0MHz
NUMBER OF CHANNEL	4 for 802.11a, 802.11n (20MHz) 2 for 802.11n (40MHz)
OUTPUT POWER	48.5mW
ANTENNA TYPE	PCBantenna with 0dBi gain
ANTENNA CONNECTOR	UFL
DATA CABLE	NA
I/O PORTS	Refer to user's manual
ACCESSORY DEVICES	NA

NOTE:

- The frequency bands used in this EUT are listed as follows:

Frequency Band (MHz)	5180~5240	5745~5825
802.11a	√	√
802.11n (20MHz)	√	√
802.11n (40MHz)	√	√

- The EUT incorporates a MIMO function. Physically, the EUT provides two completed transmitters and two receivers.

MODULATION MODE	TX FUNCTION
802.11a	1TX
802.11n (20MHz)	2TX
802.11n (40MHz)	2TX

- The above EUT information is declared by manufacturer and for more detailed features description, please refer to the manufacturer's specifications or user's manual.

3.2 DESCRIPTION OF TEST MODES

4 channels are provided for 802.11a, 802.11n (20MHz):

CHANNEL	FREQUENCY	CHANNEL	FREQUENCY
36	5180MHz	44	5220MHz
40	5200MHz	48	5240MHz

2 channels are provided for 802.11n (40MHz):

CHANNEL	FREQUENCY	CHANNEL	FREQUENCY
38	5190MHz	46	5230MHz

3.2.1 TEST MODE APPLICABILITY AND TESTED CHANNEL DETAIL

EUT CONFIGURE MODE	APPLICABLE TO				DESCRIPTION
	RE≥1G	RE<1G	PLC	APCM	
-	√	√	√	√	-

Where **RE≥1G**: Radiated Emission above 1GHz **RE<1G**: Radiated Emission below 1GHz
PLC: Power Line Conducted Emission **APCM**: Antenna Port Conducted Measurement

RADIATED EMISSION TEST (ABOVE 1GHz):

- Pre-Scan has been conducted to determine the worst-case mode from all possible combinations between available modulations, data rates and antenna ports (if EUT with antenna diversity architecture).
- Following channel(s) was (were) selected for the final test as listed below.

MODE	AVAILABLE CHANNEL	TESTED CHANNEL	MODULATION TECHNOLOGY	MODULATION TYPE	DATA RATE (Mbps)
802.11a	36 to 48	36, 40, 48	OFDM	BPSK	6.0
802.11n (20MHz)	36 to 48	36, 40, 48	OFDM	BPSK	7.2
802.11n (40MHz)	38 to 46	38, 46	OFDM	BPSK	15.0

RADIATED EMISSION TEST (BELOW 1GHz):

- Pre-Scan has been conducted to determine the worst-case mode from all possible combinations between available modulations, data rates and antenna ports (if EUT with antenna diversity architecture).
- Following channel(s) was (were) selected for the final test as listed below.

MODE	AVAILABLE CHANNEL	TESTED CHANNEL	MODULATION TECHNOLOGY	MODULATION TYPE	DATA RATE (Mbps)
802.11a	36 to 48	36	OFDM	BPSK	6.0

POWER LINE CONDUCTED EMISSION TEST:

- Pre-Scan has been conducted to determine the worst-case mode from all possible combinations between available modulations, data rates and antenna ports (if EUT with antenna diversity architecture).
- Following channel(s) was (were) selected for the final test as listed below.

MODE	AVAILABLE CHANNEL	TESTED CHANNEL	MODULATION TECHNOLOGY	MODULATION TYPE	DATA RATE (Mbps)
802.11a	36 to 48	36	OFDM	BPSK	6.0

BANDEDGE MEASUREMENT:

- Pre-Scan has been conducted to determine the worst-case mode from all possible combinations between available modulations, data rates and antenna ports (if EUT with antenna diversity architecture).
- Following channel(s) was (were) selected for the final test as listed below.

MODE	AVAILABLE CHANNEL	TESTED CHANNEL	MODULATION TECHNOLOGY	MODULATION TYPE	DATA RATE (Mbps)
802.11a	36 to 48	36, 48	OFDM	BPSK	6.0
802.11n (20MHz)	36 to 48	36, 48	OFDM	BPSK	7.2
802.11n (40MHz)	38 to 46	38, 46	OFDM	BPSK	15.0

ANTENNA PORT CONDUCTED MEASUREMENT:

- This item includes all test value of each mode, but only includes spectrum plot of worst value of each mode.
- Pre-Scan has been conducted to determine the worst-case mode from all possible combinations between available modulations, data rates and antenna ports (if EUT with antenna diversity architecture).
- Following channel(s) was (were) selected for the final test as listed below.

MODE	AVAILABLE CHANNEL	TESTED CHANNEL	MODULATION TECHNOLOGY	MODULATION TYPE	DATA RATE (Mbps)
802.11a	36 to 48	36, 40, 48	OFDM	BPSK	6.0
802.11n (20MHz)	36 to 48	36, 40, 48	OFDM	BPSK	7.2
802.11n (40MHz)	38 to 46	38, 46	OFDM	BPSK	15.0

TEST CONDITION:

APPLICABLE TO	ENVIRONMENTAL CONDITIONS	INPUT POWER	TESTED BY
RE≥1G	25deg. C, 65%RH	120Vac, 60Hz	Sun Lin
RE<1G	25deg. C, 65%RH	120Vac, 60Hz	Anderson Hong
PLC	25deg. C, 68%RH	120Vac, 60Hz	Sun Lin
APCM	25deg. C, 68%RH	120Vac, 60Hz	Brad Wu

3.3 DUTY CYCLE OF TEST SIGNAL

Duty cycle of test signal is > 98 %

3.4 DESCRIPTION OF SUPPORT UNITS

The EUT has been tested as an independent unit together with other necessary accessories or support units. The following support units or accessories were used to form a representative test configuration during the tests.

NO.	PRODUCT	BRAND	MODEL NO.	SERIAL NO.	FCC ID
1	NOTEBOOK	DELL	E5420	1HC2XM1	FCC DoC Approved
2	EXTERNAL BOARD	NA	NA	NA	NA
3	ADAPTER	FAIRWAY	WN10A-050U	NA	NA

NO.	SIGNAL CABLE DESCRIPTION OF THE ABOVE SUPPORT UNITS
1	NA
2	NA
3	1.8m non-shielded cable without core

NOTE:

1. All power cords of the above support units are non shielded (1.8m).
2. Item 2 & 3 were supplied from client.

3.4.1 CONFIGURATION OF SYSTEM UNDER TEST

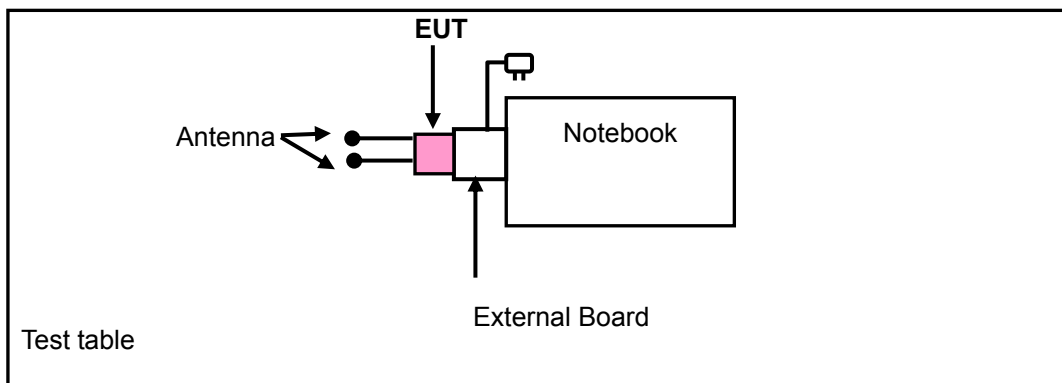

3.5 GENERAL DESCRIPTION OF APPLIED STANDARDS

The EUT is a RF Product. According to the specifications of the manufacturer, it must comply with the requirements of the following standards:

FCC Part 15, Subpart E (15.407)

ANSI C63.10-2009

All test items have been performed and recorded as per the above standards.

NOTE: The EUT is also considered as a kind of computer peripheral, because the connection to computer is necessary for typical use. It has been verified to comply with the requirements of FCC Part 15, Subpart B, Class B (DoC). The test report has been issued separately.

4. TEST TYPES AND RESULTS

4.1 RADIATED EMISSION AND BANDEDGE MEASUREMENT

4.1.1 LIMITS OF RADIATED EMISSION AND BANDEDGE MEASUREMENT

Radiated emissions which fall in the restricted bands must comply with the radiated emission limits specified as below table:

FREQUENCIES (MHz)	FIELD STRENGTH (microvolts/meter)	MEASUREMENT DISTANCE (meters)
0.009 ~ 0.490	2400/F(kHz)	300
0.490 ~ 1.705	24000/F(kHz)	30
1.705 ~ 30.0	30	30
30 ~ 88	100	3
88 ~ 216	150	3
216 ~ 960	200	3
Above 960	500	3

NOTE:

1. The lower limit shall apply at the transition frequencies.
2. Emission level (dBuV/m) = 20 log Emission level (uV/m).
3. For frequencies above 1000MHz, the field strength limits are based on average detector, however, the peak field strength of any emission shall not exceed the maximum permitted average limits, specified above by more than 20dB under any condition of modulation.

4.1.2 LIMITS OF UNWANTED EMISSION OUT OF THE RESTRICTED BANDS

EIRP LIMIT (dBm)	EQUIVALENT FIELD STRENGTH AT 3m (dBµV/m)
PK	PK
-27	68.3

NOTE: The following formula is used to convert the equipment isotropic radiated power (eirp) to field strength:

$$E = \frac{1000000\sqrt{30P}}{3} \mu\text{V/m, where P is the eirp (Watts).}$$



4.1.3 TEST INSTRUMENTS

DESCRIPTION & MANUFACTURER	MODEL NO.	SERIAL NO.	DATE OF CALIBRATION	DUE DATE OF CALIBRATION
Test Receiver ROHDE & SCHWARZ	ESCI	100744	Apr. 19, 2011	Apr. 18, 2012
Spectrum Analyzer ROHDE & SCHWARZ	FSP40	100040	Aug. 04, 2011	Aug. 03, 2012
BILOG Antenna SCHWARZBECK	VULB9168	9168-156	Apr. 12, 2011	Apr. 11, 2012
HORN Antenna SCHWARZBECK	BBHA 9120 D	9120D-563	Sep. 06, 2011	Sep. 05, 2012
HORN Antenna SCHWARZBECK	BBHA 9170	148	Jul. 20, 2011	Jul. 19, 2012
Preamplifier Agilent	8449B	3008A01911	Oct. 29, 2011	Oct. 28, 2012
Preamplifier Agilent	8447D	2944A10638	Oct. 29, 2011	Oct. 28, 2012
RF signal cable HUBER+SUHNNER	SUCOFLEX 104	295013/4 283403/4	Aug. 19, 2011	Aug. 18, 2012
RF signal cable Worken	8D-FB	Cable-HYCH9-01	Aug. 13, 2011	Aug. 12, 2012
Software	ADT_Radiated_ V7.6.15.9.2	NA	NA	NA
Antenna Tower EMCO	2070/2080	512.835.4684	NA	NA
Turn Table EMCO	2087-2.03	NA	NA	NA
Antenna Tower & Turn Table Controller EMCO	2090	NA	NA	NA
26GHz ~ 40GHz Amplifier	EM26400	815221	Oct. 29, 2011	Oct. 28, 2012
High Speed Peak Power Meter	ML2495A	0824011	Aug. 04, 2011	Aug. 03, 2012
Power Sensor	MA2411B	0738171	Aug. 04, 2011	Aug. 03, 2012

- NOTE:**
1. The calibration interval of the above test instruments is 12 months and the calibrations are traceable to NML/ROC and NIST/USA.
 2. The test was performed in HwaYa Chamber 9.
 3. The horn antenna and HP preamplifier (model: 8449B) are used only for the measurement of emission frequency above 1GHz if tested.
 4. The FCC Site Registration No. is 460141.
 5. The IC Site Registration No. is IC 7450F-4.

4.1.4 TEST PROCEDURES

- a. The EUT was placed on the top of a rotating table 0.8 meters above the ground at a 3 meter semi-anechoic chamber. The table was rotated 360 degrees to determine the position of the highest radiation.
- b. The EUT was set 3 meters away from the interference-receiving antenna, which was mounted on the top of a variable-height antenna tower.
- c. The antenna is a broadband antenna, and its height is varied from one meter to four meters above the ground to determine the maximum value of the field strength. Both horizontal and vertical polarizations of the antenna are set to make the measurement.
- d. For each suspected emission, the EUT was arranged to its worst case and then the antenna was tuned to heights from 1 meter to 4 meters and the rotatable table was turned from 0 degrees to 360 degrees to find the maximum reading.
- e. The test-receiver system was set to Peak Detect Function and Specified Bandwidth with Maximum Hold Mode.
- f. If the emission level of the EUT in peak mode was 10dB lower than the limit specified, then testing could be stopped and the peak values of the EUT would be reported. Otherwise the emissions that did not have 10dB margin would be re-tested one by one using peak, quasi-peak or average method as specified and then reported in a data sheet.

NOTE:

1. The resolution bandwidth and video bandwidth of test receiver/spectrum analyzer is 120kHz for Peak detection (PK) and Quasi-peak detection (QP) at frequency below 1GHz.
2. The resolution bandwidth of test receiver/spectrum analyzer is 1MHz and video bandwidth is 3MHz for Peak detection at frequency above 1GHz.
3. The resolution bandwidth of test receiver/spectrum analyzer is 1MHz and the video bandwidth is 1kHz for Average detection (AV) at frequency above 1GHz.
4. All modes of operation were investigated and the worst-case emissions are reported.

4.1.5 DEVIATION FROM TEST STANDARD

No deviation.

4.1.6 TEST SETUP

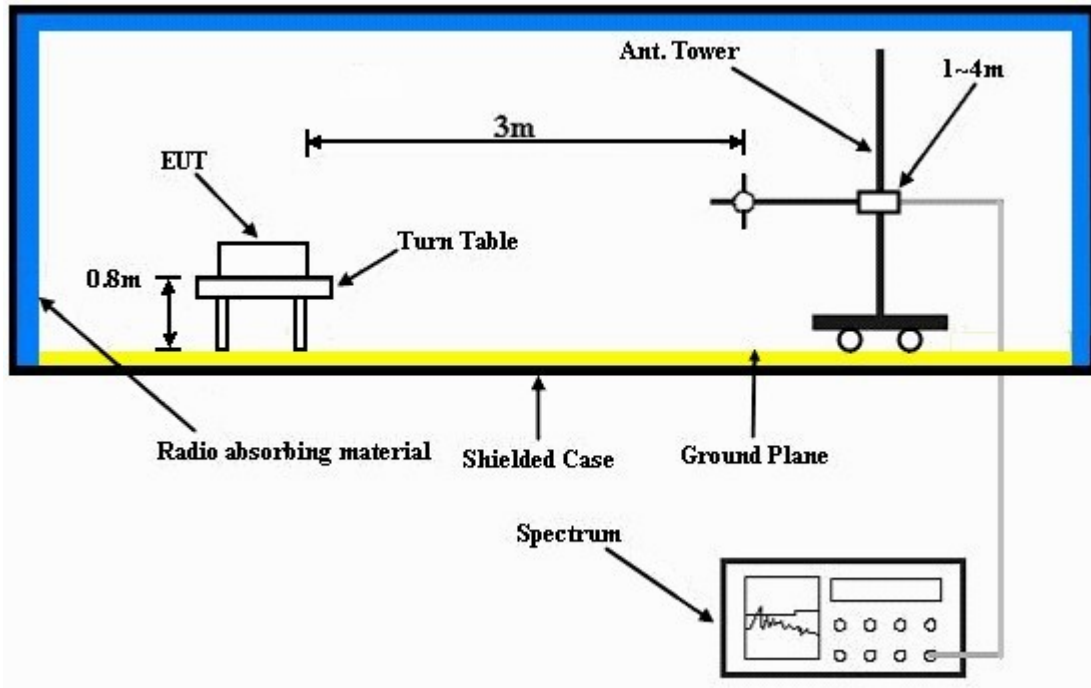

For the actual test configuration, please refer to the attached file (Test Setup Photo).

4.1.7 EUT OPERATING CONDITION

- a. Plugged the EUT into notebook via external board and placed them on the testing table.
- b. The notebook system ran a test program (provided by manufacturer) to enable EUT under transmission condition continuously at specific channel frequency.
- c. The necessary accessories enable the system in full functions.

4.1.8 TEST RESULTS

ABOVE 1GHz DATA : 802.11a

EUT TEST CONDITION		MEASUREMENT DETAIL	
CHANNEL	Channel 36	FREQUENCY RANGE	1 ~ 40GHz
INPUT POWER (SYSTEM)	120Vac, 60 Hz	DETECTOR FUNCTION	Peak (PK) Average (AV)
ENVIRONMENTAL CONDITIONS	25deg. C, 64%RH	TESTED BY	Sun Lin

ANTENNA POLARITY & TEST DISTANCE: HORIZONTAL AT 3 M								
NO.	FREQ. (MHz)	EMISSION LEVEL (dBuV/m)	LIMIT (dBuV/m)	MARGIN (dB)	ANTENNA HEIGHT (m)	TABLE ANGLE (Degree)	RAW VALUE (dBuV)	CORRECTION FACTOR (dB/m)
1	5128.00	56.0 PK	74.0	-18.0	1.50 H	94	17.90	38.10
2	5128.00	45.4 AV	54.0	-8.6	1.50 H	94	7.30	38.10
3	*5180.00	107.8 PK			1.53 H	94	69.60	38.20
4	*5180.00	95.7 AV			1.53 H	94	57.50	38.20
5	#10360.00	57.5 PK	68.3	-10.8	1.15 H	121	9.50	48.00
ANTENNA POLARITY & TEST DISTANCE: VERTICAL AT 3 M								
NO.	FREQ. (MHz)	EMISSION LEVEL (dBuV/m)	LIMIT (dBuV/m)	MARGIN (dB)	ANTENNA HEIGHT (m)	TABLE ANGLE (Degree)	RAW VALUE (dBuV)	CORRECTION FACTOR (dB/m)
1	5128.00	51.2 PK	74.0	-22.8	1.12 V	217	13.10	38.10
2	5128.00	40.5 AV	54.0	-13.5	1.12 V	217	2.40	38.10
3	*5180.00	102.8 PK			1.12 V	212	64.60	38.20
4	*5180.00	91.2 AV			1.12 V	212	53.00	38.20
5	#10360.00	55.3 PK	68.3	-13.0	1.39 V	82	7.30	48.00

- REMARKS:**
1. Emission level (dBuV/m) = Raw Value (dBuV) + Correction Factor (dB/m).
 2. Correction Factor (dB/m) = Antenna Factor (dB/m) + Cable Factor (dB).
 3. The other emission levels were very low against the limit.
 4. Margin value = Emission level – Limit value.
 5. “ * “: Fundamental frequency.
 6. “#”:The radiated frequency is out the restricted band.



A D T

EUT TEST CONDITION		MEASUREMENT DETAIL	
CHANNEL	Channel 40	FREQUENCY RANGE	1 ~ 40GHz
INPUT POWER (SYSTEM)	120Vac, 60 Hz	DETECTOR FUNCTION	Peak (PK) Average (AV)
ENVIRONMENTAL CONDITIONS	25deg. C, 64%RH	TESTED BY	Sun Lin

ANTENNA POLARITY & TEST DISTANCE: HORIZONTAL AT 3 M								
NO.	FREQ. (MHz)	EMISSION LEVEL (dBuV/m)	LIMIT (dBuV/m)	MARGIN (dB)	ANTENNA HEIGHT (m)	TABLE ANGLE (Degree)	RAW VALUE (dBuV)	CORRECTION FACTOR (dB/m)
1	*5200.00	107.5 PK			1.43 H	92	69.30	38.20
2	*5200.00	95.6 AV			1.43 H	92	57.40	38.20
3	#6933.00	53.6 PK	68.3	-14.7	1.52 H	217	10.70	42.90
4	#10400.00	57.1 PK	68.3	-11.2	1.05 H	117	9.00	48.10
ANTENNA POLARITY & TEST DISTANCE: VERTICAL AT 3 M								
NO.	FREQ. (MHz)	EMISSION LEVEL (dBuV/m)	LIMIT (dBuV/m)	MARGIN (dB)	ANTENNA HEIGHT (m)	TABLE ANGLE (Degree)	RAW VALUE (dBuV)	CORRECTION FACTOR (dB/m)
1	*5200.00	102.5 PK			1.01 V	217	64.30	38.20
2	*5200.00	90.9 AV			1.01 V	217	52.70	38.20
3	#6933.00	50.3 PK	68.3	-18.0	1.14 V	329	7.40	42.90
4	#10400.00	55.4 PK	68.3	-12.9	1.35 V	78	7.30	48.10

- REMARKS:**
1. Emission level (dBuV/m) = Raw Value (dBuV) + Correction Factor (dB/m).
 2. Correction Factor (dB/m) = Antenna Factor (dB/m) + Cable Factor (dB).
 3. The other emission levels were very low against the limit.
 4. Margin value = Emission level – Limit value.
 5. “ * “: Fundamental frequency.
 6. “#”:The radiated frequency is out the restricted band.



A D T

EUT TEST CONDITION		MEASUREMENT DETAIL	
CHANNEL	Channel 48	FREQUENCY RANGE	1 ~ 40GHz
INPUT POWER (SYSTEM)	120Vac, 60 Hz	DETECTOR FUNCTION	Peak (PK) Average (AV)
ENVIRONMENTAL CONDITIONS	25deg. C, 64%RH	TESTED BY	Sun Lin

ANTENNA POLARITY & TEST DISTANCE: HORIZONTAL AT 3 M								
NO.	FREQ. (MHz)	EMISSION LEVEL (dBuV/m)	LIMIT (dBuV/m)	MARGIN (dB)	ANTENNA HEIGHT (m)	TABLE ANGLE (Degree)	RAW VALUE (dBuV)	CORRECTION FACTOR (dB/m)
1	*5240.00	107.2 PK			1.48 H	84	68.90	38.30
2	*5240.00	95.5 AV			1.48 H	84	57.20	38.30
3	5350.00	54.6 PK	74.0	-19.4	1.44 H	89	16.10	38.50
4	5350.00	42.2 AV	54.0	-11.8	1.44 H	89	3.70	38.50
5	#10480.00	56.3 PK	68.3	-12.0	1.15 H	123	8.10	48.20
ANTENNA POLARITY & TEST DISTANCE: VERTICAL AT 3 M								
NO.	FREQ. (MHz)	EMISSION LEVEL (dBuV/m)	LIMIT (dBuV/m)	MARGIN (dB)	ANTENNA HEIGHT (m)	TABLE ANGLE (Degree)	RAW VALUE (dBuV)	CORRECTION FACTOR (dB/m)
1	*5240.00	102.2 PK			1.08 V	210	63.90	38.30
2	*5240.00	90.7 AV			1.08 V	210	52.40	38.30
3	5350.00	49.3 PK	74.0	-24.7	1.01 V	215	10.80	38.50
4	5350.00	35.8 AV	54.0	-18.2	1.01 V	215	-2.70	38.50
5	#10480.00	55.1 PK	68.3	-13.2	1.34 V	65	6.90	48.20

- REMARKS:**
1. Emission level (dBuV/m) = Raw Value (dBuV) + Correction Factor (dB/m).
 2. Correction Factor (dB/m) = Antenna Factor (dB/m) + Cable Factor (dB).
 3. The other emission levels were very low against the limit.
 4. Margin value = Emission level – Limit value.
 5. “ * “: Fundamental frequency.
 6. “#”:The radiated frequency is out the restricted band.

802.11n (20MHz)

EUT TEST CONDITION		MEASUREMENT DETAIL	
CHANNEL	Channel 36	FREQUENCY RANGE	1 ~ 40GHz
INPUT POWER (SYSTEM)	120Vac, 60 Hz	DETECTOR FUNCTION	Peak (PK) Average (AV)
ENVIRONMENTAL CONDITIONS	25deg. C, 64%RH	TESTED BY	Sun Lin

ANTENNA POLARITY & TEST DISTANCE: HORIZONTAL AT 3 M								
NO.	FREQ. (MHz)	EMISSION LEVEL (dBuV/m)	LIMIT (dBuV/m)	MARGIN (dB)	ANTENNA HEIGHT (m)	TABLE ANGLE (Degree)	RAW VALUE (dBuV)	CORRECTION FACTOR (dB/m)
1	5150.00	56.3 PK	74.0	-17.7	1.12 H	218	18.10	38.20
2	5150.00	44.2 AV	54.0	-9.8	1.12 H	218	6.00	38.20
3	*5180.00	102.7 PK			1.12 H	217	64.50	38.20
4	*5180.00	92.3 AV			1.12 H	217	54.10	38.20
5	#10360.00	56.7 PK	68.3	-11.6	1.08 H	304	8.70	48.00
ANTENNA POLARITY & TEST DISTANCE: VERTICAL AT 3 M								
NO.	FREQ. (MHz)	EMISSION LEVEL (dBuV/m)	LIMIT (dBuV/m)	MARGIN (dB)	ANTENNA HEIGHT (m)	TABLE ANGLE (Degree)	RAW VALUE (dBuV)	CORRECTION FACTOR (dB/m)
1	5128.00	56.7 PK	74.0	-17.3	1.02 V	271	18.60	38.10
2	5128.00	45.6 AV	54.0	-8.4	1.02 V	271	7.50	38.10
3	*5180.00	103.2 PK			1.02 V	280	65.00	38.20
4	*5180.00	92.9 AV			1.02 V	280	54.70	38.20
5	#10360.00	56.2 PK	68.3	-12.1	1.35 V	128	8.20	48.00

- REMARKS:**
1. Emission level (dBuV/m) = Raw Value (dBuV) + Correction Factor (dB/m).
 2. Correction Factor (dB/m) = Antenna Factor (dB/m) + Cable Factor (dB).
 3. The other emission levels were very low against the limit.
 4. Margin value = Emission level – Limit value.
 5. “ * “: Fundamental frequency.
 6. “#”:The radiated frequency is out the restricted band.



A D T

EUT TEST CONDITION		MEASUREMENT DETAIL	
CHANNEL	Channel 40	FREQUENCY RANGE	1 ~ 40GHz
INPUT POWER (SYSTEM)	120Vac, 60 Hz	DETECTOR FUNCTION	Peak (PK) Average (AV)
ENVIRONMENTAL CONDITIONS	25deg. C, 64%RH	TESTED BY	Sun Lin

ANTENNA POLARITY & TEST DISTANCE: HORIZONTAL AT 3 M								
NO.	FREQ. (MHz)	EMISSION LEVEL (dBuV/m)	LIMIT (dBuV/m)	MARGIN (dB)	ANTENNA HEIGHT (m)	TABLE ANGLE (Degree)	RAW VALUE (dBuV)	CORRECTION FACTOR (dB/m)
1	#3467.00	53.5 PK	68.3	-14.8	1.44 H	122	19.50	34.00
2	*5200.00	102.4 PK			1.05 H	278	64.20	38.20
3	*5200.00	92.0 AV			1.05 H	278	53.80	38.20
4	#10400.00	56.2 PK	68.3	-12.1	1.08 H	300	8.10	48.10
ANTENNA POLARITY & TEST DISTANCE: VERTICAL AT 3 M								
NO.	FREQ. (MHz)	EMISSION LEVEL (dBuV/m)	LIMIT (dBuV/m)	MARGIN (dB)	ANTENNA HEIGHT (m)	TABLE ANGLE (Degree)	RAW VALUE (dBuV)	CORRECTION FACTOR (dB/m)
1	#3467.00	49.8 PK	68.3	-18.5	1.80 V	34	15.80	34.00
2	*5200.00	103.0 PK			1.17 V	215	64.80	38.20
3	*5200.00	92.6 AV			1.17 V	215	54.40	38.20
4	#10400.00	57.5 PK	68.3	-10.8	1.28 V	147	9.40	48.10

- REMARKS:**
1. Emission level (dBuV/m) = Raw Value (dBuV) + Correction Factor (dB/m).
 2. Correction Factor (dB/m) = Antenna Factor (dB/m) + Cable Factor (dB).
 3. The other emission levels were very low against the limit.
 4. Margin value = Emission level – Limit value.
 5. “ * “: Fundamental frequency.
 6. “#”:The radiated frequency is out the restricted band.



A D T

EUT TEST CONDITION		MEASUREMENT DETAIL	
CHANNEL	Channel 48	FREQUENCY RANGE	1 ~ 40GHz
INPUT POWER (SYSTEM)	120Vac, 60 Hz	DETECTOR FUNCTION	Peak (PK) Average (AV)
ENVIRONMENTAL CONDITIONS	25deg. C, 64%RH	TESTED BY	Sun Lin

ANTENNA POLARITY & TEST DISTANCE: HORIZONTAL AT 3 M								
NO.	FREQ. (MHz)	EMISSION LEVEL (dBuV/m)	LIMIT (dBuV/m)	MARGIN (dB)	ANTENNA HEIGHT (m)	TABLE ANGLE (Degree)	RAW VALUE (dBuV)	CORRECTION FACTOR (dB/m)
1	*5240.00	102.1 PK			1.03 H	292	63.80	38.30
2	*5240.00	91.6 AV			1.03 H	292	53.30	38.30
3	5350.00	55.3 PK	74.0	-18.7	1.03 H	292	16.80	38.50
4	5350.00	42.8 AV	54.0	-11.2	1.03 H	292	4.30	38.50
5	#10480.00	56.3 PK	68.3	-12.0	1.15 H	298	8.10	48.20
ANTENNA POLARITY & TEST DISTANCE: VERTICAL AT 3 M								
NO.	FREQ. (MHz)	EMISSION LEVEL (dBuV/m)	LIMIT (dBuV/m)	MARGIN (dB)	ANTENNA HEIGHT (m)	TABLE ANGLE (Degree)	RAW VALUE (dBuV)	CORRECTION FACTOR (dB/m)
1	*5240.00	102.6 PK			1.00 V	259	64.30	38.30
2	*5240.00	92.2 AV			1.00 V	259	53.90	38.30
3	5350.00	56.0 PK	74.0	-18.0	1.12 V	242	17.50	38.50
4	5350.00	43.3 AV	54.0	-10.7	1.12 V	242	4.80	38.50
5	#10480.00	56.7 PK	68.3	-11.6	1.28 V	112	8.50	48.20

- REMARKS:**
1. Emission level (dBuV/m) = Raw Value (dBuV) + Correction Factor (dB/m).
 2. Correction Factor (dB/m) = Antenna Factor (dB/m) + Cable Factor (dB).
 3. The other emission levels were very low against the limit.
 4. Margin value = Emission level – Limit value.
 5. “ * “: Fundamental frequency.
 6. “#”:The radiated frequency is out the restricted band.

802.11n (40MHz)

EUT TEST CONDITION		MEASUREMENT DETAIL	
CHANNEL	Channel 38	FREQUENCY RANGE	1 ~ 40GHz
INPUT POWER (SYSTEM)	120Vac, 60 Hz	DETECTOR FUNCTION	Peak (PK) Average (AV)
ENVIRONMENTAL CONDITIONS	25deg. C, 64%RH	TESTED BY	Sun Lin

ANTENNA POLARITY & TEST DISTANCE: HORIZONTAL AT 3 M								
NO.	FREQ. (MHz)	EMISSION LEVEL (dBuV/m)	LIMIT (dBuV/m)	MARGIN (dB)	ANTENNA HEIGHT (m)	TABLE ANGLE (Degree)	RAW VALUE (dBuV)	CORRECTION FACTOR (dB/m)
1	5150.00	56.2 PK	74.0	-17.8	1.17 H	213	18.00	38.20
2	5150.00	43.6 AV	54.0	-10.4	1.17 H	213	5.40	38.20
3	*5190.00	98.7 PK			1.18 H	223	60.50	38.20
4	*5190.00	88.8 AV			1.18 H	223	50.60	38.20
5	#10380.00	56.5 PK	68.3	-11.8	1.12 H	289	8.50	48.00

ANTENNA POLARITY & TEST DISTANCE: VERTICAL AT 3 M								
NO.	FREQ. (MHz)	EMISSION LEVEL (dBuV/m)	LIMIT (dBuV/m)	MARGIN (dB)	ANTENNA HEIGHT (m)	TABLE ANGLE (Degree)	RAW VALUE (dBuV)	CORRECTION FACTOR (dB/m)
1	5150.00	56.7 PK	74.0	-17.3	1.01 V	271	18.50	38.20
2	5150.00	44.1 AV	54.0	-9.9	1.01 V	271	5.90	38.20
3	*5190.00	99.2 PK			1.00 V	272	61.00	38.20
4	*5190.00	89.3 AV			1.00 V	272	51.10	38.20
5	#10380.00	56.8 PK	68.3	-11.5	1.28 V	122	8.80	48.00

- REMARKS:**
1. Emission level (dBuV/m) = Raw Value (dBuV) + Correction Factor (dB/m).
 2. Correction Factor (dB/m) = Antenna Factor (dB/m) + Cable Factor (dB).
 3. The other emission levels were very low against the limit.
 4. Margin value = Emission level – Limit value.
 5. “ * “: Fundamental frequency.
 6. “#”:The radiated frequency is out the restricted band.



A D T

EUT TEST CONDITION		MEASUREMENT DETAIL	
CHANNEL	Channel 46	FREQUENCY RANGE	1 ~ 40GHz
INPUT POWER (SYSTEM)	120Vac, 60 Hz	DETECTOR FUNCTION	Peak (PK) Average (AV)
ENVIRONMENTAL CONDITIONS	25deg. C, 64%RH	TESTED BY	Sun Lin

ANTENNA POLARITY & TEST DISTANCE: HORIZONTAL AT 3 M								
NO.	FREQ. (MHz)	EMISSION LEVEL (dBuV/m)	LIMIT (dBuV/m)	MARGIN (dB)	ANTENNA HEIGHT (m)	TABLE ANGLE (Degree)	RAW VALUE (dBuV)	CORRECTION FACTOR (dB/m)
1	*5230.00	98.2 PK			1.21 H	205	59.90	38.30
2	*5230.00	88.2 AV			1.21 H	205	49.90	38.30
3	5350.00	53.6 PK	74.0	-20.4	1.18 H	212	15.10	38.50
4	5350.00	42.5 AV	54.0	-11.5	1.18 H	212	4.00	38.50
5	#10460.00	56.1 PK	68.3	-12.2	1.12 H	293	7.90	48.20
ANTENNA POLARITY & TEST DISTANCE: VERTICAL AT 3 M								
NO.	FREQ. (MHz)	EMISSION LEVEL (dBuV/m)	LIMIT (dBuV/m)	MARGIN (dB)	ANTENNA HEIGHT (m)	TABLE ANGLE (Degree)	RAW VALUE (dBuV)	CORRECTION FACTOR (dB/m)
1	*5230.00	98.8 PK			1.00 V	268	60.50	38.30
2	*5230.00	89.0 AV			1.00 V	268	50.70	38.30
3	5350.00	54.1 PK	74.0	-19.9	1.02 V	282	15.60	38.50
4	5350.00	42.8 AV	54.0	-11.2	1.02 V	282	4.30	38.50
5	#10460.00	56.3 PK	68.3	-12.0	1.22 V	135	8.10	48.20

- REMARKS:**
1. Emission level (dBuV/m) = Raw Value (dBuV) + Correction Factor (dB/m).
 2. Correction Factor (dB/m) = Antenna Factor (dB/m) + Cable Factor (dB).
 3. The other emission levels were very low against the limit.
 4. Margin value = Emission level – Limit value.
 5. “ * “: Fundamental frequency.
 6. “#”:The radiated frequency is out the restricted band.

BELOW 1GHz WORST-CASE DATA : 802.11a

EUT TEST CONDITION		MEASUREMENT DETAIL	
CHANNEL	Channel 36	FREQUENCY RANGE	Below 1000MHz
INPUT POWER (SYSTEM)	120Vac, 60 Hz	DETECTOR FUNCTION	Quasi-Peak
ENVIRONMENTAL CONDITIONS	25deg. C, 65%RH	TESTED BY	Anderson Hong

ANTENNA POLARITY & TEST DISTANCE: HORIZONTAL AT 3 M								
NO.	FREQ. (MHz)	EMISSION LEVEL (dBuV/m)	LIMIT (dBuV/m)	MARGIN (dB)	ANTENNA HEIGHT (m)	TABLE ANGLE (Degree)	RAW VALUE (dBuV)	CORRECTION FACTOR (dB/m)
1	98.04	34.9 QP	43.5	-8.6	2.00 H	226	25.60	9.30
2	234.11	35.1 QP	46.0	-10.9	1.25 H	208	22.60	12.50
3	298.26	31.2 QP	46.0	-14.8	1.00 H	10	16.30	14.90
4	545.13	27.6 QP	46.0	-18.4	1.00 H	154	6.40	21.20
5	626.77	30.9 QP	46.0	-15.1	1.25 H	166	8.30	22.60
6	832.83	37.3 QP	46.0	-8.7	2.00 H	319	11.70	25.60
ANTENNA POLARITY & TEST DISTANCE: VERTICAL AT 3 M								
NO.	FREQ. (MHz)	EMISSION LEVEL (dBuV/m)	LIMIT (dBuV/m)	MARGIN (dB)	ANTENNA HEIGHT (m)	TABLE ANGLE (Degree)	RAW VALUE (dBuV)	CORRECTION FACTOR (dB/m)
1	37.78	37.2 QP	40.0	-2.8	1.00 V	97	23.90	13.30
2	99.98	32.9 QP	43.5	-10.6	1.25 V	10	23.40	9.50
3	166.07	32.0 QP	43.5	-11.5	1.00 V	313	18.20	13.80
4	243.83	29.8 QP	46.0	-16.2	1.25 V	109	16.90	12.90
5	432.38	27.2 QP	46.0	-18.8	1.25 V	331	8.80	18.40
6	700.64	31.8 QP	46.0	-14.2	1.50 V	163	8.90	22.90

- REMARKS:**
1. Emission level (dBuV/m) = Raw Value (dBuV) + Correction Factor (dB/m).
 2. Correction Factor (dB/m) = Antenna Factor (dB/m) + Cable Factor (dB).
 3. The other emission levels were very low against the limit.
 4. Margin value = Emission level – Limit value.

4.2 CONDUCTED EMISSION MEASUREMENT

4.2.1 LIMITS OF CONDUCTED EMISSION MEASUREMENT

FREQUENCY OF EMISSION (MHz)	CONDUCTED LIMIT (dB μ V)	
	Quasi-peak	Average
0.15 ~ 0.5	66 to 56	56 to 46
0.5 ~ 5	56	46
5 ~ 30	60	50

- NOTE:**
1. The lower limit shall apply at the transition frequencies.
 2. The limit decreases in line with the logarithm of the frequency in the range of 0.15 to 0.50MHz.
 3. All emanations from a class A/B digital device or system, including any network of conductors and apparatus connected thereto, shall not exceed the level of field strengths specified above.

4.2.2 TEST INSTRUMENTS

DESCRIPTION & MANUFACTURER	MODEL NO.	SERIAL NO.	DATE OF CALIBRATION	DUE DATE OF CALIBRATION
Test Receiver ROHDE & SCHWARZ	ESCS30	100289	Nov. 19, 2011	Nov. 18, 2012
RF signal cable Woken	5D-FB	Cable-HYCO2-01	Dec. 22, 2011	Dec. 21, 2012
LISN ROHDE & SCHWARZ	ESH2-Z5	100100	Dec. 30, 2011	Dec. 29, 2012
LISN ROHDE & SCHWARZ	ESH3-Z5	100312	Jul. 07, 2011	Jul. 06, 2012
V-LISN SCHWARZBECK	NNBL 8226-2	8226-142	Jun. 30, 2011	Jun. 29, 2012
LISN ROHDE & SCHWARZ	ENV216	100072	Jun. 10, 2011	Jun. 09, 2012
Software ADT	ADT_Cond_ V7.3.7	NA	NA	NA

- NOTE:**
1. The calibration interval of the above test instruments is 12 months and the calibrations are traceable to NML/ROC and NIST/USA.
 2. The test was performed in HwaYa Shielded Room 2.
 3. The VCCI Site Registration No. is C-2047.

4.2.3 TEST PROCEDURES

- a. The EUT was placed 0.4 meters from the conducting wall of the shielded room with EUT being connected to the power mains through a line impedance stabilization network (LISN). Other support units were connected to the power mains through another LISN. The two LISNs provide 50 ohm/ 50uH of coupling impedance for the measuring instrument.
- b. Both lines of the power mains connected to the EUT were checked for maximum conducted interference.
- c. The frequency range from 150kHz to 30MHz was searched. Emission levels under (Limit - 20dB) was not recorded.

NOTE: All modes of operation were investigated and the worst-case emissions are reported.

4.2.4 DEVIATION FROM TEST STANDARD

No deviation.

4.2.5 TEST SETUP

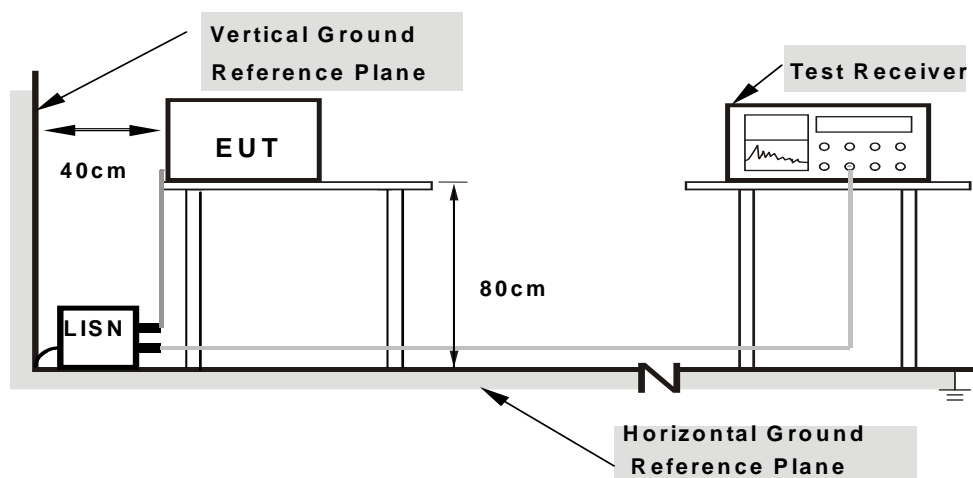

- Note:**
1. Support units were connected to second LISN.
 2. Both of LISNs (AMN) are 80 cm from EUT and at least 80 from other units and other metal planes

For the actual test configuration, please refer to the attached file (Test Setup Photo).

4.2.6 EUT OPERATING CONDITIONS

Same as 4.1.6.

4.2.7 TEST RESULTS

CONDUCTED WORST-CASE DATA : 802.11a

PHASE	Line 1	6dB BANDWIDTH	9kHz
-------	--------	---------------	------

No	Freq. [MHz]	Corr. Factor (dB)	Reading Value		Emission Level		Limit		Margin	
			[dB (uV)]		[dB (uV)]		[dB (uV)]		(dB)	
			Q.P.	AV.	Q.P.	AV.	Q.P.	AV.	Q.P.	AV.
1	0.15000	0.17	46.28	36.92	46.45	37.09	66.00	56.00	-19.55	-18.91
2	0.71250	0.22	38.17	30.19	38.39	30.41	56.00	46.00	-17.61	-15.59
3	0.86094	0.22	42.51	36.66	42.73	36.88	56.00	46.00	-13.27	-9.12
4	0.99766	0.23	39.92	31.22	40.15	31.45	56.00	46.00	-15.85	-14.55
5	1.28906	0.25	37.36	28.32	37.61	28.57	56.00	46.00	-18.39	-17.43
6	1.43750	0.26	39.48	29.87	39.74	30.13	56.00	46.00	-16.26	-15.87

- REMARKS:**
1. Q.P. and AV. are abbreviations of quasi-peak and average individually.
 2. "-": The Quasi-peak reading value also meets average limit and measurement with the average detector is unnecessary.
 3. The emission levels of other frequencies were very low against the limit.
 4. Margin value = Emission level - Limit value
 5. Correction factor = Insertion loss + Cable loss
 6. Emission Level = Correction Factor + Reading Value.

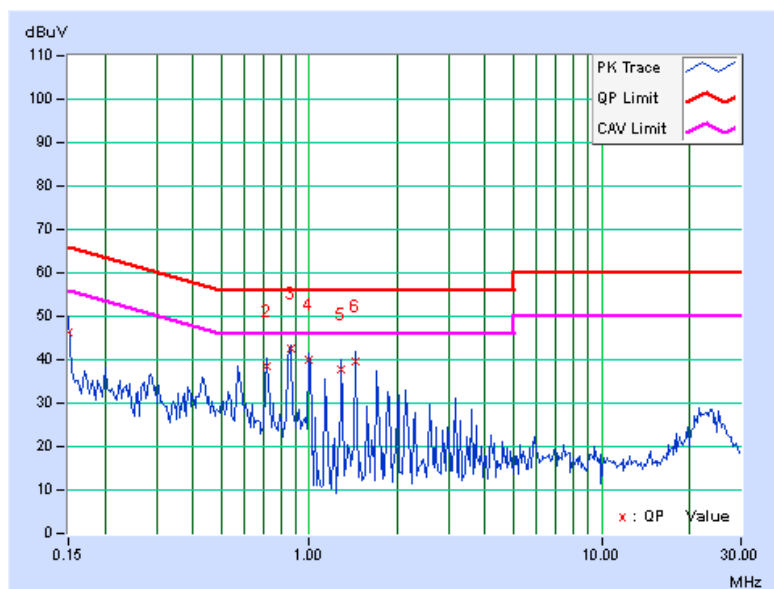



A D T

PHASE	Line 2	6dB BANDWIDTH	9kHz
-------	--------	---------------	------

No	Freq. [MHz]	Corr. Factor (dB)	Reading Value		Emission Level		Limit		Margin	
			[dB (uV)]		[dB (uV)]		[dB (uV)]		(dB)	
			Q.P.	AV.	Q.P.	AV.	Q.P.	AV.	Q.P.	AV.
1	0.15000	0.17	38.24	26.40	38.41	26.57	66.00	56.00	-27.59	-29.43
2	0.28741	0.16	36.30	32.44	36.46	32.60	60.60	50.60	-24.14	-18.00
3	0.42344	0.18	31.52	27.37	31.70	27.55	57.38	47.38	-25.68	-19.83
4	0.56303	0.18	33.60	24.52	33.78	24.70	56.00	46.00	-22.22	-21.30
5	0.84922	0.19	36.96	31.20	37.15	31.39	56.00	46.00	-18.85	-14.61
6	1.41797	0.22	36.65	27.31	36.87	27.53	56.00	46.00	-19.13	-18.47

- REMARKS:**
1. Q.P. and AV. are abbreviations of quasi-peak and average individually.
 2. "-": The Quasi-peak reading value also meets average limit and measurement with the average detector is unnecessary.
 3. The emission levels of other frequencies were very low against the limit.
 4. Margin value = Emission level - Limit value
 5. Correction factor = Insertion loss + Cable loss
 6. Emission Level = Correction Factor + Reading Value.

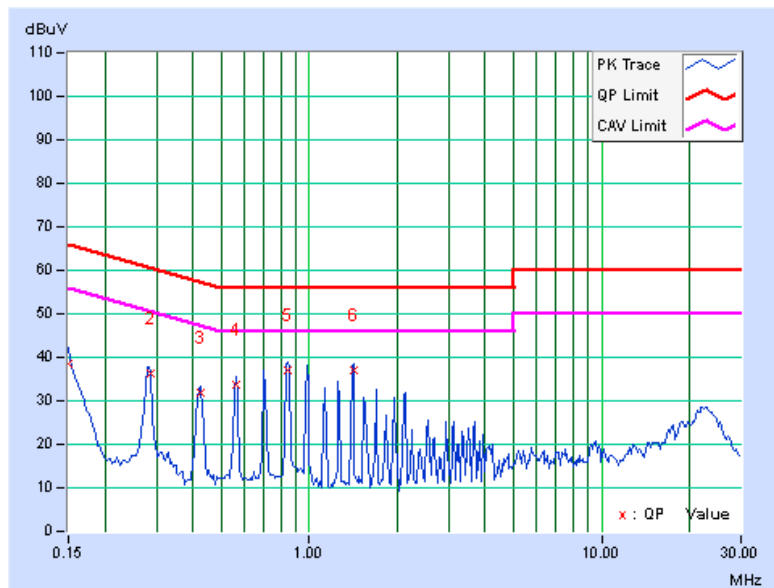

4.3 PEAK TRANSMIT POWER MEASUREMENT

4.3.1 LIMITS OF PEAK TRANSMIT POWER MEASUREMENT

FREQUENCY BAND	LIMIT
5.15 ~ 5.25GHz	The lesser of 50mW (17dBm) or 4dBm + 10logB

NOTE: Where B is the 26dB emission bandwidth in MHz.

4.3.2 TEST SETUP

FOR POWER OUTPUT MEASUREMENT

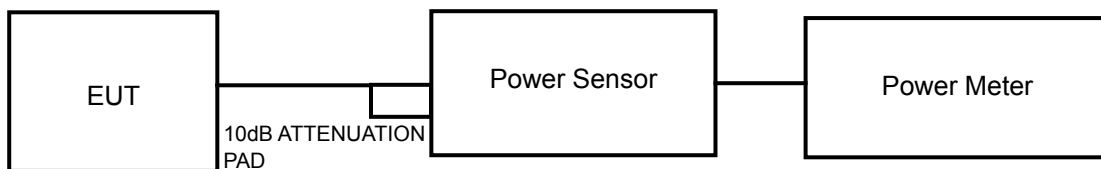

FOR 26dB BANDWIDTH

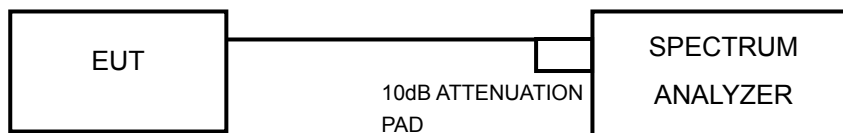

4.3.3 TEST INSTRUMENTS

Refer to section 4.1.3 to get information of above instrument.

4.3.4 TEST PROCEDURE

FOR AVERAGE POWER MEASUREMENT

An average power sensor was used on the output port of the EUT. A power meter was used to read the response of the average power sensor. Record the power level.

FOR 26dB BANDWIDTH

- 1) Set RBW = approximately 1% of the emission bandwidth.
- 2) Set the VBW > RBW.
- 3) Detector = Peak.
- 4) Trace mode = max hold.
- 5) Measure the maximum width of the emission that is 26 dB down from the peak of the emission. Compare this with the RBW setting of the analyzer. Readjust RBW and repeat measurement as needed until the RBW/EBW ratio is approximately 1%.

4.3.5 DEVIATION FROM TEST STANDARD

No deviation.

4.3.6 EUT OPERATING CONDITIONS

The software provided by client to enable the EUT under transmission condition continuously at specific channel frequencies individually.

4.3.7 TEST RESULTS

POWER OUTPUT: 802.11a

HANNEL	CHANNEL FREQUENCY (MHz)	AVERAGE POWER (mW)	AVERAGE POWER (dBm)	POWER LIMIT (dBm)	PASS/FAIL
36	5180	29.6	14.71	17	PASS
40	5200	29.9	14.75	17	PASS
48	5240	30.3	14.82	17	PASS

802.11n (20MHz)

CHAN.	CHAN. FREQ. (MHz)	AVERAGE POWER (dBm)		TOTAL POWER (mW)	TOTAL POWER (dBm)	POWER LIMIT (dBm)	PASS / FAIL
		CHAIN 0	CHAIN 1				
36	5180	11.58	11.72	29.2	14.7	17	PASS
40	5200	11.62	11.75	29.5	14.7	17	PASS
48	5240	11.57	11.71	29.2	14.7	17	PASS

802.11n (40MHz)

CHAN.	CHAN. FREQ. (MHz)	AVERAGE POWER (dBm)		TOTAL POWER (mW)	TOTAL POWER (dBm)	POWER LIMIT (dBm)	PASS / FAIL
		CHAIN 0	CHAIN 1				
38	5190	13.81	13.75	47.8	16.8	17	PASS
46	5230	13.86	13.84	48.5	16.9	17	PASS



26dB BANDWIDTH: 802.11a

CHANNEL	CHANNEL FREQUENCY (MHz)	26dBc BANDWIDTH (MHz)	PASS / FAIL
36	5180	19.88	PASS
40	5200	19.90	PASS
48	5240	20.01	PASS

802.11n (20MHz)

CHANNEL	CHANNEL FREQUENCY (MHz)	26dBc BANDWIDTH (MHz)		PASS / FAIL
		CHAIN 0	CHAIN 1	
36	5180	20.42	20.35	PASS
40	5200	20.47	20.39	PASS
48	5240	20.34	20.41	PASS

802.11n (40MHz)

CHANNEL	CHANNEL FREQUENCY (MHz)	26dBc BANDWIDTH (MHz)		PASS / FAIL
		CHAIN 0	CHAIN 1	
38	5190	41.16	41.25	PASS
46	5230	41.28	41.46	PASS

4.4 PEAK POWER SPECTRAL DENSITY MEASUREMENT

4.4.1 LIMITS OF PEAK POWER SPECTRAL DENSITY MEASUREMENT

FREQUENCY BAND	LIMIT
5.15 ~ 5.25GHz	4dBm

4.4.2 TEST SETUP



4.4.3 TEST INSTRUMENTS

Refer to section 4.1.3 to get information of above instrument.

4.4.4 TEST PROCEDURES

- 1) Set span to encompass the entire emission bandwidth (EBW) of the signal.
- 2) Set RBW = 1 MHz, Set VBW \geq 3 MHz, Detector = RMS
- 3) Sweep time = 100 second.
- 4) Perform a single sweep.
- 5) Record the max value

4.4.5 DEVIATION FROM TEST STANDARD

No deviation.

4.4.6 EUT OPERATING CONDITIONS

Same as 4.3.6.

4.4.7 TEST RESULTS

802.11a

CHANNEL	FREQUENCY (MHz)	PSD (dBm)	MAXIMUM LIMIT (dBm)	PASS/FAIL
36	5180	3.58	4	PASS
40	5200	3.52	4	PASS
48	5240	3.88	4	PASS

802.11n (20MHz)

CHAN.	CHAN. FREQ. (MHz)	PSD (dBm)		TOTAL POWER DENSITY (dBm)	MAX. LIMIT (dBm)	PASS / FAIL
		CHAIN 0	CHAIN 1			
36	5180	0.22	0.49	3.369	4	PASS
40	5200	0.41	0.75	3.555	4	PASS
48	5240	0.72	0.81	3.728	4	PASS

802.11n (40MHz)

CHAN.	CHAN. FREQ. (MHz)	PSD (dBm)		TOTAL POWER DENSITY (dBm)	MAX. LIMIT (dBm)	PASS / FAIL
		CHAIN 0	CHAIN 1			
38	5190	0.08	-0.20	2.894	4	PASS
46	5230	0.11	-0.03	3.034	4	PASS

4.5 PEAK POWER EXCURSION MEASUREMENT

4.5.1 LIMITS OF PEAK POWER EXCURSION MEASUREMENT

Shall not exceed 13 dB

4.5.2 TEST SETUP

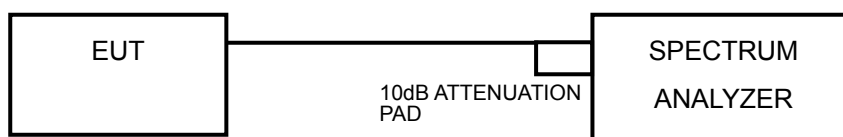

4.5.3 TEST INSTRUMENTS

Refer to section 4.1.3 to get information of above instrument.

4.5.4 TEST PROCEDURE

- 1) Set RBW = 1 MHz, VBW \leq 3 MHz, Detector = peak.
- 2) Trace mode = max-hold. Allow the sweeps to continue until the trace stabilizes.
- 3) Use the peak search function to find the peak of the spectrum.
- 4) Measure the PPSD.
- 5) Compute the ratio of the maximum of the peak-max-hold spectrum to the PPSD.

4.5.5 DEVIATION FROM TEST STANDARD

No deviation.

4.5.6 EUT OPERATING CONDITIONS

Same as 4.2.6



4.5.7 TEST RESULTS

802.11a

CHANNEL	CHANNEL FREQUENCY (MHz)	PEAK VALUE (dBm)	PPSD (dBm)	PEAK EXCURSION (dB)	LIMIT (dB)	PASS/FAIL
36	5180	13.16	3.58	9.58	13	PASS
44	5220	13.12	3.52	9.60	13	PASS
48	5240	13.22	3.88	9.34	13	PASS



A D T

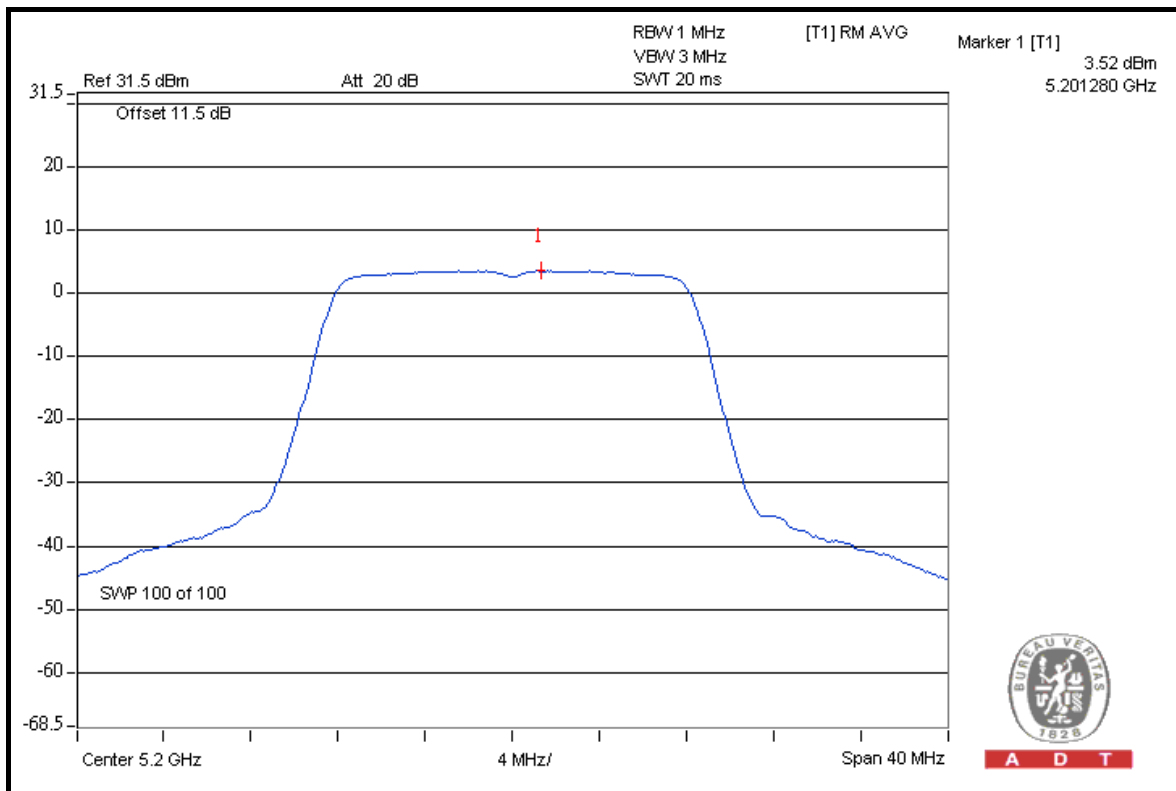
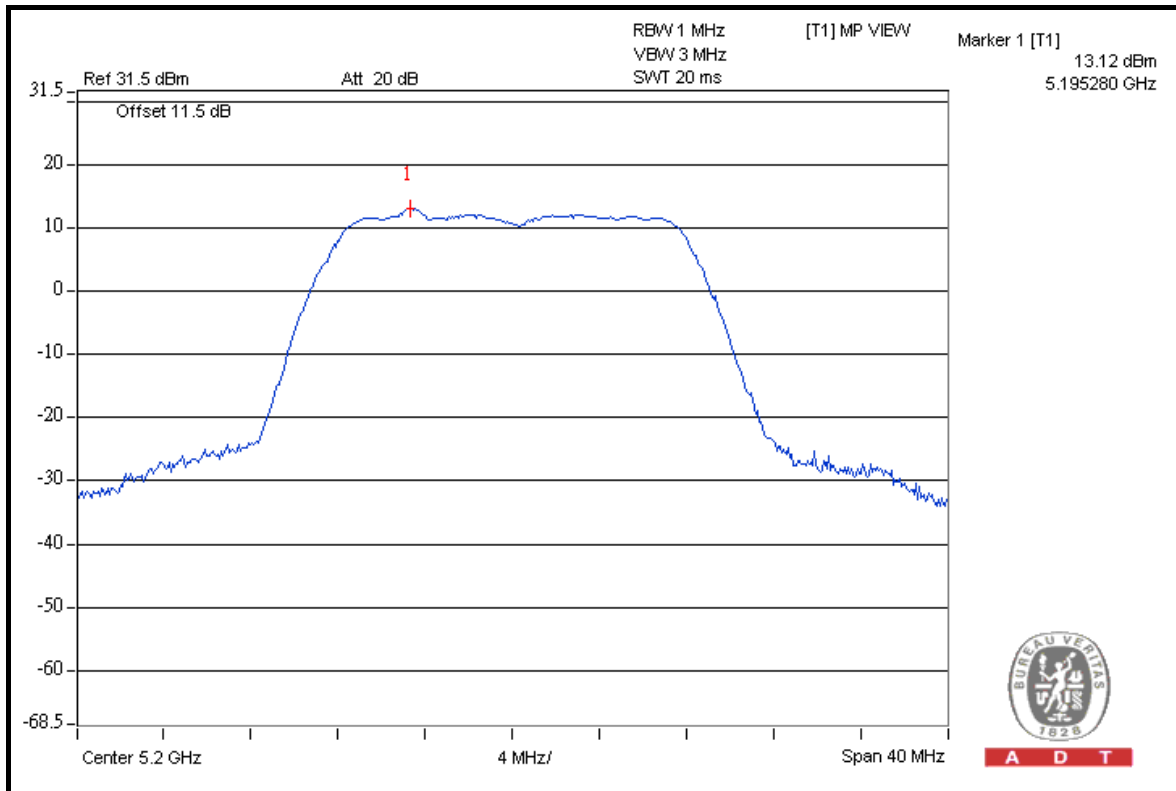



A D T

802.11n (20MHz)

TX chain	CHAN.	CHANNEL FREQUENCY (MHz)	PEAK VALUE (dBm)	PPSD (dBm)	PEAK EXCURSION (dB)	LIMIT (dB)	PASS /FAIL
0	36	5180	8.82	0.22	8.60	13	PASS
	40	5200	9.00	0.41	8.59	13	PASS
	48	5240	8.94	0.72	8.22	13	PASS
1	36	5180	9.36	0.49	8.87	13	PASS
	40	5200	9.55	0.75	8.80	13	PASS
	48	5240	9.53	0.81	8.72	13	PASS



A D T

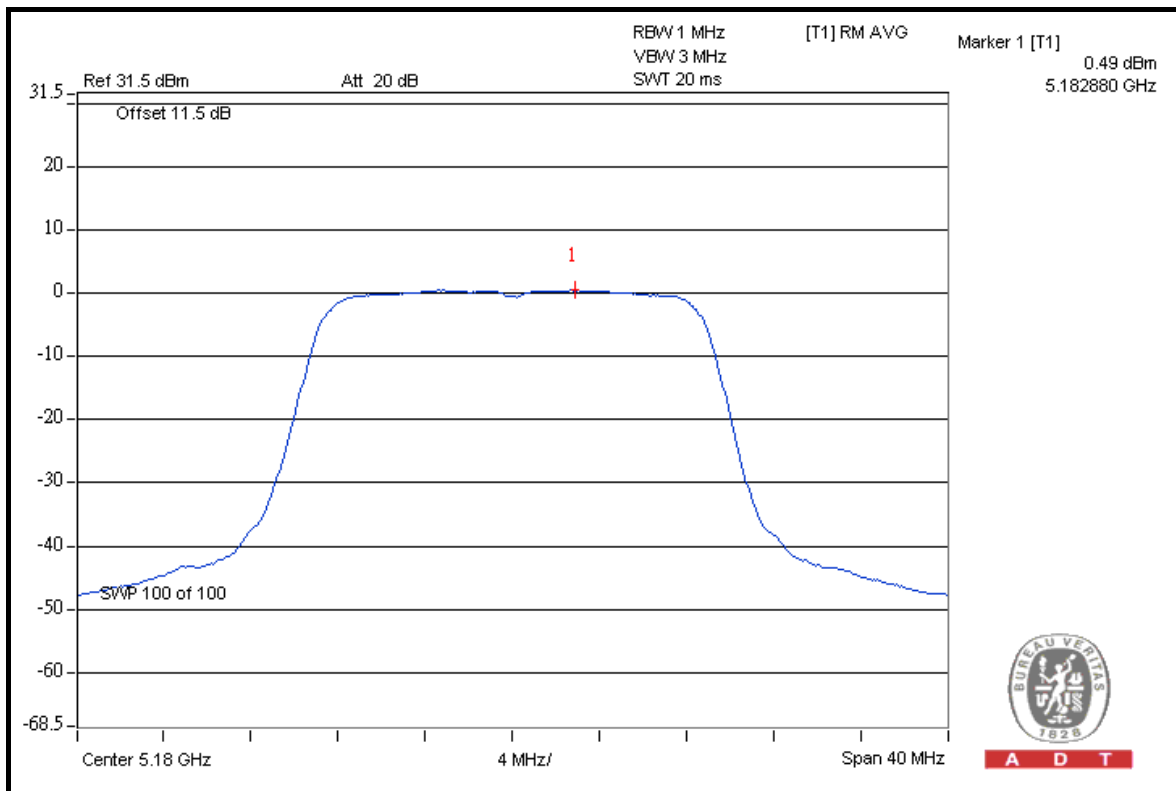
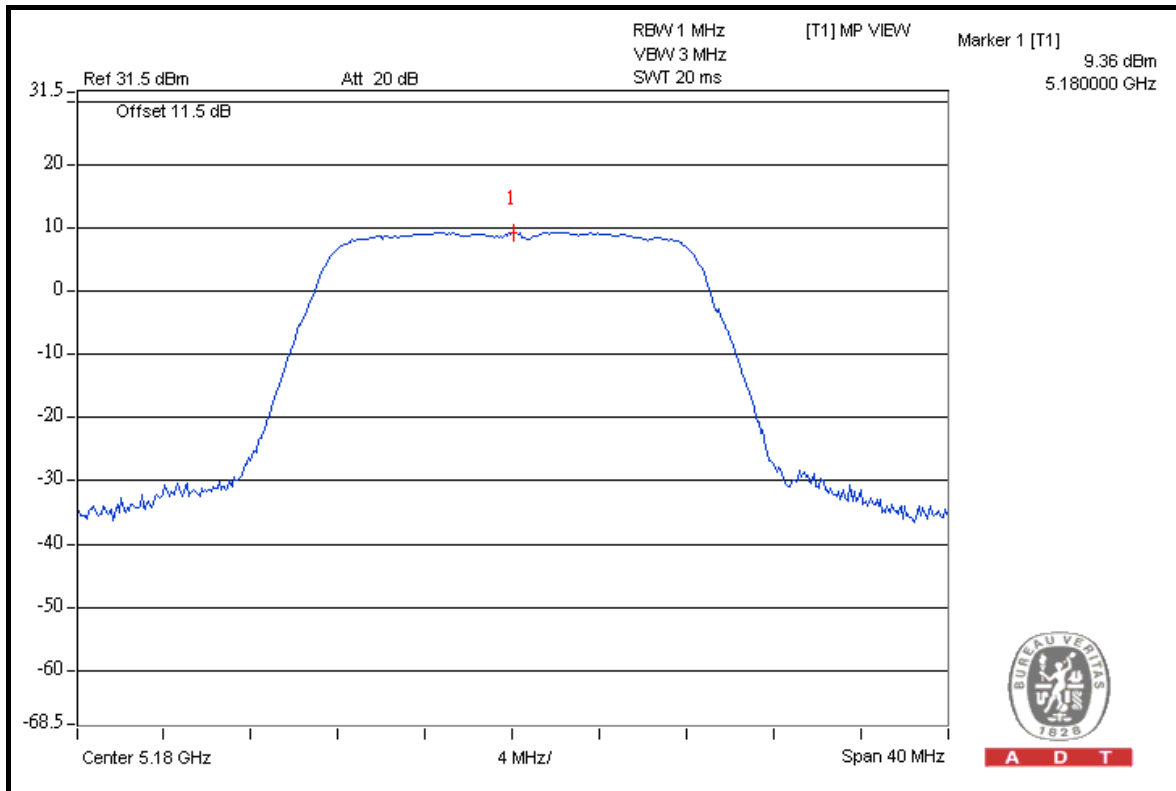



A D T

802.11n (40MHz)

TX chain	CHAN.	CHANNEL FREQUENCY (MHz)	PEAK VALUE (dBm)	PPSD (dBm)	PEAK EXCURSION (dB)	LIMIT (dB)	PASS /FAIL
0	38	5190	8.64	0.08	8.56	13	PASS
	46	5230	8.93	0.11	8.82	13	PASS
1	38	5190	8.66	-0.20	8.86	13	PASS
	46	5230	8.51	-0.03	8.54	13	PASS



A D T

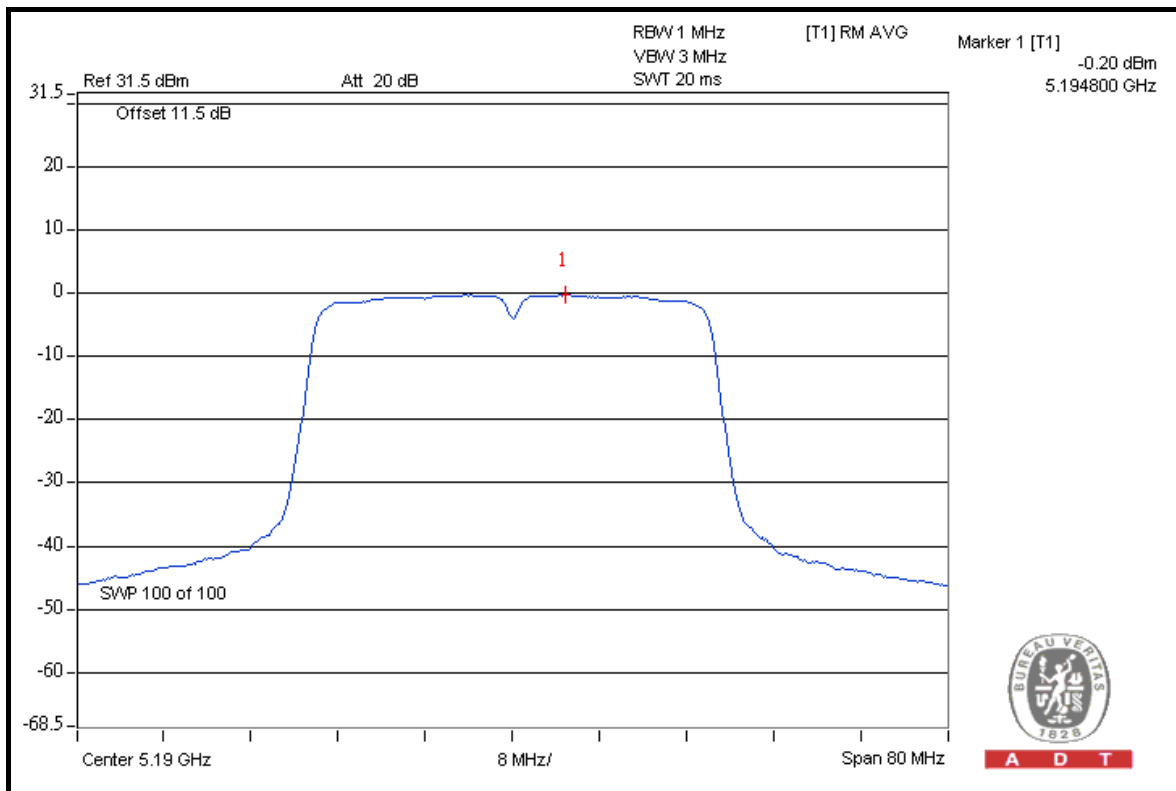
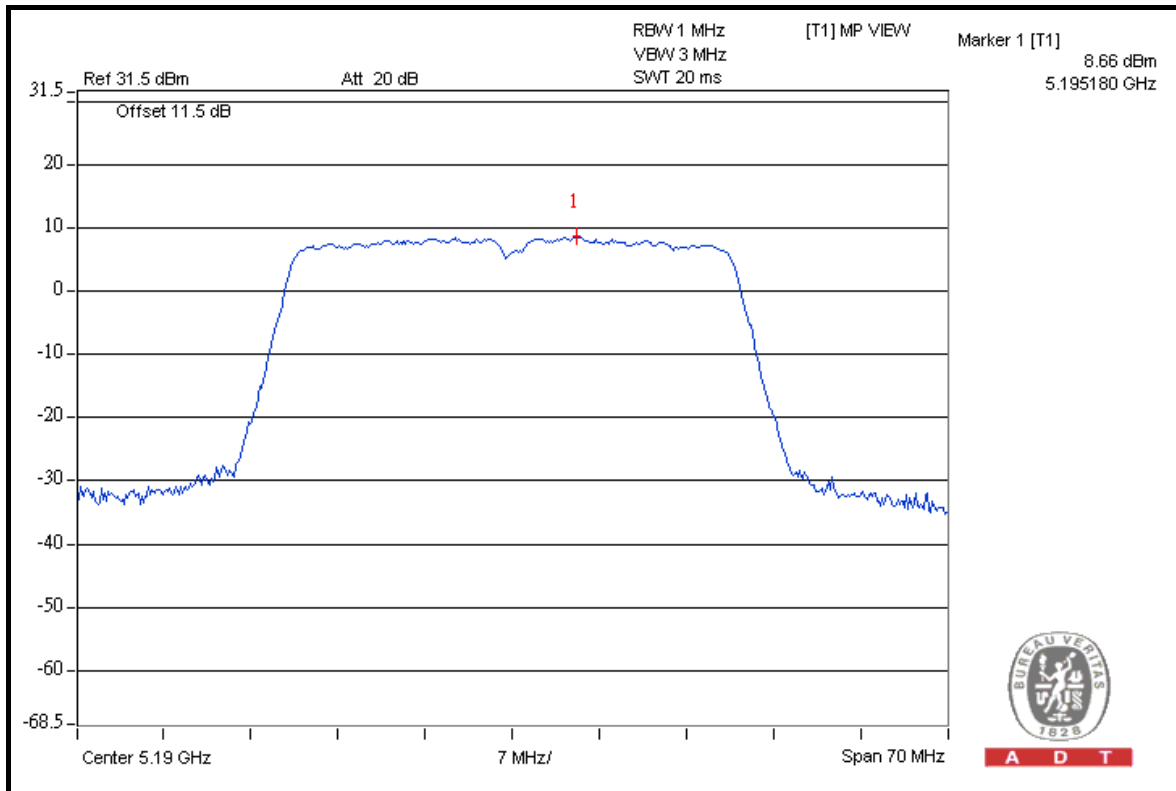

4.6 FREQUENCY STABILITY

4.6.1 LIMITS OF FREQUENCY STABILITY MEASUREMENT

The frequency of the carrier signal shall be maintained within band of operation

4.6.2 TEST SETUP

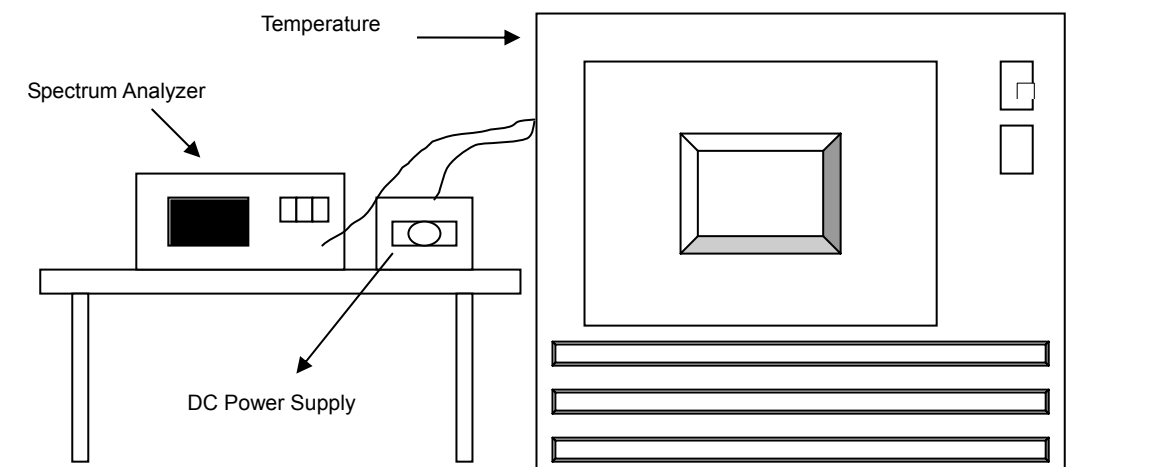

4.6.3 TEST INSTRUMENTS

Refer to section 4.1.3 to get information of above instrument.

4.6.4 TEST PROCEDURE

- a. The EUT was placed inside the environmental test chamber and powered by nominal DC voltage.
- b. Turn the EUT on and couple its output to a spectrum analyzer.
- c. Turn the EUT off and set the chamber to the highest temperature specified.
- d. Allow sufficient time (approximately 30 min) for the temperature of the chamber to stabilize, turn the EUT on and measure the operating frequency after 2, 5, and 10 minutes.
- e. Repeat step 2 and 3 with the temperature chamber set to the lowest temperature.
- f. The test chamber was allowed to stabilize at +20 degree C for a minimum of 30 minutes. The supply voltage was then adjusted on the EUT from 85% to 115% and the frequency record.

4.6.5 DEVIATION FROM TEST STANDARD

No deviation.

4.6.6 EUT OPERATING CONDITION

Set the EUT transmit at un-modulation mode to test frequency stability.

4.6.7 TEST RESULTS

FREQUENCY STABILITY VERSUS TEMP.									
OPERATING FREQUENCY: 5200MHz									
TEMP. (°C)	POWER SUPPLY (Vac)	0 MINUTE		2 MINUTE		5 MINUTE		10 MINUTE	
		Measured Frequency (MHz)	Frequency Drift (ppm)	Measured Frequency (MHz)	Frequency Drift (ppm)	Measured Frequency (MHz)	Frequency Drift (ppm)	Measured Frequency (MHz)	Frequency Drift (ppm)
50	110.0	5199.988821	-2.150	5199.989038	-2.108	5199.989237	-2.070	5199.989287	-2.060
40	110.0	5199.988386	-2.233	5199.988823	-2.149	5199.988328	-2.245	5199.988420	-2.227
30	110.0	5199.990127	-1.899	5199.990206	-1.883	5199.990189	-1.887	5199.990365	-1.853
20	110.0	5199.991142	-1.703	5199.991707	-1.595	5199.991621	-1.611	5199.991473	-1.640
10	110.0	5199.993451	-1.259	5199.993635	-1.224	5199.993200	-1.308	5199.993859	-1.181
0	110.0	5199.992069	-1.525	5199.991886	-1.560	5199.991836	-1.570	5199.992615	-1.420
-10	110.0	5199.989922	-1.938	5199.990163	-1.892	5199.989849	-1.952	5199.990146	-1.895
-20	110.0	5199.989499	-2.019	5199.989556	-2.008	5199.989277	-2.062	5199.989303	-2.057
-30	110.0	5199.988290	-2.252	5199.988714	-2.170	5199.988295	-2.251	5199.988322	-2.246

FREQUENCY STABILITY VERSUS VOLTAGE									
OPERATING FREQUENCY: 5200MHz									
TEMP. (°C)	POWER SUPPLY (Vac)	0 MINUTE		2 MINUTE		5 MINUTE		10 MINUTE	
		Measured Frequency (MHz)	Frequency Drift (ppm)	Measured Frequency (MHz)	Frequency Drift (ppm)	Measured Frequency (MHz)	Frequency Drift (ppm)	Measured Frequency (MHz)	Frequency Drift (ppm)
20	93.5	5199.991202	-1.692	5199.991312	-1.671	5199.991100	-1.712	5199.991734	-1.590
	110.0	5199.991142	-1.703	5199.991707	-1.595	5199.991621	-1.611	5199.991473	-1.640
	126.5	5199.991432	-1.648	5199.991227	-1.687	5199.991432	-1.648	5199.991220	-1.688

5. PHOTOGRAPHS OF THE TEST CONFIGURATION

Please refer to the attached file (Test Setup Photo).



6. INFORMATION ON THE TESTING LABORATORIES

We, Bureau Veritas Consumer Products Services (H.K.) Ltd., Taoyuan Branch, were founded in 1988 to provide our best service in EMC, Radio, Telecom and Safety consultation. Our laboratories are accredited and approved according to ISO/IEC 17025.

Copies of accreditation and authorization certificates of our laboratories obtained from approval agencies can be downloaded from our web site: www.adt.com.tw/index.5.phtml. If you have any comments, please feel free to contact us at the following:

Linko EMC/RF Lab:
Tel: 886-2-26052180
Fax: 886-2-26051924

Hsin Chu EMC/RF Lab:
Tel: 886-3-5935343
Fax: 886-3-5935342

Hwa Ya EMC/RF/Safety Telecom Lab:
Tel: 886-3-3183232
Fax: 886-3-3185050

Email: service.adt@tw.bureauveritas.com
Web Site: www.adt.com.tw

The address and road map of all our labs can be found in our web site also.

7. APPENDIX A - MODIFICATIONS RECORDERS FOR ENGINEERING CHANGES TO THE EUT BY THE LAB

No modifications were made to the EUT by the lab during the test.

---END---