



FCC TEST REPORT (15.247)

REPORT NO.: RF120305C07
MODEL NO.: DIR-826LMO1
FCC ID: KA2IR826LMO1
RECEIVED: Mar. 05, 2012
TESTED: Mar. 13 ~ Mar. 22, 2012
ISSUED: Mar. 26, 2012

APPLICANT: D-Link Corporation

ADDRESS: 17595 Mt. Herrmann, Fountain Valley, CA 92708,
U.S.A.

ISSUED BY: Bureau Veritas Consumer Products Services
(H.K.) Ltd., Taoyuan Branch

LAB ADDRESS: No. 47, 14th Ling, Chia Pau Vil., Lin Kou Dist.,
New Taipei City, Taiwan (R.O.C.)

TEST LOCATION: No. 19, Hwa Ya 2nd Rd, Wen Hwa Tsuen, Kwei
Shan Hsiang, Taoyuan Hsien 333, Taiwan, R.O.C.

This test report consists of 44 pages in total. It may be duplicated completely for legal use with the approval of the applicant. It should not be reproduced except in full, without the written approval of our laboratory. The client should not use it to claim product certification, approval or endorsement by TAF or any government agency. The test results in the report only apply to the tested sample.





TABLE OF CONTENTS

RELEASE CONTROL RECORD	4
1. CERTIFICATION	5
2. SUMMARY OF TEST RESULTS	6
2.1 MEASUREMENT UNCERTAINTY	6
3. GENERAL INFORMATION	7
3.1 GENERAL DESCRIPTION OF EUT	7
3.2 DESCRIPTION OF TEST MODES	8
3.2.1 TEST MODE APPLICABILITY AND TESTED CHANNEL DETAIL	9
3.3 DESCRIPTION OF SUPPORT UNITS	11
3.3.1 CONFIGURATION OF SYSTEM UNDER TEST	11
3.4 GENERAL DESCRIPTION OF APPLIED STANDARDS	12
4. TEST TYPES AND RESULTS	13
4.1 RADIATED EMISSION MEASUREMENT	13
4.1.1 LIMITS OF RADIATED EMISSION MEASUREMENT	13
4.1.2 TEST INSTRUMENTS	14
4.1.3 TEST PROCEDURES	15
4.1.4 DEVIATION FROM TEST STANDARD	15
4.1.5 TEST SETUP	16
4.1.6 EUT OPERATING CONDITIONS	16
4.1.7 TEST RESULTS	17
4.2 CONDUCTED EMISSION MEASUREMENT	26
4.2.1 LIMITS OF CONDUCTED EMISSION MEASUREMENT	26
4.2.2 TEST INSTRUMENTS	26
4.2.3 TEST PROCEDURES	27
4.2.4 DEVIATION FROM TEST STANDARD	27
4.2.5 TEST SETUP	28
4.2.6 EUT OPERATING CONDITIONS	28
4.2.7 TEST RESULTS	29
4.3 6dB BANDWIDTH MEASUREMENT	31
4.3.1 LIMITS OF 6dB BANDWIDTH MEASUREMENT	31
4.3.2 TEST SETUP	31
4.3.3 TEST INSTRUMENTS	31
4.3.4 TEST PROCEDURE	31
4.3.5 DEVIATION FROM TEST STANDARD	31
4.3.6 EUT OPERATING CONDITIONS	31
4.3.7 TEST RESULTS	32
4.4 CONDUCTED OUTPUT POWER	33
4.4.1 LIMITS OF CONDUCTED OUTPUT POWER MEASUREMENT	33
4.4.2 TEST SETUP	33
4.4.3 INSTRUMENTS	33
4.4.4 TEST PROCEDURES	33
4.4.5 DEVIATION FROM TEST STANDARD	33
4.4.6 EUT OPERATING CONDITIONS	33
4.4.7 TEST RESULTS	34
4.5 POWER SPECTRAL DENSITY MEASUREMENT	35
4.5.1 LIMITS OF POWER SPECTRAL DENSITY MEASUREMENT	35
4.5.2 TEST SETUP	35



A D T

4.5.3	TEST INSTRUMENTS.....	35
4.5.4	TEST PROCEDURE.....	35
4.5.5	DEVIATION FROM TEST STANDARD.....	35
4.5.6	EUT OPERATING CONDITION.....	35
4.5.7	TEST RESULTS	36
4.6	CONDUCTED OUT OF BAND EMISSION MEASUREMENT.....	37
4.6.1	LIMITS OF CONDUCTED OUT OF BAND EMISSION MEASUREMENT	37
4.6.2	TEST SETUP.....	37
4.6.3	TEST INSTRUMENTS.....	37
4.6.4	TEST PROCEDURE.....	37
4.6.5	DEVIATION FROM TEST STANDARD.....	37
4.6.6	EUT OPERATING CONDITION.....	38
4.6.7	TEST RESULTS	38
5.	PHOTOGRAPHS OF THE TEST CONFIGURATION.....	42
6.	INFORMATION ON THE TESTING LABORATORIES	43
7.	APPENDIX A - MODIFICATIONS RECORDERS FOR ENGINEERING CHANGES TO THE EUT BY THE LAB.....	44



A D T

RELEASE CONTROL RECORD

ISSUE NO.	REASON FOR CHANGE	DATE ISSUED
RF120305C07	Original release	Mar. 26, 2012



1. CERTIFICATION

PRODUCT: IEEE 802.11a/n Wireless PCIe Module
MODEL NO.: DIR-826LMO1
BRAND: D-Link
APPLICANT: D-Link Corporation
TESTED: Mar. 13 ~ Mar. 22, 2012
TEST SAMPLE: ENGINEERING SAMPLE
STANDARDS: **FCC Part 15, Subpart C (Section 15.247)**
ANSI C63.10-2009

The above equipment (model: DIR-826LMO1) has been tested by **Bureau Veritas Consumer Products Services (H.K.) Ltd., Taoyuan Branch**, and found compliance with the requirement of the above standards. The test record, data evaluation & Equipment Under Test (EUT) configurations represented herein are true and accurate accounts of the measurements of the sample's EMC characteristics under the conditions specified in this report.

PREPARED BY : Andrea Hsia , **DATE :** Mar. 26, 2012
Andrea Hsia / Specialist

APPROVED BY : Gary Chang , **DATE :** Mar. 26, 2012
Gary Chang / Technical Manager

2. SUMMARY OF TEST RESULTS

The EUT has been tested according to the following specifications:

APPLIED STANDARD: FCC PART 15, SUBPART C (SECTION 15.247)			
STANDARD SECTION	TEST TYPE	RESULT	REMARK
15.207	AC Power Conducted Emission	PASS	Meet the requirement of limit. Minimum passing margin is -15.04dB at 0.86484MHz.
15.247(d) 15.209	Radiated Emissions	PASS	Meet the requirement of limit. Minimum passing margin is -1.0dB at 11570.00 & 11650.00MHz.
15.247(d)	Band Edge Measurement	PASS	Meet the requirement of limit.
15.247(a)(2)	6dB bandwidth	PASS	Meet the requirement of limit.
15.247(b)	Conducted power	PASS	Meet the requirement of limit.
15.247(e)	Power Spectral Density	PASS	Meet the requirement of limit.
15.203	Antenna Requirement	PASS	Antenna connector is UFL not a standard connector.

2.1 MEASUREMENT UNCERTAINTY

Where relevant, the following measurement uncertainty levels have been estimated for tests performed on the EUT as specified in CISPR 16-4-2:

MEASUREMENT	FREQUENCY	UNCERTAINTY
Conducted emissions	9kHz~30MHz	2.44 dB
Radiated emissions	30MHz ~ 200MHz	2.93 dB
	200MHz ~1000MHz	2.95 dB
	1GHz ~ 18GHz	2.26 dB
	18GHz ~ 40GHz	1.94 dB

This uncertainty represents an expanded uncertainty expressed at approximately the 95% confidence level using a coverage factor of $k = 2$.



3. GENERAL INFORMATION

3.1 GENERAL DESCRIPTION OF EUT

EUT	IEEE 802.11a/n Wireless PCIe Module
MODEL NO.	DIR-826LMO1
POWER SUPPLY	3.3Vdc
MODULATION TYPE	64QAM, 16QAM, QPSK, BPSK
MODULATION TECHNOLOGY	OFDM
TRANSFER RATE	802.11a: 54.0/ 48.0/ 36.0/ 24.0/ 18.0/ 12.0/ 9.0/ 6.0Mbps 802.11n: up to 300.0Mbps
OPERATING FREQUENCY	5745 ~ 5825MHz
NUMBER OF CHANNEL	5 for 802.11a, 802.11n (20MHz) 2 for 802.11n (40MHz)
OUTPUT POWER	409.8mW
ANTENNA TYPE	PCBantenna with 0dBi gain
ANTENNA CONNECTOR	UFL
DATA CABLE	NA
I/O PORTS	Refer to user's manual
ACCESSORY DEVICES	NA

NOTE:

1. The frequency bands used in this EUT are listed as follows:

Frequency Band (MHz)	5180~5240	5745~5825
802.11a	√	√
802.11n (20MHz)	√	√
802.11n (40MHz)	√	√

2. The EUT incorporates a MIMO function. Physically, the EUT provides two completed transmitters and two receivers.

MODULATION MODE	TX FUNCTION
802.11a	1TX
802.11n (20MHz)	2TX
802.11n (40MHz)	2TX

3. The above EUT information is declared by manufacturer and for more detailed features description, please refer to the manufacturer's specifications or user's manual.



3.2 DESCRIPTION OF TEST MODES

5 channels are provided for 802.11a, 802.11n (20MHz):

CHANNEL	FREQUENCY	CHANNEL	FREQUENCY
149	5745MHz	161	5805MHz
153	5765MHz	165	5825MHz
157	5785MHz		

2 channels are provided for 802.11n (40MHz):

CHANNEL	FREQUENCY	CHANNEL	FREQUENCY
151	5755MHz	159	5795MHz



3.2.1 TEST MODE APPLICABILITY AND TESTED CHANNEL DETAIL

EUT CONFIGURE MODE	APPLICABLE TO				DESCRIPTION
	RE≥1G	RE<1G	PLC	APCM	
-	√	√	√	√	-

Where **RE≥1G**: Radiated Emission above 1GHz **RE<1G**: Radiated Emission below 1GHz
PLC: Power Line Conducted Emission **APCM**: Antenna Port Conducted Measurement

RADIATED EMISSION TEST (ABOVE 1GHz):

- Pre-Scan has been conducted to determine the worst-case mode from all possible combinations between available modulations, data rates and antenna ports (if EUT with antenna diversity architecture).
- Following channel(s) was (were) selected for the final test as listed below.

MODE	AVAILABLE CHANNEL	TESTED CHANNEL	MODULATION TECHNOLOGY	MODULATION TYPE	DATA RATE (Mbps)
802.11a	149 to 165	149, 157, 165	OFDM	BPSK	6.0
802.11n (20MHz)	149 to 165	149, 157, 165	OFDM	BPSK	7.2
802.11n (40MHz)	151 to 159	149, 157, 165	OFDM	BPSK	15.0

RADIATED EMISSION TEST (BELOW 1GHz):

- Pre-Scan has been conducted to determine the worst-case mode from all possible combinations between available modulations, data rates and antenna ports (if EUT with antenna diversity architecture).
- Following channel(s) was (were) selected for the final test as listed below.

MODE	AVAILABLE CHANNEL	TESTED CHANNEL	MODULATION TECHNOLOGY	MODULATION TYPE	DATA RATE (Mbps)
802.11n (20MHz)	149 to 165	157	OFDM	BPSK	7.2

POWER LINE CONDUCTED EMISSION TEST:

- Pre-Scan has been conducted to determine the worst-case mode from all possible combinations between available modulations, data rates and antenna ports (if EUT with antenna diversity architecture).
- Following channel(s) was (were) selected for the final test as listed below.

MODE	AVAILABLE CHANNEL	TESTED CHANNEL	MODULATION TECHNOLOGY	MODULATION TYPE	DATA RATE (Mbps)
802.11n (20MHz)	149 to 165	157	OFDM	BPSK	7.2



BANDEDGE MEASUREMENT:

- Pre-Scan has been conducted to determine the worst-case mode from all possible combinations between available modulations, data rates and antenna ports (if EUT with antenna diversity architecture).
- Following channel(s) was (were) selected for the final test as listed below.

MODE	AVAILABLE CHANNEL	TESTED CHANNEL	MODULATION TECHNOLOGY	MODULATION TYPE	DATA RATE (Mbps)
802.11a	149 to 165	149, 165	OFDM	BPSK	6.0
802.11n (20MHz)	149 to 165	149, 165	OFDM	BPSK	7.2
802.11n (40MHz)	151 to 159	149, 165	OFDM	BPSK	15.0

ANTENNA PORT CONDUCTED MEASUREMENT:

- This item includes all test value of each mode, but only includes spectrum plot of worst value of each mode.
- Pre-Scan has been conducted to determine the worst-case mode from all possible combinations between available modulations, data rates and antenna ports (if EUT with antenna diversity architecture).
- Following channel(s) was (were) selected for the final test as listed below.

MODE	AVAILABLE CHANNEL	TESTED CHANNEL	MODULATION TECHNOLOGY	MODULATION TYPE	DATA RATE (Mbps)
802.11a	149 to 165	149, 157, 165	OFDM	BPSK	6.0
802.11n (20MHz)	149 to 165	149, 157, 165	OFDM	BPSK	7.2
802.11n (40MHz)	151 to 159	149, 157, 165	OFDM	BPSK	15.0

TEST CONDITION:

APPLICABLE TO	ENVIRONMENTAL CONDITIONS	INPUT POWER	TESTED BY
RE≥1G	25deg. C, 65%RH	120Vac, 60Hz	Sun Lin
RE<1G	25deg. C, 65%RH	120Vac, 60Hz	Anderson Hong
PLC	25deg. C, 68%RH	120Vac, 60Hz	Sun Lin
APCM	25deg. C, 68%RH	120Vac, 60Hz	Brad Wu

3.3 DESCRIPTION OF SUPPORT UNITS

The EUT has been tested as an independent unit together with other necessary accessories or support units. The following support units or accessories were used to form a representative test configuration during the tests.

NO.	PRODUCT	BRAND	MODEL NO.	SERIAL NO.	FCC ID
1	NOTEBOOK	DELL	E5420	1HC2XM1	FCC DoC Approved
2	EXTERNAL BOARD	NA	NA	NA	NA
3	ADAPTER	FAIRWAY	WN10A-050U	NA	NA

NO.	SIGNAL CABLE DESCRIPTION OF THE ABOVE SUPPORT UNITS
1	NA
2	NA
3	1.8m non-shielded cable without core

NOTE:

1. All power cords of the above support units are non shielded (1.8m).
2. Item 2 & 3 were supplied from client.

3.3.1 CONFIGURATION OF SYSTEM UNDER TEST

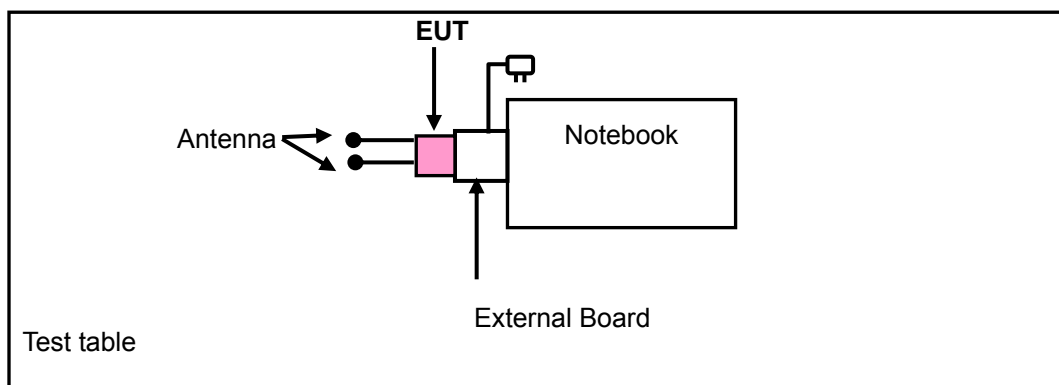

3.4 GENERAL DESCRIPTION OF APPLIED STANDARDS

The EUT is a RF Product. According to the specifications of the manufacturer, it must comply with the requirements of the following standards:

FCC Part 15, Subpart C (15.247)

ANSI C63.10-2009

All test items have been performed and recorded as per the above standards.

NOTE: The EUT is also considered as a kind of computer peripheral, because the connection to computer is necessary for typical use. It has been verified to comply with the requirements of FCC Part 15, Subpart B, Class B (DoC). The test report has been issued separately.

4. TEST TYPES AND RESULTS

4.1 RADIATED EMISSION MEASUREMENT

4.1.1 LIMITS OF RADIATED EMISSION MEASUREMENT

Radiated emissions which fall in the restricted bands must comply with the radiated emission limits specified as below table. Other emissions shall be at least 20dB below the highest level of the desired power:

FREQUENCIES (MHz)	FIELD STRENGTH (microvolts/meter)	MEASUREMENT DISTANCE (meters)
0.009 ~ 0.490	2400/F(kHz)	300
0.490 ~ 1.705	24000/F(kHz)	30
1.705 ~ 30.0	30	30
30 ~ 88	100	3
88 ~ 216	150	3
216 ~ 960	200	3
Above 960	500	3

NOTE:

1. The lower limit shall apply at the transition frequencies.
2. Emission level (dBuV/m) = 20 log Emission level (uV/m).
3. For frequencies above 1000MHz, the field strength limits are based on average detector, however, the peak field strength of any emission shall not exceed the maximum permitted average limits, specified above by more than 20dB under any condition of modulation.



4.1.2 TEST INSTRUMENTS

DESCRIPTION & MANUFACTURER	MODEL NO.	SERIAL NO.	DATE OF CALIBRATION	DUE DATE OF CALIBRATION
Test Receiver ROHDE & SCHWARZ	ESCI	100744	Apr. 19, 2011	Apr. 18, 2012
Spectrum Analyzer ROHDE & SCHWARZ	FSP40	100040	Aug. 04, 2011	Aug. 03, 2012
BILOG Antenna SCHWARZBECK	VULB9168	9168-156	Apr. 12, 2011	Apr. 11, 2012
HORN Antenna SCHWARZBECK	BBHA 9120 D	9120D-563	Sep. 06, 2011	Sep. 05, 2012
HORN Antenna SCHWARZBECK	BBHA 9170	148	Jul. 20, 2011	Jul. 19, 2012
Preamplifier Agilent	8449B	3008A01911	Oct. 29, 2011	Oct. 28, 2012
Preamplifier Agilent	8447D	2944A10638	Oct. 29, 2011	Oct. 28, 2012
RF signal cable HUBER+SUHNNER	SUCOFLEX 104	295013/4 283403/4	Aug. 19, 2011	Aug. 18, 2012
RF signal cable Worken	8D-FB	Cable-HYCH9-01	Aug. 13, 2011	Aug. 12, 2012
Software	ADT_Radiated_ V7.6.15.9.2	NA	NA	NA
Antenna Tower EMCO	2070/2080	512.835.4684	NA	NA
Turn Table EMCO	2087-2.03	NA	NA	NA
Antenna Tower & Turn Table Controller EMCO	2090	NA	NA	NA
26GHz ~ 40GHz Amplifier	EM26400	815221	Oct. 29, 2011	Oct. 28, 2012
High Speed Peak Power Meter	ML2495A	0824011	Aug. 04, 2011	Aug. 03, 2012
Power Sensor	MA2411B	0738171	Aug. 04, 2011	Aug. 03, 2012

- NOTE:**
1. The calibration interval of the above test instruments is 12 months and the calibrations are traceable to NML/ROC and NIST/USA.
 2. The test was performed in HwaYa Chamber 9.
 3. The horn antenna and HP preamplifier (model: 8449B) are used only for the measurement of emission frequency above 1GHz if tested.
 4. The FCC Site Registration No. is 460141.
 5. The IC Site Registration No. is IC 7450F-4.

4.1.3 TEST PROCEDURES

- a. The EUT was placed on the top of a rotating table 0.8 meters above the ground at a 3 meters semi-anechoic chamber. The table was rotated 360 degrees to determine the position of the highest radiation.
- b. The EUT was set 3 meters away from the interference-receiving antenna, which was mounted on the top of a variable-height antenna tower.
- c. The antenna is a broadband antenna, and its height is varied from one meter to four meters above the ground to determine the maximum value of the field strength. Both horizontal and vertical polarizations of the antenna are set to make the measurement.
- d. For each suspected emission, the EUT was arranged to its worst case and then the antenna was tuned to heights from 1 meter to 4 meters and the rotatable table was turned from 0 degrees to 360 degrees to find the maximum reading.
- e. The test-receiver system was set to Peak Detect Function and Specified Bandwidth with Maximum Hold Mode.
- f. If the emission level of the EUT in peak mode was lower than the limit specified, then testing could be stopped and the peak values of the EUT would be reported. Otherwise the emissions would be re-tested one by one using peak, quasi-peak or average method as specified and then reported in a data sheet.

NOTE:

1. The resolution bandwidth and video bandwidth of test receiver/spectrum analyzer is 120kHz for Quasi-peak detection at frequency below 1GHz.
2. The resolution bandwidth of test receiver/spectrum analyzer is 100kHz and video bandwidth is 300kHz for Peak detection at frequency above 1GHz.
3. The resolution bandwidth of test receiver/spectrum analyzer is 1MHz and the video bandwidth is 1kHz for Average detection (AV) at frequency above 1GHz.
4. All modes of operation were investigated and the worst-case emissions are reported.

4.1.4 DEVIATION FROM TEST STANDARD

No deviation.

4.1.5 TEST SETUP

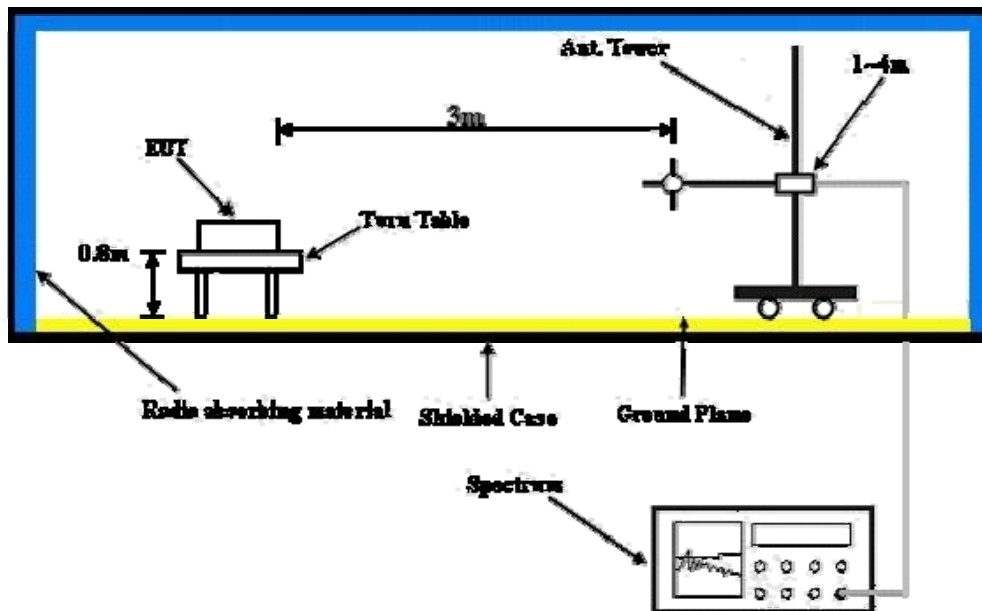

For the actual test configuration, please refer to the attached file (Test Setup Photo).

4.1.6 EUT OPERATING CONDITIONS

- a. Plugged the EUT into notebook via external board and placed them on the testing table.
- b. The notebook system ran a test program (provided by manufacturer) to enable EUT under transmission condition continuously at specific channel frequency.
- c. The necessary accessories enable the system in full functions.



4.1.7 TEST RESULTS

ABOVE 1GHz DATA : 802.11a

EUT TEST CONDITION		MEASUREMENT DETAIL	
CHANNEL	Channel 149	FREQUENCY RANGE	1 ~ 40GHz
INPUT POWER (SYSTEM)	120Vac, 60 Hz	DETECTOR FUNCTION	Peak (PK) Average (AV)
ENVIRONMENTAL CONDITIONS	25deg. C, 65%RH	TESTED BY	Sun Lin

ANTENNA POLARITY & TEST DISTANCE: HORIZONTAL AT 3 M								
NO.	FREQ. (MHz)	EMISSION LEVEL (dBuV/m)	LIMIT (dBuV/m)	MARGIN (dB)	ANTENNA HEIGHT (m)	TABLE ANGLE (Degree)	RAW VALUE (dBuV)	CORRECTION FACTOR (dB/m)
1	#5725.00	87.9 PK	99.1	-11.2	1.43 H	282	48.70	39.20
2	#5725.00	72.7 AV	87.8	-15.1	1.43 H	282	33.50	39.20
3	*5745.00	119.1 PK			1.43 H	282	79.80	39.30
4	*5745.00	107.8 AV			1.43 H	282	68.50	39.30
5	11490.00	60.2 PK	74.0	-13.8	1.59 H	304	10.80	49.40
6	11490.00	46.0 AV	54.0	-8.0	1.59 H	304	-3.40	49.40
7	#17235.00	65.4 PK	99.1	-33.7	1.59 H	154	11.90	53.50
8	#17235.00	52.0 AV	87.8	-35.8	1.59 H	154	-1.50	53.50
ANTENNA POLARITY & TEST DISTANCE: VERTICAL AT 3 M								
NO.	FREQ. (MHz)	EMISSION LEVEL (dBuV/m)	LIMIT (dBuV/m)	MARGIN (dB)	ANTENNA HEIGHT (m)	TABLE ANGLE (Degree)	RAW VALUE (dBuV)	CORRECTION FACTOR (dB/m)
1	#5725.00	66.2 PK	89.9	-23.7	2.18 V	30	27.00	39.20
2	#5725.00	61.4 AV	79.0	-17.6	2.18 V	30	22.20	39.20
3	*5745.00	109.9 PK			2.18 V	30	70.60	39.30
4	*5745.00	99.0 AV			2.18 V	30	59.70	39.30
5	11490.00	60.6 PK	74.0	-13.4	1.35 V	272	11.20	49.40
6	11490.00	46.7 AV	54.0	-7.3	1.35 V	272	-2.70	49.40
7	#17235.00	62.2 PK	89.9	-27.7	1.36 V	270	8.70	53.50
8	#17235.00	48.4 AV	79.0	-30.6	1.36 V	270	-5.10	53.50

- REMARKS:**
1. Emission level (dBuV/m) = Raw Value (dBuV) + Correction Factor (dB/m).
 2. Correction Factor (dB/m) = Antenna Factor (dB/m) + Cable Factor (dB).
 3. The other emission levels were very low against the limit.
 4. Margin value = Emission level – Limit value.
 5. “ * “: Fundamental frequency.
 6. The limit value is defined as per 15.247.
 7. "#":The radiated frequency is out the restricted band.



A D T

EUT TEST CONDITION		MEASUREMENT DETAIL	
CHANNEL	Channel 157	FREQUENCY RANGE	1 ~ 40GHz
INPUT POWER (SYSTEM)	120Vac, 60 Hz	DETECTOR FUNCTION	Peak (PK) Average (AV)
ENVIRONMENTAL CONDITIONS	25deg. C, 65%RH	TESTED BY	Sun Lin

ANTENNA POLARITY & TEST DISTANCE: HORIZONTAL AT 3 M								
NO.	FREQ. (MHz)	EMISSION LEVEL (dBuV/m)	LIMIT (dBuV/m)	MARGIN (dB)	ANTENNA HEIGHT (m)	TABLE ANGLE (Degree)	RAW VALUE (dBuV)	CORRECTION FACTOR (dB/m)
1	#5725.00	69.1 PK	98.8	-29.7	1.41 H	286	29.90	39.20
2	#5725.00	56.1 AV	87.5	-31.4	1.41 H	286	16.90	39.20
3	*5785.00	118.8 PK			1.40 H	285	79.40	39.40
4	*5785.00	107.5 AV			1.40 H	285	68.10	39.40
5	11570.00	62.2 PK	74.0	-11.8	1.28 H	304	13.00	49.20
6	11570.00	49.8 AV	54.0	-4.2	1.28 H	304	0.60	49.20
7	#17355.00	67.4 PK	98.8	-31.4	1.41 H	155	13.10	54.30
8	#17355.00	54.8 AV	87.5	-32.7	1.41 H	155	0.50	54.30
ANTENNA POLARITY & TEST DISTANCE: VERTICAL AT 3 M								
NO.	FREQ. (MHz)	EMISSION LEVEL (dBuV/m)	LIMIT (dBuV/m)	MARGIN (dB)	ANTENNA HEIGHT (m)	TABLE ANGLE (Degree)	RAW VALUE (dBuV)	CORRECTION FACTOR (dB/m)
1	#5725.00	46.7 PK	89.6	-42.9	2.18 V	51	7.50	39.20
2	#5725.00	35.8 AV	78.7	-42.9	2.18 V	51	-3.40	39.20
3	*5785.00	109.6 PK			2.21 V	51	70.20	39.40
4	*5785.00	98.7 AV			2.21 V	51	59.30	39.40
5	11570.00	64.3 PK	74.0	-9.7	1.32 V	289	15.10	49.20
6	11570.00	50.7 AV	54.0	-3.3	1.32 V	289	1.50	49.20
7	#17355.00	65.8 PK	89.6	-23.8	1.25 V	241	11.50	54.30
8	#17355.00	51.3 AV	78.7	-27.4	1.25 V	241	-3.00	54.30

- REMARKS:**
1. Emission level (dBuV/m) = Raw Value (dBuV) + Correction Factor (dB/m).
 2. Correction Factor (dB/m) = Antenna Factor (dB/m) + Cable Factor (dB).
 3. The other emission levels were very low against the limit.
 4. Margin value = Emission level – Limit value.
 5. “ * “: Fundamental frequency.
 6. The limit value is defined as per 15.247.
 7. "#":The radiated frequency is out the restricted band.



A D T

EUT TEST CONDITION		MEASUREMENT DETAIL	
CHANNEL	Channel 165	FREQUENCY RANGE	1 ~ 40GHz
INPUT POWER (SYSTEM)	120Vac, 60 Hz	DETECTOR FUNCTION	Peak (PK) Average (AV)
ENVIRONMENTAL CONDITIONS	25deg. C, 65%RH	TESTED BY	Sun Lin

ANTENNA POLARITY & TEST DISTANCE: HORIZONTAL AT 3 M								
NO.	FREQ. (MHz)	EMISSION LEVEL (dBuV/m)	LIMIT (dBuV/m)	MARGIN (dB)	ANTENNA HEIGHT (m)	TABLE ANGLE (Degree)	RAW VALUE (dBuV)	CORRECTION FACTOR (dB/m)
1	*5825.00	118.5 PK			1.67 H	288	79.00	39.50
2	*5825.00	107.1 AV			1.67 H	288	67.60	39.50
3	#5850.00	86.3 PK	98.5	-12.2	1.67 H	281	46.80	39.50
4	#5850.00	68.8 AV	87.1	-18.3	1.67 H	281	29.30	39.50
5	11650.00	61.8 PK	74.0	-12.2	1.56 H	275	12.70	49.10
6	11650.00	48.7 AV	54.0	-5.3	1.56 H	275	-0.40	49.10
7	#17475.00	66.2 PK	98.5	-32.3	1.60 H	155	11.20	55.00
8	#17475.00	52.9 AV	87.1	-34.2	1.60 H	155	-2.10	55.00
ANTENNA POLARITY & TEST DISTANCE: VERTICAL AT 3 M								
NO.	FREQ. (MHz)	EMISSION LEVEL (dBuV/m)	LIMIT (dBuV/m)	MARGIN (dB)	ANTENNA HEIGHT (m)	TABLE ANGLE (Degree)	RAW VALUE (dBuV)	CORRECTION FACTOR (dB/m)
1	*5825.00	109.2 PK			2.07 V	32	69.70	39.50
2	*5825.00	98.2 AV			2.07 V	32	58.70	39.50
3	#5850.00	66.2 PK	89.2	-23.0	2.07 V	32	26.70	39.50
4	#5850.00	51.0 AV	78.2	-27.2	2.07 V	32	11.50	39.50
5	11650.00	61.6 PK	74.0	-12.4	1.37 V	262	12.50	49.10
6	11650.00	49.4 AV	54.0	-4.6	1.37 V	262	0.30	49.10
7	#17475.00	64.4 PK	89.2	-24.8	1.33 V	238	9.40	55.00
8	#17475.00	51.9 AV	78.2	-26.3	1.33 V	238	-3.10	55.00

- REMARKS:**
1. Emission level (dBuV/m) = Raw Value (dBuV) + Correction Factor (dB/m).
 2. Correction Factor (dB/m) = Antenna Factor (dB/m) + Cable Factor (dB).
 3. The other emission levels were very low against the limit.
 4. Margin value = Emission level – Limit value.
 5. “ * “: Fundamental frequency.
 6. The limit value is defined as per 15.247.
 7. “#”:The radiated frequency is out the restricted band.



A D T

802.11n (20MHz)

EUT TEST CONDITION		MEASUREMENT DETAIL	
CHANNEL	Channel 149	FREQUENCY RANGE	1 ~ 40GHz
INPUT POWER (SYSTEM)	120Vac, 60 Hz	DETECTOR FUNCTION	Peak (PK) Average (AV)
ENVIRONMENTAL CONDITIONS	25deg. C, 65%RH	TESTED BY	Sun Lin

ANTENNA POLARITY & TEST DISTANCE: HORIZONTAL AT 3 M								
NO.	FREQ. (MHz)	EMISSION LEVEL (dBuV/m)	LIMIT (dBuV/m)	MARGIN (dB)	ANTENNA HEIGHT (m)	TABLE ANGLE (Degree)	RAW VALUE (dBuV)	CORRECTION FACTOR (dB/m)
1	3830.00	42.8 PK	74.0	-31.2	1.58 H	277	7.80	35.00
2	3830.00	30.1 AV	54.0	-23.9	1.58 H	277	-4.90	35.00
3	#5725.00	84.6 PK	96.0	-11.4	1.42 H	276	45.40	39.20
4	#5725.00	65.9 AV	85.8	-19.9	1.42 H	276	26.70	39.20
5	*5745.00	116.0 PK			1.42 H	276	76.70	39.30
6	*5745.00	105.8 AV			1.42 H	276	66.50	39.30
7	7660.00	53.1 PK	74.0	-20.9	1.18 H	205	8.70	44.40
8	7660.00	40.3 AV	54.0	-13.7	1.18 H	205	-4.10	44.40
9	11490.00	63.1 PK	74.0	-10.9	1.59 H	305	13.70	49.40
10	11490.00	48.9 AV	54.0	-5.1	1.59 H	305	-0.50	49.40

ANTENNA POLARITY & TEST DISTANCE: VERTICAL AT 3 M								
NO.	FREQ. (MHz)	EMISSION LEVEL (dBuV/m)	LIMIT (dBuV/m)	MARGIN (dB)	ANTENNA HEIGHT (m)	TABLE ANGLE (Degree)	RAW VALUE (dBuV)	CORRECTION FACTOR (dB/m)
1	3830.00	44.5 PK	74.0	-29.5	1.53 V	125	9.50	35.00
2	3830.00	36.2 AV	54.0	-17.8	1.53 V	125	1.20	35.00
3	#5725.00	84.5 PK	95.9	-11.4	1.13 V	68	45.30	39.20
4	#5725.00	63.8 AV	85.6	-21.8	1.13 V	68	24.60	39.20
5	*5745.00	115.9 PK			1.01 V	71	76.60	39.30
6	*5745.00	105.6 AV			1.01 V	71	66.30	39.30
7	7660.00	53.0 PK	74.0	-21.0	1.58 V	165	8.60	44.40
8	7660.00	42.7 AV	54.0	-11.3	1.58 V	165	-1.70	44.40
9	11490.00	65.3 PK	74.0	-8.7	1.55 V	270	15.90	49.40
10	11490.00	51.6 AV	54.0	-2.4	1.55 V	270	2.20	49.40

- REMARKS:**
1. Emission level (dBuV/m) = Raw Value (dBuV) + Correction Factor (dB/m).
 2. Correction Factor (dB/m) = Antenna Factor (dB/m) + Cable Factor (dB).
 3. The other emission levels were very low against the limit.
 4. Margin value = Emission level – Limit value.
 5. “ * “: Fundamental frequency.
 6. The limit value is defined as per 15.247.
 7. "#":The radiated frequency is out the restricted band.



A D T

EUT TEST CONDITION		MEASUREMENT DETAIL	
CHANNEL	Channel 157	FREQUENCY RANGE	1 ~ 40GHz
INPUT POWER (SYSTEM)	120Vac, 60 Hz	DETECTOR FUNCTION	Peak (PK) Average (AV)
ENVIRONMENTAL CONDITIONS	25deg. C, 65%RH	TESTED BY	Sun Lin

ANTENNA POLARITY & TEST DISTANCE: HORIZONTAL AT 3 M

NO.	FREQ. (MHz)	EMISSION LEVEL (dBuV/m)	LIMIT (dBuV/m)	MARGIN (dB)	ANTENNA HEIGHT (m)	TABLE ANGLE (Degree)	RAW VALUE (dBuV)	CORRECTION FACTOR (dB/m)
1	3856.00	42.2 PK	74.0	-31.8	1.63 H	254	7.10	35.10
2	3856.00	29.3 AV	54.0	-24.7	1.63 H	254	-5.80	35.10
3	#5725.00	69.7 PK	95.7	-26.0	1.31 H	258	30.50	39.20
4	#5725.00	58.0 AV	85.4	-27.4	1.31 H	258	18.80	39.20
5	*5785.00	115.7 PK			1.39 H	253	76.30	39.40
6	*5785.00	105.4 AV			1.39 H	253	66.00	39.40
7	7713.00	62.6 PK	74.0	-11.4	1.48 H	296	18.10	44.50
8	7713.00	48.5 AV	54.0	-5.5	1.48 H	296	4.00	44.50
9	11570.00	64.2 PK	74.0	-9.8	1.41 H	241	15.00	49.20
10	11570.00	49.8 AV	54.0	-4.2	1.41 H	241	0.60	49.20
11	#17355.00	64.6 PK	95.7	-31.1	1.03 H	165	10.30	54.30
12	#17355.00	51.8 AV	85.4	-33.6	1.03 H	165	-2.50	54.30

ANTENNA POLARITY & TEST DISTANCE: VERTICAL AT 3 M

NO.	FREQ. (MHz)	EMISSION LEVEL (dBuV/m)	LIMIT (dBuV/m)	MARGIN (dB)	ANTENNA HEIGHT (m)	TABLE ANGLE (Degree)	RAW VALUE (dBuV)	CORRECTION FACTOR (dB/m)
1	3856.00	43.5 PK	74.0	-30.5	1.21 V	126	8.40	35.10
2	3856.00	34.1 AV	54.0	-19.9	1.21 V	126	-1.00	35.10
3	#5725.00	69.5 PK	95.4	-25.9	1.00 V	77	30.30	39.20
4	#5725.00	57.9 AV	85.1	-27.2	1.00 V	77	18.70	39.20
5	*5785.00	115.4 PK			1.12 V	68	76.00	39.40
6	*5785.00	105.1 AV			1.12 V	68	65.70	39.40
7	7713.00	52.4 PK	74.0	-21.6	1.64 V	168	7.90	44.50
8	7713.00	41.5 AV	54.0	-12.5	1.64 V	168	-3.00	44.50
9	11570.00	67.3 PK	74.0	-6.7	1.55 V	272	18.10	49.20
10	11570.00	53.0 AV	54.0	-1.0	1.55 V	272	3.80	49.20
11	#17355.00	66.5 PK	95.4	-28.9	1.31 V	271	12.20	54.30
12	#17355.00	52.5 AV	85.1	-32.6	1.31 V	271	-1.80	54.30

- REMARKS:**
1. Emission level (dBuV/m) = Raw Value (dBuV) + Correction Factor (dB/m).
 2. Correction Factor (dB/m) = Antenna Factor (dB/m) + Cable Factor (dB).
 3. The other emission levels were very low against the limit.
 4. Margin value = Emission level – Limit value.
 5. “ * “: Fundamental frequency.
 6. The limit value is defined as per 15.247.
 7. "#":The radiated frequency is out the restricted band.



A D T

EUT TEST CONDITION		MEASUREMENT DETAIL	
CHANNEL	Channel 165	FREQUENCY RANGE	1 ~ 40GHz
INPUT POWER (SYSTEM)	120Vac, 60 Hz	DETECTOR FUNCTION	Peak (PK) Average (AV)
ENVIRONMENTAL CONDITIONS	25deg. C, 65%RH	TESTED BY	Sun Lin

ANTENNA POLARITY & TEST DISTANCE: HORIZONTAL AT 3 M

NO.	FREQ. (MHz)	EMISSION LEVEL (dBuV/m)	LIMIT (dBuV/m)	MARGIN (dB)	ANTENNA HEIGHT (m)	TABLE ANGLE (Degree)	RAW VALUE (dBuV)	CORRECTION FACTOR (dB/m)
1	3883.00	42.7 PK	74.0	-31.3	1.58 H	262	7.50	35.20
2	3883.00	29.7 AV	54.0	-24.3	1.58 H	262	-5.50	35.20
3	*5825.00	115.3 PK			1.39 H	268	75.80	39.50
4	*5825.00	105.1 AV			1.39 H	268	65.60	39.50
5	#5850.00	83.5 PK	95.3	-11.8	1.65 H	279	44.00	39.50
6	#5850.00	64.8 AV	85.1	-20.3	1.65 H	279	25.30	39.50
7	#7767.00	62.5 PK	95.3	-32.8	1.52 H	281	17.90	44.60
8	#7767.00	48.3 AV	85.1	-36.8	1.52 H	281	3.70	44.60
9	11650.00	63.8 PK	74.0	-10.2	1.38 H	258	14.70	49.10
10	11650.00	49.7 AV	54.0	-4.3	1.38 H	258	0.60	49.10
11	#17475.00	64.7 PK	95.3	-30.6	1.08 H	177	9.70	55.00
12	#17475.00	52.1 AV	85.1	-33.0	1.08 H	177	-2.90	55.00

ANTENNA POLARITY & TEST DISTANCE: VERTICAL AT 3 M

NO.	FREQ. (MHz)	EMISSION LEVEL (dBuV/m)	LIMIT (dBuV/m)	MARGIN (dB)	ANTENNA HEIGHT (m)	TABLE ANGLE (Degree)	RAW VALUE (dBuV)	CORRECTION FACTOR (dB/m)
1	3883.00	44.9 PK	74.0	-29.1	1.33 V	128	9.70	35.20
2	3883.00	35.9 AV	54.0	-18.1	1.33 V	128	0.70	35.20
3	*5825.00	115.1 PK			1.08 V	69	75.60	39.50
4	*5825.00	104.7 AV			1.08 V	69	65.20	39.50
5	#5850.00	82.5 PK	95.1	-12.6	1.00 V	69	43.00	39.50
6	#5850.00	64.0 AV	84.7	-20.7	1.00 V	69	24.50	39.50
7	#7767.00	52.4 PK	95.1	-42.7	1.52 V	261	7.80	44.60
8	#7767.00	41.4 AV	84.7	-43.3	1.52 V	261	-3.20	44.60
9	11650.00	65.9 PK	74.0	-8.1	1.28 V	271	16.80	49.10
10	11650.00	53.0 AV	54.0	-1.0	1.28 V	271	3.90	49.10
11	#17475.00	65.1 PK	95.1	-30.0	1.14 V	267	10.10	55.00
12	#17475.00	52.5 AV	84.7	-32.2	1.14 V	267	-2.50	55.00

- REMARKS:**
1. Emission level (dBuV/m) = Raw Value (dBuV) + Correction Factor (dB/m).
 2. Correction Factor (dB/m) = Antenna Factor (dB/m) + Cable Factor (dB).
 3. The other emission levels were very low against the limit.
 4. Margin value = Emission level – Limit value.
 5. “ * “: Fundamental frequency.
 6. The limit value is defined as per 15.247.
 7. "#":The radiated frequency is out the restricted band.



A D T

802.11n (40MHz)

EUT TEST CONDITION		MEASUREMENT DETAIL	
CHANNEL	Channel 151	FREQUENCY RANGE	1 ~ 40GHz
INPUT POWER (SYSTEM)	120Vac, 60 Hz	DETECTOR FUNCTION	Peak (PK) Average (AV)
ENVIRONMENTAL CONDITIONS	25deg. C, 65%RH	TESTED BY	Sun Lin

ANTENNA POLARITY & TEST DISTANCE: HORIZONTAL AT 3 M								
NO.	FREQ. (MHz)	EMISSION LEVEL (dBuV/m)	LIMIT (dBuV/m)	MARGIN (dB)	ANTENNA HEIGHT (m)	TABLE ANGLE (Degree)	RAW VALUE (dBuV)	CORRECTION FACTOR (dB/m)
1	3836.00	42.3 PK	74.0	-31.7	1.62 H	247	7.30	35.00
2	3836.00	29.9 AV	54.0	-24.1	1.62 H	247	-5.10	35.00
3	#5725.00	80.0 PK	91.0	-11.0	1.43 H	280	40.80	39.20
4	#5725.00	62.7 AV	80.6	-17.9	1.43 H	280	23.50	39.20
5	*5755.00	111.0 PK			1.67 H	280	71.70	39.30
6	*5755.00	100.6 AV			1.67 H	280	61.30	39.30
7	7673.00	53.2 PK	74.0	-20.8	1.08 H	268	8.80	44.40
8	7673.00	40.3 AV	54.0	-13.7	1.08 H	268	-4.10	44.40
9	11510.00	63.5 PK	74.0	-10.5	1.58 H	289	14.10	49.40
10	11510.00	49.1 AV	54.0	-4.9	1.58 H	289	-0.30	49.40

ANTENNA POLARITY & TEST DISTANCE: VERTICAL AT 3 M								
NO.	FREQ. (MHz)	EMISSION LEVEL (dBuV/m)	LIMIT (dBuV/m)	MARGIN (dB)	ANTENNA HEIGHT (m)	TABLE ANGLE (Degree)	RAW VALUE (dBuV)	CORRECTION FACTOR (dB/m)
1	3836.00	44.0 PK	74.0	-30.0	1.52 V	134	9.00	35.00
2	3836.00	33.0 AV	54.0	-21.0	1.52 V	134	-2.00	35.00
3	#5725.00	79.3 PK	90.5	-11.2	1.00 V	79	40.10	39.20
4	#5725.00	61.5 AV	80.4	-18.9	1.00 V	79	22.30	39.20
5	*5755.00	110.5 PK			1.00 V	76	71.20	39.30
6	*5755.00	100.4 AV			1.00 V	76	61.10	39.30
7	7673.00	53.7 PK	74.0	-20.3	1.53 V	113	9.30	44.40
8	7673.00	44.0 AV	54.0	-10.0	1.53 V	113	-0.40	44.40
9	11510.00	62.0 PK	74.0	-12.0	1.29 V	267	12.60	49.40
10	11510.00	48.6 AV	54.0	-5.4	1.29 V	267	-0.80	49.40

- REMARKS:**
1. Emission level (dBuV/m) = Raw Value (dBuV) + Correction Factor (dB/m).
 2. Correction Factor (dB/m) = Antenna Factor (dB/m) + Cable Factor (dB).
 3. The other emission levels were very low against the limit.
 4. Margin value = Emission level – Limit value.
 5. “ * “: Fundamental frequency.
 6. The limit value is defined as per 15.247.
 7. "#":The radiated frequency is out the restricted band.



A D T

EUT TEST CONDITION		MEASUREMENT DETAIL	
CHANNEL	Channel 159	FREQUENCY RANGE	1 ~ 40GHz
INPUT POWER (SYSTEM)	120Vac, 60 Hz	DETECTOR FUNCTION	Peak (PK) Average (AV)
ENVIRONMENTAL CONDITIONS	25deg. C, 65%RH	TESTED BY	Sun Lin

ANTENNA POLARITY & TEST DISTANCE: HORIZONTAL AT 3 M								
NO.	FREQ. (MHz)	EMISSION LEVEL (dBuV/m)	LIMIT (dBuV/m)	MARGIN (dB)	ANTENNA HEIGHT (m)	TABLE ANGLE (Degree)	RAW VALUE (dBuV)	CORRECTION FACTOR (dB/m)
1	3863.00	42.7 PK	74.0	-31.3	1.58 H	269	7.60	35.10
2	3863.00	30.8 AV	54.0	-23.2	1.58 H	269	-4.30	35.10
3	*5795.00	113.7 PK			1.40 H	281	74.30	39.40
4	*5795.00	103.0 AV			1.40 H	281	63.60	39.40
5	#5850.00	82.7 PK	93.7	-11.0	1.63 H	294	43.20	39.50
6	#5850.00	65.0 AV	83.0	-18.0	1.63 H	294	25.50	39.50
7	7727.00	53.8 PK	74.0	-20.2	1.12 H	232	9.30	44.50
8	7727.00	41.2 AV	54.0	-12.8	1.12 H	232	-3.30	44.50
9	11590.00	63.8 PK	74.0	-10.2	1.63 H	289	14.70	49.10
10	11590.00	49.7 AV	54.0	-4.3	1.63 H	289	0.60	49.10
ANTENNA POLARITY & TEST DISTANCE: VERTICAL AT 3 M								
NO.	FREQ. (MHz)	EMISSION LEVEL (dBuV/m)	LIMIT (dBuV/m)	MARGIN (dB)	ANTENNA HEIGHT (m)	TABLE ANGLE (Degree)	RAW VALUE (dBuV)	CORRECTION FACTOR (dB/m)
1	3863.00	45.1 PK	74.0	-28.9	1.48 V	157	10.00	35.10
2	3863.00	33.7 AV	54.0	-20.3	1.48 V	157	-1.40	35.10
3	*5795.00	113.4 PK			1.00 V	67	74.00	39.40
4	*5795.00	102.6 AV			1.00 V	67	63.20	39.40
5	#5850.00	82.3 PK	93.4	-11.1	1.00 V	70	42.80	39.50
6	#5850.00	64.7 AV	82.6	-17.9	1.00 V	70	25.20	39.50
7	7727.00	54.3 PK	74.0	-19.7	1.52 V	107	9.80	44.50
8	7727.00	44.5 AV	54.0	-9.5	1.52 V	107	0.00	44.50
9	11590.00	63.4 PK	74.0	-10.6	1.65 V	273	14.30	49.10
10	11590.00	50.7 AV	54.0	-3.3	1.65 V	273	1.60	49.10

- REMARKS:**
1. Emission level (dBuV/m) = Raw Value (dBuV) + Correction Factor (dB/m).
 2. Correction Factor (dB/m) = Antenna Factor (dB/m) + Cable Factor (dB).
 3. The other emission levels were very low against the limit.
 4. Margin value = Emission level – Limit value.
 5. “ * “: Fundamental frequency.
 6. The limit value is defined as per 15.247.
 7. “#”:The radiated frequency is out the restricted band.



A D T

BELOW 1GHz WORST-CASE DATA : 802.11n (20MHz)

EUT TEST CONDITION		MEASUREMENT DETAIL	
CHANNEL	Channel 157	FREQUENCY RANGE	Below 1000MHz
INPUT POWER (SYSTEM)	120Vac, 60 Hz	DETECTOR FUNCTION	Quasi-Peak
ENVIRONMENTAL CONDITIONS	25deg. C, 65%RH	TESTED BY	Anderson Hong

ANTENNA POLARITY & TEST DISTANCE: HORIZONTAL AT 3 M								
NO.	FREQ. (MHz)	EMISSION LEVEL (dBuV/m)	LIMIT (dBuV/m)	MARGIN (dB)	ANTENNA HEIGHT (m)	TABLE ANGLE (Degree)	RAW VALUE (dBuV)	CORRECTION FACTOR (dB/m)
1	98.04	36.3 QP	43.5	-7.2	2.50 H	256	27.00	9.30
2	111.64	34.3 QP	43.5	-9.2	1.25 H	88	23.40	10.90
3	208.84	33.6 QP	43.5	-9.9	1.00 H	244	22.00	11.60
4	300.20	30.4 QP	46.0	-15.6	1.00 H	220	15.40	15.00
5	665.65	28.6 QP	46.0	-17.4	1.00 H	250	5.90	22.70
6	842.55	33.8 QP	46.0	-12.2	1.50 H	247	8.10	25.70
ANTENNA POLARITY & TEST DISTANCE: VERTICAL AT 3 M								
NO.	FREQ. (MHz)	EMISSION LEVEL (dBuV/m)	LIMIT (dBuV/m)	MARGIN (dB)	ANTENNA HEIGHT (m)	TABLE ANGLE (Degree)	RAW VALUE (dBuV)	CORRECTION FACTOR (dB/m)
1	35.83	37.2 QP	40.0	-2.8	1.25 V	46	24.20	13.00
2	166.07	32.8 QP	43.5	-10.7	1.50 V	319	19.00	13.80
3	243.83	29.6 QP	46.0	-16.4	1.00 V	55	16.70	12.90
4	432.38	26.6 QP	46.0	-19.4	1.25 V	313	8.20	18.40
5	700.64	27.6 QP	46.0	-18.4	1.00 V	190	4.70	22.90
6	842.55	31.3 QP	46.0	-14.7	1.75 V	241	5.60	25.70

- REMARKS:**
1. Emission level (dBuV/m) = Raw Value (dBuV) + Correction Factor (dB/m).
 2. Correction Factor (dB/m) = Antenna Factor (dB/m) + Cable Factor (dB).
 3. The other emission levels were very low against the limit.
 4. Margin value = Emission level – Limit value.

4.2 CONDUCTED EMISSION MEASUREMENT

4.2.1 LIMITS OF CONDUCTED EMISSION MEASUREMENT

FREQUENCY OF EMISSION (MHz)	CONDUCTED LIMIT (dB μ V)	
	Quasi-peak	Average
0.15 ~ 0.5	66 to 56	56 to 46
0.5 ~ 5	56	46
5 ~ 30	60	50

- NOTE:** 1. The lower limit shall apply at the transition frequencies.
2. The limit decreases in line with the logarithm of the frequency in the range of 0.15 to 0.50MHz.
3. All emanations from a class A/B digital device or system, including any network of conductors and apparatus connected thereto, shall not exceed the level of field strengths specified above.

4.2.2 TEST INSTRUMENTS

DESCRIPTION & MANUFACTURER	MODEL NO.	SERIAL NO.	DATE OF CALIBRATION	DUE DATE OF CALIBRATION
Test Receiver ROHDE & SCHWARZ	ESCS30	100289	Nov. 19, 2011	Nov. 18, 2012
RF signal cable Woken	5D-FB	Cable-HYCO2-01	Dec. 22, 2011	Dec. 21, 2012
LISN ROHDE & SCHWARZ	ESH2-Z5	100100	Dec. 30, 2011	Dec. 29, 2012
LISN ROHDE & SCHWARZ	ESH3-Z5	100312	Jul. 07, 2011	Jul. 06, 2012
V-LISN SCHWARZBECK	NNBL 8226-2	8226-142	Jun. 30, 2011	Jun. 29, 2012
LISN ROHDE & SCHWARZ	ENV216	100072	Jun. 10, 2011	Jun. 09, 2012
Software ADT	ADT_Cond_ V7.3.7	NA	NA	NA

- NOTE:** 1. The calibration interval of the above test instruments is 12 months and the calibrations are traceable to NML/ROC and NIST/USA.
2. The test was performed in HwaYa Shielded Room 2.
3. The VCCI Site Registration No. is C-2047.

4.2.3 TEST PROCEDURES

- a. The EUT was placed 0.4 meters from the conducting wall of the shielded room with EUT being connected to the power mains through a line impedance stabilization network (LISN). Other support units were connected to the power mains through another LISN. The two LISNs provide 50 ohm/ 50uH of coupling impedance for the measuring instrument.
- b. Both lines of the power mains connected to the EUT were checked for maximum conducted interference.
- c. The frequency range from 150kHz to 30MHz was searched. Emission levels under (Limit - 20dB) was not recorded.

NOTE: All modes of operation were investigated and the worst-case emissions are reported.

4.2.4 DEVIATION FROM TEST STANDARD

No deviation.

4.2.5 TEST SETUP

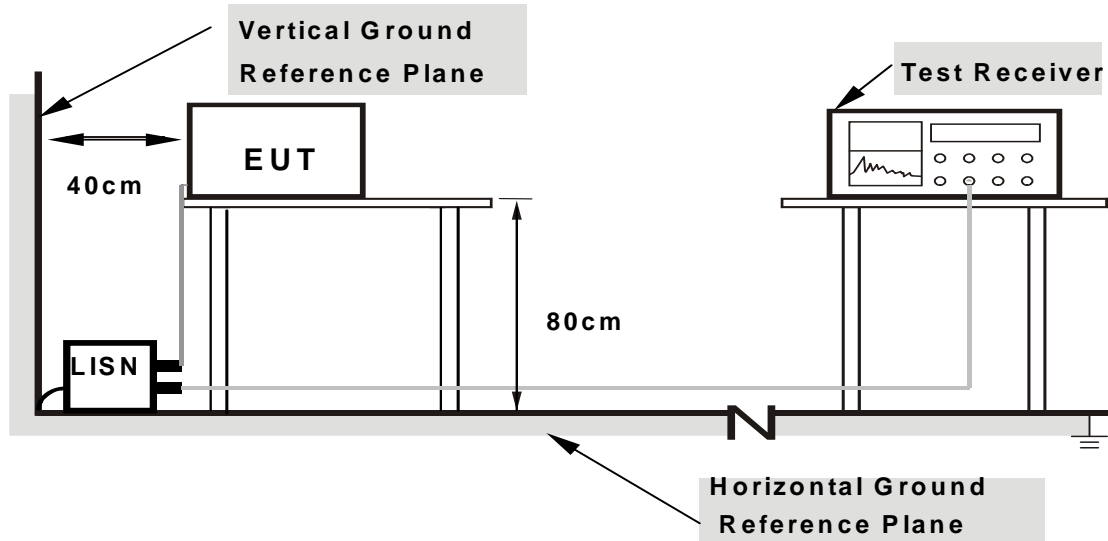

Note: 1. Support units were connected to second LISN.

2. Both of LISNs (AMN) are 80 cm from EUT and at least 80 cm from other units and other metal planes

For the actual test configuration, please refer to the attached file (Test Setup Photo).

4.2.6 EUT OPERATING CONDITIONS

Same as 4.1.6

4.2.7 TEST RESULTS

CONDUCTED WORST-CASE DATA : 802.11n (20MHz)

PHASE	Line 1	6dB BANDWIDTH	9kHz
-------	--------	---------------	------

No	Freq. [MHz]	Corr.	Reading Value		Emission Level		Limit		Margin	
		Factor	[dB (uV)]		[dB (uV)]		[dB (uV)]		(dB)	
		(dB)	Q.P.	AV.	Q.P.	AV.	Q.P.	AV.	Q.P.	AV.
1	0.15000	0.17	45.99	37.24	46.16	37.41	66.00	56.00	-19.84	-18.59
2	0.28672	0.18	30.86	25.65	31.04	25.83	60.62	50.62	-29.58	-24.79
3	0.43516	0.20	31.21	23.27	31.41	23.47	57.15	47.15	-25.74	-23.68
4	0.71250	0.22	34.29	23.65	34.51	23.87	56.00	46.00	-21.49	-22.13
5	0.86484	0.22	37.23	30.74	37.45	30.96	56.00	46.00	-18.55	-15.04
6	1.42969	0.26	35.58	25.28	35.84	25.54	56.00	46.00	-20.16	-20.46

- REMARKS:**
1. Q.P. and AV. are abbreviations of quasi-peak and average individually.
 2. "-": The Quasi-peak reading value also meets average limit and measurement with the average detector is unnecessary.
 3. The emission levels of other frequencies were very low against the limit.
 4. Margin value = Emission level - Limit value
 5. Correction factor = Insertion loss + Cable loss
 6. Emission Level = Correction Factor + Reading Value.

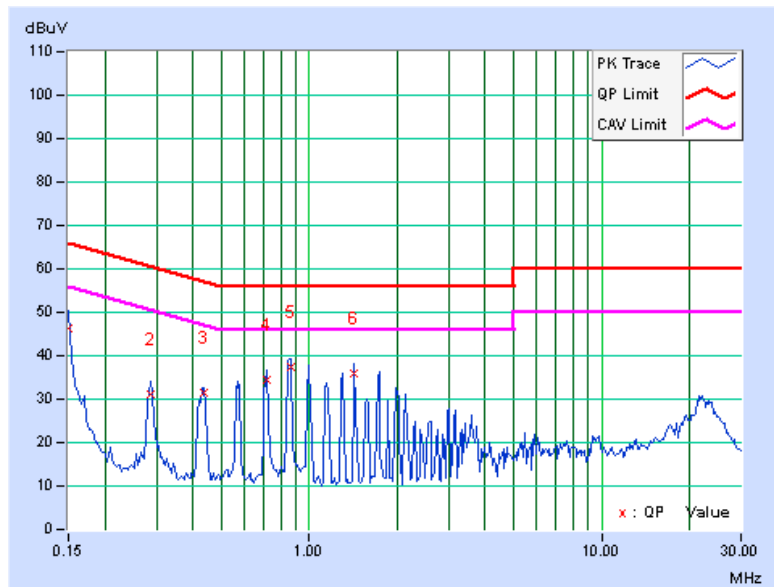



A D T

PHASE	Line 2	6dB BANDWIDTH	9kHz
-------	--------	---------------	------

No	Freq. [MHz]	Corr. Factor (dB)	Reading Value		Emission Level		Limit		Margin	
			[dB (uV)]		[dB (uV)]		[dB (uV)]		(dB)	
			Q.P.	AV.	Q.P.	AV.	Q.P.	AV.	Q.P.	AV.
1	0.15000	0.17	46.20	37.85	46.37	38.02	66.00	56.00	-19.63	-17.98
2	0.28672	0.16	36.14	32.96	36.30	33.12	60.62	50.62	-24.32	-17.50
3	0.43516	0.18	32.37	25.08	32.55	25.26	57.15	47.15	-24.60	-21.89
4	0.70859	0.19	35.15	25.86	35.34	26.05	56.00	46.00	-20.66	-19.95
5	0.84922	0.19	37.27	25.25	37.46	25.44	56.00	46.00	-18.54	-20.56
6	1.43359	0.22	35.66	27.41	35.88	27.63	56.00	46.00	-20.12	-18.37

- REMARKS:**
1. Q.P. and AV. are abbreviations of quasi-peak and average individually.
 2. "-": The Quasi-peak reading value also meets average limit and measurement with the average detector is unnecessary.
 3. The emission levels of other frequencies were very low against the limit.
 4. Margin value = Emission level - Limit value
 5. Correction factor = Insertion loss + Cable loss
 6. Emission Level = Correction Factor + Reading Value.

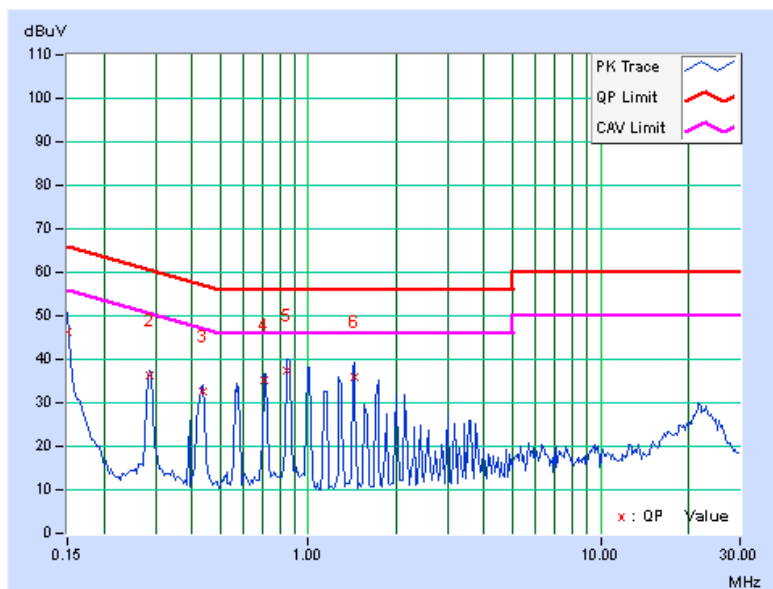

4.3 6dB BANDWIDTH MEASUREMENT

4.3.1 LIMITS OF 6dB BANDWIDTH MEASUREMENT

The minimum of 6dB Bandwidth Measurement is 0.5MHz.

4.3.2 TEST SETUP

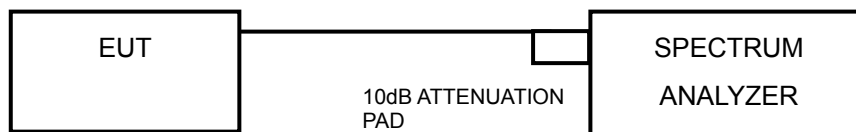

4.3.3 TEST INSTRUMENTS

Refer to section 4.1.2 to get information of above instrument.

4.3.4 TEST PROCEDURE

- a. Set resolution bandwidth (RBW) = approximately 1% of the emission bandwidth
- b. Set the video bandwidth (VBW) $\geq 3 \times$ RBW, Detector = Peak.
- c. Trace mode = max hold.
- d. Sweep = auto couple.
- e. Measure the maximum width of the emission that is constrained by the frequencies associated with the two amplitude points (upper and lower) that are attenuated by 6 dB relative to the maximum level measured in the fundamental emission

4.3.5 DEVIATION FROM TEST STANDARD

No deviation.

4.3.6 EUT OPERATING CONDITIONS

The software provided by client to enable the EUT under transmission condition continuously at lowest, middle and highest channel frequencies individually.



4.3.7 TEST RESULTS

802.11a

CHANNEL	FREQUENCY (MHz)	6dB BANDWIDTH (MHz)	MINIMUM LIMIT (MHz)	PASS / FAIL
149	5745	16.42	0.5	PASS
157	5785	16.49	0.5	PASS
165	5825	16.47	0.5	PASS

802.11n (20MHz)

CHANNEL	FREQUENCY (MHz)	6dB BANDWIDTH (MHz)		MINIMUM LIMIT (MHz)	PASS / FAIL
		CHAIN 0	CHAIN 1		
149	5745	17.52	17.51	0.5	PASS
157	5785	17.48	17.51	0.5	PASS
165	5825	17.51	17.39	0.5	PASS

802.11n (40MHz)

CHANNEL	FREQUENCY (MHz)	6dB BANDWIDTH (MHz)		MINIMUM LIMIT (MHz)	PASS / FAIL
		CHAIN 0	CHAIN 1		
151	5755	36.09	36.10	0.5	PASS
159	5795	36.21	36.22	0.5	PASS

4.4 CONDUCTED OUTPUT POWER

4.4.1 LIMITS OF CONDUCTED OUTPUT POWER MEASUREMENT

For systems using digital modulation in the 5725 –5850 MHz bands: 1 Watt (30dBm)

4.4.2 TEST SETUP

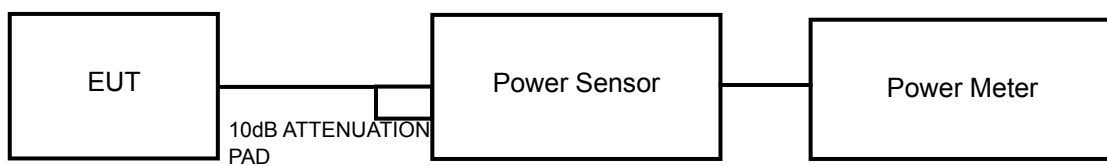

4.4.3 INSTRUMENTS

Refer to section 4.1.2 to get information of above instrument.

4.4.4 TEST PROCEDURES

A peak power sensor was used on the output port of the EUT. A power meter was used to read the response of the peak power sensor. Record the peak power level.

4.4.5 DEVIATION FROM TEST STANDARD

No deviation.

4.4.6 EUT OPERATING CONDITIONS

Same as Item 4.3.6.



A D T

4.4.7 TEST RESULTS

802.11a

CHANNEL	FREQUENCY (MHz)	PEAK POWER (mW)	PEAK POWER (dBm)	LIMIT (dBm)	PASS/FAIL
149	5745	252.3	24.02	30	PASS
157	5785	255.3	24.07	30	PASS
165	5825	252.9	24.03	30	PASS

802.11n (20MHz)

CHAN.	FREQUENCY (MHz)	PEAK POWER (dBm)		TOTAL POWER (mW)	TOTAL POWER (dBm)	LIMIT (dBm)	PASS / FAIL
		CHAIN 0	CHAIN 1				
149	5745	22.45	22.21	342.1	25.3	30	PASS
157	5785	22.47	22.42	351.2	25.5	30	PASS
165	5825	22.32	22.28	339.7	25.3	30	PASS

802.11n (40MHz)

CHAN.	FREQUENCY (MHz)	PEAK POWER (dBm)		TOTAL POWER (mW)	TOTAL POWER (dBm)	LIMIT (dBm)	PASS / FAIL
		CHAIN 0	CHAIN 1				
151	5755	20.05	20.12	204.0	23.1	30	PASS
159	5795	23.16	23.07	409.8	26.1	30	PASS

4.5 POWER SPECTRAL DENSITY MEASUREMENT

4.5.1 LIMITS OF POWER SPECTRAL DENSITY MEASUREMENT

The Maximum of Power Spectral Density Measurement is 8dBm.

4.5.2 TEST SETUP

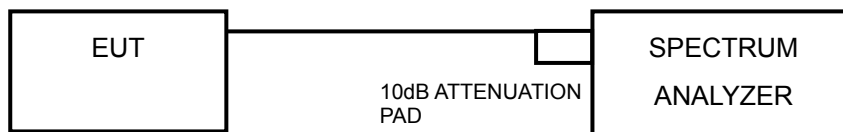

4.5.3 TEST INSTRUMENTS

Refer to section 4.1.2 to get information of above instrument.

4.5.4 TEST PROCEDURE.

- a. Set the RBW = 100 kHz, VBW = 300 kHz, Detector = peak.
- b. Sweep time = auto couple, Trace mode = max hold, allow trace to fully stabilize.
- c. Use the peak marker function to determine the maximum power level in any 100 kHz band segment within the fundamental EBW.
- d. Scale the observed power level to an equivalent value in 3 kHz by adjusting (reducing) the measured power by a bandwidth correction factor (BWCF) where $BWCF = 10\log(3 \text{ kHz}/100\text{kHz})$

4.5.5 DEVIATION FROM TEST STANDARD

No deviation.

4.5.6 EUT OPERATING CONDITION

Same as item 4.3.6.

4.5.7 TEST RESULTS

802.11a

Channel	FREQ. (MHz)	PSD (dBm/100kHz)	PSD (dBm/3kHz)	Limit (dBm/3kHz)	PASS /FAIL
149	5745	2.93	-12.30	8	PASS
157	5785	3.10	-12.13	8	PASS
165	5825	2.76	-12.47	8	PASS

802.11n (20MHz)

TX chain	Channel	FREQ. (MHz)	PSD (dBm/100kHz)	PSD (dBm/3kHz)	10 log (N=2) dB	Total PSD (dBm/3kHz)	Limit (dBm/3kHz)	PASS /FAIL
0	149	5745	1.75	-13.48	3.01	-10.47	8	PASS
	157	5785	1.88	-13.35	3.01	-10.34	8	PASS
	165	5825	1.74	-13.49	3.01	-10.48	8	PASS
1	149	5745	1.82	-13.41	3.01	-10.40	8	PASS
	157	5785	1.90	-13.33	3.01	-10.32	8	PASS
	165	5825	1.87	-13.36	3.01	-10.35	8	PASS

802.11n (40MHz)

TX chain	Channel	FREQ. (MHz)	PSD (dBm/100kHz)	PSD (dBm/3kHz)	10 log (N=2) dB	Total PSD (dBm/3kHz)	Limit (dBm/3kHz)	PASS /FAIL
0	151	5755	-2.99	-18.22	3.01	-15.21	8	PASS
	159	5795	-0.01	-15.24	3.01	-12.23	8	PASS
1	151	5755	-3.38	-18.61	3.01	-15.60	8	PASS
	159	5795	-0.32	-15.55	3.01	-12.54	8	PASS

4.6 CONDUCTED OUT OF BAND EMISSION MEASUREMENT

4.6.1 LIMITS OF CONDUCTED OUT OF BAND EMISSION MEASUREMENT

Below -20dB of the highest emission level of operating band (in 100kHz Resolution Bandwidth).

4.6.2 TEST SETUP

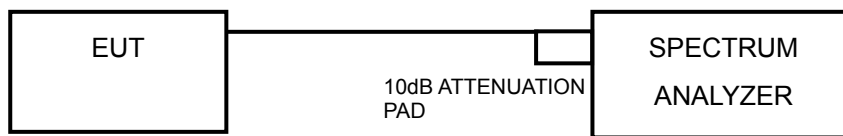

4.6.3 TEST INSTRUMENTS

Refer to section 4.1.2 to get information of above instrument.

4.6.4 TEST PROCEDURE

MEASUREMENT PROCEDURE REF

1. Set the RBW = 100 kHz.
2. Set the VBW \geq 300 kHz.
3. Detector = peak.
4. Sweep time = auto couple.
5. Trace mode = max hold.
6. Allow trace to fully stabilize.
7. Use the peak marker function to determine the maximum power level in any 100 kHz band segment within the fundamental EBW.

MEASUREMENT PROCEDURE OOB

1. Set RBW = 100 kHz.
2. Set VBW \geq 300 kHz.
3. Set span to encompass the spectrum to be examined.
4. Detector = peak.
5. Trace Mode = max hold.
6. Sweep = auto couple.

4.6.5 DEVIATION FROM TEST STANDARD

No deviation.

4.6.6 EUT OPERATING CONDITION

Same as Item 4.3.6

4.6.7 TEST RESULTS

The conducted emission test is performed on each TX port of operating mode without summing or adding $10\log(N)$ since the limit is relative emission limit. Only worst data of each operating mode is presented.

The spectrum plots are attached on the following pages. D1 line indicates the highest level, and D2 line indicates the 20dB offset below D1. It shows compliance with the requirement.



A D T

802.11a

CH 149

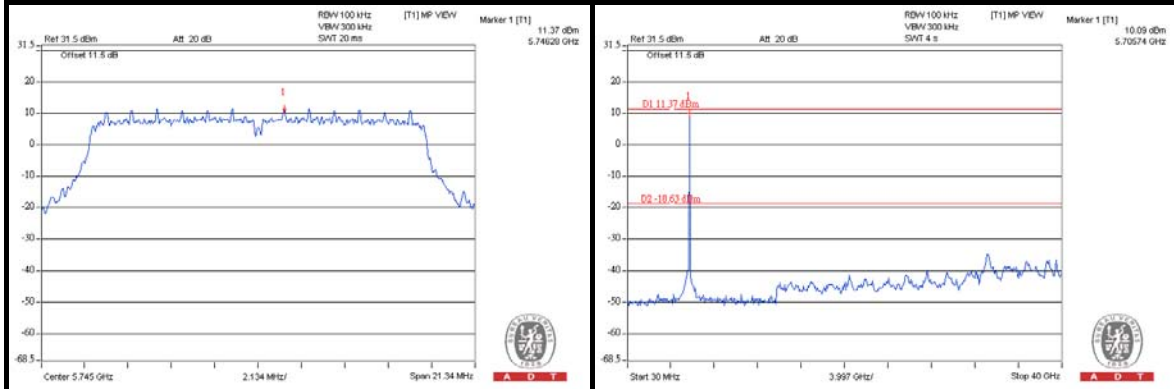

CH 157

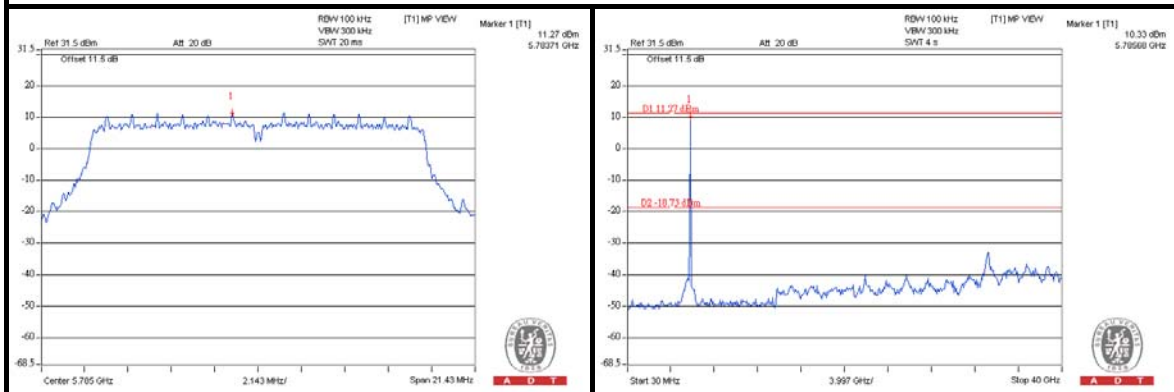

CH 165

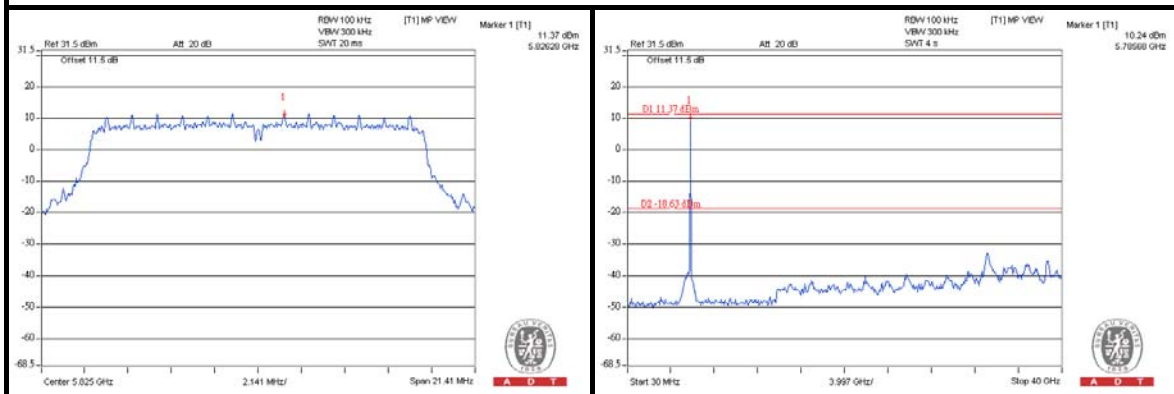



A D T

802.11n (20MHz)

CH 149

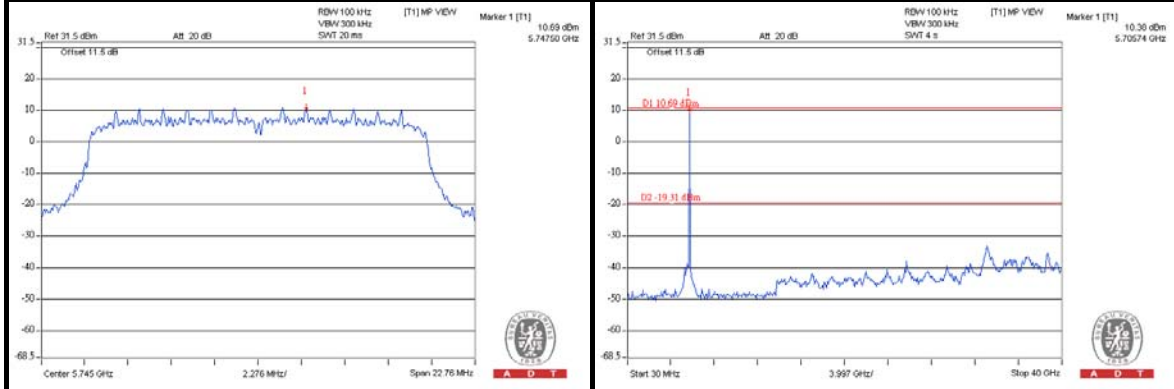

CH 157

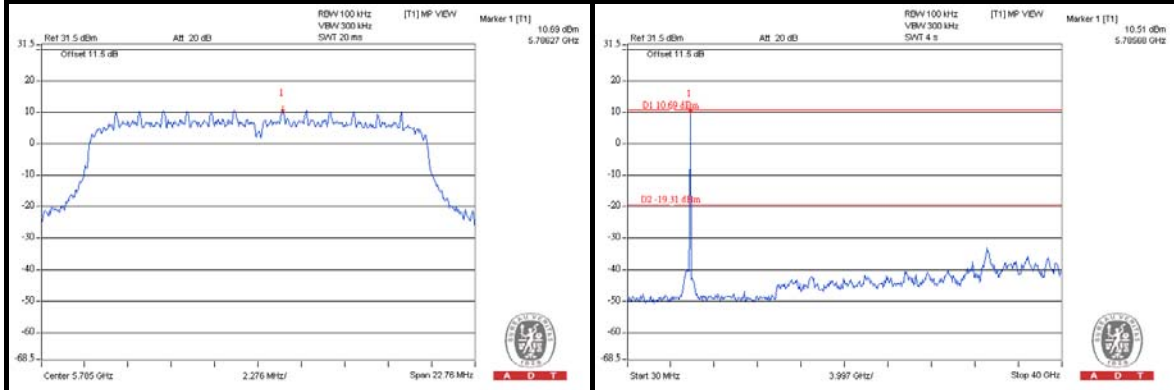

CH 165

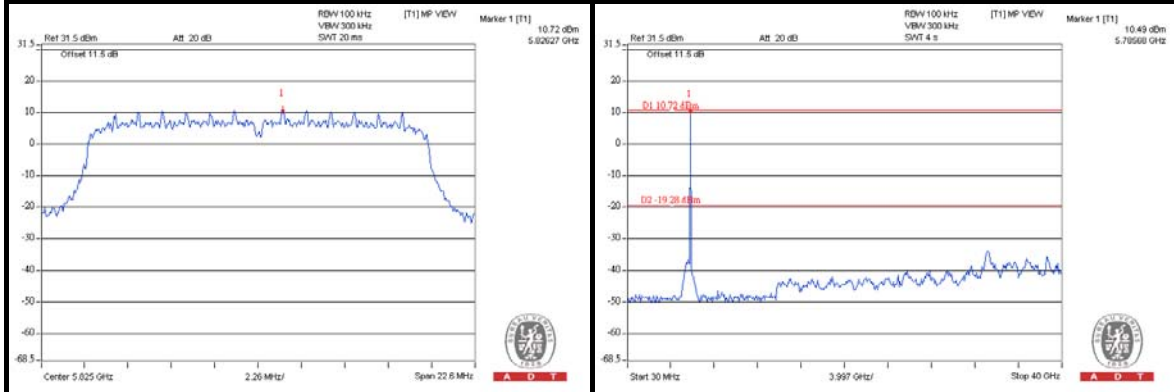

802.11n (40MHz)

CH 151

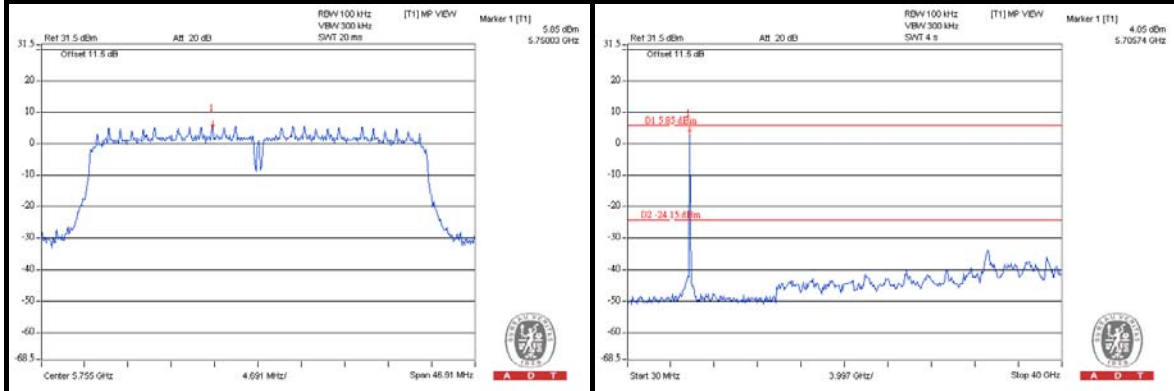

CH 159

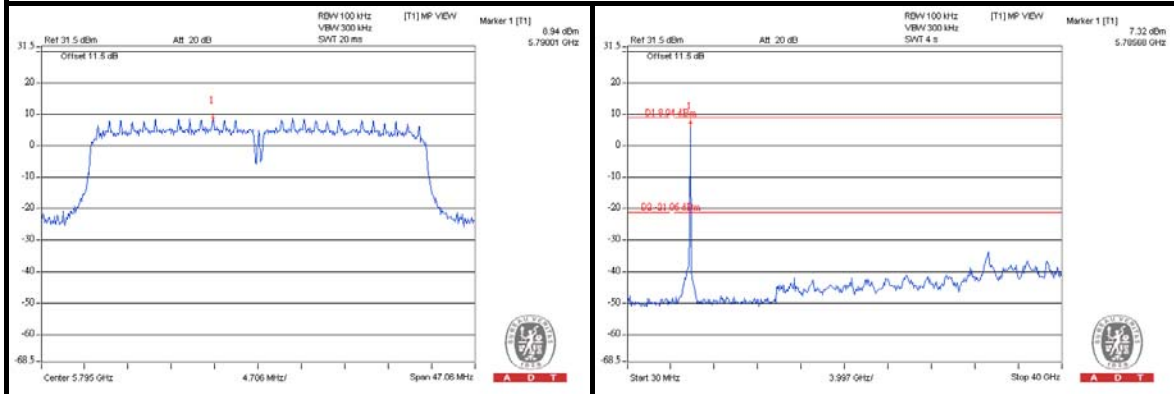

5. PHOTOGRAPHS OF THE TEST CONFIGURATION

Please refer to the attached file (Test Setup Photo).



6. INFORMATION ON THE TESTING LABORATORIES

We, Bureau Veritas Consumer Products Services (H.K.) Ltd., Taoyuan Branch, were founded in 1988 to provide our best service in EMC, Radio, Telecom and Safety consultation. Our laboratories are accredited and approved according to ISO/IEC 17025.

Copies of accreditation and authorization certificates of our laboratories obtained from approval agencies can be downloaded from our web site: www.adt.com.tw/index.5.phtml.

If you have any comments, please feel free to contact us at the following:

Linko EMC/RF Lab

Tel: 886-2-26052180

Fax: 886-2-26051924

Hsin Chu EMC/RF Lab

Tel: 886-3-5935343

Fax: 886-3-5935342

Hwa Ya EMC/RF/Safety/Telecom Lab

Tel: 886-3-3183232

Fax: 886-3-3185050

Email: service.adt@tw.bureauveritas.com

Web Site: www.adt.com.tw

The address and road map of all our labs can be found in our web site also.

7. APPENDIX A - MODIFICATIONS RECORDERS FOR ENGINEERING CHANGES TO THE EUT BY THE LAB

No modifications were made to the EUT by the lab during the test.

---END---