



# FCC TEST REPORT

**REPORT NO.:** RF120724E01C

**MODEL NO.:** DIR-645L

**FCC ID:** KA2IR645LA1

**RECEIVED:** July 24, 2012

**TESTED:** July 26 to Aug. 21, 2012

**ISSUED:** Feb. 20, 2013

**APPLICANT:** D-Link Corporation

**ADDRESS:** No.289, Sinhu 3rd Rd., Neihu District, Taipei City 114,  
Taiwan, R.O.C.

**ISSUED BY:** Bureau Veritas Consumer Products Services  
(H.K.) Ltd., Taoyuan Branch Hsin Chu Laboratory

**LAB ADDRESS :** No. 81-1, Lu Liao Keng, 9th Ling, Wu Lung Tsuen,  
Chiung Lin Hsiang, Hsin Chu Hsien 307, Taiwan,  
R.O.C.

**TEST LOCATION (1):** No. 81-1, Lu Liao Keng, 9th Ling, Wu Lung Tsuen,  
Chiung Lin Hsiang, Hsin Chu Hsien 307, Taiwan,  
R.O.C.

**TEST LOCATION (2):** No. 49, Ln. 206, Wende Rd., Shangshan Tsuen,  
Chiung Lin Hsiang, Hsin Chu Hsien 307, Taiwan,  
R.O.C.

This report should not be used by the client to claim product certification, approval, or endorsement by TAF or any government agencies.



This report is for your exclusive use. Any copying or replication of this report to or for any other person or entity, or use of our name or trademark, is permitted only with our prior written permission. This report sets forth our findings solely with respect to the test samples identified herein. The results set forth in this report are not indicative or representative of the quality or characteristics of the lot from which a test sample was taken or any similar or identical product unless specifically and expressly noted. Our report includes all of the tests requested by you and the results thereof based upon the information that you provided to us. You have 60 days from date of issuance of this report to notify us of any material error or omission caused by our negligence, provided, however, that such notice shall be in writing and shall specifically address the issue you wish to raise. A failure to raise such issue within the prescribed time shall constitute your unqualified acceptance of the completeness of this report, the tests conducted and the correctness of the report contents. Unless specific mention, the uncertainty of measurement has been explicitly taken into account to declare the compliance or non-compliance to the specification



A D T

## Table of Contents

RELEASE CONTROL RECORD .....	4
1. CERTIFICATION .....	5
2. SUMMARY OF TEST RESULTS .....	6
2.1 MEASUREMENT UNCERTAINTY .....	7
3. GENERAL INFORMATION .....	8
3.1 GENERAL DESCRIPTION OF EUT .....	8
3.2 DESCRIPTION OF TEST MODES .....	10
3.2.1 TEST MODE APPLICABILITY AND TESTED CHANNEL DETAIL .....	11
3.3 GENERAL DESCRIPTION OF APPLIED STANDARDS .....	14
3.4 DESCRIPTION OF SUPPORT UNITS.....	15
3.5 CONFIGURATION OF SYSTEM UNDER TEST .....	16
4. TEST TYPES AND RESULTS .....	18
4.1 CONDUCTED EMISSION MEASUREMENT .....	18
4.1.1 LIMITS OF CONDUCTED EMISSION MEASUREMENT .....	18
4.1.2 TEST INSTRUMENTS.....	18
4.1.3 TEST PROCEDURES .....	19
4.1.4 DEVIATION FROM TEST STANDARD .....	19
4.1.5 TEST SETUP .....	20
4.1.6 EUT OPERATING CONDITIONS .....	20
4.1.7 TEST RESULTS (MODE 1) .....	21
4.1.8 TEST RESULTS (MODE 2) .....	23
4.2 RADIATED EMISSION AND BANDEDGE MEASUREMENT .....	25
4.2.1 LIMITS OF RADIATED EMISSION AND BANDEDGE MEASUREMENT .....	25
4.2.2 TEST INSTRUMENTS.....	26
4.2.3 TEST PROCEDURES .....	27
4.2.4 DEVIATION FROM TEST STANDARD .....	27
4.2.5 TEST SETUP .....	28
4.2.6 EUT OPERATING CONDITIONS .....	28
4.2.7 TEST RESULTS .....	29
4.3 6dB BANDWIDTH MEASUREMENT .....	42
4.3.1 LIMITS OF 6dB BANDWIDTH MEASUREMENT .....	42
4.3.2 TEST INSTRUMENTS.....	42
4.3.3 TEST PROCEDURE.....	42
4.3.4 DEVIATION FROM TEST STANDARD .....	42
4.3.5 TEST SETUP .....	42
4.3.6 EUT OPERATING CONDITIONS .....	42
4.3.7 TEST RESULTS .....	43
4.4 CONDUCTED OUTPUT POWER MEASUREMENT .....	44
4.4.1 LIMITS OF MAXIMUM PEAK OUTPUT POWER MEASUREMENT .....	44
4.4.2 INSTRUMENTS.....	44



A D T

4.4.3	TEST PROCEDURES .....	44
4.4.4	DEVIATION FROM TEST STANDARD .....	44
4.4.5	TEST SETUP .....	44
4.4.6	EUT OPERATING CONDITIONS .....	45
4.4.7	TEST RESULTS .....	46
4.5	POWER SPECTRAL DENSITY MEASUREMENT .....	47
4.5.1	LIMITS OF POWER SPECTRAL DENSITY MEASUREMENT .....	47
4.5.2	TEST INSTRUMENTS.....	47
4.5.3	TEST PROCEDURE.....	47
4.5.4	DEVIATION FROM TEST STANDARD .....	47
4.5.5	TEST SETUP .....	47
4.5.6	EUT OPERATING CONDITION.....	48
4.5.7	TEST RESULTS .....	49
4.6	CONDUCTED OUT-BAND EMISSION MEASUREMENT.....	51
4.6.1	LIMITS OF CONDUCTED OUT-BAND EMISSION MEASUREMENT.....	51
4.6.2	TEST INSTRUMENTS.....	51
4.6.3	TEST PROCEDURE.....	51
4.6.4	DEVIATION FROM TEST STANDARD .....	52
4.6.5	TEST SETUP .....	52
4.6.6	EUT OPERATING CONDITION.....	52
4.6.7	TEST RESULTS .....	52
5.	PHOTOGRAPHS OF THE TEST CONFIGURATION.....	57
6.	INFORMATION ON THE TESTING LABORATORIES .....	58
7.	APPENDIX A - MODIFICATIONS RECORDERS FOR ENGINEERING CHANGES TO THE EUT BY THE LAB.....	59



A D T

## RELEASE CONTROL RECORD

ISSUE NO.	REASON FOR CHANGE	DATE ISSUED
RF120724E01C	Original release	Feb. 20, 2013



## 1. CERTIFICATION

**PRODUCT:** Wireless N300 Gigabit Cloud Router with SmartBeam™ Technology

**BRAND NAME:** D-Link

**MODEL NO.:** DIR-645L

**TEST SAMPLE:** ENGINEERING SAMPLE

**APPLICANT:** D-Link Corporation

**TESTED:** July 26 to Aug. 21, 2012

**STANDARDS:** FCC Part 15, Subpart C (Section 15.247)  
ANSI C63.10-2009

The above equipment (Model: DIR-645L) has been tested by **Bureau Veritas Consumer Products Services (H.K.) Ltd., Taoyuan Branch**, and found compliance with the requirement of the above standards. The test record, data evaluation & Equipment Under Test (EUT) configurations represented herein are true and accurate accounts of the measurements of the sample's EMC characteristics under the conditions specified in this report.

**PREPARED BY** : , **DATE:** Feb. 20, 2013  
(Lori Chung, Specialist)

**APPROVED BY** : , **DATE:** Feb. 20, 2013  
(May Chen, Deputy Manager)



A D T

## 2. SUMMARY OF TEST RESULTS

The EUT has been tested according to the following specifications:

APPLIED STANDARD: FCC PART 15, SUBPART C (SECTION 15.247)			
STANDARD SECTION	TEST TYPE	RESULT	REMARK
15.207	AC Power Conducted Emission	PASS	Meet the requirement of limit. Minimum passing margin is -4.49dB at 10.41406MHz.
15.247(d) 15.209	Radiated Emissions	PASS	Meet the requirement of limit. Minimum passing margin is -0.5dB at 2390.00MHz.
15.247(d)	Band Edge Measurement	PASS	Meet the requirement of limit.
15.247(a)(2)	6dB bandwidth	PASS	Meet the requirement of limit.
15.247(b)	Conducted power	PASS	Meet the requirement of limit.
15.247(e)	Power Spectral Density	PASS	Meet the requirement of limit.
15.203	Antenna Requirement	PASS	No antenna connector is used.



A D T

## 2.1 MEASUREMENT UNCERTAINTY

Where relevant, the following measurement uncertainty levels have been estimated for tests performed on the EUT as specified in CISPR 16-4-2:

This uncertainty represents an expanded uncertainty expressed at approximately the 95% confidence level using a coverage factor of  $k=2$ .

Measurement	Value
Conducted emissions	2.98 dB
Radiated emissions (30MHz-1GHz)	5.59 dB
Radiated emissions (1GHz -6GHz)	3.56 dB
Radiated emissions (6GHz -18GHz)	4.10 dB
Radiated emissions (18GHz -40GHz)	4.24 dB



A D T

### 3. GENERAL INFORMATION

#### 3.1 GENERAL DESCRIPTION OF EUT

<b>PRODUCT</b>	Wireless N300 Gigabit Cloud Router with SmartBeam™ Technology
<b>MODEL NO.</b>	DIR-645L
<b>POWER SUPPLY</b>	DC 12V from power adapter
<b>MODULATION TYPE</b>	CCK, DQPSK, DBPSK for DSSS 64QAM, 16QAM, QPSK, BPSK for OFDM
<b>MODULATION TECHNOLOGY</b>	DSSS, OFDM
<b>TRANSFER RATE</b>	802.11b: up to 11Mbps 802.11g: up to 54Mbps 802.11n (HT20, 800ns GI): up to 130Mbps 802.11n (HT20, 400ns GI): up to 144.444Mbps 802.11n (HT40, 800ns GI): up to 270Mbps 802.11n (HT40, 400ns GI): up to 300Mbps
<b>OPERATING FREQUENCY</b>	2.4GHz: 2.412 ~ 2.462GHz
<b>NUMBER OF CHANNEL</b>	11 for 802.11b, 802.11g, 802.11n (HT20) 7 for 802.11n (HT40)
<b>MAXIMUM OUTPUT POWER</b>	802.11b: 164.437mW 802.11g: 154.525mW 802.11n (HT20): 307.869mW 802.11n (HT40): 296.617mW
<b>ANTENNA TYPE</b>	Please see NOTE
<b>DATA CABLE</b>	NA
<b>I/O PORTS</b>	Refer to user's manual
<b>ASSOCIATED DEVICES</b>	NA

**NOTE:**

1. The EUT must be supplied with power adapter as following table:

No	Manufacturer	Brand	Model No.	Spec.
1	CWT	D-Link	SAG024F 4 US	Input: 100-240V, 0.8A, 47-63Hz Output: 12V, 2.0A DC power cable: 1.2m, unshielded
2	AMIGO		AMS4-1202000FU	Input: 100-240V, 0.8A, 50/60Hz Output: 12V, 2.0A DC power cable: 1.2m, unshielded

For radiated test, the EUT was pre-tested with above adapters, the worse case was found in adapter 2. Therefore only the test data of the adapter was recorded in the test report.





A D T

2. There are six antennas provided to this EUT, please refer to the following table:

Antenna	Manufacture	Model name	Antenna Gain (dBi)	Frequency range (MHz to MHz)	Antenna Type	Connector
1	MEDIATEK	NA	3.33	2400~2483.5	PIFA	NA
2	MEDIATEK	NA	5.30	2400~2483.5	PIFA	NA
3	MEDIATEK	NA	3.76	2400~2483.5	PIFA	NA
4	MEDIATEK	NA	5.23	2400~2483.5	PIFA	NA
5	MEDIATEK	NA	4.87	2400~2483.5	PIFA	NA
6	MEDIATEK	NA	4.92	2400~2483.5	PIFA	NA

3. According to the above antennas, there are two antennas will transmit simultaneously. Therefore the following antenna combination modes could be chosen as below table:

COMBINATION MODE	Antenna Configuration	
	CHAIN(0)	CHAIN(1)
1	Antenna 1 - H	Antenna 4 - V
2	Antenna 1 - H	Antenna 5 - V
3	Antenna 1 - H	Antenna 6 - V
4	Antenna 2 - H	Antenna 4 - V
5	Antenna 2 - H	Antenna 5 - V
6	Antenna 2 - H	Antenna 6 - V
7	Antenna 3 - H	Antenna 4 - V
8	Antenna 3 - H	Antenna 5 - V
9	Antenna 3 - H	Antenna 6 - V

**Note:**

Above antenna combinations were pre-tested in chamber, the worse case was found as below:

1. The antenna 2 was selected as representative antennas for 802.11b and 802.11g final test.
2. The antenna 2, 4 were selected as representative antennas for 802.11n final test.

4. The EUT incorporates a MIMO function without beam forming.

MODULATION MODE	Tx/Rx FUNCTION
802.11b	1Tx/2Rx
802.11g	1Tx/2Rx
802.11n (HT20)	2Tx/2Rx
802.11n (HT40)	2Tx/2Rx

5. When the EUT operating in 802.11n, the software operation, which is defined by manufacturer, MCS (Modulation and Coding Schemes) from 0 to 15.

6. The above EUT information was declared by the manufacturer and for more detailed features description, please refer to the manufacturer's specifications or User's Manual.

### 3.2 DESCRIPTION OF TEST MODES

11 channels are provided for 802.11b, 802.11g, 802.11n (HT20):

CHANNEL	FREQUENCY	CHANNEL	FREQUENCY
1	2412MHz	7	2442MHz
2	2417MHz	8	2447MHz
3	2422MHz	9	2452MHz
4	2427MHz	10	2457MHz
5	2432MHz	11	2462MHz
6	2437MHz		

7 channels are provided for 802.11n (HT40):

CHANNEL	FREQUENCY	CHANNEL	FREQUENCY
3	2422MHz	7	2442MHz
4	2427MHz	8	2447MHz
5	2432MHz	9	2452MHz
6	2437MHz		





A D T

#### **RADIATED EMISSION TEST (ABOVE 1 GHz):**

- Pre-Scan has been conducted to determine the worst-case mode from all possible combinations between available modulations, data rates and antenna ports (if EUT with antenna diversity architecture).
- Following channel(s) was (were) selected for the final test as listed below.

MODE	AVAILABLE CHANNEL	TESTED CHANNEL	MODULATION TECHNOLOGY	MODULATION TYPE	DATA RATE (Mbps)
802.11b	1 to 11	1, 6, 11	DSSS	DBPSK	1
802.11g	1 to 11	1, 6, 11	OFDM	BPSK	6
802.11n (HT20)	1 to 11	1, 6, 11	OFDM	BPSK	6.5
802.11n (HT40)	3 to 9	3, 6, 9	OFDM	BPSK	13.5

#### **ANTENNA PORT CONDUCTED MEASUREMENT:**

- Pre-Scan has been conducted to determine the worst-case mode from all possible combinations between available modulations, data rates and antenna ports (if EUT with antenna diversity architecture).
- Following channel(s) was (were) selected for the final test as listed below.

MODE	AVAILABLE CHANNEL	TESTED CHANNEL	MODULATION TECHNOLOGY	MODULATION TYPE	DATA RATE (Mbps)
802.11b	1 to 11	1, 6, 11	DSSS	DBPSK	1
802.11g	1 to 11	1, 6, 11	OFDM	BPSK	6
802.11n (HT20)	1 to 11	1, 6, 11	OFDM	BPSK	6.5
802.11n (HT40)	3 to 9	3, 6, 9	OFDM	BPSK	13.5

#### **CONDUCTED OUT-BAND EMISSION MEASUREMENT:**

- Pre-Scan has been conducted to determine the worst-case mode from all possible combinations between available modulations, data rates and antenna ports (if EUT with antenna diversity architecture).
- Following channel(s) was (were) selected for the final test as listed below.

MODE	AVAILABLE CHANNEL	TESTED CHANNEL	MODULATION TECHNOLOGY	MODULATION TYPE	DATA RATE (Mbps)
802.11b	1 to 11	1, 6, 11	DSSS	DBPSK	1
802.11g	1 to 11	1, 6, 11	OFDM	BPSK	6
802.11n (HT20)	1 to 11	1, 6, 11	OFDM	BPSK	6.5
802.11n (HT40)	3 to 9	3, 6, 9	OFDM	BPSK	13.5



A D T

**TEST CONDITION:**

APPLICABLE TO	ENVIRONMENTAL CONDITIONS	INPUT POWER	TESTED BY
PLC	25deg. C, 65%RH	120Vac, 60Hz	Kyle Huang
RE<1G	25deg. C, 71%RH	120Vac, 60Hz	Frank Liu
RE <sup>3</sup> 1G	25deg. C, 66%RH	120Vac, 60Hz	Robert Cheng
APCM	25deg. C, 60%RH	120Vac, 60Hz	Frank Liu
OB	25deg. C, 60%RH	120Vac, 60Hz	Frank Liu

### 3.3 GENERAL DESCRIPTION OF APPLIED STANDARDS

The EUT is a RF product. According to the specifications of the manufacturer, it must comply with the requirements of the following standards:

**FCC Part 15, Subpart C. (15.247)**

**558074 D01 DTS Meas Guidance v01**

**ANSI C63.10-2009**

All test items have been performed and recorded as per the above standards.

**Note:** The EUT has been verified to comply with the requirements of FCC Part 15, Subpart B, Class B (DoC). The test report has been issued separately.



A D T

### 3.4 DESCRIPTION OF SUPPORT UNITS

The EUT has been tested as an independent unit together with other necessary accessories or support units. The following support units or accessories were used to form a representative test configuration during the tests.

For Conducted emission test					
NO.	PRODUCT	BRAND	MODEL NO.	SERIAL NO.	FCC ID
1	NOTEBOOK COMPUTER	DELL	PP18L	12252644560	FCC DoC
2	NOTEBOOK COMPUTER	DELL	E6420	B92T3R1	FCC DoC
3	NOTEBOOK COMPUTER	DELL	E5420	CHHYLQ1	FCC DoC
4	NOTEBOOK COMPUTER	DELL	PP27L	6YLB32S	FCC DoC
5	USB Flash Drive	SanDisk	SDCZ2-512-A10	5597844849	FCC DoC
6	SWITCH	HP	J9088A	NA	NA

For Other test items					
NO.	PRODUCT	BRAND	MODEL NO.	SERIAL NO.	FCC ID
1	NOTEBOOK COMPUTER	DELL	E6420	H62T3R1	FCC DoC
2	NOTEBOOK COMPUTER	DELL	PP32LA	DSL32S	FCC DoC
3	HUB	ZyXEL	ES-116P	S060H0200021 5	FCC DoC
4	iPod shuffle	Apple	MC749TA/A	CC4DM9M8DF DM	NA

For Conducted emission test	
NO.	SIGNAL CABLE DESCRIPTION OF THE ABOVE SUPPORT UNITS
1	UTP cable (10m)
2	UTP cable (10m)
3	NA
4	NA
5	NA
6	UTP cable (10m)

For Other test items	
NO.	SIGNAL CABLE DESCRIPTION OF THE ABOVE SUPPORT UNITS
1	UTP cable, 10m
2	UTP cable, 10m
3	UTP cable, 10m
4	USB cable, 0.1m

**NOTE:** All power cords of the above support units are non shielded (1.8m).

### 3.5 CONFIGURATION OF SYSTEM UNDER TEST

For Conducted emission test:

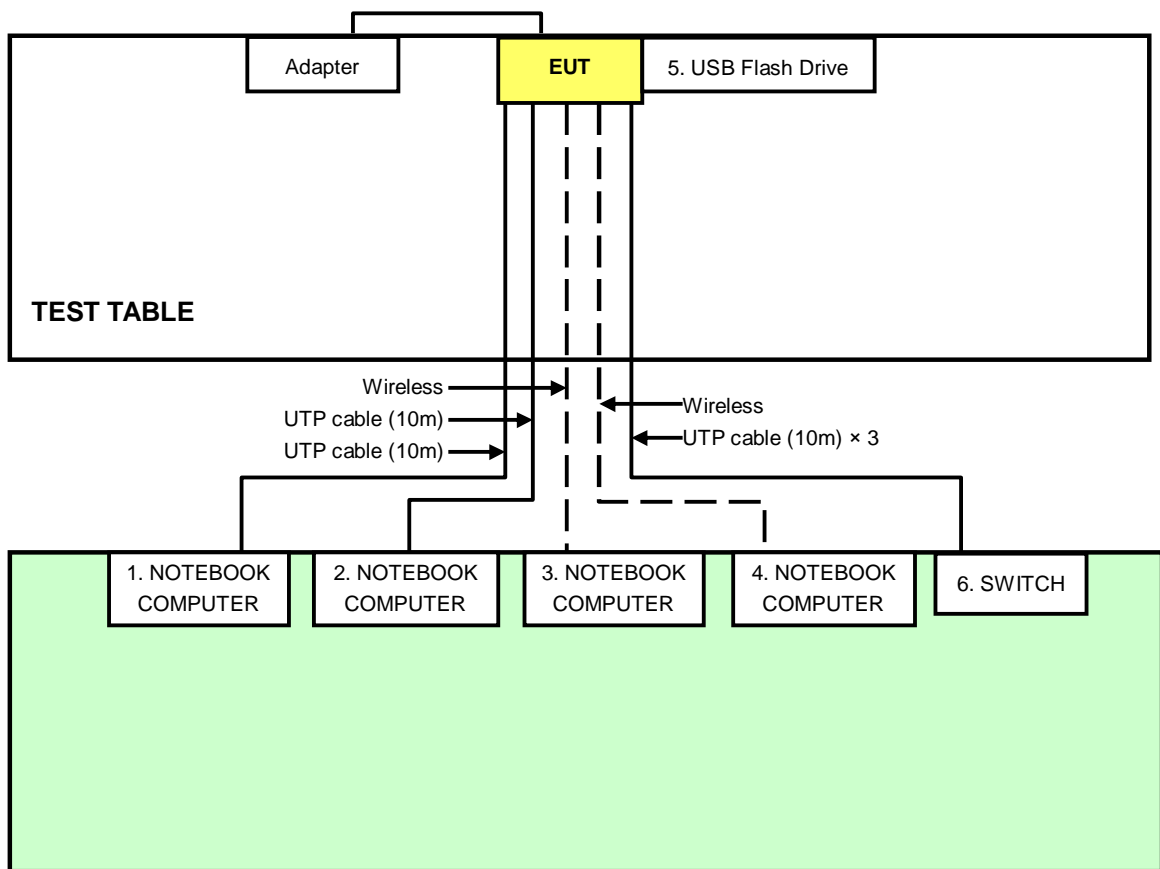



**For Other test items:**

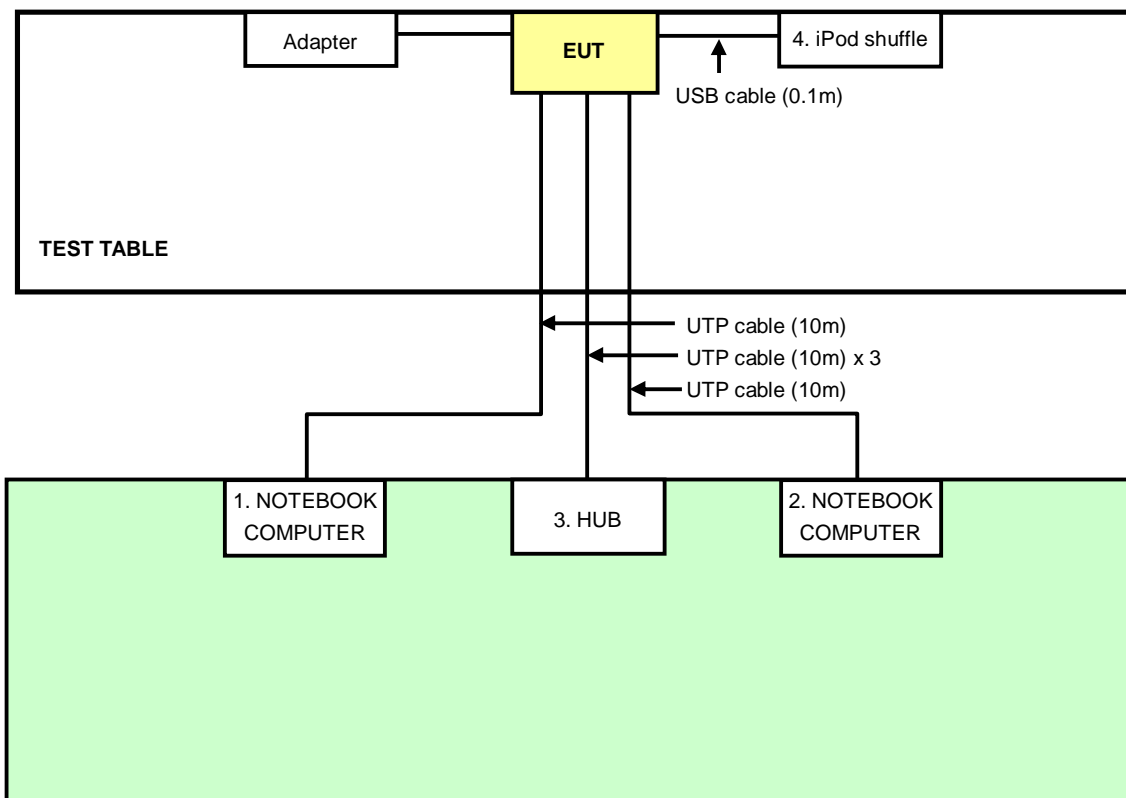



A D T

## 4. TEST TYPES AND RESULTS

### 4.1 CONDUCTED EMISSION MEASUREMENT

#### 4.1.1 LIMITS OF CONDUCTED EMISSION MEASUREMENT

FREQUENCY OF EMISSION (MHz)	CONDUCTED LIMIT (dB $\mu$ V)	
	Quasi-peak	Average
0.15-0.5	66 to 56	56 to 46
0.5-5	56	46
5-30	60	50

- NOTE:**
1. The lower limit shall apply at the transition frequencies.
  2. The limit decreases in line with the logarithm of the frequency in the range of 0.15 to 0.50 MHz.

#### 4.1.2 TEST INSTRUMENTS

DESCRIPTION & MANUFACTURER	MODEL NO.	SERIAL NO.	CALIBRATED DATE	CALIBRATED UNTIL
Test Receiver ROHDE & SCHWARZ	ESCS 30	100287	Feb. 29, 2012	Feb. 28, 2013
Line-Impedance Stabilization Network (for EUT) SCHWARZBECK	NSLK 8127	8127-523	Sep. 20, 2011	Sep. 19, 2012
Line-Impedance Stabilization Network (for Peripheral) ROHDE & SCHWARZ	ESH3-Z5	848773/004	Nov. 01, 2011	Oct. 31, 2012
RF Cable (JYEBAO)	5DFB	COACAB-002	Aug. 05, 2012	Aug. 04, 2013
50 ohms Terminator	50	4	Nov. 12, 2011	Nov. 11, 2012
Software ADT	BV ADT_Cond_V7.3.7 .3	NA	NA	NA

**Note:**

1. The calibration interval of the above test instruments is 12 months and the calibrations are traceable to NML/ROC and NIST/USA.
2. The test was performed in Shielded Room No. A.
3. The VCCI Con A Registration No. is C-817.
4. Tested Date: Aug. 21, 2012



A D T

#### 4.1.3 TEST PROCEDURES

- a. The EUT was placed 0.4 meters from the conducting wall of the shielded room with EUT being connected to the power mains through a line impedance stabilization network (LISN). Other support units were connected to the power mains through another LISN. The two LISNs provide 50 ohm/ 50uH of coupling impedance for the measuring instrument.
- b. Both lines of the power mains connected to the EUT were checked for maximum conducted interference.
- c. The frequency range from 150kHz to 30MHz was searched. At least the disturbance levels and the frequencies of six highest disturbances from each mains port were recorded.

**Note:** All modes of operation were investigated and the worst-case emissions are reported.

#### 4.1.4 DEVIATION FROM TEST STANDARD

No deviation

#### 4.1.5 TEST SETUP

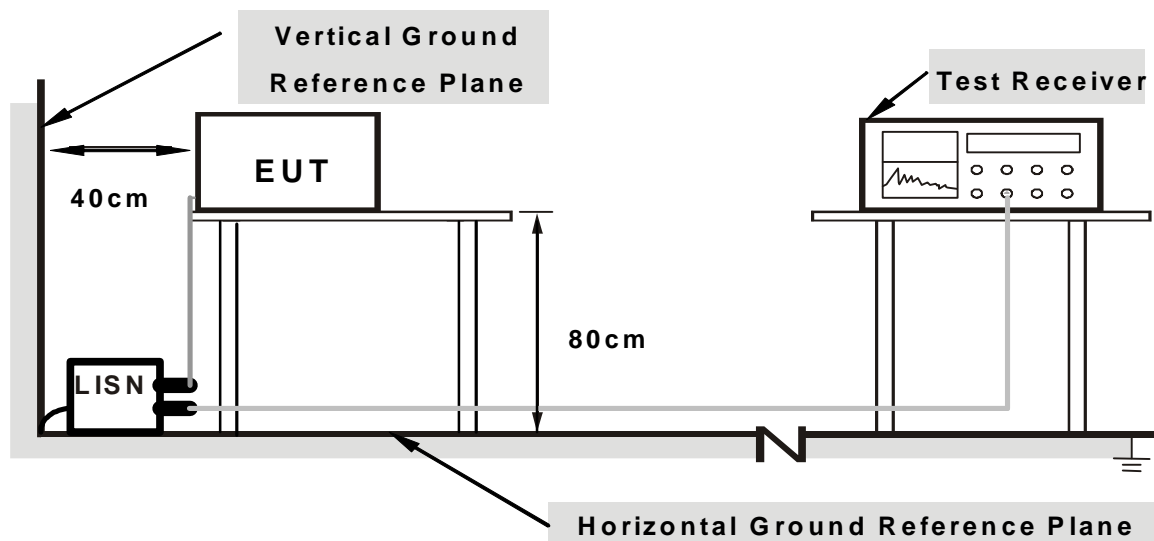

**Note: 1. Support units were connected to second LISN.**

**2. Both of LISNs (AMN) are 80 cm from EUT and at least 80 from other units and other metal planes**

For the actual test configuration, please refer to the related item – Photographs of the Test Configuration.

#### 4.1.6 EUT OPERATING CONDITIONS

1. Turn on the power of EUT.
2. The communication partner run test program “RT5x9x V1.0.7.6 AP” to enable EUT under transmission/receiving condition continuously at specific channel frequency.

### 4.1.7 TEST RESULTS (MODE 1)

<b>PHASE</b>	Line (L)	<b>6dB BANDWIDTH</b>	9 kHz
--------------	----------	----------------------	-------

No	Freq. [MHz]	Corr. Factor (dB)	Reading Value [dB (uV)]		Emission Level [dB (uV)]		Limit [dB (uV)]		Margin (dB)	
			Q.P.	AV.	Q.P.	AV.	Q.P.	AV.	Q.P.	AV.
1	0.15391	0.06	56.39	46.71	56.45	46.77	65.79	55.79	-9.34	-9.02
2	0.18906	0.06	48.24	40.14	48.30	40.20	64.08	54.08	-15.78	-13.88
3	6.51953	0.32	39.72	33.77	40.04	34.09	60.00	50.00	-19.96	-15.91
4	10.75000	0.42	49.10	43.89	49.52	44.31	60.00	50.00	-10.48	-5.69
5	12.48438	0.46	42.28	37.25	42.74	37.71	60.00	50.00	-17.26	-12.29
6	23.52734	0.69	33.25	27.62	33.94	28.31	60.00	50.00	-26.06	-21.69

#### REMARKS:

1. Q.P. and AV. are abbreviations of quasi-peak and average individually.
2. The emission levels of other frequencies were very low against the limit.
3. Margin value = Emission level - Limit value
4. Correction factor = Insertion loss + Cable loss
5. Emission Level = Correction Factor + Reading Value.

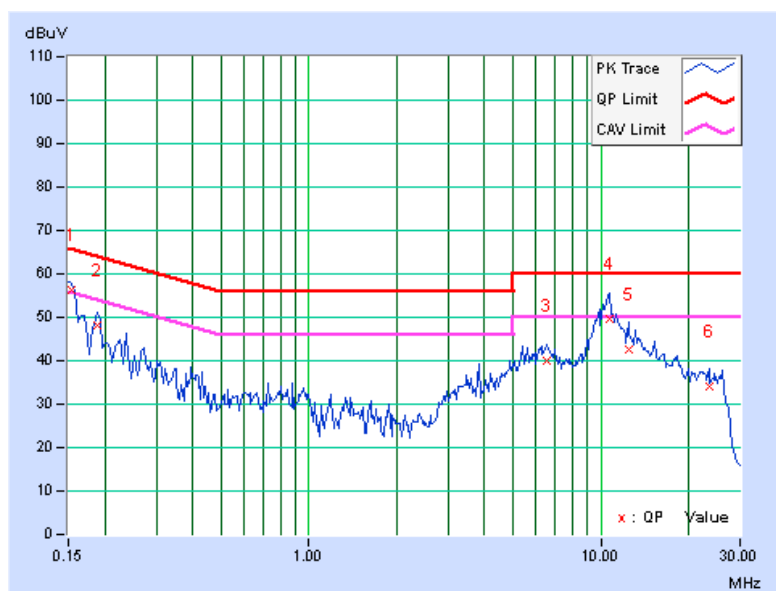

PHASE	Neutral (N)	6dB BANDWIDTH	9 kHz
-------	-------------	---------------	-------

No	Freq. [MHz]	Corr. Factor (dB)	Reading Value		Emission Level		Limit		Margin	
			[dB (uV)]		[dB (uV)]		[dB (uV)]		(dB)	
			Q.P.	AV.	Q.P.	AV.	Q.P.	AV.	Q.P.	AV.
1	0.15391	0.07	56.03	46.81	56.10	46.88	65.79	55.79	-9.69	-8.91
2	0.18906	0.07	49.36	39.11	49.43	39.18	64.08	54.08	-14.65	-14.90
3	6.10547	0.30	40.54	35.15	40.84	35.45	60.00	50.00	-19.16	-14.55
<b>4</b>	<b>10.41406</b>	<b>0.39</b>	<b>50.69</b>	<b>45.12</b>	<b>51.08</b>	<b>45.51</b>	<b>60.00</b>	<b>50.00</b>	<b>-8.92</b>	<b>-4.49</b>
5	15.96875	0.52	37.47	32.21	37.99	32.73	60.00	50.00	-22.01	-17.27
6	24.25391	0.69	31.77	26.75	32.46	27.44	60.00	50.00	-27.54	-22.56

**REMARKS:**

1. Q.P. and AV. are abbreviations of quasi-peak and average individually.
2. The emission levels of other frequencies were very low against the limit.
3. Margin value = Emission level - Limit value
4. Correction factor = Insertion loss + Cable loss
5. Emission Level = Correction Factor + Reading Value.

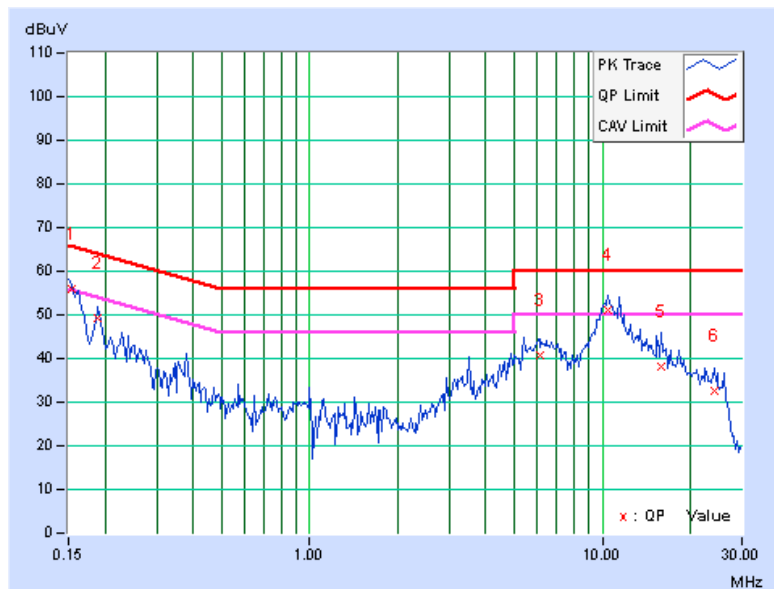

### 4.1.8 TEST RESULTS (MODE 2)

<b>PHASE</b>	Line (L)	<b>6dB BANDWIDTH</b>	9 kHz
--------------	----------	----------------------	-------

No	Freq.	Corr.	Reading Value		Emission Level		Limit		Margin	
	[MHz]	Factor	[dB (uV)]		[dB (uV)]		[dB (uV)]		(dB)	
		(dB)	Q.P.	AV.	Q.P.	AV.	Q.P.	AV.	Q.P.	AV.
1	0.19687	0.06	51.21	40.08	51.27	40.14	63.74	53.74	-12.47	-13.60
2	0.25156	0.06	48.86	39.57	48.92	39.63	61.71	51.71	-12.78	-12.07
3	0.32578	0.07	44.48	33.61	44.55	33.68	59.56	49.56	-15.01	-15.88
4	0.44297	0.07	39.62	31.20	39.69	31.27	57.01	47.01	-17.31	-15.73
5	0.96250	0.12	31.55	21.70	31.67	21.82	56.00	46.00	-24.33	-24.18
6	13.01172	0.47	37.29	35.55	37.76	36.02	60.00	50.00	-22.24	-13.98

**REMARKS:**

1. Q.P. and AV. are abbreviations of quasi-peak and average individually.
2. The emission levels of other frequencies were very low against the limit.
3. Margin value = Emission level - Limit value
4. Correction factor = Insertion loss + Cable loss
5. Emission Level = Correction Factor + Reading Value.

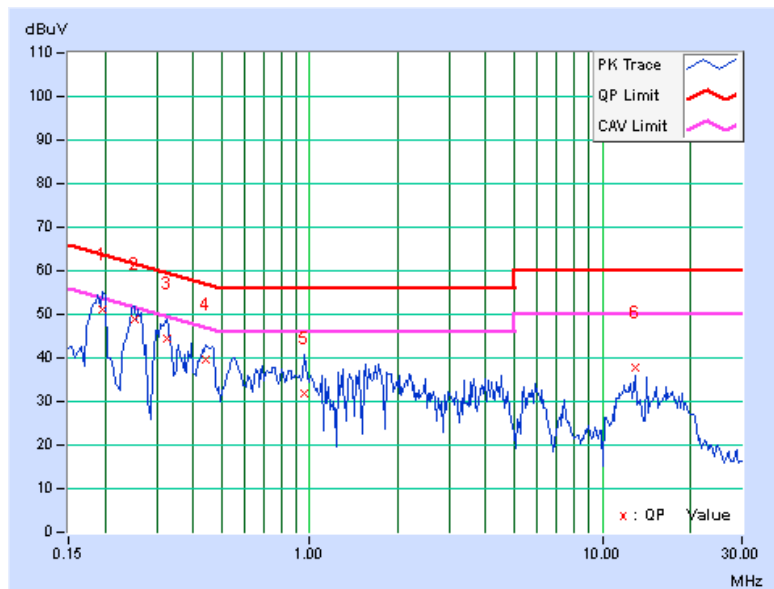

PHASE	Neutral (N)	6dB BANDWIDTH	9 kHz
-------	-------------	---------------	-------

No	Freq. [MHz]	Corr. Factor (dB)	Reading Value		Emission Level		Limit		Margin	
			[dB (uV)]		[dB (uV)]		[dB (uV)]		(dB)	
			Q.P.	AV.	Q.P.	AV.	Q.P.	AV.	Q.P.	AV.
1	0.19687	0.07	51.61	39.77	51.68	39.84	63.74	53.74	-12.06	-13.90
2	0.25547	0.07	48.58	38.43	48.65	38.50	61.58	51.58	-12.92	-13.07
3	0.32969	0.08	41.52	27.20	41.60	27.28	59.46	49.46	-17.86	-22.18
4	0.91563	0.11	36.34	25.67	36.45	25.78	56.00	46.00	-19.55	-20.22
5	1.57813	0.15	37.67	28.27	37.82	28.42	56.00	46.00	-18.18	-17.58
6	11.83203	0.42	35.53	29.73	35.95	30.15	60.00	50.00	-24.05	-19.85

**REMARKS:**

1. Q.P. and AV. are abbreviations of quasi-peak and average individually.
2. The emission levels of other frequencies were very low against the limit.
3. Margin value = Emission level - Limit value
4. Correction factor = Insertion loss + Cable loss
5. Emission Level = Correction Factor + Reading Value.

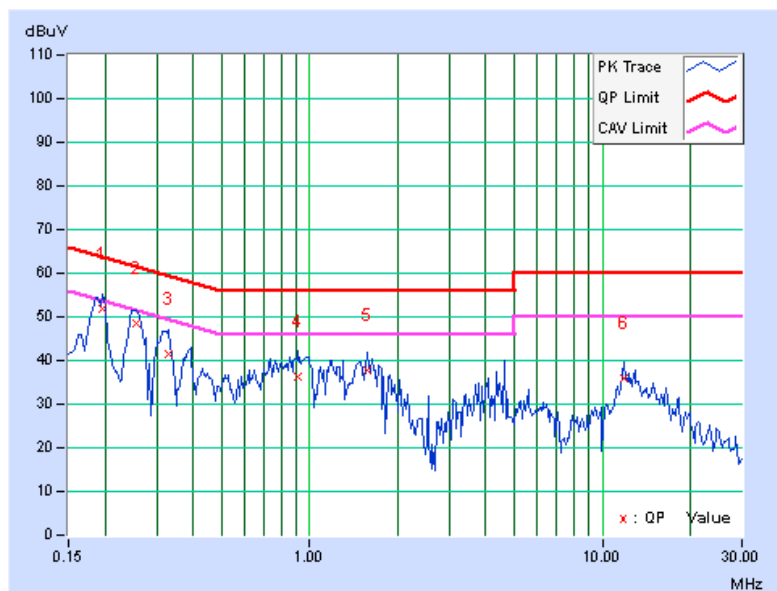





A D T

## 4.2 RADIATED EMISSION AND BANDEDGE MEASUREMENT

### 4.2.1 LIMITS OF RADIATED EMISSION AND BANDEDGE MEASUREMENT

Radiated emissions which fall in the restricted bands must comply with the radiated emission limits specified as below table. Other emissions shall be at least 30dB below the highest level of the desired power:

Frequencies (MHz)	Field strength (microvolts/meter)	Measurement distance (meters)
0.009-0.490	2400/F(kHz)	300
0.490-1.705	24000/F(kHz)	30
1.705-30.0	30	30
30-88	100	3
88-216	150	3
216-960	200	3
Above 960	500	3

**NOTE:**

1. The lower limit shall apply at the transition frequencies.
2. Emission level (dBuV/m) = 20 log Emission level (uV/m).
3. For frequencies above 1000MHz, the field strength limits are based on average detector, however, the peak field strength of any emission shall not exceed the maximum permitted average limits, specified above by more than 20dB under any condition of modulation.



A D T

#### 4.2.2 TEST INSTRUMENTS

DESCRIPTION & MANUFACTURER	MODEL NO.	SERIAL NO.	CALIBRATED DATE	CALIBRATED UNTIL
Spectrum Analyzer Agilent	E4446A	MY48250254	July 09, 2012	July 08, 2013
Pre-Selector Agilent	N9039A	MY46520311	July 09, 2012	July 08, 2013
Signal Generator Agilent	N5181A	MY49060517	July 09, 2012	July 08, 2013
Pre-Amplifier Mini-Circuits	ZFL-1000VH2 B	AMP-ZFL-03	Nov. 15, 2011	Nov. 14, 2012
Pre-Amplifier Agilent	8449B	3008A02578	June 26, 2012	June 25, 2013
Pre-Amplifier SPACEK LABS	SLKKa-48-6	9K16	Nov. 15, 2011	Nov. 14, 2012
Trilog Broadband Antenna SCHWARZBECK	VULB 9168	9168-360	Apr. 09, 2012	Apr. 08, 2013
Horn_Antenna AISI	AIH.8018	0000320091110	Nov. 14, 2011	Nov. 13, 2012
Horn_Antenna SCHWARZBECK	BBHA 9170	9170-424	Oct. 07, 2011	Oct. 06, 2012
RF Cable	NA	RF104-201 RF104-203 RF104-204	Dec. 26, 2011	Dec. 25, 2012
RF Cable	NA	CHGCAB_001	Oct. 07, 2011	Oct. 06, 2012
Software	ADT_Radiated _V8.7.05	NA	NA	NA
Antenna Tower & Turn Table CT	NA	NA	NA	NA

**Note:**

1. The calibration interval of the above test instruments is 12 months and the calibrations are traceable to NML/ROC and NIST/USA.
2. The horn antenna, preamplifier (model: 8449B) are used only for the measurement of emission frequency above 1GHz if tested.
3. The test was performed in 966 Chamber No. G.
4. The FCC Site Registration No. is 966073.
5. The VCCI Site Registration No. is G-137.
6. The CANADA Site Registration No. is IC 7450H-2.
7. Tested Date: July 26 to Aug. 03, 2012

#### 4.2.3 TEST PROCEDURES

- a. The EUT was placed on the top of a rotating table 0.8 meters above the ground at a 3 meters chamber. The table was rotated 360 degrees to determine the position of the highest radiation.
- b. The EUT was set 3 meters away from the interference-receiving antenna, which was mounted on the top of a variable-height antenna tower.
- c. The height of antenna is varied from one meter to four meters above the ground to determine the maximum value of the field strength. Both horizontal and vertical polarizations of the antenna are set to make the measurement.
- d. For each suspected emission, the EUT was arranged to its worst case and then the antenna was tuned to heights from 1 meter to 4 meters and the rotatable table was turned from 0 degrees to 360 degrees to find the maximum reading.
- e. The test-receiver system was set to quasi-peak detect function and specified bandwidth with maximum hold mode when the test frequency is below 1 GHz.
- f. The test-receiver system was set to peak and average detect function and specified bandwidth with maximum hold mode when the test frequency is above 1 GHz. If the peak reading value also meets average limit, measurement with the average detector is unnecessary.

#### NOTE:

1. The resolution bandwidth and video bandwidth of test receiver/spectrum analyzer is 120kHz for Quasi-peak detection (QP) at frequency below 1GHz.
2. The resolution bandwidth of test receiver/spectrum analyzer is 1 MHz and the video bandwidth is 3 MHz for Peak detection (PK) at frequency above 1GHz.
3. The resolution bandwidth of test receiver/spectrum analyzer is 1 MHz and the video bandwidth is 10 Hz for Average detection (AV) at frequency above 1GHz.
4. All modes of operation were investigated and the worst-case emissions are reported.

#### 4.2.4 DEVIATION FROM TEST STANDARD

No deviation

#### 4.2.5 TEST SETUP

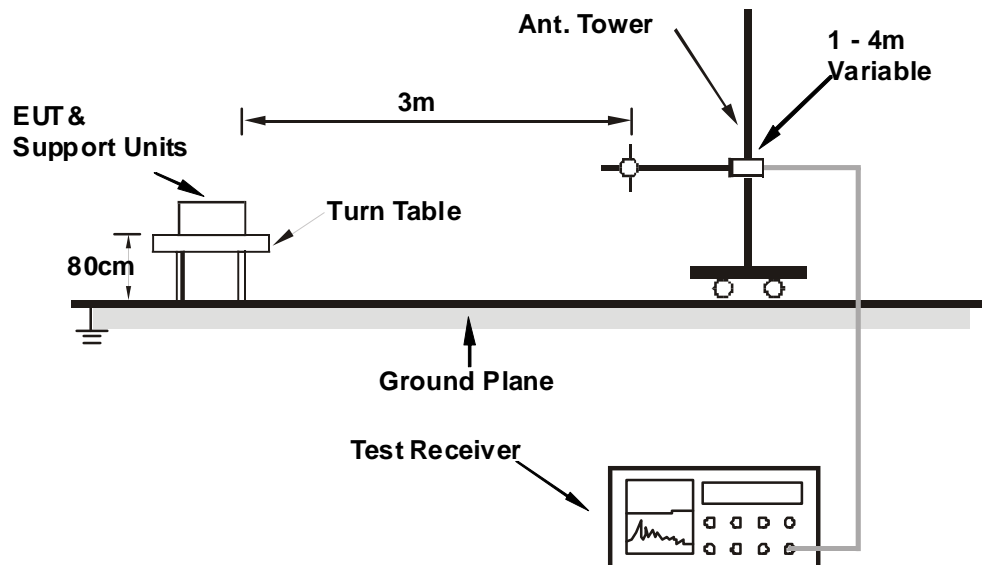

For the actual test configuration, please refer to the related item – Photographs of the Test Configuration.

#### 4.2.6 EUT OPERATING CONDITIONS

Same as 4.1.6

## 4.2.7 TEST RESULTS

### BELOW 1GHz WORST-CASE DATA

#### 802.11n (HT20)

<b>CHANNEL</b>	TX Channel 1	<b>DETECTOR FUNCTION</b>	Quasi-Peak (QP)
<b>FREQUENCY RANGE</b>	Below 1GHz		

ANTENNA POLARITY & TEST DISTANCE: HORIZONTAL AT 3 M								
NO	FREQ. (MHz)	EMISSION LEVEL (dBuV/m)	LIMIT (dBuV/m)	MARGIN (dB)	ANTENNA HEIGHT (m)	TABLE ANGLE (Degree)	RAW VALUE (dBuV)	CORRECTION FACTOR (dB/m)
1	217.11	39.4 QP	46.0	-6.6	1.00 H	75	27.50	11.91
2	233.33	39.9 QP	46.0	-6.1	1.50 H	227	27.30	12.62
3	250.03	34.7 QP	46.0	-11.3	1.00 H	74	21.35	13.35
4	374.97	34.4 QP	46.0	-11.6	1.00 H	35	17.14	17.22
5	700.04	41.3 QP	46.0	-4.7	2.00 H	314	17.33	23.97
6	874.95	39.4 QP	46.0	-6.6	1.50 H	75	12.31	27.12
ANTENNA POLARITY & TEST DISTANCE: VERTICAL AT 3 M								
NO	FREQ. (MHz)	EMISSION LEVEL (dBuV/m)	LIMIT (dBuV/m)	MARGIN (dB)	ANTENNA HEIGHT (m)	TABLE ANGLE (Degree)	RAW VALUE (dBuV)	CORRECTION FACTOR (dB/m)
1	176.25	38.6 QP	43.5	-4.9	1.00 V	312	25.30	13.29
2	221.25	38.6 QP	46.0	-7.4	1.00 V	301	26.48	12.09
3	374.97	31.9 QP	46.0	-14.1	1.00 V	354	14.66	17.22
4	500.02	33.9 QP	46.0	-12.1	1.00 V	360	13.49	20.39
5	700.04	37.6 QP	46.0	-8.4	1.50 V	360	13.60	23.97
6	933.33	34.3 QP	46.0	-11.7	1.00 V	253	6.51	27.80

#### REMARKS:

1. Emission level (dBuV/m) = Raw Value (dBuV) + Correction Factor (dB/m).
2. Correction Factor (dB/m) = Antenna Factor (dB/m) + Cable Factor (dB).
3. The other emission levels were very low against the limit.
4. Margin value = Emission level – Limit value.



## ABOVE 1GHz DATA

### 802.11b

<b>CHANNEL</b>	TX Channel 1	<b>DETECTOR FUNCTION</b>	Peak (PK)
<b>FREQUENCY RANGE</b>	1GHz ~ 25GHz		Average (AV)

#### ANTENNA POLARITY & TEST DISTANCE: HORIZONTAL AT 3 M

NO	FREQ. (MHz)	EMISSION LEVEL (dBuV/m)	LIMIT (dBuV/m)	MARGIN (dB)	ANTENNA HEIGHT (m)	TABLE ANGLE (Degree)	RAW VALUE (dBuV)	CORRECTIO N FACTOR (dB/m)
1	2390.00	59.2 PK	74.0	-14.8	1.48 H	93	27.22	31.98
2	2390.00	47.1 AV	54.0	-6.9	1.48 H	93	15.12	31.98
3	*2412.00	96.5 PK			1.48 H	93	64.45	32.05
4	*2412.00	93.9 AV			1.48 H	93	61.85	32.05
5	4824.00	52.8 PK	74.0	-21.2	1.34 H	335	13.22	39.58
6	4824.00	49.9 AV	54.0	-4.1	1.34 H	335	10.32	39.58

#### ANTENNA POLARITY & TEST DISTANCE: VERTICAL AT 3 M

NO	FREQ. (MHz)	EMISSION LEVEL (dBuV/m)	LIMIT (dBuV/m)	MARGIN (dB)	ANTENNA HEIGHT (m)	TABLE ANGLE (Degree)	RAW VALUE (dBuV)	CORRECTIO N FACTOR (dB/m)
1	2390.00	59.8 PK	74.0	-14.2	1.05 V	82	27.82	31.98
2	2390.00	48.7 AV	54.0	-5.3	1.05 V	82	16.72	31.98
3	*2412.00	107.5 PK			1.05 V	82	75.45	32.05
4	*2412.00	104.7 AV			1.05 V	82	72.65	32.05
5	4824.00	55.4 PK	74.0	-18.6	1.32 V	274	15.82	39.58
6	4824.00	53.0 AV	54.0	-1.0	1.32 V	274	13.42	39.58

#### REMARKS:

1. Emission level (dBuV/m) = Raw Value (dBuV) + Correction Factor (dB/m).
2. Correction Factor (dB/m) = Antenna Factor (dB/m) + Cable Factor (dB).
3. The other emission levels were very low against the limit.
4. Margin value = Emission level – Limit value.
5. " \* " : Fundamental frequency.



A D T

<b>CHANNEL</b>	TX Channel 6	<b>DETECTOR FUNCTION</b>	Peak (PK)
<b>FREQUENCY RANGE</b>	1GHz ~ 25GHz		Average (AV)

**ANTENNA POLARITY & TEST DISTANCE: HORIZONTAL AT 3 M**

NO	FREQ. (MHz)	EMISSION LEVEL (dBuV/m)	LIMIT (dBuV/m)	MARGIN (dB)	ANTENNA HEIGHT (m)	TABLE ANGLE (Degree)	RAW VALUE (dBuV)	CORRECTION FACTOR (dB/m)
1	*2437.00	96.6 PK			1.44 H	58	64.48	32.12
2	*2437.00	93.4 AV			1.44 H	58	61.28	32.12
3	4874.00	55.6 PK	74.0	-18.4	1.08 H	346	15.90	39.70
4	4874.00	52.7 AV	54.0	-1.3	1.08 H	346	13.00	39.70
5	7311.00	54.2 PK	74.0	-19.8	1.03 H	56	6.61	47.59
6	7311.00	45.8 AV	54.0	-8.2	1.03 H	56	-1.79	47.59

**ANTENNA POLARITY & TEST DISTANCE: VERTICAL AT 3 M**

NO	FREQ. (MHz)	EMISSION LEVEL (dBuV/m)	LIMIT (dBuV/m)	MARGIN (dB)	ANTENNA HEIGHT (m)	TABLE ANGLE (Degree)	RAW VALUE (dBuV)	CORRECTION FACTOR (dB/m)
1	*2437.00	107.7 PK			1.04 V	79	75.58	32.12
2	*2437.00	104.6 AV			1.04 V	79	72.48	32.12
3	4874.00	55.9 PK	74.0	-18.1	1.17 V	278	16.20	39.70
4	4874.00	53.2 AV	54.0	-0.8	1.17 V	278	13.50	39.70
5	7311.00	54.6 PK	74.0	-19.4	1.00 V	53	7.01	47.59
6	7311.00	46.2 AV	54.0	-7.8	1.00 V	53	-1.39	47.59

**REMARKS:**

1. Emission level (dBuV/m) = Raw Value (dBuV) + Correction Factor (dB/m).
2. Correction Factor (dB/m) = Antenna Factor (dB/m) + Cable Factor (dB).
3. The other emission levels were very low against the limit.
4. Margin value = Emission level – Limit value.
5. " \* ": Fundamental frequency.



A D T

<b>CHANNEL</b>	TX Channel 11	<b>DETECTOR FUNCTION</b>	Peak (PK)
<b>FREQUENCY RANGE</b>	1GHz ~ 25GHz		Average (AV)

**ANTENNA POLARITY & TEST DISTANCE: HORIZONTAL AT 3 M**

NO	FREQ. (MHz)	EMISSION LEVEL (dBuV/m)	LIMIT (dBuV/m)	MARGIN (dB)	ANTENNA HEIGHT (m)	TABLE ANGLE (Degree)	RAW VALUE (dBuV)	CORRECTION FACTOR (dB/m)
1	*2462.00	96.7 PK			1.42 H	63	64.52	32.18
2	*2462.00	93.1 AV			1.42 H	63	60.92	32.18
3	2483.50	58.3 PK	74.0	-15.7	1.42 H	62	26.06	32.24
4	2483.50	47.2 AV	54.0	-6.8	1.42 H	62	14.96	32.24
5	4924.00	55.5 PK	74.0	-18.5	1.08 H	338	15.66	39.84
6	4924.00	53.1 AV	54.0	-0.9	1.08 H	338	13.26	39.84
7	7386.00	55.0 PK	74.0	-19.0	1.00 H	57	7.48	47.52
8	7386.00	46.4 AV	54.0	-7.6	1.00 H	57	-1.12	47.52

**ANTENNA POLARITY & TEST DISTANCE: VERTICAL AT 3 M**

NO	FREQ. (MHz)	EMISSION LEVEL (dBuV/m)	LIMIT (dBuV/m)	MARGIN (dB)	ANTENNA HEIGHT (m)	TABLE ANGLE (Degree)	RAW VALUE (dBuV)	CORRECTION FACTOR (dB/m)
1	*2462.00	107.2 PK			1.05 V	73	75.02	32.18
2	*2462.00	104.3 AV			1.05 V	73	72.12	32.18
3	2483.50	58.6 PK	74.0	-15.4	1.05 V	73	26.36	32.24
4	2483.50	47.8 AV	54.0	-6.2	1.05 V	73	15.56	32.24
5	4924.00	53.6 PK	74.0	-20.4	1.26 V	274	13.76	39.84
6	4924.00	49.7 AV	54.0	-4.3	1.26 V	274	9.86	39.84
7	7386.00	55.3 PK	74.0	-18.7	1.04 V	46	7.78	47.52
8	7386.00	46.6 AV	54.0	-7.4	1.04 V	46	-0.92	47.52

**REMARKS:**

1. Emission level (dBuV/m) = Raw Value (dBuV) + Correction Factor (dB/m).
2. Correction Factor (dB/m) = Antenna Factor (dB/m) + Cable Factor (dB).
3. The other emission levels were very low against the limit.
4. Margin value = Emission level – Limit value.
5. " \* ": Fundamental frequency.





A D T

802.11g

<b>CHANNEL</b>	TX Channel 1	<b>DETECTOR FUNCTION</b>	Peak (PK)
<b>FREQUENCY RANGE</b>	1GHz ~ 25GHz		Average (AV)

**ANTENNA POLARITY & TEST DISTANCE: HORIZONTAL AT 3 M**

NO	FREQ. (MHz)	EMISSION LEVEL (dBuV/m)	LIMIT (dBuV/m)	MARGIN (dB)	ANTENNA HEIGHT (m)	TABLE ANGLE (Degree)	RAW VALUE (dBuV)	CORRECTION FACTOR (dB/m)
1	2359.70	59.1 PK	74.0	-14.9	1.43 H	59	27.24	31.86
2	2359.70	47.2 AV	54.0	-6.8	1.43 H	59	15.34	31.86
3	*2412.00	104.6 PK			1.43 H	59	72.55	32.05
4	*2412.00	94.4 AV			1.43 H	59	62.35	32.05
5	4824.00	50.3 PK	74.0	-23.7	1.04 H	277	10.72	39.58
6	4824.00	38.4 AV	54.0	-15.6	1.04 H	277	-1.18	39.58

**ANTENNA POLARITY & TEST DISTANCE: VERTICAL AT 3 M**

NO	FREQ. (MHz)	EMISSION LEVEL (dBuV/m)	LIMIT (dBuV/m)	MARGIN (dB)	ANTENNA HEIGHT (m)	TABLE ANGLE (Degree)	RAW VALUE (dBuV)	CORRECTION FACTOR (dB/m)
1	2359.70	70.6 PK	74.0	-3.4	1.02 V	277	38.74	31.86
2	2359.70	50.7 AV	54.0	-3.3	1.02 V	277	18.84	31.86
3	*2412.00	114.6 PK			1.02 V	277	82.55	32.05
4	*2412.00	105.5 AV			1.02 V	277	73.45	32.05
5	4824.00	51.2 PK	74.0	-22.8	1.24 V	263	11.62	39.58
6	4824.00	40.3 AV	54.0	-13.7	1.24 V	263	0.72	39.58

**REMARKS:**

1. Emission level (dBuV/m) = Raw Value (dBuV) + Correction Factor (dB/m).
2. Correction Factor (dB/m) = Antenna Factor (dB/m) + Cable Factor (dB).
3. The other emission levels were very low against the limit.
4. Margin value = Emission level – Limit value.
5. " \* ": Fundamental frequency.



A D T

<b>CHANNEL</b>	TX Channel 6	<b>DETECTOR FUNCTION</b>	Peak (PK)
<b>FREQUENCY RANGE</b>	1GHz ~ 25GHz		Average (AV)

**ANTENNA POLARITY & TEST DISTANCE: HORIZONTAL AT 3 M**

NO	FREQ. (MHz)	EMISSION LEVEL (dBuV/m)	LIMIT (dBuV/m)	MARGIN (dB)	ANTENNA HEIGHT (m)	TABLE ANGLE (Degree)	RAW VALUE (dBuV)	CORRECTION FACTOR (dB/m)
1	2384.70	58.6 PK	74.0	-15.4	1.44 H	63	26.64	31.96
2	2384.70	47.2 AV	54.0	-6.8	1.44 H	63	15.24	31.96
3	*2437.00	108.9 PK			1.44 H	63	76.78	32.12
4	*2437.00	98.3 AV			1.44 H	63	66.18	32.12
5	2489.40	59.4 PK	74.0	-14.6	1.44 H	63	27.15	32.25
6	2489.40	48.6 AV	54.0	-5.4	1.44 H	63	16.35	32.25
7	4874.00	50.6 PK	74.0	-23.4	1.06 H	269	10.90	39.70
8	4874.00	38.7 AV	54.0	-15.3	1.06 H	269	-1.00	39.70
9	7311.00	50.6 PK	74.0	-23.4	1.00 H	62	3.01	47.59
10	7311.00	40.4 AV	54.0	-13.6	1.00 H	62	-7.19	47.59

**ANTENNA POLARITY & TEST DISTANCE: VERTICAL AT 3 M**

NO	FREQ. (MHz)	EMISSION LEVEL (dBuV/m)	LIMIT (dBuV/m)	MARGIN (dB)	ANTENNA HEIGHT (m)	TABLE ANGLE (Degree)	RAW VALUE (dBuV)	CORRECTION FACTOR (dB/m)
1	2384.70	65.2 PK	74.0	-8.8	1.02 V	276	33.24	31.96
2	2384.70	53.4 AV	54.0	-0.6	1.02 V	276	21.44	31.96
3	*2437.00	117.8 PK			1.02 V	276	85.68	32.12
4	*2437.00	109.0 AV			1.02 V	276	76.88	32.12
5	2489.40	61.1 PK	74.0	-12.9	1.02 V	276	28.85	32.25
6	2489.40	51.9 AV	54.0	-2.1	1.02 V	276	19.65	32.25
7	4874.00	53.6 PK	74.0	-20.4	1.26 V	259	13.90	39.70
8	4874.00	42.6 AV	54.0	-11.4	1.26 V	259	2.90	39.70
9	7311.00	50.4 PK	74.0	-23.6	1.06 V	52	2.81	47.59
10	7311.00	40.3 AV	54.0	-13.7	1.06 V	52	-7.29	47.59

**REMARKS:**

1. Emission level (dBuV/m) = Raw Value (dBuV) + Correction Factor (dB/m).
2. Correction Factor (dB/m) = Antenna Factor (dB/m) + Cable Factor (dB).
3. The other emission levels were very low against the limit.
4. Margin value = Emission level – Limit value.
5. " \* ": Fundamental frequency.



A D T

<b>CHANNEL</b>	TX Channel 11	<b>DETECTOR FUNCTION</b>	Peak (PK)
<b>FREQUENCY RANGE</b>	1GHz ~ 25GHz		Average (AV)

**ANTENNA POLARITY & TEST DISTANCE: HORIZONTAL AT 3 M**

NO	FREQ. (MHz)	EMISSION LEVEL (dBuV/m)	LIMIT (dBuV/m)	MARGIN (dB)	ANTENNA HEIGHT (m)	TABLE ANGLE (Degree)	RAW VALUE (dBuV)	CORRECTION FACTOR (dB/m)
1	2378.90	58.4 PK	74.0	-15.6	1.49 H	62	26.46	31.94
2	2378.90	48.6 AV	54.0	-5.4	1.49 H	62	16.66	31.94
3	*2462.00	105.4 PK			1.49 H	62	73.22	32.18
4	*2462.00	95.2 AV			1.49 H	62	63.02	32.18
5	2483.50	59.6 PK	74.0	-14.4	1.49 H	62	27.36	32.24
6	2483.50	48.3 AV	54.0	-5.7	1.49 H	62	16.06	32.24
7	4924.00	50.2 PK	74.0	-23.8	1.04 H	253	10.36	39.84
8	4924.00	38.4 AV	54.0	-15.6	1.04 H	253	-1.44	39.84
9	7386.00	50.4 PK	74.0	-23.6	1.00 H	59	2.88	47.52
10	7386.00	40.2 AV	54.0	-13.8	1.00 H	59	-7.32	47.52

**ANTENNA POLARITY & TEST DISTANCE: VERTICAL AT 3 M**

NO	FREQ. (MHz)	EMISSION LEVEL (dBuV/m)	LIMIT (dBuV/m)	MARGIN (dB)	ANTENNA HEIGHT (m)	TABLE ANGLE (Degree)	RAW VALUE (dBuV)	CORRECTION FACTOR (dB/m)
1	2378.90	62.1 PK	74.0	-11.9	1.00 V	265	30.16	31.94
2	2378.90	51.0 AV	54.0	-3.0	1.00 V	265	19.06	31.94
3	*2462.00	115.1 PK			1.00 V	265	82.92	32.18
4	*2462.00	106.0 AV			1.00 V	265	73.82	32.18
5	2483.50	72.9 PK	74.0	-1.1	1.00 V	265	40.66	32.24
6	2483.50	52.3 AV	54.0	-1.7	1.00 V	265	20.06	32.24
7	4924.00	53.3 PK	74.0	-20.7	1.21 V	243	13.46	39.84
8	4924.00	42.4 AV	54.0	-11.6	1.21 V	243	2.56	39.84
9	7386.00	50.7 PK	74.0	-23.3	1.03 V	62	3.18	47.52
10	7386.00	40.6 AV	54.0	-13.4	1.03 V	62	-6.92	47.52

**REMARKS:**

1. Emission level (dBuV/m) = Raw Value (dBuV) + Correction Factor (dB/m).
2. Correction Factor (dB/m) = Antenna Factor (dB/m) + Cable Factor (dB).
3. The other emission levels were very low against the limit.
4. Margin value = Emission level – Limit value.
5. " \* ": Fundamental frequency.



A D T

### 802.11n (HT20)

<b>CHANNEL</b>	TX Channel 1	<b>DETECTOR FUNCTION</b>	Peak (PK)
<b>FREQUENCY RANGE</b>	1GHz ~ 25GHz		Average (AV)

ANTENNA POLARITY & TEST DISTANCE: HORIZONTAL AT 3 M								
NO	FREQ. (MHz)	EMISSION LEVEL (dBuV/m)	LIMIT (dBuV/m)	MARGIN (dB)	ANTENNA HEIGHT (m)	TABLE ANGLE (Degree)	RAW VALUE (dBuV)	CORRECTIO N FACTOR (dB/m)
1	2390.00	57.4 PK	74.0	-16.6	1.24 H	244	25.42	31.98
2	2390.00	49.3 AV	54.0	-4.7	1.24 H	244	17.32	31.98
3	*2412.00	105.2 PK			1.24 H	244	73.15	32.05
4	*2412.00	95.6 AV			1.24 H	244	63.55	32.05
5	4824.00	50.3 PK	74.0	-23.7	1.02 H	241	10.72	39.58
6	4824.00	38.2 AV	54.0	-15.8	1.02 H	241	-1.38	39.58
ANTENNA POLARITY & TEST DISTANCE: VERTICAL AT 3 M								
NO	FREQ. (MHz)	EMISSION LEVEL (dBuV/m)	LIMIT (dBuV/m)	MARGIN (dB)	ANTENNA HEIGHT (m)	TABLE ANGLE (Degree)	RAW VALUE (dBuV)	CORRECTIO N FACTOR (dB/m)
1	2390.00	69.6 PK	74.0	-4.4	1.07 V	274	37.62	31.98
2	2390.00	53.5 AV	54.0	-0.5	1.07 V	274	21.52	31.98
3	*2412.00	117.2 PK			1.04 V	263	85.15	32.05
4	*2412.00	107.0 AV			1.04 V	263	74.95	32.05
5	4824.00	53.4 PK	74.0	-20.6	1.24 V	251	13.82	39.58
6	4824.00	42.3 AV	54.0	-11.7	1.24 V	251	2.72	39.58

#### REMARKS:

1. Emission level (dBuV/m) = Raw Value (dBuV) + Correction Factor (dB/m).
2. Correction Factor (dB/m) = Antenna Factor (dB/m) + Cable Factor (dB).
3. The other emission levels were very low against the limit.
4. Margin value = Emission level – Limit value.
5. " \* ": Fundamental frequency.



A D T

<b>CHANNEL</b>	TX Channel 6	<b>DETECTOR FUNCTION</b>	Peak (PK)
<b>FREQUENCY RANGE</b>	1GHz ~ 25GHz		Average (AV)

**ANTENNA POLARITY & TEST DISTANCE: HORIZONTAL AT 3 M**

NO	FREQ. (MHz)	EMISSION LEVEL (dBuV/m)	LIMIT (dBuV/m)	MARGIN (dB)	ANTENNA HEIGHT (m)	TABLE ANGLE (Degree)	RAW VALUE (dBuV)	CORRECTION FACTOR (dB/m)
1	2385.10	57.3 PK	74.0	-16.7	1.24 H	251	25.34	31.96
2	2385.10	48.6 AV	54.0	-5.4	1.24 H	251	16.64	31.96
3	*2437.00	108.4 PK			1.24 H	251	76.28	32.12
4	*2437.00	98.2 AV			1.24 H	251	66.08	32.12
5	2488.70	58.6 PK	74.0	-15.4	1.24 H	251	26.35	32.25
6	2488.70	49.3 AV	54.0	-4.7	1.24 H	251	17.05	32.25
7	4874.00	50.4 PK	74.0	-23.6	1.03 H	241	10.70	39.70
8	4874.00	38.1 AV	54.0	-15.9	1.03 H	241	-1.60	39.70
9	7311.00	50.2 PK	74.0	-23.8	1.00 H	38	2.61	47.59
10	7311.00	40.2 AV	54.0	-13.8	1.00 H	38	-7.39	47.59

**ANTENNA POLARITY & TEST DISTANCE: VERTICAL AT 3 M**

NO	FREQ. (MHz)	EMISSION LEVEL (dBuV/m)	LIMIT (dBuV/m)	MARGIN (dB)	ANTENNA HEIGHT (m)	TABLE ANGLE (Degree)	RAW VALUE (dBuV)	CORRECTION FACTOR (dB/m)
1	2385.10	62.8 PK	74.0	-11.2	1.23 V	286	30.84	31.96
2	2385.10	53.1 AV	54.0	-0.9	1.23 V	286	21.14	31.96
3	*2437.00	119.4 PK			1.06 V	276	87.28	32.12
4	*2437.00	110.3 AV			1.06 V	276	78.18	32.12
5	2488.70	59.7 PK	74.0	-14.3	1.23 V	286	27.45	32.25
6	2488.70	49.1 AV	54.0	-4.9	1.23 V	286	16.85	32.25
7	4874.00	53.6 PK	74.0	-20.4	1.26 V	249	13.90	39.70
8	4874.00	42.1 AV	54.0	-11.9	1.26 V	249	2.40	39.70
9	7311.00	50.6 PK	74.0	-23.4	1.00 V	55	3.01	47.59
10	7311.00	40.7 AV	54.0	-13.3	1.00 V	55	-6.89	47.59

**REMARKS:**

1. Emission level (dBuV/m) = Raw Value (dBuV) + Correction Factor (dB/m).
2. Correction Factor (dB/m) = Antenna Factor (dB/m) + Cable Factor (dB).
3. The other emission levels were very low against the limit.
4. Margin value = Emission level – Limit value.
5. " \* ": Fundamental frequency.



A D T

<b>CHANNEL</b>	TX Channel 11	<b>DETECTOR FUNCTION</b>	Peak (PK)
<b>FREQUENCY RANGE</b>	1GHz ~ 25GHz		Average (AV)

**ANTENNA POLARITY & TEST DISTANCE: HORIZONTAL AT 3 M**

NO	FREQ. (MHz)	EMISSION LEVEL (dBuV/m)	LIMIT (dBuV/m)	MARGIN (dB)	ANTENNA HEIGHT (m)	TABLE ANGLE (Degree)	RAW VALUE (dBuV)	CORRECTION FACTOR (dB/m)
1	2379.50	56.6 PK	74.0	-17.4	1.26 H	245	24.66	31.94
2	2379.50	47.3 AV	54.0	-6.7	1.26 H	245	15.36	31.94
3	*2462.00	104.0 PK			1.26 H	245	71.82	32.18
4	*2462.00	94.8 AV			1.26 H	245	62.62	32.18
5	2483.50	57.1 PK	74.0	-16.9	1.26 H	245	24.86	32.24
6	2483.50	48.3 AV	54.0	-5.7	1.26 H	245	16.06	32.24
7	4924.00	50.1 PK	74.0	-23.9	1.03 H	244	10.26	39.84
8	4924.00	38.3 AV	54.0	-15.7	1.03 H	244	-1.54	39.84
9	7386.00	50.7 PK	74.0	-23.3	1.00 H	42	3.18	47.52
10	7386.00	40.6 AV	54.0	-13.4	1.00 H	42	-6.92	47.52

**ANTENNA POLARITY & TEST DISTANCE: VERTICAL AT 3 M**

NO	FREQ. (MHz)	EMISSION LEVEL (dBuV/m)	LIMIT (dBuV/m)	MARGIN (dB)	ANTENNA HEIGHT (m)	TABLE ANGLE (Degree)	RAW VALUE (dBuV)	CORRECTION FACTOR (dB/m)
1	2379.50	60.5 PK	74.0	-13.5	1.05 V	264	28.56	31.94
2	2379.50	50.7 AV	54.0	-3.3	1.05 V	264	18.76	31.94
3	*2462.00	115.2 PK			1.05 V	264	83.02	32.18
4	*2462.00	106.7 AV			1.05 V	264	74.52	32.18
5	2483.50	73.4 PK	74.0	-0.6	1.05 V	264	41.16	32.24
6	2483.50	50.2 AV	54.0	-3.8	1.05 V	264	17.96	32.24
7	4924.00	53.7 PK	74.0	-20.3	1.21 V	255	13.86	39.84
8	4924.00	42.6 AV	54.0	-11.4	1.21 V	255	2.76	39.84
9	7386.00	50.4 PK	74.0	-23.6	1.00 V	0	2.88	47.52
10	7386.00	40.2 AV	54.0	-13.8	1.00 V	0	-7.32	47.52

**REMARKS:**

1. Emission level (dBuV/m) = Raw Value (dBuV) + Correction Factor (dB/m).
2. Correction Factor (dB/m) = Antenna Factor (dB/m) + Cable Factor (dB).
3. The other emission levels were very low against the limit.
4. Margin value = Emission level – Limit value.
5. " \* ": Fundamental frequency.



A D T

802.11n (HT40)

<b>CHANNEL</b>	TX Channel 3	<b>DETECTOR FUNCTION</b>	Peak (PK)
<b>FREQUENCY RANGE</b>	1GHz ~ 25GHz		Average (AV)

**ANTENNA POLARITY & TEST DISTANCE: HORIZONTAL AT 3 M**

NO	FREQ. (MHz)	EMISSION LEVEL (dBuV/m)	LIMIT (dBuV/m)	MARGIN (dB)	ANTENNA HEIGHT (m)	TABLE ANGLE (Degree)	RAW VALUE (dBuV)	CORRECTION FACTOR (dB/m)
1	2390.00	58.3 PK	74.0	-15.7	1.21 H	243	26.32	31.98
2	2390.00	47.6 AV	54.0	-6.4	1.21 H	243	15.62	31.98
3	*2422.00	97.3 PK			1.21 H	243	65.22	32.08
4	*2422.00	87.8 AV			1.21 H	243	55.72	32.08
5	4844.00	48.4 PK	74.0	-25.6	1.04 H	249	8.77	39.63
6	4844.00	36.7 AV	54.0	-17.3	1.04 H	249	-2.93	39.63
7	7266.00	50.3 PK	74.0	-23.7	1.00 H	59	2.70	47.60
8	7266.00	40.3 AV	54.0	-13.7	1.00 H	59	-7.30	47.60

**ANTENNA POLARITY & TEST DISTANCE: VERTICAL AT 3 M**

NO	FREQ. (MHz)	EMISSION LEVEL (dBuV/m)	LIMIT (dBuV/m)	MARGIN (dB)	ANTENNA HEIGHT (m)	TABLE ANGLE (Degree)	RAW VALUE (dBuV)	CORRECTION FACTOR (dB/m)
1	2390.00	69.0 PK	74.0	-5.0	1.07 V	276	37.02	31.98
2	2390.00	53.4 AV	54.0	-0.6	1.07 V	276	21.42	31.98
3	*2422.00	108.7 PK			1.07 V	276	76.62	32.08
4	*2422.00	99.0 AV			1.07 V	276	66.92	32.08
5	4844.00	52.6 PK	74.0	-21.4	1.26 V	249	12.97	39.63
6	4844.00	40.3 AV	54.0	-13.7	1.26 V	249	0.67	39.63
7	7266.00	50.7 PK	74.0	-23.3	1.00 V	56	3.10	47.60
8	7266.00	40.6 AV	54.0	-13.4	1.00 V	56	-7.00	47.60

**REMARKS:**

1. Emission level (dBuV/m) = Raw Value (dBuV) + Correction Factor (dB/m).
2. Correction Factor (dB/m) = Antenna Factor (dB/m) + Cable Factor (dB).
3. The other emission levels were very low against the limit.
4. Margin value = Emission level – Limit value.
5. " \* ": Fundamental frequency.



A D T

<b>CHANNEL</b>	TX Channel 6	<b>DETECTOR FUNCTION</b>	Peak (PK)
<b>FREQUENCY RANGE</b>	1GHz ~ 25GHz		Average (AV)

**ANTENNA POLARITY & TEST DISTANCE: HORIZONTAL AT 3 M**

NO	FREQ. (MHz)	EMISSION LEVEL (dBuV/m)	LIMIT (dBuV/m)	MARGIN (dB)	ANTENNA HEIGHT (m)	TABLE ANGLE (Degree)	RAW VALUE (dBuV)	CORRECTION FACTOR (dB/m)
1	2329.30	56.3 PK	74.0	-17.7	1.24 H	259	24.56	31.74
2	2329.30	48.4 AV	54.0	-5.6	1.24 H	259	16.66	31.74
3	*2437.00	102.2 PK			1.24 H	259	70.08	32.12
4	*2437.00	95.3 AV			1.24 H	259	63.18	32.12
5	2483.50	56.1 PK	74.0	-17.9	1.24 H	259	23.86	32.24
6	2483.50	47.3 AV	54.0	-6.7	1.24 H	259	15.06	32.24
7	4874.00	50.6 PK	74.0	-23.4	1.03 H	244	10.90	39.70
8	4874.00	38.4 AV	54.0	-15.6	1.03 H	244	-1.30	39.70
9	7311.00	50.9 PK	74.0	-23.1	1.00 H	63	3.31	47.59
10	7311.00	40.7 AV	54.0	-13.3	1.00 H	63	-6.89	47.59

**ANTENNA POLARITY & TEST DISTANCE: VERTICAL AT 3 M**

NO	FREQ. (MHz)	EMISSION LEVEL (dBuV/m)	LIMIT (dBuV/m)	MARGIN (dB)	ANTENNA HEIGHT (m)	TABLE ANGLE (Degree)	RAW VALUE (dBuV)	CORRECTION FACTOR (dB/m)
1	2329.30	72.3 PK	74.0	-1.7	1.06 V	259	40.56	31.74
2	2329.30	51.0 AV	54.0	-3.0	1.06 V	259	19.26	31.74
3	*2437.00	114.2 PK			1.06 V	259	82.08	32.12
4	*2437.00	106.4 AV			1.06 V	259	74.28	32.12
5	2483.50	71.6 PK	74.0	-2.4	1.06 V	259	39.36	32.24
6	2483.50	50.4 AV	54.0	-3.6	1.06 V	259	18.16	32.24
7	4874.00	56.4 PK	74.0	-17.6	1.27 V	253	16.70	39.70
8	4874.00	43.6 AV	54.0	-10.4	1.27 V	253	3.90	39.70
9	7311.00	50.9 PK	74.0	-23.1	1.00 V	73	3.31	47.59
10	7311.00	40.9 AV	54.0	-13.1	1.00 V	73	-6.69	47.59

**REMARKS:**

1. Emission level (dBuV/m) = Raw Value (dBuV) + Correction Factor (dB/m).
2. Correction Factor (dB/m) = Antenna Factor (dB/m) + Cable Factor (dB).
3. The other emission levels were very low against the limit.
4. Margin value = Emission level – Limit value.
5. " \* ": Fundamental frequency.





A D T

<b>CHANNEL</b>	TX Channel 9	<b>DETECTOR FUNCTION</b>	Peak (PK)
<b>FREQUENCY RANGE</b>	1GHz ~ 25GHz		Average (AV)

**ANTENNA POLARITY & TEST DISTANCE: HORIZONTAL AT 3 M**

NO	FREQ. (MHz)	EMISSION LEVEL (dBuV/m)	LIMIT (dBuV/m)	MARGIN (dB)	ANTENNA HEIGHT (m)	TABLE ANGLE (Degree)	RAW VALUE (dBuV)	CORRECTION FACTOR (dB/m)
1	2348.40	56.4 PK	74.0	-17.6	1.21 H	249	24.58	31.82
2	2348.40	47.1 AV	54.0	-6.9	1.21 H	249	15.28	31.82
3	*2452.00	102.3 PK			1.21 H	249	70.14	32.16
4	*2452.00	92.6 AV			1.21 H	249	60.44	32.16
5	2483.50	56.9 PK	74.0	-17.1	1.21 H	249	24.66	32.24
6	2483.50	48.3 AV	54.0	-5.7	1.21 H	249	16.06	32.24
7	4904.00	47.3 PK	74.0	-26.7	1.02 H	251	7.53	39.77
8	4904.00	36.4 AV	54.0	-17.6	1.02 H	251	-3.37	39.77
9	7356.00	50.7 PK	74.0	-23.3	1.00 H	62	3.15	47.55
10	7356.00	40.6 AV	54.0	-13.4	1.00 H	62	-6.95	47.55

**ANTENNA POLARITY & TEST DISTANCE: VERTICAL AT 3 M**

NO	FREQ. (MHz)	EMISSION LEVEL (dBuV/m)	LIMIT (dBuV/m)	MARGIN (dB)	ANTENNA HEIGHT (m)	TABLE ANGLE (Degree)	RAW VALUE (dBuV)	CORRECTION FACTOR (dB/m)
1	2348.40	60.8 PK	74.0	-13.2	1.07 V	276	28.98	31.82
2	2348.40	50.1 AV	54.0	-3.9	1.07 V	276	18.28	31.82
3	*2452.00	113.0 PK			1.06 V	264	80.84	32.16
4	*2452.00	103.9 AV			1.06 V	264	71.74	32.16
5	2483.50	71.5 PK	74.0	-2.5	1.07 V	276	39.26	32.24
6	2483.50	52.5 AV	54.0	-1.5	1.07 V	276	20.26	32.24
7	4904.00	53.4 PK	74.0	-20.6	1.26 V	244	13.63	39.77
8	4904.00	41.3 AV	54.0	-12.7	1.26 V	244	1.53	39.77
9	7356.00	51.5 PK	74.0	-22.5	1.00 V	69	3.95	47.55
10	7356.00	40.4 AV	54.0	-13.6	1.00 V	69	-7.15	47.55

**REMARKS:**

1. Emission level (dBuV/m) = Raw Value (dBuV) + Correction Factor (dB/m).
2. Correction Factor (dB/m) = Antenna Factor (dB/m) + Cable Factor (dB).
3. The other emission levels were very low against the limit.
4. Margin value = Emission level – Limit value.
5. " \* ": Fundamental frequency.

### 4.3 6dB BANDWIDTH MEASUREMENT

#### 4.3.1 LIMITS OF 6dB BANDWIDTH MEASUREMENT

The minimum of 6dB Bandwidth Measurement is 0.5 MHz.

#### 4.3.2 TEST INSTRUMENTS

DESCRIPTION & MANUFACTURER	MODEL NO.	SERIAL NO.	CALIBRATED DATE	CALIBRATED UNTIL
R&S SPECTRUM ANALYZER	FSP40	100036	Dec. 14, 2011	Dec. 13, 2012

**Note:**

1. The calibration interval of the above test instruments is 12 months and the calibrations are traceable to NML/ROC and NIST/USA.
2. Tested date : July 26, 2012

#### 4.3.3 TEST PROCEDURE

1. Set resolution bandwidth (RBW) = approximately 1% of the emission bandwidth
2. Set the video bandwidth (VBW)  $\geq 3 \times$  RBW, Detector = Peak.
3. Trace mode = max hold.
4. Sweep = auto couple.
5. Measure the maximum width of the emission that is constrained by the frequencies associated with the two amplitude points (upper and lower) that are attenuated by 6 dB relative to the maximum level measured in the fundamental emission

#### 4.3.4 DEVIATION FROM TEST STANDARD

No deviation

#### 4.3.5 TEST SETUP

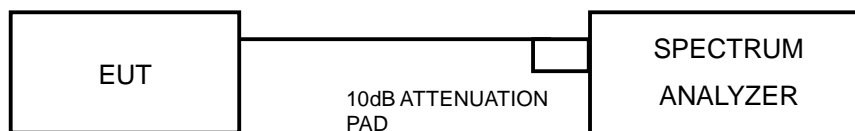

#### 4.3.6 EUT OPERATING CONDITIONS

The software provided by client to enable the EUT under transmission condition continuously at lowest, middle and highest channel frequencies individually.



A D T

### 4.3.7 TEST RESULTS

#### 802.11b

CHANNEL	CHANNEL FREQUENCY (MHz)	6dB BANDWIDTH (MHz)	MINIMUM LIMIT (MHz)	PASS / FAIL
1	2412	11.36	0.5	PASS
6	2437	11.35	0.5	PASS
11	2462	11.38	0.5	PASS

#### 802.11g

CHANNEL	CHANNEL FREQUENCY (MHz)	6dB BANDWIDTH (MHz)	MINIMUM LIMIT (MHz)	PASS / FAIL
1	2412	15.82	0.5	PASS
6	2437	15.86	0.5	PASS
11	2462	15.30	0.5	PASS

#### 802.11n (HT20)

CHANNEL	FREQUENCY (MHz)	6dB BANDWIDTH (MHz)		MINIMUM LIMIT (MHz)	PASS / FAIL
		CHAIN 0	CHAIN 1		
1	2412	16.14	16.14	0.5	PASS
6	2437	16.16	16.08	0.5	PASS
11	2462	16.13	16.13	0.5	PASS

#### 802.11n (HT40)

CHANNEL	FREQUENCY (MHz)	6dB BANDWIDTH (MHz)		MINIMUM LIMIT (MHz)	PASS / FAIL
		CHAIN 0	CHAIN 1		
3	2422	33.09	32.96	0.5	PASS
6	2437	33.12	33.16	0.5	PASS
9	2452	33.10	33.08	0.5	PASS

#### 4.4 CONDUCTED OUTPUT POWER MEASUREMENT

##### 4.4.1 LIMITS OF MAXIMUM PEAK OUTPUT POWER MEASUREMENT

For systems using digital modulation in the 2400–2483.5 MHz band: 1 Watt (30dBm)

##### 4.4.2 INSTRUMENTS

DESCRIPTION & MANUFACTURER	MODEL NO.	SERIAL NO.	CALIBRATED DATE	CALIBRATED UNTIL
R&S Spectrum Analyzer	FSP40	100036	Dec. 14, 2011	Dec. 13, 2012

- Note:**
1. The calibration interval of the above test instruments is 12 months and the calibrations are traceable to NML/ROC and NIST/USA.
  2. Tested date : July 26, 2012

##### 4.4.3 TEST PROCEDURES

Follow FCC KDB 558074 DTS test procedure:  
Measurement Procedure AVG2

- 1) Set the analyzer span to 5-30% greater than the EBW.
- 2) Set RBW =1MHz.
- 3) Set the VBW  $\geq 3 \times$  RBW.
- 4) Number of measurement points in the sweep  $\geq 2 \times$  (span/RBW).
- 5) Sweep time = auto couple.
- 6) Detector = power averaging (RMS) or sample.
- 7) Employ trace averaging in power averaging (RMS) mode over a minimum of 100 traces.
- 8) Use the spectrum analyzer's integrated band power measurement function with band limits set equal to the EBW band edges.

##### 4.4.4 DEVIATION FROM TEST STANDARD

No deviation

##### 4.4.5 TEST SETUP

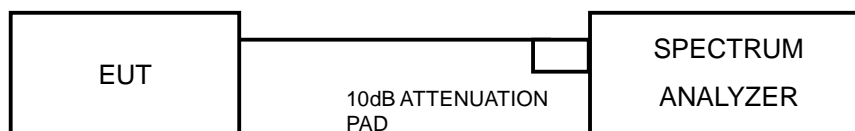

#### 4.4.6 EUT OPERATING CONDITIONS

Same as Item 4.3.6

#### 4.4.7 TEST RESULTS

##### 802.11b

CHANNEL	FREQUENCY (MHz)	AVERAGE POWER (mW)	AVERAGE POWER (dBm)	AVERAGE POWER LIMIT (dBm)	PASS/ FAIL
1	2412	164.437	22.16	30	PASS
6	2437	158.125	21.99	30	PASS
11	2462	99.083	19.96	30	PASS

##### 802.11g

CHANNEL	FREQUENCY (MHz)	AVERAGE POWER (mW)	AVERAGE POWER (dBm)	AVERAGE POWER LIMIT (dBm)	PASS/ FAIL
1	2412	111.944	20.49	30	PASS
6	2437	154.525	21.89	30	PASS
11	2462	138.676	21.42	30	PASS

##### 802.11n (HT20)

CHAN.	FREQUENCY (MHz)	AVERAGE POWER (dBm)		TOTAL POWER (mW)	TOTAL POWER (dBm)	LIMIT (dBm)	PASS / FAIL
		CHAIN 0	CHAIN 1				
1	2412	21.56	20.91	266.529	24.26	30	PASS
6	2437	20.71	22.79	307.869	24.88	30	PASS
11	2462	21.01	20.13	229.222	23.60	30	PASS

##### 802.11n (HT40)

CHAN.	FREQUENCY (MHz)	AVERAGE POWER (dBm)		TOTAL POWER (mW)	TOTAL POWER (dBm)	LIMIT (dBm)	PASS / FAIL
		CHAIN 0	CHAIN 1				
3	2422	15.11	14.46	60.359	17.81	30	PASS
6	2437	21.83	21.59	296.617	24.72	30	PASS
9	2452	18.00	17.77	122.937	20.90	30	PASS

## 4.5 POWER SPECTRAL DENSITY MEASUREMENT

### 4.5.1 LIMITS OF POWER SPECTRAL DENSITY MEASUREMENT

The Maximum of Power Spectral Density Measurement is 8dBm.

### 4.5.2 TEST INSTRUMENTS

DESCRIPTION & MANUFACTURER	MODEL NO.	SERIAL NO.	CALIBRATED DATE	CALIBRATED UNTIL
R&S Spectrum Analyzer	FSP40	100036	Dec. 14, 2011	Dec. 13, 2012

**Note:**

1. The calibration interval of the above test instruments is 12 months and the calibrations are traceable to NML/ROC and NIST/USA.
2. Tested date : July 26, 2012

### 4.5.3 TEST PROCEDURE

1. Set the RBW = 100 kHz, VBW =300 kHz, Detector = Power Average (RMS).
2. Number of measurement points in the sweep  $\geq 2 \times \text{span/RBW}$
3. Manually set the sweep time to  $\geq 10 \times (\text{number of measurement points in sweep}) \times (\text{transmission symbol period})$ .
4. Perform the measurement over a single sweep.
5. Use the peak marker function to determine the maximum power level in any 100 kHz band segment within the fundamental EBW.
6. Scale the observed power level to an equivalent value in 3 kHz by adjusting (reducing) the measured power by a bandwidth correction factor (BWCF) where  $\text{BWCF} = 10\log(3 \text{ kHz}/100\text{kHz})$

### 4.5.4 DEVIATION FROM TEST STANDARD

No deviation

### 4.5.5 TEST SETUP

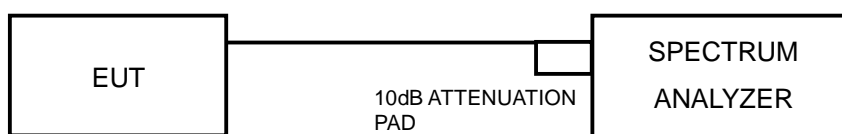



A D T

#### 4.5.6 EUT OPERATING CONDITION

Same as Item 4.3.6





A D T

### 4.5.7 TEST RESULTS

#### 802.11b

Channel	FREQUENCY (MHz)	PSD (dBm/100kHz)	PSD (dBm/3kHz)	Limit (dBm/3kHz)	PASS /FAIL
1	2412	4.53	-10.70	8	PASS
6	2437	4.34	-10.89	8	PASS
11	2462	2.33	-12.90	8	PASS

#### 802.11g

Channel	FREQUENCY (MHz)	PSD (dBm/100kHz)	PSD (dBm/3kHz)	Limit (dBm/3kHz)	PASS /FAIL
1	2412	1.16	-14.07	8	PASS
6	2437	2.55	-12.68	8	PASS
11	2462	2.28	-12.95	8	PASS

#### 802.11n (HT20)

TX chain	Channel	FREQ. (MHz)	PSD (dBm/100kHz)	PSD (dBm/3kHz)	10 log (N=2) dB	Total PSD (dBm/3kHz)	Limit (dBm/3kHz)	PASS /FAIL
0	1	2412	2.19	-13.04	3.01	-10.03	8	PASS
	6	2437	1.35	-13.88	3.01	-10.87	8	PASS
	11	2462	1.59	-13.64	3.01	-10.63	8	PASS
1	1	2412	1.50	-13.73	3.01	-10.72	8	PASS
	6	2437	3.42	-11.81	3.01	-8.80	8	PASS
	11	2462	0.71	-14.52	3.01	-11.51	8	PASS



A D T

### 802.11n (HT40)

TX chain	Channel	FREQ. (MHz)	PSD (dBm/100kHz)	PSD (dBm/3kHz)	10 log (N=2) dB	Total PSD (dBm/3kHz)	Limit (dBm/3kHz)	PASS /FAIL
0	3	2422	-7.33	-22.56	3.01	-19.55	8	PASS
	6	2437	-0.69	-15.92	3.01	-12.91	8	PASS
	9	2452	-4.44	-19.67	3.01	-16.66	8	PASS
1	3	2422	-7.96	-23.19	3.01	-20.18	8	PASS
	6	2437	-0.76	-15.99	3.01	-12.98	8	PASS
	9	2452	-4.66	-19.89	3.01	-16.88	8	PASS



A D T

## 4.6 CONDUCTED OUT-BAND EMISSION MEASUREMENT

### 4.6.1 LIMITS OF CONDUCTED OUT-BAND EMISSION MEASUREMENT

Below 30dB of the highest emission level of operating band (in 100kHz Resolution Bandwidth).

### 4.6.2 TEST INSTRUMENTS

DESCRIPTION & MANUFACTURER	MODEL NO.	SERIAL NO.	CALIBRATED DATE	CALIBRATED UNTIL
R&S Spectrum Analyzer	FSP40	100036	Dec. 14, 2011	Dec. 13, 2012

**Note:**

1. The calibration interval of the above test instruments is 12 months and the calibrations are traceable to NML/ROC and NIST/USA.
2. Tested date : July 26, 2012

### 4.6.3 TEST PROCEDURE

#### MEASUREMENT PROCEDURE REF

1. Set the RBW = 100 kHz.
2. Set the VBW  $\geq$  300 kHz.
3. Detector = power average (RMS).
4. Manually set the sweep time to  $\geq 10 \times$  (number of measurement points in sweep)  $\times$  (transmission symbol period).
5. Perform the measurement over a single sweep.
6. Use the peak marker function to determine the maximum power level in any 100 kHz band segment within the fundamental EBW.

### MEASUREMENT PROCEDURE OOB

1. Set RBW = 100 kHz.
2. Set VBW  $\geq$  300 kHz.
3. Set span to encompass the spectrum to be examined
4. Detector = power average (RMS).
5. Manually set the sweep time to  $\geq 10 \times$  (number of measurement points in sweep)  $\times$  (transmission symbol period).
6. Perform the measurement over a single sweep.
7. Use the peak marker function to determine the maximum power level in any 100 kHz band segment within the fundamental EBW.

#### 4.6.4 DEVIATION FROM TEST STANDARD

No deviation

#### 4.6.5 TEST SETUP

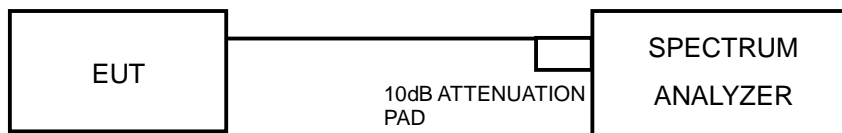

#### 4.6.6 EUT OPERATING CONDITION

Same as Item 4.3.6

#### 4.6.7 TEST RESULTS

The spectrum plots are attached on the following pages. D1 line indicates the highest level, and D2 line indicates the 30dB offset below D1. It shows compliance with the requirement.



A D T

### 802.11b

#### Maximum REF

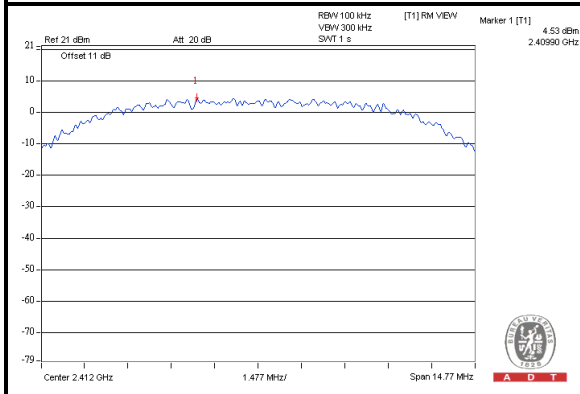

#### CH 1

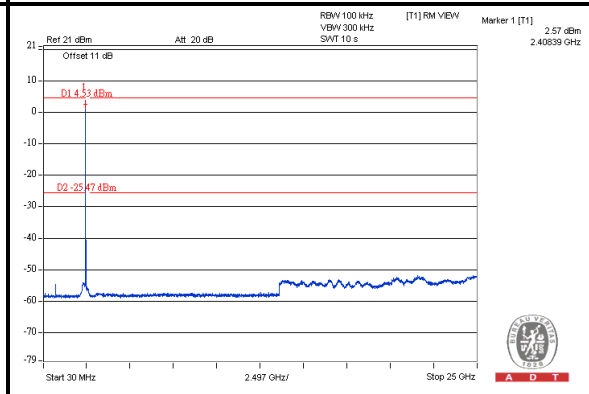

#### CH 6

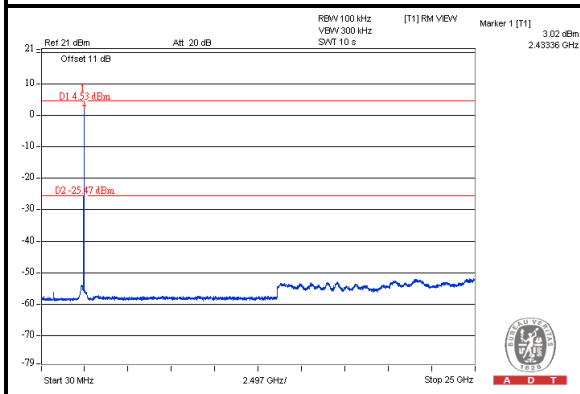

#### CH 11

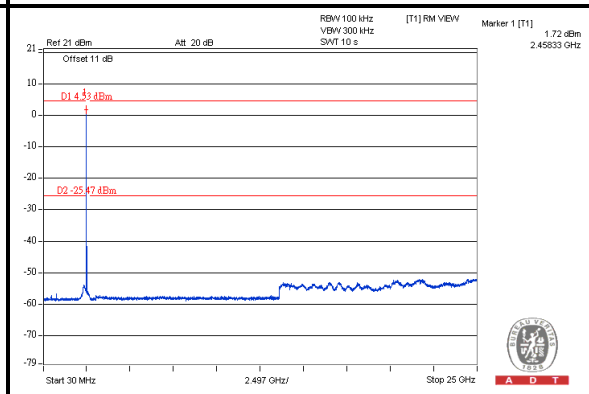



A D T

### 802.11g

#### Maximum REF

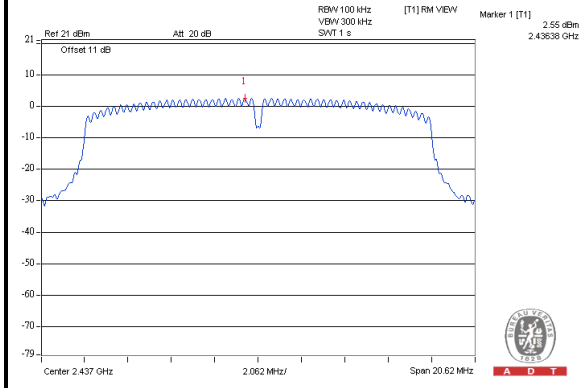

#### CH 1

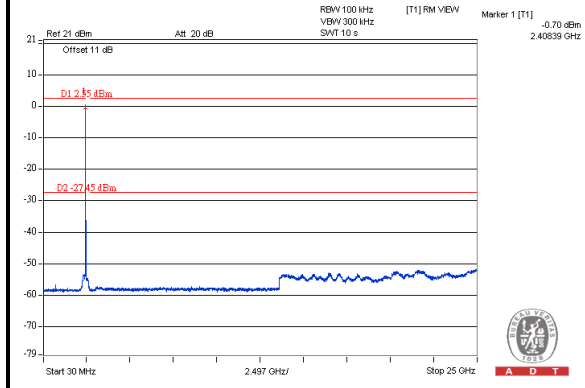

#### CH 6

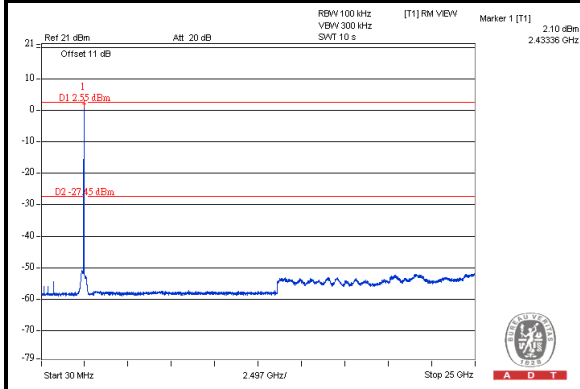

#### CH 11

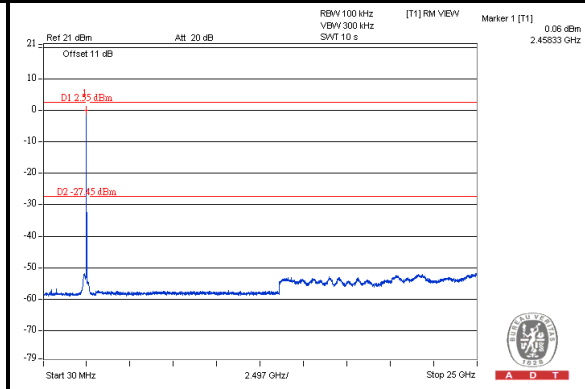



A D T

### 802.11n (HT20)

#### Maximum REF

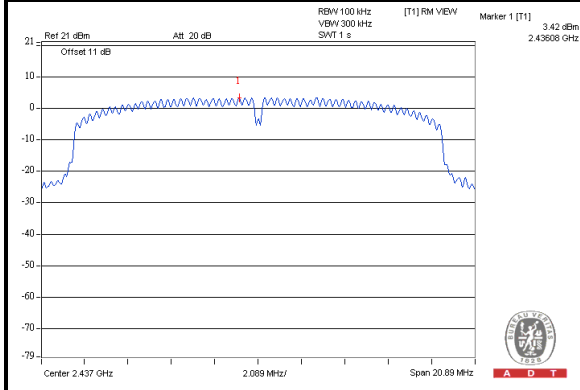

#### CH 1

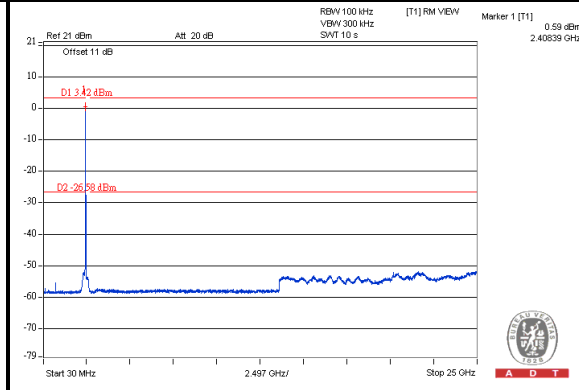

#### CH 6

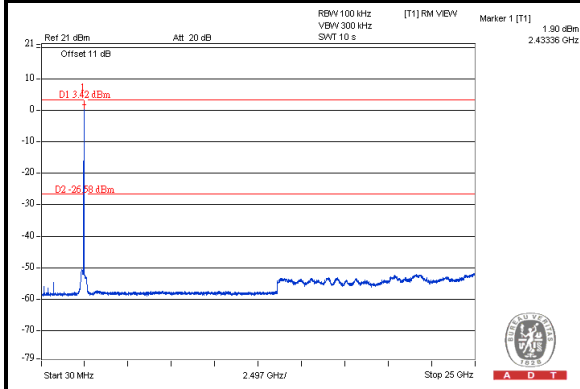

#### CH 11

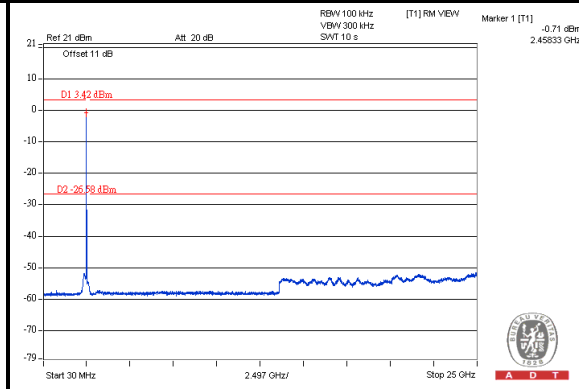



A D T

### 802.11n (HT40)

#### Maximum REF

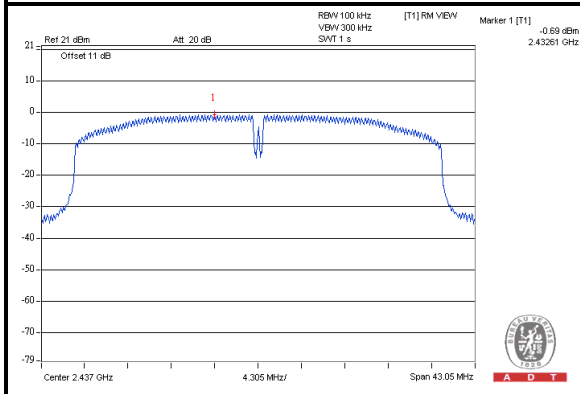

#### CH 3

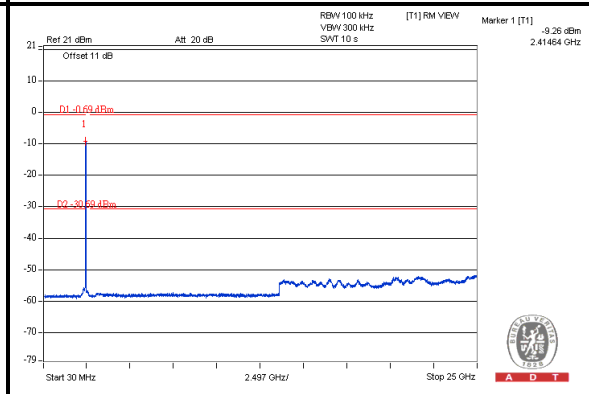

#### CH 6

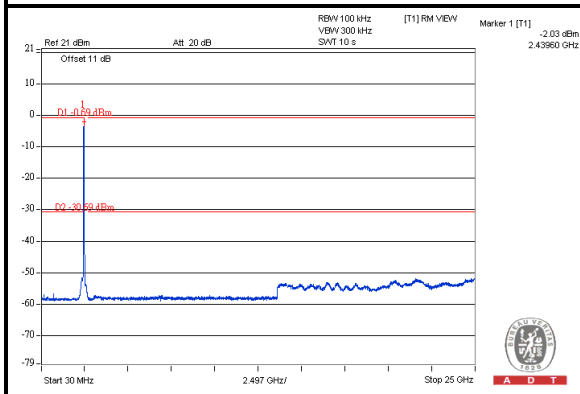

#### CH 9

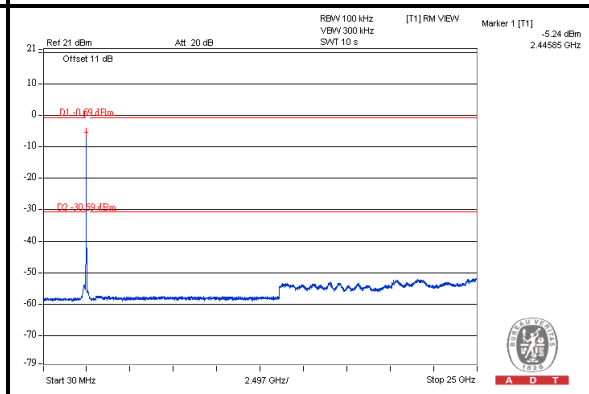





A D T

## 5. PHOTOGRAPHS OF THE TEST CONFIGURATION

Please refer to the attached file (Test Setup Photo).





## 6. INFORMATION ON THE TESTING LABORATORIES

We, Bureau Veritas Consumer Products Services (H.K.) Ltd., Taoyuan Branch, were founded in 1988 to provide our best service in EMC, Radio, Telecom and Safety consultation. Our laboratories are accredited and approved according to ISO/IEC 17025.

If you have any comments, please feel free to contact us at the following:

**Linko EMC/RF Lab:**

Tel: 886-2-26052180

Fax: 886-2-26052943

**Hsin Chu EMC/RF Lab:**

Tel: 886-3-5935343

Fax: 886-3-5935342

**Hwa Ya EMC/RF/Safety/Telecom Lab:**

Tel: 886-3-3183232

Fax: 886-3-3270892

**Email:** [service.adt@tw.bureauveritas.com](mailto:service.adt@tw.bureauveritas.com)

**Web Site:** [www.bureauveritas-adt.com](http://www.bureauveritas-adt.com)

The address and road map of all our labs can be found in our web site also.



A D T

## 7. APPENDIX A - MODIFICATIONS RECORDERS FOR ENGINEERING CHANGES TO THE EUT BY THE LAB

No modifications were made to the EUT by the lab during the test.

--- END ---