

FCC Radio Test Report

FCC ID:KA2IR615X1

This report concerns:Original Grant

Project No. : 1908H006
Equipment : Wireless N300 Router
Brand Name : D-Link
Test Model : DIR-615
Series Model : DIR-612
Applicant : D-Link Corporation
Address : 17595Mt. Hermann, Fountain Valley, California United States
92708
Date of Receipt : Jul. 15, 2019
Date of Test : Jul. 15, 2019~Aug. 24, 2019
Issued Date : Sep. 12, 2019
Report Version : R00
Test Sample : Engineering Sample No.:SH19081581
Standard(s) : FCC Part15, Subpart C (15.247)
ANSI C63.10-2013
KDB 558074 D01 15.247 Meas Guidance V05r02

The above equipment has been tested and found compliance with the requirement of the relativestandards by BTL Inc.

Krain. Wu

Prepared by : Krain Wu

young chai

Approved by : Young Chai



Certificate # 5123. 03

Add: No. 29, Jintang Road, Tangzhen Industry Park, Pudong New Area, Shanghai
201210,China

TEL: +86-021-61765666

Web: www.newbtl.com

Declaration

BTL represents to the client that testing is done in accordance with standard procedures as applicable and that test instruments used has been calibrated with standards traceable to international standard(s) and/or national standard(s).

BTL's reports apply only to the specific samples tested under conditions. It is manufacture's responsibility to ensure that additional production units of this model are manufactured with the identical electrical and mechanical components. **BTL** shall have no liability for any declarations, inferences or generalizations drawn by the client or others from **BTL** issued reports.

The report must not be used by the client to claim product certification, approval, or endorsement by NVLAP, NIST, A2LA, or any agency of the U.S. Government.

This report is the confidential property of the client. As a mutual protection to the clients, the public and ourselves, the test report shall not be reproduced, except in full, without our written approval.

BTL's laboratory quality assurance procedures are in compliance with the **ISO/IEC17025** requirements, and accredited by the conformity assessment authorities listed in this test report.

BTL is not responsible for the sampling stage, so the results only apply to the sample as received.

The information, data and test plan are provided by manufacturer which may affect the validity of results, so it is manufacturer's responsibility to ensure that the apparatus meets the essential requirements of applied standards and in all the possible configurations as representative of its intended use.

Limitation

For the use of the authority's logo is limited unless the Test Standard(s)/Scope(s)/Item(s) mentioned in this test report is (are) included in the conformity assessment authorities acceptance respective.

Please note that the measurement uncertainty is provided for informational purpose only and are not use in determining the Pass/Fail results.

Table of Contents	Page
REPORT ISSUED HISTORY	6
1 . SUMMARY OF TEST RESULTS	7
1.1 TEST FACILITY	8
1.2 MEASUREMENT UNCERTAINTY	8
1.3 TEST ENVIRONMENT CONDITIONS	8
2 . GENERAL INFORMATION	9
2.1 GENERAL DESCRIPTION OF EUT	9
2.2 DESCRIPTION OF TEST MODES	10
2.3 PARAMETERS OF TEST SOFTWARE	12
2.4 DUTY CYCLE	13
2.5 BLOCKDIAGRAMSHOWINGTHECONFIGURATIONOFSYSTEMTESTED	14
2.6 SUPPORT UNITS	14
3 .AC POWER LINE CONDUCTED EMISSIONS TEST	15
3.1 LIMIT	15
3.2 TEST PROCEDURE	15
3.3 DEVIATIONFROMTESTSTANDARD	15
3.4 TESTSETUP	16
3.5 EUT OPERATION CONDITIONS	16
3.6 TEST RESULTS	16
4 . RADIATED EMISSIONSTEST	17
4.1 LIMIT	17
4.2 TEST PROCEDURE	18
4.3 DEVIATIONFROMTESTSTANDARD	18
4.4 TESTSETUP	19
4.5 EUT OPERATIONCONDITIONS	20
4.6 TEST RESULTS - 9 KHZ TO 30MHZ	20
4.7 TEST RESULTS - 30 MHZTO 1000MHZ	20
4.8 TEST RESULTS- ABOVE 1000MHZ	20
5 .BANDWIDTH TEST	21
5.1 LIMIT	21
5.2 TEST PROCEDURE	21
5.3 DEVIATION FROM STANDARD	21

Table of Contents	Page
5.4 TEST SETUP	21
5.5 EUT OPERATION CONDITIONS	21
5.6 TESTRESULTS	21
6 .MAXIMUM OUTPUT POWER TEST	22
6.1 LIMIT	22
6.2 TEST PROCEDURE	22
6.3 DEVIATION FROM STANDARD	22
6.4 TEST SETUP	22
6.5 EUT OPERATION CONDITIONS	22
6.6 TESTRESULTS	22
7 .CONDUCTED SPURIOUS EMISSIONS	23
7.1 LIMIT	23
7.2 TEST PROCEDURE	23
7.3 DEVIATION FROM STANDARD	23
7.4 TEST SETUP	23
7.5 EUT OPERATION CONDITIONS	23
7.6 TESTRESULTS	23
8 .POWER SPECTRAL DENSITY TEST	24
8.1 LIMIT	24
8.2 TEST PROCEDURE	24
8.3 DEVIATION FROM STANDARD	24
8.4 TEST SETUP	24
8.5 EUT OPERATION CONDITIONS	24
8.6 TESTRESULTS	24
9 . MEASUREMENT INSTRUMENTS LIST	25
APPENDIX A - AC POWER LINE CONDUCTED EMISSIONS	27
APPENDIX B - RADIATED EMISSION - 9 KHZ TO 30 MHZ	30
APPENDIX C - RADIATED EMISSION - 30 MHZ TO 1000 MHZ	35
APPENDIXD -RADIATED EMISSION- ABOVE 1000MHZ	38
APPENDIXE - BANDWIDTH	87
APPENDIXF- MAXIMUMOUTPUT POWER	90
APPENDIXG - CONDUCTED SPURIOUS EMISSIONS	94

Table of Contents**Page****APPENDIXH - POWER SPECTRAL DENSITY****101**

REPORT ISSUED HISTORY

Report Version	Description	Issued Date
R00	Original Issue.	Sep. 12, 2019

1. SUMMARY OF TEST RESULTS

Test procedures according to the technical standard(s):

FCC Part15, Subpart C (15.247)				
Standard(s) Section	Test Item	Test Result	Judgment	Remark
15.207	AC Power Line Conducted Emissions	APPENDIX A	N/A	-----
15.247(d) 15.205(a) 15.209(a)	Radiated Emissions	APPENDIX B APPENDIX C APPENDIX D	PASS	-----
15.247(a)(2)	Bandwidth	APPENDIX E	PASS	-----
15.247(b)(3)	Maximum Output Power	APPENDIX F	PASS	-----
15.247(d)	Conducted Spurious Emissions	APPENDIX G	PASS	-----
15.247(e)	Power Spectral Density	APPENDIX H	PASS	-----
15.203	Antenna Requirement	-----	PASS	-----

Note:

(1) "N/A" denotes test is not applicable in this test report.

1.1 TEST FACILITY

The test facilities used to collect the test data in this report is at the location of No.29, Jintang Road, Tangzhen Industry Park, Pudong New Area, Shanghai 201210, China.

BTL's Test Firm Registration Number for FCC: 476765

BTL's Designation Number for FCC: CN1241

1.2 MEASUREMENT UNCERTAINTY

ISO/IEC 17025 requires that an estimate of the measurement uncertainties associated with the emissions test results be included in the report. The measurement uncertainties given below are based on a 95% confidence level (based on a coverage factor (k=2))

The BTL measurement uncertainty as below table:

A. Radiated emissions test:

Test Site	Method	Measurement Frequency Range	Ant. H / V	U, (dB)
SH-CB01	CISPR	9 KHz~30 MHz	V	3.79
		9 KHz~30 MHz	H	3.57
		30MHz~200MHz	V	4.04
		30MHz~200MHz	H	3.76
		200MHz~1,000MHz	V	4.24
		200MHz~1,000MHz	H	3.84
		1GHz~18GHz	V	4.46
		1GHz~18GHz	H	4.40
		18 GHz~40 GHz	V	3.95
		18 GHz~40 GHz	H	3.95

Note: Unless specifically mentioned, the uncertainty of measurement has not been taken into account to declare the compliance or non-compliance to the specification.

1.3 TEST ENVIRONMENT CONDITIONS

Test Item	Temperature	Humidity	Test Voltage	Tested By
AC Power Line Conducted Emissions	23°C	59%	AC 120V	Summer Xu
Radiated Emissions-9K-30MHz	24°C	57%	AC 120V	Summer Xu
Radiated Emissions-30 MHz to 1GHz	24°C	57%	AC 120V	Summer Xu
Radiated Emissions-Above 1000 MHz	24°C	57%	AC 120V	Summer Xu
Bandwidth	23°C	59%	AC 120V	Summer Xu
Maximum output power& e.i.r.p.	23°C	59%	AC 120V	Summer Xu
Conducted Spurious Emissions	23°C	59%	AC 120V	Summer Xu
Power Spectral Density	23°C	59%	AC 120V	Summer Xu

2. GENERAL INFORMATION

2.1 GENERAL DESCRIPTION OF EUT

Equipment	Wireless N300 Router
Brand Name	D-Link
Test Model	DIR-615
Series Model	DIR-612
Model Difference(s)	Only differs in model name.
Software Version	V3.0.2
Hardware Version	X1
Power Source	1# DC Voltage supplied from AC/DC adapter: Brand/Model: HEWEISHUN/BN049-A05009U
Power Rating	I/P: 100-240V ~ 50/60Hz 0.3A O/P: 9V---600mA
Operation Frequency	2412 MHz~ 2462 MHz
Modulation Type	IEEE 802.11b:DSSS IEEE 802.11g:OFDM IEEE 802.11n:OFDM
Bit Rate of Transmitter	IEEE 802.11b: 11/5.5/2/1 Mbps IEEE 802.11g: 54/48/36/24/18/12/9/6 Mbps IEEE 802.11n: up to 300 Mbps
Maximum Output Power Non-Beamforming	IEEE 802.11b: 22.31dBm (0.1702 W) IEEE 802.11g: 27.29dBm (0.5358 W) IEEE 802.11n (HT20):29.61dBm (0.9152 W) IEEE 802.11n (HT40):29.18dBm (0.8285 W)

Note:

- For a more detailed features description, please refer to the manufacturer's specifications or the user's manual.
- Channel List:

CH01 - CH11 for IEEE 802.11b, IEEE 802.11g, IEEE 802.11n (HT20) CH03 - CH09 for IEEE 802.11n (HT40)							
Channel	Frequency (MHz)	Channel	Frequency (MHz)	Channel	Frequency (MHz)	Channel	Frequency (MHz)
01	2412	04	2427	07	2442	10	2457
02	2417	05	2432	08	2447	11	2462
03	2422	06	2437	09	2452		

3. Antenna Specification:

Ant.	Brand	Model Name	Antenna Type	Connector	Gain (dBi)	Note
1	N/A	N/A	Dipole	N/A	5	N/A
2	N/A	N/A	Dipole	N/A	5	N/A

The EUT incorporates a MIMO function. Physically, the EUT provides two completed transmitters and receivers (2T2R), all transmit signals are completely uncorrelated, then, **Direction gain = G_{ANT}** , that is Directional gain=5.

4. Table for Antenna Configuration:

Operating Mode TX Mode	1TX	2TX
802.11b	V (Ant. 1)	-
802.11g	V (Ant. 1)	-
802.11n(20MHz)	-	V (Ant. 1 + Ant. 2)
802.11n(40MHz)	-	V (Ant. 1 + Ant. 2)

2.2 DESCRIPTION OF TEST MODES

The test system was pre-tested based on the consideration of all possible combinations of EUT operation mode.

Pretest Mode	Description
Mode 1	TX B Mode Channel 01/06/11
Mode 2	TX G Mode Channel 01/06/11
Mode 3	TX N-20 MHz Mode Channel 01/06/11
Mode 4	TX N-40 MHz Mode Channel 03/06/09
Mode 5	TX N20 MODE CHANNEL 06

Following mode(s) as (were) found to be the worst case(s) and selected for the final test.

AC power line conducted emissions test	
Final Test Mode:	Description
Mode 5	TX N20 MODE CHANNEL 06

Radiated emissions test - Below 1GHz	
Final Test Mode:	Description
Mode 5	TX N20 MODE CHANNEL 06

Radiated emissions test- Above 1GHz	
Final Test Mode:	Description
Mode 1	TX B Mode Channel 01/06/11
Mode 2	TX G Mode Channel 01/06/11
Mode 3	TX N-20 MHz Mode Channel 01/06/11
Mode 4	TX N-40 MHz Mode Channel 03/06/09

Conducted test	
Final Test Mode:	Description
Mode 1	TX B Mode Channel 01/06/11
Mode 2	TX G Mode Channel 01/06/11
Mode 3	TX N-20 MHz Mode Channel 01/06/11
Mode 4	TX N-40 MHz Mode Channel 03/06/09

NOTE:

- (1) The measurements are performed at the high, middle, low available channels.
- (2) 802.11b mode: CCK (1Mbps)
 802.11g mode: OFDM (6Mbps)
 802.11n HT20 mode : BPSK (6.5Mbps)
 802.11n HT40mode : BPSK (13.5Mbps)
 For radiated emission tests, the highest output powers were set for final test.
- (3) For radiated emission below 1GHz test, the IEEE 802.11n20is found to be the worst case and recorded.
- (4) For radiated emission above 1GHz test, 1GHz~26.5GHz have been pre-tested and in this report only recorded the worst case. The remaining spurious points are all below the limit value of 20dB.

2.3PARAMETERS OF TEST SOFTWARE**Non-Beamforming**

Test Software	MTOOL		
Frequency (MHz)	2412	2437	2462
IEEE 802.11b	41	41	41
IEEE 802.11g	40	52	41
IEEE 802.11n (HT20)	40	47	39
Frequency (MHz)	2422	2437	2452
IEEE 802.11n (HT40)	37	40	38

2.4 DUTY CYCLE

If duty cycle is $\geq 98\%$, duty factor is not required.
 If duty cycle is $< 98\%$, duty factor shall be considered.
 The output power = measured power + duty factor.

IEEE 802.11b

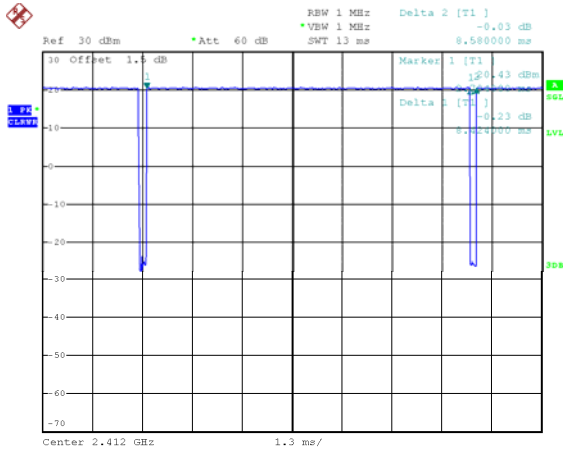

Date: 21.AUG.2019 10:46:07

Duty cycle = $8.424 \text{ ms} / 8.580 \text{ ms} = 98.18\%$
 Duty Factor = $10 \log(1/\text{Duty cycle}) = 0.00$

IEEE 802.11n (HT20)

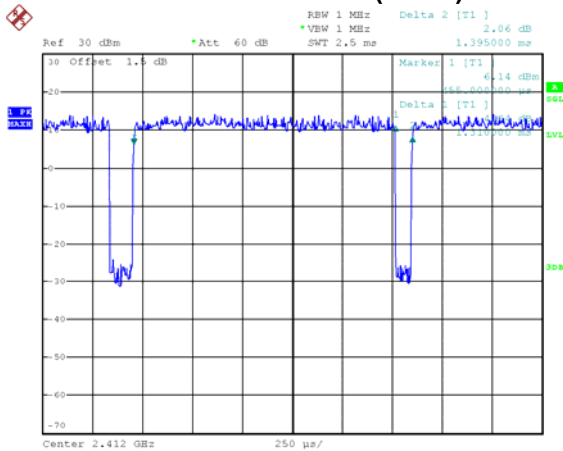

Date: 21.AUG.2019 10:54:23

Duty cycle = $1.310 \text{ ms} / 1.395 \text{ ms} = 93.91\%$
 Duty Factor = $10 \log(1/\text{Duty cycle}) = 0.27$,

IEEE 802.11g

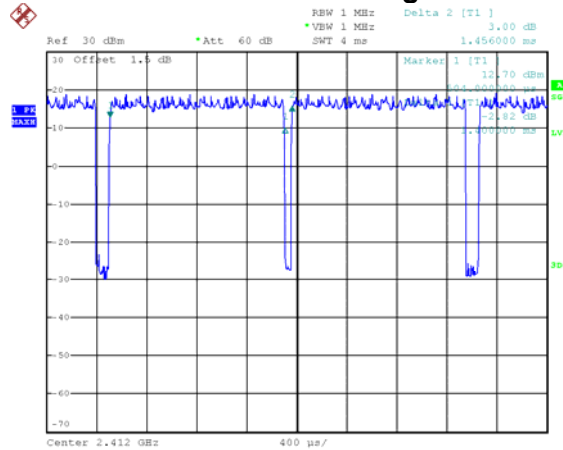

Date: 21.AUG.2019 10:50:54

Duty cycle = $1.400 \text{ ms} / 1.456 \text{ ms} = 96.15\%$
 Duty Factor = $10 \log(1/\text{Duty cycle}) = 0.17$

IEEE 802.11n (HT40)

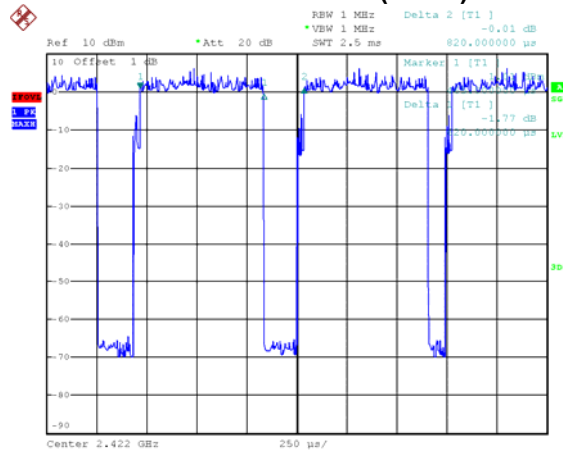

Date: 21.AUG.2019 11:07:18

Duty cycle = $0.620 \text{ ms} / 0.820 \text{ ms} = 75.61\%$
 Duty Factor = $10 \log(1/\text{Duty cycle}) = 1.21$

NOTE:

For IEEE 802.11g and IEEE 802.11n (HT20):
 For radiated emissions frequency above 1 GHz, the resolution bandwidth of test receiver/spectrum analyzer is 1 MHz and the video bandwidth is 1 kHz (Duty cycle $< 98\%$).

For IEEE 802.11n (HT40):
 For radiated emissions frequency above 1 GHz, the resolution bandwidth of test receiver/spectrum analyzer is 1 MHz and the video bandwidth is 2 kHz (Duty cycle $< 98\%$).

2.5 BLOCK DIAGRAM SHOWING THE CONFIGURATION OF SYSTEM TESTED

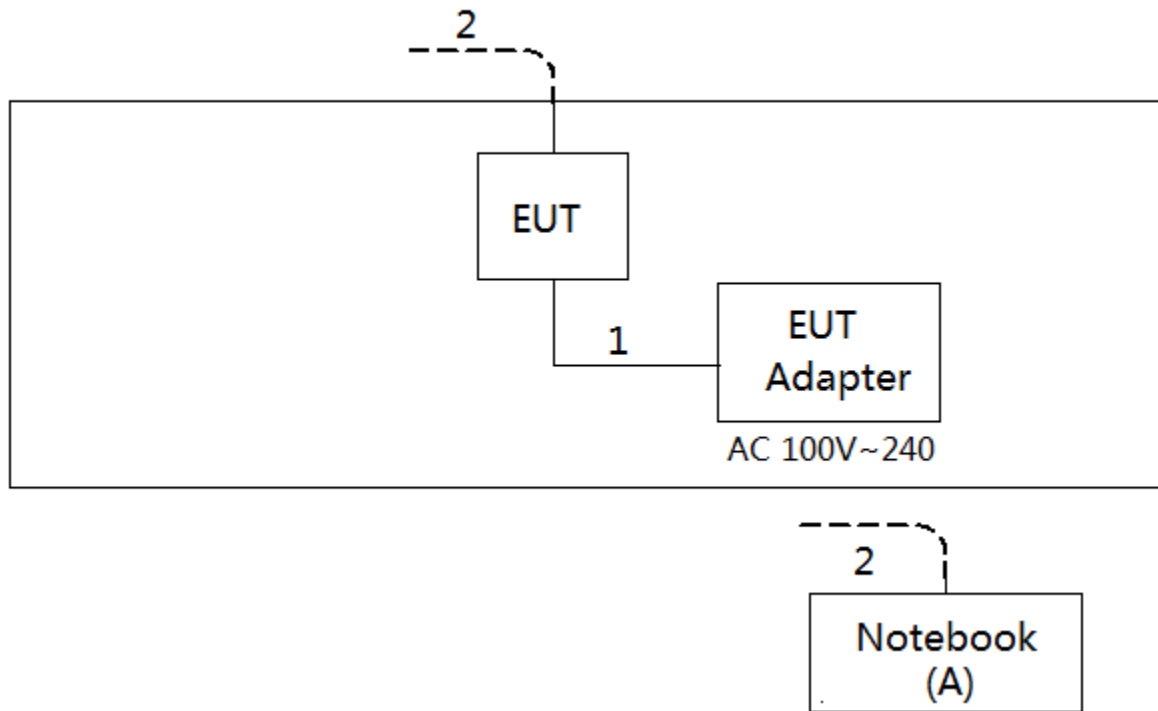

2.6 SUPPORT UNITS

Item	Equipment	Brand	Model/Type No.	Series No.
A	NOTEBOOK	Lenovo	INSPIRON 1420-	JX193A01SDC2

Item	Shielded Type	Ferrite Core	Length	Note
1	NA	NA	10M	
2	NA	NA	1.5M	

3.AC POWER LINE CONDUCTED EMISSIONS TEST

3.1LIMIT

Frequency of Emission (MHz)	Limit (dB μ V)	
	Quasi-peak	Average
0.15 -0.50	66to 56*	56 - 46*
0.50 -5.0	56	46
5.0 -30.0	60	50

NOTE:

- (1) The tighter limit applies at the band edges.
- (2) The limit of " * " marked band means the limitation decreases linearly with the logarithm of the frequency in the range.

The following table is the setting of the receiver

Receiver Parameters	Setting
Attenuation	10 dB
Start Frequency	0.15 MHz
Stop Frequency	30 MHz
IF Bandwidth	9 kHz

3.2TEST PROCEDURE

- a. The EUT was placed 0.8 meters from the horizontal ground plane with EUT being connected to the power mains through a line impedance stabilization network (LISN). All other support equipment powered from additional LISN(s). The LISN provide 50 Ohm/ 50uH of coupling impedance for the measuring instrument.
- b. Interconnecting cables that hang closer than 40 cm to the groundplane shall be folded back and forth in the center forming a bundle 30 to 40 cm long.
- c. I/O cables that are not connected to a peripheral shall be bundled in the center. The end of the cable may be terminated, if required, using the correct terminating impedance. The overall length shall not exceed 1 m.
- d. LISN at least 80 cm from nearest part of EUT chassis.
- e. For the actual test configuration, please refer to the related Item -EUT Test Photos.

3.3DEVIATIONFROMTESTSTANDARD

No deviation

3.4 TEST SETUP

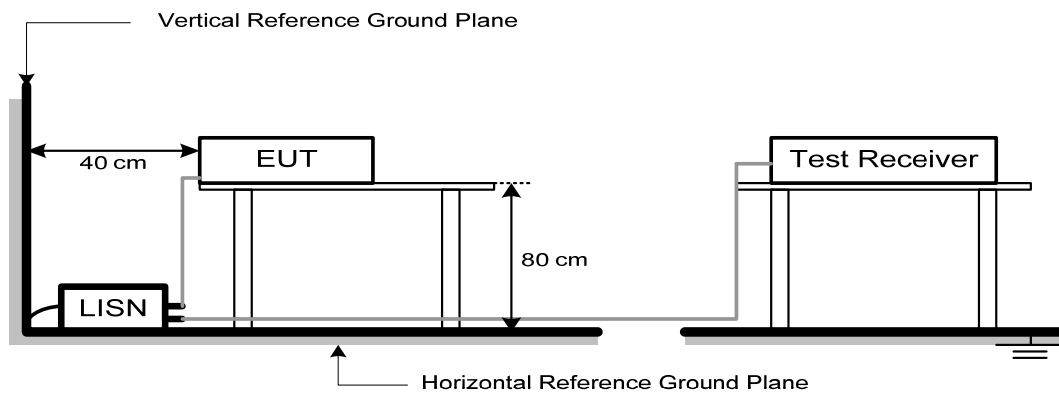

3.5 EUT OPERATION CONDITIONS

EUT was programmed to be in continuously transmitting mode.

3.6 TEST RESULTS

Please refer to the APPENDIX A.

4. RADIATED EMISSIONSTEST

4.1LIMIT

In case the emission fall within the restricted band specified on 15.205(a), then the 15.209(a) limit in the table below has to be followed.

LIMITS OF RADIATED EMISSION MEASUREMENT (9 kHz-1000MHz)

Frequency (MHz)	Field Strength (microvolts/meter)	Measurement Distance (meters)
0.009-0.490	2400/F(kHz)	300
0.490-1.705	24000/F(kHz)	30
1.705-30.0	30	30
30-88	100	3
88-216	150	3
216-960	200	3
Above 960	500	3

LIMITS OF RADIATED EMISSION MEASUREMENT (Above 1000MHz)

Frequency (MHz)	(dBuV/m at 3 m)	
	Peak	Average
Above 1000	74	54

NOTE:

- (1) The limit for radiated test was performed according to FCC PART 15C.
- (2) The tighter limit applies at the band edges.
- (3) Emission level (dBuV/m)=20log Emission level (uV/m).
- (4) The test result calculated as following:
 Measurement Value = Reading Level + Correct Factor
 Correct Factor = Antenna Factor + Cable Loss - Amplifier Gain(if use)
 Margin Level = Measurement Value - Limit Value

Spectrum Parameter	Setting
Attenuation	Auto
Start Frequency	1000 MHz
Stop Frequency	10th carrier harmonic
RBW / VBW (Emission in restricted band)	1MHz / 3MHz for Peak, 1MHz / 1/T for Average

Receiver Parameter	Setting
Attenuation	Auto
Start ~ Stop Frequency	9 kHz~90kHz for PK/AVG detector
Start ~ Stop Frequency	90kHz~110kHz for QP detector
Start ~ Stop Frequency	110kHz~490kHz for PK/AVG detector
Start ~ Stop Frequency	490kHz~30MHz for QP detector
Start ~ Stop Frequency	30MHz~1000MHz for QP detector

4.2 TEST PROCEDURE

- a. The measuring distance of 3 m shall be used for measurements. The EUT was placed on the top of a rotating table 0.8 meter above the ground at a 3 meter semi-anechoic chamber. The table was rotated 360 degrees to determine the position of the highest radiation.(below 1GHz)
- b. The measuring distance of 3 m shall be used for measurements. The EUT was placed on the top of a rotating table 1.5 meter above the ground at a 3 meter semi-anechoic chamber. The table was rotated 360 degrees to determine the position of the highest radiation.(above 1GHz)
- c. The height of the equipment or of the substitution antenna shall be 0.8m or 1.5m; the height of the test antenna shall vary between 1 m to 4 m. Both horizontal and vertical polarizations of the antenna are set to make the measurement.
- d. For each suspected emission, the EUT was arranged to its worst case and then the antenna was tuned to heights find the maximum reading (used Bore sight function).
- e. The receiver system was set to peak and average detect function and specified bandwidth with maximum hold mode when the test frequency is above 1GHz.
- f. The initial step in collecting radiated emission data is a receiver peak detector mode pre-scanning the measurement frequency range. Significant peaks are then marked and then Quasi Peak detector mode re-measured.
- g. All readings are Peak unless otherwise stated QP in column of Note. Peak denotes that the Peak reading compliance with the QP Limits and then QP Mode measurement didn't perform. (below 1GHz)
- h. All readings are Peak Mode value unless otherwise stated AVG in column of Note. If the Peak Mode Measured value compliance with the Peak Limits and lower than AVG Limits, the EUT shall be deemed to meet both Peak & AVG Limits and then only Peak Mode was measured, but AVG Mode didn't perform. (above 1GHz)
- i. For the actual test configuration, please refer to the related Item -EUT Test Photos.

4.3 DEVIATION FROM TEST STANDARD

No deviation

4.4 TEST SETUP

9 kHz-30 MHz

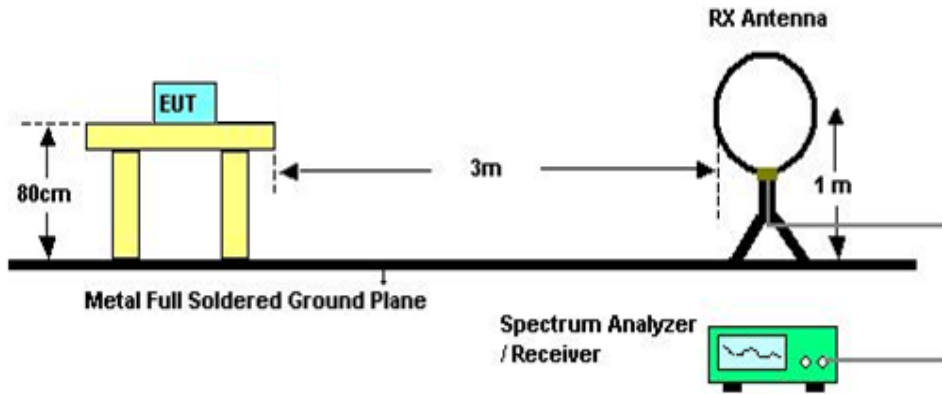

30 MHz to 1 GHz

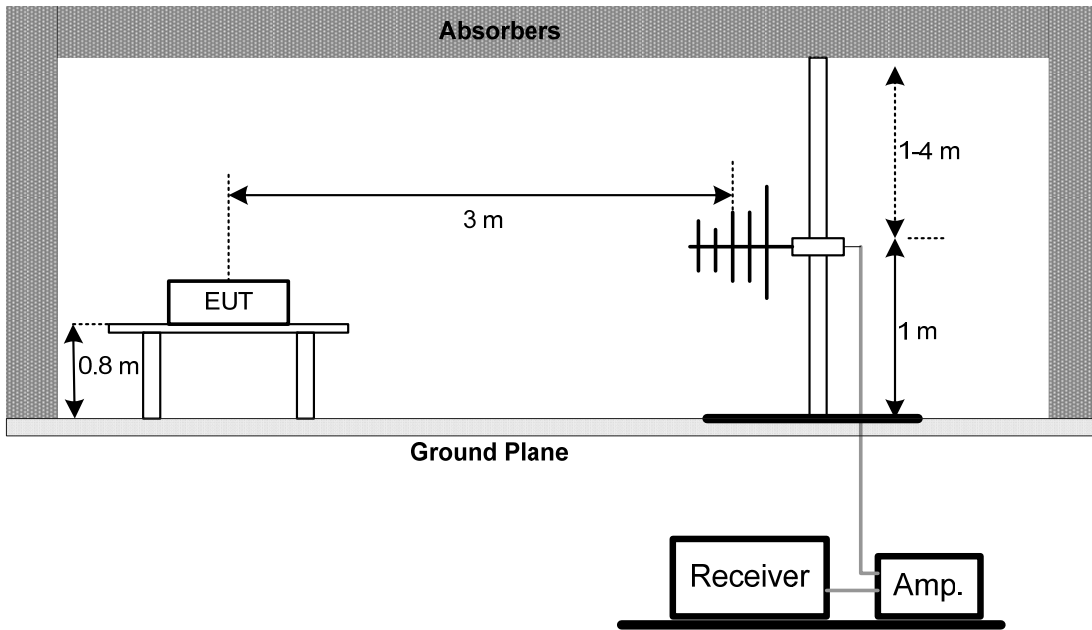

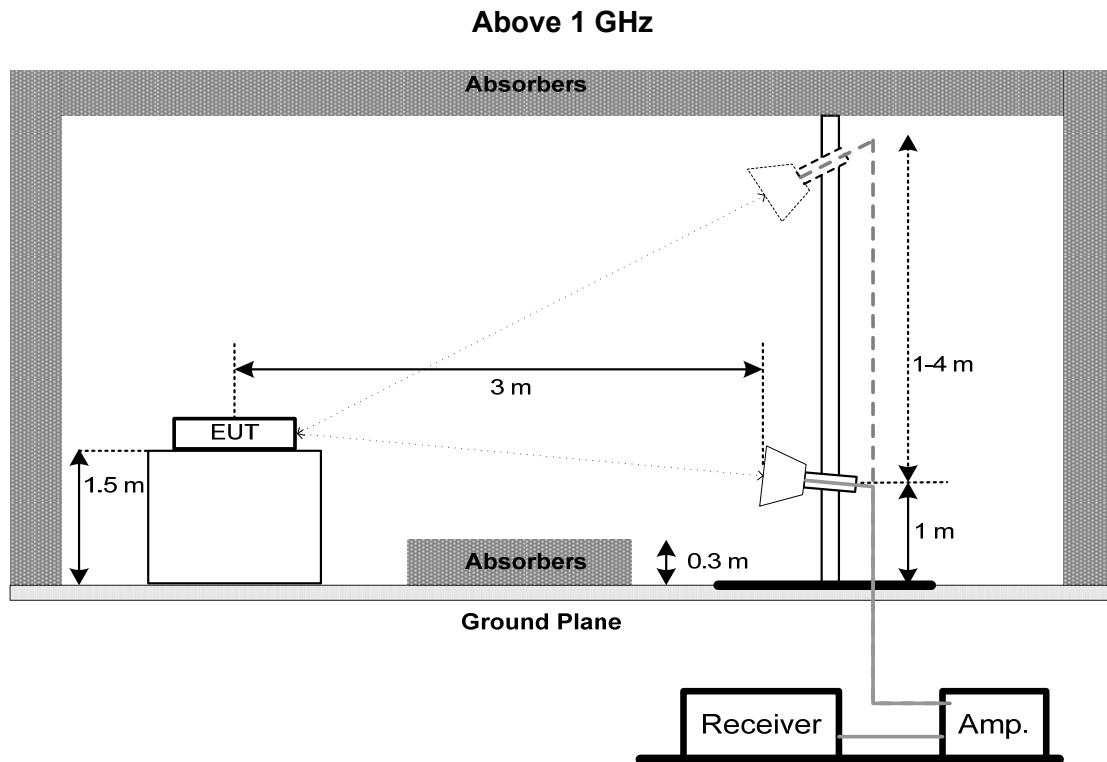

4.5 EUT OPERATION CONDITIONS

The EUT was programmed to be in continuously transmitting mode.

4.6 TEST RESULTS - 9 KHZ TO 30MHZ

Please refer to the APPENDIX B

Remark:

- (1) Distance extrapolation factor = $40 \log (\text{specific distance} / \text{test distance})$ (dB).
- (2) Limit line = specific limits (dBuV) + distance extrapolation factor.

4.7 TEST RESULTS - 30 MHZ TO 1000MHZ

Please refer to the APPENDIX C.

4.8 TEST RESULTS- ABOVE 1000MHZ

Please refer to the APPENDIX D.

Remark:

- (1) No limit: This is fundamental signal, the judgment is not applicable.
For fundamental signal judgment was referred to Peak output test.

5.BANDWIDTH TEST**5.1LIMIT**

FCC Part15, Subpart C (15.247)		
Section	Test Item	Limit
15.247(a)(2)	6dB Bandwidth	Minimum 500 kHz
	99% Emission Bandwidth	-

5.2TEST PROCEDURE

- The EUT was directly connected to the spectrum analyzer and antenna output port as show in the block diagram below.
- Spectrum Setting: RBW= 100 kHz, VBW=300 kHz, Sweep time = 2.5 ms.
- The bandwidth was performed in accordance with method 11.8.1 of ANSI C63.10-2013.

5.3DEVIATION FROM STANDARD

No deviation.

5.4TEST SETUP**5.5EUT OPERATION CONDITIONS**

The EUT was programmed to be in continuously transmitting mode.

5.6TESTRESULTS

Please refer to the APPENDIX E.

6. MAXIMUM OUTPUT POWER TEST**6.1 LIMIT**

FCC Part15, Subpart C (15.247)		
Section	Test Item	Limit
15.247(b)(3)	Maximum Output Power	1 Watt or 30dBm

6.2 TEST PROCEDURE

- The EUT was directly connected to the power meter and antenna output port as show in the block diagram below.
- The maximum conducted output power was performed in accordance with method 11.9.1.3(for peak power) or 11.9.2.3.1(for AVG power) of ANSI C63.10-2013.

6.3 DEVIATION FROM STANDARD

No deviation.

6.4 TEST SETUP**6.5 EUT OPERATION CONDITIONS**

The EUT was programmed to be in continuously transmitting mode.

6.6 TEST RESULTS

Please refer to the APPENDIX F.

7.CONDUCTED SPURIOUS EMISSIONS

7.1 LIMIT

In any 100 kHz bandwidth outside the frequency band in which the spread spectrum or digitally modulated intentional radiator is operating, the radio frequency power that is produced by the intentional radiator shall be at least 20 dB below that in the 100 kHz bandwidth within the band that contains the highest level of the desired power, based on either an RF conducted or a radiated measurement, provided the transmitter demonstrates compliance with the peak Output Power limits. If the transmitter complies with the Output Power limits based on the use of RMS averaging over a time interval, as permitted under paragraph (b)(3) of this section, the attenuation required under this paragraph shall be 30 dB instead of 20 dB. Attenuation below the general limits specified in Section 15.209(a) is not required. In addition, radiated emissions which fall in the restricted bands, as defined in Section 15.205(a), must also comply with the radiated emission limits specified in Section 15.209(a) (see Section 15.205(c)).

7.2TEST PROCEDURE

- a. The EUT was directly connected to the spectrum analyzer and antenna output port as show in the block diagram below.
- b. Spectrum Setting: RBW= 100 kHz, VBW=300 kHz, Sweep time = Auto.

7.3DEVIATION FROM STANDARD

No deviation.

7.4TEST SETUP



7.5EUT OPERATION CONDITIONS

The EUT was programmed to be in continuously transmitting mode.

7.6TEST RESULTS

Please refer to the APPENDIX G.

8. POWER SPECTRAL DENSITY TEST

8.1 LIMIT

FCC Part15, Subpart C (15.247)		
Section	Test Item	Limit
15.247(e)	Power Spectral Density	8 dBm (in any 3 kHz)

8.2 TEST PROCEDURE

- The EUT was directly connected to the spectrum analyzer and antenna output port as show in the block diagram below.
- Spectrum Setting: RBW=3 kHz, VBW=10 kHz, Sweep time = Auto.
- The Power Spectral Density was performed in accordance with method11.10.2 of ANSI C63.10-2013.

8.3 DEVIATION FROM STANDARD

No deviation.

8.4 TEST SETUP

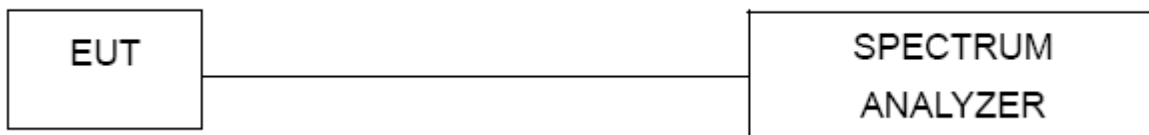

8.5 EUT OPERATION CONDITIONS

The EUT was programmed to be in continuously transmitting mode.

8.6 TEST RESULTS

Please refer to the APPENDIX H.

9. MEASUREMENT INSTRUMENTS LIST

AC Power Line Conducted Emissions					
Item	Kind of Equipment	Manufacturer	Type No.	Serial No.	Calibrated until
1	Line Impedance Stabilisation Network	Schwarzbeck	NNLK 8121	8121-822	Mar. 29, 2020
2	TWO-LINE V-NETWORK	R&S	ENV216	101340	Nov. 20, 2019
3	Test Cable	emci	EMCRG400-BM-NM-10000	170628	Apr. 17, 2020
4	EMI Test Receiver	R&S	ESCI	100082	Mar. 29, 2020
5	50Ω Terminator	SHX	TF2-1G-A	17051602	Mar. 29, 2020
6	50Ω coaxial switch	Anritsu	MP59B	6201750902	Mar. 29, 2020
7	Measurement Software	Farad	EZ-EMC Ver.NB-03A1-01	N/A	N/A

Radiated Emissions - 9 kHz to 30MHz					
Item	Kind of Equipment	Manufacturer	Type No.	Serial No.	Calibrated until
1	Loop Antenna	EMCI	EMCI LPA600	275	Mar. 29, 2020
2	EMI Test Receiver	R&S	ESCI	100082	Mar. 29, 2020
3	Measurement Software	Farad	EZ-EMC Ver.NB-03A1-01	N/A	N/A

Radiated Emissions - 30 MHz to 1 GHz					
Item	Kind of Equipment	Manufacturer	Type No.	Serial No.	Calibrated until
1	TRILOG Broadband Antenna	Schwarzbeck	VULB 9168	719	Mar. 29, 2020
2	Pre-Amplifier	emci	EMC9135	980400	Mar. 29, 2020
3	MXE EMI Receiver	Keysight	N9038A	MY57150106	Mar. 29, 2020
4	Test Cable	emci	EMC104-SM-SM-7000	170330	Apr. 17, 2020
5	Test Cable	emci	EMC104-SM-SM-1000	170331	Apr. 17, 2020
6	Test Cable	emci	EMC104-SM-NM-3500	170621	Apr. 17, 2020
7	Measurement Software	Farad	EZ-EMC Ver.NB-03A1-01	N/A	N/A

Radiated Emissions - Above 1GHz

Item	Kind of Equipment	Manufacturer	Type No.	Serial No.	Calibrated until
1	Double-Ridged Waveguide Horn Antenna	ETS-Lindgren	9120D	00206960	Mar. 29, 2020
2	Pre-Amplifier	emci	EMC012645SE	980421	Mar. 29, 2020
3	EXA Spectrum Analyzer	Keysight	N9010A	MY56480545	Mar. 29, 2020
4	Test Cable	emci	EMC104-SM-SM-7000	170330	Apr. 17, 2020
5	Test Cable	emci	EMC104-SM-SM-1000	170331	Apr. 17, 2020
6	Test Cable	emci	EMC104-SM-NM-3500	170621	Apr. 17, 2020
7	Measurement Software	Farad	EZ-EMC Ver.NB-03A1-01	N/A	N/A
8	MXE EMI Receiver	Keysight	N9038A	MY57150106	Mar. 29, 2020

Bandwidth

Item	Kind of Equipment	Manufacturer	Type No.	Serial No.	Calibrated until
1	Spectrum Analyzer	R&S	FSP40	100626	Mar. 29, 2020

Maximum Output Power

Item	Kind of Equipment	Manufacturer	Type No.	Serial No.	Calibrated until
1	Power Meter	Keysight	8990B	MY51000507	Mar. 29, 2020
2	Pulse Power Sensor	Keysight	N1923A	MY58310003	Mar. 29, 2020

Antenna Conducted Spurious Emissions

Item	Kind of Equipment	Manufacturer	Type No.	Serial No.	Calibrated until
1	Spectrum Analyzer	R&S	FSP40	100626	Mar. 29, 2020

Power Spectral Density

Item	Kind of Equipment	Manufacturer	Type No.	Serial No.	Calibrated until
1	Spectrum Analyzer	R&S	FSP40	100626	Mar. 29, 2020

Remark: "N/A" denotes no model name, serial no. or calibration specified.

All calibration period of equipment list is one year.

APPENDIX A - AC POWER LINE CONDUCTED EMISSIONS

Test Mode: TX Mode

Line

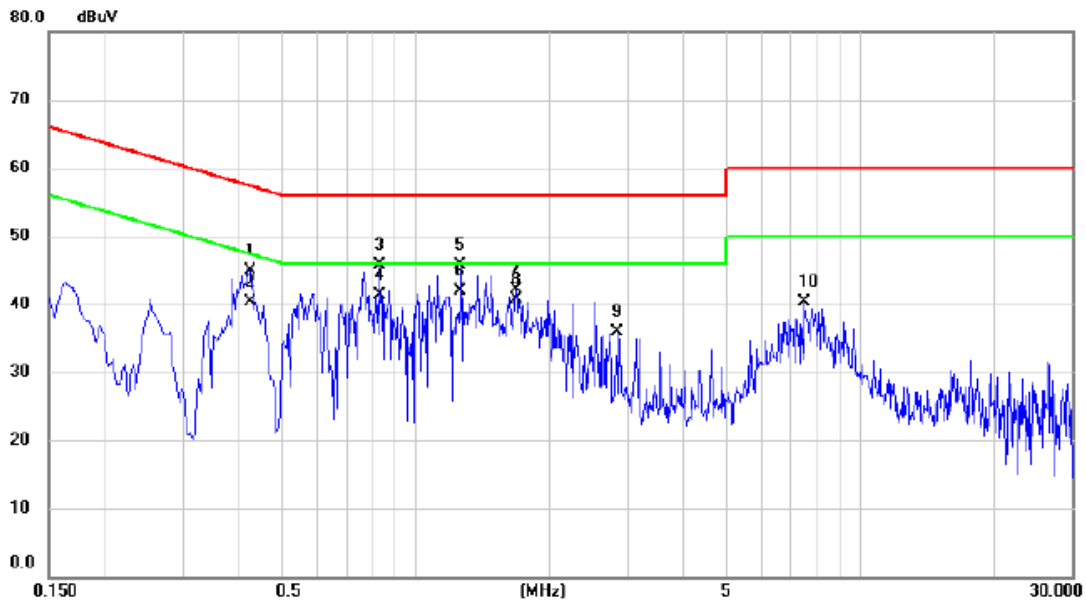

No.	Mk.	Freq. MHz	Reading Level dBuV	Correct Factor dB	Measure- ment dBuV	Limit dBuV	Margin dB	Detector	Comment
1		0.4243	35.06	9.91	44.97	57.36	-12.39	QP	
2		0.4243	30.41	9.91	40.32	47.36	-7.04	AVG	
3		0.8294	35.87	9.82	45.69	56.00	-10.31	QP	
4		0.8294	31.52	9.82	41.34	46.00	-4.66	AVG	
5		1.2660	36.37	9.28	45.65	56.00	-10.35	QP	
6	*	1.2660	32.62	9.28	41.90	46.00	-4.10	AVG	
7		1.6890	32.22	9.96	42.18	56.00	-13.82	QP	
8		1.6890	30.71	9.96	40.67	46.00	-5.33	AVG	
9		2.8454	25.87	10.01	35.88	56.00	-20.12	QP	
10		7.4984	30.22	10.14	40.36	60.00	-19.64	QP	

REMARKS:

- (1) Measurement Value = Reading Level + Correct Factor.
- (2) Margin Level = Measurement Value - Limit Value.

Test Mode: TX Mode

Neutral

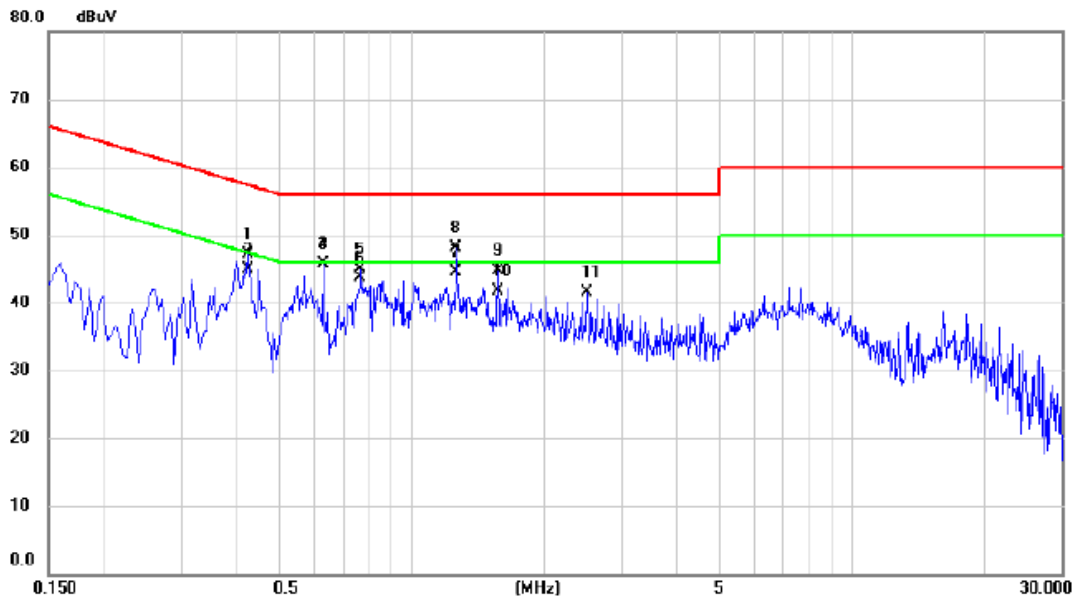

No. Mk.	Freq. MHz	Reading Level dBuV	Correct Factor dB	Measurement dBuV	Limit dBuV	Margin dB	Detector	Comment
1	0.4243	37.24	9.77	47.01	57.36	-10.35	QP	
2	0.4244	35.13	9.77	44.90	47.36	-2.46	AVG	
3	0.6311	35.89	9.84	45.73	56.00	-10.27	QP	
4	0.6313	35.89	9.84	45.73	46.00	-0.27	AVG	
5	0.7661	35.02	9.82	44.84	56.00	-11.16	QP	
6	0.7663	33.81	9.82	43.63	46.00	-2.37	AVG	
7	1.2660	34.80	9.78	44.58	56.00	-11.42	QP	
8 *	1.2660	38.35	9.78	48.13	46.00	2.13	AVG	
9	1.5720	34.78	9.93	44.71	56.00	-11.29	QP	
10	1.5720	31.74	9.93	41.67	46.00	-4.33	AVG	
11	2.5034	31.58	9.99	41.57	56.00	-14.43	QP	

REMARKS:

- (1) Measurement Value = Reading Level + Correct Factor.
- (2) Margin Level = Measurement Value - Limit Value.

APPENDIX B - RADIATED EMISSION - 9 KHZ TO 30 MHZ

Test Mode: TX Mode

Ant 0°

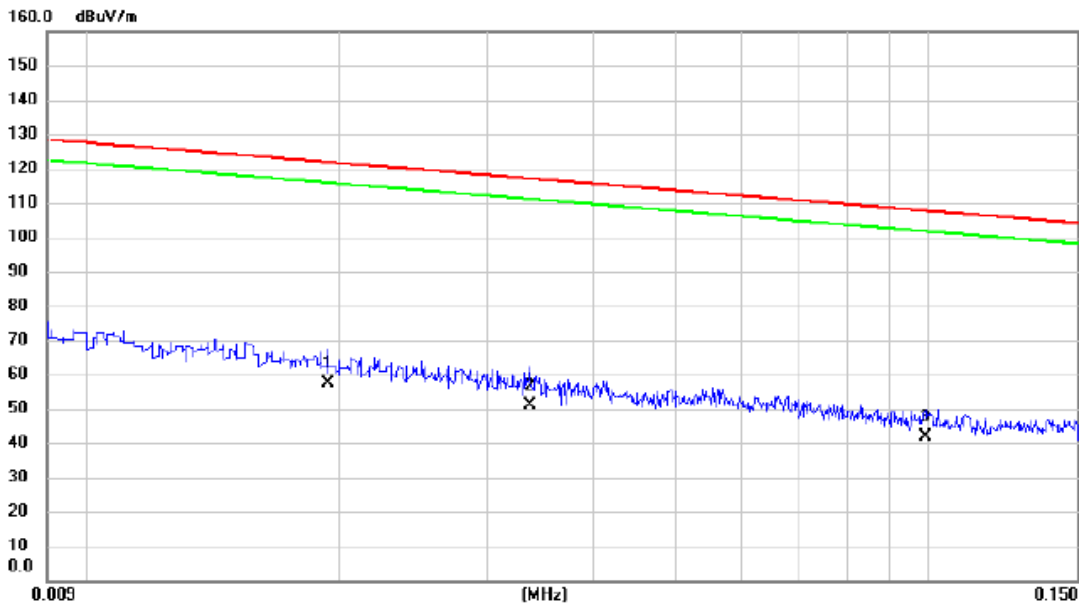

No.	Mk.	Freq.	Reading Level	Correct Factor	Measurement	Limit	Margin	Detector	Comment
		MHz	dBuV	dB	dBuV/m	dBuV/m	dB		
1	*	0.0194	-15.45	72.67	57.22	121.85	-64.63	AVG	
2		0.0337	-17.53	68.59	51.06	117.05	-65.99	AVG	
3		0.0990	-16.28	58.12	41.84	107.69	-65.85	QP	

REMARKS:

- (1) Measurement Value = Reading Level + Correct Factor.
- (2) Margin Level = Measurement Value - Limit Value.

Test Mode: TX Mode

Ant 0°

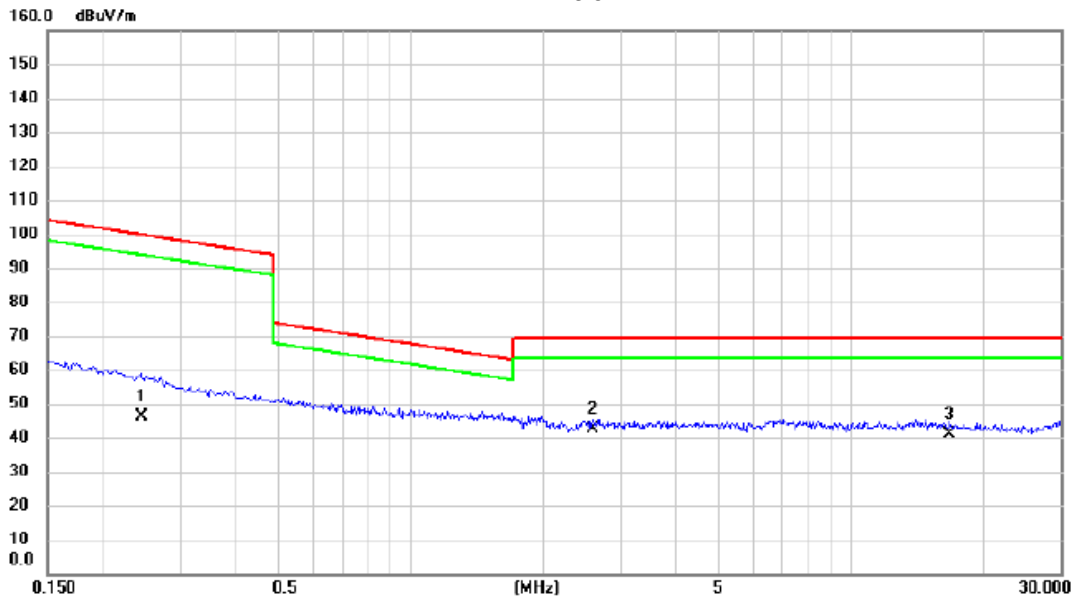

No.	Mk.	Freq. MHz	Reading Level dBuV	Correct Factor dB	Measure- ment dBuV/m	Limit dBuV/m	Margin dB	Detector	Comment
1		0.2444	-4.24	50.59	46.35	99.84	-53.49	AVG	
2	*	2.5890	4.12	38.33	42.45	69.54	-27.09	QP	
3		16.7370	3.60	37.51	41.11	69.54	-28.43	QP	

REMARKS:

(1) Measurement Value = Reading Level + Correct Factor.

(2) Margin Level = Measurement Value - Limit Value.

Test Mode: TX Mode

Ant 90°

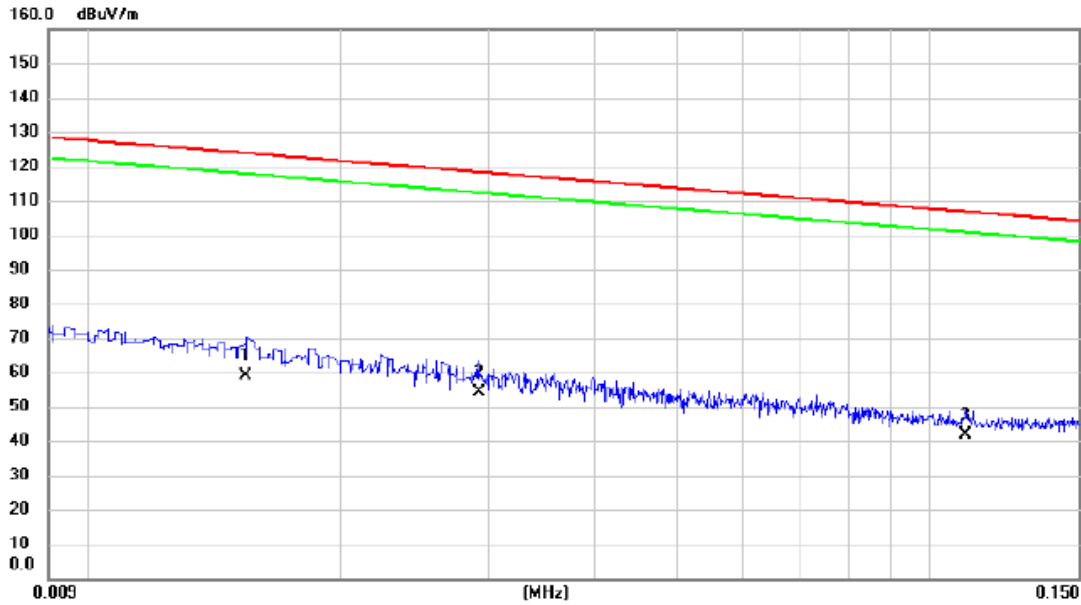

No.	Mk.	Freq. MHz	Reading Level dBuV	Correct Factor dB	Measure- ment dBuV/m	Limit dBuV/m	Margin dB	Detector	Comment
1		0.0154	-16.06	75.11	59.05	123.85	-64.80	AVG	
2	*	0.0292	-15.62	69.91	54.29	118.30	-64.01	AVG	
3		0.1101	-15.50	57.40	41.90	106.77	-64.87	AVG	

REMARKS:

- (1) Measurement Value = Reading Level + Correct Factor.
- (2) Margin Level = Measurement Value - Limit Value.

Test Mode: TX Mode

Ant 90°

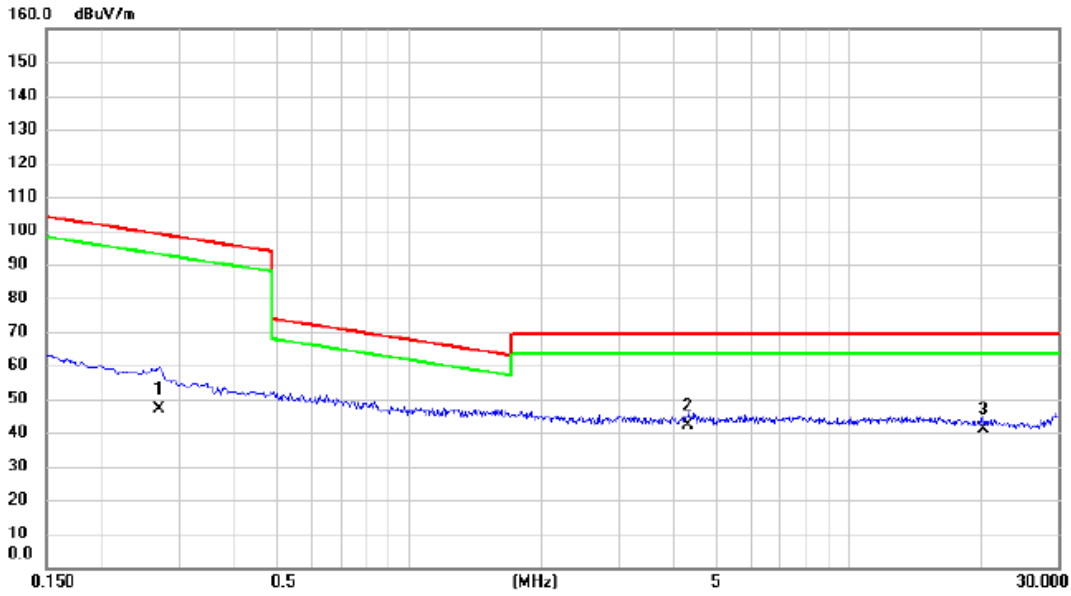

No.	Mk.	Freq.	Reading Level	Correct Factor	Measurement	Limit	Margin	Detector	Comment
		MHz	dBuV	dB	dBuV/m	dBuV/m	dB		
1		0.2714	-2.82	49.67	46.85	98.93	-52.08	AVG	
2	*	4.3215	4.40	37.84	42.24	69.54	-27.30	QP	
3		20.2240	3.98	36.84	40.82	69.54	-28.72	QP	

REMARKS:

- (1) Measurement Value = Reading Level + Correct Factor.
- (2) Margin Level = Measurement Value - Limit Value.

APPENDIX C - RADIATED EMISSION - 30 MHZ TO 1000 MHZ

Test Mode: TX Mode

Vertical

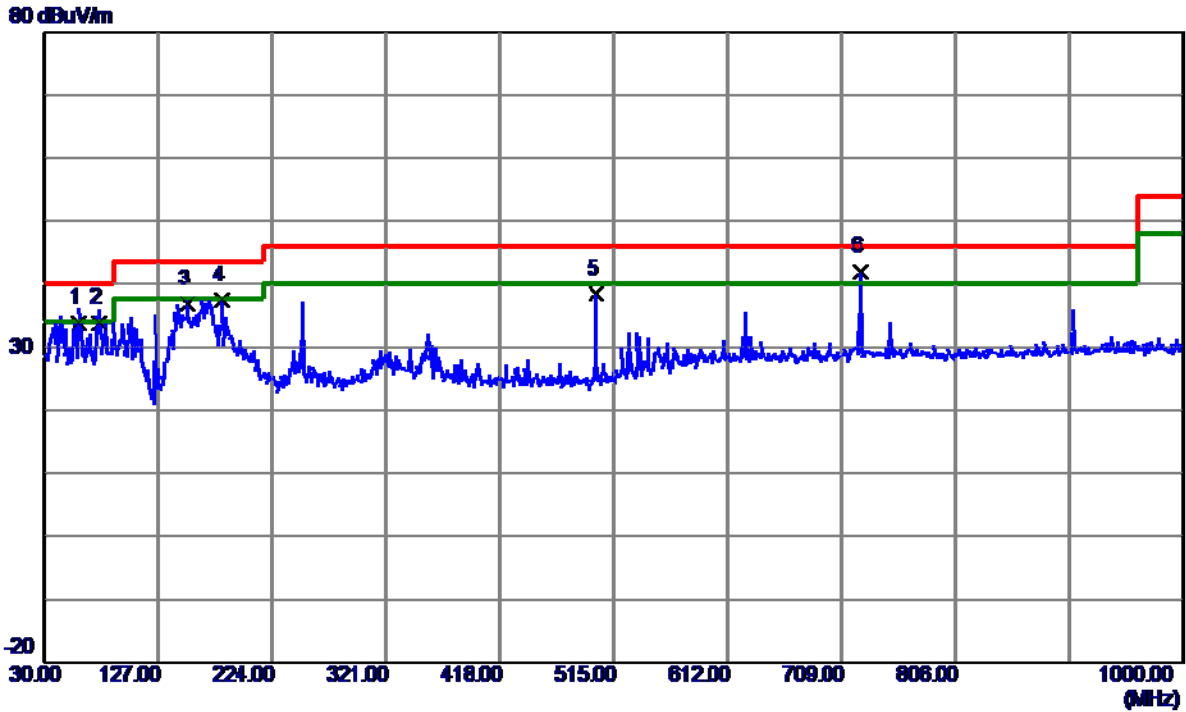

No.	Freq. MHz	Reading Level dBuV/m	Correct Factor dB	Measure ment dBuV/m	Limit dBuV/m	Margin dB	Detector	Comment
1	58.6150	50.78	-17.06	33.72	40.00	-6.28	QP	
2	76.5600	53.29	-19.42	33.87	40.00	-6.13	QP	
3	151.7350	50.51	-13.65	36.86	43.50	-6.64	QP	
4	181.3200	53.87	-16.41	37.46	43.50	-6.04	QP	
5	499.9650	49.67	-11.26	38.41	46.00	-7.59	Peak	
6 *	725.0050	48.41	-6.45	41.96	46.00	-4.04	QP	

REMARKS:

- (1) Measurement Value = Reading Level + Correct Factor.
- (2) Margin Level = Measurement Value - Limit Value.

Test Mode: TX Mode

Horizontal

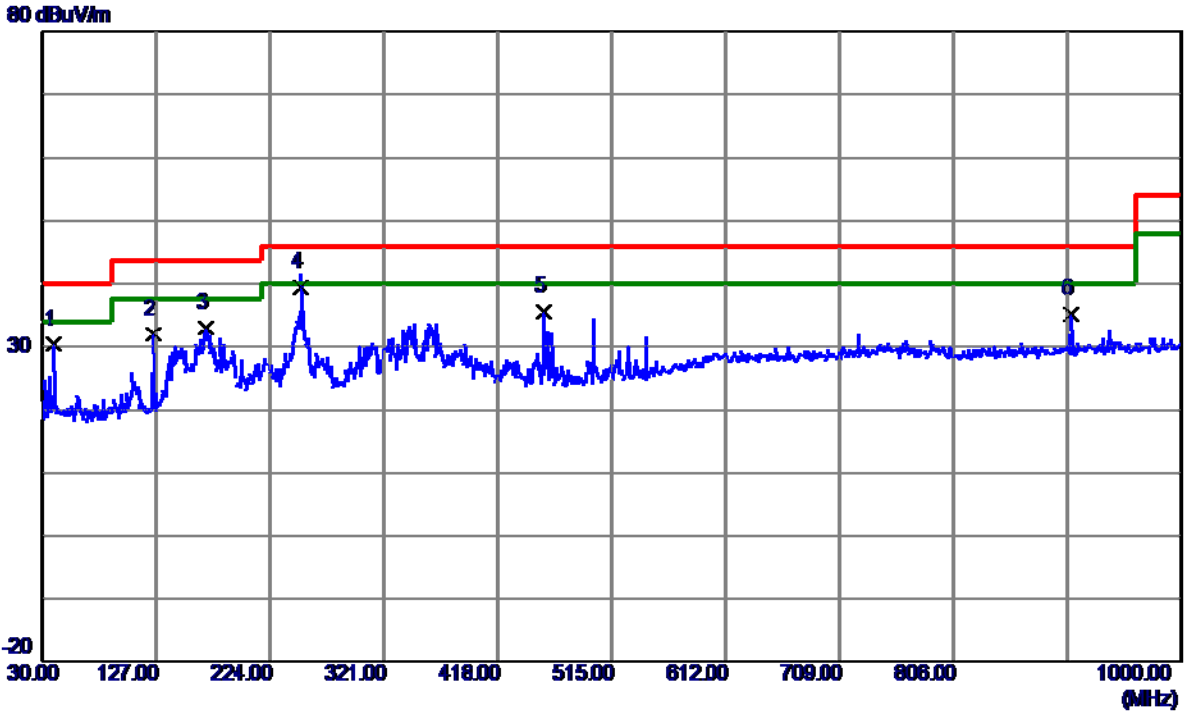

No.	Freq. MHz	Reading Level dBuV/m	Correct Factor dB	Measure ment dBuV/m	Limit dBuV/m	Margin dB	Detector	Comment
1	40.1850	46.63	-16.28	30.35	40.00	-9.65	Peak	
2	125.0600	47.71	-15.64	32.07	43.50	-11.43	Peak	
3	168.7100	47.38	-14.41	32.97	43.50	-10.53	Peak	
4 *	250.1900	55.22	-15.88	39.34	46.00	-6.66	QP	
5	456.3150	47.15	-11.63	35.52	46.00	-10.48	Peak	
6	906.3950	41.02	-5.88	35.14	46.00	-10.86	Peak	

REMARKS:

- (1) Measurement Value = Reading Level + Correct Factor.
- (2) Margin Level = Measurement Value - Limit Value.

APPENDIXD -RADIATED EMISSION- ABOVE 1000MHZ

Test Mode: TX B Mode 2412 MHz

Vertical

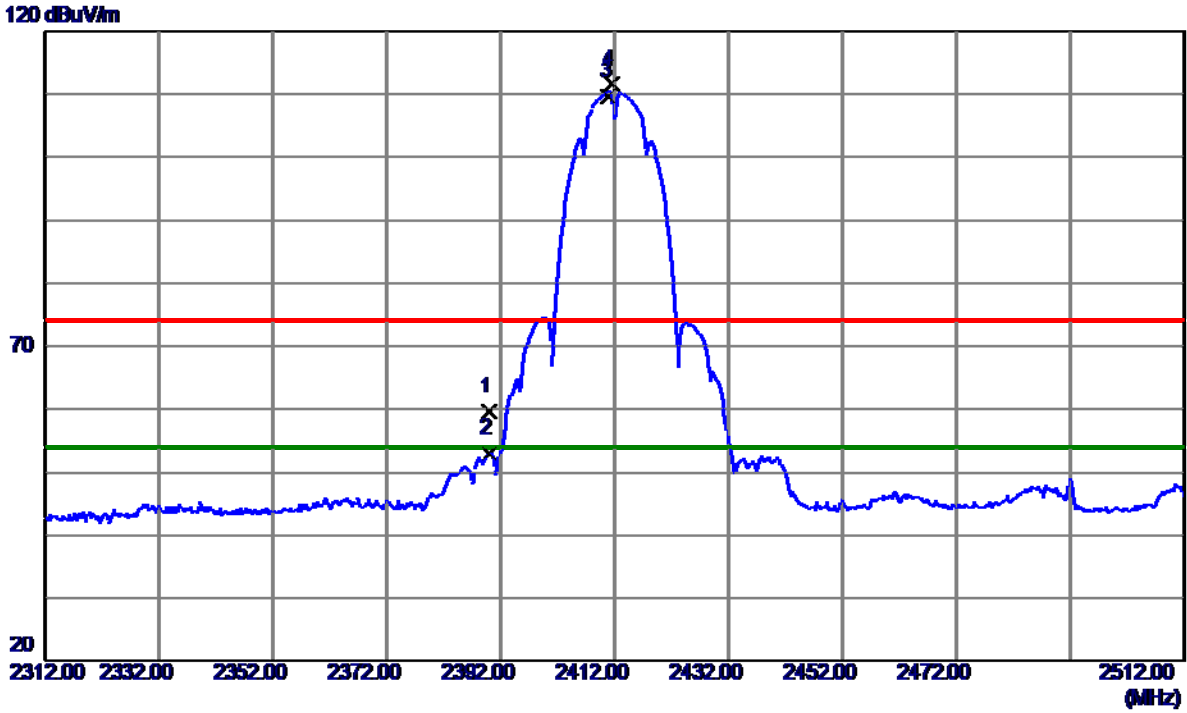

No.	Freq. MHz	Reading Level dBuV/m	Correct Factor dB	Measure ment dBuV/m	Limit dBuV/m	Margin dB	Detector	Comment
1	2390.0000	26.27	33.25	59.52	74.00	-14.48	Peak	
2	2390.0000	19.77	33.25	53.02	54.00	-0.98	AVG	
3 *	2411.0000	76.27	33.31	109.58	54.00	55.58	AVG	No limit
4	2411.6000	78.32	33.31	111.63	74.00	37.63	Peak	No limit

REMARKS:

(1) Measurement Value = Reading Level + Correct Factor.

(2) Margin Level = Measurement Value - Limit Value.

Test Mode: TX B Mode2412 MHz

Vertical

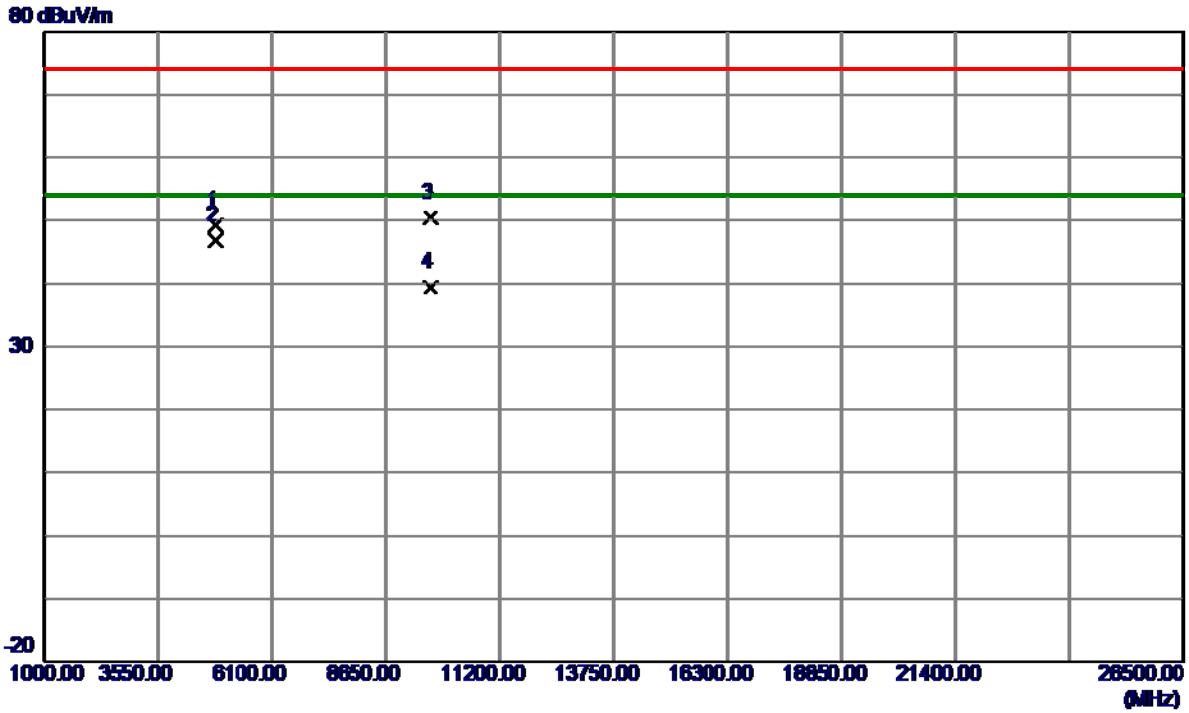

No.	Freq. MHz	Reading Level dBuV/m	Correct Factor dB	Measure ment dBuV/m	Limit dBuV/m	Margin dB	Detector	Comment
1	4823.9800	58.27	-8.99	49.28	74.00	-24.72	Peak	
2 *	4824.0900	55.79	-8.99	46.80	54.00	-7.20	AVG	
3	9647.9650	48.87	1.56	50.43	74.00	-23.57	Peak	
4	9648.0550	37.85	1.56	39.41	54.00	-14.59	AVG	

REMARKS:

- (1) Measurement Value = Reading Level + Correct Factor.
- (2) Margin Level = Measurement Value - Limit Value.

Test Mode: TX B Mode2412 MHz

Horizontal

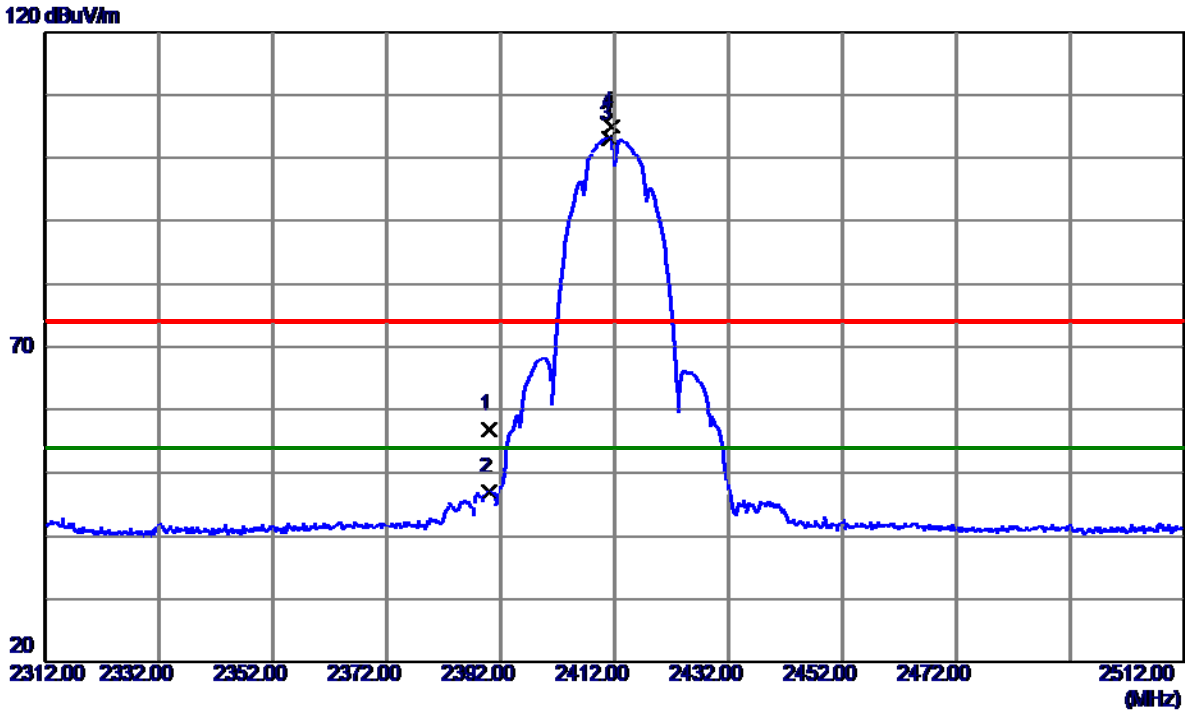

No.	Freq. MHz	Reading Level dBuV/m	Correct Factor dB	Measure ment dBuV/m	Limit dBuV/m	Margin dB	Detector	Comment
1	2390.0000	23.49	33.25	56.74	74.00	-17.26	Peak	
2	2390.0000	13.72	33.25	46.97	54.00	-7.03	AVG	
3 *	2411.2000	69.71	33.31	103.02	54.00	49.02	AVG	No limit
4	2411.6000	71.79	33.31	105.10	74.00	31.10	Peak	No limit

REMARKS:

- (1) Measurement Value = Reading Level + Correct Factor.
- (2) Margin Level = Measurement Value - Limit Value.

Test Mode: TX B Mode 2412 MHz

Horizontal

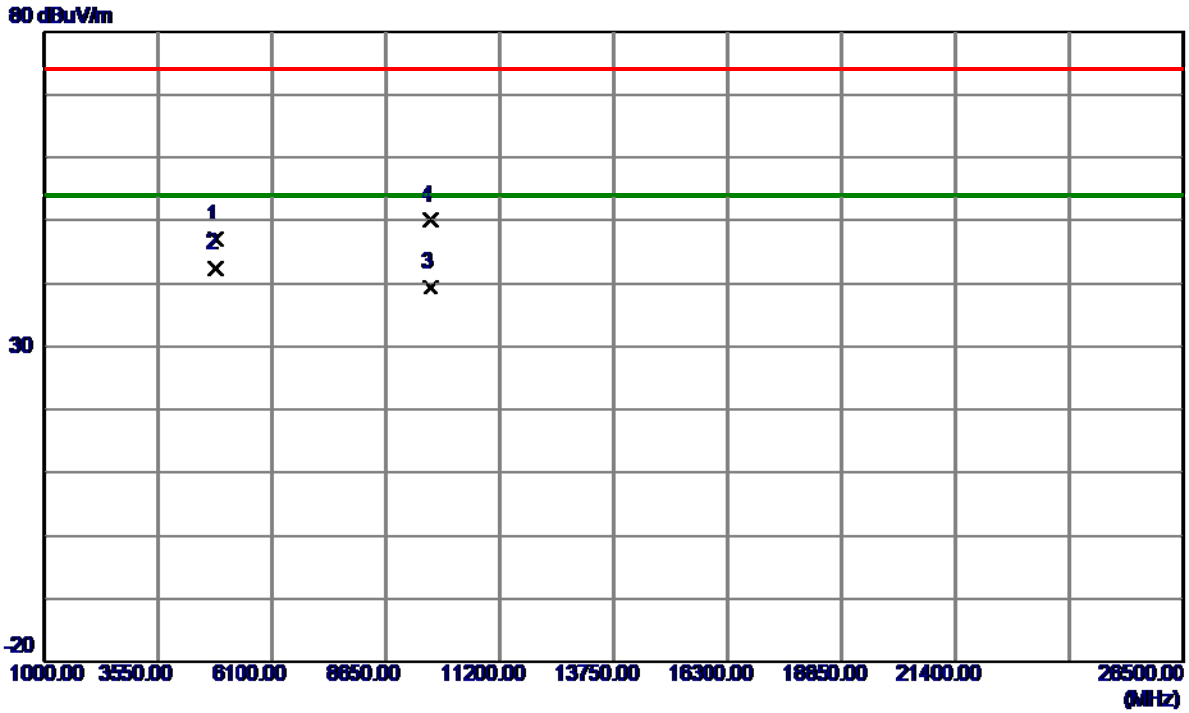

No.	Freq. MHz	Reading Level dBuV/m	Correct Factor dB	Measure ment dBuV/m	Limit dBuV/m	Margin dB	Detector	Comment
1	4823.8900	56.06	-8.99	47.07	74.00	-26.93	Peak	
2 *	4824.0050	51.46	-8.99	42.47	54.00	-11.53	AVG	
3	9648.1100	37.87	1.56	39.43	54.00	-14.57	AVG	
4	9648.6050	48.52	1.56	50.08	74.00	-23.92	Peak	

REMARKS:

- (1) Measurement Value = Reading Level + Correct Factor.
- (2) Margin Level = Measurement Value - Limit Value.

Test Mode: TX B Mode 2437 MHz

Vertical

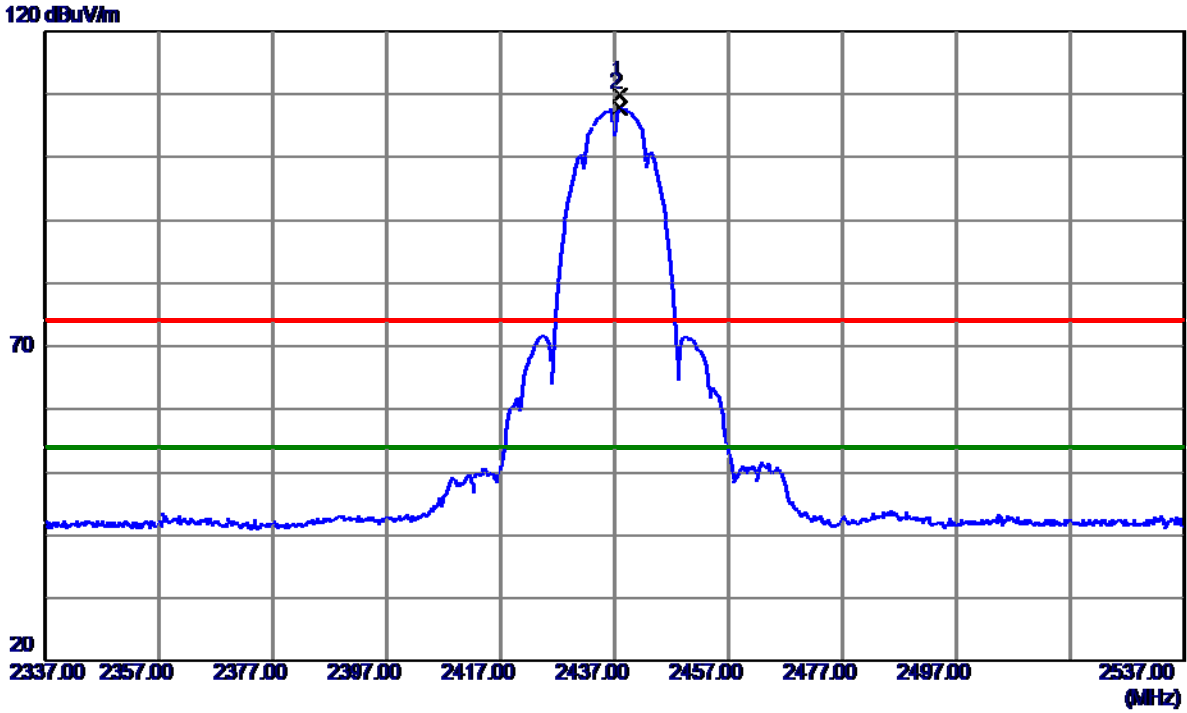

No.	Freq. MHz	Reading Level dBuV/m	Correct Factor dB	Measure ment dBuV/m	Limit dBuV/m	Margin dB	Detector	Comment
1	2437.8000	76.33	33.38	109.71	74.00	35.71	Peak	No limit
2 *	2437.8000	74.41	33.38	107.79	54.00	53.79	AVG	No limit

REMARKS:

- (1) Measurement Value = Reading Level + Correct Factor.
- (2) Margin Level = Measurement Value - Limit Value.

Test Mode: TX B Mode2437 MHz

Vertical

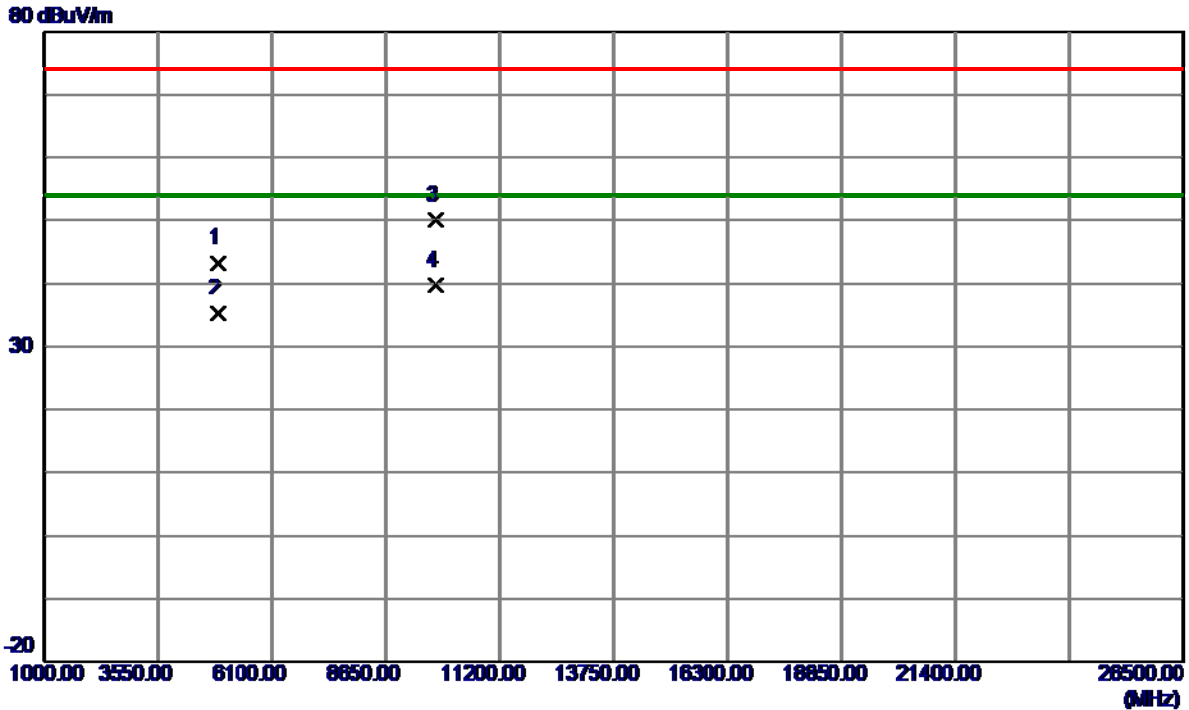

No.	Freq. MHz	Reading Level dBuV/m	Correct Factor dB	Measure ment dBuV/m	Limit dBuV/m	Margin dB	Detector	Comment
1	4873.9100	52.07	-8.80	43.27	74.00	-30.73	Peak	
2	4873.9800	43.93	-8.80	35.13	54.00	-18.87	AVG	
3	9747.8450	48.13	1.89	50.02	74.00	-23.98	Peak	
4 *	9748.0000	37.81	1.89	39.70	54.00	-14.30	AVG	

REMARKS:

- (1) Measurement Value = Reading Level + Correct Factor.
- (2) Margin Level = Measurement Value - Limit Value.

Test Mode: TX B Mode2437 MHz

Horizontal

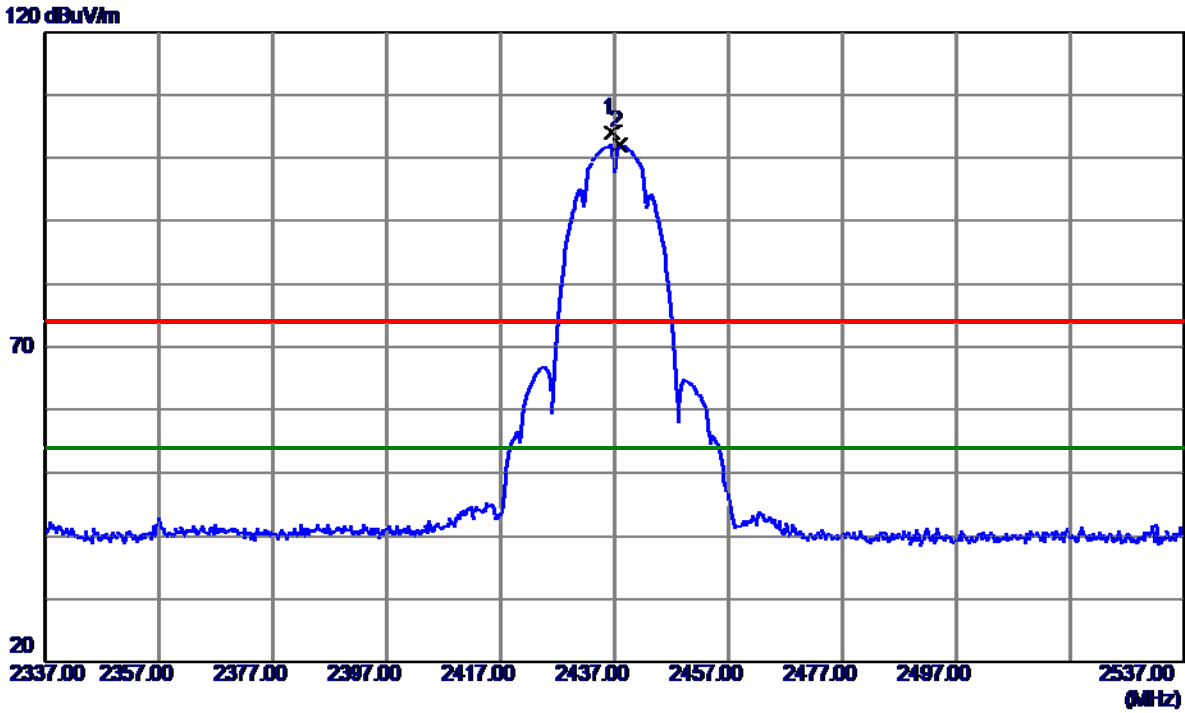

No.	Freq. MHz	Reading Level dBuV/m	Correct Factor dB	Measure ment dBuV/m	Limit dBuV/m	Margin dB	Detector	Comment
1	2436.6000	70.67	33.38	104.05	74.00	30.05	Peak	No limit
2 *	2437.8000	68.64	33.38	102.02	54.00	48.02	AVG	No limit

REMARKS:

- (1) Measurement Value = Reading Level + Correct Factor.
- (2) Margin Level = Measurement Value - Limit Value.

Test Mode: TX B Mode2437 MHz

Horizontal

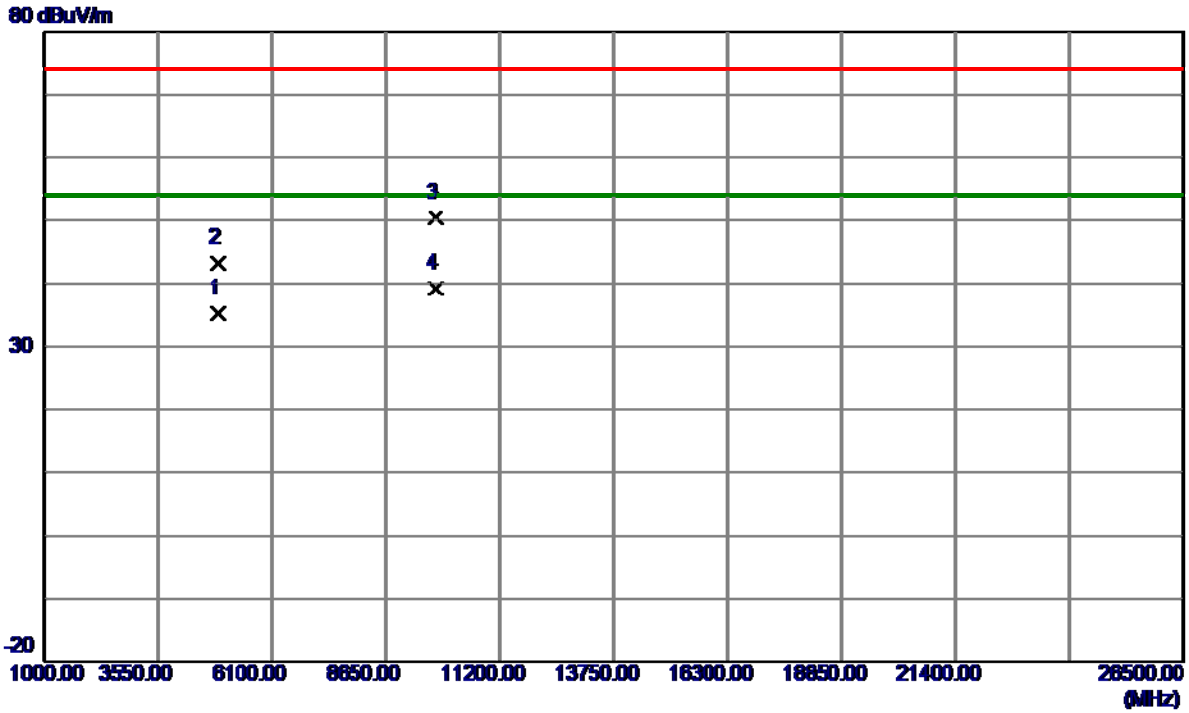

No.	Freq. MHz	Reading Level dBuV/m	Correct Factor dB	Measure ment dBuV/m	Limit dBuV/m	Margin dB	Detector	Comment
1	4874.0700	44.02	-8.80	35.22	54.00	-18.78	AVG	
2	4874.6549	52.02	-8.80	43.22	74.00	-30.78	Peak	
3	9747.8700	48.46	1.89	50.35	74.00	-23.65	Peak	
4 *	9747.9800	37.32	1.89	39.21	54.00	-14.79	AVG	

REMARKS:

- (1) Measurement Value = Reading Level + Correct Factor.
- (2) Margin Level = Measurement Value - Limit Value.

Test Mode: TX B Mode 2462 MHz

Vertical

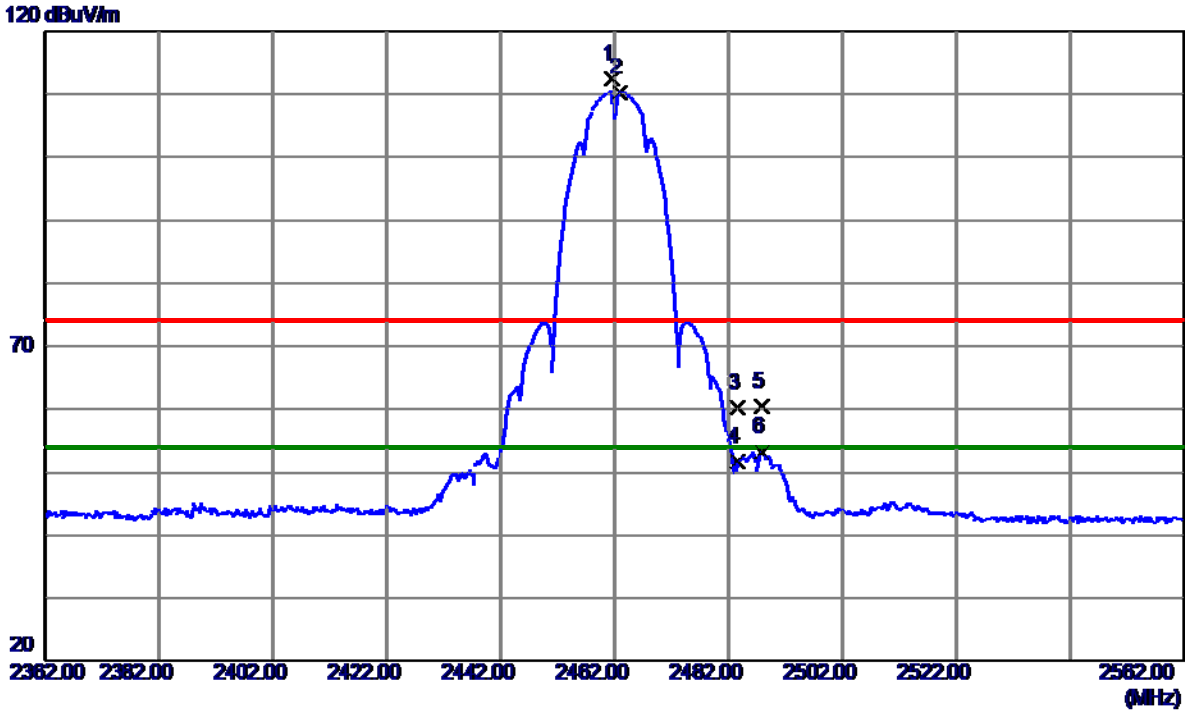

No.	Freq. MHz	Reading Level dBuV/m	Correct Factor dB	Measure ment dBuV/m	Limit dBuV/m	Margin dB	Detector	Comment
1	2461.6000	78.90	33.45	112.35	74.00	38.35	Peak	No limit
2 *	2462.8000	76.75	33.45	110.20	54.00	56.20	AVG	No limit
3	2483.5000	26.63	33.51	60.14	74.00	-13.86	Peak	
4	2483.5000	18.19	33.51	51.70	54.00	-2.30	AVG	
5	2487.8000	26.91	33.53	60.44	74.00	-13.56	Peak	
6	2487.8000	19.70	33.53	53.23	54.00	-0.77	AVG	

REMARKS:

(1) Measurement Value = Reading Level + Correct Factor.

(2) Margin Level = Measurement Value - Limit Value.

Test Mode: TX B Mode2462 MHz

Vertical

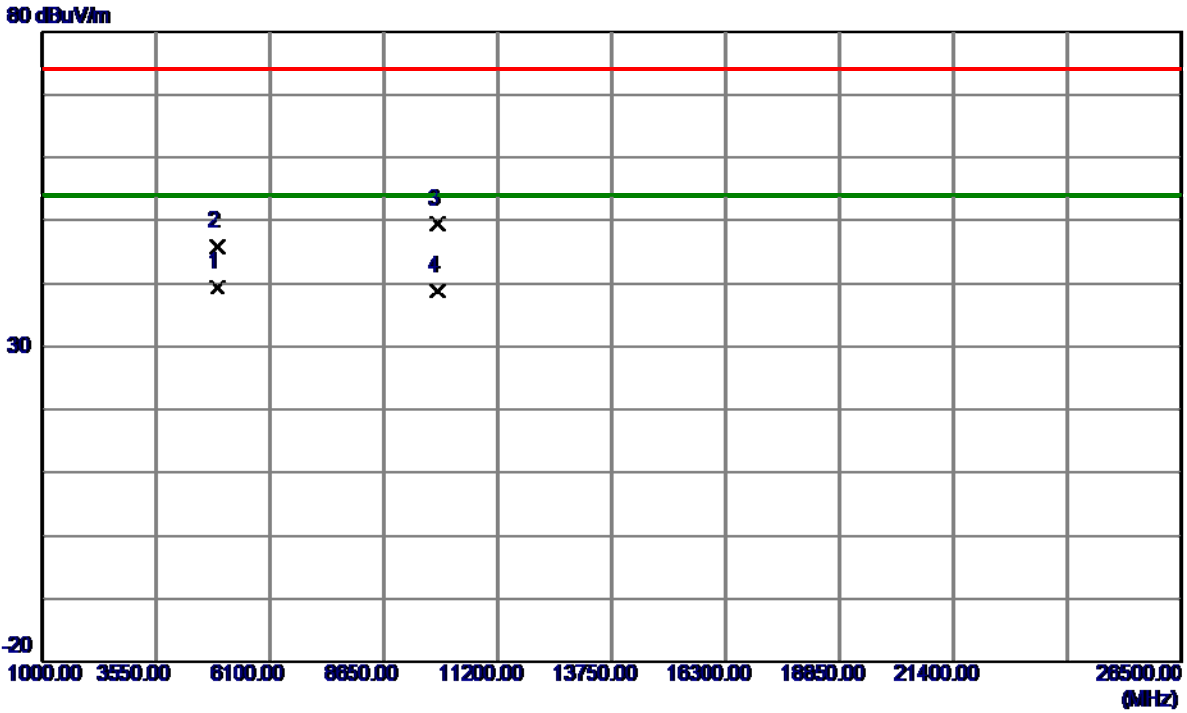

No.	Freq. MHz	Reading Level dBuV/m	Correct Factor dB	Measure ment dBuV/m	Limit dBuV/m	Margin dB	Detector	Comment
1 *	4924.0000	48.08	-8.60	39.48	54.00	-14.52	AVG	
2	4924.0700	54.34	-8.60	45.74	74.00	-28.26	Peak	
3	9847.4100	47.11	2.21	49.32	74.00	-24.68	Peak	
4	9848.0400	36.50	2.21	38.71	54.00	-15.29	AVG	

REMARKS:

- (1) Measurement Value = Reading Level + Correct Factor.
- (2) Margin Level = Measurement Value - Limit Value.

Test Mode: TX B Mode 2462 MHz

Horizontal

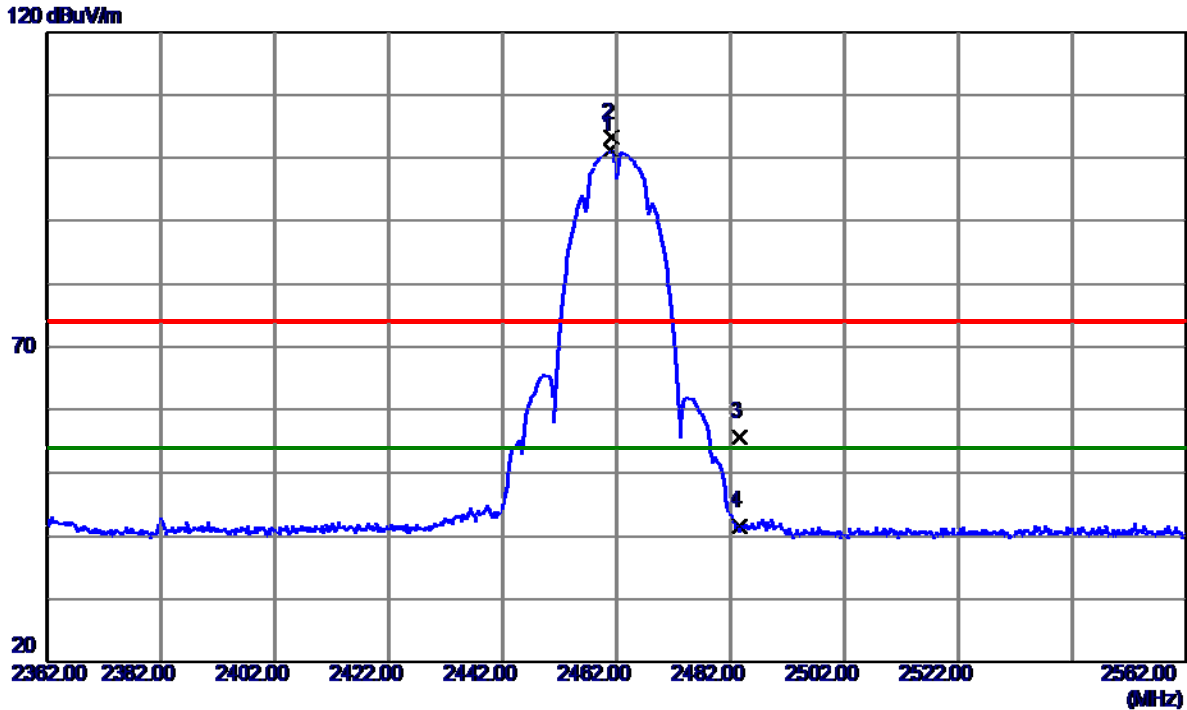

No.	Freq. MHz	Reading Level dBuV/m	Correct Factor dB	Measure ment dBuV/m	Limit dBuV/m	Margin dB	Detector	Comment
1 *	2461.0000	67.76	33.45	101.21	54.00	47.21	AVG	No limit
2	2461.2000	69.69	33.45	103.14	74.00	29.14	Peak	No limit
3	2483.5000	22.10	33.51	55.61	74.00	-18.39	Peak	
4	2483.5000	8.04	33.51	41.55	54.00	-12.45	AVG	

REMARKS:

- (1) Measurement Value = Reading Level + Correct Factor.
- (2) Margin Level = Measurement Value - Limit Value.

Test Mode: TX B Mode2462 MHz

Horizontal

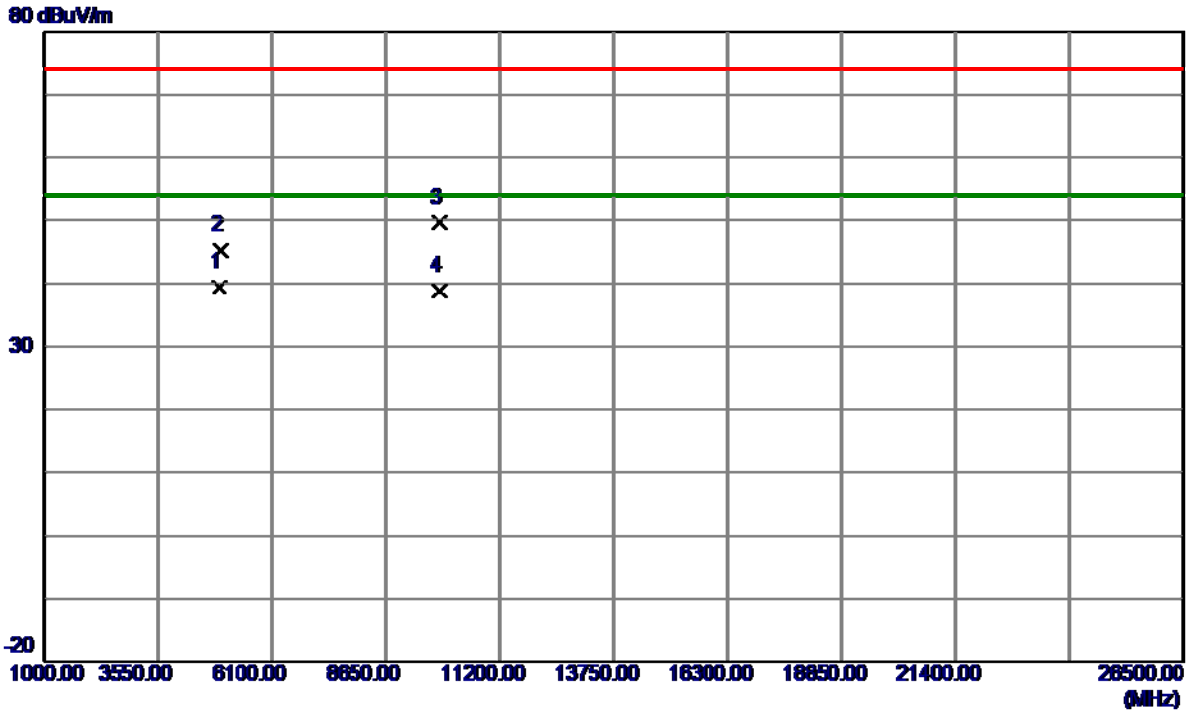

No.	Freq. MHz	Reading Level dBuV/m	Correct Factor dB	Measure ment dBuV/m	Limit dBuV/m	Margin dB	Detector	Comment
1 *	4924.0500	48.00	-8.60	39.40	54.00	-14.60	AVG	
2	4924.2750	53.71	-8.60	45.11	74.00	-28.89	Peak	
3	9847.5550	47.47	2.21	49.68	74.00	-24.32	Peak	
4	9848.0500	36.67	2.21	38.88	54.00	-15.12	AVG	

REMARKS:

- (1) Measurement Value = Reading Level + Correct Factor.
- (2) Margin Level = Measurement Value - Limit Value.

Test Mode: TX G Mode2412 MHz

Vertical

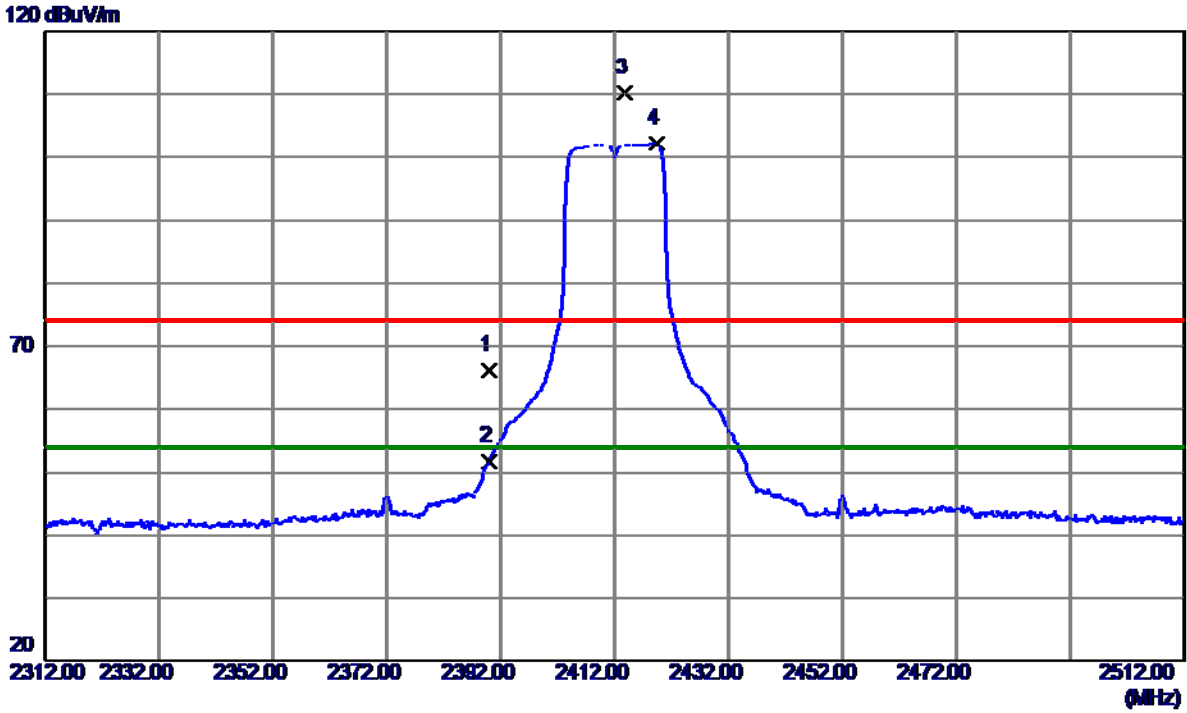

No.	Freq. MHz	Reading Level dBuV/m	Correct Factor dB	Measure ment dBuV/m	Limit dBuV/m	Margin dB	Detector	Comment
1	2390.0000	32.99	33.25	66.24	74.00	-7.76	Peak	
2	2390.0000	18.60	33.25	51.85	54.00	-2.15	AVG	
3	2413.8000	76.89	33.32	110.21	74.00	36.21	Peak	No limit
4 *	2419.4000	68.84	33.33	102.17	54.00	48.17	AVG	No limit

REMARKS:

- (1) Measurement Value = Reading Level + Correct Factor.
- (2) Margin Level = Measurement Value - Limit Value.

Test Mode: TX G Mode2412 MHz

Vertical

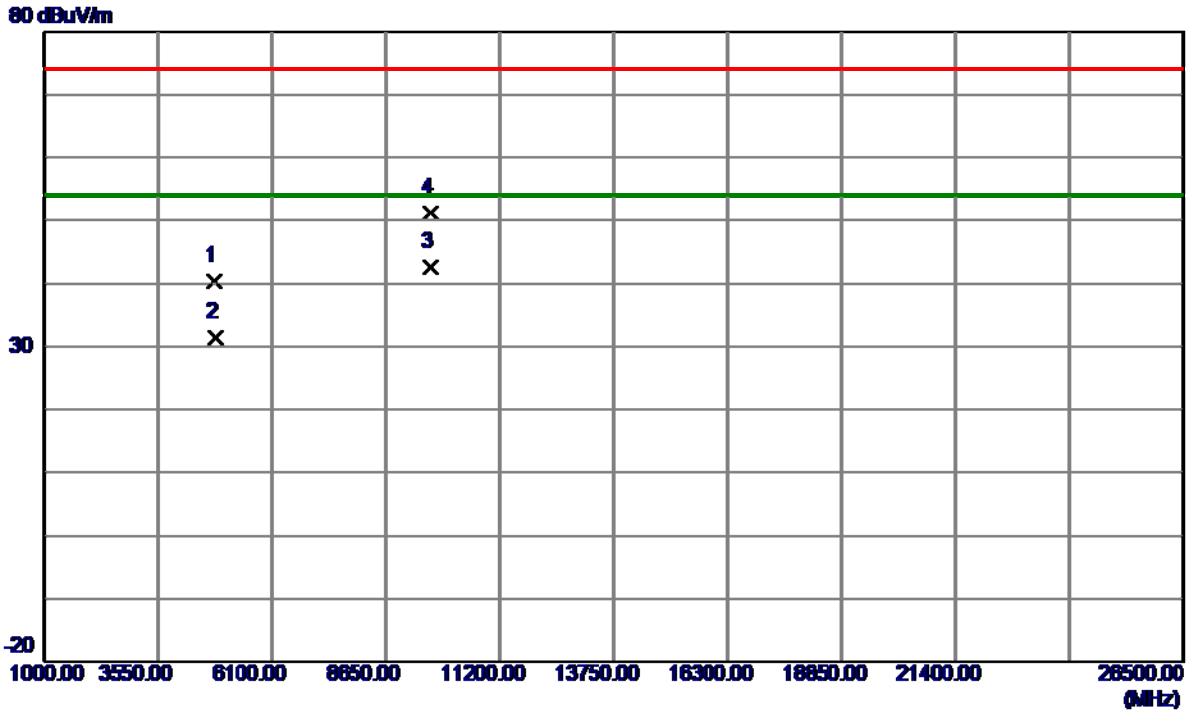

No.	Freq. MHz	Reading Level dBuV/m	Correct Factor dB	Measure ment dBuV/m	Limit dBuV/m	Margin dB	Detector	Comment
1	4800.2500	49.41	-9.09	40.32	74.00	-33.68	Peak	
2	4823.9000	40.38	-8.99	31.39	54.00	-22.61	AVG	
3 *	9648.0500	40.96	1.56	42.52	54.00	-11.48	AVG	
4	9648.2750	49.64	1.56	51.20	74.00	-22.80	Peak	

REMARKS:

- (1) Measurement Value = Reading Level + Correct Factor.
- (2) Margin Level = Measurement Value - Limit Value.

Test Mode: TX G Mode2412 MHz

Horizontal

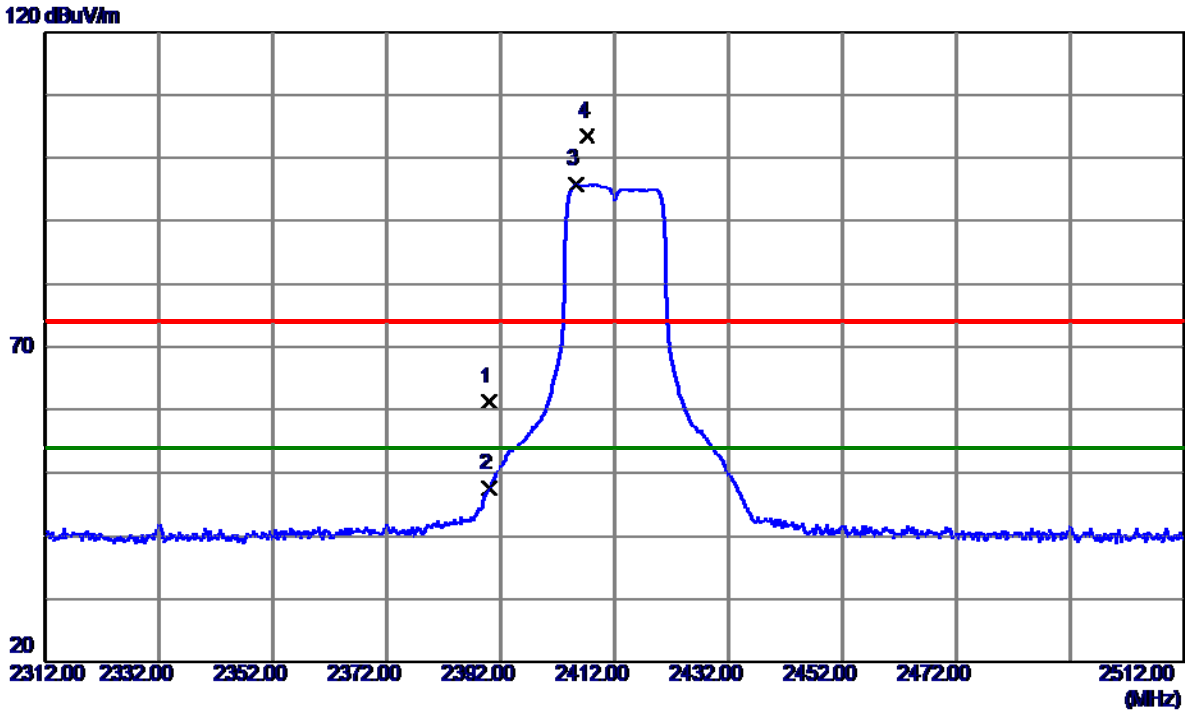

No.	Freq. MHz	Reading Level dBuV/m	Correct Factor dB	Measure ment dBuV/m	Limit dBuV/m	Margin dB	Detector	Comment
1	2390.0000	27.88	33.25	61.13	74.00	-12.87	Peak	
2	2390.0000	14.40	33.25	47.65	54.00	-6.35	AVG	
3 *	2405.2000	62.51	33.29	95.80	54.00	41.80	AVG	No limit
4	2407.2000	70.04	33.30	103.34	74.00	29.34	Peak	No limit

REMARKS:

- (1) Measurement Value = Reading Level + Correct Factor.
- (2) Margin Level = Measurement Value - Limit Value.

Test Mode: TX G Mode2412 MHz

Horizontal

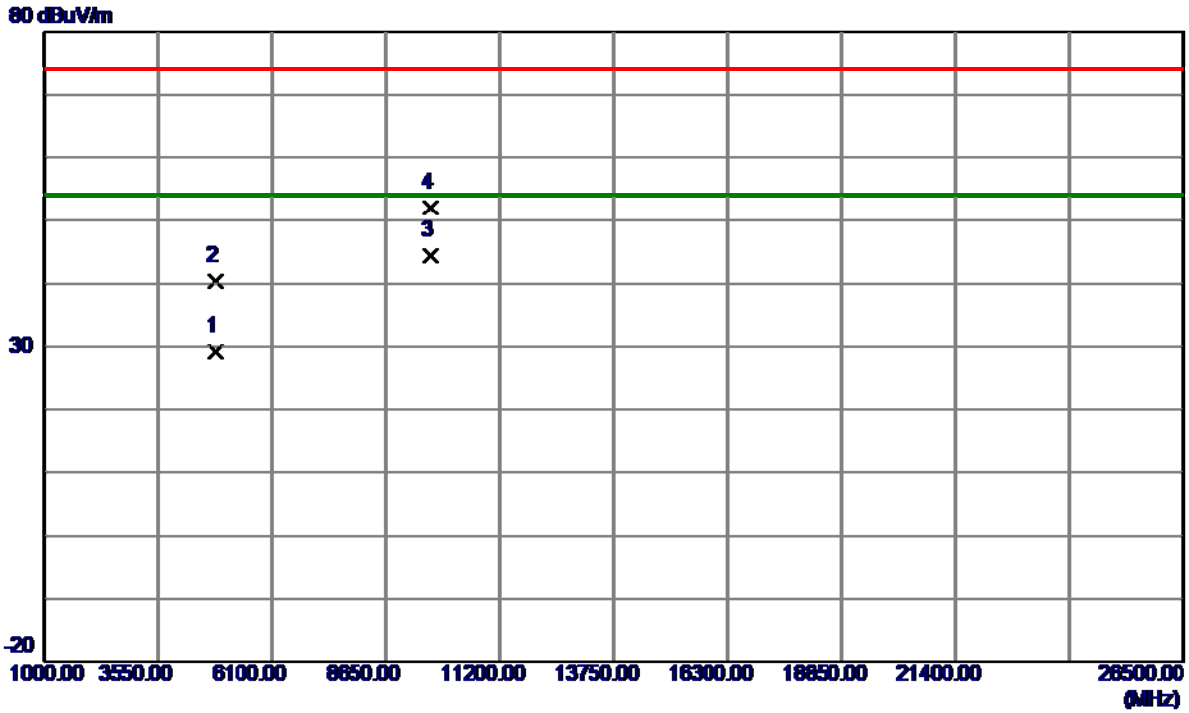

No.	Freq. MHz	Reading Level dBuV/m	Correct Factor dB	Measure ment dBuV/m	Limit dBuV/m	Margin dB	Detector	Comment
1	4824.1000	38.24	-8.99	29.25	54.00	-24.75	AVG	
2	4838.7500	49.40	-8.94	40.46	74.00	-33.54	Peak	
3 *	9648.0750	42.82	1.56	44.38	54.00	-9.62	AVG	
4	9648.2950	50.50	1.56	52.06	74.00	-21.94	Peak	

REMARKS:

(1) Measurement Value = Reading Level + Correct Factor.

(2) Margin Level = Measurement Value - Limit Value.

Test Mode: TX G Mode2437 MHz

Vertical

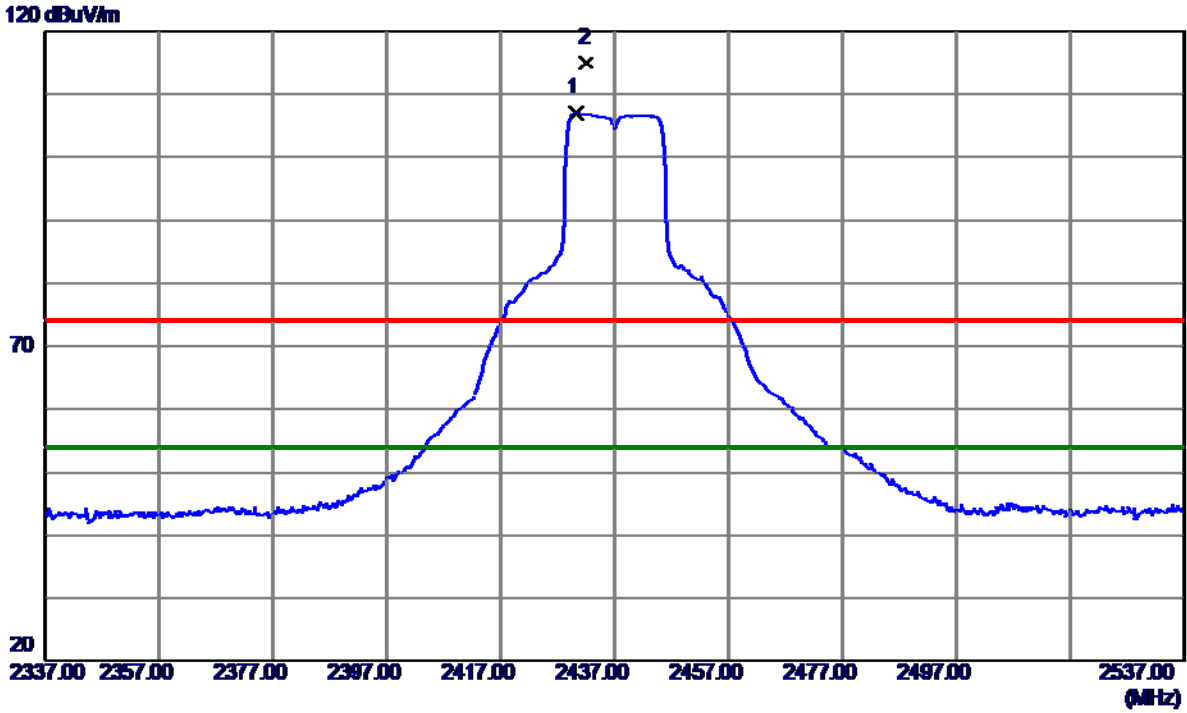

No.	Freq. MHz	Reading Level dBuV/m	Correct Factor dB	Measure ment dBuV/m	Limit dBuV/m	Margin dB	Detector	Comment
1 *	2430.2000	73.70	33.36	107.06	54.00	53.06	AVG	No limit
2	2432.0000	81.55	33.37	114.92	74.00	40.92	Peak	No limit

REMARKS:

- (1) Measurement Value = Reading Level + Correct Factor.
- (2) Margin Level = Measurement Value - Limit Value.

Test Mode: TX G Mode2437 MHz

Vertical

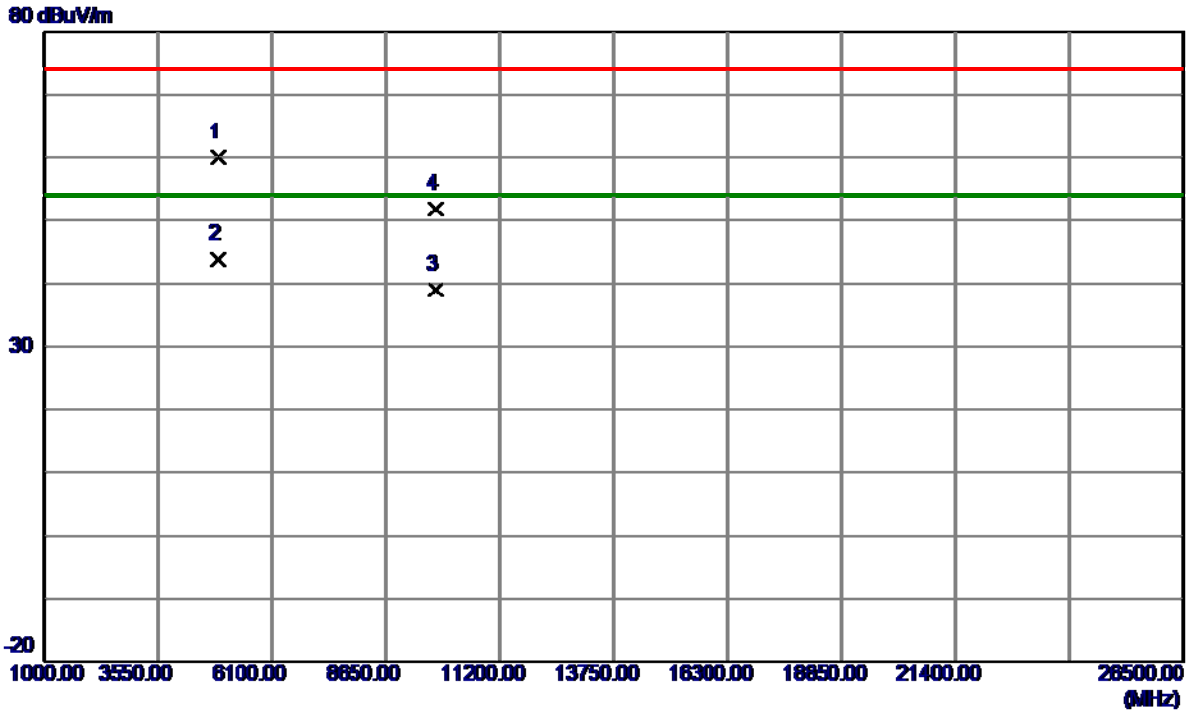

No.	Freq. MHz	Reading Level dBuV/m	Correct Factor dB	Measure ment dBuV/m	Limit dBuV/m	Margin dB	Detector	Comment
1	4873.8000	68.72	-8.80	59.92	74.00	-14.08	Peak	
2 *	4874.0000	52.67	-8.80	43.87	54.00	-10.13	AVG	
3	9747.9500	37.09	1.89	38.98	54.00	-15.02	AVG	
4	9750.4500	49.97	1.89	51.86	74.00	-22.14	Peak	

REMARKS:

- (1) Measurement Value = Reading Level + Correct Factor.
- (2) Margin Level = Measurement Value - Limit Value.

Test Mode: TX G Mode2437 MHz

Horizontal

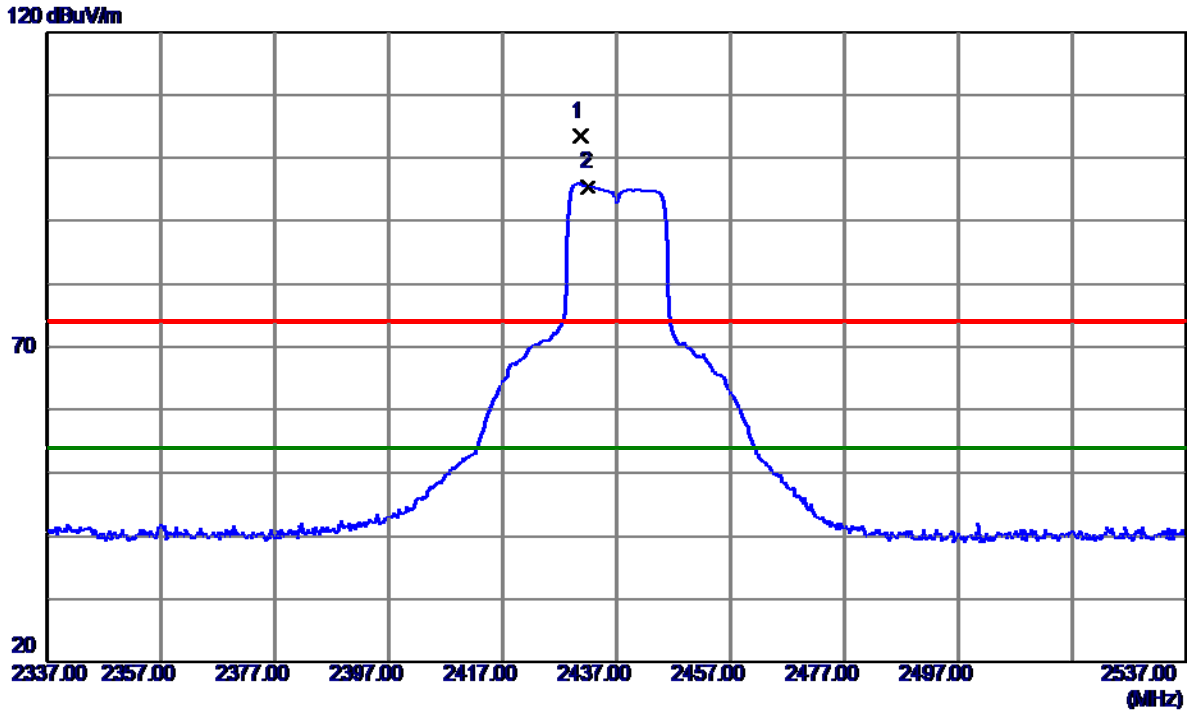

No.	Freq. MHz	Reading Level dBuV/m	Correct Factor dB	Measure ment dBuV/m	Limit dBuV/m	Margin dB	Detector	Comment
1	2430.6000	69.98	33.36	103.34	74.00	29.34	Peak	No limit
2 *	2432.0000	62.12	33.37	95.49	54.00	41.49	AVG	No limit

REMARKS:

- (1) Measurement Value = Reading Level + Correct Factor.
- (2) Margin Level = Measurement Value - Limit Value.

Test Mode: TX G Mode2437 MHz

Horizontal

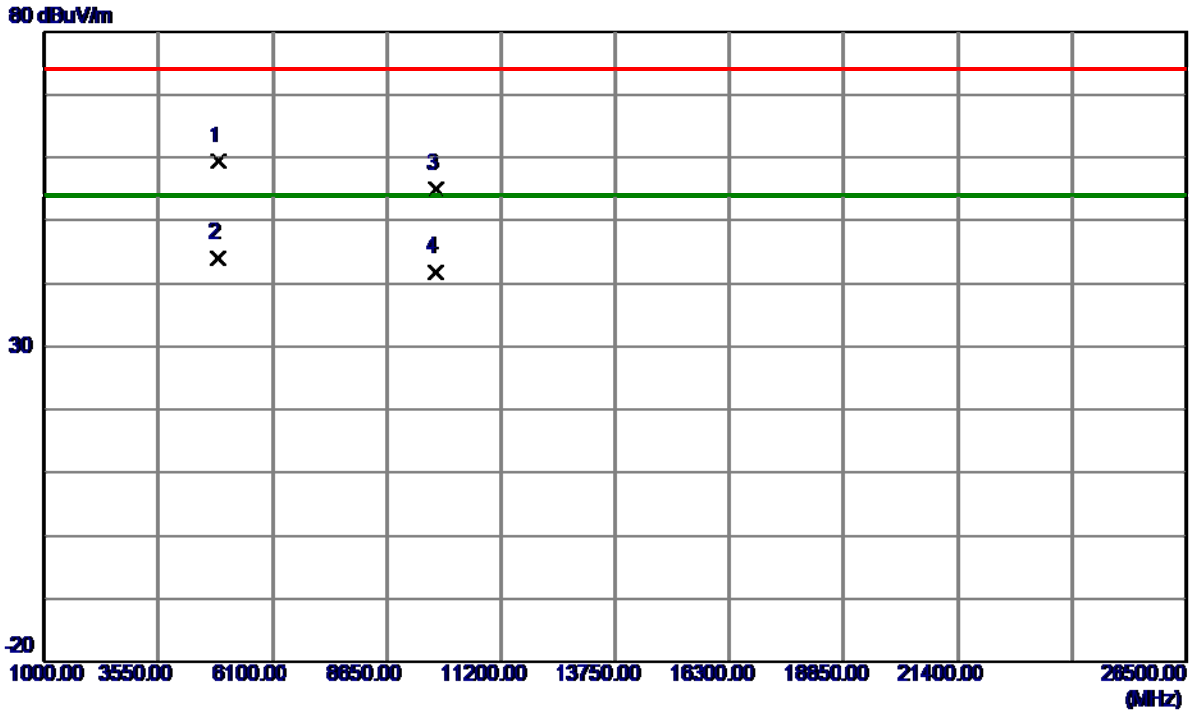

No.	Freq. MHz	Reading Level dBuV/m	Correct Factor dB	Measure ment dBuV/m	Limit dBuV/m	Margin dB	Detector	Comment
1	4873.3000	68.28	-8.80	59.48	74.00	-14.52	Peak	
2 *	4873.8000	52.74	-8.80	43.94	54.00	-10.06	AVG	
3	9747.9400	53.14	1.89	55.03	74.00	-18.97	Peak	
4	9747.9400	39.99	1.89	41.88	54.00	-12.12	AVG	

REMARKS:

(1) Measurement Value = Reading Level + Correct Factor.

(2) Margin Level = Measurement Value - Limit Value.

Test Mode: TX G Mode 2462 MHz

Vertical

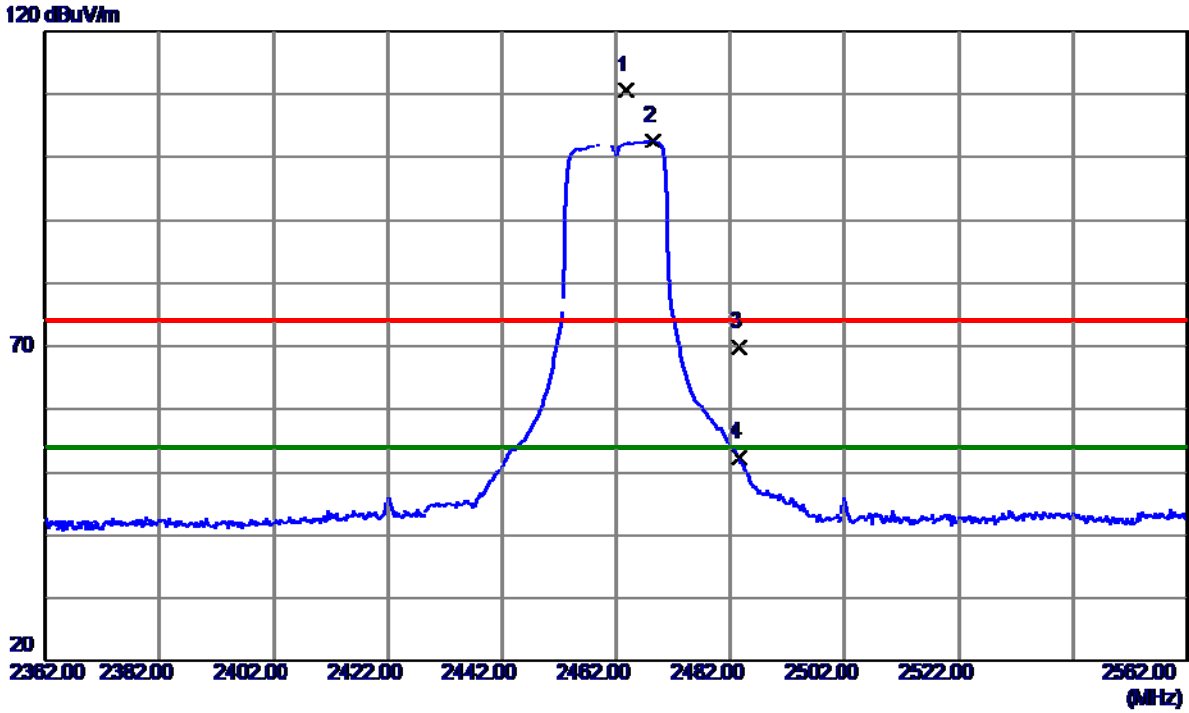

No.	Freq. MHz	Reading Level dBuV/m	Correct Factor dB	Measure ment dBuV/m	Limit dBuV/m	Margin dB	Detector	Comment
1	2463.8000	77.12	33.46	110.58	74.00	36.58	Peak	No limit
2 *	2468.4000	69.06	33.47	102.53	54.00	48.53	AVG	No limit
3	2483.5000	36.20	33.51	69.71	74.00	-4.29	Peak	
4	2483.5000	18.85	33.51	52.36	54.00	-1.64	AVG	

REMARKS:

(1) Measurement Value = Reading Level + Correct Factor.

(2) Margin Level = Measurement Value - Limit Value.

Test Mode: TX G Mode2462 MHz

Vertical

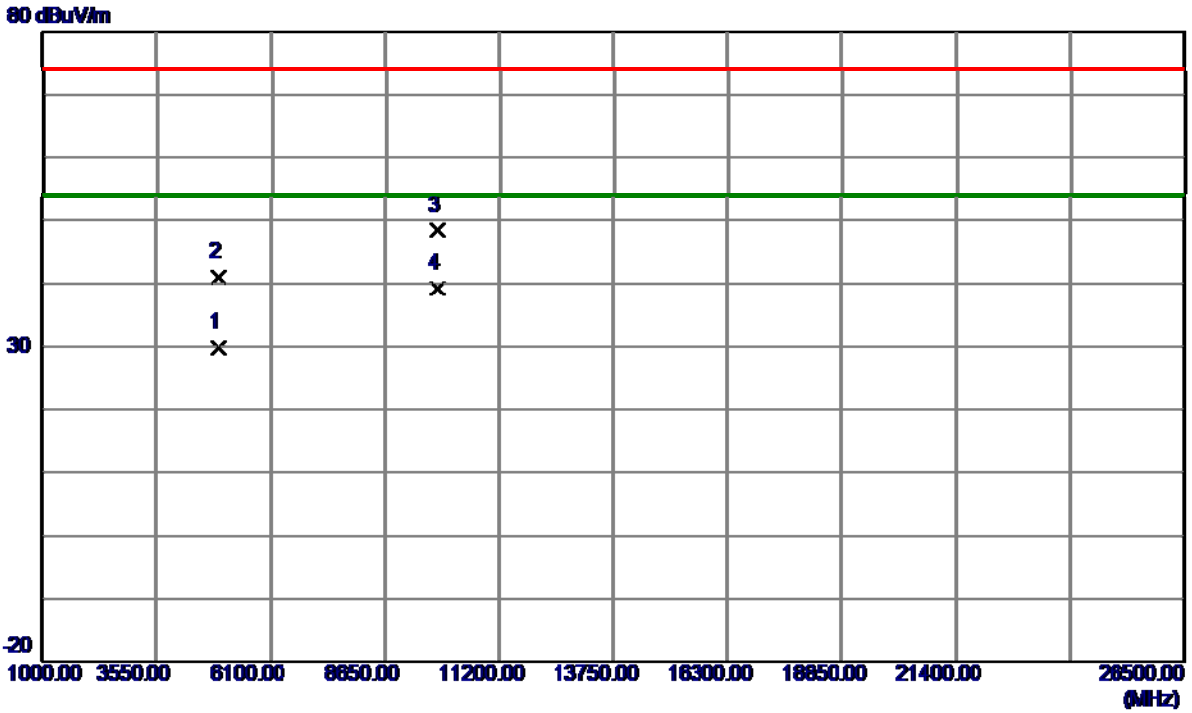

No.	Freq. MHz	Reading Level dBuV/m	Correct Factor dB	Measure ment dBuV/m	Limit dBuV/m	Margin dB	Detector	Comment
1	4924.2300	38.36	-8.60	29.76	54.00	-24.24	AVG	
2	4925.9700	49.58	-8.60	40.98	74.00	-33.02	Peak	
3	9847.5599	46.24	2.21	48.45	74.00	-25.55	Peak	
4 *	9847.8700	37.07	2.21	39.28	54.00	-14.72	AVG	

REMARKS:

- (1) Measurement Value = Reading Level + Correct Factor.
- (2) Margin Level = Measurement Value - Limit Value.

Test Mode: TX G Mode2462 MHz

Horizontal

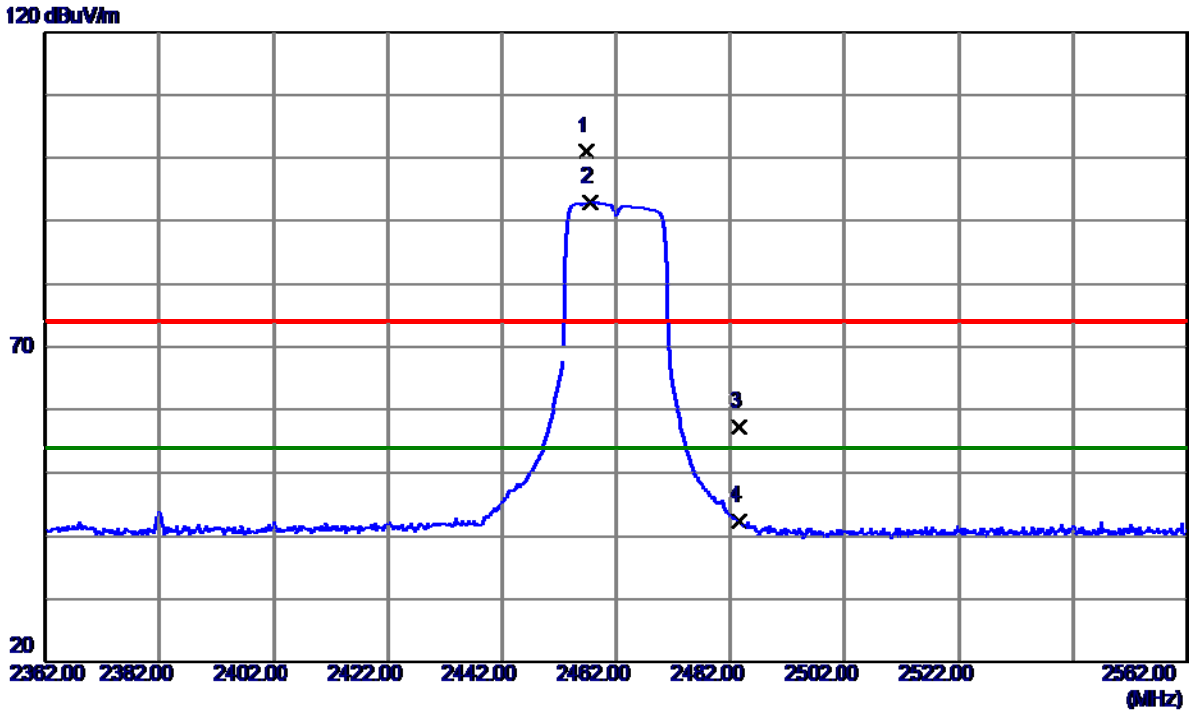

No.	Freq. MHz	Reading Level dBuV/m	Correct Factor dB	Measure ment dBuV/m	Limit dBuV/m	Margin dB	Detector	Comment
1	2456.8000	67.56	33.44	101.00	74.00	27.00	Peak	No limit
2 *	2457.6000	59.50	33.44	92.94	54.00	38.94	AVG	No limit
3	2483.5000	23.75	33.51	57.26	74.00	-16.74	Peak	
4	2483.5000	8.87	33.51	42.38	54.00	-11.62	AVG	

REMARKS:

- (1) Measurement Value = Reading Level + Correct Factor.
- (2) Margin Level = Measurement Value - Limit Value.

Test Mode: TX G Mode2462 MHz

Horizontal

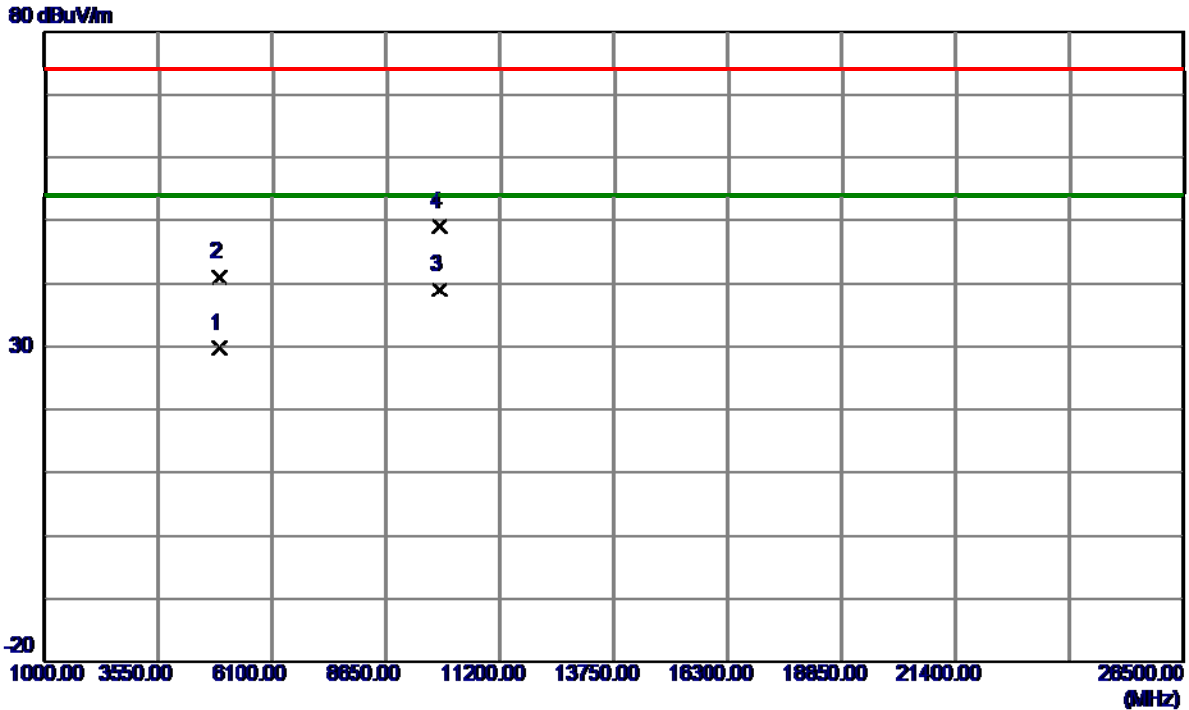

No.	Freq. MHz	Reading Level dBuV/m	Correct Factor dB	Measure ment dBuV/m	Limit dBuV/m	Margin dB	Detector	Comment
1	4923.6000	38.31	-8.61	29.70	54.00	-24.30	AVG	
2	4923.9800	49.64	-8.60	41.04	74.00	-32.96	Peak	
3 *	9847.9100	36.83	2.21	39.04	54.00	-14.96	AVG	
4	9848.1800	46.70	2.21	48.91	74.00	-25.09	Peak	

REMARKS:

(1) Measurement Value = Reading Level + Correct Factor.

(2) Margin Level = Measurement Value - Limit Value.

Test Mode: TX N-20M Mode2412 MHz

Vertical

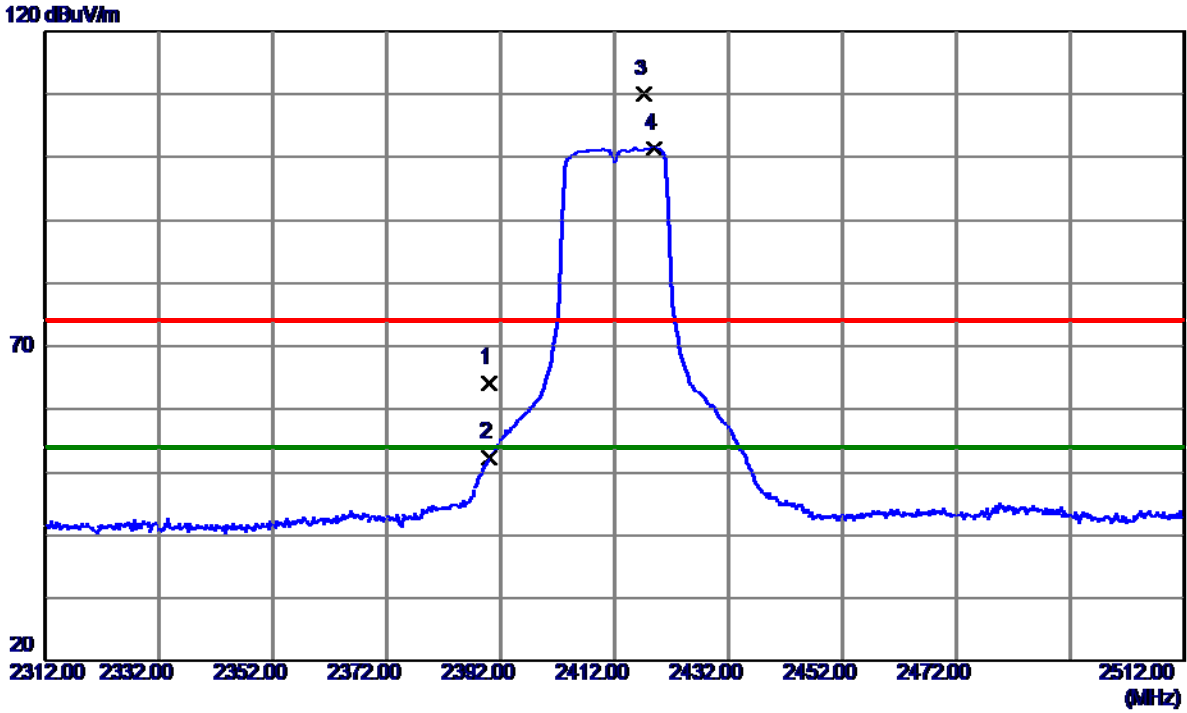

No.	Freq. MHz	Reading Level dBuV/m	Correct Factor dB	Measure ment dBuV/m	Limit dBuV/m	Margin dB	Detector	Comment
1	2390.0000	30.97	33.25	64.22	74.00	-9.78	Peak	
2	2390.0000	19.22	33.25	52.47	54.00	-1.53	AVG	
3	2417.2000	76.68	33.32	110.00	74.00	36.00	Peak	No limit
4 *	2418.8000	68.11	33.33	101.44	54.00	47.44	AVG	No limit

REMARKS:

(1) Measurement Value = Reading Level + Correct Factor.

(2) Margin Level = Measurement Value - Limit Value.

Test Mode: TX N-20M Mode2412 MHz

Vertical

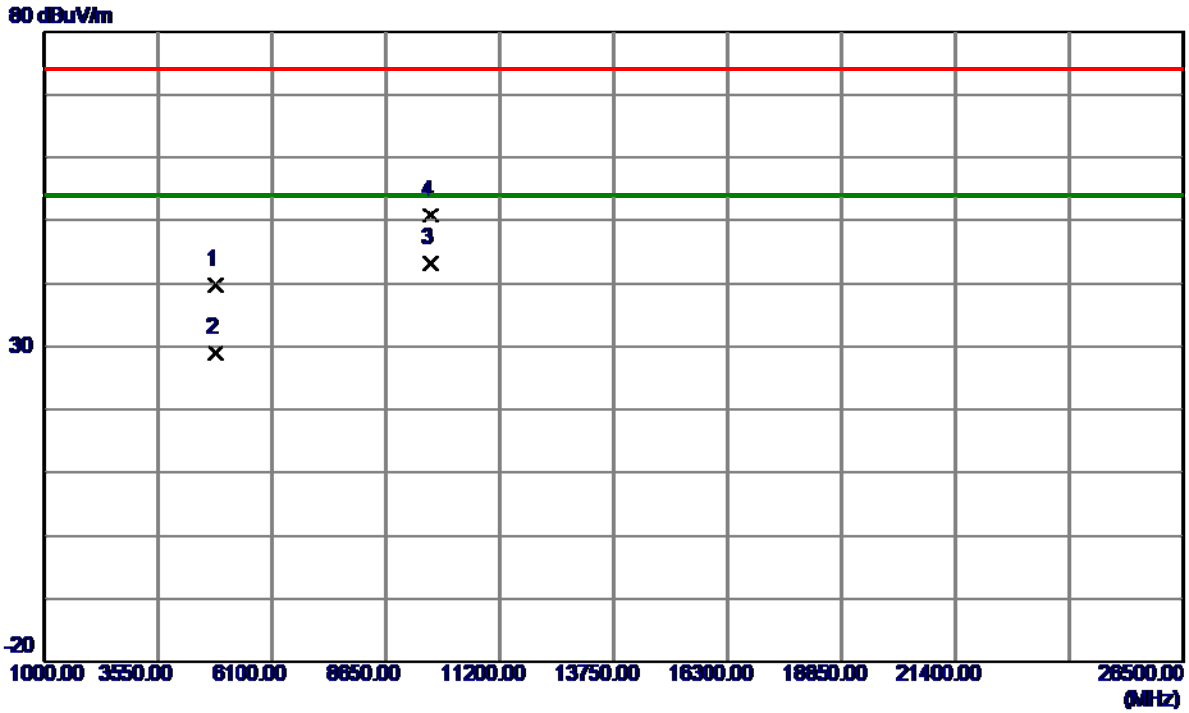

No.	Freq. MHz	Reading Level dBuV/m	Correct Factor dB	Measure ment dBuV/m	Limit dBuV/m	Margin dB	Detector	Comment
1	4825.0500	48.80	-8.99	39.81	74.00	-34.19	Peak	
2	4831.3500	38.00	-8.96	29.04	54.00	-24.96	AVG	
3 *	9648.0550	41.56	1.56	43.12	54.00	-10.88	AVG	
4	9648.4400	49.32	1.56	50.88	74.00	-23.12	Peak	

REMARKS:

- (1) Measurement Value = Reading Level + Correct Factor.
- (2) Margin Level = Measurement Value - Limit Value.

Test Mode: TX N-20M Mode2412 MHz

Horizontal

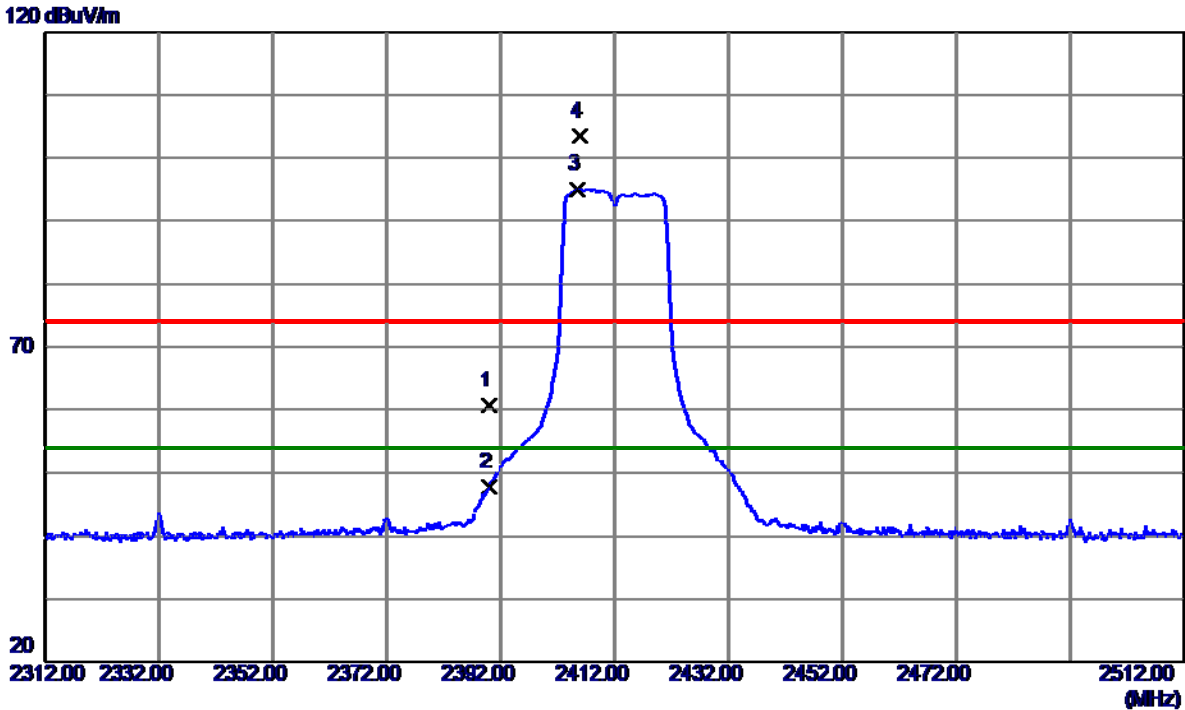

No.	Freq. MHz	Reading Level dBuV/m	Correct Factor dB	Measure ment dBuV/m	Limit dBuV/m	Margin dB	Detector	Comment
1	2390.0000	27.33	33.25	60.58	74.00	-13.42	Peak	
2	2390.0000	14.59	33.25	47.84	54.00	-6.16	AVG	
3 *	2405.4000	61.69	33.29	94.98	54.00	40.98	AVG	No limit
4	2405.8000	70.02	33.29	103.31	74.00	29.31	Peak	No limit

REMARKS:

- (1) Measurement Value = Reading Level + Correct Factor.
- (2) Margin Level = Measurement Value - Limit Value.

Test Mode: TX N-20M Mode2412 MHz

Horizontal

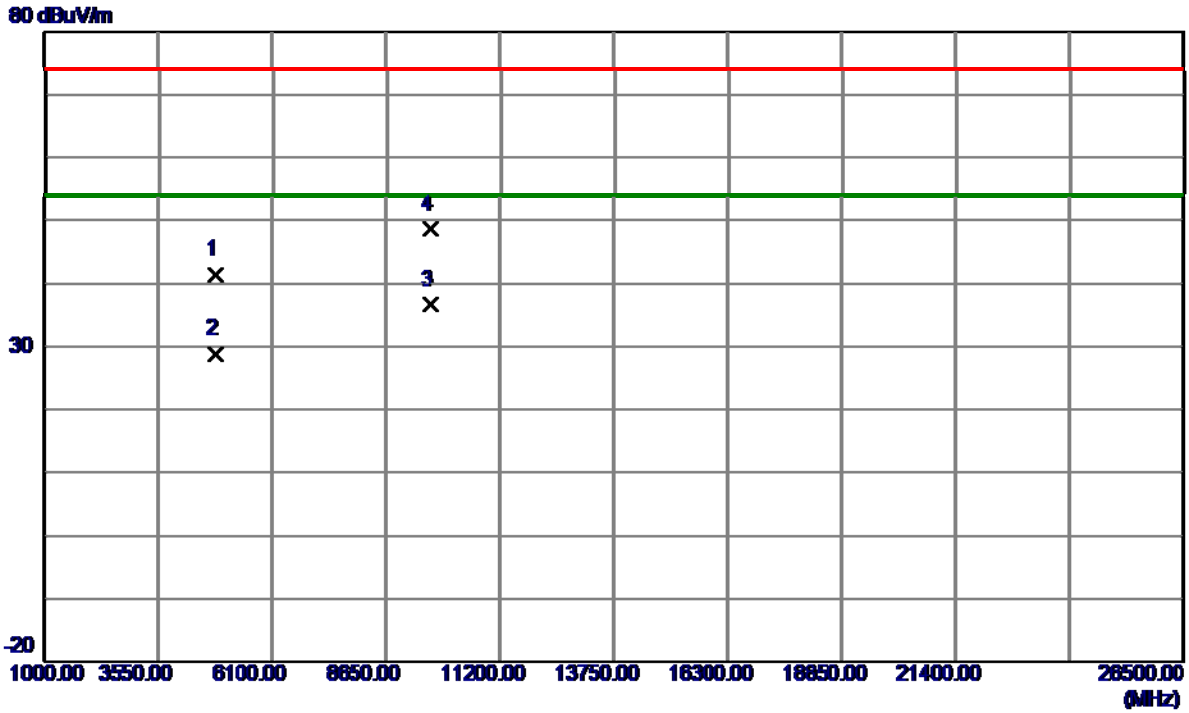

No.	Freq. MHz	Reading Level dBuV/m	Correct Factor dB	Measure ment dBuV/m	Limit dBuV/m	Margin dB	Detector	Comment
1	4822.1800	50.44	-9.00	41.44	74.00	-32.56	Peak	
2	4822.6600	37.85	-9.00	28.85	54.00	-25.15	AVG	
3 *	9648.1600	34.95	1.56	36.51	54.00	-17.49	AVG	
4	9649.0900	46.98	1.56	48.54	74.00	-25.46	Peak	

REMARKS:

- (1) Measurement Value = Reading Level + Correct Factor.
- (2) Margin Level = Measurement Value - Limit Value.

Test Mode: TX N-20M Mode2437 MHz

Vertical

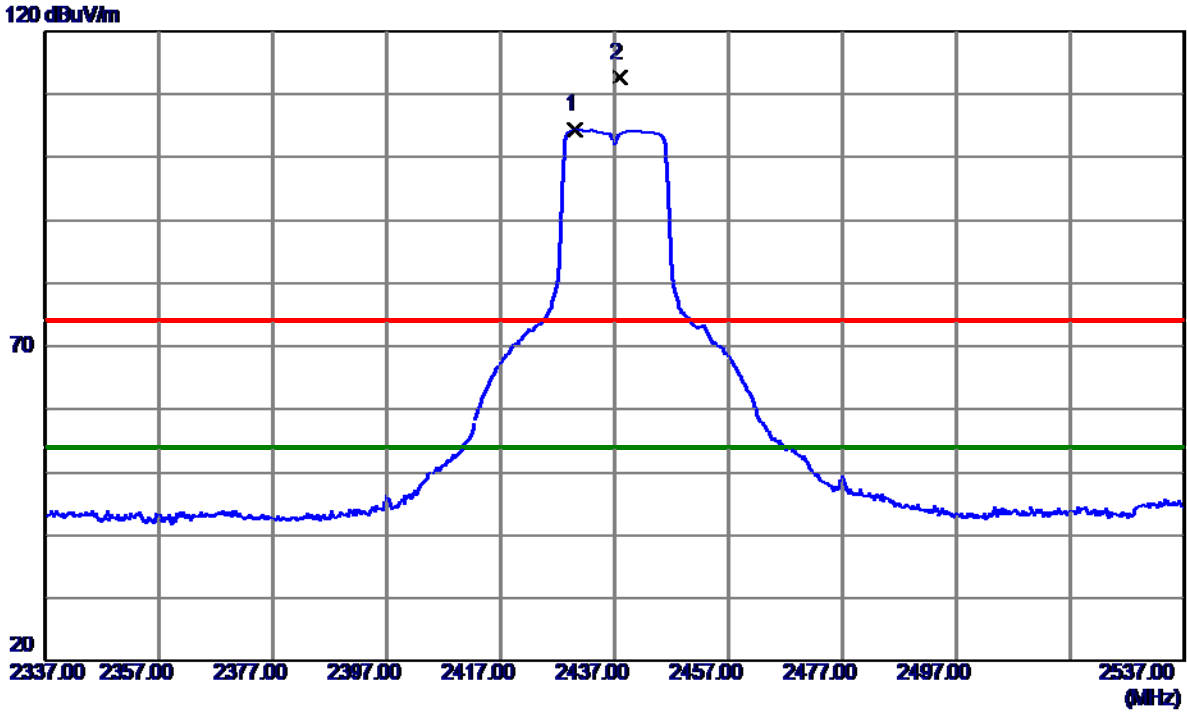

No.	Freq. MHz	Reading Level dBuV/m	Correct Factor dB	Measure ment dBuV/m	Limit dBuV/m	Margin dB	Detector	Comment
1 *	2429.8000	71.04	33.36	104.40	54.00	50.40	AVG	No limit
2	2437.8000	79.18	33.38	112.56	74.00	38.56	Peak	No limit

REMARKS:

- (1) Measurement Value = Reading Level + Correct Factor.
- (2) Margin Level = Measurement Value - Limit Value.

Test Mode: TX N-20M Mode2437 MHz

Vertical

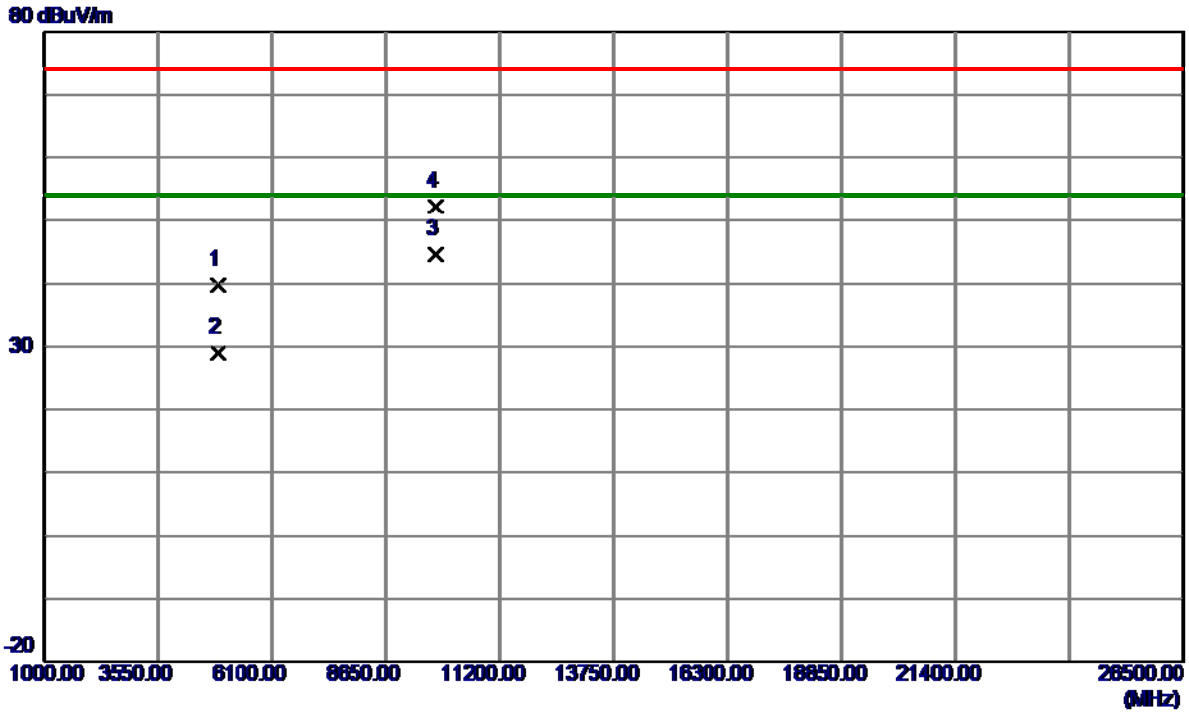

No.	Freq. MHz	Reading Level dBuV/m	Correct Factor dB	Measure ment dBuV/m	Limit dBuV/m	Margin dB	Detector	Comment
1	4881.0200	48.63	-8.77	39.86	74.00	-34.14	Peak	
2	4882.3800	37.84	-8.77	29.07	54.00	-24.93	AVG	
3 *	9748.0500	42.67	1.89	44.56	54.00	-9.44	AVG	
4	9748.2800	50.33	1.89	52.22	74.00	-21.78	Peak	

REMARKS:

- (1) Measurement Value = Reading Level + Correct Factor.
- (2) Margin Level = Measurement Value - Limit Value.

Test Mode: TX N-20M Mode2437 MHz

Horizontal

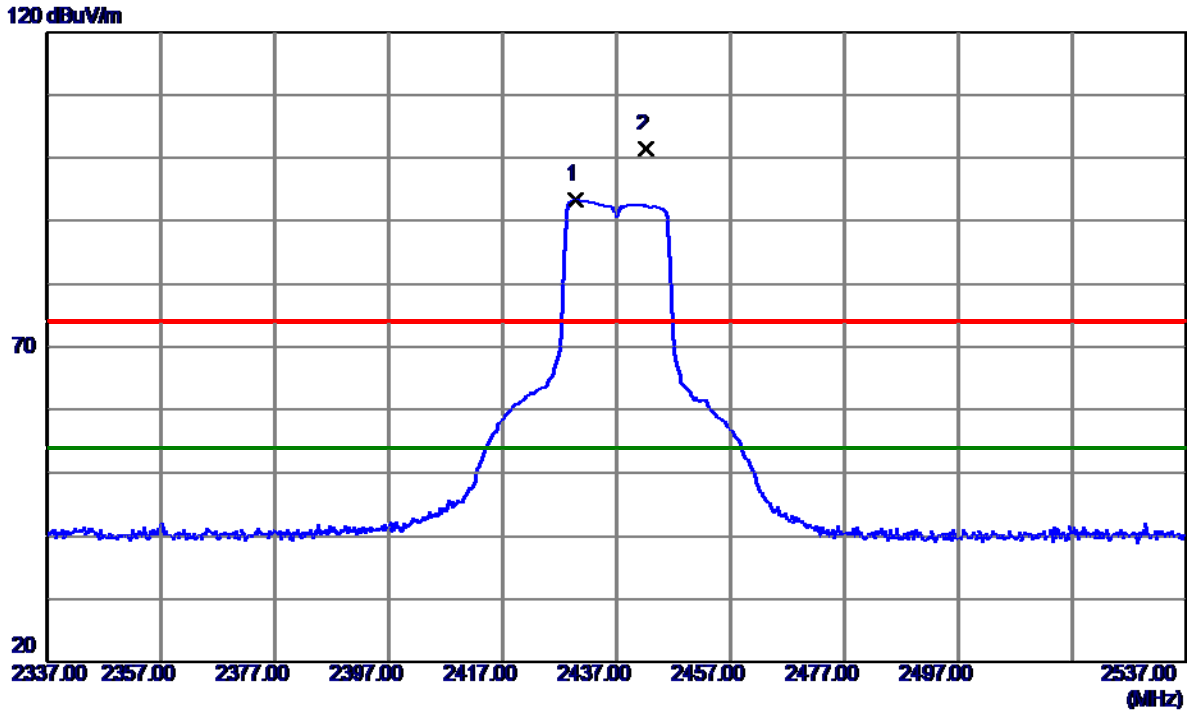

No.	Freq. MHz	Reading Level dBuV/m	Correct Factor dB	Measure ment dBuV/m	Limit dBuV/m	Margin dB	Detector	Comment
1 *	2429.6000	60.08	33.36	93.44	54.00	39.44	AVG	No limit
2	2442.2000	68.03	33.40	101.43	74.00	27.43	Peak	No limit

REMARKS:

- (1) Measurement Value = Reading Level + Correct Factor.
- (2) Margin Level = Measurement Value - Limit Value.

Test Mode: TX N-20M Mode2437 MHz

Horizontal

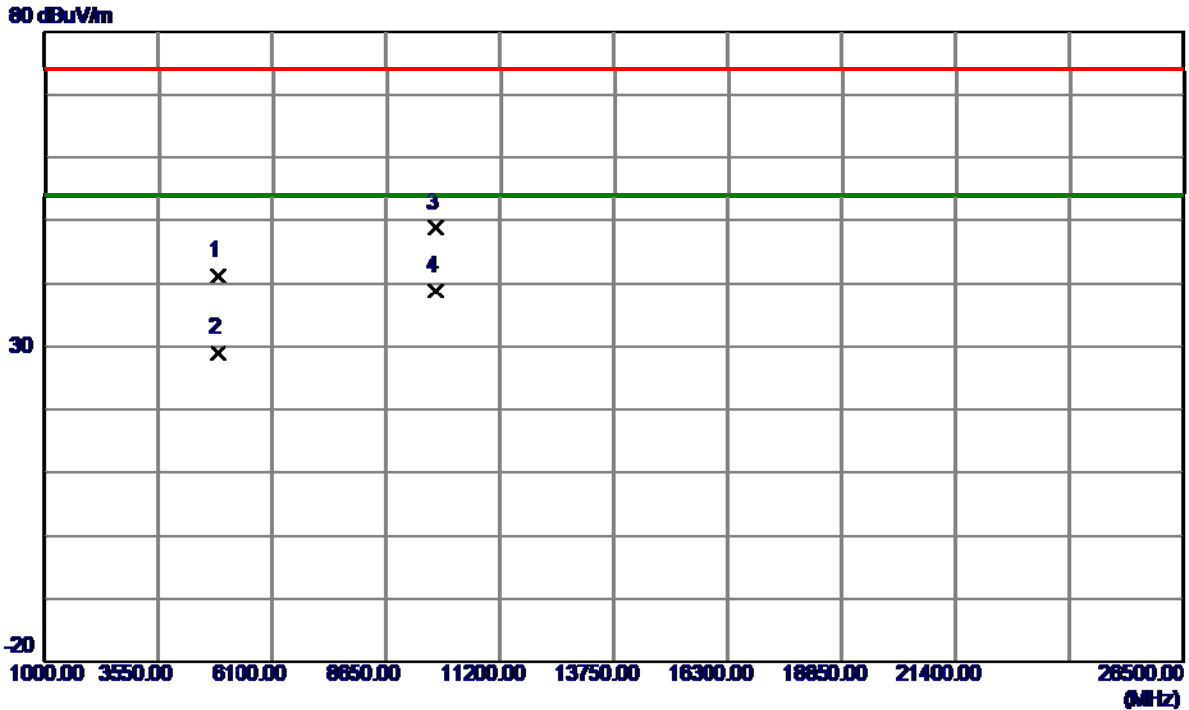

No.	Freq. MHz	Reading Level dBuV/m	Correct Factor dB	Measure ment dBuV/m	Limit dBuV/m	Margin dB	Detector	Comment
1	4878.7000	50.06	-8.78	41.28	74.00	-32.72	Peak	
2	4883.1400	37.80	-8.76	29.04	54.00	-24.96	AVG	
3	9747.5700	46.94	1.88	48.82	74.00	-25.18	Peak	
4 *	9748.0900	36.95	1.89	38.84	54.00	-15.16	AVG	

REMARKS:

- (1) Measurement Value = Reading Level + Correct Factor.
- (2) Margin Level = Measurement Value - Limit Value.

Test Mode: TX N-20M Mode2462 MHz

Vertical

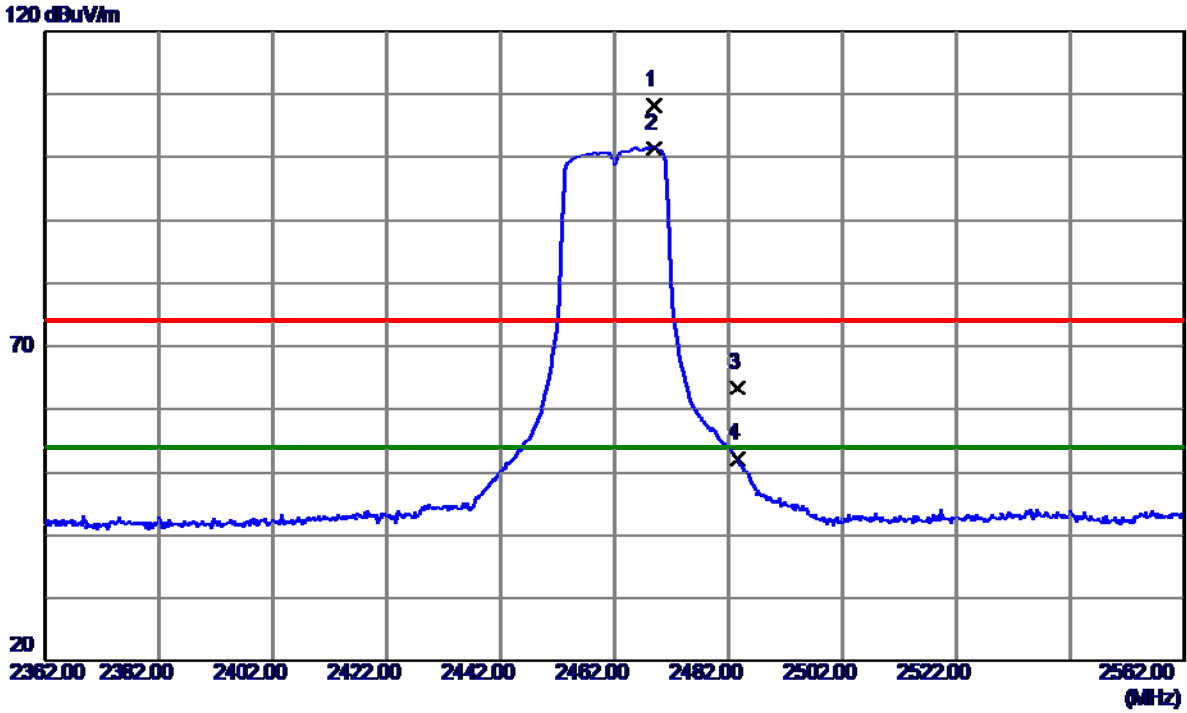

No.	Freq. MHz	Reading Level dBuV/m	Correct Factor dB	Measure ment dBuV/m	Limit dBuV/m	Margin dB	Detector	Comment
1	2468.8000	74.76	33.47	108.23	74.00	34.23	Peak	No limit
2 *	2468.8000	67.98	33.47	101.45	54.00	47.45	AVG	No limit
3	2483.5000	29.92	33.51	63.43	74.00	-10.57	Peak	
4	2483.5000	18.65	33.51	52.16	54.00	-1.84	AVG	

REMARKS:

(1) Measurement Value = Reading Level + Correct Factor.

(2) Margin Level = Measurement Value - Limit Value.

Test Mode: TX N-20M Mode2462 MHz

Vertical

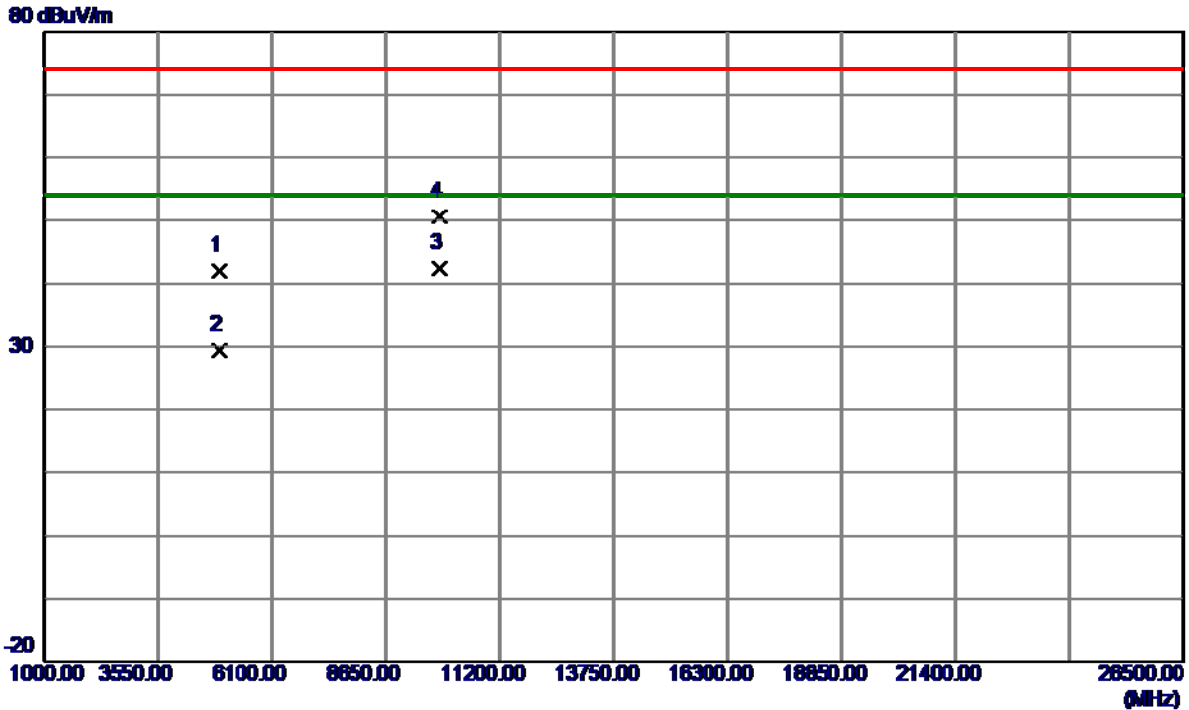

No.	Freq. MHz	Reading Level dBuV/m	Correct Factor dB	Measure ment dBuV/m	Limit dBuV/m	Margin dB	Detector	Comment
1	4922.0250	50.53	-8.61	41.92	74.00	-32.08	Peak	
2	4923.4900	38.03	-8.61	29.42	54.00	-24.58	AVG	
3 *	9848.0850	40.10	2.21	42.31	54.00	-11.69	AVG	
4	9848.1000	48.41	2.21	50.62	74.00	-23.38	Peak	

REMARKS:

- (1) Measurement Value = Reading Level + Correct Factor.
- (2) Margin Level = Measurement Value - Limit Value.

Test Mode: TX N-20M Mode2462 MHz

Horizontal

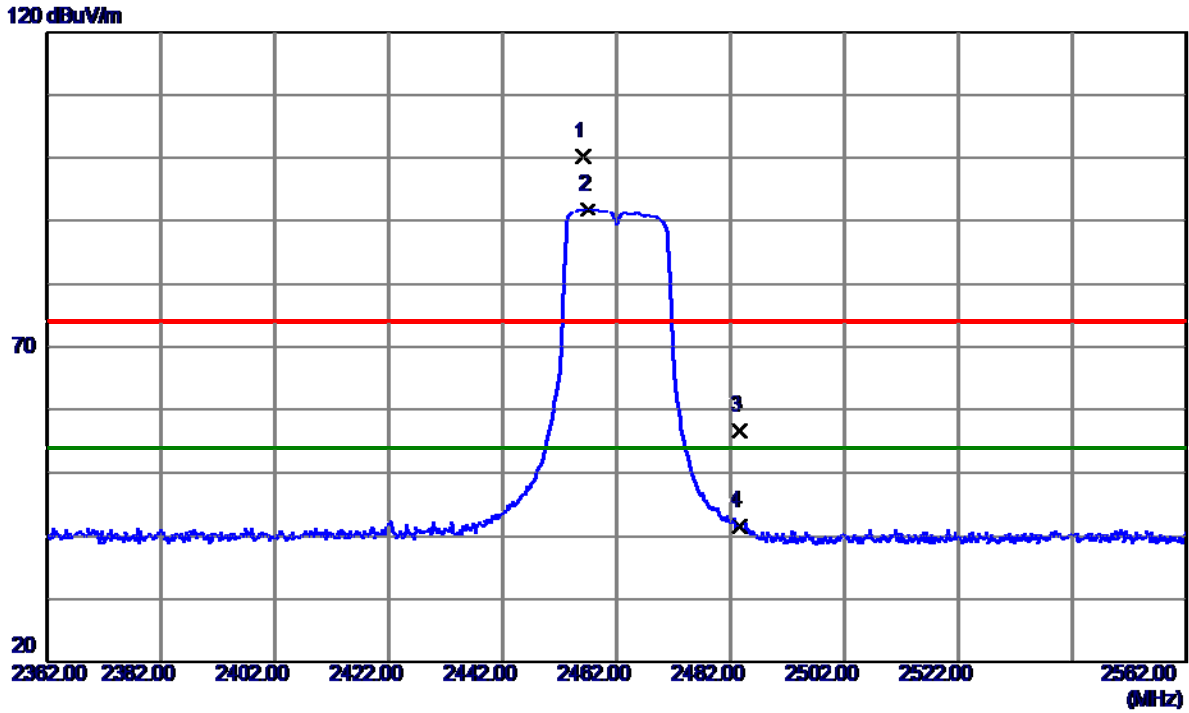

No.	Freq. MHz	Reading Level dBuV/m	Correct Factor dB	Measure ment dBuV/m	Limit dBuV/m	Margin dB	Detector	Comment
1 *	2456.0000	66.74	33.43	100.17	54.00	46.17	AVG	No limit
2	2456.8000	58.41	33.44	91.85	74.00	17.85	Peak	No limit
3	2483.5000	23.07	33.51	56.58	74.00	-17.42	Peak	
4	2483.5000	8.14	33.51	41.65	54.00	-12.35	AVG	

REMARKS:

- (1) Measurement Value = Reading Level + Correct Factor.
- (2) Margin Level = Measurement Value - Limit Value.

Test Mode: TX N-20M Mode2462 MHz

Horizontal

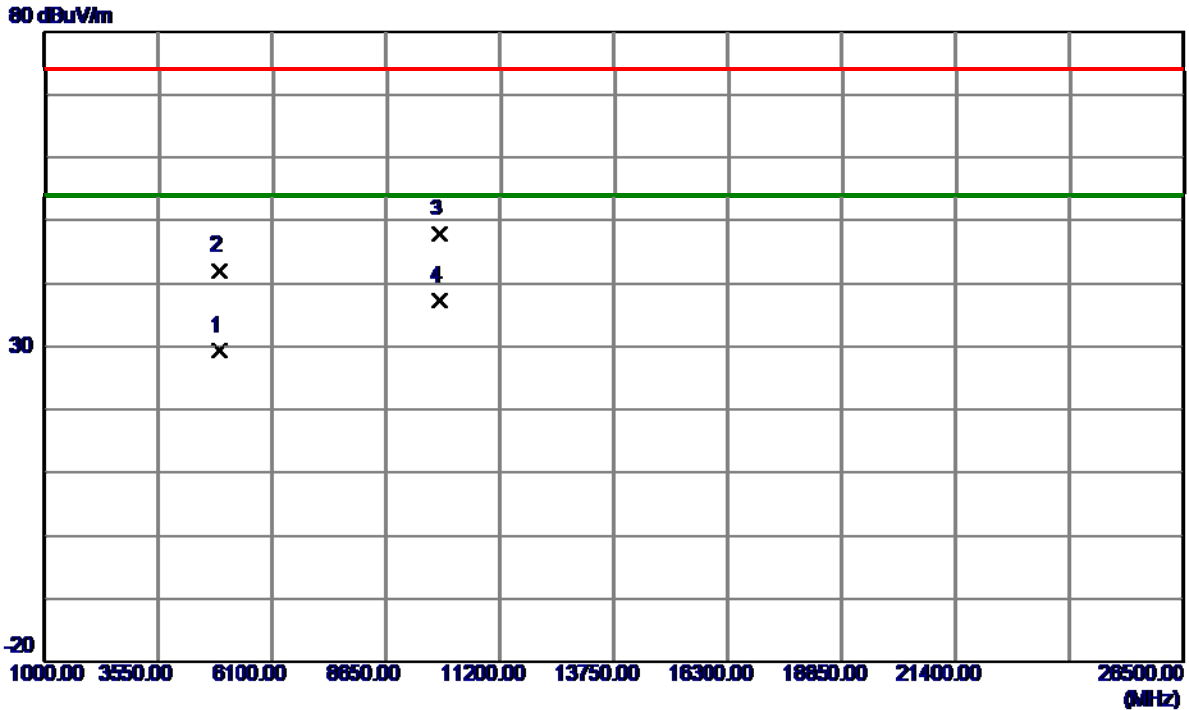

No.	Freq. MHz	Reading Level dBuV/m	Correct Factor dB	Measure ment dBuV/m	Limit dBuV/m	Margin dB	Detector	Comment
1	4921.8000	37.91	-8.61	29.30	54.00	-24.70	AVG	
2	4922.4700	50.56	-8.61	41.95	74.00	-32.05	Peak	
3	9843.6250	45.64	2.20	47.84	74.00	-26.16	Peak	
4 *	9847.8850	35.00	2.21	37.21	54.00	-16.79	AVG	

REMARKS:

- (1) Measurement Value = Reading Level + Correct Factor.
- (2) Margin Level = Measurement Value - Limit Value.

Test Mode: TX N-40M Mode 2422MHz

Vertical

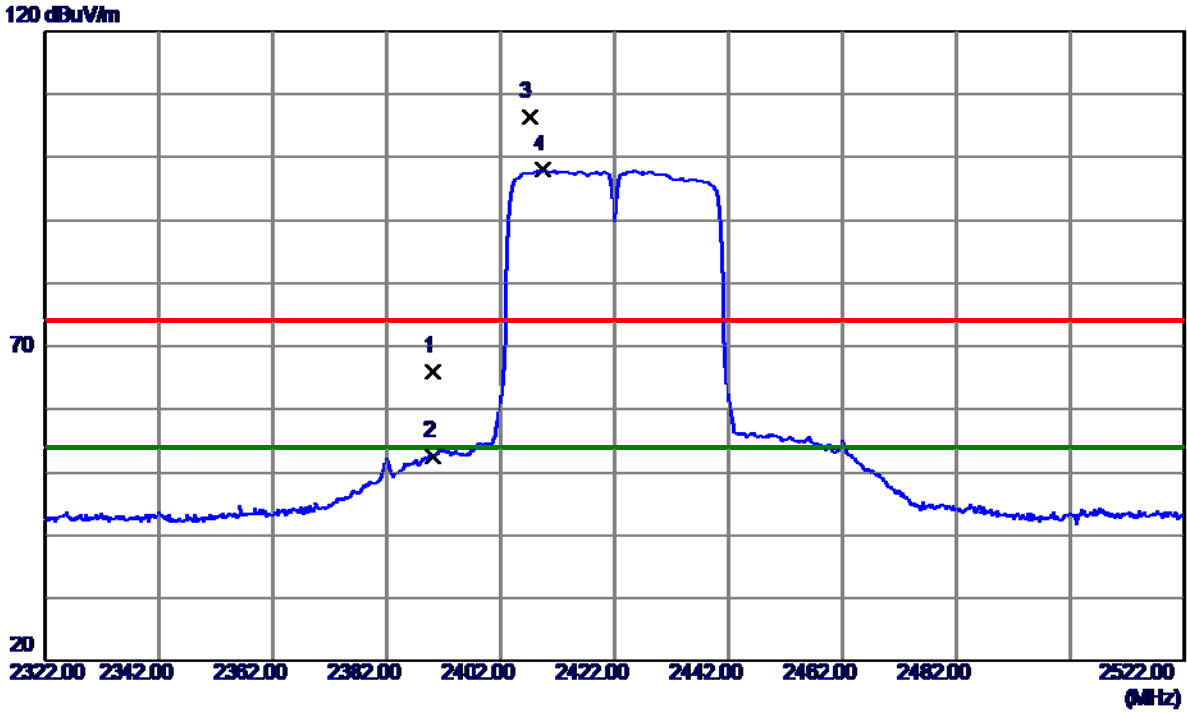

No.	Freq. MHz	Reading Level dBuV/m	Correct Factor dB	Measure ment dBuV/m	Limit dBuV/m	Margin dB	Detector	Comment
1	2390.0000	32.80	33.25	66.05	74.00	-7.95	Peak	
2	2390.0000	19.35	33.25	52.60	54.00	-1.40	AVG	
3	2407.0000	73.09	33.30	106.39	74.00	32.39	Peak	No limit
4 *	2409.4000	64.60	33.30	97.90	54.00	43.90	AVG	No limit

REMARKS:

(1) Measurement Value = Reading Level + Correct Factor.

(2) Margin Level = Measurement Value - Limit Value.

Test Mode: TX N-40M Mode 2422MHz

Vertical

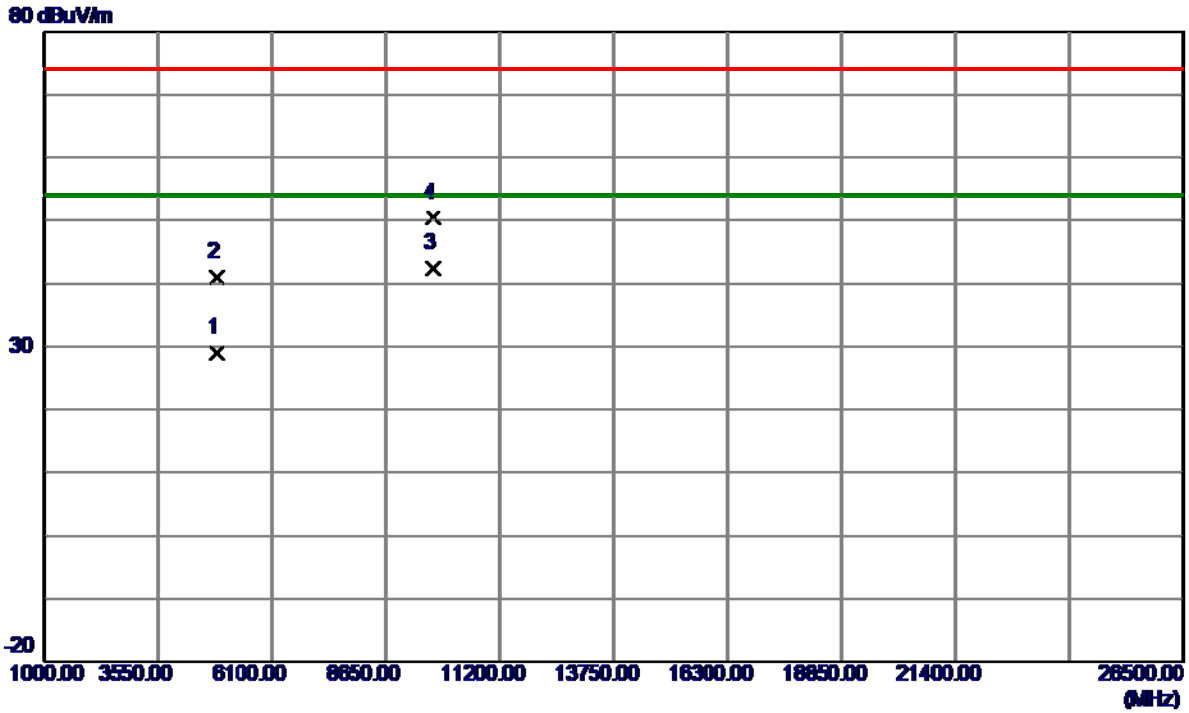

No.	Freq. MHz	Reading Level dBuV/m	Correct Factor dB	Measure ment dBuV/m	Limit dBuV/m	Margin dB	Detector	Comment
1	4842.0900	37.83	-8.92	28.91	54.00	-25.09	AVG	
2	4846.4850	49.95	-8.91	41.04	74.00	-32.96	Peak	
3 *	9688.0450	40.62	1.69	42.31	54.00	-11.69	AVG	
4	9688.4000	48.78	1.69	50.47	74.00	-23.53	Peak	

REMARKS:

- (1) Measurement Value = Reading Level + Correct Factor.
- (2) Margin Level = Measurement Value - Limit Value.

Test Mode: TX N-40M Mode 2422MHz

Horizontal

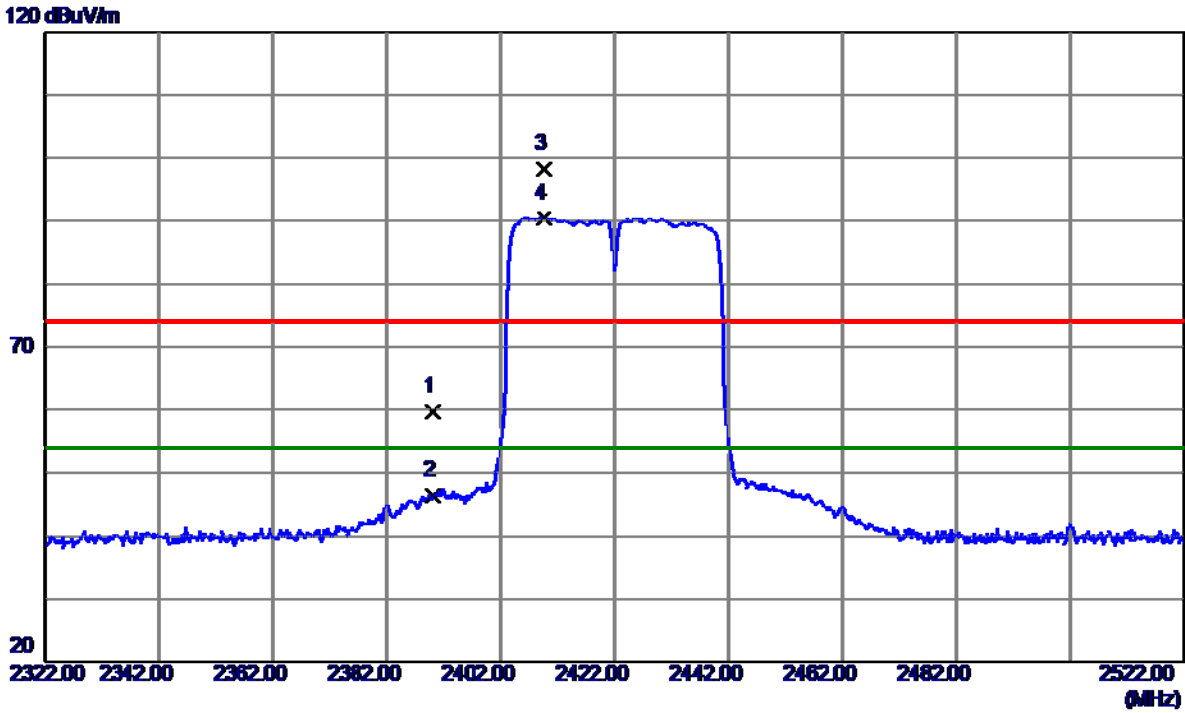

No.	Freq. MHz	Reading Level dBuV/m	Correct Factor dB	Measure ment dBuV/m	Limit dBuV/m	Margin dB	Detector	Comment
1	2390.0000	26.40	33.25	59.65	74.00	-14.35	Peak	
2	2390.0000	13.22	33.25	46.47	54.00	-7.53	AVG	
3	2409.6000	64.85	33.30	98.15	74.00	24.15	Peak	No limit
4 *	2409.6000	57.19	33.30	90.49	54.00	36.49	AVG	No limit

REMARKS:

- (1) Measurement Value = Reading Level + Correct Factor.
- (2) Margin Level = Measurement Value - Limit Value.

Test Mode: TX N-40M Mode 2422MHz

Horizontal

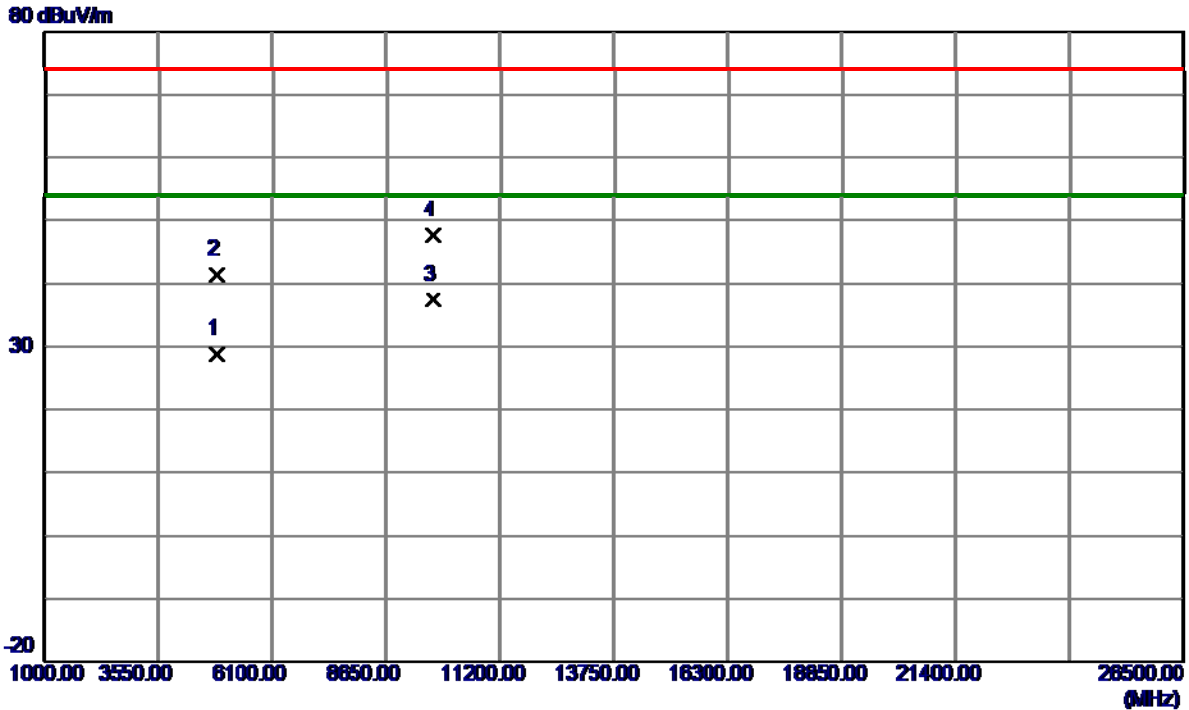

No.	Freq. MHz	Reading Level dBuV/m	Correct Factor dB	Measure ment dBuV/m	Limit dBuV/m	Margin dB	Detector	Comment
1	4841.7350	37.71	-8.92	28.79	54.00	-25.21	AVG	
2	4845.7150	50.27	-8.91	41.36	74.00	-32.64	Peak	
3 *	9688.1250	35.68	1.69	37.37	54.00	-16.63	AVG	
4	9697.3050	45.89	1.72	47.61	74.00	-26.39	Peak	

REMARKS:

- (1) Measurement Value = Reading Level + Correct Factor.
- (2) Margin Level = Measurement Value - Limit Value.

Test Mode: TX N-40M Mode2437 MHz

Vertical

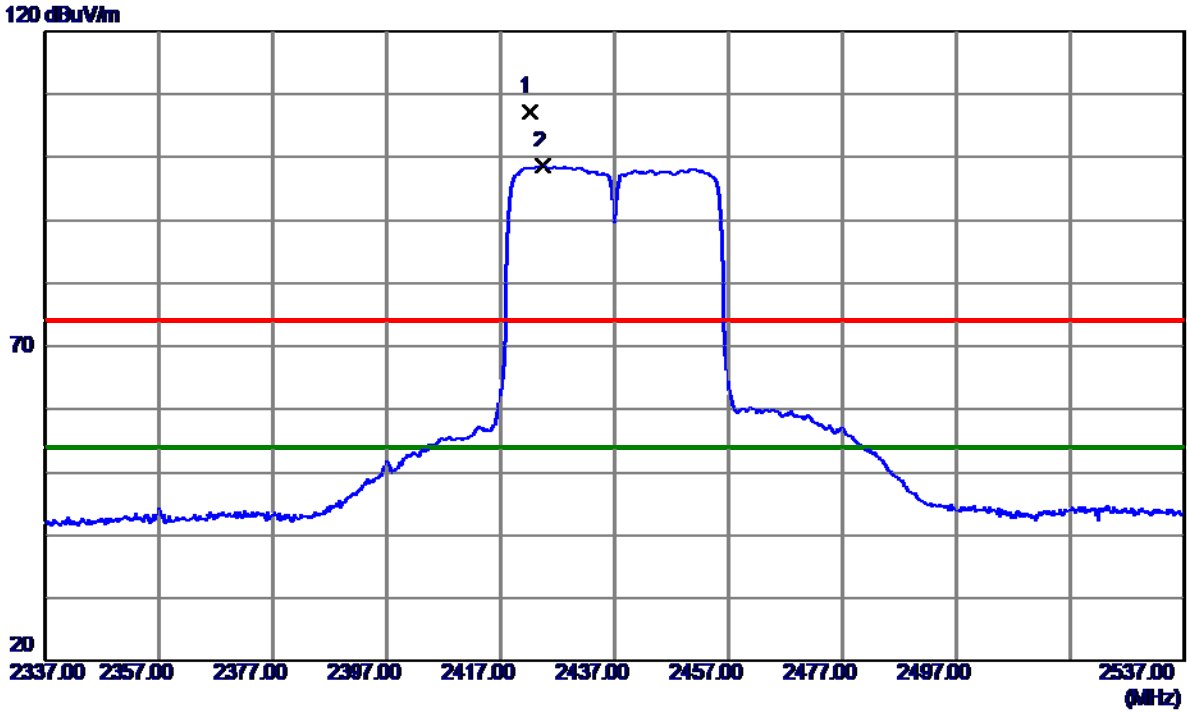

No.	Freq. MHz	Reading Level dBuV/m	Correct Factor dB	Measure ment dBuV/m	Limit dBuV/m	Margin dB	Detector	Comment
1	2422.0000	73.94	33.34	107.28	74.00	33.28	Peak	No limit
2 *	2424.4000	65.19	33.35	98.54	54.00	44.54	AVG	No limit

REMARKS:

- (1) Measurement Value = Reading Level + Correct Factor.
- (2) Margin Level = Measurement Value - Limit Value.

Test Mode: TX N-40M Mode2437 MHz

Vertical

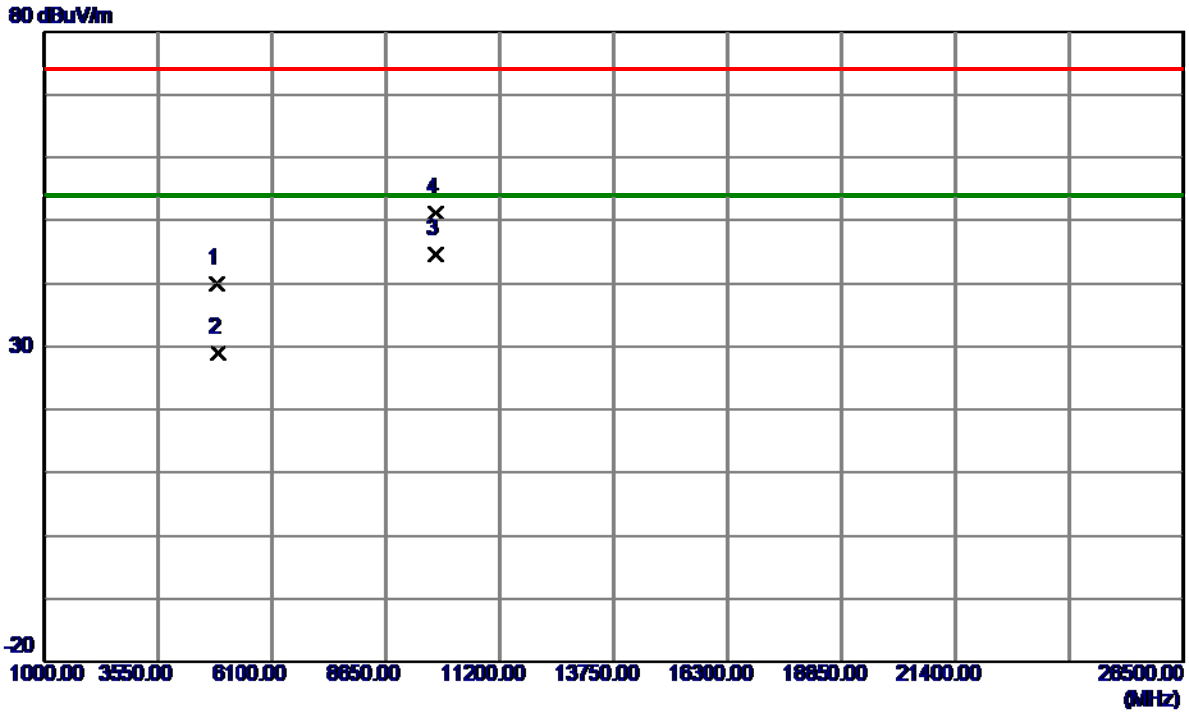

No.	Freq. MHz	Reading Level dBuV/m	Correct Factor dB	Measure ment dBuV/m	Limit dBuV/m	Margin dB	Detector	Comment
1	4864.8400	48.74	-8.83	39.91	74.00	-34.09	Peak	
2	4882.2799	37.76	-8.77	28.99	54.00	-25.01	AVG	
3 *	9748.0800	42.69	1.89	44.58	54.00	-9.42	AVG	
4	9748.2699	49.28	1.89	51.17	74.00	-22.83	Peak	

REMARKS:

- (1) Measurement Value = Reading Level + Correct Factor.
- (2) Margin Level = Measurement Value - Limit Value.

Test Mode: TX N-40M Mode2437 MHz

Horizontal

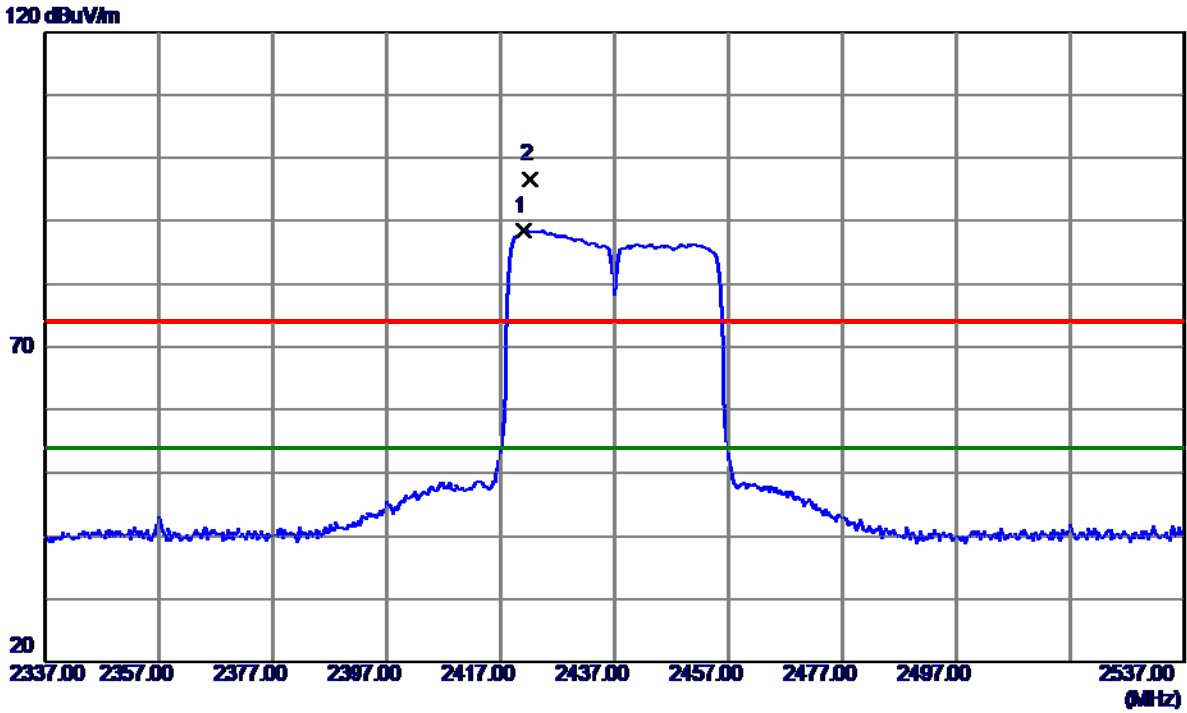

No.	Freq. MHz	Reading Level dBuV/m	Correct Factor dB	Measure ment dBuV/m	Limit dBuV/m	Margin dB	Detector	Comment
1 *	2421.0000	55.04	33.34	88.38	54.00	34.38	AVG	No limit
2	2422.2000	63.30	33.34	96.64	74.00	22.64	Peak	No limit

REMARKS:

- (1) Measurement Value = Reading Level + Correct Factor.
- (2) Margin Level = Measurement Value - Limit Value.

Test Mode: TX N-40M Mode2437 MHz

Horizontal

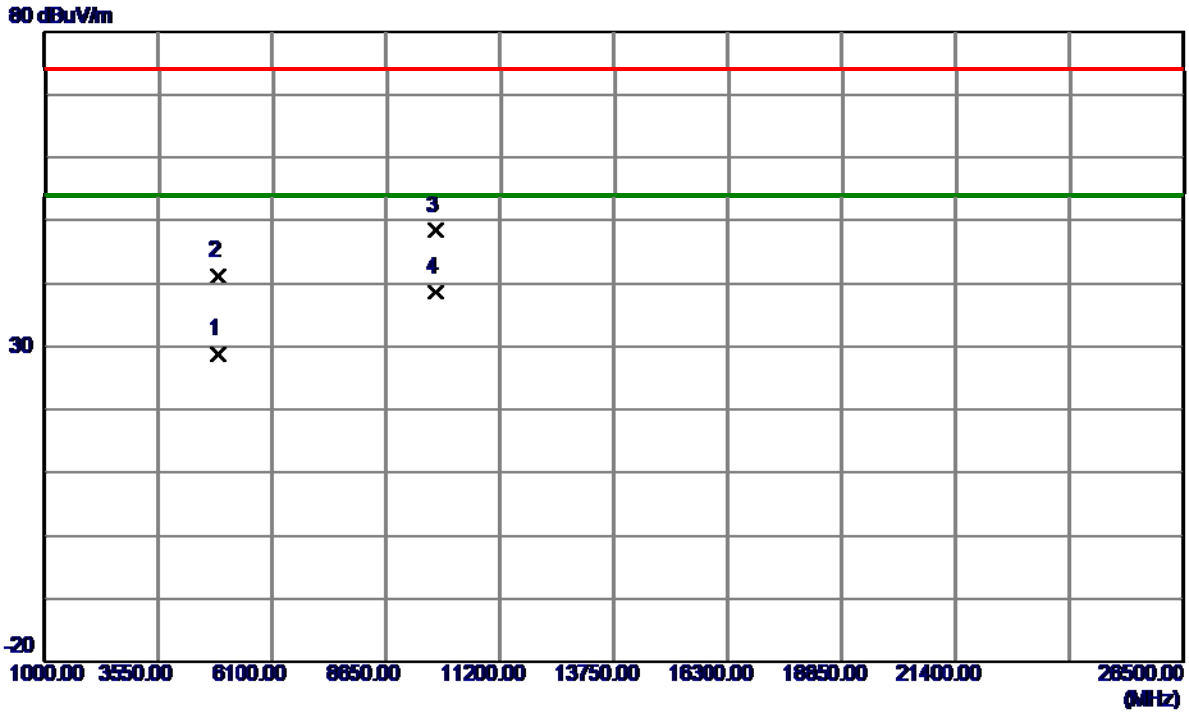

No.	Freq. MHz	Reading Level dBuV/m	Correct Factor dB	Measure ment dBuV/m	Limit dBuV/m	Margin dB	Detector	Comment
1	4871.9650	37.61	-8.81	28.80	54.00	-25.20	AVG	
2	4873.9600	49.97	-8.80	41.17	74.00	-32.83	Peak	
3	9747.6700	46.53	1.88	48.41	74.00	-25.59	Peak	
4 *	9747.9900	36.63	1.89	38.52	54.00	-15.48	AVG	

REMARKS:

- (1) Measurement Value = Reading Level + Correct Factor.
- (2) Margin Level = Measurement Value - Limit Value.

Test Mode: TX N-40M Mode2452 MHz

Vertical

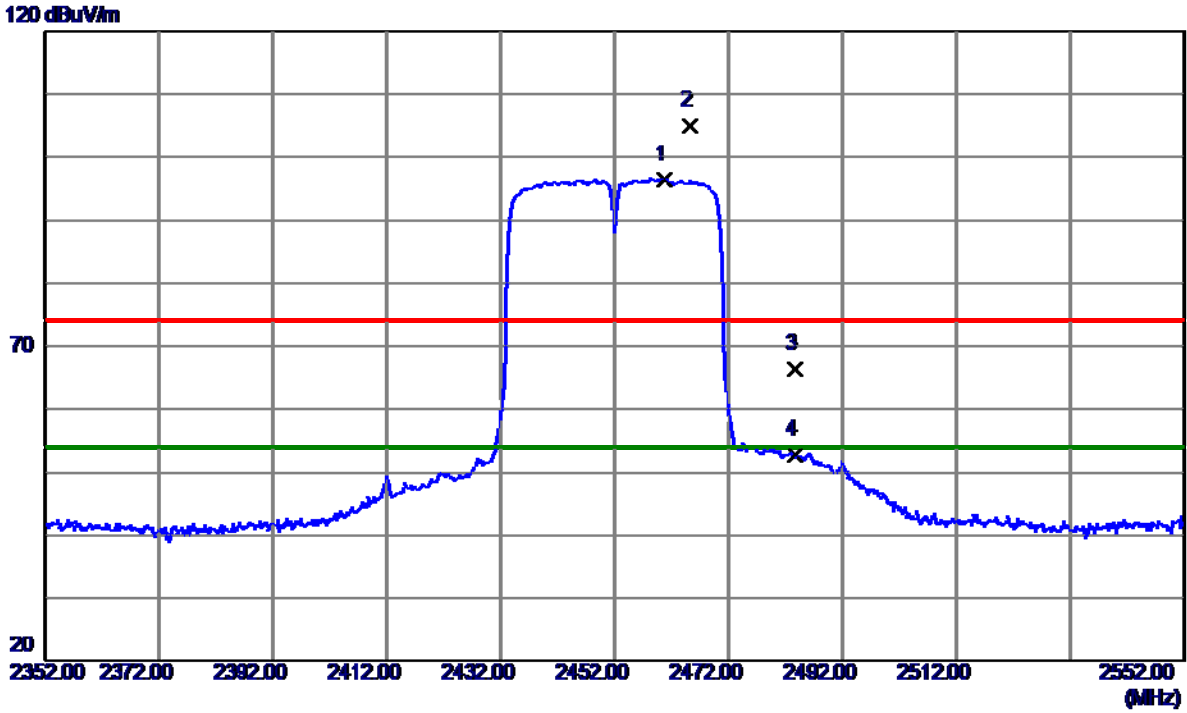

No.	Freq. MHz	Reading Level dBuV/m	Correct Factor dB	Measure ment dBuV/m	Limit dBuV/m	Margin dB	Detector	Comment
1 *	2460.6000	62.99	33.45	96.44	54.00	42.44	AVG	No limit
2	2465.2000	71.54	33.46	105.00	74.00	31.00	Peak	No limit
3	2483.5000	32.97	33.51	66.48	74.00	-7.52	Peak	
4	2483.5000	19.22	33.51	52.73	54.00	-1.27	AVG	

REMARKS:

- (1) Measurement Value = Reading Level + Correct Factor.
- (2) Margin Level = Measurement Value - Limit Value.

Test Mode: TX N-40M Mode2452 MHz

Vertical

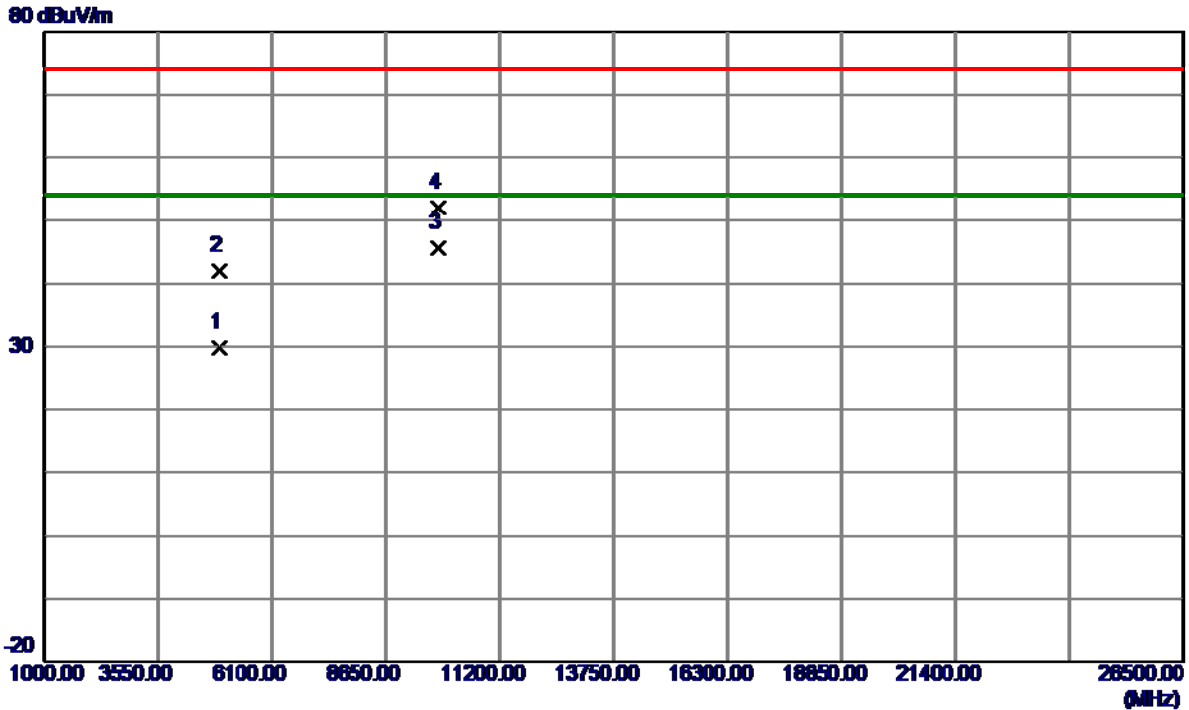

No.	Freq. MHz	Reading Level dBuV/m	Correct Factor dB	Measure ment dBuV/m	Limit dBuV/m	Margin dB	Detector	Comment
1	4903.2350	38.47	-8.69	29.78	54.00	-24.22	AVG	
2	4904.4950	50.67	-8.68	41.99	74.00	-32.01	Peak	
3 *	9808.0250	43.56	2.08	45.64	54.00	-8.36	AVG	
4	9808.0500	49.88	2.08	51.96	74.00	-22.04	Peak	

REMARKS:

- (1) Measurement Value = Reading Level + Correct Factor.
- (2) Margin Level = Measurement Value - Limit Value.

Test Mode: TX N-40M Mode2452 MHz

Horizontal

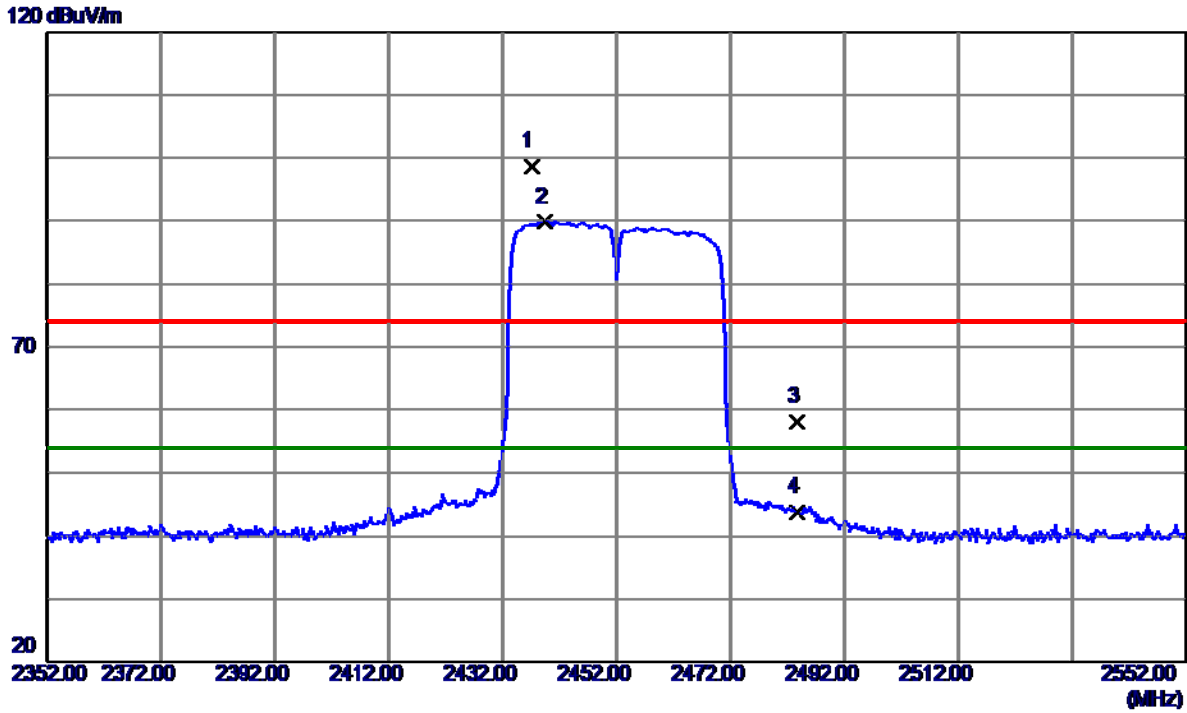

No.	Freq. MHz	Reading Level dBuV/m	Correct Factor dB	Measure ment dBuV/m	Limit dBuV/m	Margin dB	Detector	Comment
1	2437.0000	65.14	33.38	98.52	74.00	24.52	Peak	No limit
2 *	2439.4000	56.49	33.39	89.88	54.00	35.88	AVG	No limit
3	2483.5000	24.54	33.51	58.05	74.00	-15.95	Peak	
4	2483.5000	10.21	33.51	43.72	54.00	-10.28	AVG	

REMARKS:

- (1) Measurement Value = Reading Level + Correct Factor.
- (2) Margin Level = Measurement Value - Limit Value.

Test Mode: TX N-40M Mode2452 MHz

Horizontal

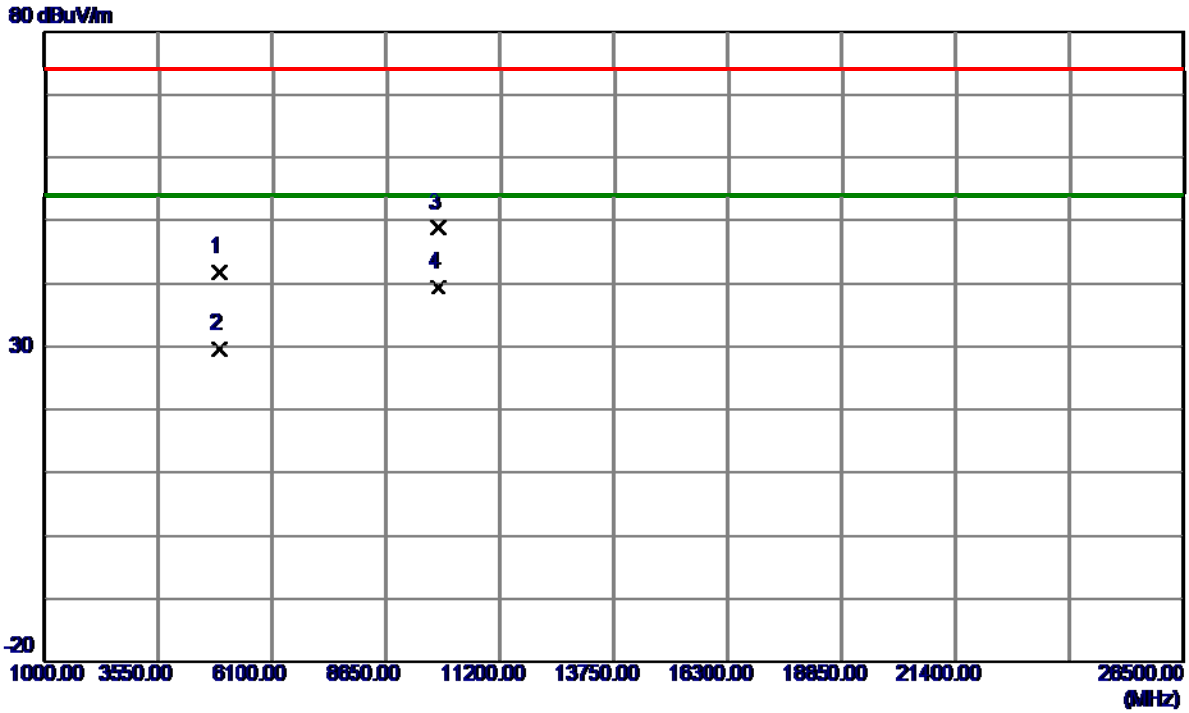

No.	Freq. MHz	Reading Level dBuV/m	Correct Factor dB	Measure ment dBuV/m	Limit dBuV/m	Margin dB	Detector	Comment
1	4901.9100	50.53	-8.69	41.84	74.00	-32.16	Peak	
2	4904.4100	38.23	-8.68	29.55	54.00	-24.45	AVG	
3	9806.3800	46.80	2.08	48.88	74.00	-25.12	Peak	
4 *	9807.8850	37.41	2.08	39.49	54.00	-14.51	AVG	

REMARKS:

- (1) Measurement Value = Reading Level + Correct Factor.
- (2) Margin Level = Measurement Value - Limit Value.

APPENDIXE - BANDWIDTH

Non-Beamforming

Test Mode	TX B Mode
-----------	-----------

Channel	Frequency (MHz)	6dB Bandwidth (MHz)	99% Emission Bandwidth(MHz)	6dB Bandwidth Min. Limit(kHz)	Result
01	2412	10.12	16.44	500	Complies
06	2437	10.15	16.48	500	Complies
11	2462	10.15	16.40	500	Complies

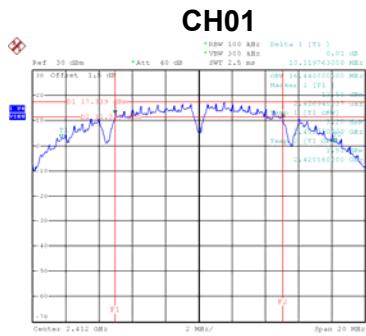

Date: 21.AUG.2019 11:20:19

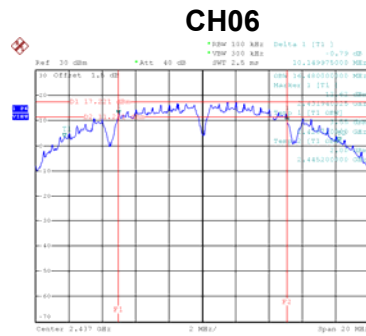

Date: 21.AUG.2019 11:20:19

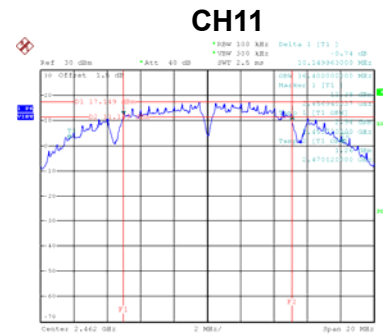

Date: 21.AUG.2019 11:20:19

Test Mode	TX G Mode
-----------	-----------

Channel	Frequency (MHz)	6dB Bandwidth (MHz)	99% Emission Bandwidth(MHz)	6dB Bandwidth Min. Limit(kHz)	Result
01	2412	16.38	16.56	500	Complies
06	2437	16.40	16.56	500	Complies
11	2462	16.36	16.56	500	Complies

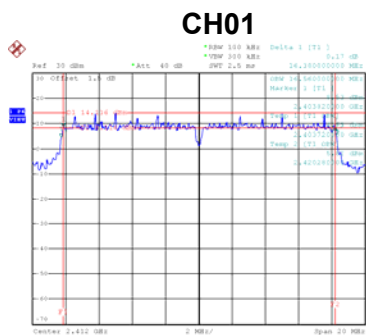

Date: 21.AUG.2019 11:30:16

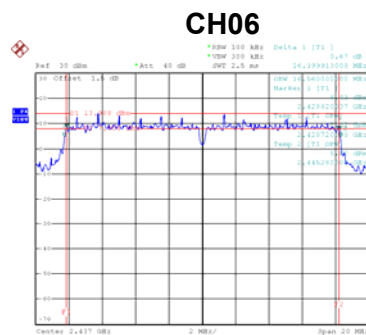

Date: 21.AUG.2019 11:30:16

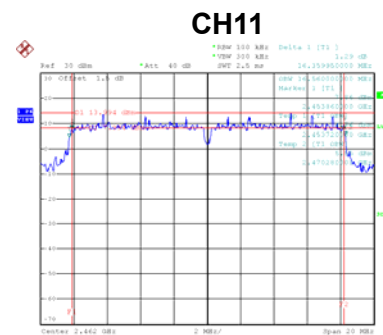

Date: 21.AUG.2019 11:30:16

Test Mode	TX N-20M Mode
-----------	---------------

Channel	Frequency (MHz)	6dB Bandwidth (MHz)	99% Emission Bandwidth(MHz)	6dB Bandwidth Min. Limit(kHz)	Result
01	2412	17.58	17.64	500	Complies
06	2437	17.58	17.64	500	Complies
11	2462	17.58	17.64	500	Complies

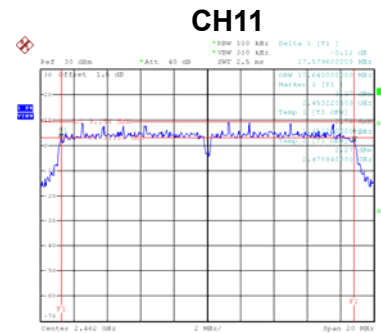
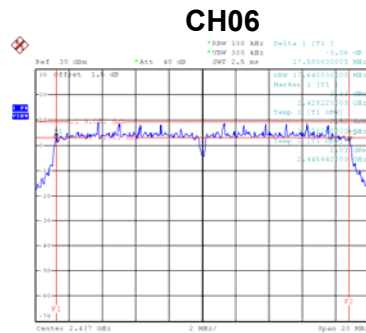
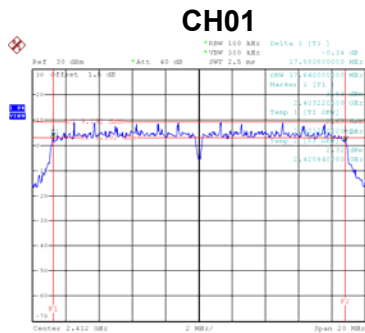

Test Mode	TX N-40M Mode
-----------	---------------

Channel	Frequency (MHz)	6dB Bandwidth (MHz)	99% Emission Bandwidth(MHz)	6dB Bandwidth Min. Limit(kHz)	Result
03	2422	35.44	35.92	500	Complies
06	2437	35.76	35.92	500	Complies
09	2452	35.69	35.92	500	Complies

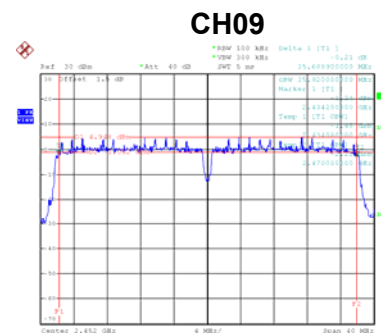
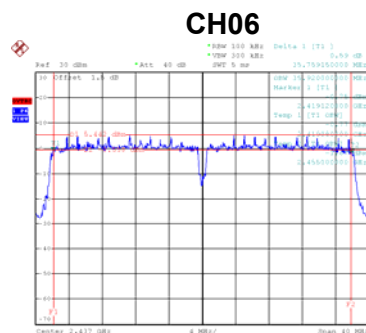
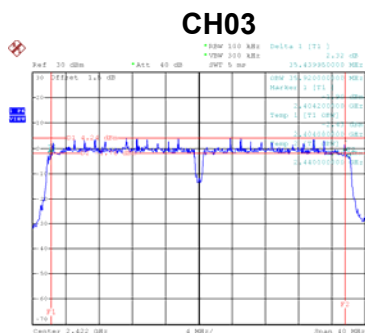

APPENDIXF- MAXIMUMOUTPUT POWER

Non-Beamforming

Test Mode	TX B Mode
------------------	------------------

Channel	Frequency (MHz)	Output Power (dBm)	Output Power (W)	Max. Limit(dBm)	Max. Limit (W)	Result
01	2412	22.31	0.1702	30.00	1.0000	Complies
06	2437	22.25	0.1679	30.00	1.0000	Complies
11	2462	22.18	0.1652	30.00	1.0000	Complies

Test Mode	TX G Mode
------------------	------------------

Channel	Frequency (MHz)	Output Power (dBm)	Output Power (W)	Max. Limit(dBm)	Max. Limit (W)	Result
01	2412	24.95	0.3126	30.00	1.0000	Complies
06	2437	27.29	0.5358	30.00	1.0000	Complies
11	2462	25.48	0.3532	30.00	1.0000	Complies

Test Mode	TX N-20M Mode_Ant. 1
-----------	----------------------

Channel	Frequency (MHz)	Output Power (dBm)	Output Power (W)	Max. Limit(dBm)	Max. Limit (W)	Result
01	2412	24.74	0.2981	30.00	1.0000	Complies
06	2437	26.72	0.4702	30.00	1.0000	Complies
11	2462	23.98	0.2502	30.00	1.0000	Complies

Test Mode	TX N-20M Mode_Ant. 2
-----------	----------------------

Channel	Frequency (MHz)	Output Power (dBm)	Output Power (W)	Max. Limit(dBm)	Max. Limit (W)	Result
01	2412	24.31	0.2700	30.00	1.0000	Complies
06	2437	26.48	0.4449	30.00	1.0000	Complies
11	2462	23.68	0.2335	30.00	1.0000	Complies

Test Mode	TX N-20M Mode_Total
-----------	---------------------

Channel	Frequency (MHz)	Output Power (dBm)	Output Power (W)	Max. Limit(dBm)	Max. Limit (W)	Result
01	2412	27.54	0.5680	30.00	1.0000	Complies
06	2437	29.61	0.9152	30.00	1.0000	Complies
11	2462	26.85	0.4837	30.00	1.0000	Complies

Test Mode	TX N-40M Mode_Ant. 1
-----------	----------------------

Channel	Frequency (MHz)	Output Power (dBm)	Output Power (W)	Max. Limit(dBm)	Max. Limit (W)	Result
03	2422	25.04	0.3195	30.00	1.0000	Complies
06	2437	26.34	0.4309	30.00	1.0000	Complies
09	2452	24.76	0.2995	30.00	1.0000	Complies

Test Mode	TX N-40M Mode_Ant. 2
-----------	----------------------

Channel	Frequency (MHz)	Output Power (dBm)	Output Power (W)	Max. Limit(dBm)	Max. Limit (W)	Result
03	2422	25.44	0.3503	30.00	1.0000	Complies
06	2437	25.99	0.3976	30.00	1.0000	Complies
09	2452	24.84	0.3051	30.00	1.0000	Complies

Test Mode	TX N-40M Mode_Total
-----------	---------------------

Channel	Frequency (MHz)	Output Power (dBm)	Output Power (W)	Max. Limit(dBm)	Max. Limit (W)	Result
03	2422	28.26	0.6697	30.00	1.0000	Complies
06	2437	29.18	0.8285	30.00	1.0000	Complies
09	2452	27.81	0.6046	30.00	1.0000	Complies

APPENDIXG - CONDUCTED SPURIOUS EMISSIONS

Non-Beamforming

Test Mode TX B Mode

Bandedge-CH01

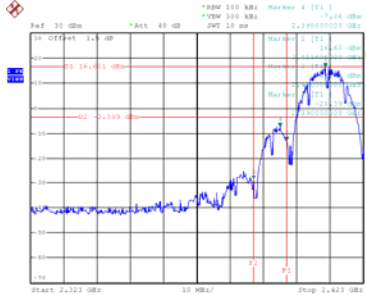

Date: 21.AUG.2019 12:03:28

Bandedge-CH11

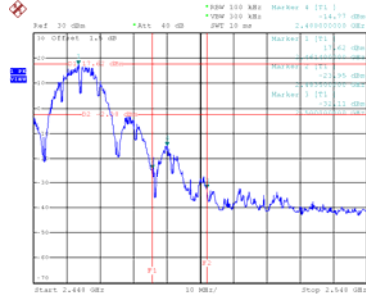

Date: 21.AUG.2019 11:33:26

CH01 –10th Harmonic of the fundamental frequency

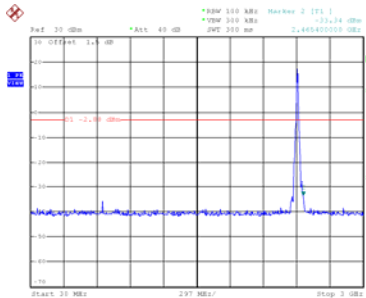

Date: 21.AUG.2019 11:28:56

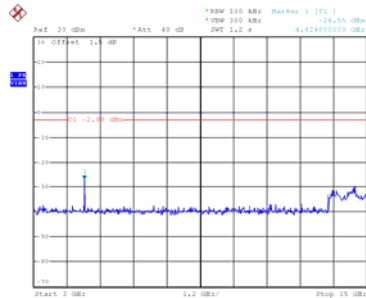

Date: 21.AUG.2019 11:29:03

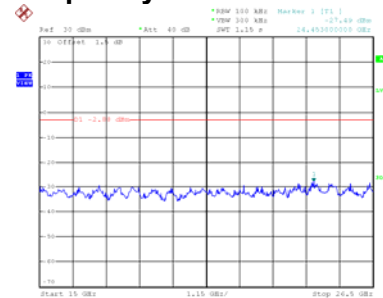

Date: 21.AUG.2019 11:29:09

CH06 –10th Harmonic of the fundamental frequency

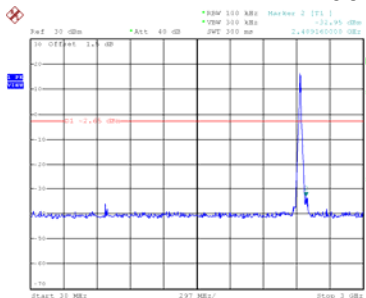

Date: 21.AUG.2019 11:31:36

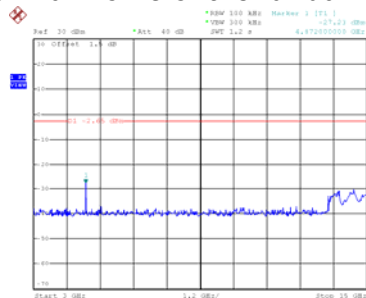

Date: 21.AUG.2019 11:31:42

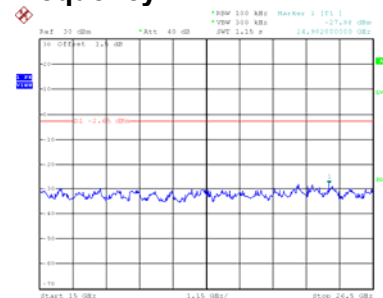

Date: 21.AUG.2019 11:31:49

CH11 –10th Harmonic of the fundamental frequency

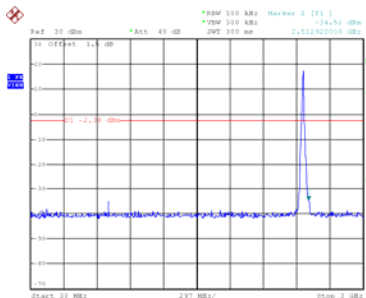

Date: 21.AUG.2019 11:33:39

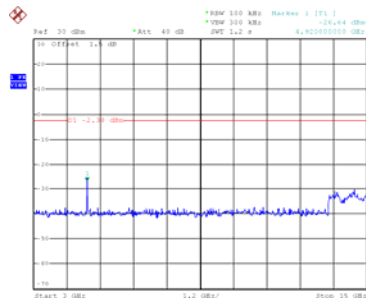

Date: 21.AUG.2019 11:33:46

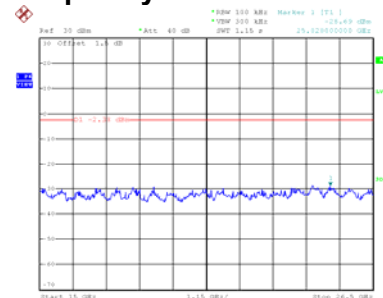

Date: 21.AUG.2019 11:33:52

Test Mode TX G Mode

Bandedge-CH01

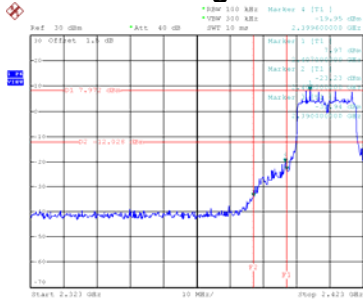

Date: 21.AUG.2019 12:00:50

Bandedge-CH11

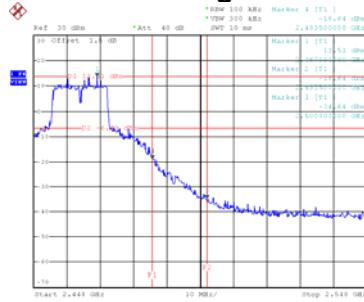

Date: 21.AUG.2019 11:35:29

CH01 –10th Harmonic of the fundamental frequency

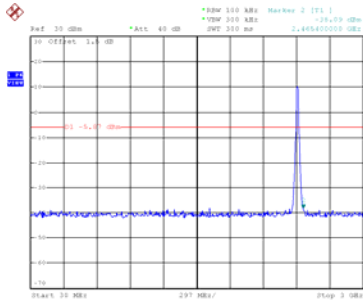

Date: 21.AUG.2019 11:38:52

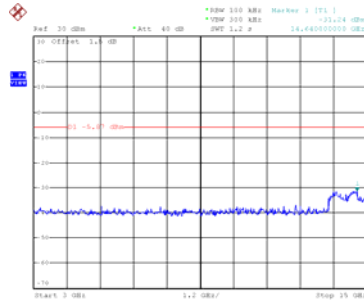

Date: 21.AUG.2019 11:38:59

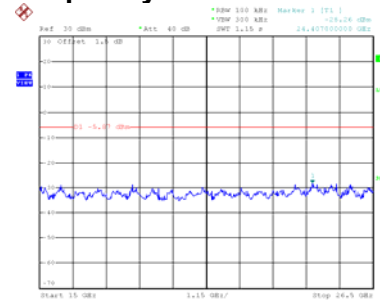

Date: 21.AUG.2019 11:39:06

CH06 –10th Harmonic of the fundamental frequency

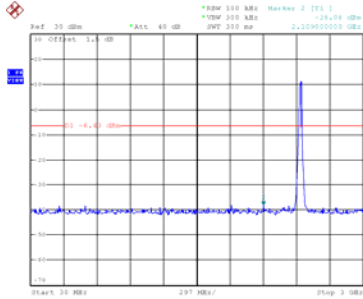

Date: 21.AUG.2019 11:37:22

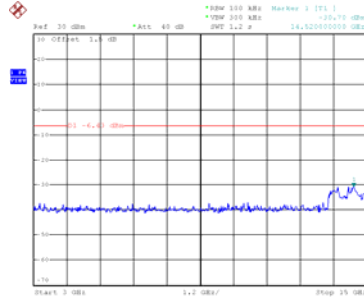

Date: 21.AUG.2019 11:37:29

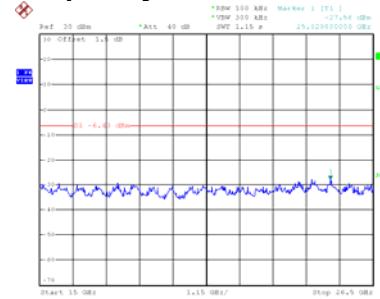

Date: 21.AUG.2019 11:37:36

CH11 –10th Harmonic of the fundamental frequency

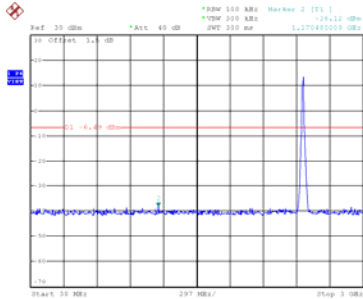

Date: 21.AUG.2019 11:35:44

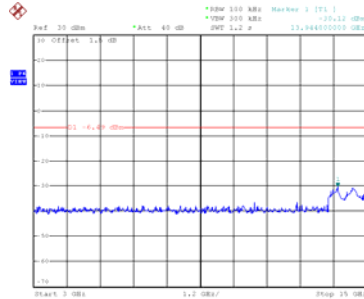

Date: 21.AUG.2019 11:35:48

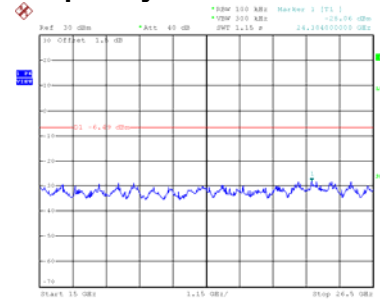

Date: 21.AUG.2019 11:35:55

Test Mode TX N-20M Mode_Ant. 1

Bandedge-CH01

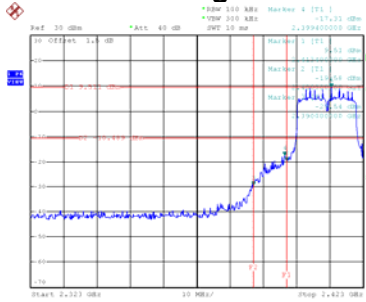

Date: 21.AUG.2019 11:57:28

Bandedge-CH11

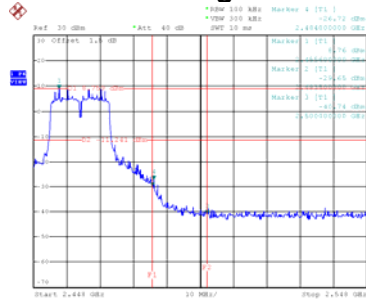

Date: 21.AUG.2019 11:43:50

CH01 –10th Harmonic of the fundamental frequency

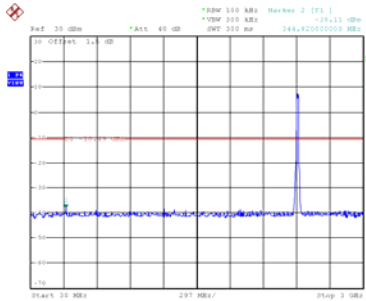

Date: 21.AUG.2019 11:57:41

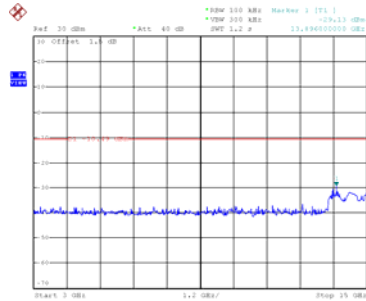

Date: 21.AUG.2019 11:57:48

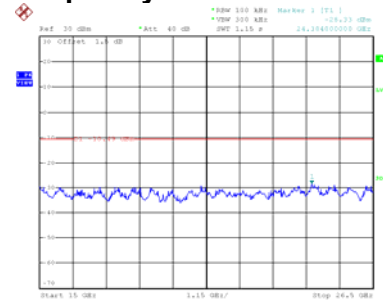

Date: 21.AUG.2019 11:57:54

CH06 –10th Harmonic of the fundamental frequency

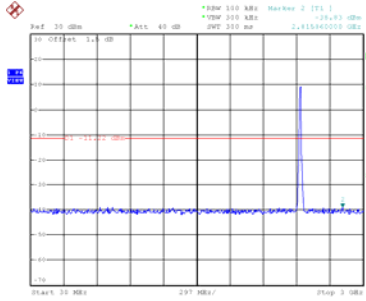

Date: 21.AUG.2019 11:42:12

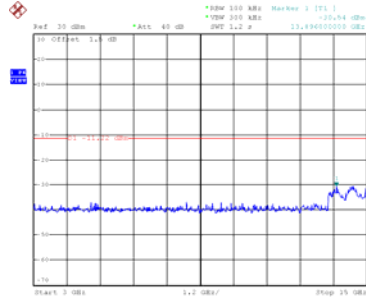

Date: 21.AUG.2019 11:42:18

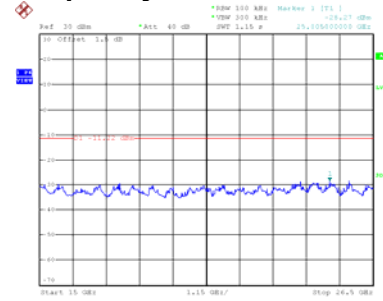

Date: 21.AUG.2019 11:42:25

CH11 –10th Harmonic of the fundamental frequency

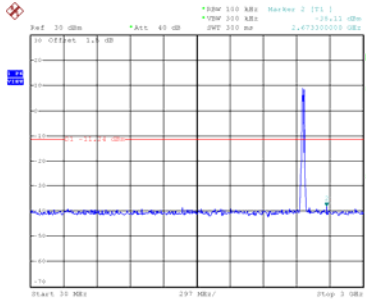

Date: 21.AUG.2019 11:44:03

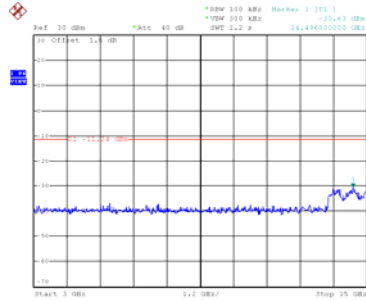

Date: 21.AUG.2019 11:44:10

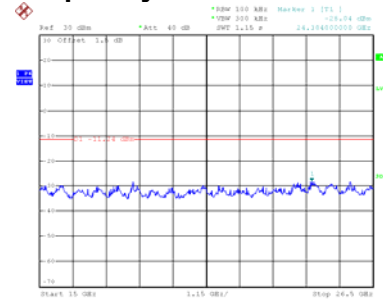

Date: 21.AUG.2019 11:44:17

Test Mode TX N-20M Mode_Ant. 2

Bandedge-CH01

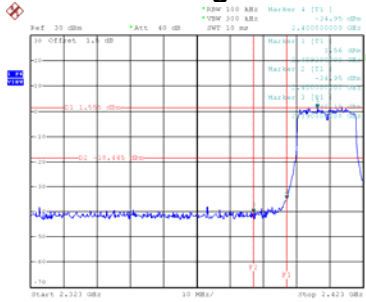

Date: 28.AUG.2019 15:00:03

Bandedge-CH11

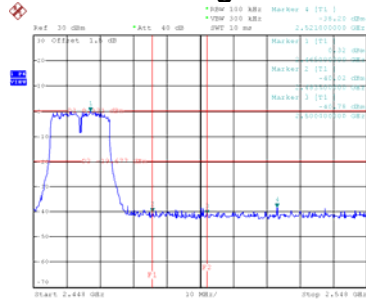

Date: 28.AUG.2019 15:05:11

CH01 –10th Harmonic of the fundamental frequency

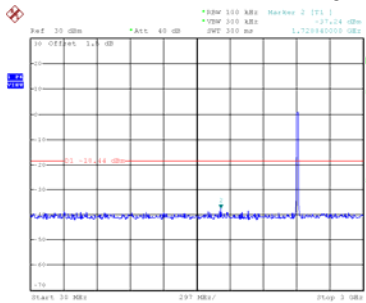

Date: 28.AUG.2019 15:00:16

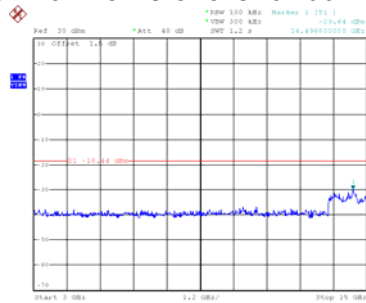

Date: 28.AUG.2019 15:00:23

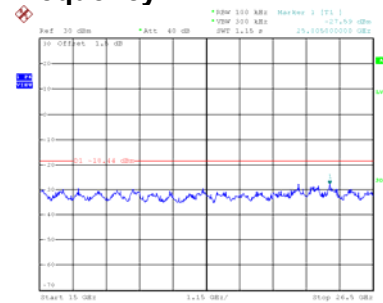

Date: 28.AUG.2019 15:00:30

CH06 –10th Harmonic of the fundamental frequency

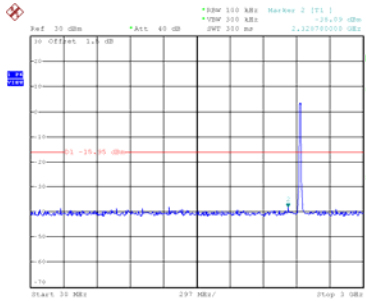

Date: 28.AUG.2019 15:03:56

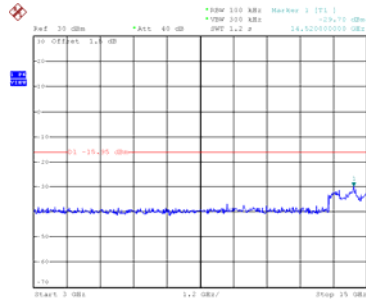

Date: 28.AUG.2019 15:04:03

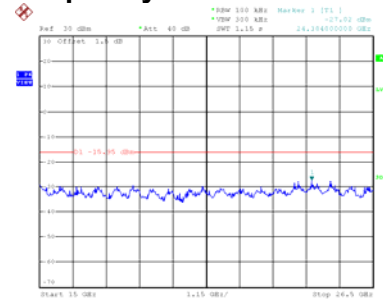

Date: 28.AUG.2019 15:04:10

CH11 –10th Harmonic of the fundamental frequency

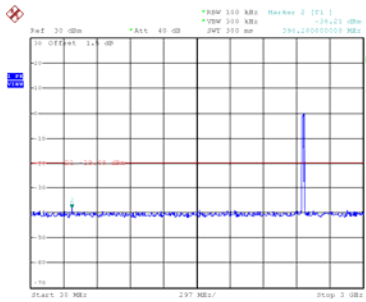

Date: 28.AUG.2019 15:05:24

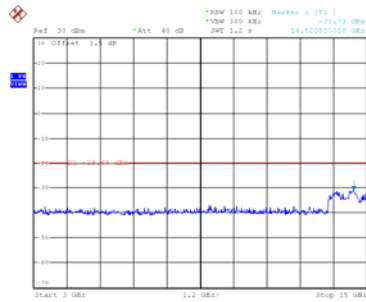

Date: 28.AUG.2019 15:05:31

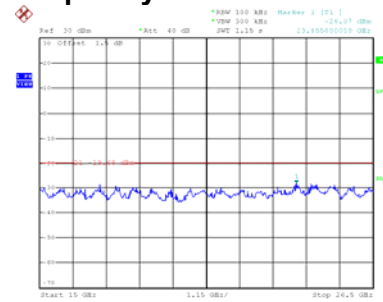

Date: 28.AUG.2019 15:05:38

Test Mode TX N-40M Mode_Ant. 1

Bandedge-CH03

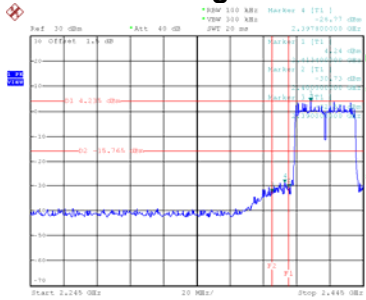

Date: 21.AUG.2019 11:45:23

Bandedge-CH09

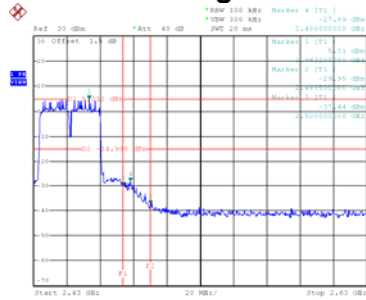

Date: 21.AUG.2019 11:55:37

CH03 –10th Harmonic of the fundamental frequency

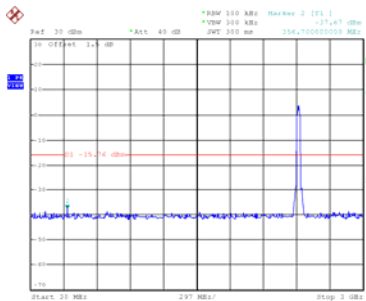

Date: 21.AUG.2019 11:45:35

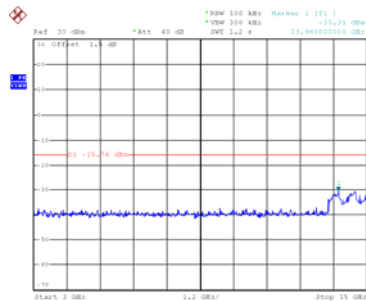

Date: 21.AUG.2019 11:45:42

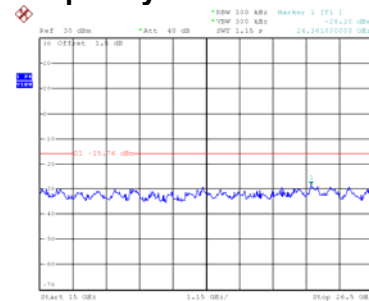

Date: 21.AUG.2019 11:45:49

CH06 –10th Harmonic of the fundamental frequency

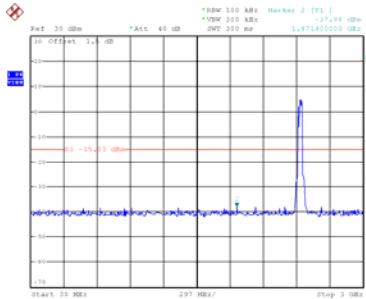

Date: 21.AUG.2019 11:49:07

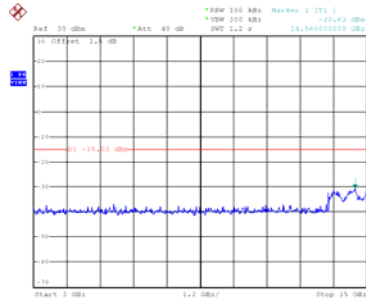

Date: 21.AUG.2019 11:49:13

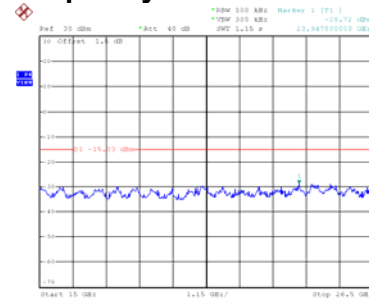

Date: 21.AUG.2019 11:49:20

CH09 –10th Harmonic of the fundamental frequency

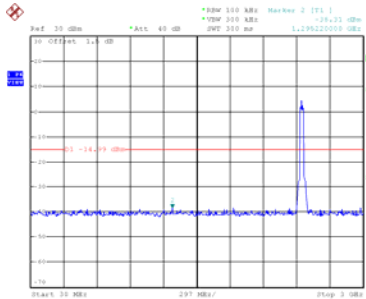

Date: 21.AUG.2019 11:55:49

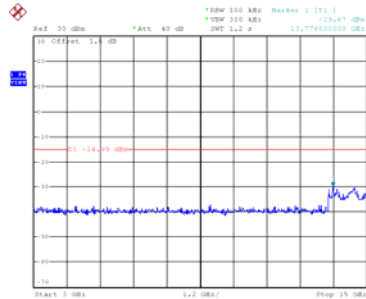

Date: 21.AUG.2019 11:55:56

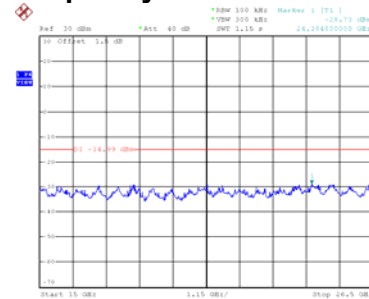

Date: 21.AUG.2019 11:56:03

Test Mode TX N-40M Mode_Ant. 2

Bandedge-CH03

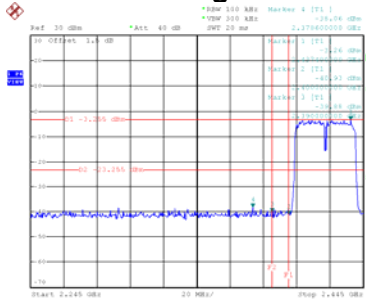

Date: 28.AUG.2019 15:08:11

Bandedge-CH09

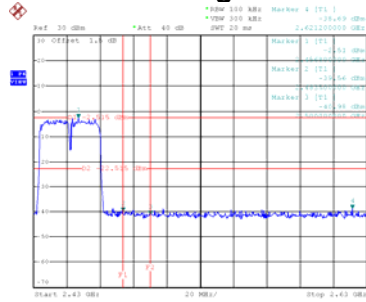

Date: 28.AUG.2019 15:12:26

CH03 –10th Harmonic of the fundamental frequency

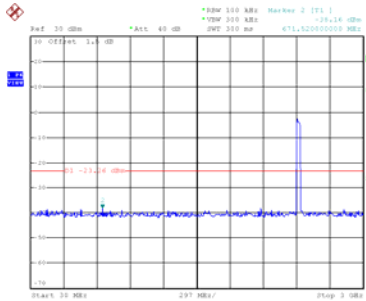

Date: 28.AUG.2019 15:08:24

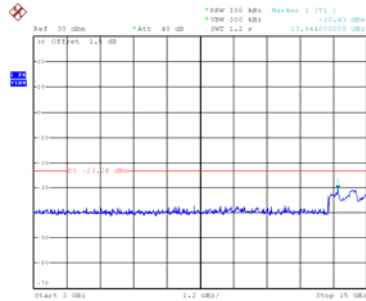

Date: 28.AUG.2019 15:08:31

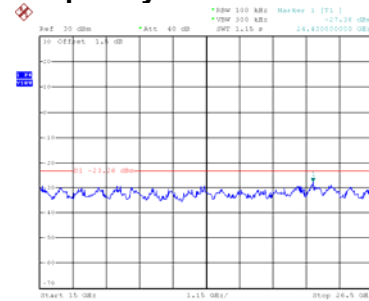

Date: 28.AUG.2019 15:08:38

CH06 –10th Harmonic of the fundamental frequency

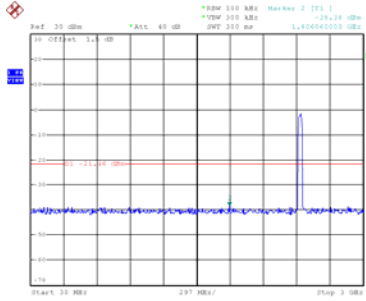

Date: 28.AUG.2019 15:10:04

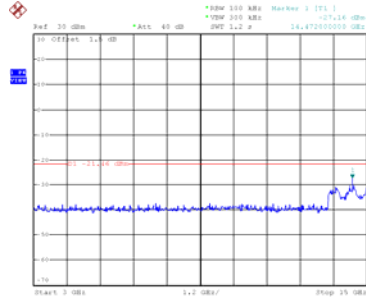

Date: 28.AUG.2019 15:10:11

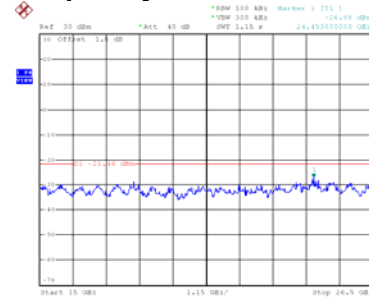

Date: 28.AUG.2019 15:10:18

CH09 –10th Harmonic of the fundamental frequency

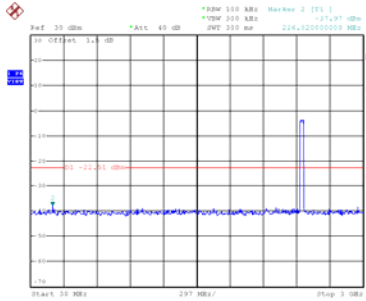

Date: 28.AUG.2019 15:12:39

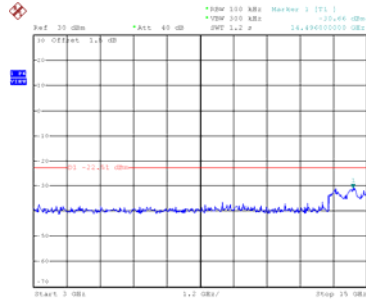

Date: 28.AUG.2019 15:12:46

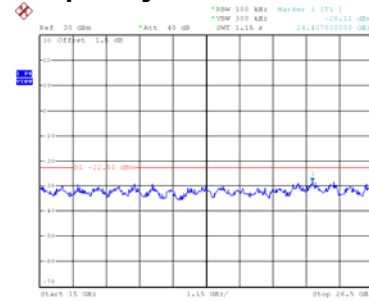

Date: 28.AUG.2019 15:12:53

APPENDIXH - POWER SPECTRAL DENSITY

Non-Beamforming

Test Mode	TX B Mode
-----------	-----------

Channel	Frequency (MHz)	Power Spectral Density (dBm/3kHz)	Max. Limit (dBm/3kHz)	Result
01	2412	2.07	8	Complies
06	2437	0.94	8	Complies
11	2462	1.65	8	Complies

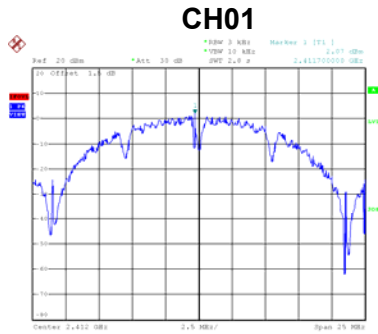

Date: 21.AUG.2019 12:07:53

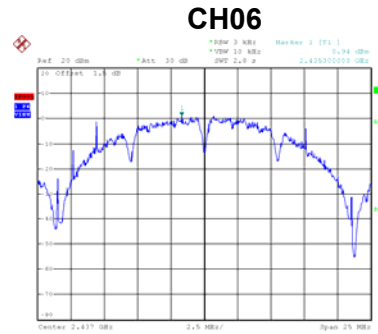

Date: 21.AUG.2019 12:08:38

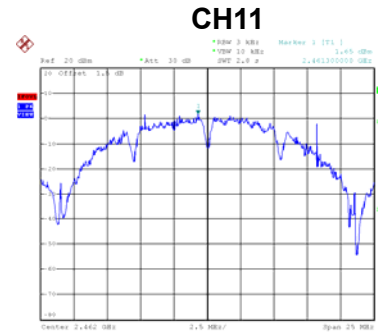

Date: 21.AUG.2019 12:13:26

Test Mode	TX G Mode
-----------	-----------

Channel	Frequency (MHz)	Power Spectral Density (dBm/3kHz)	Max. Limit (dBm/3kHz)	Result
01	2412	-1.72	8	Complies
06	2437	-3.29	8	Complies
11	2462	-3.52	8	Complies

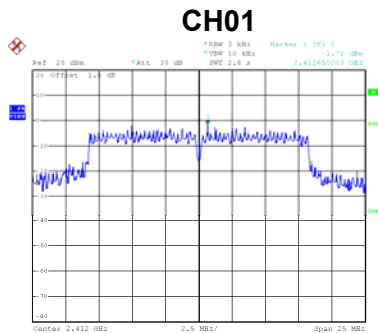

Date: 21.AUG.2019 13:38:07

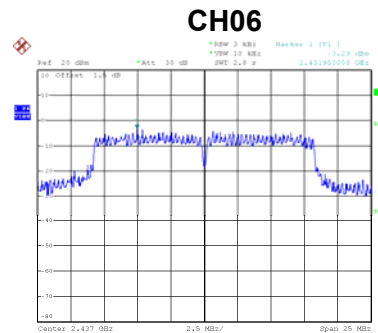

Date: 21.AUG.2019 12:10:45

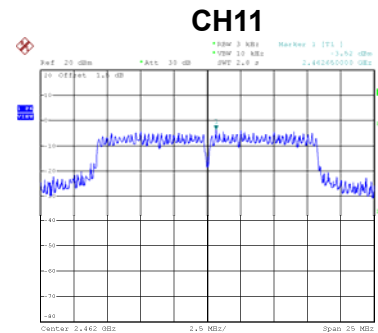

Date: 21.AUG.2019 12:10:18

Test Mode	TX N-20M Mode_Ant. 1
-----------	----------------------

Channel	Frequency (MHz)	Power Spectral Density (dBm/3kHz)	Max. Limit (dBm/3kHz)	Result
01	2412	-7.15	8	Complies
06	2437	-6.77	8	Complies
11	2462	-7.18	8	Complies

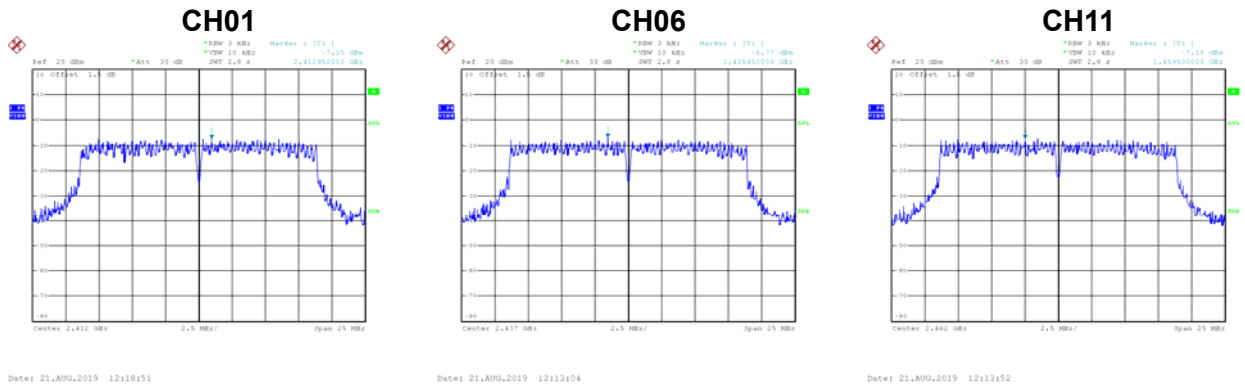

Test Mode	TX N-20M Mode_Ant. 2
-----------	----------------------

Channel	Frequency (MHz)	Power Spectral Density (dBm/3kHz)	Max. Limit (dBm/3kHz)	Result
01	2412	-11.00	8	Complies
06	2437	-11.00	8	Complies
11	2462	-10.64	8	Complies

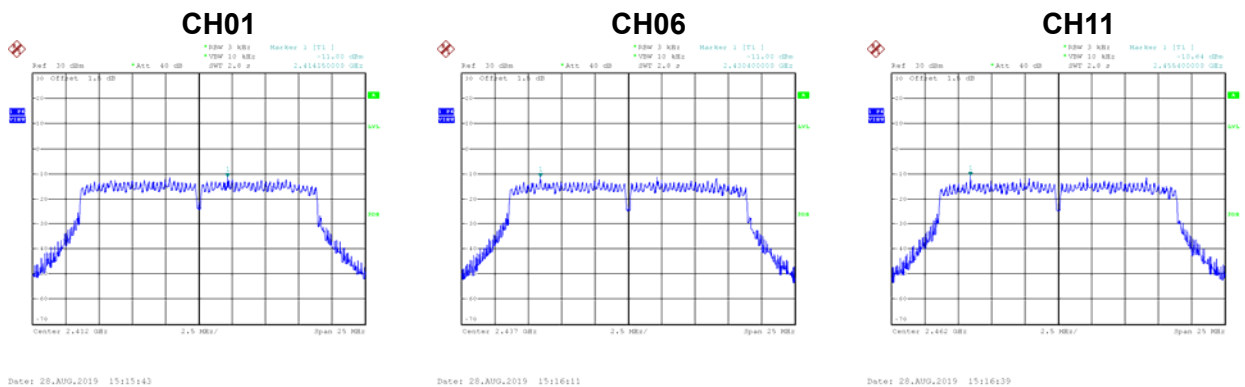

Test Mode	TX N-20M Mode_Total
-----------	---------------------

Channel	Frequency (MHz)	Power Spectral Density (dBm/3kHz)	Max. Limit (dBm/3kHz)	Result
01	2412	-5.65	8	Complies
06	2437	-5.38	8	Complies
11	2462	-5.56	8	Complies

Test Mode	TX N-40M Mode_Ant. 1
-----------	----------------------

Channel	Frequency (MHz)	Power Spectral Density (dBm/3kHz)	Max. Limit (dBm/3kHz)	Result
03	2422	-12.22	8	Complies
06	2437	-11.00	8	Complies
09	2452	-10.71	8	Complies

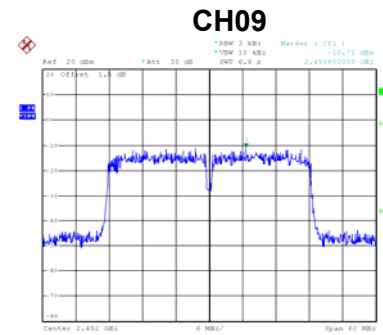
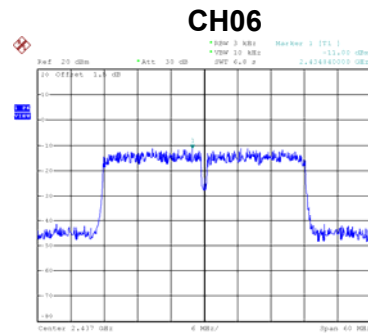
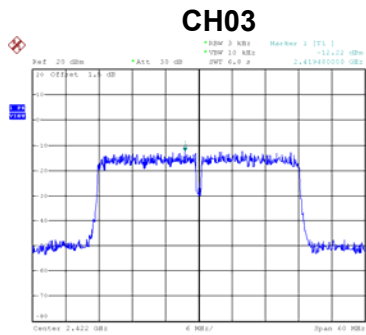

Test Mode	TX N-40M Mode_Ant. 2
-----------	----------------------

Channel	Frequency (MHz)	Power Spectral Density (dBm/3kHz)	Max. Limit (dBm/3kHz)	Result
03	2422	-14.58	8	Complies
06	2437	-14.30	8	Complies
09	2452	-17.72	8	Complies

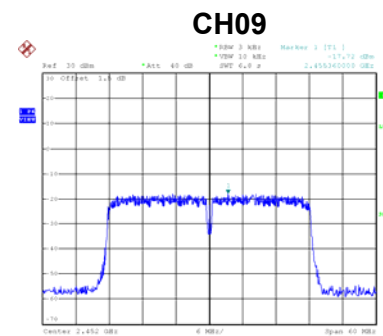
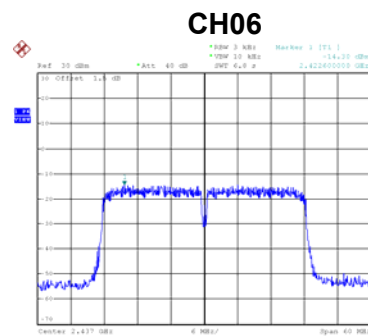
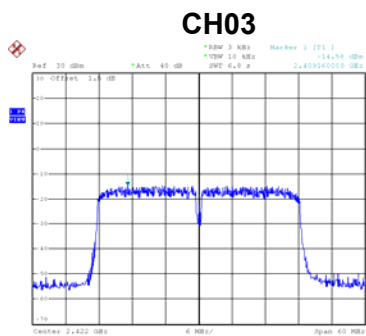

Test Mode	TX N-40M Mode_Total
-----------	---------------------

Channel	Frequency (MHz)	Power Spectral Density (dBm/3kHz)	Max. Limit (dBm/3kHz)	Result
03	2422	-10.23	8	Complies
06	2437	-9.33	8	Complies
09	2452	-9.92	8	Complies

End of Test Report