



FCC TEST REPORT

REPORT NO.: RF991117C18B R1

MODEL NO.: DIR-615

FCC ID: KA2IR615H1

RECEIVED: Sep. 29, 2011

TESTED: Oct. 04 ~ Oct. 14, 2011

ISSUED: Nov. 11, 2011

APPLICANT: D-Link Corporation

ADDRESS: 17595 Mt. Herrmann, Fountain Valley, California,
United States, 92708

ISSUED BY: Bureau Veritas Consumer Products Services (H.K.)
Ltd., Taoyuan Branch

LAB ADDRESS: No. 47, 14th Ling, Chia Pau Vil., Lin Kou Dist., New
Taipei City, Taiwan (R.O.C)

TEST LOCATION: No. 19, Hwa Ya 2nd Rd, Wen Hwa Tsuen, Kwei
Shan Hsiang, Taoyuan Hsien 333, Taiwan, R.O.C.

This test report consists of 79 pages in total. It may be duplicated completely for legal use with the approval of the applicant. It should not be reproduced except in full, without the written approval of our laboratory. The client should not use it to claim product, certification, approval or endorsement by TAF or any government agency. The test results in the report only apply to the tested sample.





TABLE OF CONTENTS

RELEASE CONTROL RECORD.....	4
1. CERTIFICATION.....	5
2. SUMMARY OF TEST RESULTS	6
2.1 MEASUREMENT UNCERTAINTY	6
3. GENERAL INFORMATION.....	7
3.1 GENERAL DESCRIPTION OF EUT.....	7
3.2 DESCRIPTION OF TEST MODES.....	8
3.2.1 CONFIGURATION OF SYSTEM UNDER TEST	8
3.2.2 TEST MODE APPLICABILITY AND TESTED CHANNEL DETAIL.....	9
3.3 GENERAL DESCRIPTION OF APPLIED STANDARDS	11
3.4 DESCRIPTION OF SUPPORT UNITS	11
4. TEST TYPES AND RESULTS	12
4.1 RADIATED EMISSION MEASUREMENT	12
4.1.1 LIMITS OF RADIATED EMISSION MEASUREMENT.....	12
4.1.2 TEST INSTRUMENTS	13
4.1.3 TEST PROCEDURES	14
4.1.4 DEVIATION FROM TEST STANDARD	14
4.1.5 TEST SETUP	15
4.1.6 EUT OPERATING CONDITIONS	15
4.1.7 TEST RESULTS	16
4.2 CONDUCTED EMISSION MEASUREMENT	29
4.2.1 LIMITS OF CONDUCTED EMISSION MEASUREMENT.....	29
4.2.2 TEST INSTRUMENTS	29
4.2.3 TEST PROCEDURES	30
4.2.4 DEVIATION FROM TEST STANDARD	30
4.2.5 TEST SETUP	31
4.2.6 EUT OPERATING CONDITIONS	31
4.2.7 TEST RESULTS	32
4.3 6dB BANDWIDTH MEASUREMENT	34
4.3.1 LIMITS OF 6dB BANDWIDTH MEASUREMENT.....	34
4.3.2 TEST INSTRUMENTS	34
4.3.3 TEST PROCEDURE	34
4.3.4 DEVIATION FROM TEST STANDARD	34
4.3.5 TEST SETUP	35
4.3.6 EUT OPERATING CONDITIONS	35
4.3.7 TEST RESULTS	36
4.4 MAXIMUM OUTPUT POWER.....	40
4.4.1 LIMITS OF MAXIMUM OUTPUT POWER MEASUREMENT	40
4.4.2 INSTRUMENTS.....	40
4.4.3 TEST PROCEDURES	40
4.4.4 DEVIATION FROM TEST STANDARD	41
4.4.5 TEST SETUP	41
4.4.6 EUT OPERATING CONDITIONS	41
4.4.7 TEST RESULTS	42
4.5 POWER SPECTRAL DENSITY MEASUREMENT.....	43
4.5.1 LIMITS OF POWER SPECTRAL DENSITY MEASUREMENT	43
4.5.2 TEST INSTRUMENTS	43
4.5.3 TEST PROCEDURE	43



A D T

4.5.4	DEVIATION FROM TEST STANDARD	44
4.5.5	TEST SETUP	44
4.5.6	EUT OPERATING CONDITION	44
4.5.7	TEST RESULTS	45
4.6	BAND EDGES MEASUREMENT	49
4.6.1	LIMITS OF BAND EDGES MEASUREMENT	49
4.6.2	TEST INSTRUMENTS	49
4.6.3	TEST PROCEDURE	50
4.6.4	DEVIATION FROM TEST STANDARD	50
4.6.5	EUT OPERATING CONDITION	51
4.6.6	TEST RESULTS	51
5.	PHOTOGRAPHS OF THE TEST CONFIGURATION.....	77
6.	INFORMATION ON THE TESTING LABORATORIES	78
7.	APPENDIX A - MODIFICATIONS RECORDERS FOR ENGINEERING CHANGES TO THE EUT BY THE LAB.....	79



A D T

RELEASE CONTROL RECORD

ISSUE NO.	REASON FOR CHANGE	DATE ISSUED
Original release	NA	Oct. 18, 2011
RF991117C18B R1	Modify model name	Nov. 11, 2011



1. CERTIFICATION

PRODUCT: Wireless N Home Router
MODEL NO.: DIR-615
BRAND: D-Link
APPLICANT: D-Link Corporation
TEST SAMPLE: ENGINEERING SAMPLE
TESTED: Oct. 04 ~ Oct. 14, 2011
STANDARDS: **FCC Part 15, Subpart C**
ANSI C63.4-2003
ANSI C63.10-2009

The above equipment (Model: DIR-615) has been tested by **Bureau Veritas Consumer Products Services (H.K.) Ltd., Taoyuan Branch**, and found compliance with the requirement of the above standards. The test record, data evaluation & Equipment Under Test (EUT) configurations represented herein are true and accurate accounts of the measurements of the sample's EMC characteristics under the conditions specified in this report.

PREPARED BY : Andrea Hsia DATE: Nov. 11, 2011
Andrea Hsia / Specialist

APPROVED BY : Gary Chang , DATE: Nov. 11, 2011
Gary Chang / Technical Manager

2. SUMMARY OF TEST RESULTS

The EUT has been tested according to the following specifications:

APPLIED STANDARD: FCC PART 15, SUBPART C (SECTION 15.247)			
STANDARD SECTION	TEST TYPE AND LIMIT	RESULT	REMARK
15.207	AC Power Conducted Emission	PASS	Meet the requirement of limit. Minimum passing margin is -2.98dB at 0.158MHz.
15.247(a)(2)	Spectrum Bandwidth of a Direct Sequence Spread Spectrum System Limit: min. 500kHz	PASS	Meet the requirement of limit.
15.247(b)	Maximum Output Power Limit: max. 30dBm	PASS	Meet the requirement of limit.
15.247(d)	Radiated Emissions Limit: Table 15.209	PASS	Meet the requirement of limit. Minimum passing margin is -1.1dB at 4874.00MHz.
15.247(e)	Power Spectral Density Limit: max. 8dBm	PASS	Meet the requirement of limit.
15.247(d)	Band Edge Measurement Limit: 20dB less than the peak value of fundamental frequency	PASS	Meet the requirement of limit.
15.203	Antenna Requirement	PASS	Antenna connector is UFL.

2.1 MEASUREMENT UNCERTAINTY

Where relevant, the following measurement uncertainty levels have been estimated for tests performed on the EUT as specified in CISPR 16-4-2:

MEASUREMENT	FREQUENCY	UNCERTAINTY
Conducted emissions	9kHz~30MHz	2.44 dB
Radiated emissions	30MHz ~ 200MHz	3.34 dB
	200MHz ~1000MHz	3.35 dB
	1GHz ~ 18GHz	2.26 dB
	18GHz ~ 40GHz	1.94 dB

This uncertainty represents an expanded uncertainty expressed at approximately the 95% confidence level using a coverage factor of $k = 2$.

3. GENERAL INFORMATION

3.1 GENERAL DESCRIPTION OF EUT

PRODUCT	Wireless N Home Router
MODEL NO.	DIR-615
FCC ID	KA2IR615H1
NOMINAL VOLTAGE	5Vdc (adapter)
MODULATION TYPE	CCK, DQPSK, DBPSK for DSSS 64QAM, 16QAM, QPSK, BPSK for OFDM
MODULATION TECHNOLOGY	DSSS, OFDM
TRANSFER RATE	802.11b:11.0/ 5.5/ 2.0/ 1.0Mbps 802.11g: 54.0/ 48.0/ 36.0/ 24.0/ 18.0/ 12.0/ 9.0/ 6.0Mbps 802.11n: up to 300.0Mbps
OPERATING FREQUENCY	2412.0 ~ 2462.0MHz
NUMBER OF CHANNEL	11 for 802.11b, 802.11g, 802.11n (20MHz) 7 for 802.11n (40MHz)
OUTPUT POWER	309.0mW
ANTENNA TYPE	Dipole antenna with 2dBi gain
ANTENNA CONNECTOR	UFL
DATA CABLE	NA
I/O PORTS	RJ45
ACCESSORY DEVICES	Adapter

NOTE:

- This report is prepared for FCC class II permissive change. This report is issued as a supplementary report of BV ADT report no.: RF991117C18A. The differences compared with original report are changing main board components and listing as below. Therefore, re-tested all the test items and presented in the test report.
Changing components as below.
* PCB took off shielding cover
* Change adapter.
* Change SDRAM from 16MB*2 to 32MB*1
* Change model name.
- The EUT incorporates a MIMO function. Physically, the EUT provides two completed transmitters and two receivers.

MODULATION MODE	TX FUNCTION
802.11b	1TX
802.11g	1TX
802.11n (20MHz)	2TX
802.11n (40MHz)	2TX

3. The EUT were powered by the following adapter:

BRAND:	D-LINK
MODEL:	SAI005B US
INPUT:	100-240Vac, 0.2A, 47-63Hz
OUTPUT:	+5Vdc, 1.0A
POWER LINE:	1.5m non-shielded cable without core

4. The above EUT information is declared by manufacturer and for more detailed features description, please refer to the manufacturer's specifications or user's manual.

3.2 DESCRIPTION OF TEST MODES

11 channels are provided for 802.11b, 802.11g and 802.11n (20MHz):

CHANNEL	FREQUENCY	CHANNEL	FREQUENCY
1	2412MHz	7	2442MHz
2	2417MHz	8	2447MHz
3	2422MHz	9	2452MHz
4	2427MHz	10	2457MHz
5	2432MHz	11	2462MHz
6	2437MHz		

7 channels are provided for 802.11n (40MHz):

CHANNEL	FREQUENCY	CHANNEL	FREQUENCY
1	2422MHz	5	2442MHz
2	2427MHz	6	2447MHz
3	2432MHz	7	2452MHz
4	2437MHz		

3.2.1 CONFIGURATION OF SYSTEM UNDER TEST

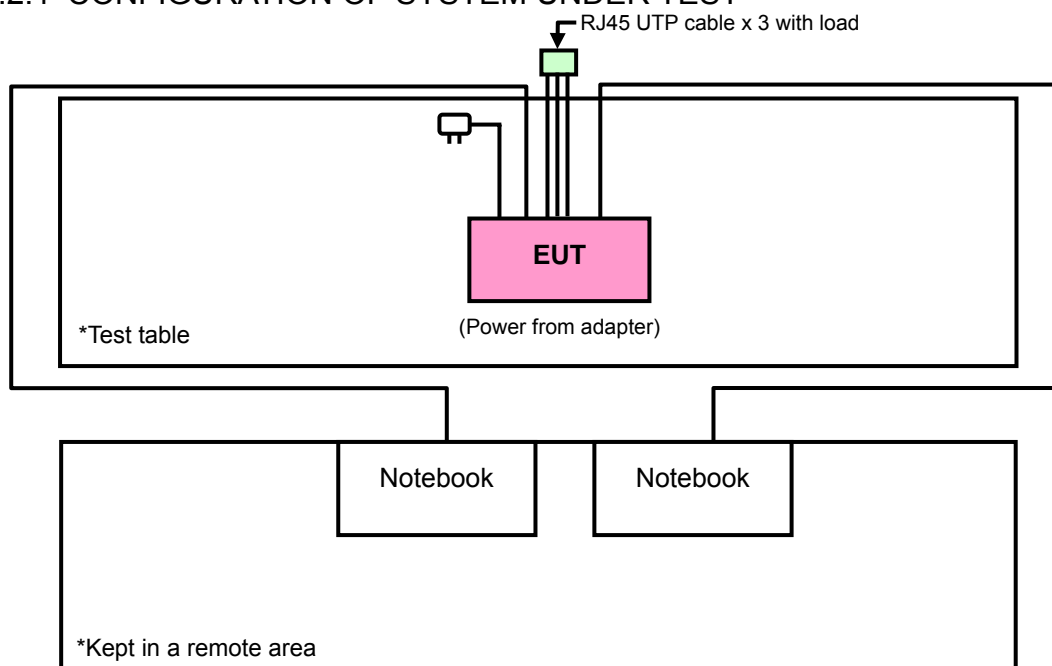

3.2.2 TEST MODE APPLICABILITY AND TESTED CHANNEL DETAIL

EUT CONFIGURE MODE	APPLICABLE TO				DESCRIPTION
	RE \geq 1G	RE<1G	PLC	APCM	
-	√	√	√	√	-

Where **RE \geq 1G**: Radiated Emission above 1GHz **RE<1G**: Radiated Emission below 1GHz
PLC: Power Line Conducted Emission **APCM**: Antenna Port Conducted Measurement

RADIATED EMISSION TEST (ABOVE 1GHz):

- Pre-Scan has been conducted to determine the worst-case mode from all possible combinations between available modulations, data rates, XYZ axis and antenna ports (if EUT with antenna diversity architecture).
- Following channel(s) was (were) selected for the final test as listed below.

MODE	AVAILABLE CHANNEL	TESTED CHANNEL	MODULATION TECHNOLOGY	MODULATION TYPE	DATA RATE (Mbps)
802.11b	1 to 11	1, 6, 11	DSSS	DBPSK	1.0
802.11g	1 to 11	1, 6, 11	OFDM	BPSK	6.0
802.11n (20MHz)	1 to 11	1, 6, 11	OFDM	BPSK	7.2
802.11n (40MHz)	1 to 7	1, 4, 7	OFDM	BPSK	15.0

RADIATED EMISSION TEST (BELOW 1GHz):

- Pre-Scan has been conducted to determine the worst-case mode from all possible combinations between available modulations, data rates, XYZ axis and antenna ports (if EUT with antenna diversity architecture).
- Following channel(s) was (were) selected for the final test as listed below.

MODE	AVAILABLE CHANNEL	TESTED CHANNEL	MODULATION TECHNOLOGY	MODULATION TYPE	DATA RATE (Mbps)
802.11g	1 to 11	6	OFDM	BPSK	6.0

POWER LINE CONDUCTED EMISSION TEST:

- Pre-Scan has been conducted to determine the worst-case mode from all possible combinations between available modulations, data rates and antenna ports (if EUT with antenna diversity architecture).
- Following channel(s) was (were) selected for the final test as listed below.

MODE	AVAILABLE CHANNEL	TESTED CHANNEL	MODULATION TECHNOLOGY	MODULATION TYPE	DATA RATE (Mbps)
802.11g	1 to 11	6	OFDM	BPSK	6.0



BANDEDGE MEASUREMENT:

- Pre-Scan has been conducted to determine the worst-case mode from all possible combinations between available modulations, data rates and antenna ports (if EUT with antenna diversity architecture).
- Following channel(s) was (were) selected for the final test as listed below.

MODE	AVAILABLE CHANNEL	TESTED CHANNEL	MODULATION TECHNOLOGY	MODULATION TYPE	DATA RATE (Mbps)
802.11b	1 to 11	1, 11	DSSS	DBPSK	1.0
802.11g	1 to 11	1, 11	OFDM	BPSK	6.0
802.11n (20MHz)	1 to 11	1, 11	OFDM	BPSK	7.2
802.11n (40MHz)	1 to 7	1, 7	OFDM	BPSK	15.0

ANTENNA PORT CONDUCTED MEASUREMENT:

- This item includes all test value of each mode, but only includes spectrum plot of worst value of each mode.
- Pre-Scan has been conducted to determine the worst-case mode from all possible combinations between available modulations, data rates and antenna ports (if EUT with antenna diversity architecture).
- Following channel(s) was (were) selected for the final test as listed below.

MODE	AVAILABLE CHANNEL	TESTED CHANNEL	MODULATION TECHNOLOGY	MODULATION TYPE	DATA RATE (Mbps)
802.11b	1 to 11	1, 6, 11	DSSS	DBPSK	1.0
802.11g	1 to 11	1, 6, 11	OFDM	BPSK	6.0
802.11n (20MHz)	1 to 11	1, 6, 11	OFDM	BPSK	7.2
802.11n (40MHz)	1 to 7	1, 4, 7	OFDM	BPSK	15.0

TEST CONDITION:

APPLICABLE TO	ENVIRONMENTAL CONDITIONS	INPUT POWER	TESTED BY
RE \geq 1G	25deg. C, 65%RH	120Vac, 60Hz	David Huang
RE $<$ 1G	25deg. C, 65%RH	120Vac, 60Hz	David Huang
PLC	24deg. C, 64%RH	120Vac, 60Hz	Skys Huang
APCM	25deg. C, 65%RH	120Vac, 60Hz	David Huang

3.3 GENERAL DESCRIPTION OF APPLIED STANDARDS

The EUT is a RF Product. According to the specifications of the manufacturer, it must comply with the requirements of the following standards:

FCC Part 15, Subpart C (15.247)

ANSI C63.4-2003

ANSI C63.10-2009

All test items have been performed and recorded as per the above standards.

NOTE: The EUT is also considered as a kind of computer peripheral, because the connection to computer is necessary for typical use. It has been verified to comply with the requirements of FCC Part 15, Subpart B, Class B (DoC). The test report has been issued separately.

3.4 DESCRIPTION OF SUPPORT UNITS

The EUT has been tested as an independent unit together with other necessary accessories or support units. The following support units or accessories were used to form a representative test configuration during the tests.

NO.	PRODUCT	BRAND	MODEL NO.	SERIAL NO.	FCC ID
1	NOTEBOOK	DELL	D531	CN-0XM006-4864 3-81U-2973	QDS-BRCM1020
2	NOTEBOOK	DELL	D830	10026042688	NA

NO.	SIGNAL CABLE DESCRIPTION OF THE ABOVE SUPPORT UNITS
1	10m RJ45 UTP cable
2	10m RJ45 UTP cable

NOTE:

1. All power cords of the above support units are non shielded (1.8m).
2. Items 1, 2 acted as communication partners to transfer data.

4. TEST TYPES AND RESULTS

4.1 RADIATED EMISSION MEASUREMENT

4.1.1 LIMITS OF RADIATED EMISSION MEASUREMENT

Radiated emissions which fall in the restricted bands, as defined in Section 15.205(a), must also comply with the radiated emission limits specified in Section 15.209(a). Other emissions shall be at least 20dB below the highest level of the desired power.

FREQUENCIES (MHz)	FIELD STRENGTH (microvolts/meter)	MEASUREMENT DISTANCE (meters)
0.009 ~ 0.490	2400/F(kHz)	300
0.490 ~ 1.705	24000/F(kHz)	30
1.705 ~ 30.0	30	30
30 ~ 88	100	3
88 ~ 216	150	3
216 ~ 960	200	3
Above 960	500	3

NOTE:

1. The lower limit shall apply at the transition frequencies.
2. Emission level (dBuV/m) = 20 log Emission level (uV/m).
3. As shown in 15.35(b), for frequencies above 1000MHz, the field strength limits are based on average detector, however, the peak field strength of any emission shall not exceed the maximum permitted average limits, specified above by more than 20dB under any condition of modulation.



4.1.2 TEST INSTRUMENTS

DESCRIPTION & MANUFACTURER	MODEL NO.	SERIAL NO.	DATE OF CALIBRATION	DUE DATE OF CALIBRATION
Test Receiver ROHDE & SCHWARZ	ESIB7	100212	Aug. 02, 2011	Aug. 01, 2012
Spectrum Analyzer ROHDE & SCHWARZ	FSP 40	100041	Jul. 21, 2011	Jul. 20, 2012
BILOG Antenna SCHWARZBECK	VULB9168	9168-160	Apr. 13, 2011	Apr. 12, 2012
HORN Antenna SCHWARZBECK	9120D	209	Aug. 25, 2011	Aug. 24, 2012
HORN Antenna SCHWARZBECK	BBHA 9170	BBHA9170243	Dec. 27, 2010	Dec. 26, 2011
Preamplifier Agilent	8447D	2944A10633	Nov. 02, 2010	Nov. 01, 2011
Preamplifier Agilent	8449B	3008A01964	Nov. 02, 2010	Nov. 01, 2011
RF signal cable HUBER+SUHNNER	SUCOFLEX 104	295014/4	Aug. 19, 2011	Aug. 18, 2012
RF signal cable HUBER+SUHNNER	SUCOFLEX 104	12738/6	Aug. 19, 2011	Aug. 18, 2012
Software ADT.	ADT_Radiated_ V7.6.15.9.2	NA	NA	NA
Antenna Tower inn-co GmbH	MA 4000	013303	NA	NA
Antenna Tower Controller inn-co GmbH	CO2000	017303	NA	NA
Turn Table ADT.	TT100.	TT93021703	NA	NA
Turn Table Controller ADT.	SC100.	SC93021703	NA	NA

- NOTE:**
1. The calibration interval of the above test instruments is 12 months and the calibrations are traceable to NML/ROC and NIST/USA.
 2. The test was performed in HwaYa Chamber 3.
 3. The horn antenna and HP preamplifier (model: 8449B) are used only for the measurement of emission frequency above 1GHz if tested.
 4. The FCC Site Registration No. is 988962.
 5. The IC Site Registration No. is IC 7450F-3.

4.1.3 TEST PROCEDURES

- a. The EUT was placed on the top of a rotating table 0.8 meters above the ground at a 3 meters semi-anechoic chamber. The table was rotated 360 degrees to determine the position of the highest radiation.
- b. The EUT was set 3 meters away from the interference-receiving antenna, which was mounted on the top of a variable-height antenna tower.
- c. The antenna is a broadband antenna, and its height is varied from one meter to four meters above the ground to determine the maximum value of the field strength. Both horizontal and vertical polarizations of the antenna are set to make the measurement.
- d. For each suspected emission, the EUT was arranged to its worst case and then the antenna was tuned to heights from 1 meter to 4 meters and the rotatable table was turned from 0 degrees to 360 degrees to find the maximum reading.
- e. The test-receiver system was set to Peak Detect Function and Specified Bandwidth with Maximum Hold Mode.
- f. If the emission level of the EUT in peak mode was lower than the limit specified, then testing could be stopped and the peak values of the EUT would be reported. Otherwise the emissions would be re-tested one by one using peak, quasi-peak or average method as specified and then reported in a data sheet.

NOTE:

1. The resolution bandwidth and video bandwidth of test receiver/spectrum analyzer is 120kHz for Quasi-peak detection at frequency below 1GHz.
2. The resolution bandwidth of test receiver/spectrum analyzer is 100kHz and video bandwidth is 300kHz for Peak detection at frequency above 1GHz.
3. The resolution bandwidth of test receiver/spectrum analyzer is 1MHz and the video bandwidth is 10Hz for Average detection (AV) at frequency above 1GHz.
4. All modes of operation were investigated and the worst-case emissions are reported.

4.1.4 DEVIATION FROM TEST STANDARD

No deviation

4.1.5 TEST SETUP

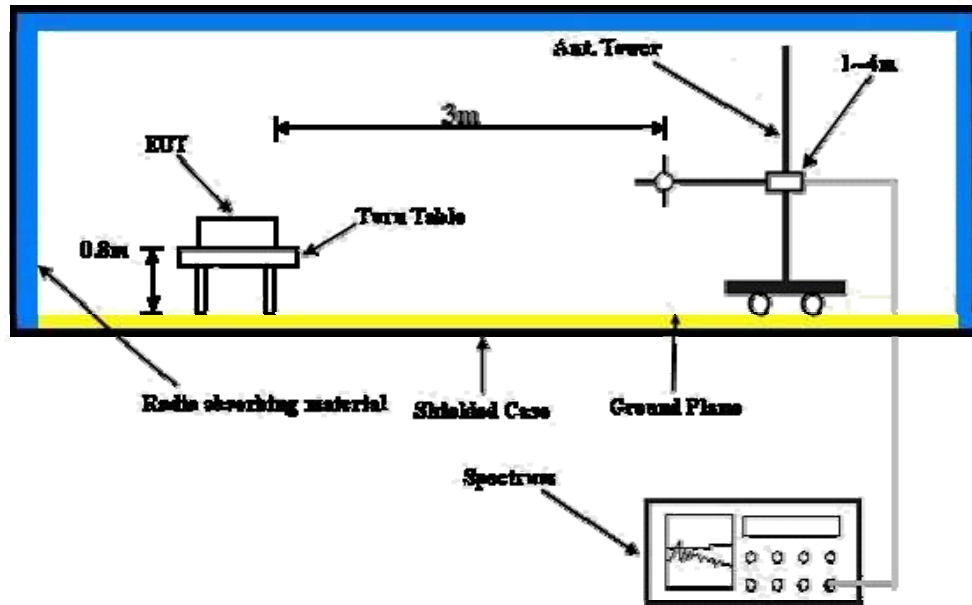

For the actual test configuration, please refer to the attached file (Test Setup Photo).

4.1.6 EUT OPERATING CONDITIONS

- a. Placed the EUT on the testing table.
- b. Prepared notebook systems outside of testing area to act as communication partners.
- c. The communication partners connected with EUT via a RJ45 cable and run a test program (provided by manufacturer) to enable EUT under transmission condition continuously at specific channel frequency.
- d. The communication partner sent data to EUT by command "PING".

4.1.7 TEST RESULTS

802.11b

EUT TEST CONDITION		MEASUREMENT DETAIL	
CHANNEL	Channel 1	FREQUENCY RANGE	1 ~ 25GHz
INPUT POWER (SYSTEM)	120Vac, 60 Hz	DETECTOR FUNCTION	Peak (PK) Average (AV)
ENVIRONMENTAL CONDITIONS	25deg. C, 60%RH	TESTED BY	David Huang

ANTENNA POLARITY & TEST DISTANCE: HORIZONTAL AT 3 M								
NO.	FREQ. (MHz)	EMISSION LEVEL (dBuV/m)	LIMIT (dBuV/m)	MARGIN (dB)	ANTENNA HEIGHT (m)	TABLE ANGLE (Degree)	RAW VALUE (dBuV)	CORRECTION FACTOR (dB/m)
1	2390.00	56.2 PK	74.0	-17.8	1.20 H	175	25.10	31.10
2	2390.00	45.1 AV	54.0	-8.9	1.20 H	175	14.00	31.10
3	*2412.00	97.9 PK			1.20 H	175	66.70	31.20
4	*2412.00	94.5 AV			1.20 H	175	63.30	31.20
5	4824.00	48.6 PK	74.0	-25.4	1.00 H	263	11.70	36.90
6	4824.00	46.2 AV	54.0	-7.8	1.00 H	263	9.30	36.90
ANTENNA POLARITY & TEST DISTANCE: VERTICAL AT 3 M								
NO.	FREQ. (MHz)	EMISSION LEVEL (dBuV/m)	LIMIT (dBuV/m)	MARGIN (dB)	ANTENNA HEIGHT (m)	TABLE ANGLE (Degree)	RAW VALUE (dBuV)	CORRECTION FACTOR (dB/m)
1	2390.00	57.3 PK	74.0	-16.7	1.03 V	264	26.20	31.10
2	2390.00	46.5 AV	54.0	-7.5	1.03 V	264	15.40	31.10
3	*2412.00	102.9 PK			1.03 V	264	71.70	31.20
4	*2412.00	99.3 AV			1.03 V	264	68.10	31.20
5	4824.00	54.8 PK	74.0	-19.2	1.01 V	78	17.90	36.90
6	4824.00	52.5 AV	54.0	-1.5	1.01 V	78	15.60	36.90

- REMARKS:**
1. Emission level (dBuV/m) = Raw Value (dBuV) + Correction Factor (dB/m).
 2. Correction Factor (dB/m) = Antenna Factor (dB/m) + Cable Factor (dB).
 3. The other emission levels were very low against the limit.
 4. Margin value = Emission level – Limit value.
 5. “ * “: Fundamental frequency.



EUT TEST CONDITION		MEASUREMENT DETAIL	
CHANNEL	Channel 6	FREQUENCY RANGE	1 ~ 25GHz
INPUT POWER (SYSTEM)	120Vac, 60 Hz	DETECTOR FUNCTION	Peak (PK) Average (AV)
ENVIRONMENTAL CONDITIONS	25deg. C, 60%RH	TESTED BY	David Huang

ANTENNA POLARITY & TEST DISTANCE: HORIZONTAL AT 3 M								
NO.	FREQ. (MHz)	EMISSION LEVEL (dBuV/m)	LIMIT (dBuV/m)	MARGIN (dB)	ANTENNA HEIGHT (m)	TABLE ANGLE (Degree)	RAW VALUE (dBuV)	CORRECTION FACTOR (dB/m)
1	2390.00	54.3 PK	74.0	-19.7	1.20 H	269	23.20	31.10
2	2390.00	45.2 AV	54.0	-8.8	1.20 H	269	14.10	31.10
3	*2437.00	100.6 PK			1.20 H	269	69.30	31.30
4	*2437.00	96.7 AV			1.20 H	269	65.40	31.30
5	4874.00	50.2 PK	74.0	-23.8	1.10 H	223	13.20	37.00
6	4874.00	47.6 AV	54.0	-6.4	1.10 H	223	10.60	37.00
ANTENNA POLARITY & TEST DISTANCE: VERTICAL AT 3 M								
NO.	FREQ. (MHz)	EMISSION LEVEL (dBuV/m)	LIMIT (dBuV/m)	MARGIN (dB)	ANTENNA HEIGHT (m)	TABLE ANGLE (Degree)	RAW VALUE (dBuV)	CORRECTION FACTOR (dB/m)
1	2390.00	56.9 PK	74.0	-17.1	1.31 V	217	25.80	31.10
2	2390.00	46.6 AV	54.0	-7.4	1.31 V	217	15.50	31.10
3	*2437.00	105.6 PK			1.31 V	217	74.30	31.30
4	*2437.00	101.8 AV			1.31 V	217	70.50	31.30
5	4874.00	55.1 PK	74.0	-18.9	1.00 V	45	18.10	37.00
6	4874.00	52.9 AV	54.0	-1.1	1.00 V	45	15.90	37.00

- REMARKS:**
1. Emission level (dBuV/m) = Raw Value (dBuV) + Correction Factor (dB/m).
 2. Correction Factor (dB/m) = Antenna Factor (dB/m) + Cable Factor (dB).
 3. The other emission levels were very low against the limit.
 4. Margin value = Emission level – Limit value.
 5. “ * ”: Fundamental frequency.



EUT TEST CONDITION		MEASUREMENT DETAIL	
CHANNEL	Channel 11	FREQUENCY RANGE	1 ~ 25GHz
INPUT POWER (SYSTEM)	120Vac, 60 Hz	DETECTOR FUNCTION	Peak (PK) Average (AV)
ENVIRONMENTAL CONDITIONS	25deg. C, 60%RH	TESTED BY	David Huang

ANTENNA POLARITY & TEST DISTANCE: HORIZONTAL AT 3 M								
NO.	FREQ. (MHz)	EMISSION LEVEL (dBuV/m)	LIMIT (dBuV/m)	MARGIN (dB)	ANTENNA HEIGHT (m)	TABLE ANGLE (Degree)	RAW VALUE (dBuV)	CORRECTION FACTOR (dB/m)
1	*2462.00	100.1 PK			1.20 H	314	68.70	31.40
2	*2462.00	96.3 AV			1.20 H	314	64.90	31.40
3	2483.50	54.3 PK	74.0	-19.7	1.20 H	314	22.80	31.50
4	2483.50	43.5 AV	54.0	-10.5	1.20 H	314	12.00	31.50
5	4924.00	48.4 PK	74.0	-25.6	1.00 H	298	11.30	37.10
6	4924.00	46.2 AV	54.0	-7.8	1.00 H	298	9.10	37.10
ANTENNA POLARITY & TEST DISTANCE: VERTICAL AT 3 M								
NO.	FREQ. (MHz)	EMISSION LEVEL (dBuV/m)	LIMIT (dBuV/m)	MARGIN (dB)	ANTENNA HEIGHT (m)	TABLE ANGLE (Degree)	RAW VALUE (dBuV)	CORRECTION FACTOR (dB/m)
1	*2462.00	105.1 PK			1.01 V	241	73.70	31.40
2	*2462.00	101.4 AV			1.01 V	241	70.00	31.40
3	2483.50	58.9 PK	74.0	-15.1	1.01 V	241	27.40	31.50
4	2483.50	48.5 AV	54.0	-5.5	1.01 V	241	17.00	31.50
5	4924.00	52.9 PK	74.0	-21.1	1.11 V	45	15.80	37.10
6	4924.00	49.9 AV	54.0	-4.1	1.11 V	45	12.80	37.10

- REMARKS:**
1. Emission level (dBuV/m) = Raw Value (dBuV) + Correction Factor (dB/m).
 2. Correction Factor (dB/m) = Antenna Factor (dB/m) + Cable Factor (dB).
 3. The other emission levels were very low against the limit.
 4. Margin value = Emission level – Limit value.
 5. “ * “: Fundamental frequency.



802.11g

EUT TEST CONDITION		MEASUREMENT DETAIL	
CHANNEL	Channel 1	FREQUENCY RANGE	1 ~ 25GHz
INPUT POWER (SYSTEM)	120Vac, 60 Hz	DETECTOR FUNCTION	Peak (PK) Average (AV)
ENVIRONMENTAL CONDITIONS	25deg. C, 60%RH	TESTED BY	David Huang

ANTENNA POLARITY & TEST DISTANCE: HORIZONTAL AT 3 M								
NO.	FREQ. (MHz)	EMISSION LEVEL (dBuV/m)	LIMIT (dBuV/m)	MARGIN (dB)	ANTENNA HEIGHT (m)	TABLE ANGLE (Degree)	RAW VALUE (dBuV)	CORRECTION FACTOR (dB/m)
1	2390.00	61.8 PK	74.0	-12.2	1.28 H	134	30.70	31.10
2	2390.00	45.9 AV	54.0	-8.1	1.28 H	134	14.80	31.10
3	*2412.00	102.6 PK			1.28 H	134	71.40	31.20
4	*2412.00	92.6 AV			1.28 H	134	61.40	31.20
5	4824.00	54.8 PK	74.0	-19.2	1.35 H	20	17.90	36.90
6	4824.00	39.5 AV	54.0	-14.5	1.35 H	20	2.60	36.90
ANTENNA POLARITY & TEST DISTANCE: VERTICAL AT 3 M								
NO.	FREQ. (MHz)	EMISSION LEVEL (dBuV/m)	LIMIT (dBuV/m)	MARGIN (dB)	ANTENNA HEIGHT (m)	TABLE ANGLE (Degree)	RAW VALUE (dBuV)	CORRECTION FACTOR (dB/m)
1	2390.00	70.6 PK	74.0	-3.4	1.08 V	247	39.50	31.10
2	2390.00	52.3 AV	54.0	-1.7	1.08 V	247	21.20	31.10
3	*2412.00	107.4 PK			1.08 V	247	76.20	31.20
4	*2412.00	97.6 AV			1.08 V	247	66.40	31.20
5	4824.00	54.0 PK	74.0	-20.0	1.34 V	129	17.10	36.90
6	4824.00	40.0 AV	54.0	-14.0	1.34 V	129	3.10	36.90

- REMARKS:**
1. Emission level (dBuV/m) = Raw Value (dBuV) + Correction Factor (dB/m).
 2. Correction Factor (dB/m) = Antenna Factor (dB/m) + Cable Factor (dB).
 3. The other emission levels were very low against the limit.
 4. Margin value = Emission level – Limit value.
 5. “ * ”: Fundamental frequency.



EUT TEST CONDITION		MEASUREMENT DETAIL	
CHANNEL	Channel 6	FREQUENCY RANGE	1 ~ 25GHz
INPUT POWER (SYSTEM)	120Vac, 60 Hz	DETECTOR FUNCTION	Peak (PK) Average (AV)
ENVIRONMENTAL CONDITIONS	25deg. C, 60%RH	TESTED BY	David Huang

ANTENNA POLARITY & TEST DISTANCE: HORIZONTAL AT 3 M								
NO.	FREQ. (MHz)	EMISSION LEVEL (dBuV/m)	LIMIT (dBuV/m)	MARGIN (dB)	ANTENNA HEIGHT (m)	TABLE ANGLE (Degree)	RAW VALUE (dBuV)	CORRECTION FACTOR (dB/m)
1	*2437.00	103.3 PK			1.27 H	134	72.00	31.30
2	*2437.00	93.4 AV			1.27 H	134	62.10	31.30
3	4874.00	55.3 PK	74.0	-18.7	1.33 H	20	18.30	37.00
4	4874.00	37.7 AV	54.0	-16.3	1.33 H	20	0.70	37.00
5	7311.00	49.9 PK	74.0	-24.1	1.33 H	165	6.80	43.10
6	7311.00	37.2 AV	54.0	-16.8	1.33 H	165	-5.90	43.10
ANTENNA POLARITY & TEST DISTANCE: VERTICAL AT 3 M								
NO.	FREQ. (MHz)	EMISSION LEVEL (dBuV/m)	LIMIT (dBuV/m)	MARGIN (dB)	ANTENNA HEIGHT (m)	TABLE ANGLE (Degree)	RAW VALUE (dBuV)	CORRECTION FACTOR (dB/m)
1	*2437.00	108.6 PK			1.07 V	245	77.30	31.30
2	*2437.00	98.7 AV			1.07 V	245	67.40	31.30
3	4874.00	56.7 PK	74.0	-17.3	1.00 V	120	19.70	37.00
4	4874.00	40.2 AV	54.0	-13.8	1.00 V	120	3.20	37.00
5	7311.00	50.6 PK	74.0	-23.4	1.00 V	169	7.40	43.20
6	7311.00	38.6 AV	54.0	-15.4	1.00 V	169	-4.60	43.20

- REMARKS:**
1. Emission level (dBuV/m) = Raw Value (dBuV) + Correction Factor (dB/m).
 2. Correction Factor (dB/m) = Antenna Factor (dB/m) + Cable Factor (dB).
 3. The other emission levels were very low against the limit.
 4. Margin value = Emission level – Limit value.
 5. “ * “: Fundamental frequency.



EUT TEST CONDITION		MEASUREMENT DETAIL	
CHANNEL	Channel 11	FREQUENCY RANGE	1 ~ 25GHz
INPUT POWER (SYSTEM)	120Vac, 60 Hz	DETECTOR FUNCTION	Peak (PK) Average (AV)
ENVIRONMENTAL CONDITIONS	25deg. C, 60%RH	TESTED BY	David Huang

ANTENNA POLARITY & TEST DISTANCE: HORIZONTAL AT 3 M								
NO.	FREQ. (MHz)	EMISSION LEVEL (dBuV/m)	LIMIT (dBuV/m)	MARGIN (dB)	ANTENNA HEIGHT (m)	TABLE ANGLE (Degree)	RAW VALUE (dBuV)	CORRECTION FACTOR (dB/m)
1	*2462.00	102.3 PK			1.24 H	134	70.90	31.40
2	*2462.00	92.6 AV			1.24 H	134	61.20	31.40
3	2483.50	65.7 PK	74.0	-8.3	1.24 H	134	34.30	31.40
4	2483.50	47.2 AV	54.0	-6.8	1.24 H	134	15.80	31.40
5	4924.00	47.9 PK	74.0	-26.1	1.00 H	224	10.80	37.10
6	4924.00	35.4 AV	54.0	-18.6	1.00 H	224	-1.70	37.10
ANTENNA POLARITY & TEST DISTANCE: VERTICAL AT 3 M								
NO.	FREQ. (MHz)	EMISSION LEVEL (dBuV/m)	LIMIT (dBuV/m)	MARGIN (dB)	ANTENNA HEIGHT (m)	TABLE ANGLE (Degree)	RAW VALUE (dBuV)	CORRECTION FACTOR (dB/m)
1	*2462.00	107.6 PK			1.05 V	236	76.20	31.40
2	*2462.00	98.0 AV			1.05 V	236	66.60	31.40
3	2483.50	72.1 PK	74.0	-1.9	1.05 V	236	40.70	31.40
4	2483.50	51.8 AV	54.0	-2.2	1.05 V	236	20.40	31.40
5	4924.00	55.5 PK	74.0	-18.5	1.22 V	123	18.40	37.10
6	4924.00	36.9 AV	54.0	-17.1	1.22 V	123	-0.20	37.10

- REMARKS:**
1. Emission level (dBuV/m) = Raw Value (dBuV) + Correction Factor (dB/m).
 2. Correction Factor (dB/m) = Antenna Factor (dB/m) + Cable Factor (dB).
 3. The other emission levels were very low against the limit.
 4. Margin value = Emission level – Limit value.
 5. “ * “: Fundamental frequency.



802.11n (20MHz)

EUT TEST CONDITION		MEASUREMENT DETAIL	
CHANNEL	Channel 1	FREQUENCY RANGE	1 ~ 25GHz
INPUT POWER (SYSTEM)	120Vac, 60 Hz	DETECTOR FUNCTION	Peak (PK) Average (AV)
ENVIRONMENTAL CONDITIONS	25deg. C, 60%RH	TESTED BY	David Huang

ANTENNA POLARITY & TEST DISTANCE: HORIZONTAL AT 3 M								
NO.	FREQ. (MHz)	EMISSION LEVEL (dBuV/m)	LIMIT (dBuV/m)	MARGIN (dB)	ANTENNA HEIGHT (m)	TABLE ANGLE (Degree)	RAW VALUE (dBuV)	CORRECTION FACTOR (dB/m)
1	2390.00	54.4 PK	74.0	-19.6	1.30 H	134	23.30	31.10
2	2390.00	44.5 AV	54.0	-9.5	1.30 H	134	13.40	31.10
3	*2412.00	100.8 PK			1.30 H	134	69.60	31.20
4	*2412.00	90.9 AV			1.30 H	134	59.70	31.20
5	4824.00	57.6 PK	74.0	-16.4	1.00 H	201	20.70	36.90
6	4824.00	42.1 AV	54.0	-11.9	1.00 H	201	5.20	36.90
ANTENNA POLARITY & TEST DISTANCE: VERTICAL AT 3 M								
NO.	FREQ. (MHz)	EMISSION LEVEL (dBuV/m)	LIMIT (dBuV/m)	MARGIN (dB)	ANTENNA HEIGHT (m)	TABLE ANGLE (Degree)	RAW VALUE (dBuV)	CORRECTION FACTOR (dB/m)
1	2390.00	61.7 PK	74.0	-12.3	1.34 V	126	30.60	31.10
2	2390.00	51.0 AV	54.0	-3.0	1.34 V	126	19.90	31.10
3	*2412.00	109.5 PK			1.34 V	126	78.30	31.20
4	*2412.00	98.9 AV			1.34 V	126	67.70	31.20
5	4824.00	64.3 PK	74.0	-9.7	1.00 V	28	27.40	36.90
6	4824.00	49.3 AV	54.0	-4.7	1.00 V	28	12.40	36.90

- REMARKS:**
1. Emission level (dBuV/m) = Raw Value (dBuV) + Correction Factor (dB/m).
 2. Correction Factor (dB/m) = Antenna Factor (dB/m) + Cable Factor (dB).
 3. The other emission levels were very low against the limit.
 4. Margin value = Emission level – Limit value.
 5. “ * ”: Fundamental frequency.



EUT TEST CONDITION		MEASUREMENT DETAIL	
CHANNEL	Channel 6	FREQUENCY RANGE	1 ~ 25GHz
INPUT POWER (SYSTEM)	120Vac, 60 Hz	DETECTOR FUNCTION	Peak (PK) Average (AV)
ENVIRONMENTAL CONDITIONS	25deg. C, 60%RH	TESTED BY	David Huang

ANTENNA POLARITY & TEST DISTANCE: HORIZONTAL AT 3 M								
NO.	FREQ. (MHz)	EMISSION LEVEL (dBuV/m)	LIMIT (dBuV/m)	MARGIN (dB)	ANTENNA HEIGHT (m)	TABLE ANGLE (Degree)	RAW VALUE (dBuV)	CORRECTION FACTOR (dB/m)
1	*2437.00	101.4 PK			1.27 H	135	70.10	31.30
2	*2437.00	91.8 AV			1.27 H	135	60.50	31.30
3	4874.00	56.0 PK	74.0	-18.0	1.00 H	199	19.00	37.00
4	4874.00	42.0 AV	54.0	-12.0	1.00 H	199	5.00	37.00
5	7311.00	50.5 PK	74.0	-23.5	1.10 H	145	7.30	43.20
6	7311.00	37.3 AV	54.0	-16.7	1.10 H	145	-5.90	43.20
ANTENNA POLARITY & TEST DISTANCE: VERTICAL AT 3 M								
NO.	FREQ. (MHz)	EMISSION LEVEL (dBuV/m)	LIMIT (dBuV/m)	MARGIN (dB)	ANTENNA HEIGHT (m)	TABLE ANGLE (Degree)	RAW VALUE (dBuV)	CORRECTION FACTOR (dB/m)
1	*2437.00	109.7 PK			1.14 V	167	78.40	31.30
2	*2437.00	99.7 AV			1.14 V	167	68.40	31.30
3	4874.00	63.3 PK	74.0	-10.7	1.25 V	26	26.30	37.00
4	4874.00	48.3 AV	54.0	-5.7	1.25 V	26	11.30	37.00
5	7311.00	50.6 PK	74.0	-23.4	1.00 V	157	7.40	43.20
6	7311.00	39.0 AV	54.0	-15.0	1.00 V	157	-4.20	43.20

- REMARKS:**
1. Emission level (dBuV/m) = Raw Value (dBuV) + Correction Factor (dB/m).
 2. Correction Factor (dB/m) = Antenna Factor (dB/m) + Cable Factor (dB).
 3. The other emission levels were very low against the limit.
 4. Margin value = Emission level – Limit value.
 5. “ * “: Fundamental frequency.



EUT TEST CONDITION		MEASUREMENT DETAIL	
CHANNEL	Channel 11	FREQUENCY RANGE	1 ~ 25GHz
INPUT POWER (SYSTEM)	120Vac, 60 Hz	DETECTOR FUNCTION	Peak (PK) Average (AV)
ENVIRONMENTAL CONDITIONS	25deg. C, 60%RH	TESTED BY	David Huang

ANTENNA POLARITY & TEST DISTANCE: HORIZONTAL AT 3 M								
NO.	FREQ. (MHz)	EMISSION LEVEL (dBuV/m)	LIMIT (dBuV/m)	MARGIN (dB)	ANTENNA HEIGHT (m)	TABLE ANGLE (Degree)	RAW VALUE (dBuV)	CORRECTION FACTOR (dB/m)
1	*2462.00	101.6 PK			1.23 H	134	70.20	31.40
2	*2462.00	91.4 AV			1.23 H	134	60.00	31.40
3	2483.50	55.7 PK	74.0	-18.3	1.23 H	134	24.30	31.40
4	2483.50	44.5 AV	54.0	-9.5	1.23 H	134	13.10	31.40
5	4924.00	56.1 PK	74.0	-17.9	1.00 H	199	19.00	37.10
6	4924.00	43.2 AV	54.0	-10.8	1.00 H	199	6.10	37.10
ANTENNA POLARITY & TEST DISTANCE: VERTICAL AT 3 M								
NO.	FREQ. (MHz)	EMISSION LEVEL (dBuV/m)	LIMIT (dBuV/m)	MARGIN (dB)	ANTENNA HEIGHT (m)	TABLE ANGLE (Degree)	RAW VALUE (dBuV)	CORRECTION FACTOR (dB/m)
1	*2462.00	109.7 PK			1.11 V	177	78.30	31.40
2	*2462.00	99.2 AV			1.11 V	177	67.80	31.40
3	2483.50	59.3 PK	74.0	-14.7	1.11 V	177	27.80	31.50
4	2483.50	48.6 AV	54.0	-5.4	1.11 V	177	17.10	31.50
5	4924.00	62.6 PK	74.0	-11.4	1.00 V	165	25.50	37.10
6	4924.00	48.3 AV	54.0	-5.7	1.00 V	165	11.20	37.10

- REMARKS:**
1. Emission level (dBuV/m) = Raw Value (dBuV) + Correction Factor (dB/m).
 2. Correction Factor (dB/m) = Antenna Factor (dB/m) + Cable Factor (dB).
 3. The other emission levels were very low against the limit.
 4. Margin value = Emission level – Limit value.
 5. “ * “: Fundamental frequency.



802.11n (40MHz)

EUT TEST CONDITION		MEASUREMENT DETAIL	
CHANNEL	Channel 1	FREQUENCY RANGE	1 ~ 25GHz
INPUT POWER (SYSTEM)	120Vac, 60 Hz	DETECTOR FUNCTION	Peak (PK) Average (AV)
ENVIRONMENTAL CONDITIONS	25deg. C, 60%RH	TESTED BY	David Huang

ANTENNA POLARITY & TEST DISTANCE: HORIZONTAL AT 3 M								
NO.	FREQ. (MHz)	EMISSION LEVEL (dBuV/m)	LIMIT (dBuV/m)	MARGIN (dB)	ANTENNA HEIGHT (m)	TABLE ANGLE (Degree)	RAW VALUE (dBuV)	CORRECTION FACTOR (dB/m)
1	2390.00	59.4 PK	74.0	-14.6	1.30 H	213	28.30	31.10
2	2390.00	47.3 AV	54.0	-6.7	1.30 H	213	16.20	31.10
3	*2422.00	99.7 PK			1.30 H	241	68.40	31.30
4	*2422.00	90.6 AV			1.30 H	241	59.30	31.30
5	4844.00	49.1 PK	74.0	-24.9	1.00 H	193	12.20	36.90
6	4844.00	36.4 AV	54.0	-17.6	1.00 H	193	-0.50	36.90
ANTENNA POLARITY & TEST DISTANCE: VERTICAL AT 3 M								
NO.	FREQ. (MHz)	EMISSION LEVEL (dBuV/m)	LIMIT (dBuV/m)	MARGIN (dB)	ANTENNA HEIGHT (m)	TABLE ANGLE (Degree)	RAW VALUE (dBuV)	CORRECTION FACTOR (dB/m)
1	2390.00	63.7 PK	74.0	-10.3	1.10 V	145	32.60	31.10
2	2390.00	51.7 AV	54.0	-2.3	1.10 V	145	20.60	31.10
3	*2422.00	105.3 PK			1.10 V	169	74.00	31.30
4	*2422.00	95.1 AV			1.10 V	169	63.80	31.30
5	4844.00	55.6 PK	74.0	-18.4	1.00 V	245	18.70	36.90
6	4844.00	43.1 AV	54.0	-10.9	1.00 V	245	6.20	36.90

- REMARKS:**
1. Emission level (dBuV/m) = Raw Value (dBuV) + Correction Factor (dB/m).
 2. Correction Factor (dB/m) = Antenna Factor (dB/m) + Cable Factor (dB).
 3. The other emission levels were very low against the limit.
 4. Margin value = Emission level – Limit value.
 5. “ * ”: Fundamental frequency.



EUT TEST CONDITION		MEASUREMENT DETAIL	
CHANNEL	Channel 4	FREQUENCY RANGE	1 ~ 25GHz
INPUT POWER (SYSTEM)	120Vac, 60 Hz	DETECTOR FUNCTION	Peak (PK) Average (AV)
ENVIRONMENTAL CONDITIONS	25deg. C, 60%RH	TESTED BY	David Huang

ANTENNA POLARITY & TEST DISTANCE: HORIZONTAL AT 3 M								
NO.	FREQ. (MHz)	EMISSION LEVEL (dBuV/m)	LIMIT (dBuV/m)	MARGIN (dB)	ANTENNA HEIGHT (m)	TABLE ANGLE (Degree)	RAW VALUE (dBuV)	CORRECTION FACTOR (dB/m)
1	*2437.00	100.0 PK			1.25 H	184	68.70	31.30
2	*2437.00	90.8 AV			1.25 H	184	59.50	31.30
3	4874.00	51.3 PK	74.0	-22.7	1.00 H	195	14.30	37.00
4	4874.00	39.5 AV	54.0	-14.5	1.00 H	195	2.50	37.00
5	7311.00	50.3 PK	74.0	-23.7	1.00 H	243	7.20	43.10
6	7311.00	38.6 AV	54.0	-15.4	1.00 H	243	-4.50	43.10
ANTENNA POLARITY & TEST DISTANCE: VERTICAL AT 3 M								
NO.	FREQ. (MHz)	EMISSION LEVEL (dBuV/m)	LIMIT (dBuV/m)	MARGIN (dB)	ANTENNA HEIGHT (m)	TABLE ANGLE (Degree)	RAW VALUE (dBuV)	CORRECTION FACTOR (dB/m)
1	*2437.00	105.9 PK			1.10 V	198	74.60	31.30
2	*2437.00	95.8 AV			1.10 V	198	64.50	31.30
3	4874.00	54.6 PK	74.0	-19.4	1.00 V	293	17.60	37.00
4	4874.00	41.9 AV	54.0	-12.1	1.00 V	293	4.90	37.00
5	7311.00	49.4 PK	74.0	-24.6	1.00 V	115	6.30	43.10
6	7311.00	39.6 AV	54.0	-14.4	1.00 V	115	-3.50	43.10

- REMARKS:**
1. Emission level (dBuV/m) = Raw Value (dBuV) + Correction Factor (dB/m).
 2. Correction Factor (dB/m) = Antenna Factor (dB/m) + Cable Factor (dB).
 3. The other emission levels were very low against the limit.
 4. Margin value = Emission level – Limit value.
 5. “ * “: Fundamental frequency.



EUT TEST CONDITION		MEASUREMENT DETAIL	
CHANNEL	Channel 7	FREQUENCY RANGE	1 ~ 25GHz
INPUT POWER (SYSTEM)	120Vac, 60 Hz	DETECTOR FUNCTION	Peak (PK) Average (AV)
ENVIRONMENTAL CONDITIONS	25deg. C, 60%RH	TESTED BY	David Huang

ANTENNA POLARITY & TEST DISTANCE: HORIZONTAL AT 3 M								
NO.	FREQ. (MHz)	EMISSION LEVEL (dBuV/m)	LIMIT (dBuV/m)	MARGIN (dB)	ANTENNA HEIGHT (m)	TABLE ANGLE (Degree)	RAW VALUE (dBuV)	CORRECTION FACTOR (dB/m)
1	*2452.00	100.3 PK			1.30 H	264	69.00	31.30
2	*2452.00	90.7 AV			1.30 H	264	59.40	31.30
3	2483.50	62.3 PK	74.0	-11.7	1.30 H	230	30.90	31.40
4	2483.50	47.7 AV	54.0	-6.3	1.30 H	230	16.30	31.40
5	4904.00	50.1 PK	74.0	-23.9	1.00 H	177	13.10	37.00
6	4904.00	38.9 AV	54.0	-15.1	1.00 H	177	1.90	37.00
ANTENNA POLARITY & TEST DISTANCE: VERTICAL AT 3 M								
NO.	FREQ. (MHz)	EMISSION LEVEL (dBuV/m)	LIMIT (dBuV/m)	MARGIN (dB)	ANTENNA HEIGHT (m)	TABLE ANGLE (Degree)	RAW VALUE (dBuV)	CORRECTION FACTOR (dB/m)
1	*2452.00	105.8 PK			1.10 V	201	74.50	31.30
2	*2452.00	95.4 AV			1.10 V	201	64.10	31.30
3	2483.50	64.7 PK	74.0	-9.3	1.00 V	183	33.30	31.40
4	2483.50	50.3 AV	54.0	-3.7	1.00 V	183	18.90	31.40
5	4904.00	53.6 PK	74.0	-20.4	1.20 V	224	16.60	37.00
6	4904.00	41.7 AV	54.0	-12.3	1.20 V	224	4.70	37.00

- REMARKS:**
1. Emission level (dBuV/m) = Raw Value (dBuV) + Correction Factor (dB/m).
 2. Correction Factor (dB/m) = Antenna Factor (dB/m) + Cable Factor (dB).
 3. The other emission levels were very low against the limit.
 4. Margin value = Emission level – Limit value.
 5. “ * “: Fundamental frequency.



BELOW 1GHz WORST-CASE DATA : 802.11g

EUT TEST CONDITION		MEASUREMENT DETAIL	
CHANNEL	Channel 6	FREQUENCY RANGE	Below 1000MHz
INPUT POWER (SYSTEM)	120Vac, 60 Hz	DETECTOR FUNCTION	Quasi-Peak
ENVIRONMENTAL CONDITIONS	25deg. C, 65%RH	TESTED BY	David Huang

ANTENNA POLARITY & TEST DISTANCE: HORIZONTAL AT 3 M								
NO.	FREQ. (MHz)	EMISSION LEVEL (dBuV/m)	LIMIT (dBuV/m)	MARGIN (dB)	ANTENNA HEIGHT (m)	TABLE ANGLE (Degree)	RAW VALUE (dBuV)	CORRECTION FACTOR (dB/m)
1	132.95	39.6 QP	43.5	-3.9	2.00 H	55	26.10	13.50
2	267.10	44.8 QP	46.0	-1.2	1.00 H	94	31.20	13.60
3	327.38	32.5 QP	46.0	-13.5	1.00 H	169	16.90	15.60
4	393.48	35.0 QP	46.0	-11.0	1.00 H	214	17.80	17.20
5	500.42	37.3 QP	46.0	-8.7	2.00 H	70	17.10	20.20
6	655.96	38.1 QP	46.0	-7.9	1.00 H	118	14.70	23.40
ANTENNA POLARITY & TEST DISTANCE: VERTICAL AT 3 M								
NO.	FREQ. (MHz)	EMISSION LEVEL (dBuV/m)	LIMIT (dBuV/m)	MARGIN (dB)	ANTENNA HEIGHT (m)	TABLE ANGLE (Degree)	RAW VALUE (dBuV)	CORRECTION FACTOR (dB/m)
1	33.79	37.9 QP	40.0	-2.1	1.00 V	154	25.50	12.40
2	57.12	38.1 QP	40.0	-1.9	2.00 V	226	24.60	13.50
3	103.78	38.8 QP	43.5	-4.7	1.00 V	40	28.10	10.70
4	267.10	37.7 QP	46.0	-8.3	3.00 V	151	24.10	13.60
5	393.48	34.9 QP	46.0	-11.1	1.00 V	160	17.70	17.20
6	500.42	40.2 QP	46.0	-5.8	1.00 V	175	20.00	20.20

- REMARKS:**
1. Emission level (dBuV/m) = Raw Value (dBuV) + Correction Factor (dB/m).
 2. Correction Factor (dB/m) = Antenna Factor (dB/m) + Cable Factor (dB).
 3. The other emission levels were very low against the limit.
 4. Margin value = Emission level – Limit value.

4.2 CONDUCTED EMISSION MEASUREMENT

4.2.1 LIMITS OF CONDUCTED EMISSION MEASUREMENT

FREQUENCY OF EMISSION (MHz)	CONDUCTED LIMIT (dB μ V)	
	Quasi-peak	Average
0.15 ~ 0.5	66 to 56	56 to 46
0.5 ~ 5	56	46
5 ~ 30	60	50

- NOTE:** 1. The lower limit shall apply at the transition frequencies.
2. The limit decreases in line with the logarithm of the frequency in the range of 0.15 to 0.50MHz.
3. All emanations from a class A/B digital device or system, including any network of conductors and apparatus connected thereto, shall not exceed the level of field strengths specified above.

4.2.2 TEST INSTRUMENTS

DESCRIPTION & MANUFACTURER	MODEL NO.	SERIAL NO.	DATE OF CALIBRATION	DUE DATE OF CALIBRATION
Test Receiver ROHDE & SCHWARZ	ESCS30	100289	Nov. 23, 2010	Nov. 22, 2011
RF signal cable Woken	5D-FB	Cable-HYCO2-01	Dec. 30, 2010	Dec. 29, 2011
LISN ROHDE & SCHWARZ	ESH2-Z5	100100	Jan. 06, 2011	Jan. 05, 2012
LISN ROHDE & SCHWARZ	ESH3-Z5	100312	Jul. 07, 2011	Jul. 06, 2012
V-LISN SCHWARZBECK	NNBL 8226-2	8226-142	Jun. 30, 2011	Jun. 29, 2012
LISN ROHDE & SCHWARZ	ENV216	100072	Jun. 10, 2011	Jun. 09, 2012
Software ADT	ADT_Cond_ V7.3.7	NA	NA	NA

- NOTE:** 1. The calibration interval of the above test instruments is 12 months and the calibrations are traceable to NML/ROC and NIST/USA.
2. The test was performed in HwaYa Shielded Room 2.
3. The VCCI Site Registration No. is C-2047.

4.2.3 TEST PROCEDURES

- a. The EUT was placed 0.4 meters from the conducting wall of the shielded room with EUT being connected to the power mains through a line impedance stabilization network (LISN). Other support units were connected to the power mains through another LISN. The two LISNs provide 50 ohm/ 50uH of coupling impedance for the measuring instrument.
- b. Both lines of the power mains connected to the EUT were checked for maximum conducted interference.
- c. The frequency range from 150kHz to 30MHz was searched. Emission levels under (Limit - 20dB) was not recorded.

NOTE: All modes of operation were investigated and the worst-case emissions are reported.

4.2.4 DEVIATION FROM TEST STANDARD

No deviation.

4.2.5 TEST SETUP

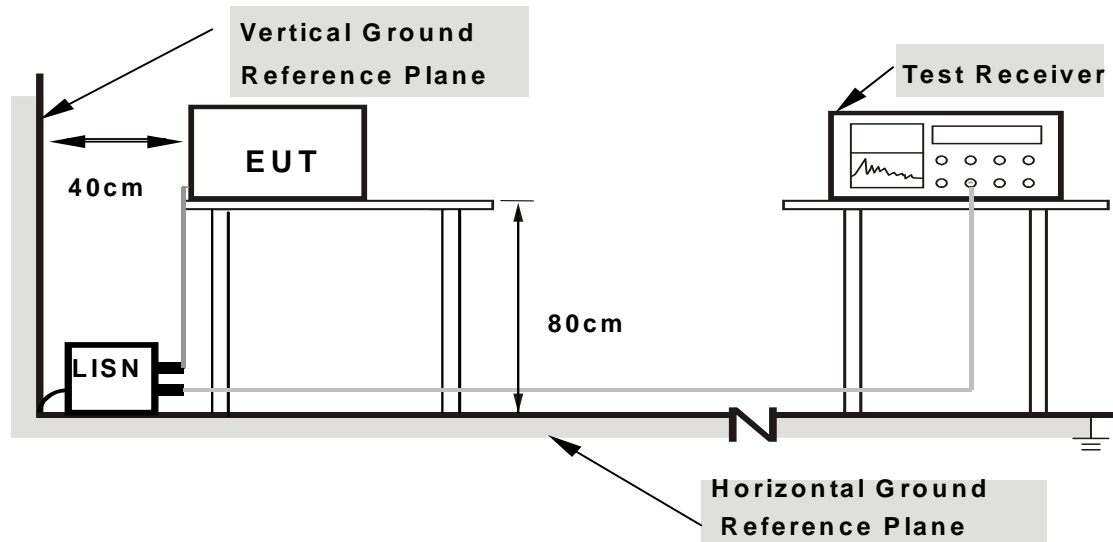

- Note:**
1. Support units were connected to second LISN.
 2. Both of LISNs (AMN) are 80 cm from EUT and at least 80 cm from other units and other metal planes

For the actual test configuration, please refer to the attached file (Test Setup Photo).

4.2.6 EUT OPERATING CONDITIONS

Same as 4.1.6.

4.2.7 TEST RESULTS

CONDUCTED WORST-CASE DATA : 802.11g

PHASE	Line 1	6dB BANDWIDTH	9kHz
-------	--------	---------------	------

No	Freq. [MHz]	Corr. Factor (dB)	Reading Value		Emission Level		Limit		Margin	
			[dB (uV)]		[dB (uV)]		[dB (uV)]		(dB)	
			Q.P.	AV.	Q.P.	AV.	Q.P.	AV.	Q.P.	AV.
1	0.158	0.15	62.45	47.79	62.60	47.94	65.58	55.58	-2.98	-7.64
2	0.168	0.15	59.57	40.15	59.72	40.30	65.05	55.05	-5.33	-14.75
3	0.193	0.15	56.95	37.24	57.10	37.39	63.91	53.91	-6.81	-16.52
4	0.209	0.15	56.71	36.88	56.86	37.03	63.26	53.26	-6.40	-16.23
5	0.244	0.15	54.71	38.83	54.86	38.98	61.97	51.97	-7.10	-12.98
6	0.275	0.16	51.83	36.27	51.99	36.43	60.97	50.97	-8.98	-14.54
7	0.318	0.16	48.34	-	48.50	-	59.76	49.76	-11.26	-
8	0.357	0.17	45.27	-	45.44	-	58.80	48.80	-13.36	-
9	0.396	0.17	42.72	-	42.89	-	57.93	47.93	-15.05	-
10	0.548	0.17	44.01	-	44.18	-	56.00	46.00	-11.82	-
11	0.642	0.18	36.87	-	37.05	-	56.00	46.00	-18.95	-
12	0.912	0.19	32.50	-	32.69	-	56.00	46.00	-23.31	-
13	2.805	0.26	31.95	-	32.21	-	56.00	46.00	-23.79	-
14	16.410	0.95	33.88	-	34.83	-	60.00	50.00	-25.17	-
15	18.188	1.04	28.85	-	29.89	-	60.00	50.00	-30.11	-

- REMARKS:**
1. Q.P. and AV. are abbreviations of quasi-peak and average individually.
 2. "-": The Quasi-peak reading value also meets average limit and measurement with the average detector is unnecessary.
 3. The emission levels of other frequencies were very low against the limit.
 4. Margin value = Emission level - Limit value
 5. Correction factor = Insertion loss + Cable loss
 6. Emission Level = Correction Factor + Reading Value.

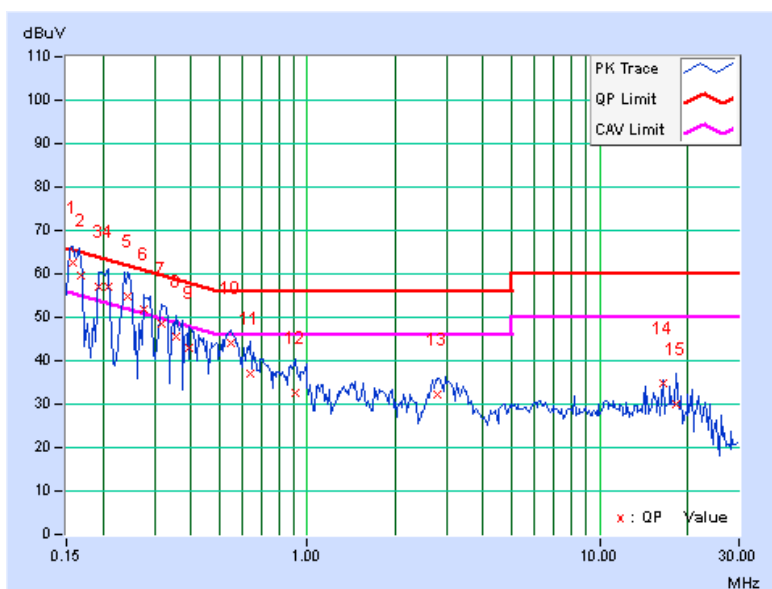

PHASE	Line 2	6dB BANDWIDTH	9kHz
-------	--------	---------------	------

No	Freq. [MHz]	Corr. Factor (dB)	Reading Value [dB (uV)]		Emission Level [dB (uV)]		Limit [dB (uV)]		Margin (dB)	
			Q.P.	AV.	Q.P.	AV.	Q.P.	AV.	Q.P.	AV.
1	0.162	0.16	60.97	42.65	61.13	42.81	65.38	55.38	-4.25	-12.57
2	0.205	0.17	56.68	37.54	56.85	37.71	63.42	53.42	-6.57	-15.71
3	0.240	0.17	54.36	35.88	54.53	36.05	62.10	52.10	-7.57	-16.05
4	0.271	0.18	49.57	-	49.75	-	61.08	51.08	-11.34	-
5	0.295	0.18	46.66	-	46.84	-	60.40	50.40	-13.56	-
6	0.318	0.18	47.30	-	47.48	-	59.76	49.76	-12.28	-
7	0.353	0.19	44.25	-	44.44	-	58.89	48.89	-14.45	-
8	0.548	0.19	38.95	-	39.14	-	56.00	46.00	-16.86	-
9	0.568	0.20	38.23	-	38.43	-	56.00	46.00	-17.57	-
10	2.914	0.27	31.58	-	31.85	-	56.00	46.00	-24.15	-
11	19.242	0.89	26.46	-	27.35	-	60.00	50.00	-32.65	-

- REMARKS:**
1. Q.P. and AV. are abbreviations of quasi-peak and average individually.
 2. "-": The Quasi-peak reading value also meets average limit and measurement with the average detector is unnecessary.
 3. The emission levels of other frequencies were very low against the limit.
 4. Margin value = Emission level - Limit value
 5. Correction factor = Insertion loss + Cable loss
 6. Emission Level = Correction Factor + Reading Value.

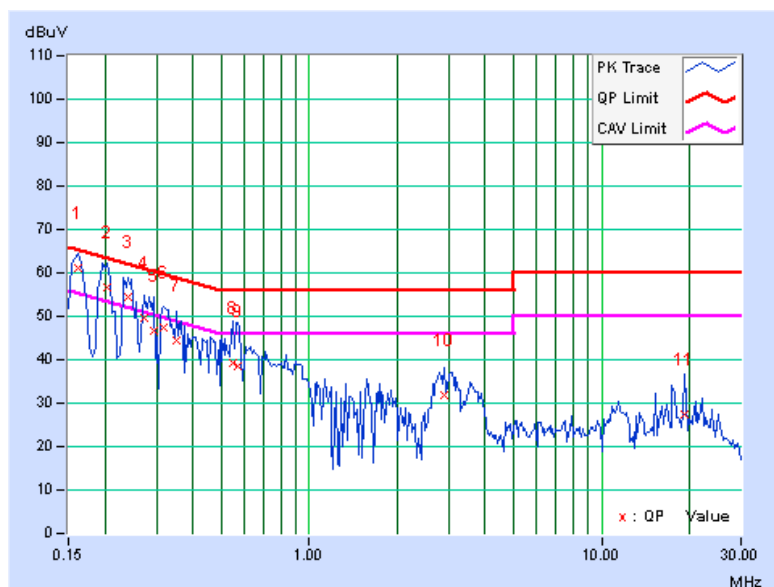



4.3 6dB BANDWIDTH MEASUREMENT

4.3.1 LIMITS OF 6dB BANDWIDTH MEASUREMENT

The minimum of 6dB Bandwidth Measurement is 0.5 MHz.

4.3.2 TEST INSTRUMENTS

DESCRIPTION & MANUFACTURER	MODEL NO.	SERIAL NO.	DATE OF CALIBRATION	DUE DATE OF CALIBRATION
SPECTRUM ANALYZER R&S	FSP40	100039	Feb. 23, 2011	Feb. 22, 2012

NOTE: The calibration interval of the above test instruments is 12 months and the calibrations are traceable to NML/ROC and NIST/USA.

4.3.3 TEST PROCEDURE

The transmitter output was connected to the spectrum analyzer through an attenuator. The bandwidth of the fundamental frequency was measured by spectrum analyzer with 100kHz RBW and 300kHz VBW. The 6dB bandwidth is defined as the total spectrum the power of which is higher than peak power minus 6dB.

4.3.4 DEVIATION FROM TEST STANDARD

No deviation.

4.3.5 TEST SETUP

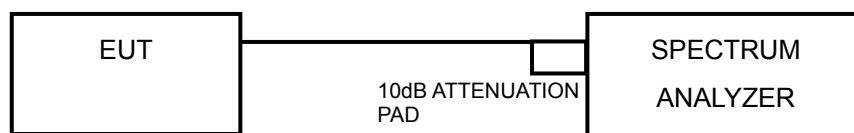

4.3.6 EUT OPERATING CONDITIONS

The software provided by client to enable the EUT under transmission condition continuously at lowest, middle and highest channel frequencies individually.

4.3.7 TEST RESULTS

802.11b

CHANNEL	CHANNEL FREQUENCY (MHz)	6dB BANDWIDTH (MHz)	MINIMUM LIMIT (MHz)	PASS / FAIL
1	2412	12.15	0.5	PASS
6	2437	12.15	0.5	PASS
11	2462	12.15	0.5	PASS

CH 11

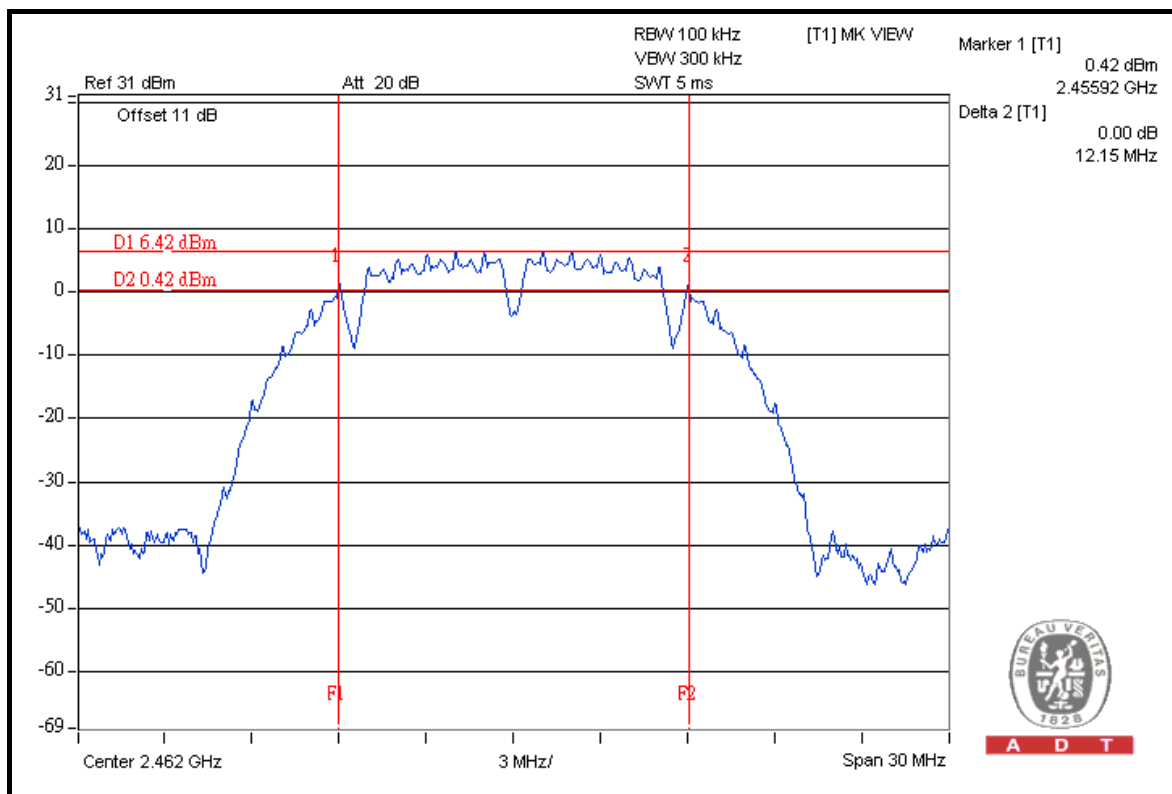

802.11g

CHANNEL	CHANNEL FREQUENCY (MHz)	6dB BANDWIDTH (MHz)	MINIMUM LIMIT (MHz)	PASS / FAIL
1	2412	16.43	0.5	PASS
6	2437	16.46	0.5	PASS
11	2462	16.43	0.5	PASS

CH 6

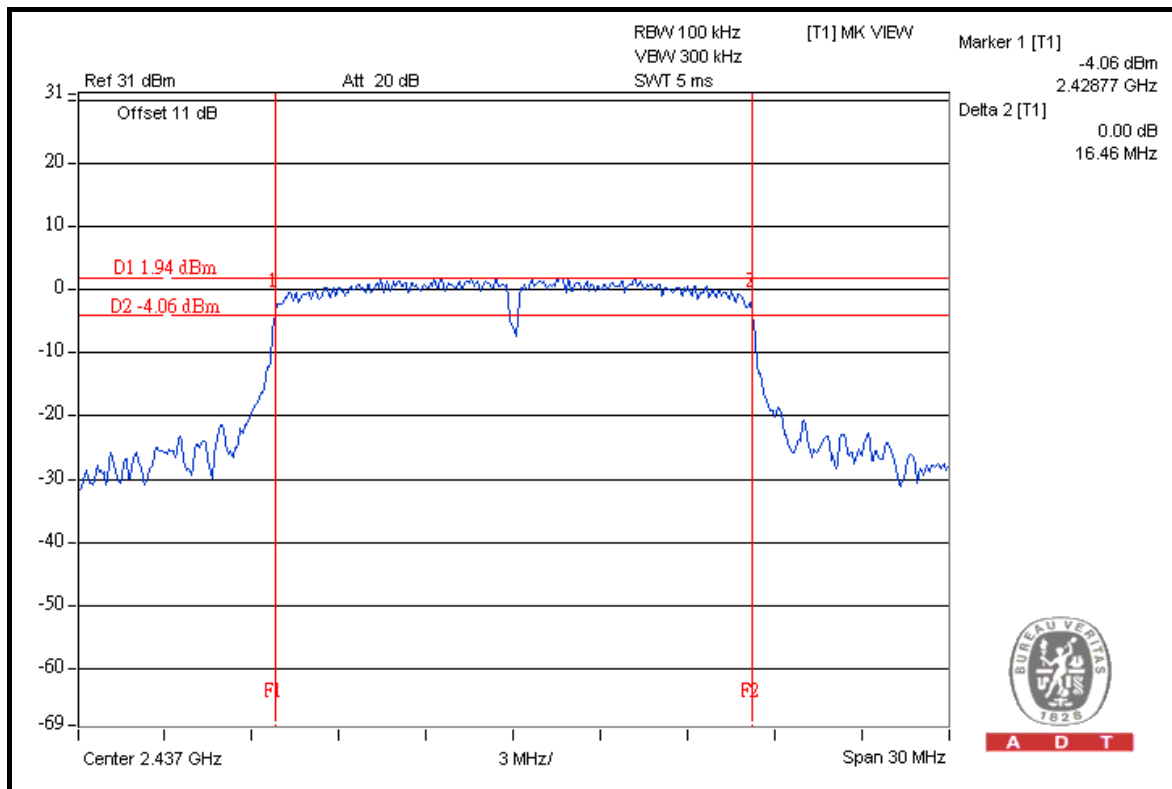

802.11n (20MHz)

CHANNEL	CHANNEL FREQUENCY (MHz)	6dB BANDWIDTH (MHz)		MINIMUM LIMIT (MHz)	PASS / FAIL
		CHAIN 0	CHAIN 1		
1	2412	17.06	17.03	0.5	PASS
6	2437	17.06	17.07	0.5	PASS
11	2462	17.06	17.06	0.5	PASS

FOR CHAIN 1: CH 6

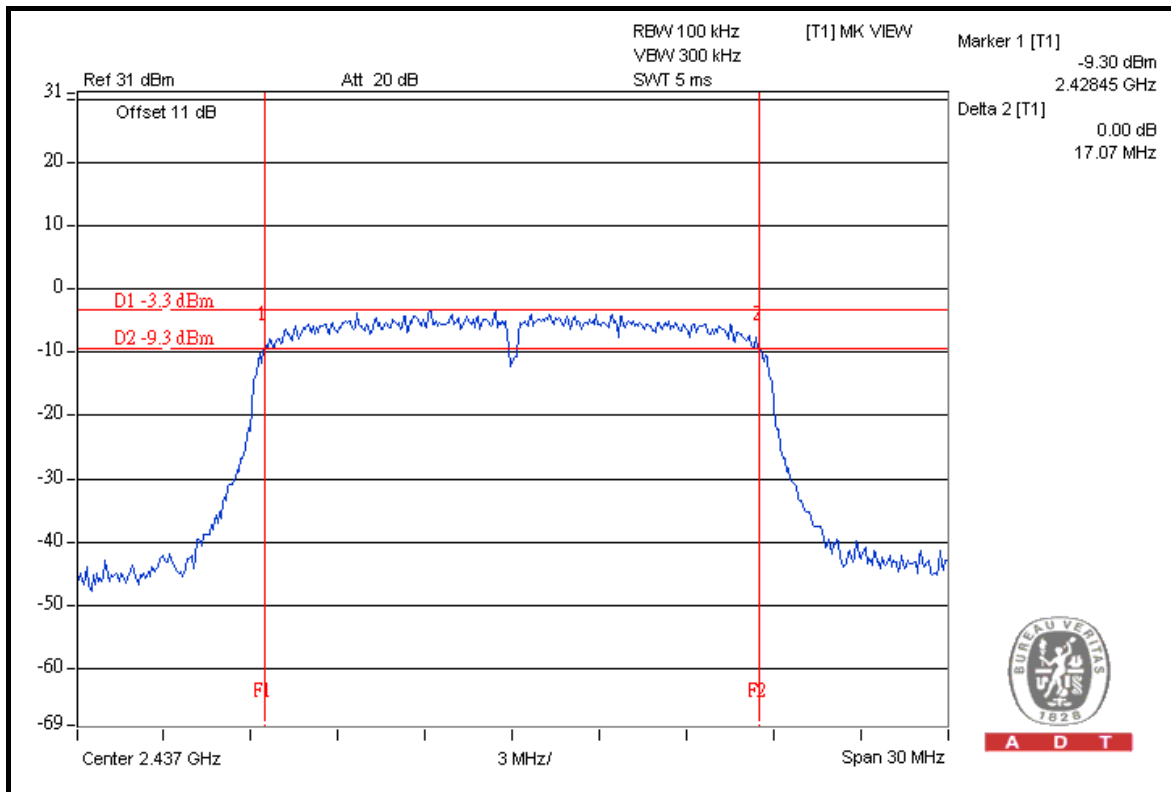

802.11n (40MHz)

CHANNEL	CHANNEL FREQUENCY (MHz)	6dB BANDWIDTH (MHz)		MINIMUM LIMIT (MHz)	PASS / FAIL
		CHAIN 0	CHAIN 1		
1	2422	35.18	35.46	0.5	PASS
4	2437	35.23	35.21	0.5	PASS
7	2452	35.24	35.48	0.5	PASS

FOR CHAIN 1: CH 7

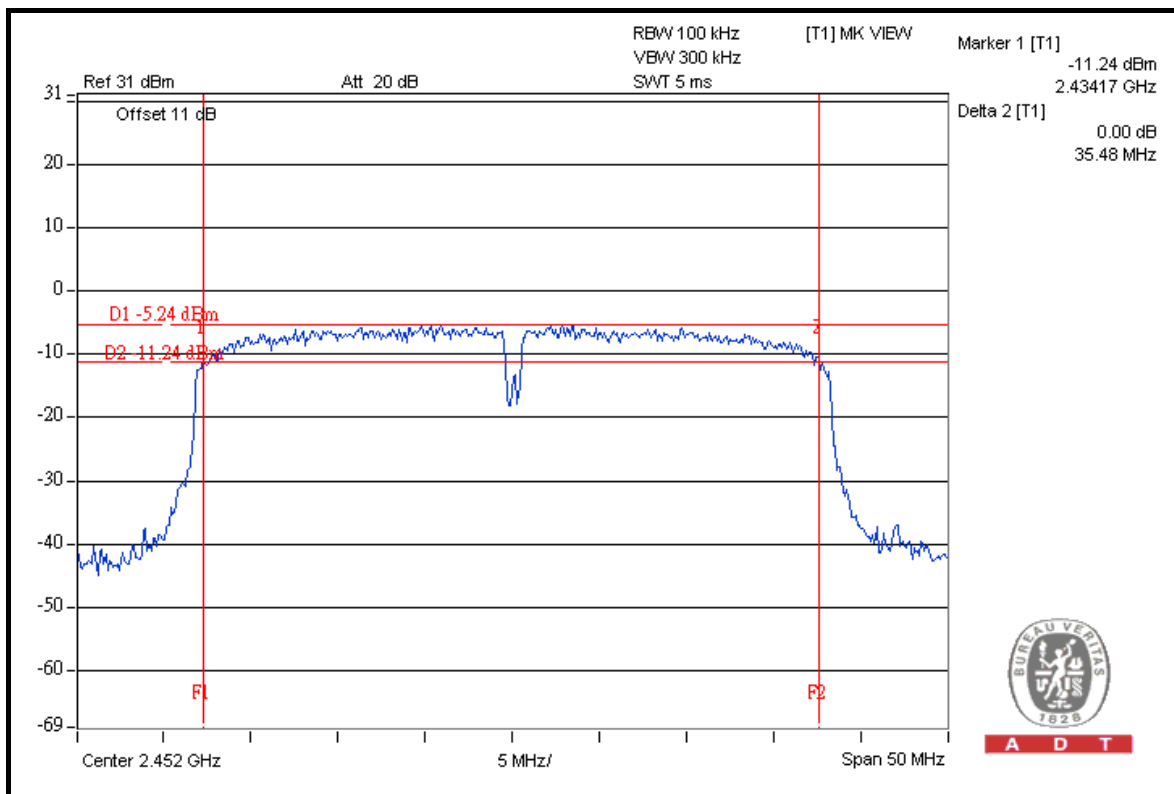



4.4 MAXIMUM OUTPUT POWER

4.4.1 LIMITS OF MAXIMUM OUTPUT POWER MEASUREMENT

The Maximum Output Power Measurement is 30dBm.

4.4.2 INSTRUMENTS

DESCRIPTION & MANUFACTURER	MODEL NO.	SERIAL NO.	DATE OF CALIBRATION	DUE DATE OF CALIBRATION
High Speed Peak Power Meter	ML2495A	0824011	Aug. 04, 2011	Aug. 03, 2012
Power Sensor	MA2411B	0738171	Aug. 04, 2011	Aug. 03, 2012

Note:

1. The calibration interval of the above test instruments is 12 months and the calibrations are traceable to NML/ROC and NIST/USA.
2. Measurement Bandwidth of ML2495A is 65MHz greater than 6dB bandwidth of emission.

4.4.3 TEST PROCEDURES

A power sensor was used on the output port of the EUT. A power meter was used to read the response of the power sensor. Record the power level.

4.4.4 DEVIATION FROM TEST STANDARD

No deviation.

4.4.5 TEST SETUP

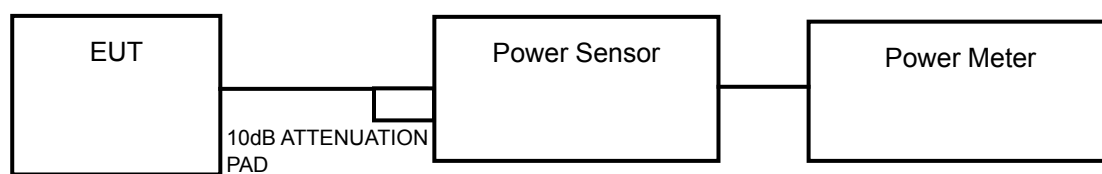

4.4.6 EUT OPERATING CONDITIONS

Same as Item 4.3.6.

4.4.7 TEST RESULTS

802.11b

CHANNEL	CHANNEL FREQUENCY (MHz)	POWER OUTPUT (dBm)	POWER OUTPUT (mW)	POWER LIMIT (dBm)	PASS/FAIL
1	2412	18.3	67.6	30	PASS
6	2437	20.3	107.2	30	PASS
11	2462	20.5	112.2	30	PASS

802.11g

CHANNEL	CHANNEL FREQUENCY (MHz)	POWER OUTPUT (dBm)	POWER OUTPUT (mW)	POWER LIMIT (dBm)	PASS/FAIL
1	2412	23.6	229.1	30	PASS
6	2437	24.9	309.0	30	PASS
11	2462	24.5	281.8	30	PASS

802.11n (20MHz)

CHAN.	CHAN. FREQ. (MHz)	POWER OUTPUT (dBm)		TOTAL POWER (mW)	TOTAL POWER (dBm)	POWER LIMIT (dBm)	PASS / FAIL
		CHAIN 0	CHAIN 1				
1	2412	20.3	20.6	222.0	23.5	30	PASS
6	2437	20.8	20.7	237.7	23.8	30	PASS
11	2462	21.6	21.1	273.4	24.4	30	PASS

802.11n (40MHz)

CHAN.	CHAN. FREQ. (MHz)	POWER OUTPUT (dBm)		TOTAL POWER (mW)	TOTAL POWER (dBm)	POWER LIMIT (dBm)	PASS / FAIL
		CHAIN 0	CHAIN 1				
1	2422	21.3	21.2	266.7	24.3	30	PASS
4	2437	21.5	21.3	276.2	24.4	30	PASS
7	2452	21.4	21.1	266.9	24.3	30	PASS



4.5 POWER SPECTRAL DENSITY MEASUREMENT

4.5.1 LIMITS OF POWER SPECTRAL DENSITY MEASUREMENT

The Maximum of Power Spectral Density Measurement is 8dBm.

4.5.2 TEST INSTRUMENTS

DESCRIPTION & MANUFACTURER	MODEL NO.	SERIAL NO.	DATE OF CALIBRATION	DUE DATE OF CALIBRATION
SPECTRUM ANALYZER R&S	FSP40	100039	Feb. 23, 2011	Feb. 22, 2012

NOTE: The calibration interval of the above test instruments is 12 months and the calibrations are traceable to NML/ROC and NIST/USA.

4.5.3 TEST PROCEDURE

The transmitter output was connected to the spectrum analyzer through an attenuator, the bandwidth of the fundamental frequency was measured with the spectrum analyzer using 3kHz RBW and 30kHz VBW, set sweep time = span/3kHz. The power spectral density was measured and recorded.

The sweep time is allowed to be longer than span/3kHz for a full response of the mixer in the spectrum analyzer.

Follow method 2 of KDB 662911 D01 Multiple Transmitter Output v01 to calculate total power density of 2 TX port.

4.5.4 DEVIATION FROM TEST STANDARD

No deviation.

4.5.5 TEST SETUP

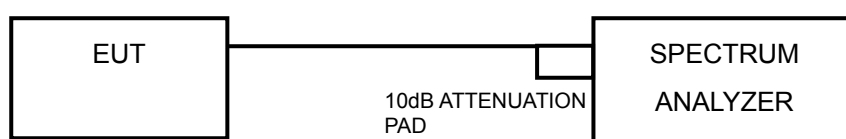

4.5.6 EUT OPERATING CONDITION

Same as Item 4.3.6

4.5.7 TEST RESULTS

802.11b

CHANNEL	CHANNEL FREQUENCY (MHz)	RF POWER LEVEL IN 3 kHz BW (dBm)	MAXIMUM LIMIT (dBm)	PASS/FAIL
1	2412	-13.8	8	PASS
6	2437	-11.1	8	PASS
11	2462	-11.0	8	PASS

CH 11

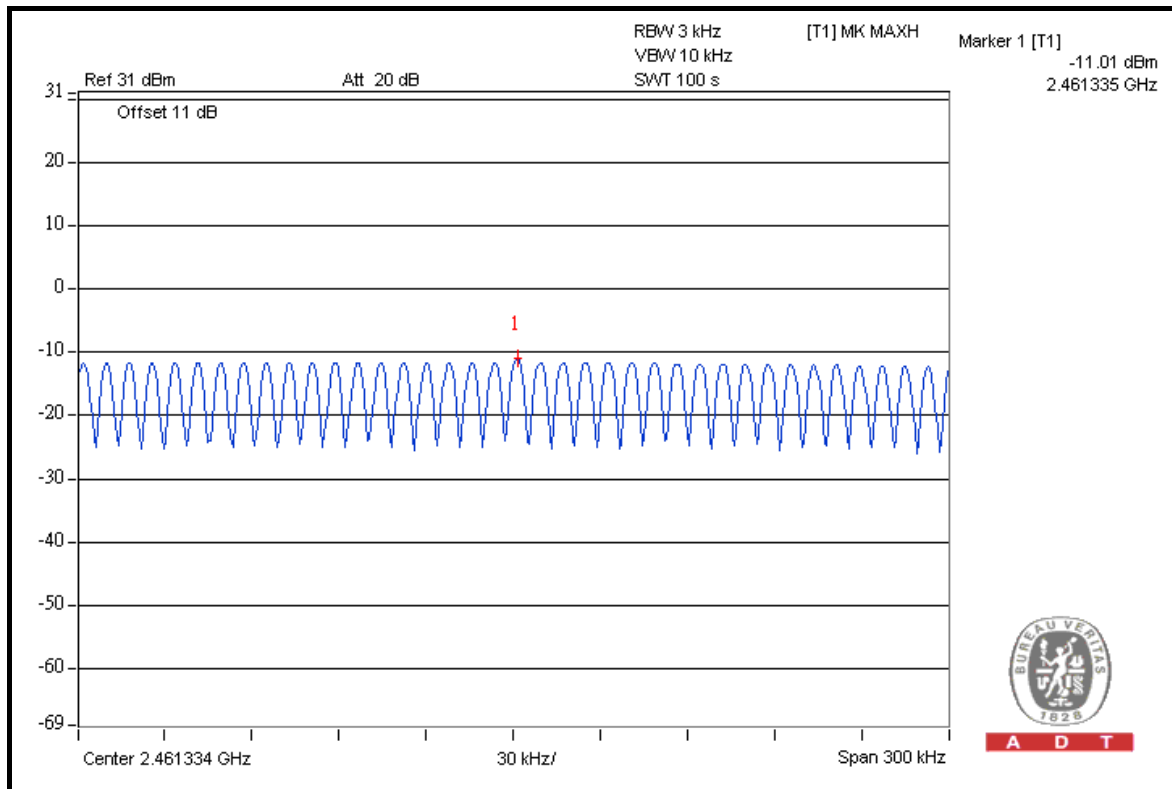

802.11g

CHANNEL	CHANNEL FREQUENCY (MHz)	RF POWER LEVEL IN 3 kHz BW (dBm)	MAXIMUM LIMIT (dBm)	PASS/FAIL
1	2412	-13.0	8	PASS
6	2437	-11.7	8	PASS
11	2462	-12.1	8	PASS

CH 6

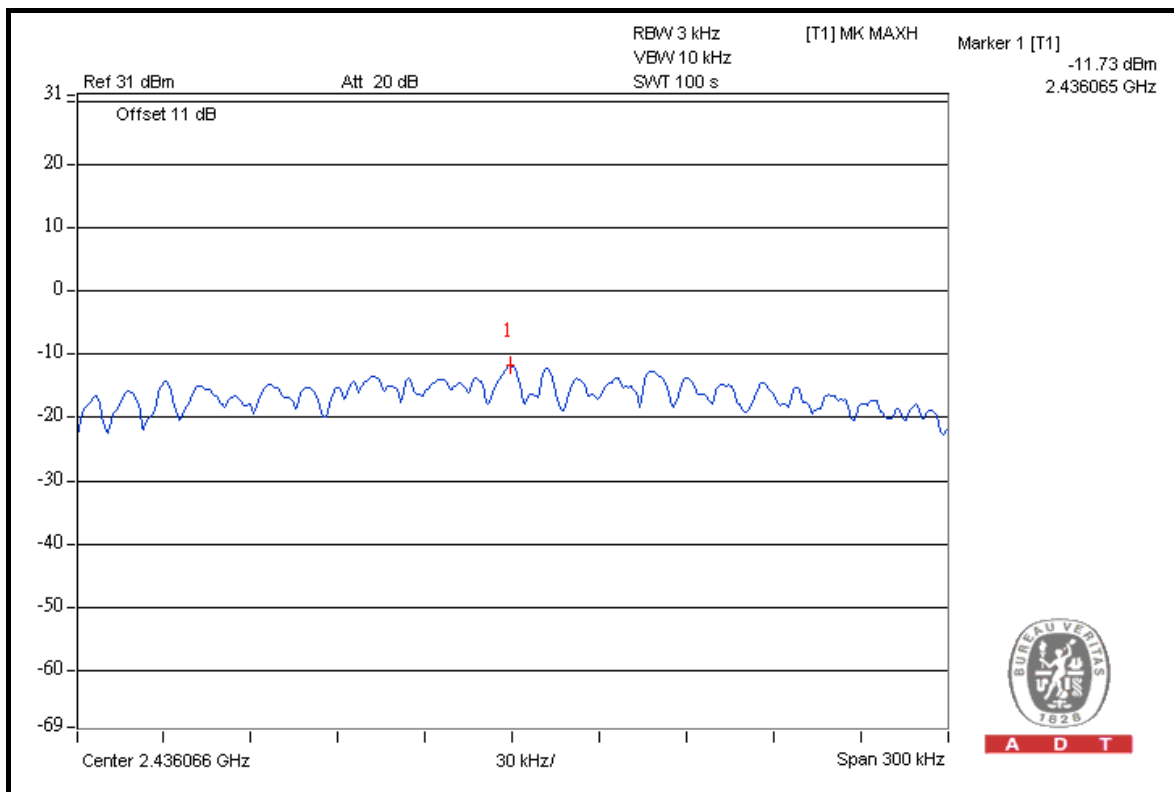



A D T

802.11n (20MHz)

CHAIN	CHAN.	CHAN. FREQ. (MHz)	RF POWER LEVEL IN 3kHz BW (dBm)		TOTAL POWER DENSITY (dBm)	MAX. LIMIT (dBm)	PASS / FAIL
			MEASURED	10 log (N=2) dB			
0	1	2412	-17.04	3.01	-14.0	8	PASS
	6	2437	-15.89	3.01	-12.9	8	PASS
	11	2462	-15.19	3.01	-12.2	8	PASS
1	1	2412	-16.68	3.01	-13.7	8	PASS
	6	2437	-16.59	3.01	-13.6	8	PASS
	11	2462	-16.38	3.01	-13.4	8	PASS

FOR CHAIN 0: CH 11

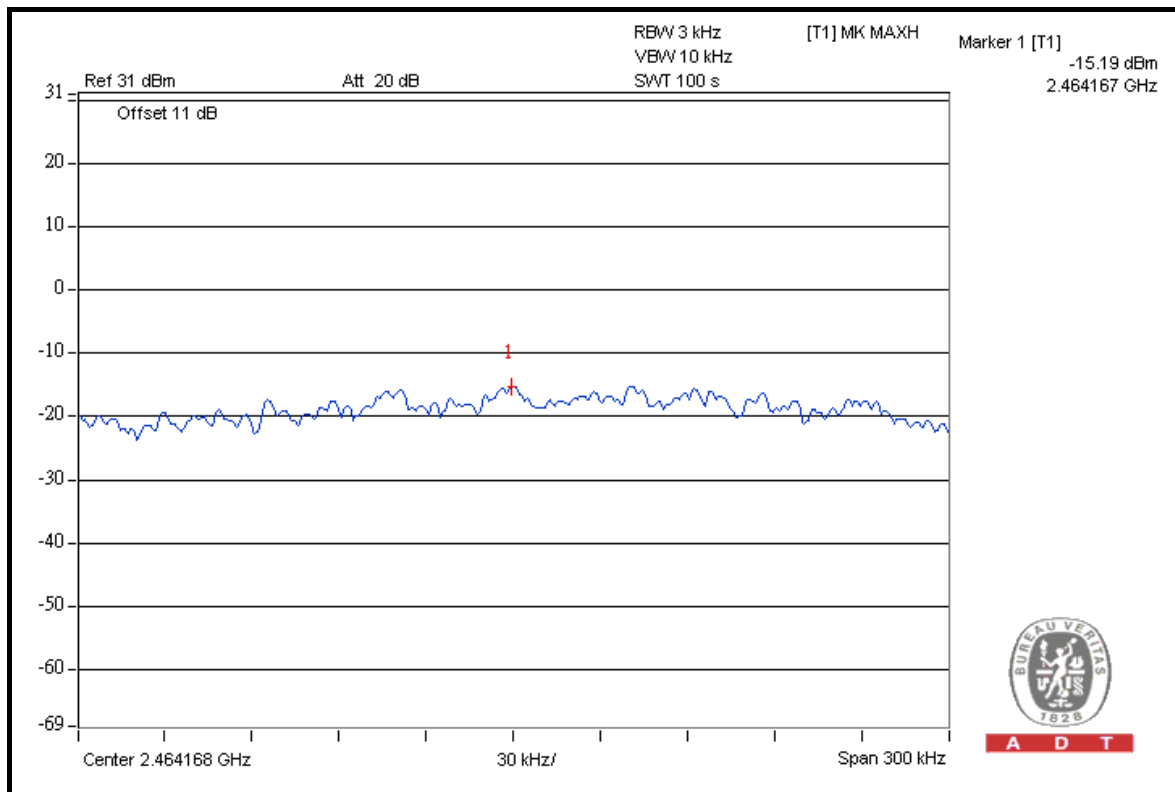

A D T



A D T

802.11n (40MHz)

CHAIN	CHAN.	CHAN. FREQ. (MHz)	RF POWER LEVEL IN 3kHz BW (dBm)		TOTAL POWER DENSITY (dBm)	MAX. LIMIT (dBm)	PASS / FAIL
			MEASURED	10 log (N=2) dB			
0	1	2422	-17.45	3.01	-14.4	8	PASS
	4	2437	-17.44	3.01	-14.4	8	PASS
	7	2452	-17.51	3.01	-14.5	8	PASS
1	1	2422	-17.16	3.01	-14.2	8	PASS
	4	2437	-16.96	3.01	-14.0	8	PASS
	7	2452	-17.12	3.01	-14.1	8	PASS

FOR CHAIN 1: CH 4

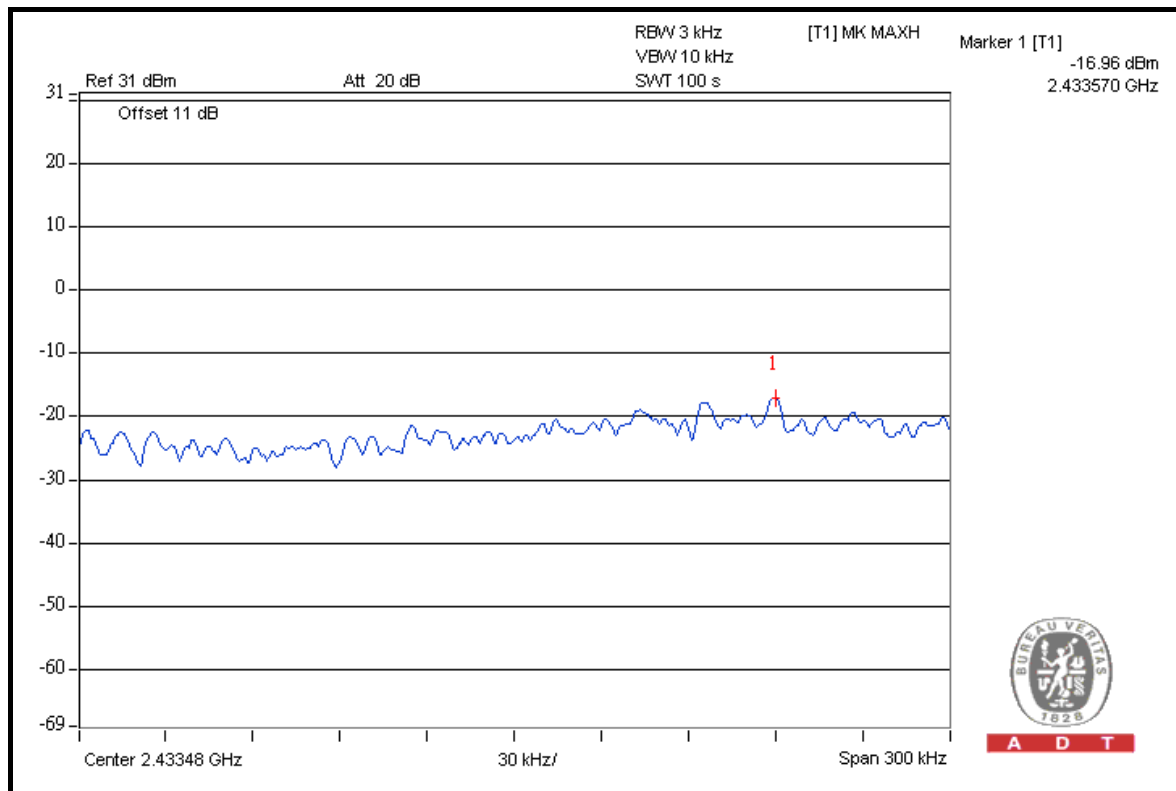

A D T



4.6 BAND EDGES MEASUREMENT

4.6.1 LIMITS OF BAND EDGES MEASUREMENT

Below –20dB of the highest emission level of operating band (in 100kHz Resolution Bandwidth).

4.6.2 TEST INSTRUMENTS

DESCRIPTION & MANUFACTURER	MODEL NO.	SERIAL NO.	DATE OF CALIBRATION	DUE DATE OF CALIBRATION
FOR CONDUCTED MEASUREMENT				
SPECTRUM ANALYZER R&S	FSP40	100039	Feb. 23, 2011	Feb. 22, 2012
FOR RADIATED MEASUREMENT				
Test Receiver ROHDE & SCHWARZ	ESIB7	100212	Aug. 02, 2011	Aug. 01, 2012
Spectrum Analyzer ROHDE & SCHWARZ	FSP 40	100041	Jul. 21, 2011	Jul. 20, 2012
BILOG Antenna SCHWARZBECK	VULB9168	9168-160	Apr. 13, 2011	Apr. 12, 2012
HORN Antenna SCHWARZBECK	9120D	209	Aug. 25, 2011	Aug. 24, 2012
HORN Antenna SCHWARZBECK	BBHA 9170	BBHA9170243	Dec. 27, 2010	Dec. 26, 2011
Preamplifier Agilent	8447D	2944A10633	Nov. 02, 2010	Nov. 01, 2011
Preamplifier Agilent	8449B	3008A01964	Nov. 02, 2010	Nov. 01, 2011
RF signal cable HUBER+SUHNNER	SUCOFLEX 104	295014/4	Aug. 19, 2011	Aug. 18, 2012
RF signal cable HUBER+SUHNNER	SUCOFLEX 104	12738/6	Aug. 19, 2011	Aug. 18, 2012
Software ADT.	ADT_Radiated_V7.6.15.9.2	NA	NA	NA
Antenna Tower inn-co GmbH	MA 4000	013303	NA	NA
Antenna Tower Controller inn-co GmbH	CO2000	017303	NA	NA
Turn Table ADT.	TT100.	TT93021703	NA	NA
Turn Table Controller ADT.	SC100.	SC93021703	NA	NA

NOTE: The calibration interval of the above test instruments is 12 months and the calibrations are traceable to NML/ROC and NIST/USA.

4.6.3 TEST PROCEDURE

FOR CONDUCTED MEASUREMENT:

The transmitter output was connected to the spectrum analyzer via a low loss cable. Set both RBW and VBW of spectrum analyzer to 100kHz and 300kHz with suitable frequency span including 100MHz bandwidth from band edge. The band edges were measured and recorded.

The spectrum plots (Peak RBW = 100kHz, VBW = 300kHz; Average RBW = 1MHz, VBW = 10Hz) are attached on the following pages.

FOR RADIATED MEASUREMENT:

- a. The EUT was placed on the top of a rotating table 0.8 meters above the ground at a 3 meter semi-anechoic chamber. The table was rotated 360 degrees to determine the position of the highest radiation.
- b. The EUT was set 3 meters away from the interference-receiving antenna, which was mounted on the top of a variable-height antenna tower.
- c. The antenna is a broadband antenna, and its height is varied from one meter to four meters above the ground to determine the maximum value of the field strength. Both horizontal and vertical polarizations of the antenna are set to make the measurement.
- d. For each suspected emission, the EUT was arranged to its worst case and then the antenna was tuned to heights from 1 meter to 4 meters and the rotatable table was turned from 0 degrees to 360 degrees to find the maximum reading.
- e. Set both RBW and VBW of spectrum analyzer to 100kHz and 300kHz with suitable frequency span including 100MHz bandwidth from band edge. The band edges were measured and recorded.

The spectrum plots (Peak RBW = 100kHz, VBW = 300kHz) are attached on the following pages.

NOTE: The resolution bandwidth of test receiver/spectrum analyzer is 1MHz and the video bandwidth is 10Hz for Average detection (AV) at frequency above 1GHz.

4.6.4 DEVIATION FROM TEST STANDARD

No deviation.



4.6.5 EUT OPERATING CONDITION

Same as Item 4.3.6.

4.6.6 TEST RESULTS

The spectrum plots are attached on the following pages. D1 line indicates the highest level, and D2 line indicates the 20dB offset below D1. It shows compliance with the requirement in part 15.247(d).

802.11b

RESTRICT BAND (2310 ~ 2390 MHz)

FREQUENCY (MHz)	FUNDAMENTAL EMISSION (dBuV/m)	DELTA (dB)	MAXIMUM FIELD STRENGTH IN RESTRICT BAND (dBuV/m)	LIMIT (dBuV/m)
2412.00 (PK)	102.9	48.02	54.88	74.00
2412.00 (AV)	99.30	53.30	46.00	54.00

RESTRICT BAND (2483.5 ~ 2500 MHz)

FREQUENCY (MHz)	FUNDAMENTAL EMISSION (dBuV/m)	DELTA (dB)	MAXIMUM FIELD STRENGTH IN RESTRICT BAND (dBuV/m)	LIMIT (dBuV/m)
2462.00 (PK)	105.1	47.31	57.79	74.00
2462.00 (AV)	101.4	50.59	50.81	54.00

NOTE:

1. Delta = Amplitude between the peak of the fundamental and the peak of the band edge emission. Please check following 3 pages.
2. Maximum field strength in restrict band = Fundamental emission – Delta.



A D T

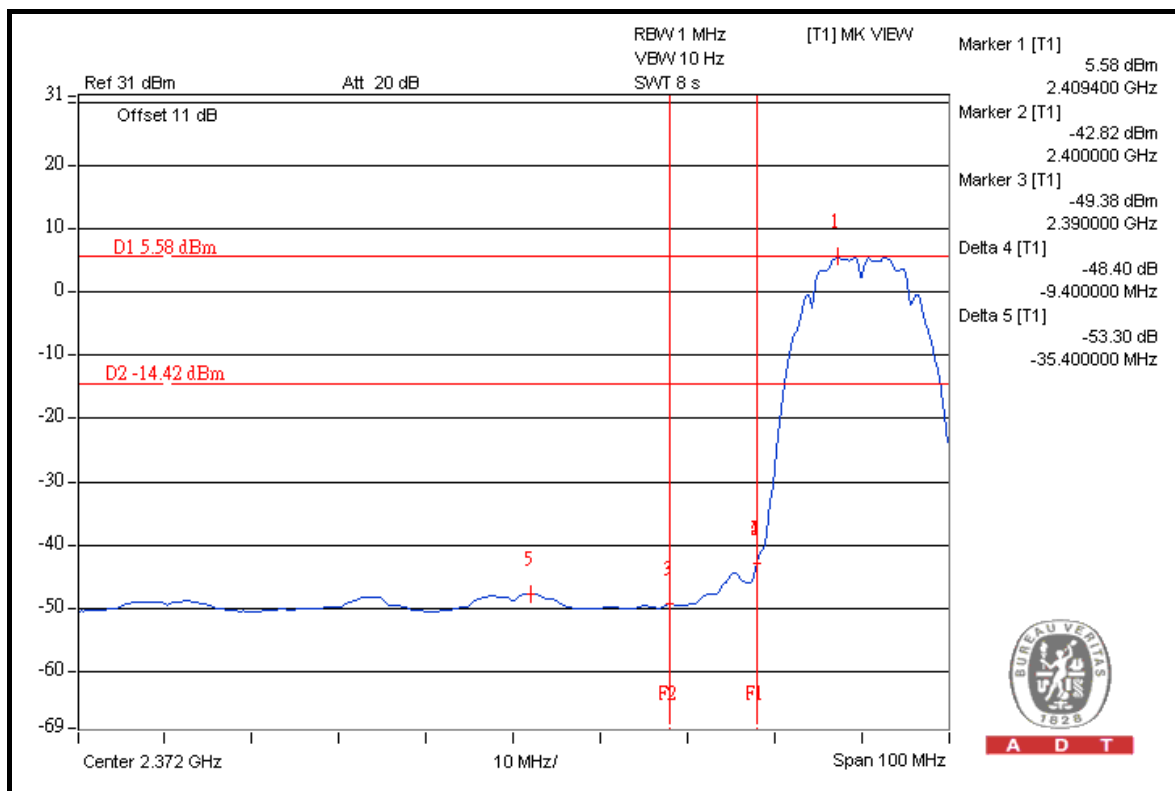
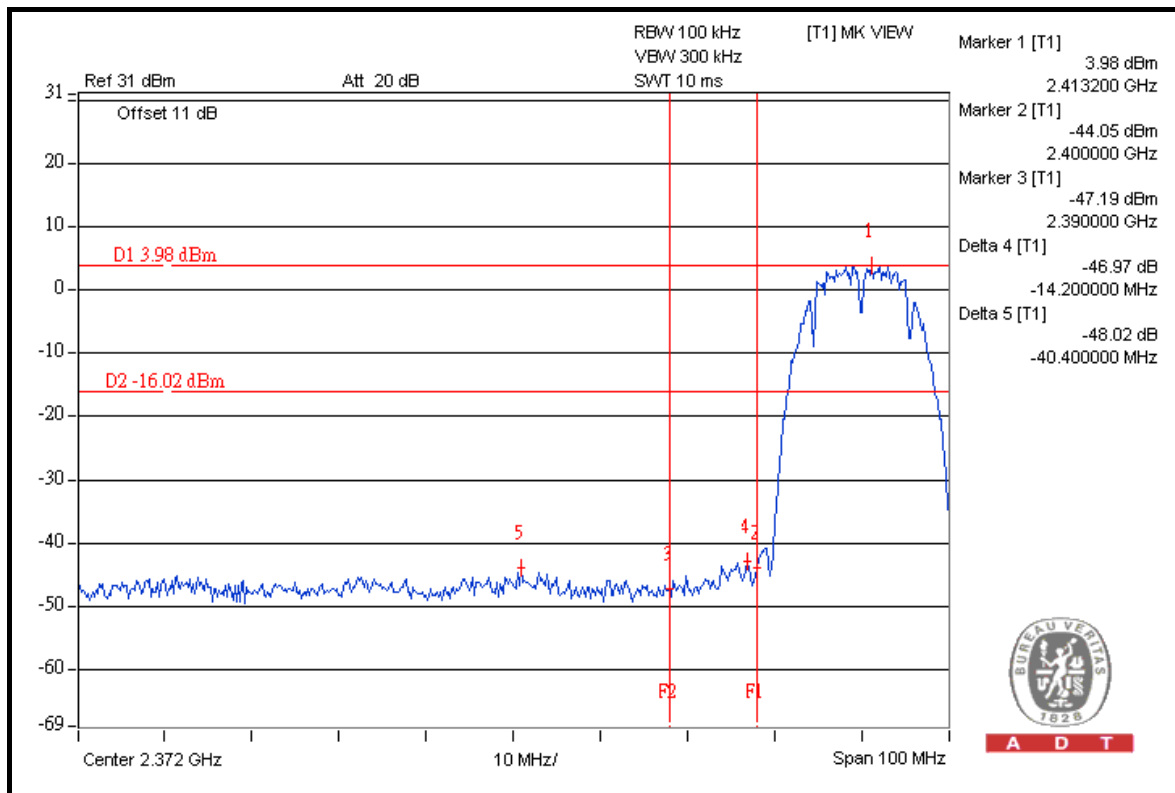



A D T

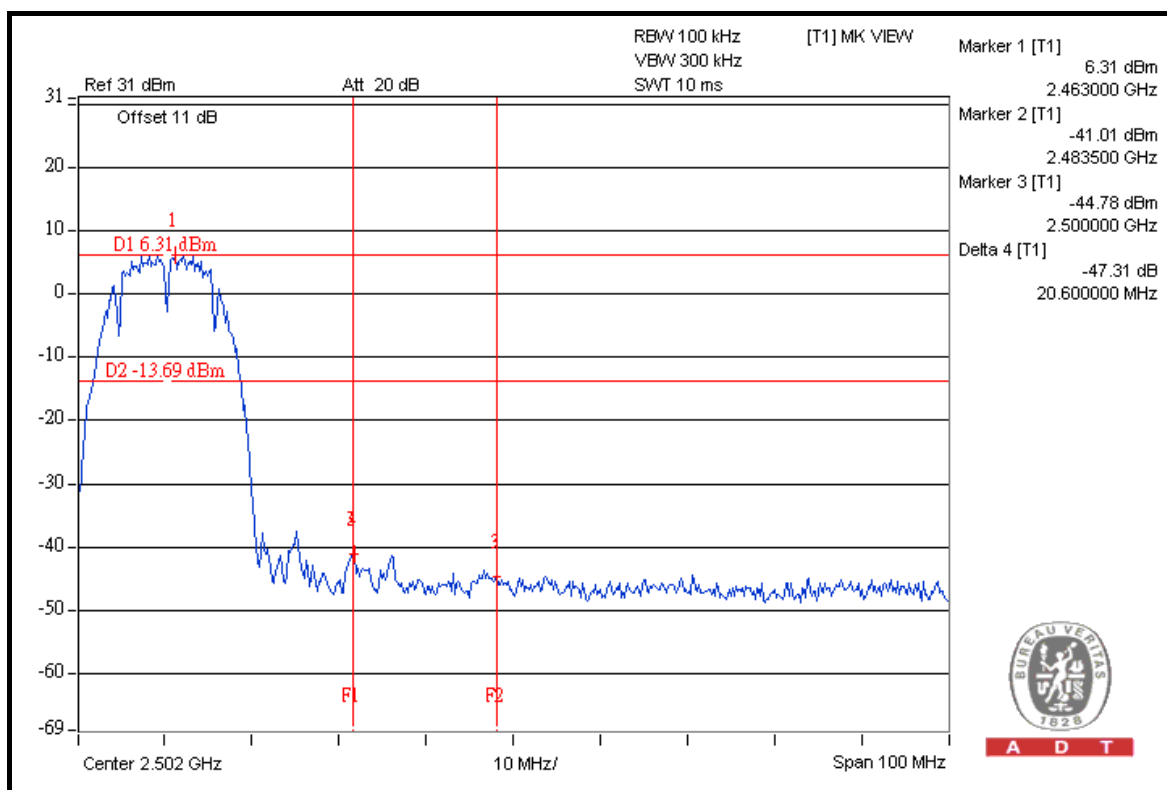
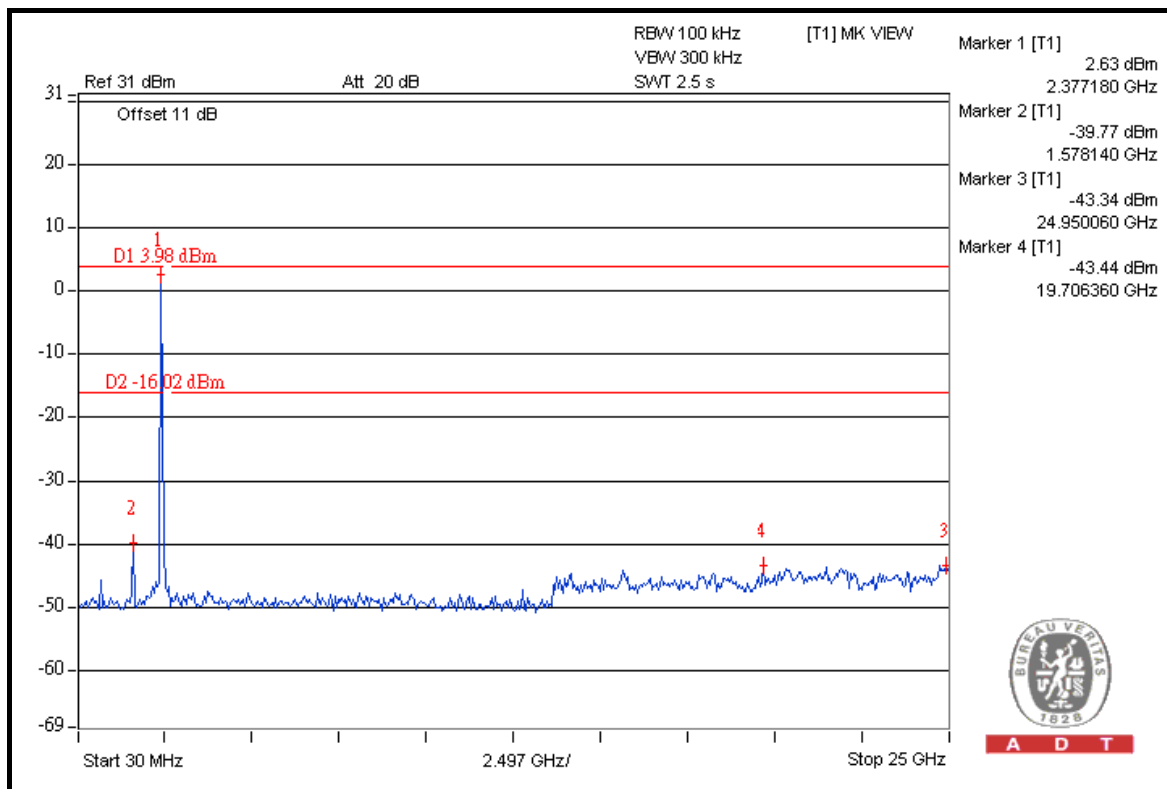



A D T

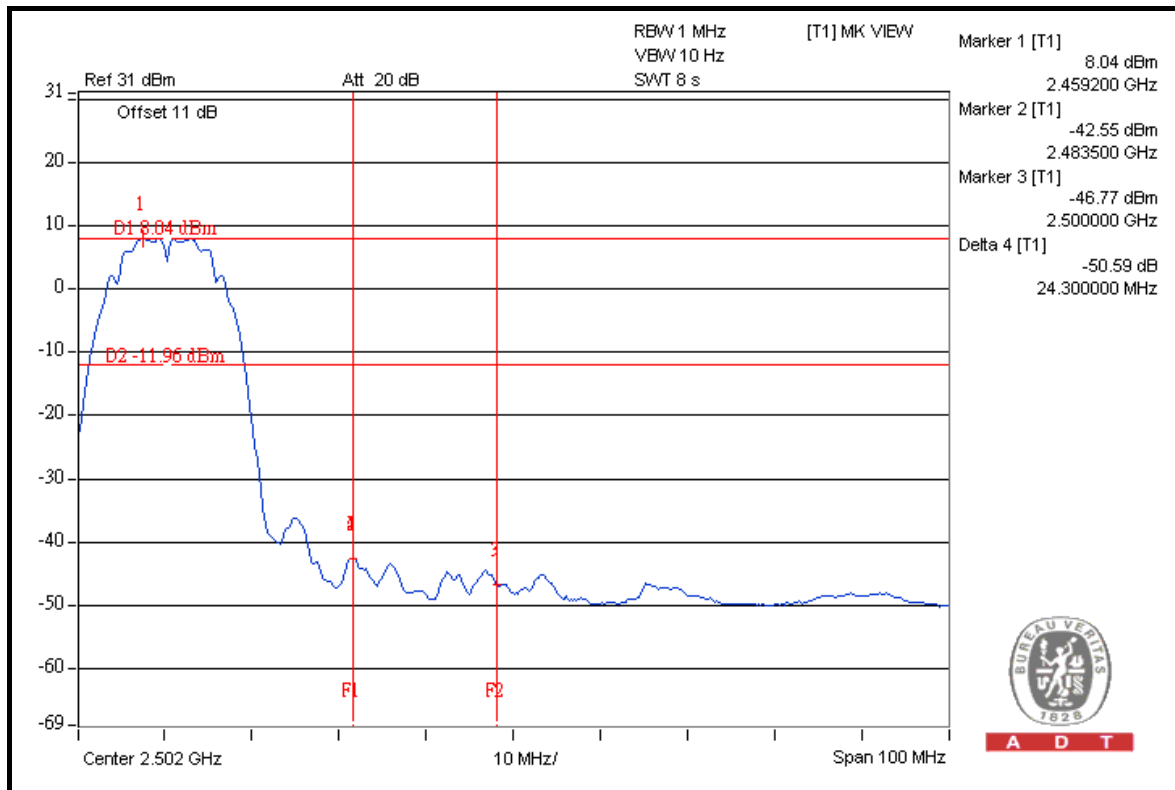

A D T

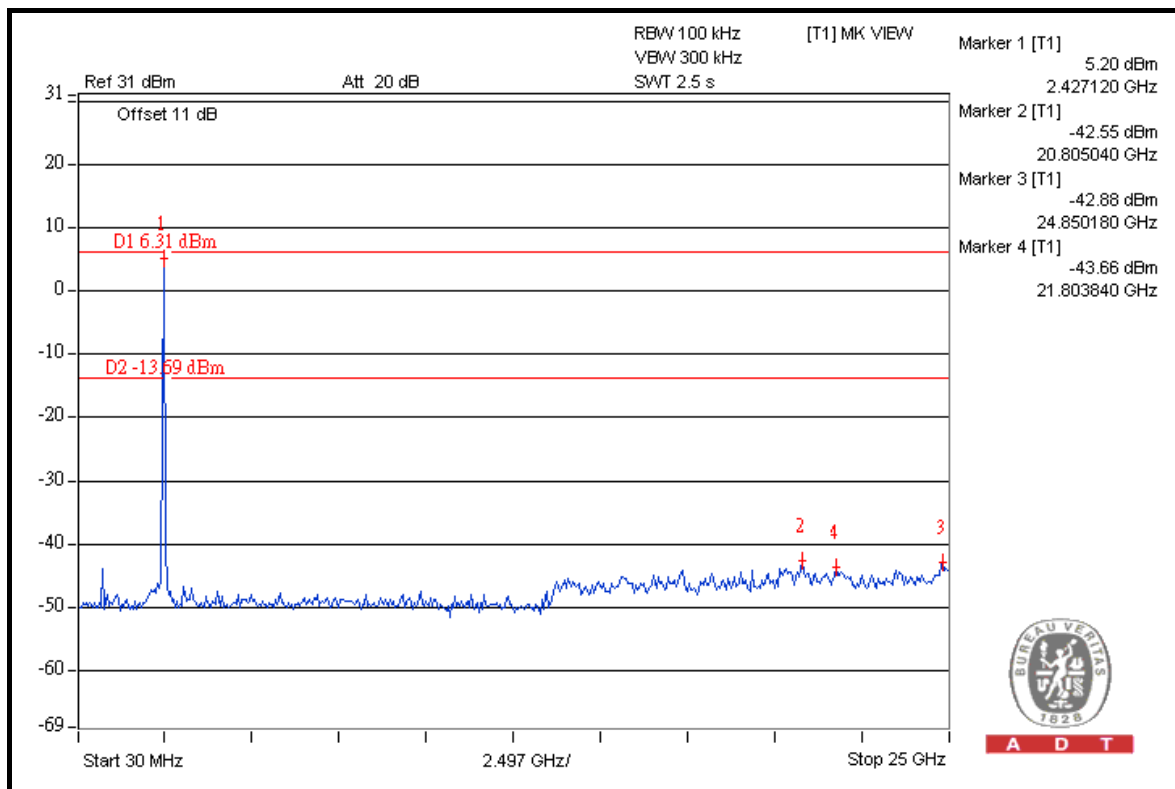

A D T



802.11g

RESTRICT BAND (2310 ~ 2390 MHz)

FREQUENCY (MHz)	FUNDAMENTAL EMISSION (dBuV/m)	DELTA (dB)	MAXIMUM FIELD STRENGTH IN RESTRICT BAND (dBuV/m)	LIMIT (dBuV/m)
2412.00 (PK)	107.4	43.05	64.35	74.00
2412.00 (AV)	97.6	48.13	49.47	54.00

RESTRICT BAND (2483.5 ~ 2500 MHz)

FREQUENCY (MHz)	FUNDAMENTAL EMISSION (dBuV/m)	DELTA (dB)	MAXIMUM FIELD STRENGTH IN RESTRICT BAND (dBuV/m)	LIMIT (dBuV/m)
2462.00 (PK)	107.6	36.61	70.99	74.00
2462.00 (AV)	98.0	46.43	51.57	54.00

NOTE:

1. Delta = Amplitude between the peak of the fundamental and the peak of the band edge emission. Please check following 3 pages.
2. Maximum field strength in restrict band = Fundamental emission – Delta.



A D T

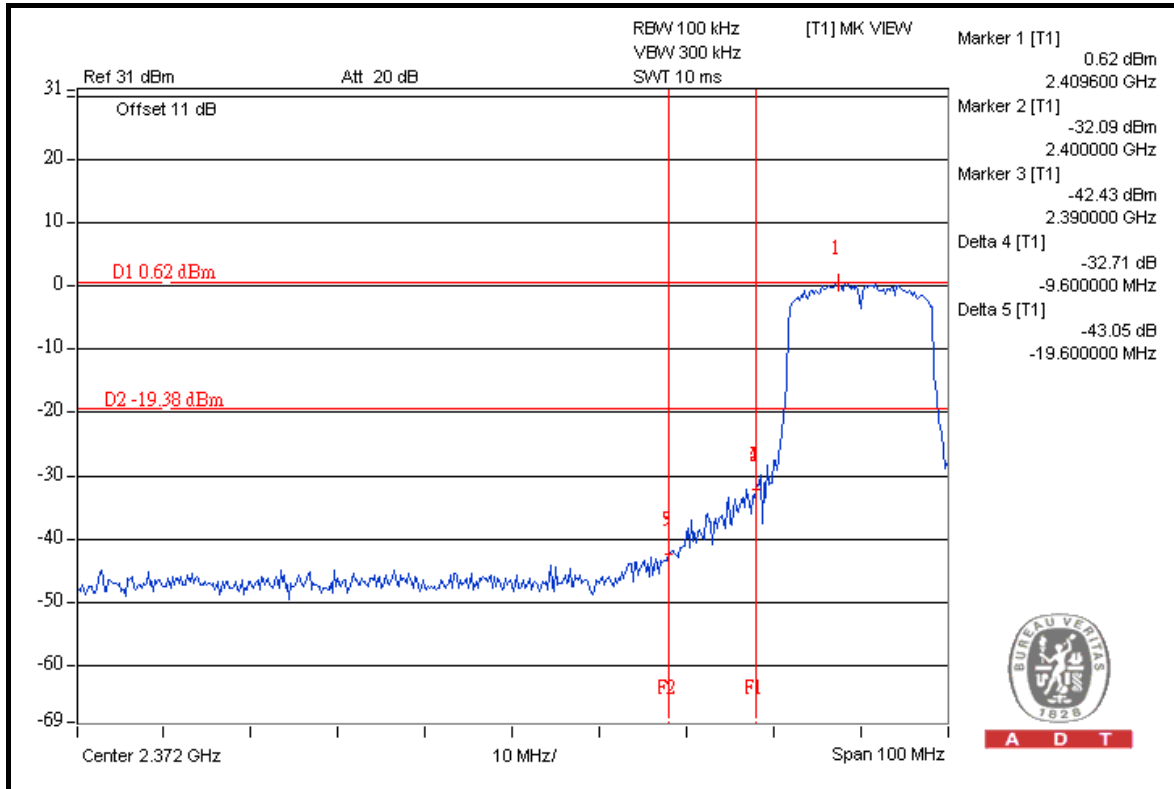

A D T

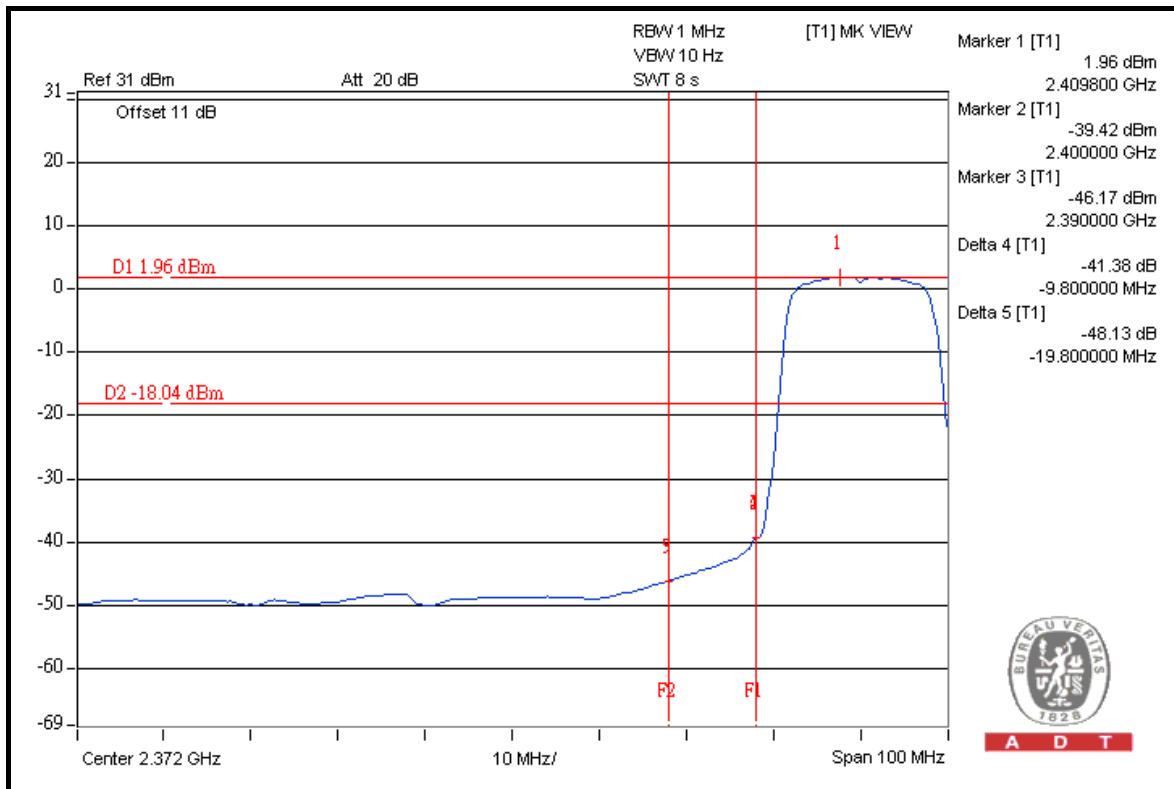

A D T



A D T

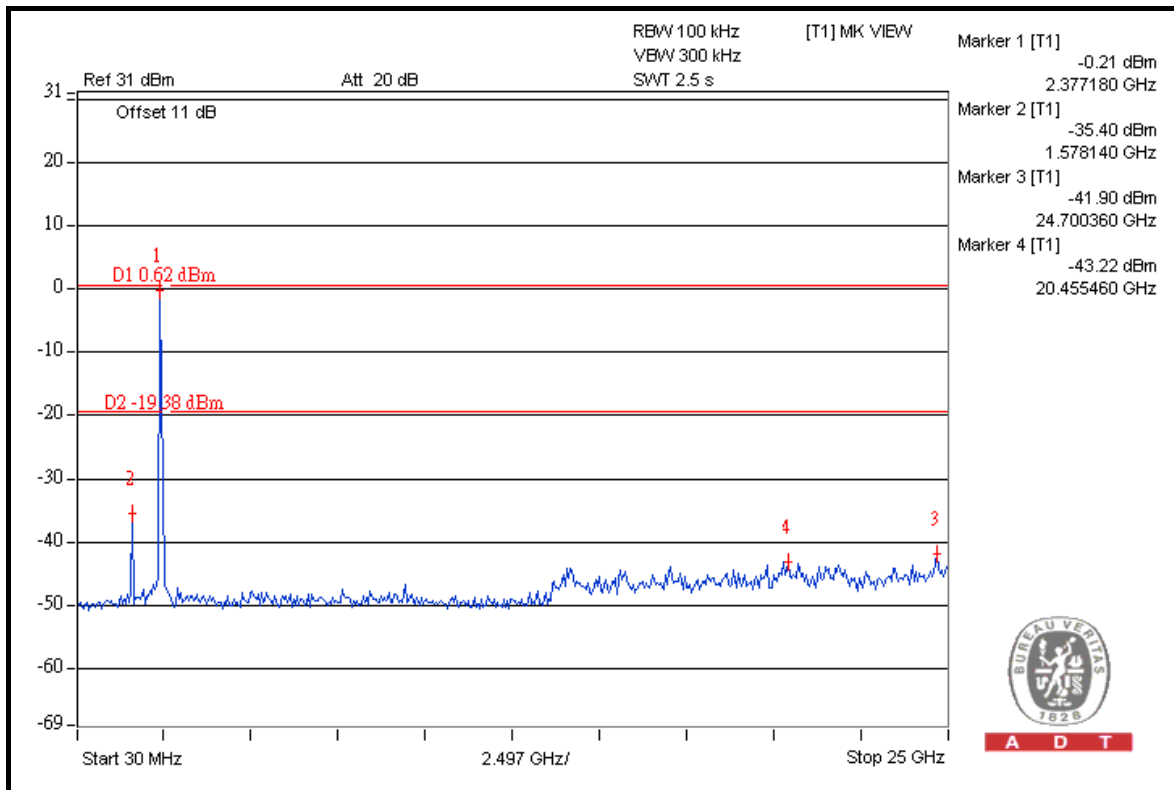

A D T

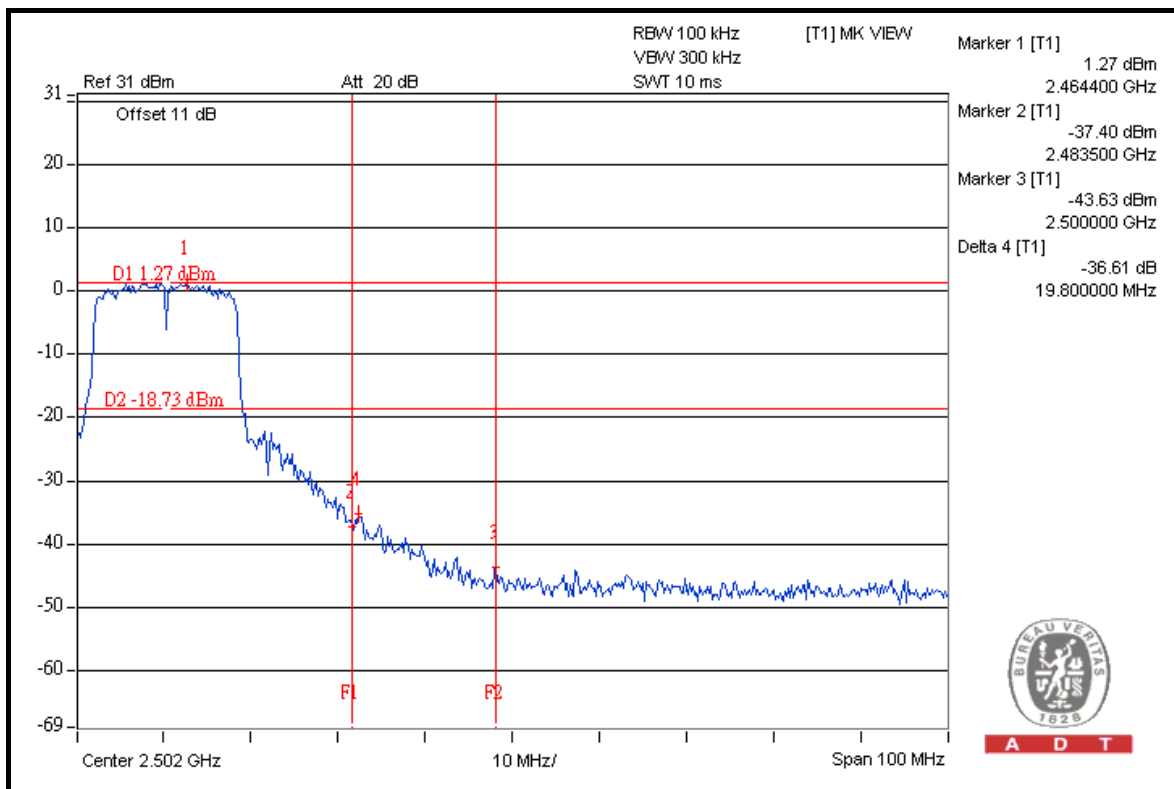

A D T



A D T

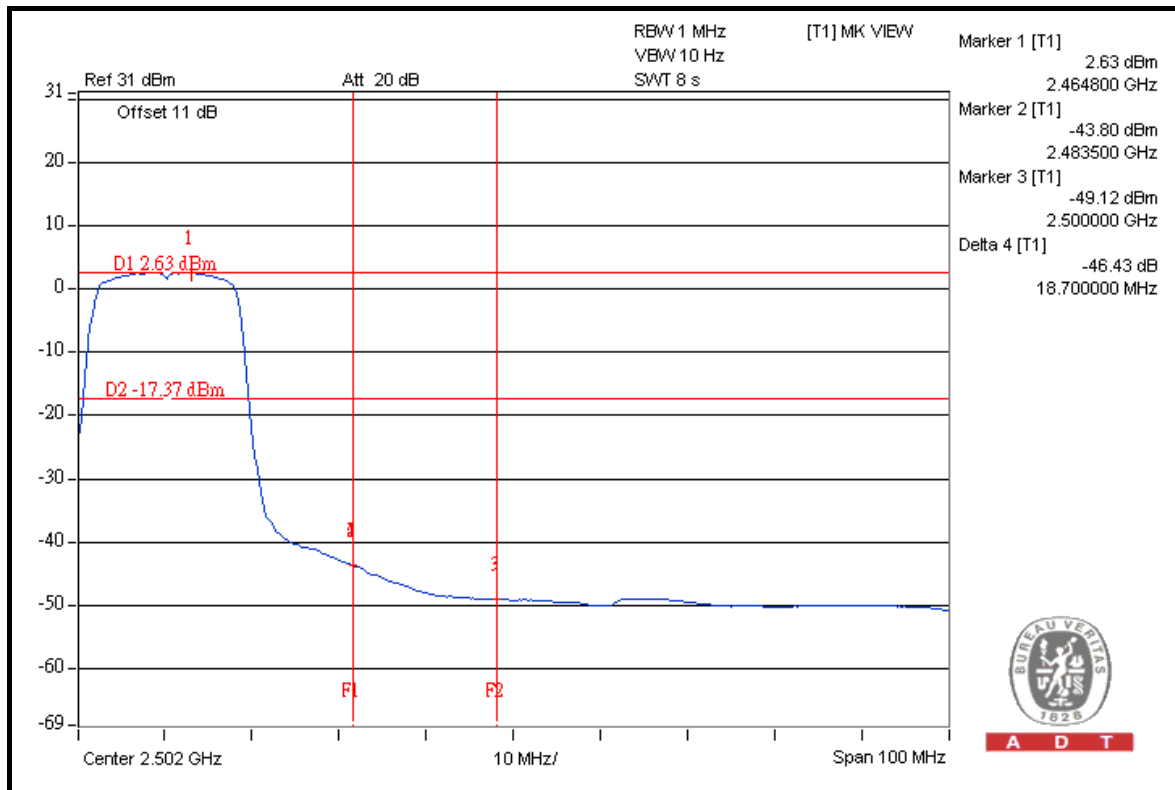

A D T

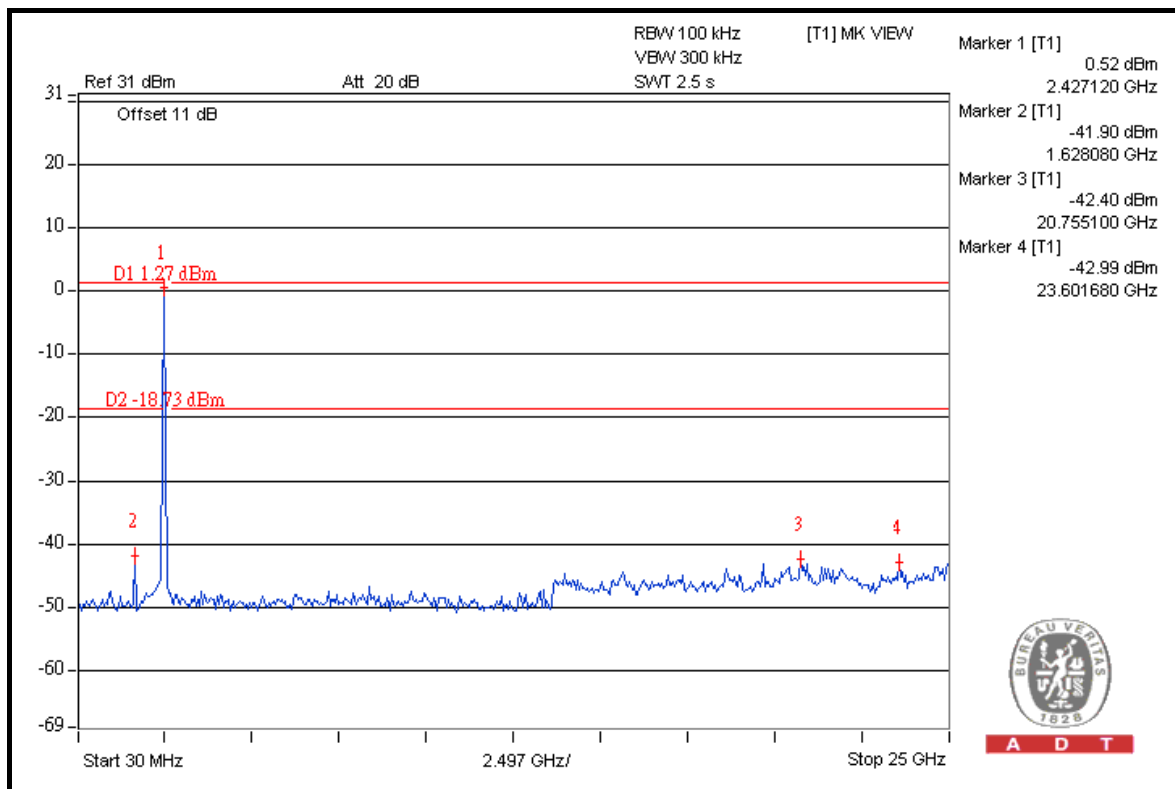

A D T

802.11n (20MHz)

RESTRICT BAND (2310 ~ 2390 MHz)

FREQUENCY (MHz)	FUNDAMENTAL EMISSION (dBuV/m)	DELTA (dB)	MAXIMUM FIELD STRENGTH IN RESTRICT BAND (dBuV/m)	LIMIT (dBuV/m)
2412.00 (PK)	109.5	41.56	67.94	74.00
2412.00 (AV)	98.9	46.30	52.60	54.00

RESTRICT BAND (2483.5 ~ 2500 MHz)

FREQUENCY (MHz)	FUNDAMENTAL EMISSION (dBuV/m)	DELTA (dB)	MAXIMUM FIELD STRENGTH IN RESTRICT BAND (dBuV/m)	LIMIT (dBuV/m)
2462.00 (PK)	109.7	43.93	65.77	74.00
2462.00 (AV)	99.2	48.95	50.25	54.00

NOTE:

1. Delta = Amplitude between the peak of the fundamental and the peak of the band edge emission. Please check following 2 pages.
2. Maximum field strength in restrict band = Fundamental emission – Delta.



A D T

FOR RADIATED MEASURED (BOTH CHAINS ON)

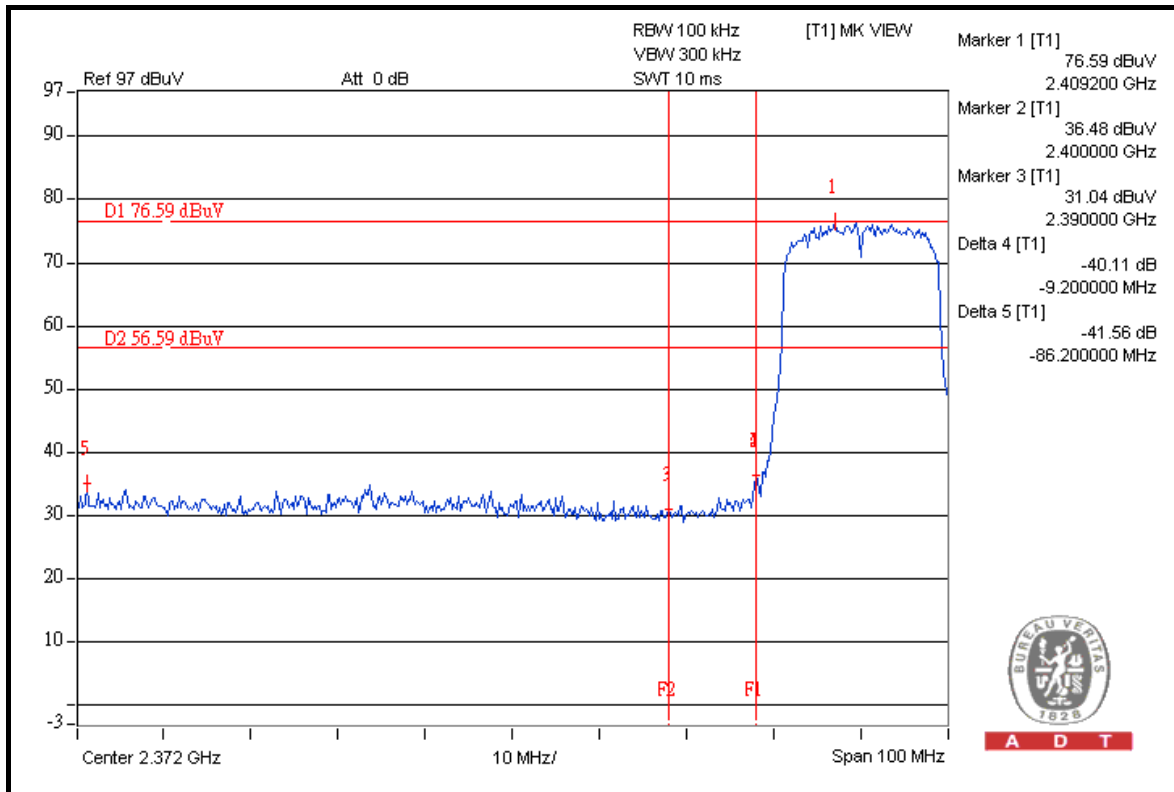

A D T

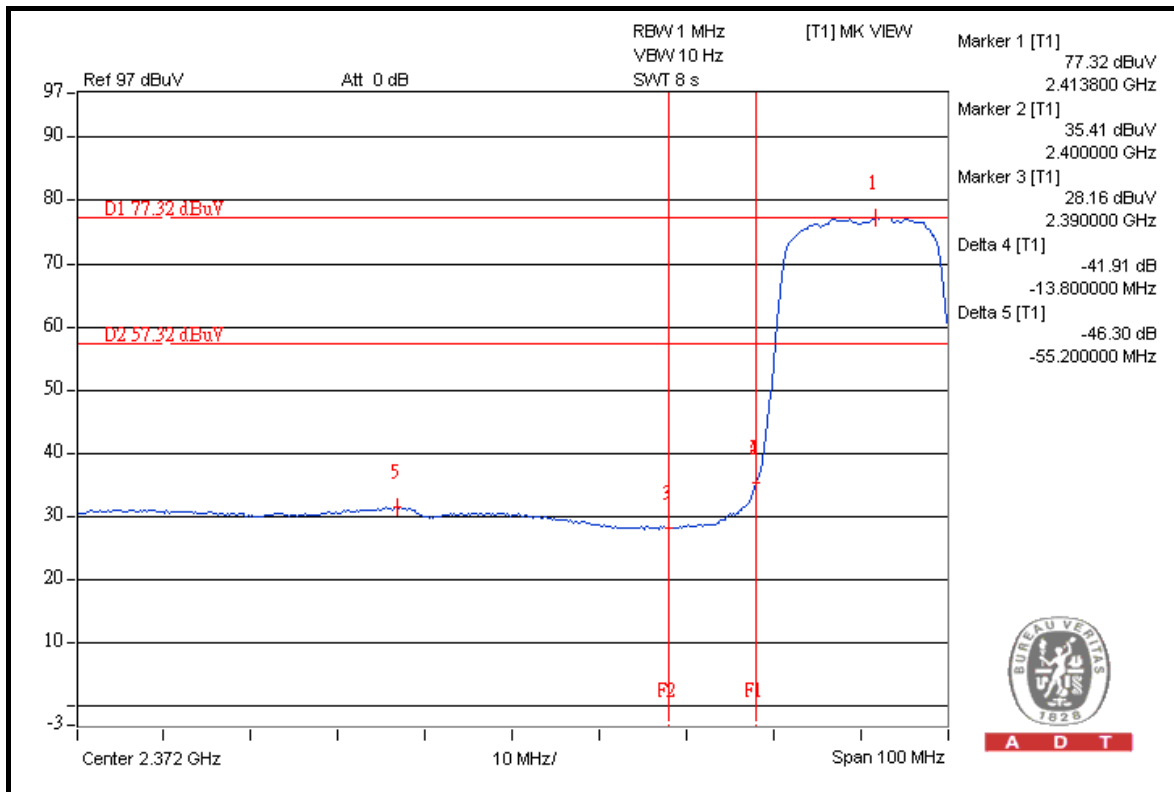

A D T



A D T

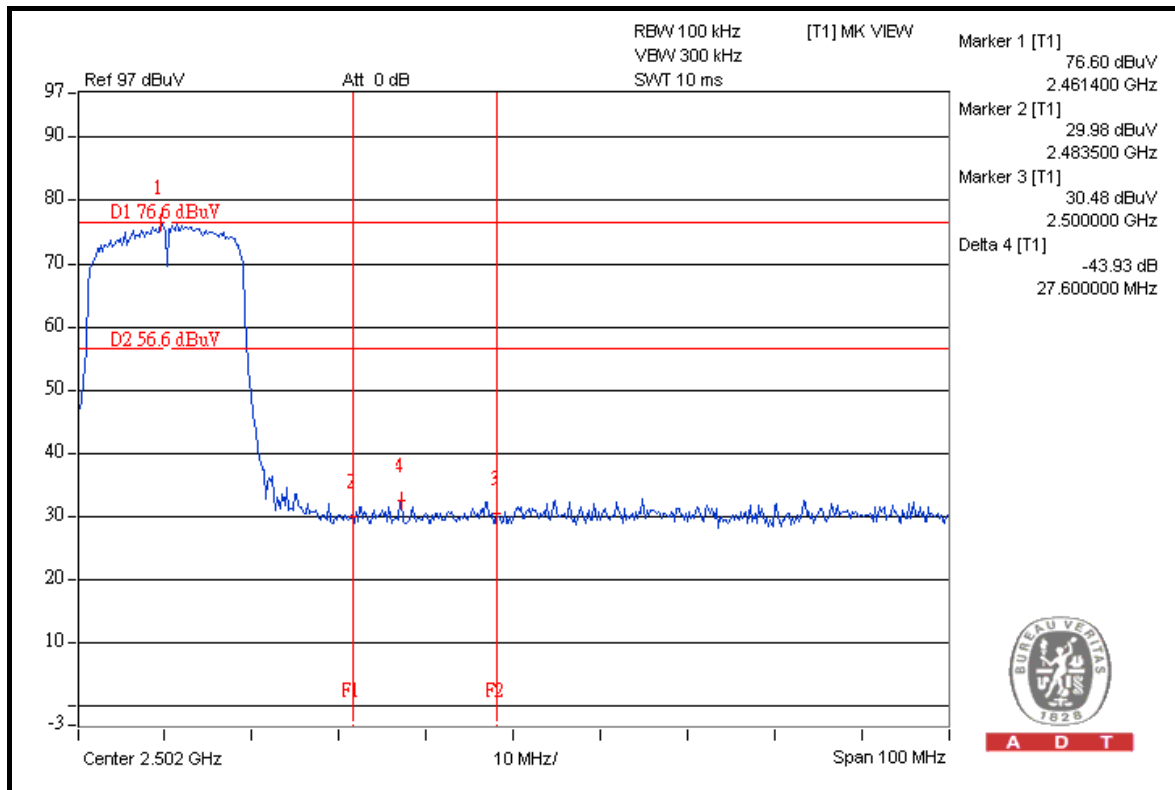

A D T

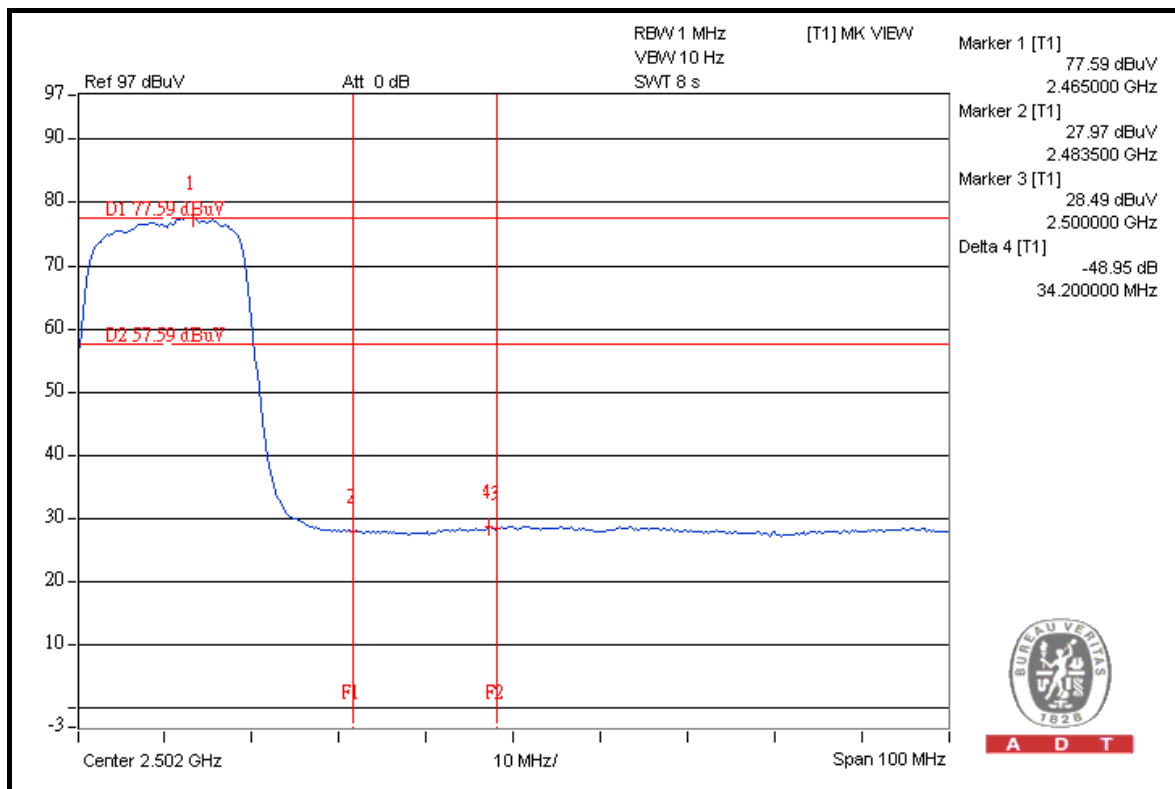

A D T



A D T

FOR CONDUCTED MEASURED

CHAIN 0

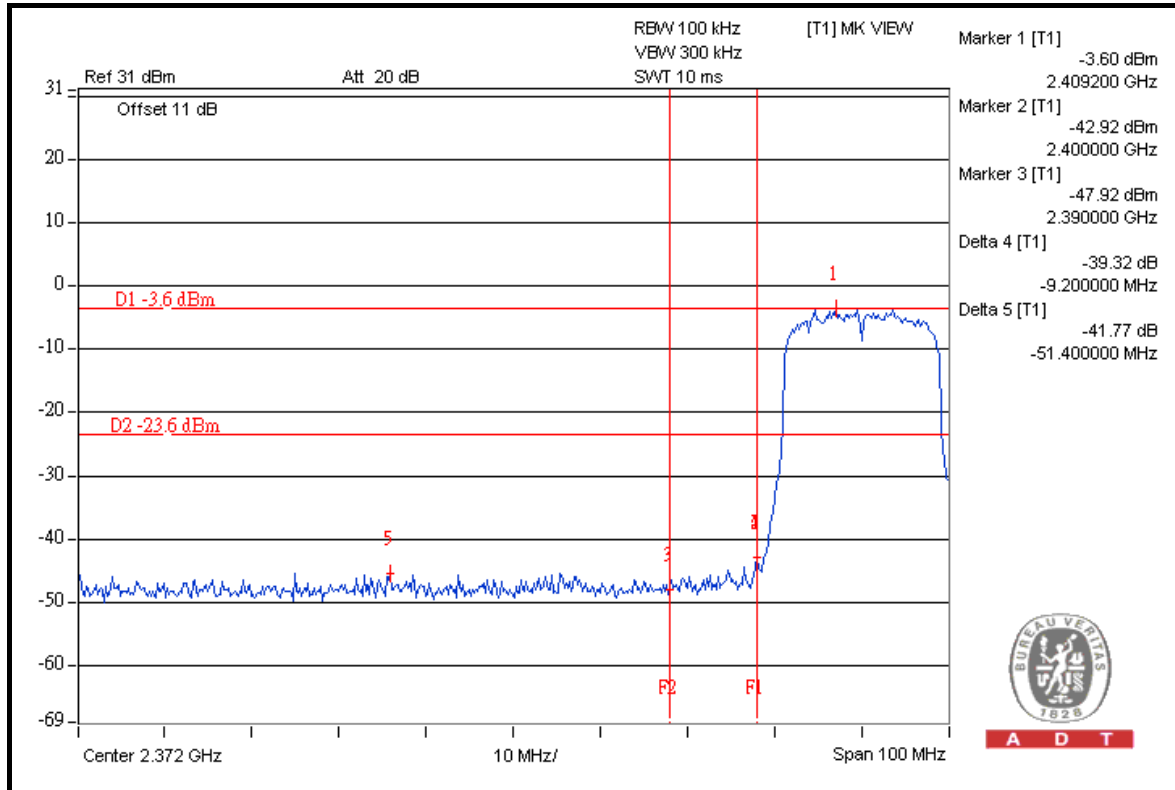

A D T

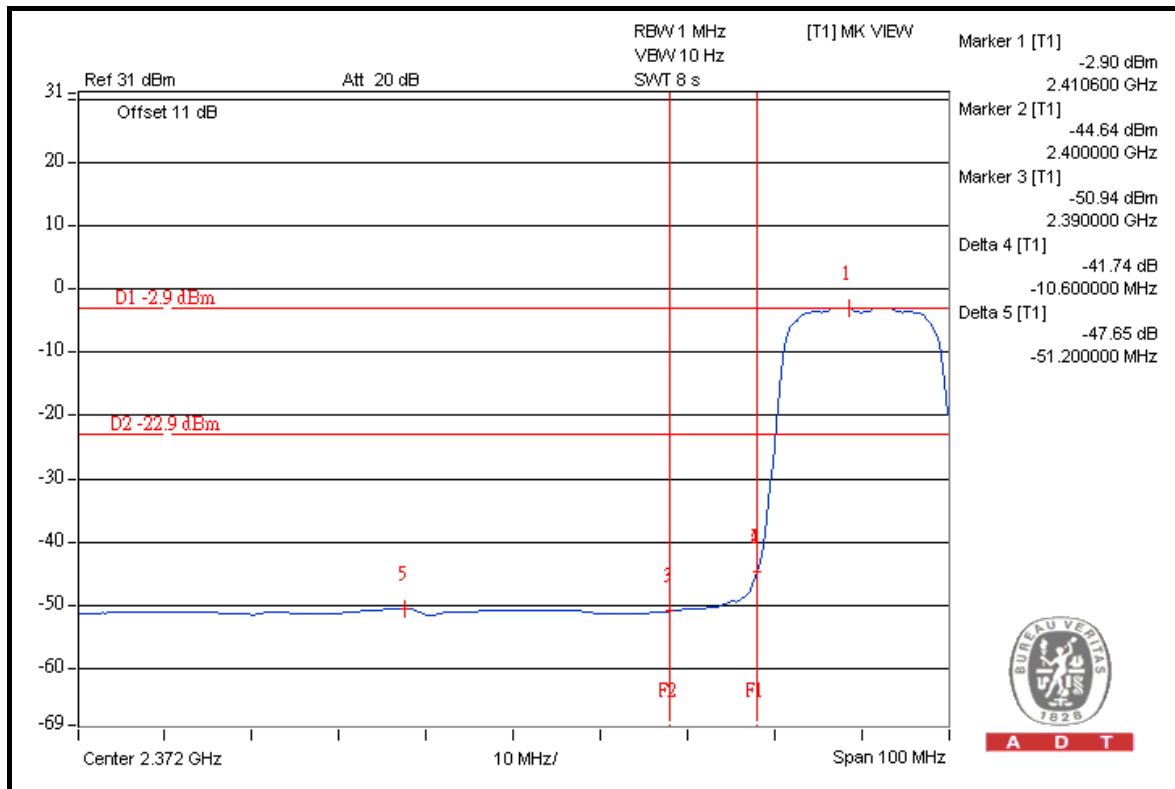

A D T



A D T

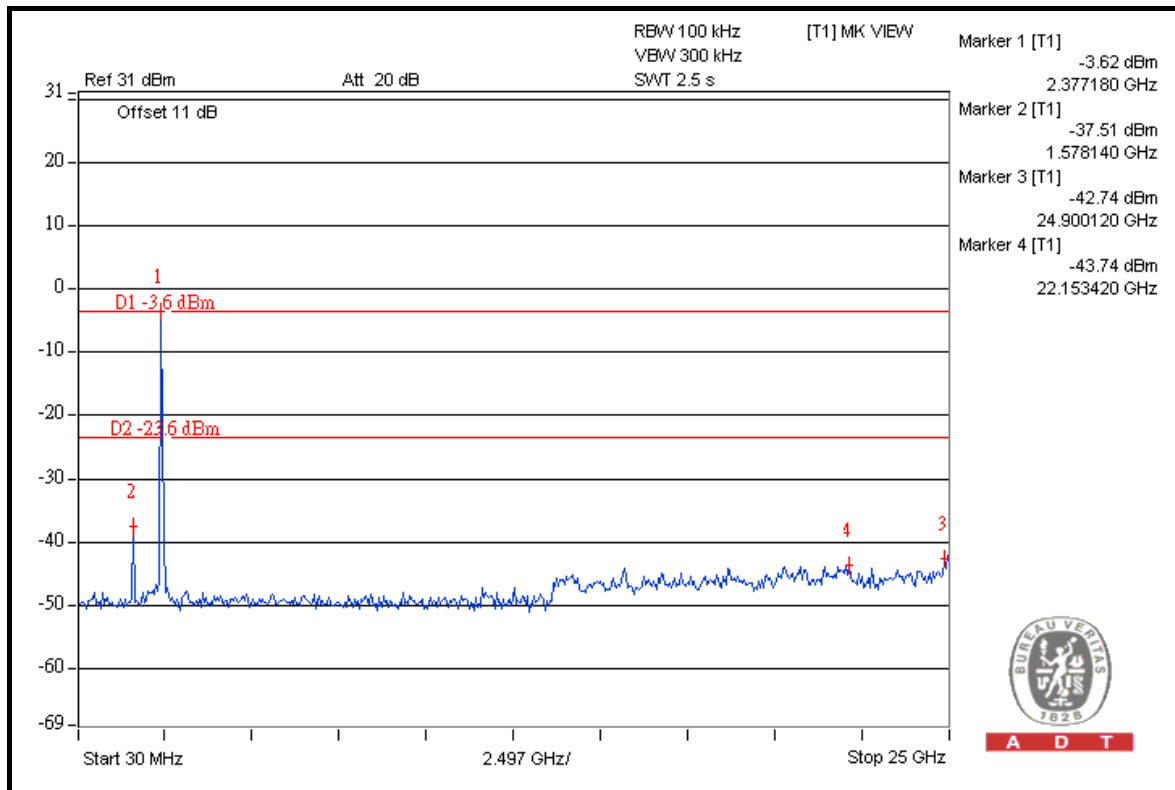

A D T

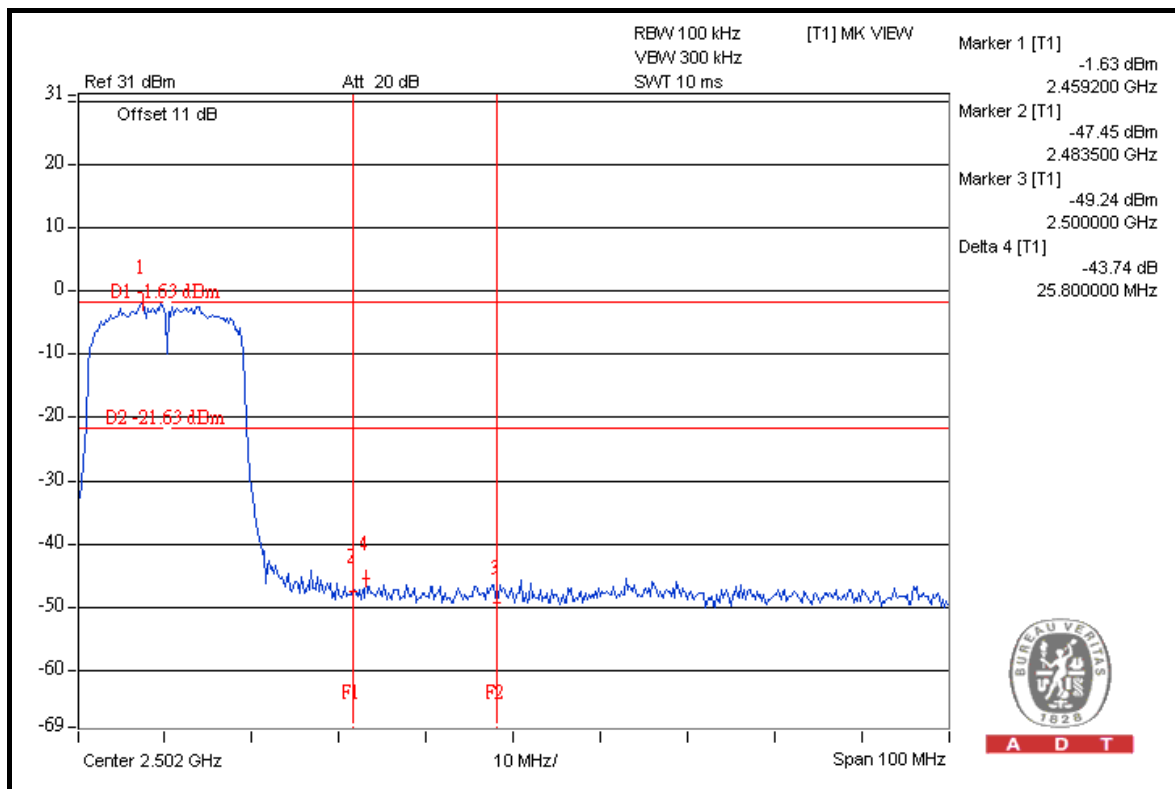

A D T



A D T

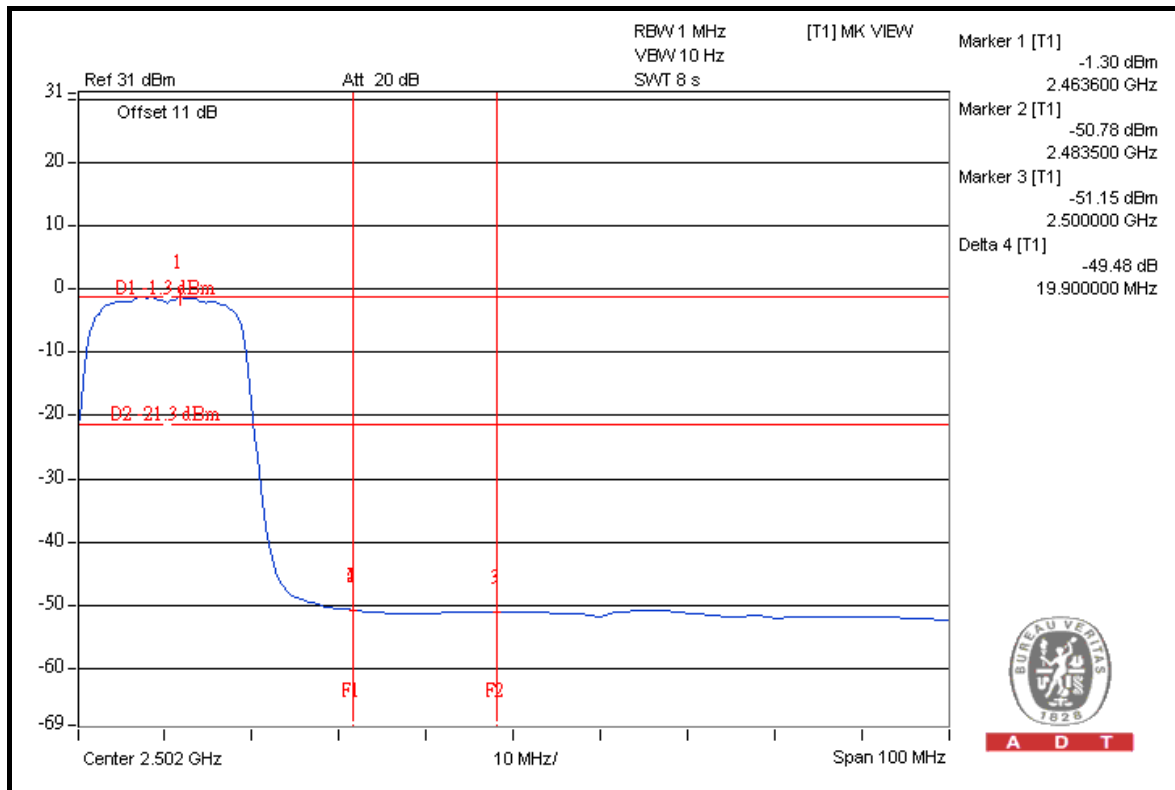

A D T

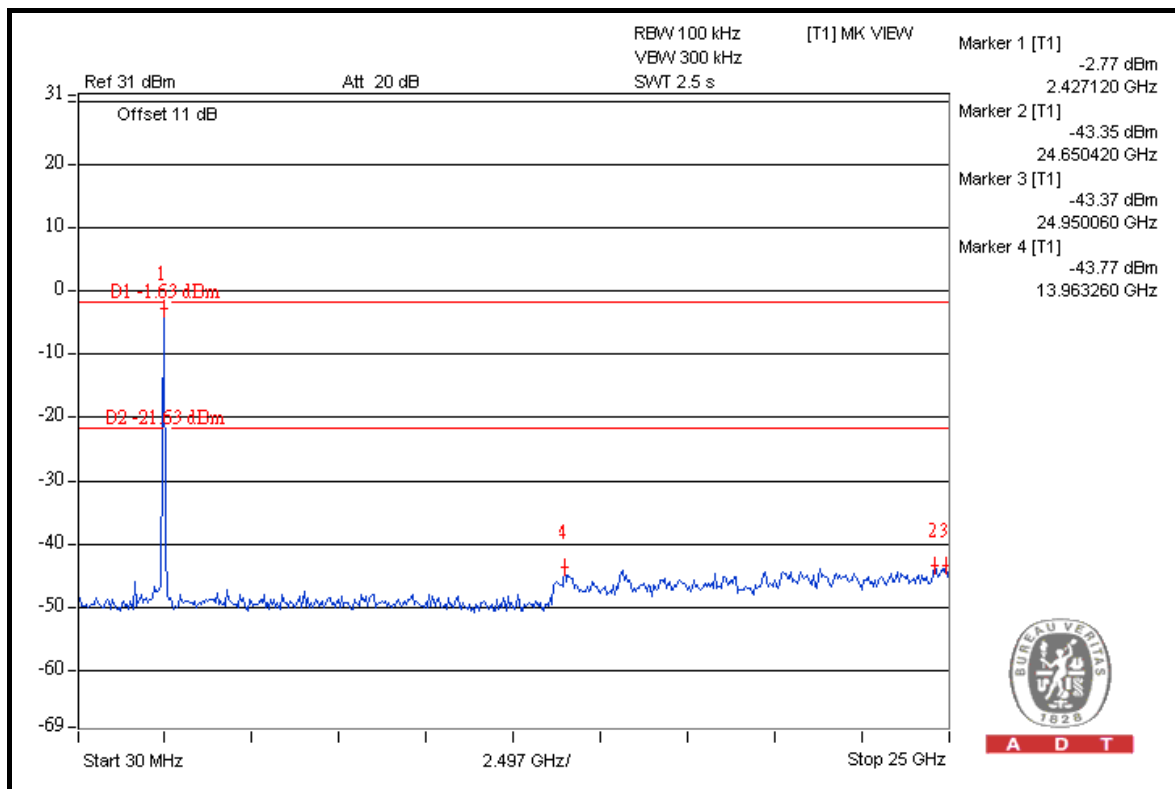

A D T



A D T

CHAIN 1

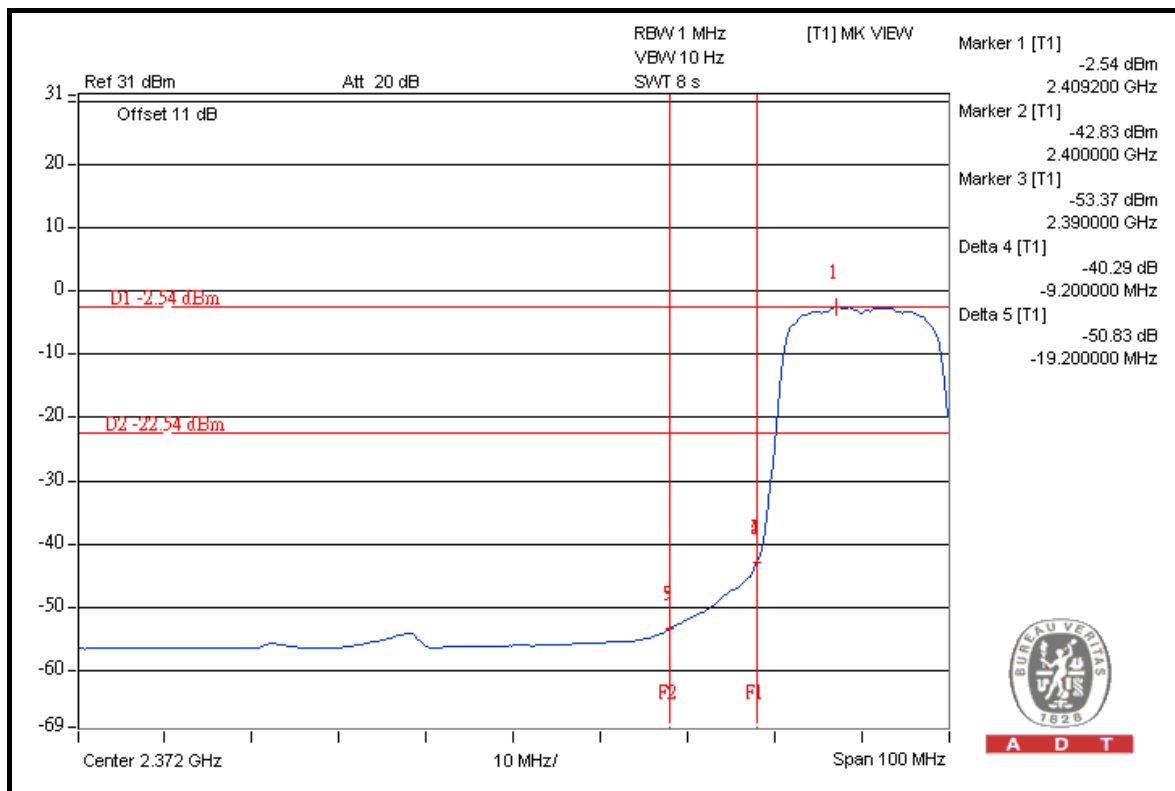
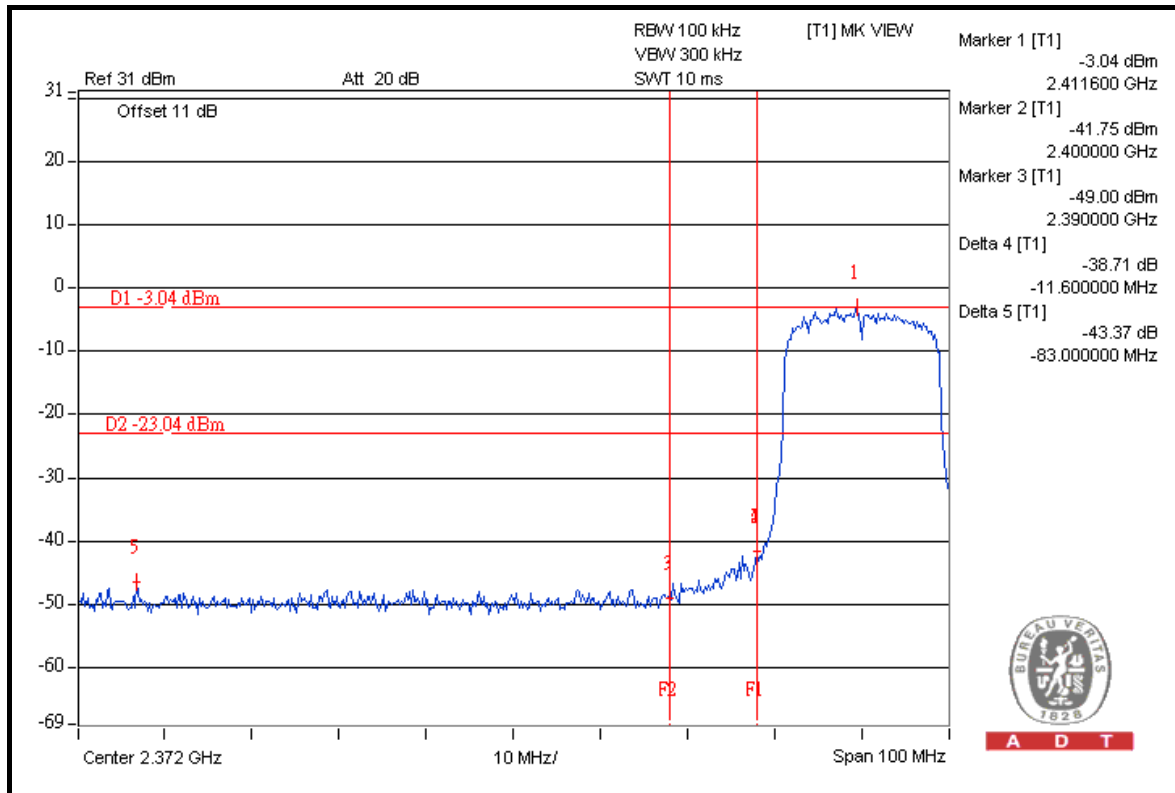



A D T

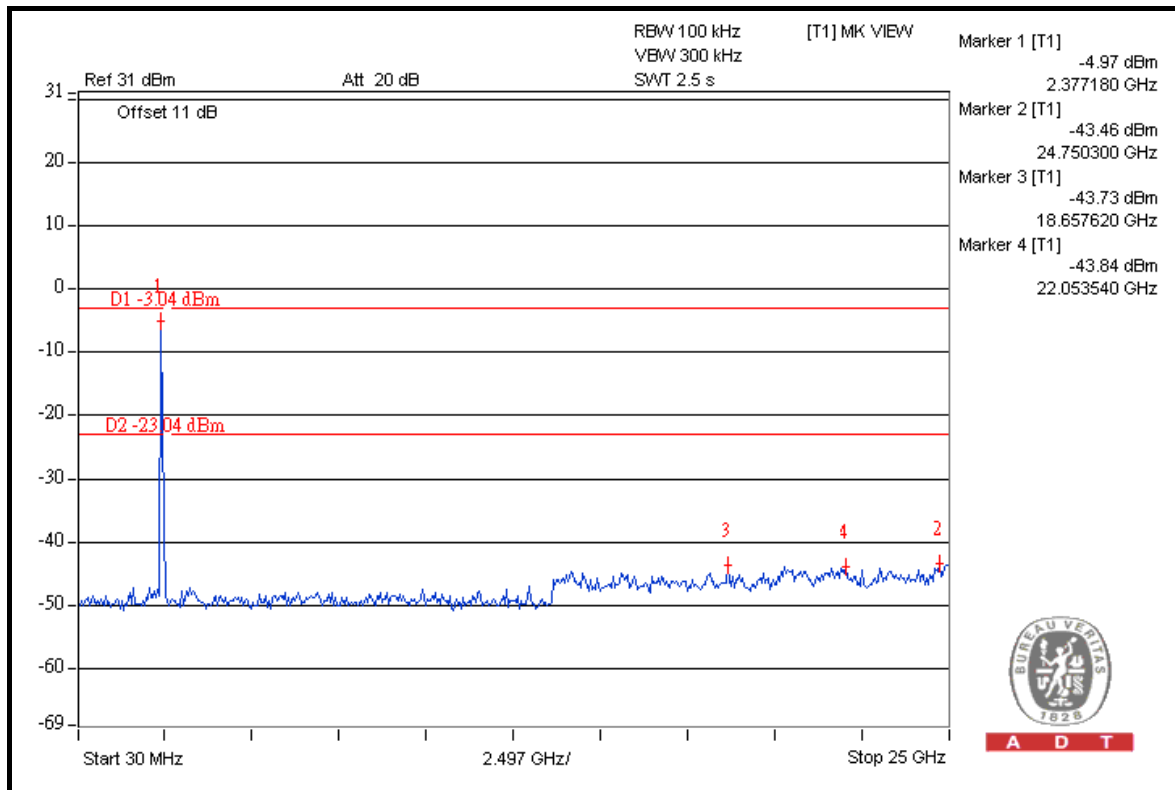

A D T

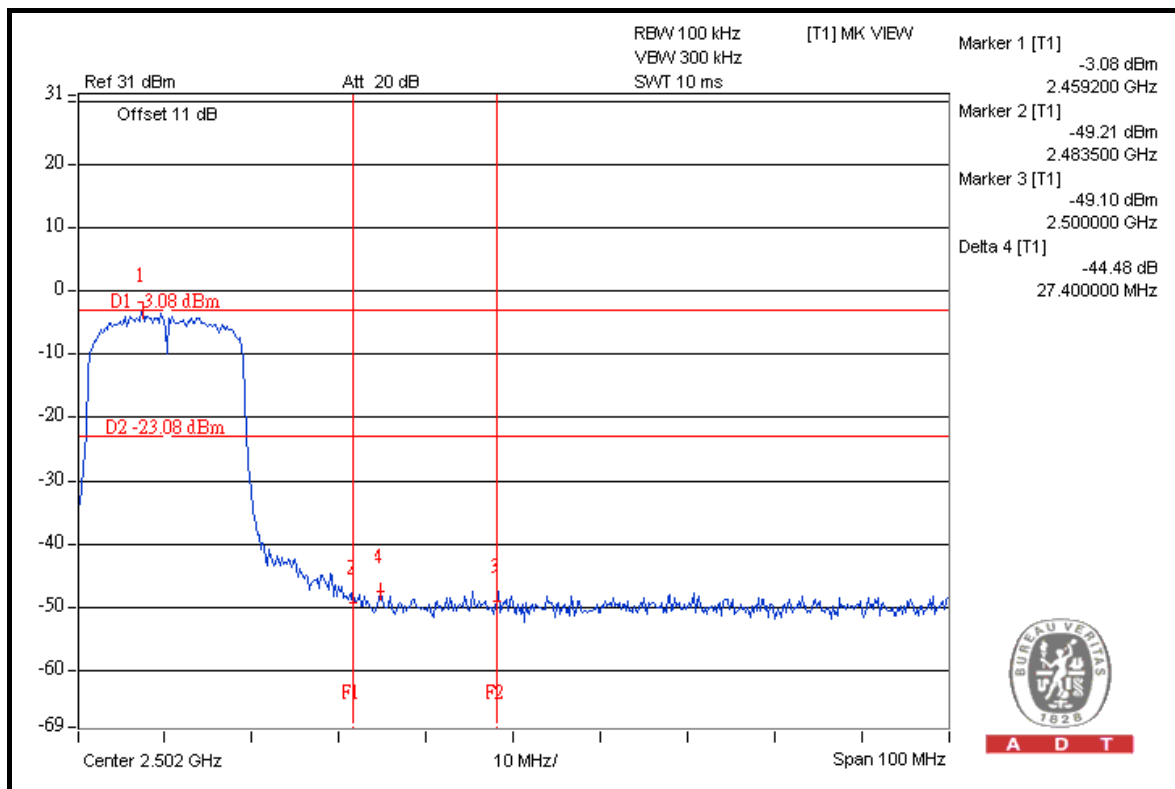

A D T



A D T

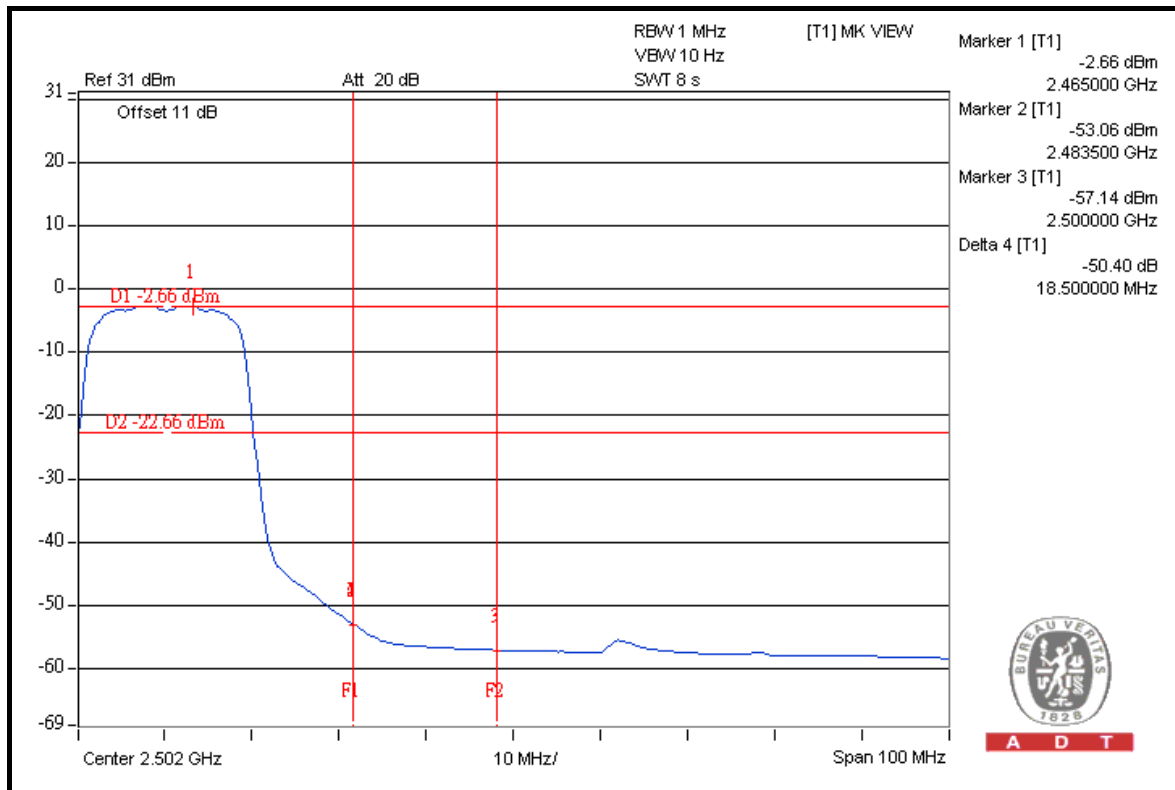

A D T

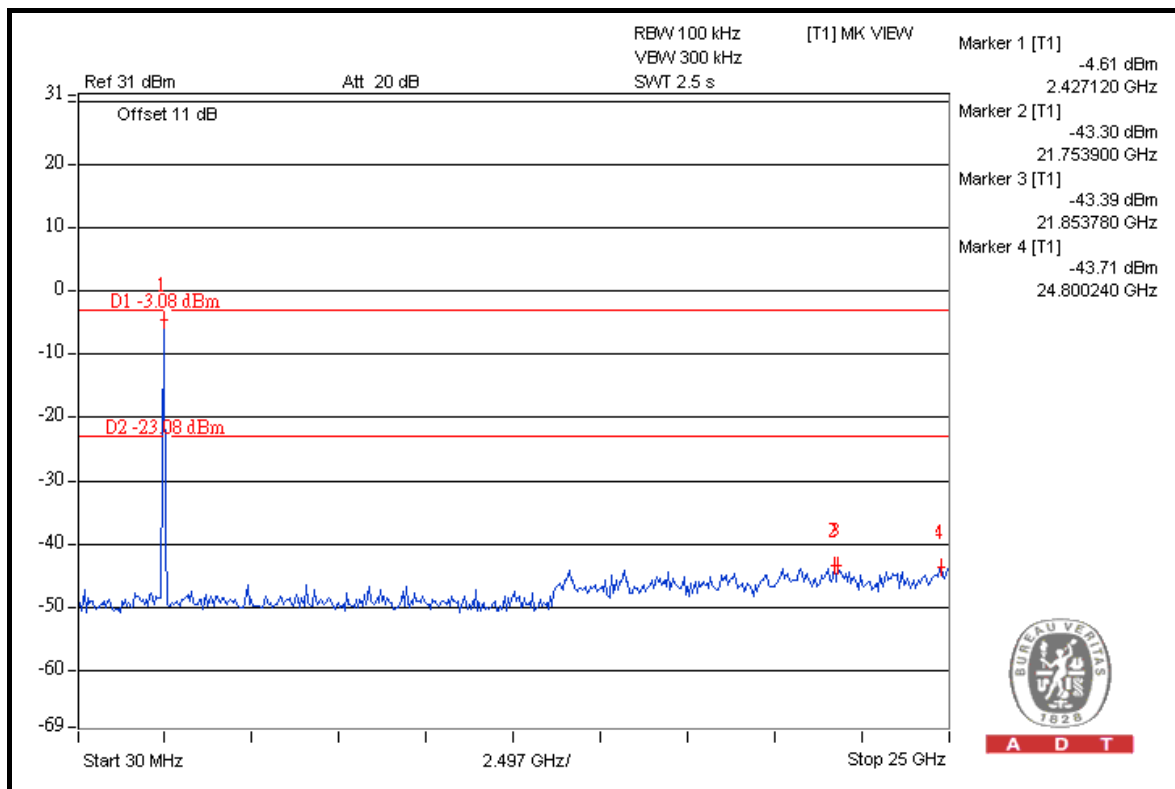

A D T



802.11n (40MHz)

RESTRICT BAND (2310 ~ 2390 MHz)

FREQUENCY (MHz)	FUNDAMENTAL EMISSION (dBuV/m)	DELTA (dB)	MAXIMUM FIELD STRENGTH IN RESTRICT BAND (dBuV/m)	LIMIT (dBuV/m)
2422.00 (PK)	105.3	38.38	66.92	74.00
2422.00 (AV)	95.1	42.96	52.14	54.00

RESTRICT BAND (2483.5 ~ 2500 MHz)

FREQUENCY (MHz)	FUNDAMENTAL EMISSION (dBuV/m)	DELTA (dB)	MAXIMUM FIELD STRENGTH IN RESTRICT BAND (dBuV/m)	LIMIT (dBuV/m)
2452.00 (PK)	105.8	40.63	65.17	74.00
2452.00 (AV)	95.4	45.28	50.12	54.00

NOTE:

1. Delta = Amplitude between the peak of the fundamental and the peak of the band edge emission. Please check following 2 pages.
2. Maximum field strength in restrict band = Fundamental emission – Delta.



A D T

FOR RADIATED MEASURED (BOTH CHAINS ON)

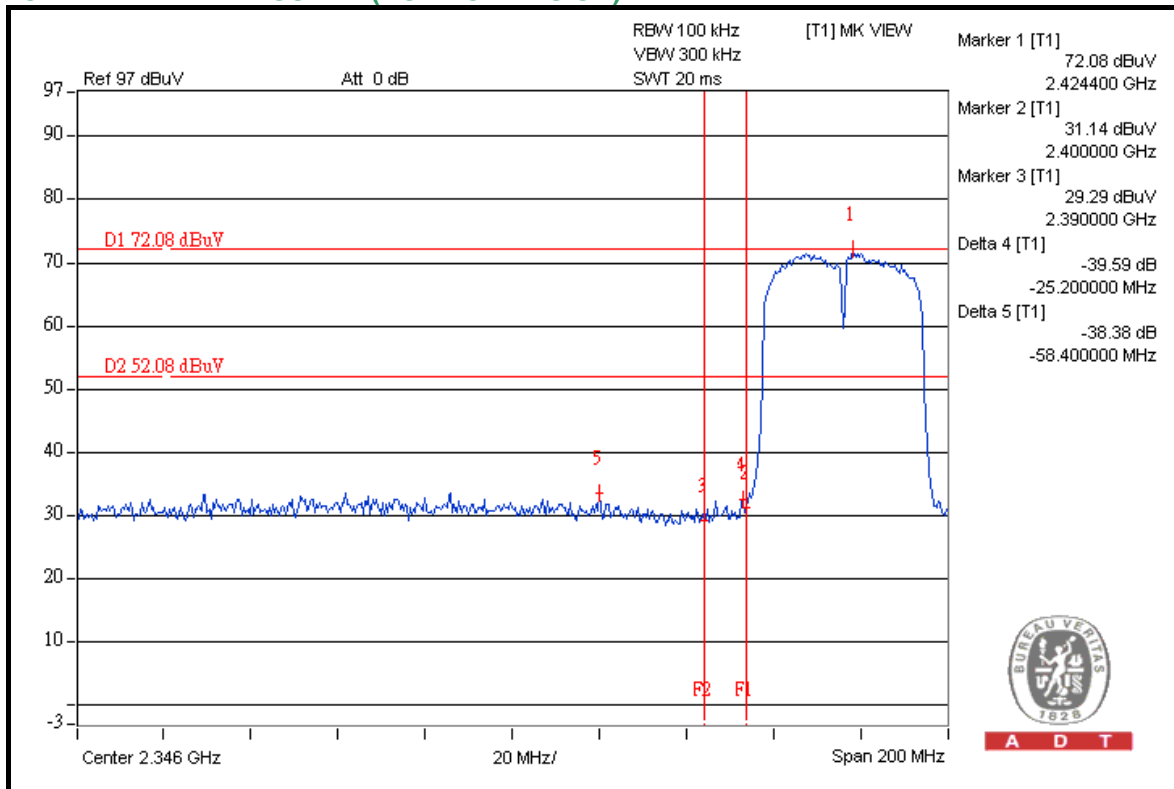

A D T

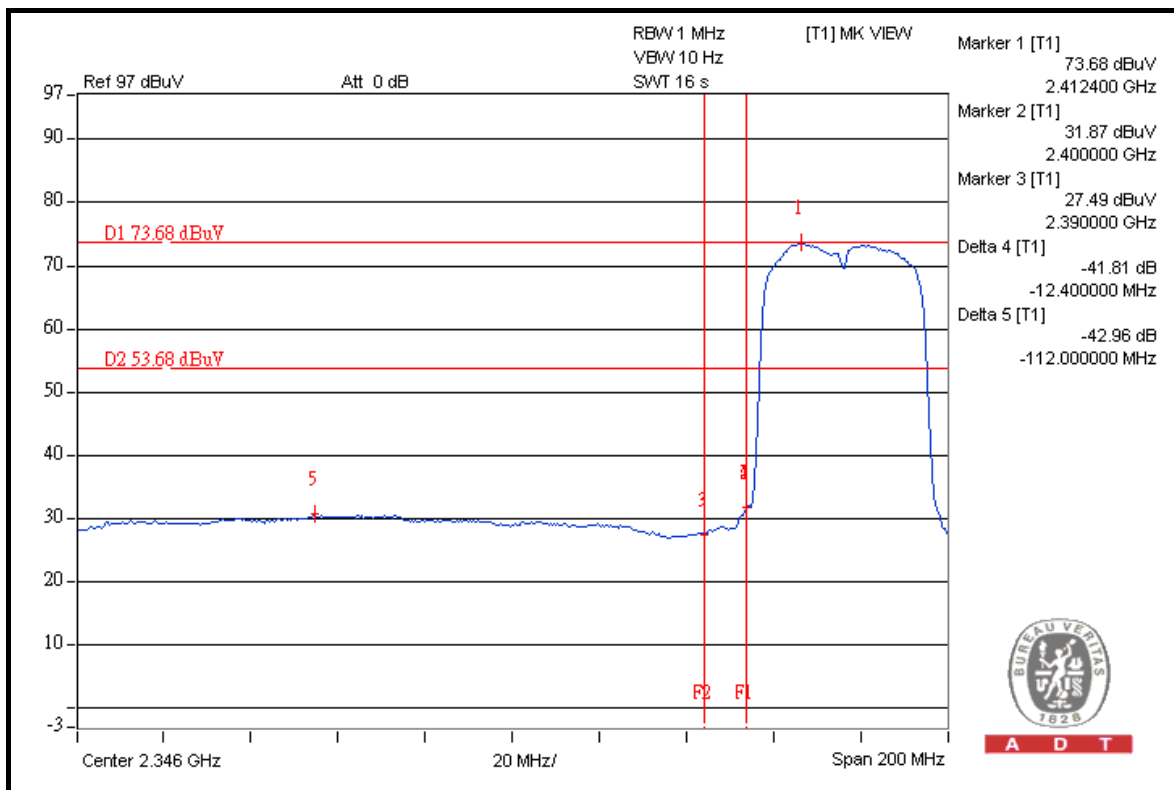

A D T



A D T

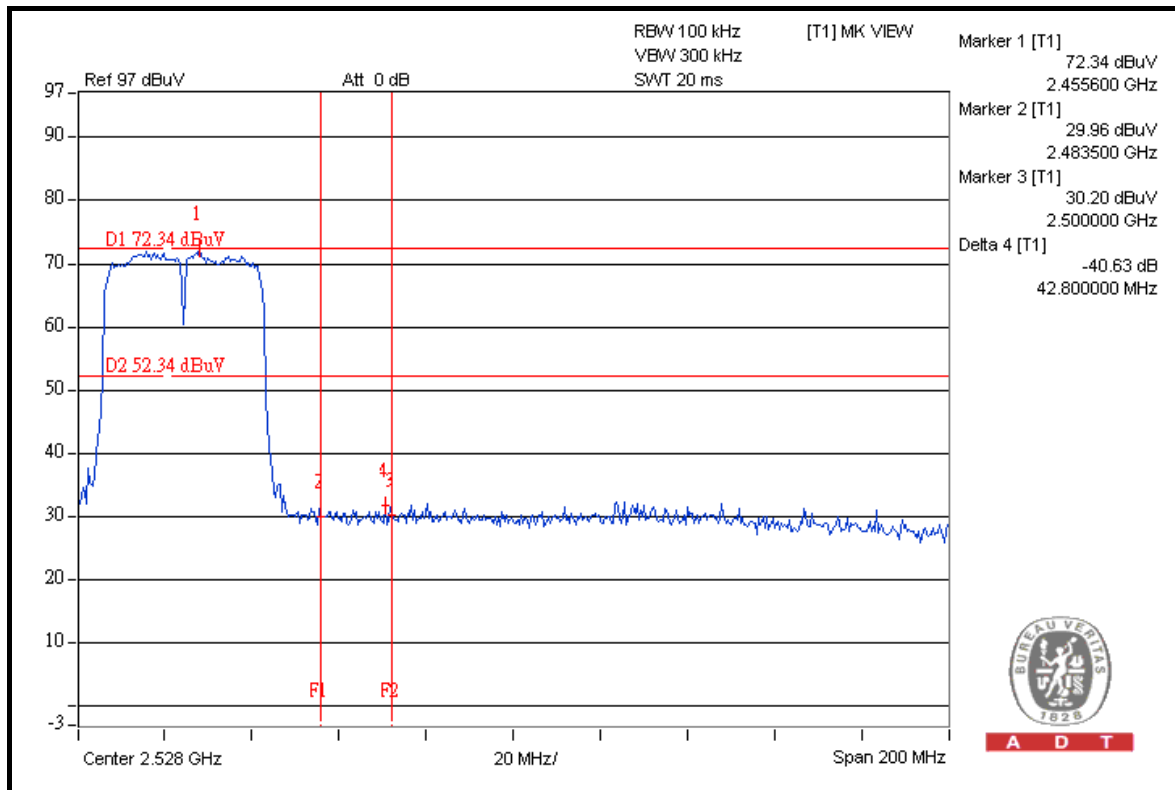

A D T

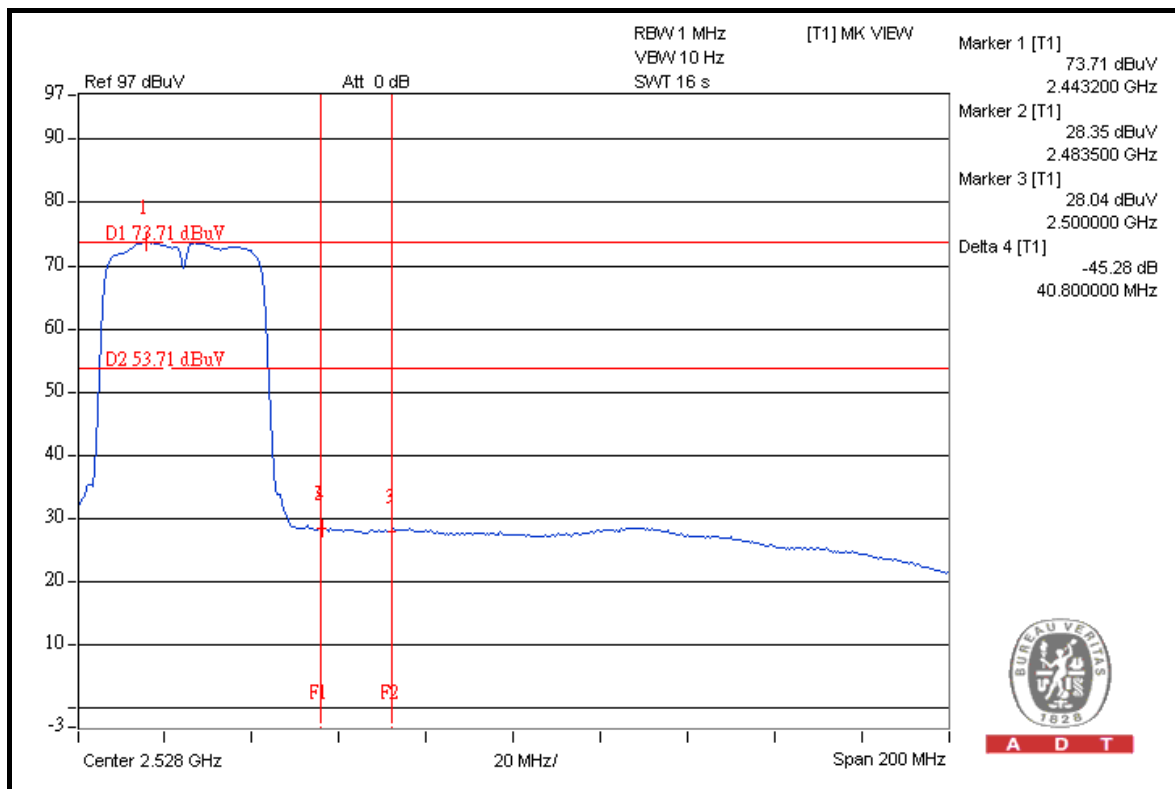

A D T



A D T

FOR CONDUCTED MEASURED CHAIN 0

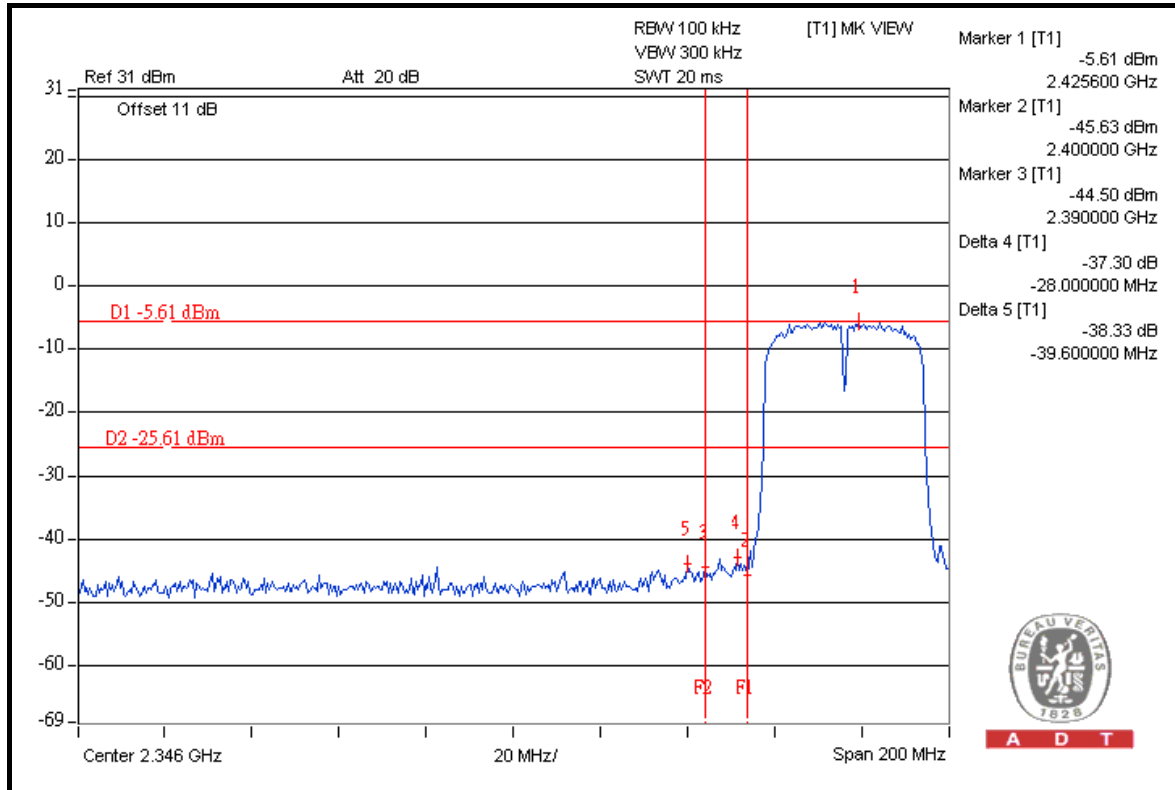

A D T

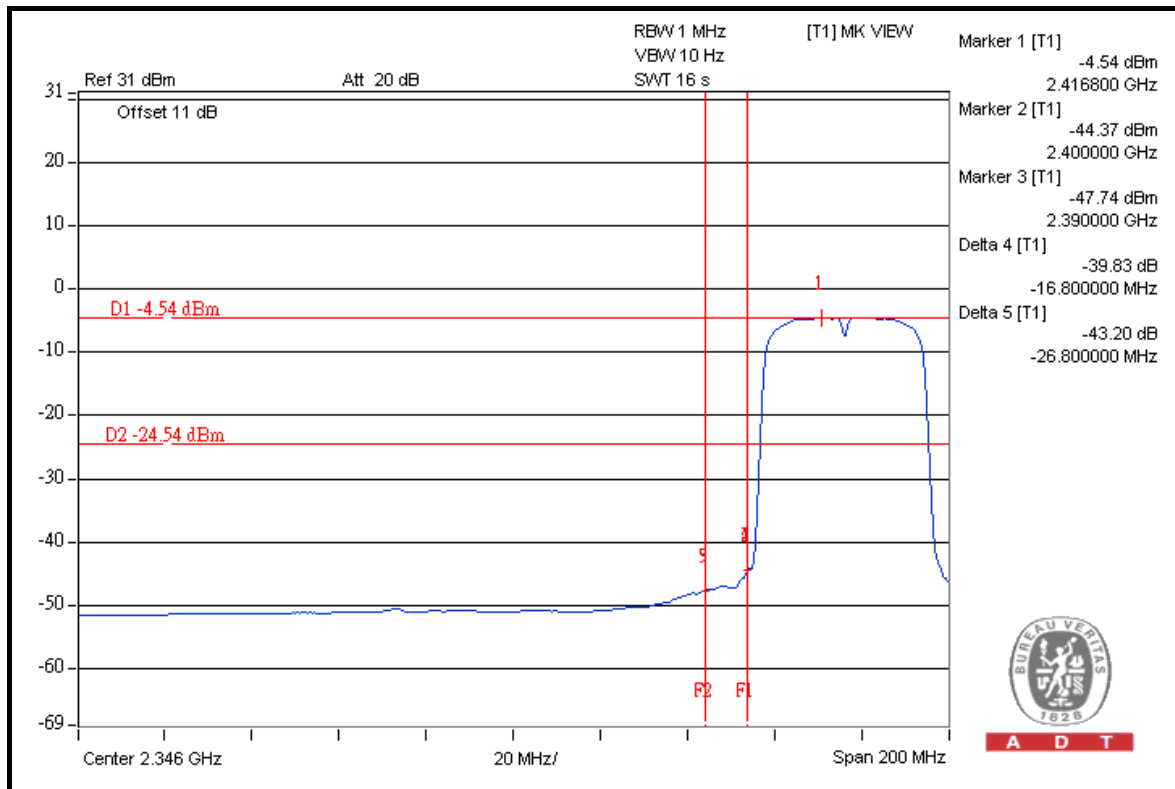

A D T



A D T

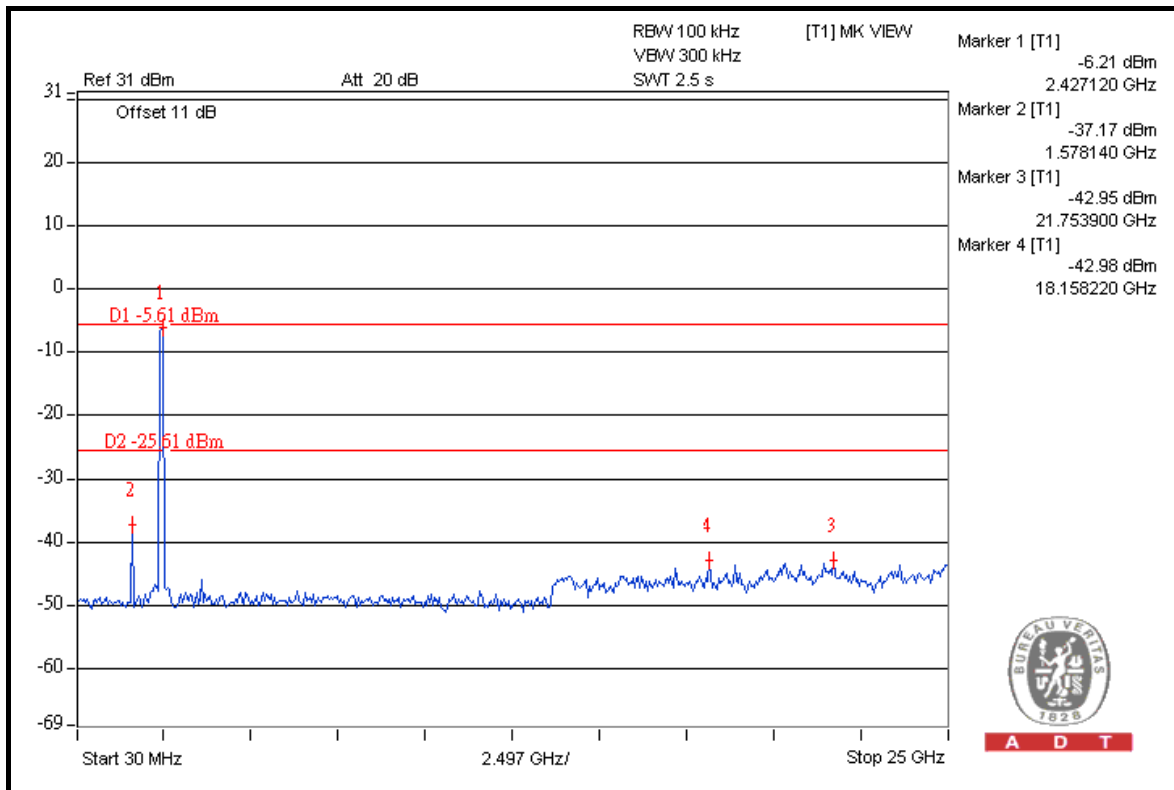

A D T

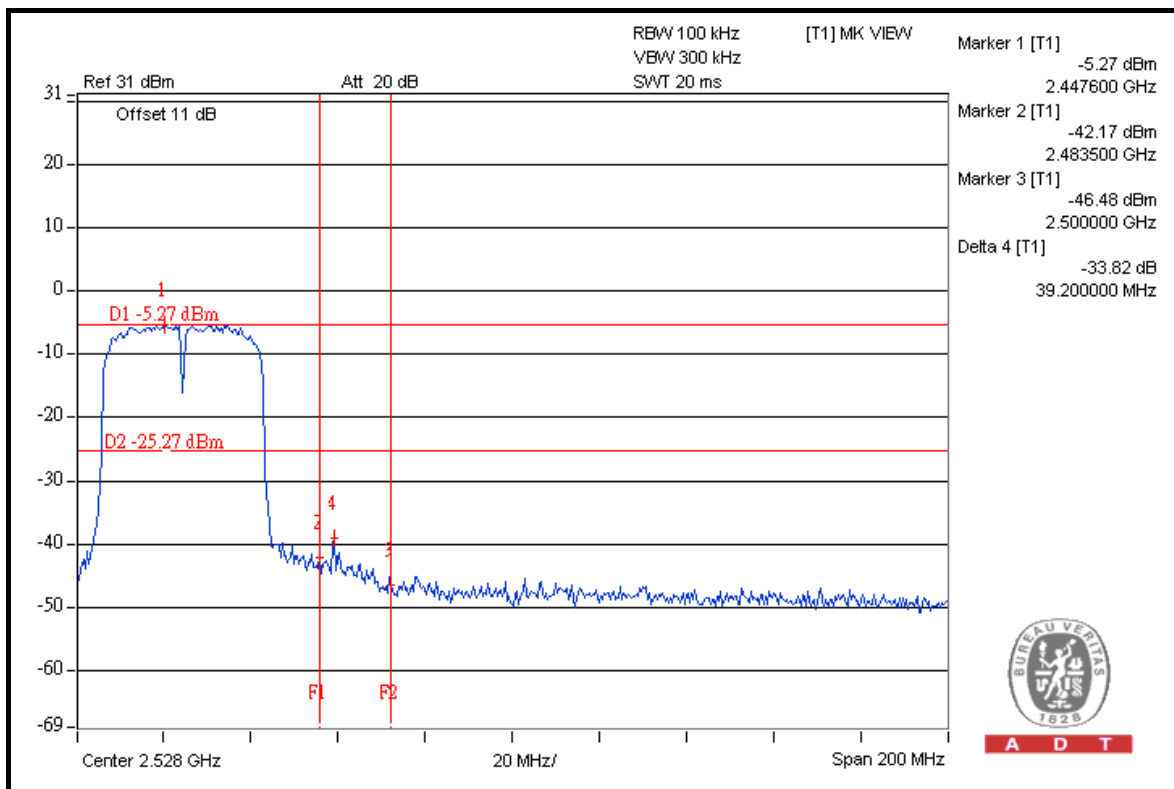

A D T



A D T

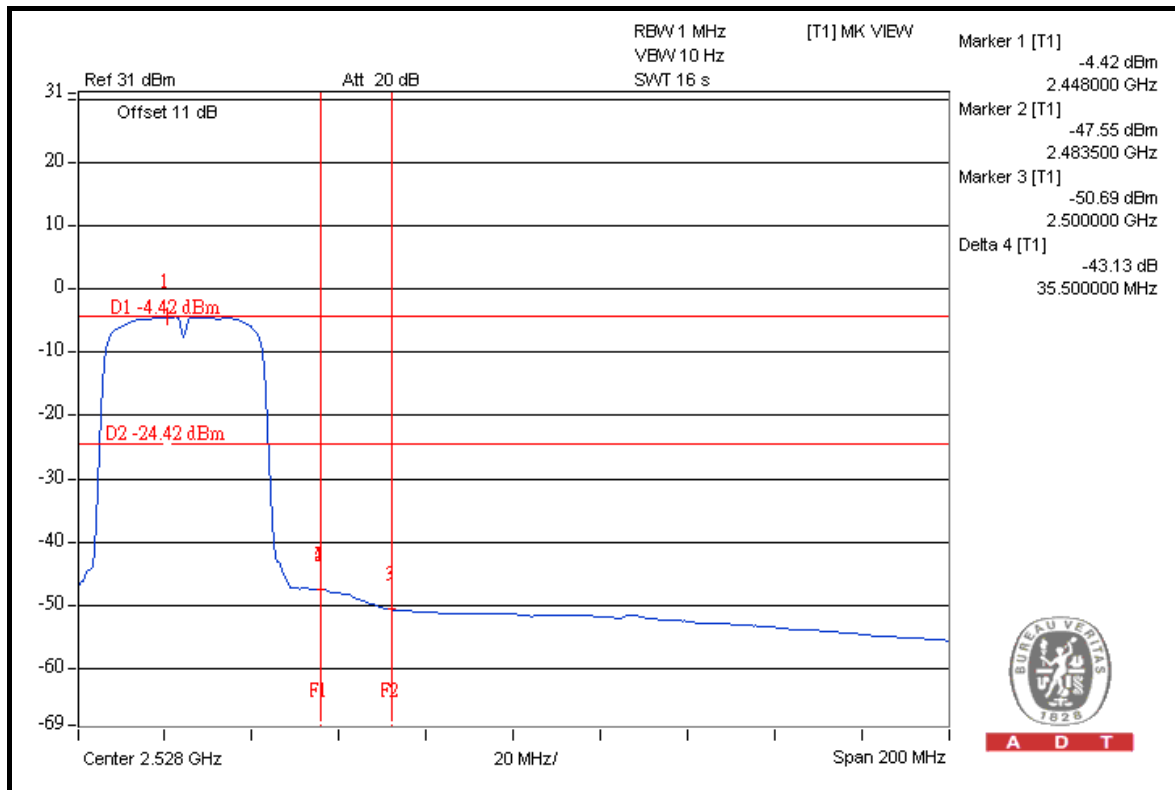

A D T

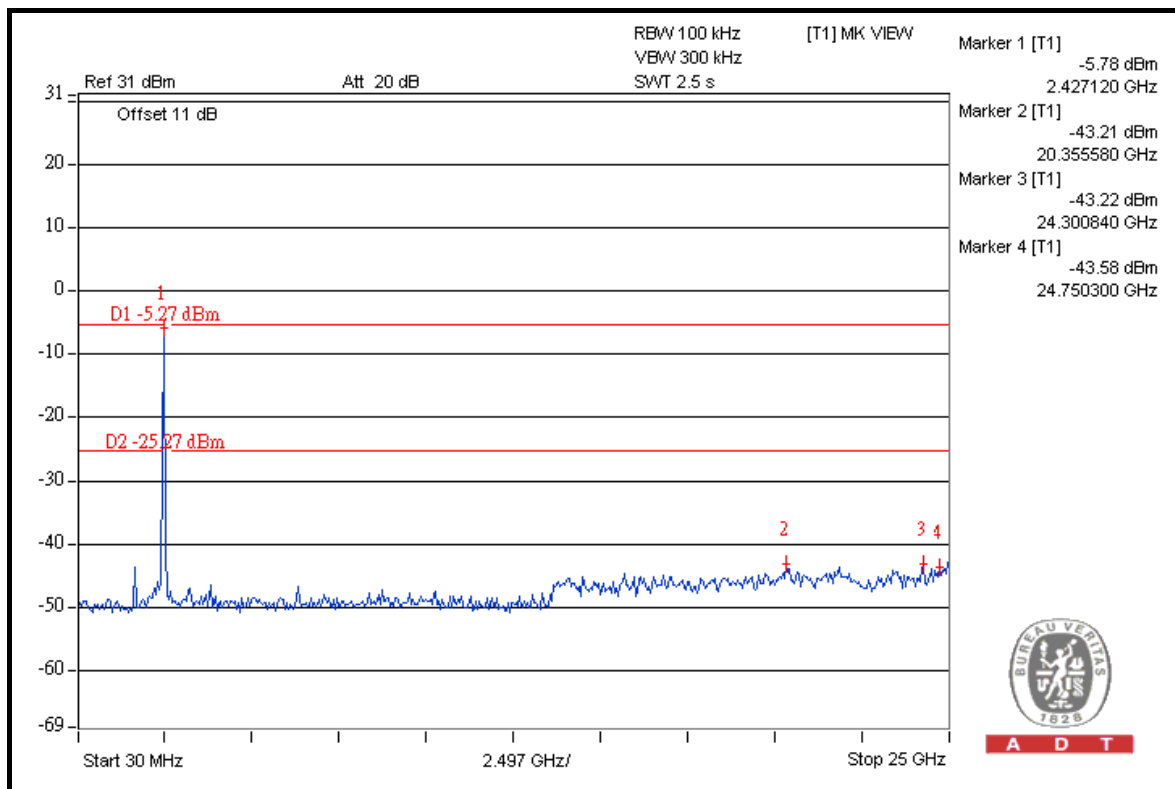

A D T



A D T

CHAIN 1

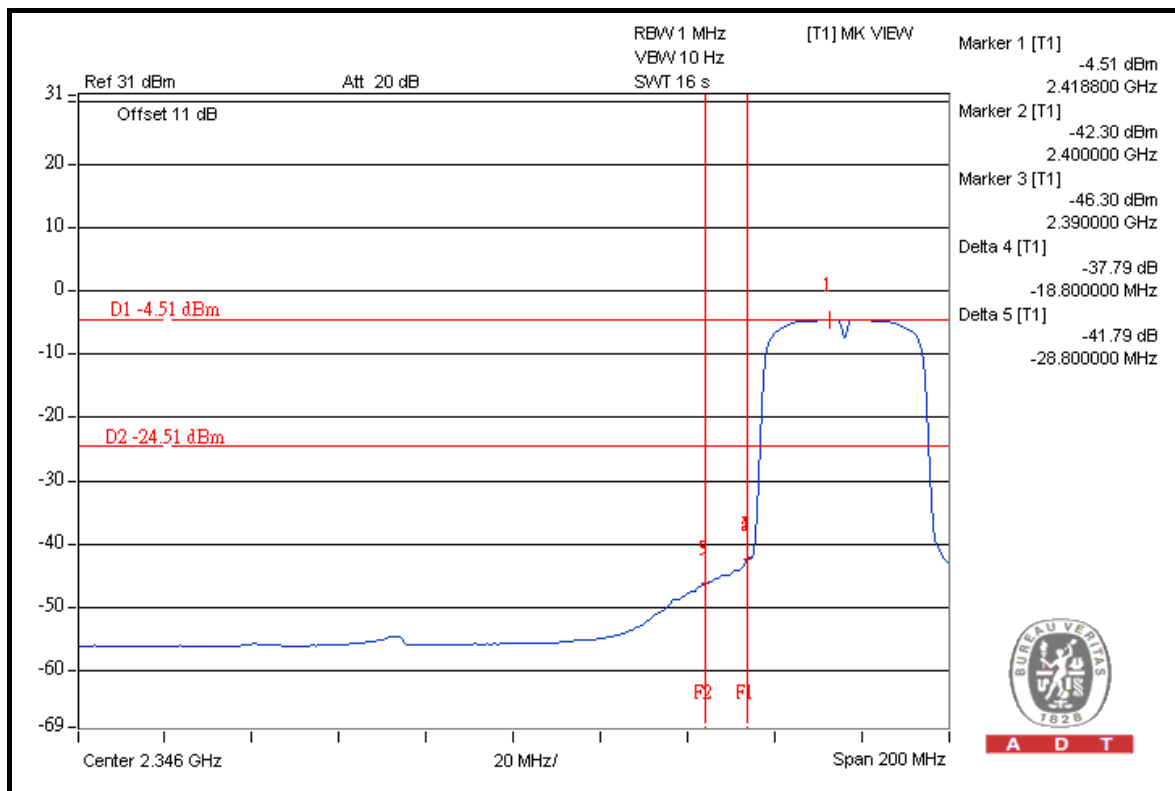
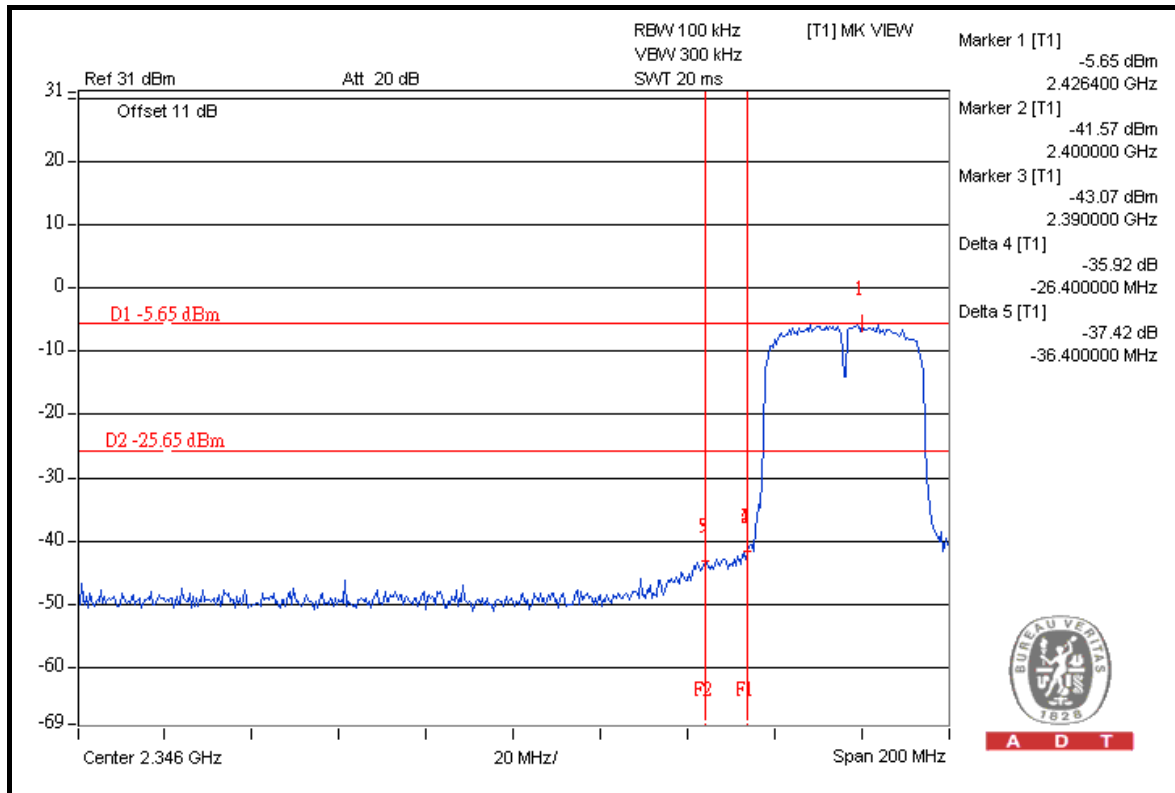



A D T

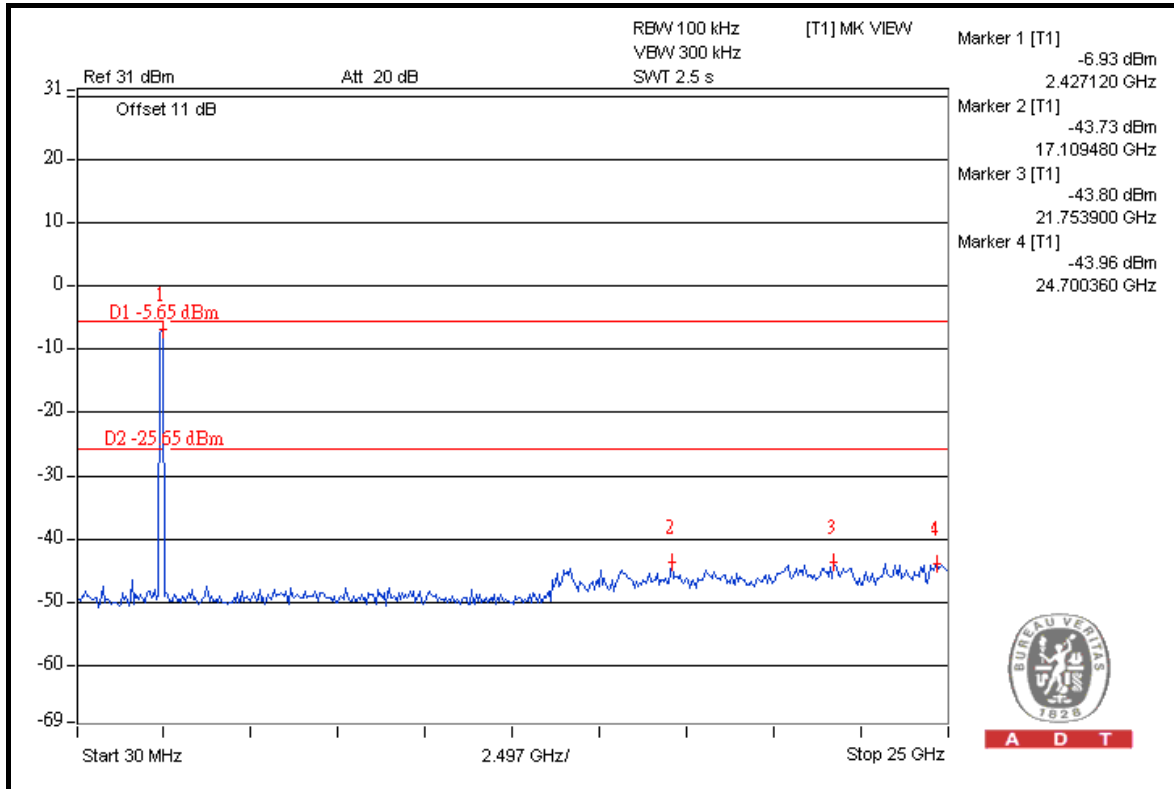

A D T

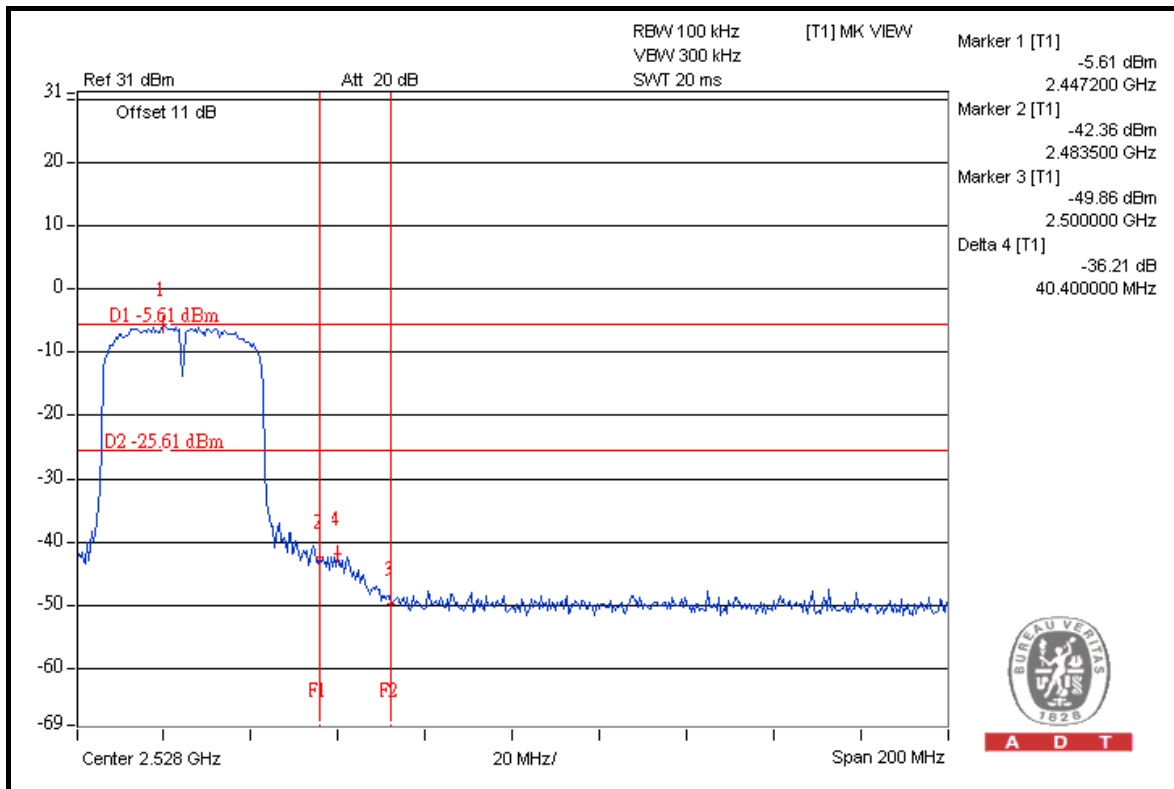

A D T



A D T

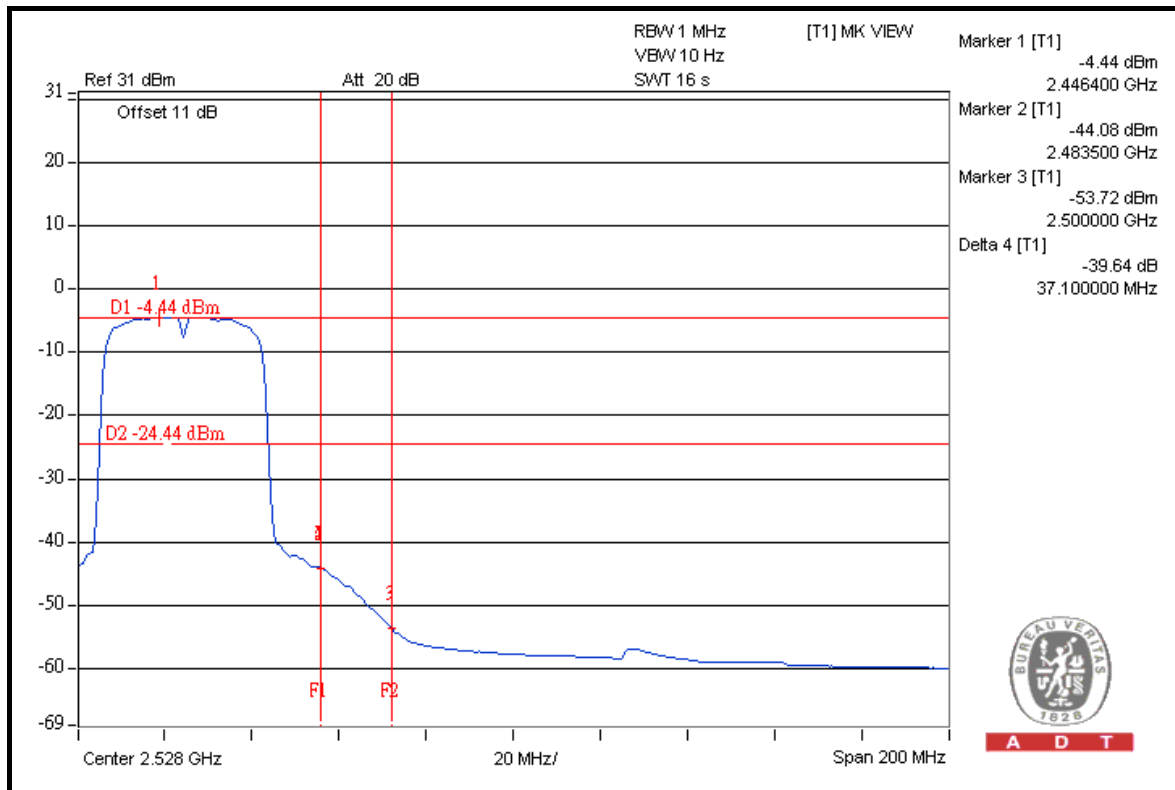

A D T

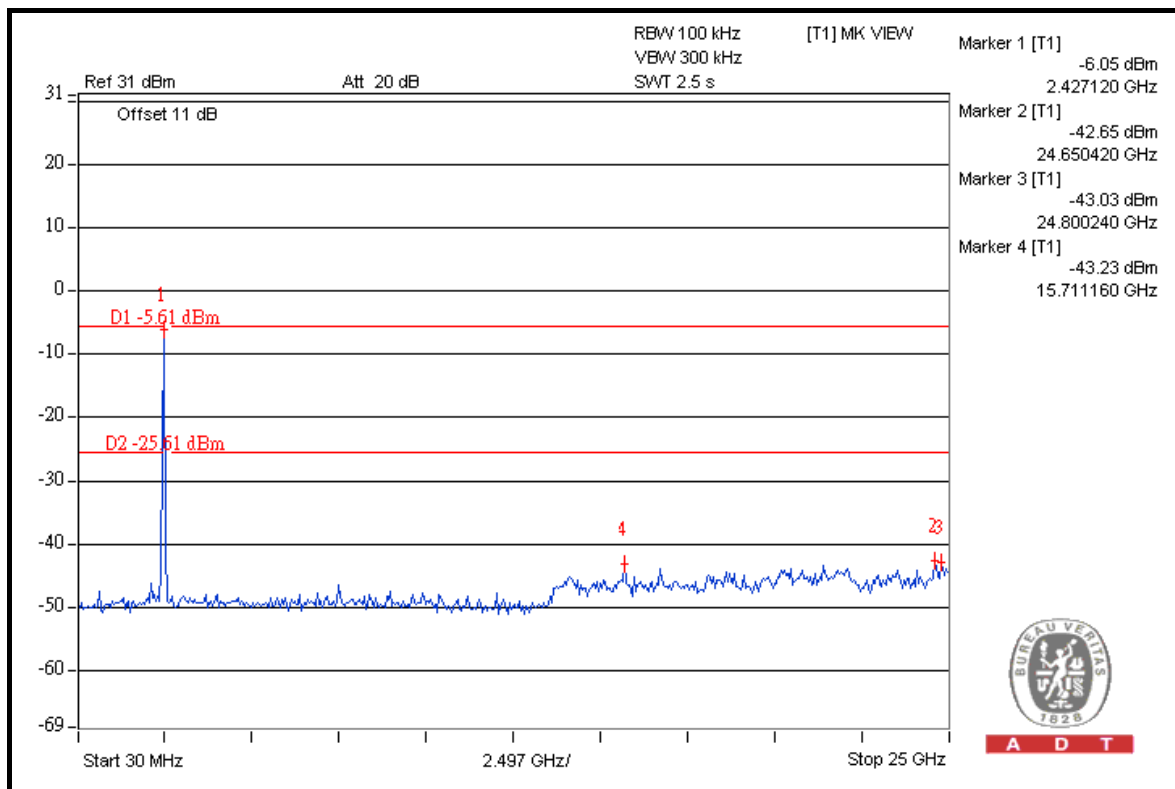

A D T



5. PHOTOGRAPHS OF THE TEST CONFIGURATION

Please refer to the attached file (Test Setup Photo).



6. INFORMATION ON THE TESTING LABORATORIES

We, Bureau Veritas Consumer Products Services (H.K.) Ltd., Taoyuan Branch, were founded in 1988 to provide our best service in EMC, Radio, Telecom and Safety consultation. Our laboratories are accredited and approved according to ISO/IEC 17025.

Copies of accreditation and authorization certificates of our laboratories obtained from approval agencies can be downloaded from our web site: www.adt.com.tw/index.5.phtml. If you have any comments, please feel free to contact us at the following:

Linko EMC/RF Lab:

Tel: 886-2-26052180

Fax: 886-2-26051924

Hsin Chu EMC/RF Lab:

Tel: 886-3-5935343

Fax: 886-3-5935342

Hwa Ya EMC/RF/Safety Telecom Lab:

Tel: 886-3-3183232

Fax: 886-3-3185050

Email: service.adt@tw.bureauveritas.com

Web Site: www.adt.com.tw

The address and road map of all our labs can be found in our web site also.



7. APPENDIX A - MODIFICATIONS RECORDERS FOR ENGINEERING CHANGES TO THE EUT BY THE LAB

No any modifications are made to the EUT by the lab during the test.

---END---