

FCC Test Report

Report No.: RF190604C42

FCC ID: KA2IR1750A1

Test Model: DIR-1750

Received Date: Jun. 04, 2019

Test Date: Jun. 13 ~ Jun. 22, 2019

Issued Date: Jul. 03, 2019

Applicant: D-Link Corporation

Address: 17595 Mt. Herrmann, Fountain Valley, California, United States, 92708

Issued By: Bureau Veritas Consumer Products Services (H.K.) Ltd., Taoyuan Branch

Lab Address: No. 47-2, 14th Ling, Chia Pau Vil., Lin Kou Dist., New Taipei City, Taiwan (R.O.C.)

Test Location: No. 19, Hwa Ya 2nd Rd., Wen Hwa Vil., Kwei Shan Dist., Taoyuan City 33383, TAIWAN (R.O.C.)

**FCC Registration /
Designation Number:** 788550 / TW0003



This report is for your exclusive use. Any copying or replication of this report to or for any other person or entity, or use of our name or trademark, is permitted only with our prior written permission. This report sets forth our findings solely with respect to the test samples identified herein. The results set forth in this report are not indicative or representative of the quality or characteristics of the lot from which a test sample was taken or any similar or identical product unless specifically and expressly noted. Our report includes all of the tests requested by you and the results thereof based upon the information that you provided to us. You have 60 days from date of issuance of this report to notify us of any material error or omission caused by our negligence, provided, however, that such notice shall be in writing and shall specifically address the issue you wish to raise. A failure to raise such issue within the prescribed time shall constitute your unqualified acceptance of the completeness of this report, the tests conducted and the correctness of the report contents. Unless specific mention, the uncertainty of measurement has been explicitly taken into account to declare the compliance or non-compliance to the specification. This report should not be used by the client to claim product certification, approval, or endorsement by TAF or any government agencies.

Table of Contents

Release Control Record	4
1 Certificate of Conformity	5
2 Summary of Test Results	6
2.1 Measurement Uncertainty.....	6
2.2 Modification Record.....	6
3 General Information	7
3.1 General Description of EUT.....	7
3.2 Description of Test Modes.....	8
3.2.1 Test Mode Applicability and Tested Channel Detail.....	9
3.3 Duty Cycle of Test Signal.....	10
3.4 Description of Support Units.....	11
3.4.1 Configuration of System under Test.....	11
3.5 General Description of Applied Standards.....	11
4 Test Types and Results	12
4.1 Radiated Emission and Bandedge Measurement.....	12
4.1.1 Limits of Radiated Emission and Bandedge Measurement.....	12
4.1.2 Test Instruments.....	13
4.1.3 Test Procedures.....	14
4.1.4 Deviation from Test Standard.....	14
4.1.5 Test Setup.....	15
4.1.6 EUT Operating Conditions.....	16
4.1.7 Test Results.....	17
4.2 Conducted Emission Measurement.....	31
4.2.1 Limits of Conducted Emission Measurement.....	31
4.2.2 Test Instruments.....	31
4.2.3 Test Procedures.....	32
4.2.4 Deviation from Test Standard.....	32
4.2.5 Test Setup.....	32
4.2.6 EUT Operating Conditions.....	32
4.2.7 Test Results.....	33
4.3 6dB Bandwidth Measurement.....	35
4.3.1 Limits of 6dB Bandwidth Measurement.....	35
4.3.2 Test Setup.....	35
4.3.3 Test Instruments.....	35
4.3.4 Test Procedure.....	35
4.3.5 Deviation from Test Standard.....	35
4.3.6 EUT Operating Conditions.....	35
4.3.7 Test Result.....	36
4.4 Conducted Output Power Measurement.....	38
4.4.1 Limits of Conducted Output Power Measurement.....	38
4.4.2 Test Setup.....	38
4.4.3 Test Instruments.....	38
4.4.4 Test Procedures.....	38
4.4.5 Deviation from Test Standard.....	38
4.4.6 EUT Operating Conditions.....	38
4.4.7 Test Results.....	39
4.5 Power Spectral Density Measurement.....	41
4.5.1 Limits of Power Spectral Density Measurement.....	41
4.5.2 Test Setup.....	41
4.5.3 Test Instruments.....	41
4.5.4 Test Procedure.....	41
4.5.5 Deviation from Test Standard.....	41
4.5.6 EUT Operating Condition.....	41

4.5.7 Test Results	42
4.6 Conducted Out of Band Emission Measurement.....	45
4.6.1 Limits of Conducted Out of Band Emission Measurement	45
4.6.2 Test Setup.....	45
4.6.3 Test Instruments	45
4.6.4 Test Procedure	45
4.6.5 Deviation from Test Standard	45
4.6.6 EUT Operating Condition	45
4.6.7 Test Results	45
5 Pictures of Test Arrangements.....	58
Appendix – Information on the Testing Laboratories	59

Release Control Record

Issue No.	Description	Date Issued
RF190604C42	Original release	Jul. 03, 2019

1 Certificate of Conformity

Product: AC1750 Gigabit Wi-Fi Router

Brand: D-Link

Test Model: DIR-1750

Sample Status: Engineering sample

Applicant: D-Link Corporation

Test Date: Jun. 13 ~ Jun. 22, 2019

Standards: 47 CFR FCC Part 15, Subpart C (Section 15.247)
ANSI C63.10:2013

The above equipment has been tested by **Bureau Veritas Consumer Products Services (H.K.) Ltd., Taoyuan Branch**, and found compliance with the requirement of the above standards. The test record, data evaluation & Equipment Under Test (EUT) configurations represented herein are true and accurate accounts of the measurements of the sample's RF characteristics under the conditions specified in this report.

Prepared by : Celine Chou , **Date:** Jul. 03, 2019
Celine Chou / Senior Specialist

Approved by : Bruce Chen , **Date:** Jul. 03, 2019
Bruce Chen / Project Engineer

2 Summary of Test Results

47 CFR FCC Part 15, Subpart C (Section 15.247)			
FCC Clause	Test Item	Result	Remarks
15.207	AC Power Conducted Emission	Pass	Meet the requirement of limit. Minimum passing margin is -12.85dB at 0.15760MHz.
15.205 / 15.209 / 15.247(d)	Radiated Emissions and Band Edge Measurement	Pass	Meet the requirement of limit. Minimum passing margin is -0.2dB at 2483.50MHz.
15.247(d)	Antenna Port Emission	Pass	Meet the requirement of limit.
15.247(a)(2)	6dB bandwidth	Pass	Meet the requirement of limit.
15.247(b)	Conducted power	Pass	Meet the requirement of limit.
15.247(e)	Power Spectral Density	Pass	Meet the requirement of limit.
15.203	Antenna Requirement	Pass	Antenna connector is i-pex(MHF) not a standard connector.

Note: Determining compliance based on the results of the compliance measurement, not taking into account measurement instrumentation uncertainty.

2.1 Measurement Uncertainty

Where relevant, the following measurement uncertainty levels have been estimated for tests performed on the EUT as specified in CISPR 16-4-2:

Measurement	Frequency	Expanded Uncertainty (k=2) (\pm)
Conducted Emissions at mains ports	150kHz ~ 30MHz	2.94 dB
Radiated Emissions up to 1 GHz	9kHz ~ 30MHz	3.04 dB
	30MHz ~ 200MHz	3.86 dB
	200MHz ~ 1000MHz	3.87 dB
Radiated Emissions above 1 GHz	1GHz ~ 18GHz	2.29 dB
	18GHz ~ 40GHz	2.29 dB

2.2 Modification Record

There were no modifications required for compliance.

3 General Information

3.1 General Description of EUT

Product	AC1750 Gigabit Wi-Fi Router
Brand	D-Link
Test Model	DIR-1750
Sample Status	Engineering sample
Power Supply Rating	12Vdc from adapter
Modulation Type	CCK, DQPSK, DBPSK for DSSS 64QAM, 16QAM, QPSK, BPSK for OFDM
Modulation Technology	DSSS, OFDM
Transfer Rate	802.11b: 11/5.5/2/1Mbps 802.11g: 54/48/36/24/18/12/9/6Mbps 802.11n: up to 450Mbps
Operating Frequency	2412 ~ 2462MHz
Number of Channel	802.11b, 802.11g, 802.11n (HT20): 11 802.11n (HT40): 7
Output Power	CDD Mode: 820.178mW Beamforming Mode: 503.198mW
Antenna Type	Refer to note
Antenna Connector	Refer to note
Accessory Device	Adapter
Cable Supplied	NA

Note:

- The EUT incorporates a MIMO function. Physically, the EUT provides 3 completed transmitters and 3 receivers.

Modulation Mode	Beamforming Mode	TX Function
802.11b	Not Support	3TX
802.11g	Not Support	3TX
802.11n (HT20)	Support	3TX
802.11n (HT40)	Support	3TX

* For 802.11n, CDD mode and Beamforming mode are presented in power output test item. For other test items, CDD mode is the worst case for final tests after pretesting.

- The EUT consumes power from the following adapters.

Adapter 1	
Brand	D-Link
Model	2ABB018F US
Input Power	100-240Vac, 50/60Hz, 0.6A
Output Power	12Vdc, 1.5A
Power Line	1.2m DC cable without core attached on adapter

Adapter 2	
Brand	APD
Model	WB-18Q12FU1
Input Power	100-240Vac, 50-60Hz, 0.6A
Output Power	12Vdc, 1.5A
Power Line	1.2m DC cable without core attached on adapter

* Adapter 1 was chosen for final test and presented in the test report.

3. The following antennas were provided to the EUT.

No.	Brand	Model	Type	Connector	Gain (dBi)	
					2.4G	5G
1	whayu	C056-511196-A	Dipole	i-pex(MHF)	4	-
2	whayu	C056-511197-A	Dipole	i-pex(MHF)	-	5
3	whayu	C056-511198-A	Dipole	i-pex(MHF)	3	4
4	whayu	C056-511198-A	Dipole	i-pex(MHF)	3	4

3.2 Description of Test Modes

11 channels are provided for 802.11b, 802.11g and 802.11n (HT20):

Channel	Frequency	Channel	Frequency
1	2412MHz	7	2442MHz
2	2417MHz	8	2447MHz
3	2422MHz	9	2452MHz
4	2427MHz	10	2457MHz
5	2432MHz	11	2462MHz
6	2437MHz		

7 channels are provided for 802.11n (HT40):

Channel	Frequency	Channel	Frequency
3	2422MHz	7	2442MHz
4	2427MHz	8	2447MHz
5	2432MHz	9	2452MHz
6	2437MHz		

3.2.1 Test Mode Applicability and Tested Channel Detail

EUT Configure Mode	Applicable to				Description
	RE \geq 1G	RE<1G	PLC	APCM	
-	√	√	√	√	-

Where RE \geq 1G: Radiated Emission above 1GHz & Bandedge Measurement
 RE<1G: Radiated Emission below 1GHz
 PLC: Power Line Conducted Emission
 APCM: Antenna Port Conducted Measurement

Note: The EUT had been pre-tested on the positioned of each 3 axis. The worst case was found when positioned on **X-plane**.

Radiated Emission Test (Above 1GHz):

- Pre-Scan has been conducted to determine the worst-case mode from all possible combinations between available modulations, data rates and antenna ports (if EUT with antenna diversity architecture).
- Following channel(s) was (were) selected for the final test as listed below.

EUT Configure Mode	Mode	Available Channel	Tested Channel	Modulation Technology	Modulation Type	Data Rate (Mbps)
-	802.11b	1 to 11	1, 6, 11	DSSS	DBPSK	1.0
-	802.11g	1 to 11	1, 6, 11	OFDM	BPSK	6.0
-	802.11n (HT20)	1 to 11	1, 6, 11	OFDM	BPSK	6.5
-	802.11n (HT40)	3 to 9	3, 6, 9	OFDM	BPSK	13.5

Radiated Emission Test (Below 1GHz):

- Pre-Scan has been conducted to determine the worst-case mode from all possible combinations between available modulations, data rates and antenna ports (if EUT with antenna diversity architecture).
- Following channel(s) was (were) selected for the final test as listed below.

EUT Configure Mode	Mode	Available Channel	Tested Channel	Modulation Technology	Modulation Type	Data Rate (Mbps)
-	802.11b	1 to 11	6	DSSS	DBPSK	1.0

Power Line Conducted Emission Test:

- Pre-Scan has been conducted to determine the worst-case mode from all possible combinations between available modulations, data rates and antenna ports (if EUT with antenna diversity architecture).
- Following channel(s) was (were) selected for the final test as listed below.

EUT Configure Mode	Mode	Available Channel	Tested Channel	Modulation Technology	Modulation Type	Data Rate (Mbps)
-	802.11b	1 to 11	6	DSSS	DBPSK	1.0

Antenna Port Conducted Measurement:

- This item includes all test value of each mode, but only includes spectrum plot of worst value of each mode.
- Pre-Scan has been conducted to determine the worst-case mode from all possible combinations between available modulations, data rates and antenna ports (if EUT with antenna diversity architecture).
- Following channel(s) was (were) selected for the final test as listed below.

EUT Configure Mode	Mode	Available Channel	Tested Channel	Modulation Technology	Modulation Type	Data Rate (Mbps)
-	802.11b	1 to 11	1, 6, 11	DSSS	DBPSK	1.0
-	802.11g	1 to 11	1, 6, 11	OFDM	BPSK	6.0
-	802.11n (HT20)	1 to 11	1, 6, 11	OFDM	BPSK	6.5
-	802.11n (HT40)	3 to 9	3, 6, 9	OFDM	BPSK	13.5

Test Condition:

Applicable to	Environmental Conditions	Input Power	Tested by
RE \geq 1G	22 deg. C, 66% RH	120Vac, 60Hz	Adair Peng
RE $<$ 1G	24 deg. C, 68% RH	120Vac, 60Hz	Adair Peng
PLC	23 deg. C, 67% RH	120Vac, 60Hz	Adair Peng
APCM	25 deg. C, 60% RH	120Vac, 60Hz	Leo Tsai

3.3 Duty Cycle of Test Signal

Duty cycle of test signal is < 98%, duty factor is required.

802.11b: Duty cycle = 8.410/8.620 = 0.976, Duty factor = 10 * log (1/0.976) = 0.11

802.11g: Duty cycle = 1.388/1.608 = 0.863, Duty factor = 10 * log (1/0.863) = 0.64

802.11n (HT20): Duty cycle = 1.304/1.382 = 0.944, Duty factor = 10 * log (1/0.944) = 0.25

802.11n (HT40): Duty cycle = 0.644/0.714 = 0.902, Duty factor = 10 * log (1/0.902) = 0.45

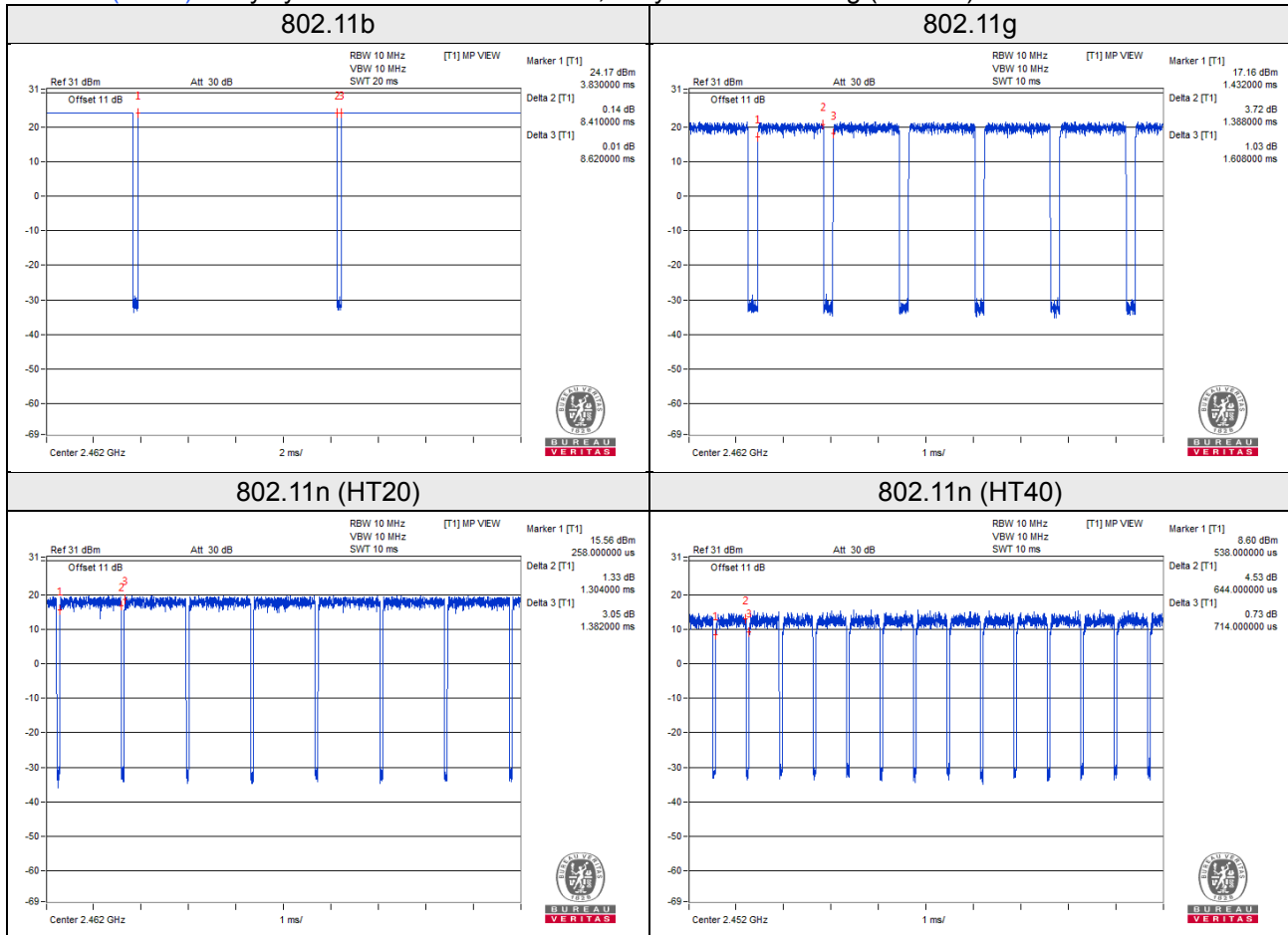

3.4 Description of Support Units

The EUT has been tested as an independent unit together with other necessary accessories or support units. The following support units or accessories were used to form a representative test configuration during the tests.

ID	Product	Brand	Model No.	Serial No.	FCC ID	Remarks
A.	Notebook	DELL	E5410	1HC2XM1	FCC DoC Approved	-
B.	Load	NA	NA	NA	NA	-

Note:

1. All power cords of the above support units are non-shielded (1.8m).
2. Item A acted as a communication partner to transfer data.

ID	Descriptions	Qty.	Length (m)	Shielding (Yes/No)	Cores (Qty.)	Remarks
1.	RJ45 cable	4	1.5	N	0	Cat5e
2.	RJ45 cable	1	6	N	0	Cat5e

3.4.1 Configuration of System under Test

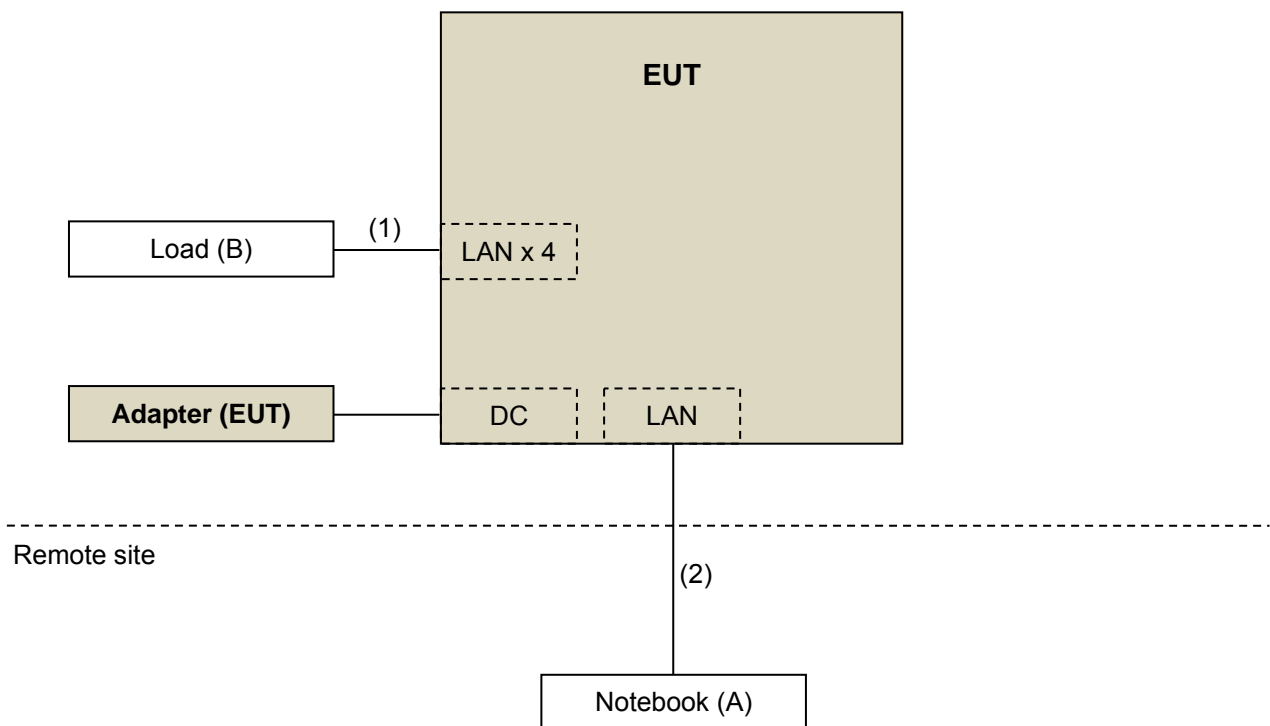

3.5 General Description of Applied Standards

The EUT is a RF Product. According to the specifications of the manufacturer, it must comply with the requirements of the following standards:

FCC Part 15, Subpart C (15.247)

KDB 558074 D01 15.247 Meas Guidance v05r02

KDB 662911 D01 Multiple Transmitter Output v02r01

ANSI C63.10-2013

All test items have been performed and recorded as per the above standards.

4 Test Types and Results

4.1 Radiated Emission and Bandedge Measurement

4.1.1 Limits of Radiated Emission and Bandedge Measurement

Radiated emissions which fall in the restricted bands must comply with the radiated emission limits specified as below table. Other emissions shall be at least 30dB below the highest level of the desired power:

Frequencies (MHz)	Field Strength (microvolts/meter)	Measurement Distance (meters)
0.009 ~ 0.490	2400/F(kHz)	300
0.490 ~ 1.705	24000/F(kHz)	30
1.705 ~ 30.0	30	30
30 ~ 88	100	3
88 ~ 216	150	3
216 ~ 960	200	3
Above 960	500	3

Note:

1. The lower limit shall apply at the transition frequencies.
2. Emission level (dBuV/m) = 20 log Emission level (uV/m).
3. For frequencies above 1000MHz, the field strength limits are based on average detector, however, the peak field strength of any emission shall not exceed the maximum permitted average limits, specified above by more than 20dB under any condition of modulation.

4.1.2 Test Instruments

Description & Manufacturer	Model No.	Serial No.	Cal. Date	Cal. Due
Test Receiver ROHDE & SCHWARZ	ESIB7	100187	May 30, 2019	May 29, 2020
BILOG Antenna SCHWARZBECK	VULB9168	9168-171	Nov. 22, 2018	Nov. 21, 2019
HORN Antenna SCHWARZBECK	9120D	209	Nov. 25, 2018	Nov. 24, 2019
HORN Antenna SCHWARZBECK	BBHA 9170	BBHA9170241	Nov. 25, 2018	Nov. 24, 2019
Loop Antenna EMCI	EM-6879	269	Sep. 07, 2018	Sep. 06, 2019
Preamplifier Agilent (Below 1GHz)	8447D	2944A10738	Aug. 21, 2018	Aug. 20, 2019
Preamplifier Agilent (Above 1GHz)	8449B	3008A02465	Mar. 27, 2019	Mar. 26, 2020
RF signal cable HUBER+SUHNER	SUCOFLEX 104	Cable-CH3-03 (223653/4)	Aug. 21, 2018	Aug. 20, 2019
RF signal cable HUBER+SUHNER& EMCI	SUCOFLEX 104&EMC104-SM-S M-8000	Cable-CH3-03 (309224+170907)	Aug. 21, 2018	Aug. 20, 2019
Software BV ADT	ADT_Radiated_ V7.6.15.9.5	NA	NA	NA
Antenna Tower inn-co GmbH	MA 4000	013303	NA	NA
Antenna Tower Controller BV ADT	AT100	AT93021702	NA	NA
Turn Table BV ADT	TT100	TT93021702	NA	NA
Turn Table Controller BV ADT	SC100	SC93021702	NA	NA
Boresight Antenna Fixture	FBA-01	FBA-SIP01	NA	NA
Pre-amplifier (18GHz-40GHz) EMC	EMC184045B	980175	Nov. 14, 2018	Nov. 13, 2019
USB Wideband Power Sensor KEYSIGHT	U2021XA	MY55050005/MY5519 0004/MY55190007/MY 55210005	Jul. 17, 2018	Jul. 16, 2019

- Note: 1. The calibration interval of the above test instruments is 12 months and the calibrations are traceable to NML/ROC and NIST/USA.
2. The test was performed in HwaYa Chamber 3.

4.1.3 Test Procedures

For Radiated emission below 30MHz

- a. The EUT was placed on the top of a rotating table 0.8 meters above the ground at a 3 meter chamber room. The table was rotated 360 degrees to determine the position of the highest radiation.
- b. The EUT was set 3 meters away from the interference-receiving antenna, which was mounted on the top of a variable-height antenna tower.
- c. Parallel, perpendicular, and ground-parallel orientations of the antenna are set to make the measurement.
- d. For each suspected emission, the EUT was arranged to its worst case and the rotatable table was turned from 0 degrees to 360 degrees to find the maximum reading.
- e. The test-receiver system was set to Quasi-Peak Detect Function and Specified Bandwidth with Maximum Hold Mode.

Note:

1. The resolution bandwidth and video bandwidth of test receiver/spectrum analyzer is 9kHz at frequency below 30MHz.

For Radiated emission above 30MHz

- a. The EUT was placed on the top of a rotating table 0.8 meters (for 30MHz ~ 1GHz) / 1.5 meters (for above 1GHz) above the ground at 3 meter chamber room for test. The table was rotated 360 degrees to determine the position of the highest radiation.
- b. The EUT was set 3 meters away from the interference-receiving antenna, which was mounted on the top of a variable-height antenna tower.
- c. The height of antenna is varied from one meter to four meters above the ground to determine the maximum value of the field strength. Both horizontal and vertical polarizations of the antenna are set to make the measurement.
- d. For each suspected emission, the EUT was arranged to its worst case and then the antenna was tuned to heights from 1 meter to 4 meters and the rotatable table was turned from 0 degrees to 360 degrees to find the maximum reading.
- e. The test-receiver system was set to quasi-peak detect function and specified bandwidth with maximum hold mode when the test frequency is below 1 GHz.
- f. The test-receiver system was set to peak and average detect function and specified bandwidth with maximum hold mode when the test frequency is above 1 GHz. If the peak reading value also meets average limit, measurement with the average detector is unnecessary.

Note:

1. The resolution bandwidth and video bandwidth of test receiver/spectrum analyzer is 120kHz for Quasi-peak detection (QP) at frequency below 1GHz.
2. The resolution bandwidth of test receiver/spectrum analyzer is 1 MHz and the video bandwidth is 3 MHz for Peak detection (PK) at frequency above 1GHz.
3. The resolution bandwidth of test receiver/spectrum analyzer is 1MHz and the video bandwidth is $\geq 1/T$ (Duty cycle < 98%) or 10Hz (Duty cycle $\geq 98\%$) for Average detection (AV) at frequency above 1GHz.
4. All modes of operation were investigated and the worst-case emissions are reported.

4.1.4 Deviation from Test Standard

No deviation.

4.1.5 Test Setup

For Radiated emission below 30MHz

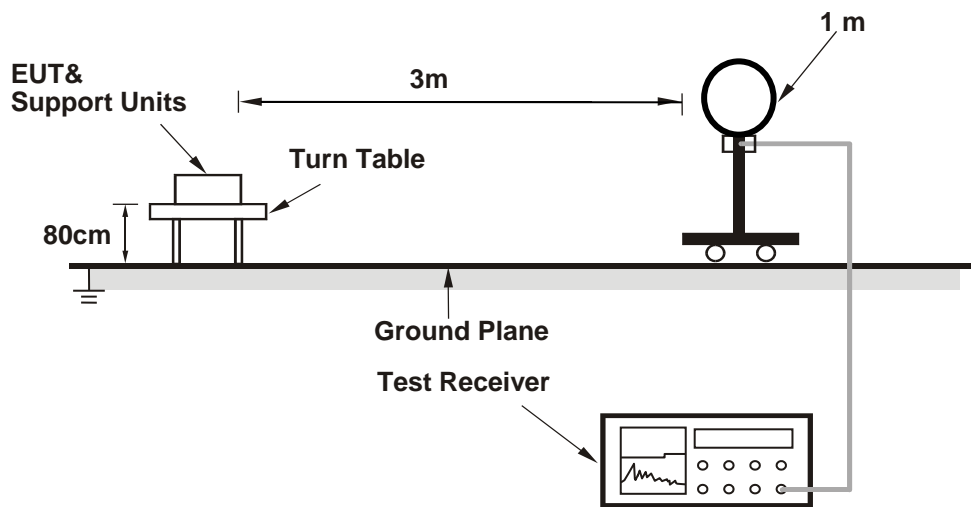

For Radiated emission 30MHz to 1GHz

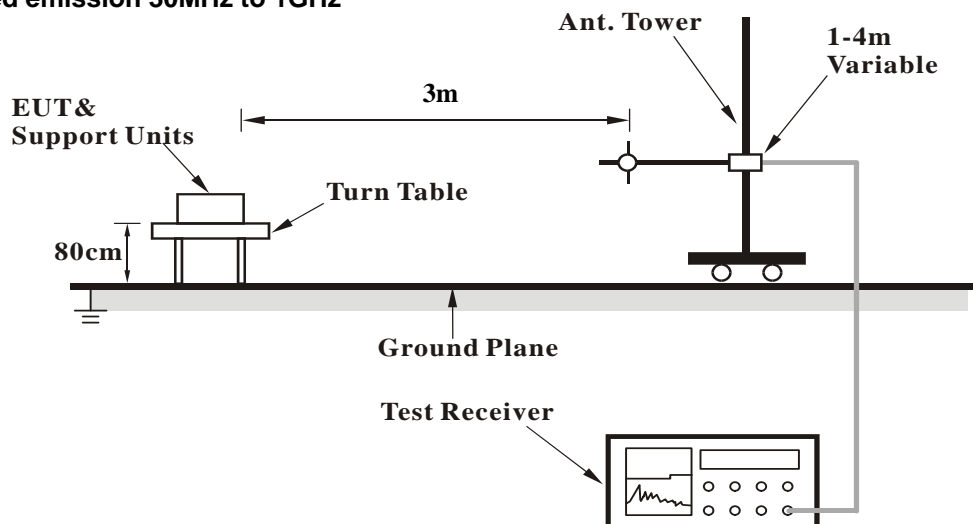

For Radiated emission above 1GHz

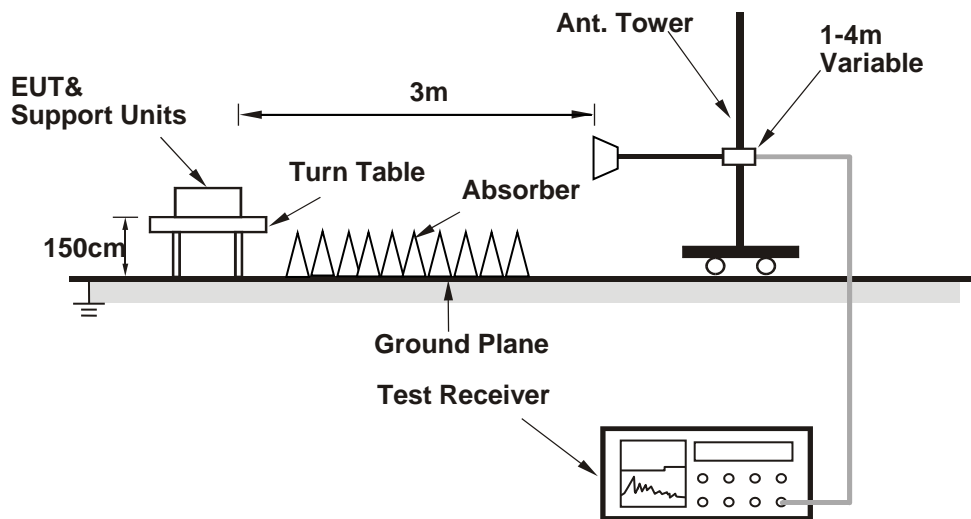

For the actual test configuration, please refer to the attached file (Test Setup Photo).

4.1.6 EUT Operating Conditions

- a. Placed the EUT on the testing table.
- b. Prepared a notebook to act as a communication partner and placed it outside of testing area.
- c. The communication partner connected with EUT via a RJ45 cable and ran a test program (provided by manufacturer) to enable EUT under transmission condition continuously at specific channel frequency.
- d. The communication partner sent data to EUT by command "PING".

4.1.7 Test Results

Above 1GHz Data:

802.11b

CHANNEL	TX Channel 1	DETECTOR FUNCTION	Peak (PK) Average (AV)
FREQUENCY RANGE	1GHz ~ 25GHz		

ANTENNA POLARITY & TEST DISTANCE: HORIZONTAL AT 3 M								
NO.	FREQ. (MHz)	EMISSION LEVEL (dBuV/m)	LIMIT (dBuV/m)	MARGIN (dB)	ANTENNA HEIGHT (m)	TABLE ANGLE (Degree)	RAW VALUE (dBuV)	CORRECTION FACTOR (dB/m)
1	2390.00	59.8 PK	74.0	-14.2	2.05 H	301	26.9	32.9
2	2390.00	47.7 AV	54.0	-6.3	2.05 H	301	14.8	32.9
3	*2412.00	108.3 PK			1.99 H	295	75.4	32.9
4	*2412.00	104.0 AV			1.99 H	295	71.1	32.9
5	4824.00	48.9 PK	74.0	-25.1	1.71 H	162	45.2	3.7
6	4824.00	38.0 AV	54.0	-16.0	1.71 H	162	34.3	3.7
ANTENNA POLARITY & TEST DISTANCE: VERTICAL AT 3 M								
NO.	FREQ. (MHz)	EMISSION LEVEL (dBuV/m)	LIMIT (dBuV/m)	MARGIN (dB)	ANTENNA HEIGHT (m)	TABLE ANGLE (Degree)	RAW VALUE (dBuV)	CORRECTION FACTOR (dB/m)
1	2390.00	63.4 PK	74.0	-10.6	1.43 V	151	30.5	32.9
2	2390.00	53.2 AV	54.0	-0.8	1.43 V	151	20.3	32.9
3	*2412.00	120.0 PK			1.59 V	146	87.1	32.9
4	*2412.00	116.1 AV			1.59 V	146	83.2	32.9
5	4824.00	52.6 PK	74.0	-21.4	1.44 V	42	48.9	3.7
6	4824.00	48.5 AV	54.0	-5.5	1.44 V	42	44.8	3.7

Remarks:

1. Emission Level(dBuV/m) = Raw Value(dBuV) + Correction Factor(dB/m).
2. Correction Factor(dB/m) = Antenna Factor(dB/m) + Cable Factor(dB) – Pre-Amplifier Factor(dB).
3. Margin value = Emission Level – Limit value.
4. The other emission levels were very low against the limit.
5. " * ": Fundamental frequency.

CHANNEL	TX Channel 6	DETECTOR FUNCTION	Peak (PK) Average (AV)
FREQUENCY RANGE	1GHz ~ 25GHz		

ANTENNA POLARITY & TEST DISTANCE: HORIZONTAL AT 3 M

NO.	FREQ. (MHz)	EMISSION LEVEL (dBuV/m)	LIMIT (dBuV/m)	MARGIN (dB)	ANTENNA HEIGHT (m)	TABLE ANGLE (Degree)	RAW VALUE (dBuV)	CORRECTION FACTOR (dB/m)
1	*2437.00	109.9 PK			1.97 H	291	77.0	32.9
2	*2437.00	105.8 AV			1.97 H	291	72.9	32.9
3	2483.50	60.1 PK	74.0	-13.9	2.05 H	301	27.1	33.0
4	2483.50	48.1 AV	54.0	-5.9	2.05 H	301	15.1	33.0
5	4874.00	51.5 PK	74.0	-22.5	1.81 H	165	47.5	4.0
6	4874.00	41.1 AV	54.0	-12.9	1.81 H	165	37.1	4.0

ANTENNA POLARITY & TEST DISTANCE: VERTICAL AT 3 M

NO.	FREQ. (MHz)	EMISSION LEVEL (dBuV/m)	LIMIT (dBuV/m)	MARGIN (dB)	ANTENNA HEIGHT (m)	TABLE ANGLE (Degree)	RAW VALUE (dBuV)	CORRECTION FACTOR (dB/m)
1	*2437.00	121.7 PK			2.26 V	234	88.8	32.9
2	*2437.00	117.9 AV			2.26 V	234	85.0	32.9
3	2483.50	64.1 PK	74.0	-9.9	1.68 V	181	31.1	33.0
4	2483.50	53.3 AV	54.0	-0.7	1.68 V	181	20.3	33.0
5	4874.00	55.1 PK	74.0	-18.9	1.63 V	43	51.1	4.0
6	4874.00	51.2 AV	54.0	-2.8	1.63 V	43	47.2	4.0

Remarks:

1. Emission Level(dBuV/m) = Raw Value(dBuV) + Correction Factor(dB/m).
2. Correction Factor(dB/m) = Antenna Factor(dB/m) + Cable Factor(dB) – Pre-Amplifier Factor(dB).
3. Margin value = Emission Level – Limit value.
4. The other emission levels were very low against the limit.
5. " * " : Fundamental frequency.
6. " # " : The radiated frequency is out of the restricted band.

CHANNEL	TX Channel 11	DETECTOR FUNCTION	Peak (PK) Average (AV)
FREQUENCY RANGE	1GHz ~ 25GHz		

ANTENNA POLARITY & TEST DISTANCE: HORIZONTAL AT 3 M								
NO.	FREQ. (MHz)	EMISSION LEVEL (dBuV/m)	LIMIT (dBuV/m)	MARGIN (dB)	ANTENNA HEIGHT (m)	TABLE ANGLE (Degree)	RAW VALUE (dBuV)	CORRECTION FACTOR (dB/m)
1	*2462.00	108.5 PK			1.88 H	291	75.6	32.9
2	*2462.00	105.1 AV			1.88 H	291	72.2	32.9
3	2483.50	61.8 PK	74.0	-12.2	1.90 H	299	28.8	33.0
4	2483.50	48.4 AV	54.0	-5.6	1.90 H	299	15.4	33.0
5	4924.00	49.1 PK	74.0	-24.9	1.69 H	169	45.1	4.0
6	4924.00	37.5 AV	54.0	-16.5	1.69 H	169	33.5	4.0

ANTENNA POLARITY & TEST DISTANCE: VERTICAL AT 3 M								
NO.	FREQ. (MHz)	EMISSION LEVEL (dBuV/m)	LIMIT (dBuV/m)	MARGIN (dB)	ANTENNA HEIGHT (m)	TABLE ANGLE (Degree)	RAW VALUE (dBuV)	CORRECTION FACTOR (dB/m)
1	*2462.00	120.1 PK			1.54 V	148	87.2	32.9
2	*2462.00	116.4 AV			1.54 V	148	83.5	32.9
3	2483.50	64.2 PK	74.0	-9.8	1.62 V	153	31.2	33.0
4	2483.50	53.5 AV	54.0	-0.5	1.62 V	153	20.5	33.0
5	4924.00	52.7 PK	74.0	-21.3	1.48 V	53	48.7	4.0
6	4924.00	47.6 AV	54.0	-6.4	1.48 V	53	43.6	4.0

Remarks:

1. Emission Level(dBuV/m) = Raw Value(dBuV) + Correction Factor(dB/m).
2. Correction Factor(dB/m) = Antenna Factor(dB/m) + Cable Factor(dB) – Pre-Amplifier Factor(dB).
3. Margin value = Emission Level – Limit value.
4. The other emission levels were very low against the limit.
5. " * ": Fundamental frequency.

802.11g

CHANNEL	TX Channel 1	DETECTOR FUNCTION	Peak (PK) Average (AV)
FREQUENCY RANGE	1GHz ~ 25GHz		

ANTENNA POLARITY & TEST DISTANCE: HORIZONTAL AT 3 M								
NO.	FREQ. (MHz)	EMISSION LEVEL (dBuV/m)	LIMIT (dBuV/m)	MARGIN (dB)	ANTENNA HEIGHT (m)	TABLE ANGLE (Degree)	RAW VALUE (dBuV)	CORRECTION FACTOR (dB/m)
1	2390.00	64.0 PK	74.0	-10.0	2.05 H	297	31.1	32.9
2	2390.00	48.4 AV	54.0	-5.6	2.05 H	297	15.5	32.9
3	*2412.00	106.4 PK			1.91 H	289	73.5	32.9
4	*2412.00	96.6 AV			1.91 H	289	63.7	32.9
5	4824.00	46.2 PK	74.0	-27.8	1.65 H	170	42.5	3.7
6	4824.00	33.2 AV	54.0	-20.8	1.65 H	170	29.5	3.7

ANTENNA POLARITY & TEST DISTANCE: VERTICAL AT 3 M								
NO.	FREQ. (MHz)	EMISSION LEVEL (dBuV/m)	LIMIT (dBuV/m)	MARGIN (dB)	ANTENNA HEIGHT (m)	TABLE ANGLE (Degree)	RAW VALUE (dBuV)	CORRECTION FACTOR (dB/m)
1	2390.00	67.0 PK	74.0	-7.0	1.21 V	355	34.1	32.9
2	2390.00	53.3 AV	54.0	-0.7	1.21 V	355	20.4	32.9
3	*2412.00	117.9 PK			1.20 V	330	85.0	32.9
4	*2412.00	108.0 AV			1.20 V	330	75.1	32.9
5	4824.00	47.4 PK	74.0	-26.6	1.51 V	47	43.7	3.7
6	4824.00	34.2 AV	54.0	-19.8	1.51 V	47	30.5	3.7

Remarks:

1. Emission Level(dBuV/m) = Raw Value(dBuV) + Correction Factor(dB/m).
2. Correction Factor(dB/m) = Antenna Factor(dB/m) + Cable Factor(dB) – Pre-Amplifier Factor(dB).
3. Margin value = Emission Level – Limit value.
4. The other emission levels were very low against the limit.
5. " * ": Fundamental frequency.

CHANNEL	TX Channel 6	DETECTOR FUNCTION	Peak (PK) Average (AV)
FREQUENCY RANGE	1GHz ~ 25GHz		

ANTENNA POLARITY & TEST DISTANCE: HORIZONTAL AT 3 M

NO.	FREQ. (MHz)	EMISSION LEVEL (dBuV/m)	LIMIT (dBuV/m)	MARGIN (dB)	ANTENNA HEIGHT (m)	TABLE ANGLE (Degree)	RAW VALUE (dBuV)	CORRECTION FACTOR (dB/m)
1	*2437.00	111.3 PK			2.05 H	297	78.4	32.9
2	*2437.00	101.7 AV			2.05 H	297	68.8	32.9
3	2483.50	67.4 PK	74.0	-6.6	1.88 H	307	34.4	33.0
4	2483.50	48.3 AV	54.0	-5.7	1.88 H	307	15.3	33.0
5	4874.00	48.4 PK	74.0	-25.6	1.78 H	169	44.4	4.0
6	4874.00	35.7 AV	54.0	-18.3	1.78 H	169	31.7	4.0

ANTENNA POLARITY & TEST DISTANCE: VERTICAL AT 3 M

NO.	FREQ. (MHz)	EMISSION LEVEL (dBuV/m)	LIMIT (dBuV/m)	MARGIN (dB)	ANTENNA HEIGHT (m)	TABLE ANGLE (Degree)	RAW VALUE (dBuV)	CORRECTION FACTOR (dB/m)
1	*2437.00	122.8 PK			2.05 V	210	89.9	32.9
2	*2437.00	113.4 AV			2.05 V	210	80.5	32.9
3	2483.50	70.3 PK	74.0	-3.7	1.68 V	156	37.3	33.0
4	2483.50	53.1 AV	54.0	-0.9	1.68 V	156	20.1	33.0
5	4874.00	51.5 PK	74.0	-22.5	1.36 V	47	47.5	4.0
6	4874.00	37.7 AV	54.0	-16.3	1.36 V	47	33.7	4.0

Remarks:

1. Emission Level(dBuV/m) = Raw Value(dBuV) + Correction Factor(dB/m).
2. Correction Factor(dB/m) = Antenna Factor(dB/m) + Cable Factor(dB) – Pre-Amplifier Factor(dB).
3. Margin value = Emission Level – Limit value.
4. The other emission levels were very low against the limit.
5. " * ": Fundamental frequency.

CHANNEL	TX Channel 11	DETECTOR FUNCTION	Peak (PK) Average (AV)
FREQUENCY RANGE	1GHz ~ 25GHz		

ANTENNA POLARITY & TEST DISTANCE: HORIZONTAL AT 3 M

NO.	FREQ. (MHz)	EMISSION LEVEL (dBuV/m)	LIMIT (dBuV/m)	MARGIN (dB)	ANTENNA HEIGHT (m)	TABLE ANGLE (Degree)	RAW VALUE (dBuV)	CORRECTION FACTOR (dB/m)
1	*2462.00	105.0 PK			1.95 H	288	72.1	32.9
2	*2462.00	95.6 AV			1.95 H	288	62.7	32.9
3	2483.50	64.3 PK	74.0	-9.7	2.03 H	299	31.3	33.0
4	2483.50	48.5 AV	54.0	-5.5	2.03 H	299	15.5	33.0
5	4924.00	45.1 PK	74.0	-28.9	1.84 H	170	41.1	4.0
6	4924.00	33.3 AV	54.0	-20.7	1.84 H	170	29.3	4.0

ANTENNA POLARITY & TEST DISTANCE: VERTICAL AT 3 M

NO.	FREQ. (MHz)	EMISSION LEVEL (dBuV/m)	LIMIT (dBuV/m)	MARGIN (dB)	ANTENNA HEIGHT (m)	TABLE ANGLE (Degree)	RAW VALUE (dBuV)	CORRECTION FACTOR (dB/m)
1	*2462.00	116.4 PK			1.61 V	237	83.5	32.9
2	*2462.00	106.6 AV			1.61 V	237	73.7	32.9
3	2483.50	67.9 PK	74.0	-6.1	1.76 V	155	34.9	33.0
4	2483.50	53.7 AV	54.0	-0.3	1.76 V	155	20.7	33.0
5	4924.00	47.3 PK	74.0	-26.7	1.41 V	49	43.3	4.0
6	4924.00	34.2 AV	54.0	-19.8	1.41 V	49	30.2	4.0

Remarks:

1. Emission Level(dBuV/m) = Raw Value(dBuV) + Correction Factor(dB/m).
2. Correction Factor(dB/m) = Antenna Factor(dB/m) + Cable Factor(dB) – Pre-Amplifier Factor(dB).
3. Margin value = Emission Level – Limit value.
4. The other emission levels were very low against the limit.
5. " * ": Fundamental frequency.

802.11n (HT20)

CHANNEL	TX Channel 1	DETECTOR FUNCTION	Peak (PK) Average (AV)
FREQUENCY RANGE	1GHz ~ 25GHz		

ANTENNA POLARITY & TEST DISTANCE: HORIZONTAL AT 3 M								
NO.	FREQ. (MHz)	EMISSION LEVEL (dBuV/m)	LIMIT (dBuV/m)	MARGIN (dB)	ANTENNA HEIGHT (m)	TABLE ANGLE (Degree)	RAW VALUE (dBuV)	CORRECTION FACTOR (dB/m)
1	2390.00	68.0 PK	74.0	-6.0	1.97 H	299	35.1	32.9
2	2390.00	48.2 AV	54.0	-5.8	1.97 H	299	15.3	32.9
3	*2412.00	105.6 PK			2.10 H	303	72.7	32.9
4	*2412.00	95.8 AV			2.10 H	303	62.9	32.9
5	4824.00	45.0 PK	74.0	-29.0	1.79 H	169	41.3	3.7
6	4824.00	32.6 AV	54.0	-21.4	1.79 H	169	28.9	3.7

ANTENNA POLARITY & TEST DISTANCE: VERTICAL AT 3 M								
NO.	FREQ. (MHz)	EMISSION LEVEL (dBuV/m)	LIMIT (dBuV/m)	MARGIN (dB)	ANTENNA HEIGHT (m)	TABLE ANGLE (Degree)	RAW VALUE (dBuV)	CORRECTION FACTOR (dB/m)
1	2390.00	71.5 PK	74.0	-2.5	1.75 V	205	38.6	32.9
2	2390.00	53.2 AV	54.0	-0.8	1.75 V	205	20.3	32.9
3	*2412.00	117.3 PK			1.61 V	150	84.4	32.9
4	*2412.00	107.7 AV			1.61 V	150	74.8	32.9
5	4824.00	47.2 PK	74.0	-26.8	1.40 V	43	43.5	3.7
6	4824.00	34.0 AV	54.0	-20.0	1.40 V	43	30.3	3.7

Remarks:

1. Emission Level(dBuV/m) = Raw Value(dBuV) + Correction Factor(dB/m).
2. Correction Factor(dB/m) = Antenna Factor(dB/m) + Cable Factor(dB) – Pre-Amplifier Factor(dB).
3. Margin value = Emission Level – Limit value.
4. The other emission levels were very low against the limit.
5. " * ": Fundamental frequency.

CHANNEL	TX Channel 6	DETECTOR FUNCTION	Peak (PK) Average (AV)
FREQUENCY RANGE	1GHz ~ 25GHz		

ANTENNA POLARITY & TEST DISTANCE: HORIZONTAL AT 3 M								
NO.	FREQ. (MHz)	EMISSION LEVEL (dBuV/m)	LIMIT (dBuV/m)	MARGIN (dB)	ANTENNA HEIGHT (m)	TABLE ANGLE (Degree)	RAW VALUE (dBuV)	CORRECTION FACTOR (dB/m)
1	*2437.00	111.1 PK			1.89 H	305	78.2	32.9
2	*2437.00	100.8 AV			1.89 H	305	67.9	32.9
3	2483.50	69.9 PK	74.0	-4.1	1.97 H	293	36.9	33.0
4	2483.50	48.5 AV	54.0	-5.5	1.97 H	293	15.5	33.0
5	4874.00	48.5 PK	74.0	-25.5	1.80 H	171	44.5	4.0
6	4874.00	35.3 AV	54.0	-18.7	1.80 H	171	31.3	4.0

ANTENNA POLARITY & TEST DISTANCE: VERTICAL AT 3 M								
NO.	FREQ. (MHz)	EMISSION LEVEL (dBuV/m)	LIMIT (dBuV/m)	MARGIN (dB)	ANTENNA HEIGHT (m)	TABLE ANGLE (Degree)	RAW VALUE (dBuV)	CORRECTION FACTOR (dB/m)
1	*2437.00	122.5 PK			2.04 V	199	89.6	32.9
2	*2437.00	112.6 AV			2.04 V	199	79.7	32.9
3	2483.50	73.5 PK	74.0	-0.5	1.43 V	330	40.5	33.0
4	2483.50	53.2 AV	54.0	-0.8	1.43 V	330	20.2	33.0
5	4874.00	51.3 PK	74.0	-22.7	1.45 V	50	47.3	4.0
6	4874.00	37.2 AV	54.0	-16.8	1.45 V	50	33.2	4.0

Remarks:

1. Emission Level(dBuV/m) = Raw Value(dBuV) + Correction Factor(dB/m).
2. Correction Factor(dB/m) = Antenna Factor(dB/m) + Cable Factor(dB) – Pre-Amplifier Factor(dB).
3. Margin value = Emission Level – Limit value.
4. The other emission levels were very low against the limit.
5. " * ": Fundamental frequency.

CHANNEL	TX Channel 11	DETECTOR FUNCTION	Peak (PK) Average (AV)
FREQUENCY RANGE	1GHz ~ 25GHz		

ANTENNA POLARITY & TEST DISTANCE: HORIZONTAL AT 3 M

NO.	FREQ. (MHz)	EMISSION LEVEL (dBuV/m)	LIMIT (dBuV/m)	MARGIN (dB)	ANTENNA HEIGHT (m)	TABLE ANGLE (Degree)	RAW VALUE (dBuV)	CORRECTION FACTOR (dB/m)
1	*2462.00	104.2 PK			1.95 H	296	71.3	32.9
2	*2462.00	93.8 AV			1.95 H	296	60.9	32.9
3	2483.50	66.9 PK	74.0	-7.1	1.99 H	309	33.9	33.0
4	2483.50	48.1 AV	54.0	-5.9	1.99 H	309	15.1	33.0
5	4924.00	45.1 PK	74.0	-28.9	1.81 H	166	41.1	4.0
6	4924.00	32.9 AV	54.0	-21.1	1.81 H	166	28.9	4.0

ANTENNA POLARITY & TEST DISTANCE: VERTICAL AT 3 M

NO.	FREQ. (MHz)	EMISSION LEVEL (dBuV/m)	LIMIT (dBuV/m)	MARGIN (dB)	ANTENNA HEIGHT (m)	TABLE ANGLE (Degree)	RAW VALUE (dBuV)	CORRECTION FACTOR (dB/m)
1	*2462.00	115.7 PK			1.69 V	243	82.8	32.9
2	*2462.00	105.8 AV			1.69 V	243	72.9	32.9
3	2483.50	70.3 PK	74.0	-3.7	1.70 V	175	37.3	33.0
4	2483.50	53.5 AV	54.0	-0.5	1.70 V	175	20.5	33.0
5	4924.00	46.9 PK	74.0	-27.1	1.37 V	46	42.9	4.0
6	4924.00	34.0 AV	54.0	-20.0	1.37 V	46	30.0	4.0

Remarks:

1. Emission Level(dBuV/m) = Raw Value(dBuV) + Correction Factor(dB/m).
2. Correction Factor(dB/m) = Antenna Factor(dB/m) + Cable Factor(dB) – Pre-Amplifier Factor(dB).
3. Margin value = Emission Level – Limit value.
4. The other emission levels were very low against the limit.
5. " * ": Fundamental frequency.

802.11n (HT40)

CHANNEL	TX Channel 3	DETECTOR FUNCTION	Peak (PK) Average (AV)
FREQUENCY RANGE	1GHz ~ 25GHz		

ANTENNA POLARITY & TEST DISTANCE: HORIZONTAL AT 3 M								
NO.	FREQ. (MHz)	EMISSION LEVEL (dBuV/m)	LIMIT (dBuV/m)	MARGIN (dB)	ANTENNA HEIGHT (m)	TABLE ANGLE (Degree)	RAW VALUE (dBuV)	CORRECTION FACTOR (dB/m)
1	2390.00	63.8 PK	74.0	-10.2	2.05 H	305	30.9	32.9
2	2390.00	47.8 AV	54.0	-6.2	2.05 H	305	14.9	32.9
3	*2422.00	97.9 PK			1.97 H	299	65.1	32.8
4	*2422.00	87.7 AV			1.97 H	299	54.9	32.8
5	4844.00	48.0 PK	74.0	-26.0	1.74 H	169	44.1	3.9
6	4844.00	35.2 AV	54.0	-18.8	1.74 H	169	31.3	3.9

ANTENNA POLARITY & TEST DISTANCE: VERTICAL AT 3 M								
NO.	FREQ. (MHz)	EMISSION LEVEL (dBuV/m)	LIMIT (dBuV/m)	MARGIN (dB)	ANTENNA HEIGHT (m)	TABLE ANGLE (Degree)	RAW VALUE (dBuV)	CORRECTION FACTOR (dB/m)
1	2390.00	66.6 PK	74.0	-7.4	1.73 V	214	33.7	32.9
2	2390.00	53.7 AV	54.0	-0.3	1.73 V	214	20.8	32.9
3	*2422.00	109.0 PK			1.73 V	209	76.2	32.8
4	*2422.00	99.2 AV			1.73 V	209	66.4	32.8
5	4844.00	50.6 PK	74.0	-23.4	2.46 V	51	46.7	3.9
6	4844.00	40.8 AV	54.0	-13.2	2.46 V	51	36.9	3.9

Remarks:

1. Emission Level(dBuV/m) = Raw Value(dBuV) + Correction Factor(dB/m).
2. Correction Factor(dB/m) = Antenna Factor(dB/m) + Cable Factor(dB) – Pre-Amplifier Factor(dB).
3. Margin value = Emission Level – Limit value.
4. The other emission levels were very low against the limit.
5. " * ": Fundamental frequency.

CHANNEL	TX Channel 6	DETECTOR FUNCTION	Peak (PK) Average (AV)
FREQUENCY RANGE	1GHz ~ 25GHz		

ANTENNA POLARITY & TEST DISTANCE: HORIZONTAL AT 3 M

NO.	FREQ. (MHz)	EMISSION LEVEL (dBuV/m)	LIMIT (dBuV/m)	MARGIN (dB)	ANTENNA HEIGHT (m)	TABLE ANGLE (Degree)	RAW VALUE (dBuV)	CORRECTION FACTOR (dB/m)
1	*2437.00	101.0 PK			1.88 H	298	68.1	32.9
2	*2437.00	90.8 AV			1.88 H	298	57.9	32.9
3	2483.50	65.3 PK	74.0	-8.7	1.91 H	299	32.3	33.0
4	2483.50	48.6 AV	54.0	-5.4	1.91 H	299	15.6	33.0
5	4874.00	48.3 PK	74.0	-25.7	1.80 H	173	44.3	4.0
6	4874.00	35.5 AV	54.0	-18.5	1.80 H	173	31.5	4.0

ANTENNA POLARITY & TEST DISTANCE: VERTICAL AT 3 M

NO.	FREQ. (MHz)	EMISSION LEVEL (dBuV/m)	LIMIT (dBuV/m)	MARGIN (dB)	ANTENNA HEIGHT (m)	TABLE ANGLE (Degree)	RAW VALUE (dBuV)	CORRECTION FACTOR (dB/m)
1	*2437.00	112.4 PK			1.77 V	191	79.5	32.9
2	*2437.00	102.1 AV			1.77 V	191	69.2	32.9
3	2483.50	68.6 PK	74.0	-5.4	1.76 V	196	35.6	33.0
4	2483.50	53.8 AV	54.0	-0.2	1.76 V	196	20.8	33.0
5	4874.00	51.1 PK	74.0	-22.9	2.29 V	56	47.1	4.0
6	4874.00	41.5 AV	54.0	-12.5	2.29 V	56	37.5	4.0

Remarks:

1. Emission Level(dBuV/m) = Raw Value(dBuV) + Correction Factor(dB/m).
2. Correction Factor(dB/m) = Antenna Factor(dB/m) + Cable Factor(dB) – Pre-Amplifier Factor(dB).
3. Margin value = Emission Level – Limit value.
4. The other emission levels were very low against the limit.
5. " * ": Fundamental frequency.

CHANNEL	TX Channel 9	DETECTOR FUNCTION	Peak (PK) Average (AV)
FREQUENCY RANGE	1GHz ~ 25GHz		

ANTENNA POLARITY & TEST DISTANCE: HORIZONTAL AT 3 M

NO.	FREQ. (MHz)	EMISSION LEVEL (dBuV/m)	LIMIT (dBuV/m)	MARGIN (dB)	ANTENNA HEIGHT (m)	TABLE ANGLE (Degree)	RAW VALUE (dBuV)	CORRECTION FACTOR (dB/m)
1	*2452.00	96.8 PK			2.05 H	293	63.9	32.9
2	*2452.00	86.9 AV			2.05 H	293	54.0	32.9
3	2483.50	62.9 PK	74.0	-11.1	1.89 H	309	29.9	33.0
4	2483.50	48.2 AV	54.0	-5.8	1.89 H	309	15.2	33.0
5	4904.00	47.1 PK	74.0	-26.9	1.76 H	169	43.1	4.0
6	4904.00	33.7 AV	54.0	-20.3	1.76 H	169	29.7	4.0

ANTENNA POLARITY & TEST DISTANCE: VERTICAL AT 3 M

NO.	FREQ. (MHz)	EMISSION LEVEL (dBuV/m)	LIMIT (dBuV/m)	MARGIN (dB)	ANTENNA HEIGHT (m)	TABLE ANGLE (Degree)	RAW VALUE (dBuV)	CORRECTION FACTOR (dB/m)
1	*2452.00	108.1 PK			1.63 V	202	75.2	32.9
2	*2452.00	98.3 AV			1.63 V	202	65.4	32.9
3	2483.50	66.2 PK	74.0	-7.8	1.82 V	214	33.2	33.0
4	2483.50	53.8 AV	54.0	-0.2	1.82 V	214	20.8	33.0
5	4904.00	49.5 PK	74.0	-24.5	2.31 V	43	45.5	4.0
6	4904.00	35.8 AV	54.0	-18.2	2.31 V	43	31.8	4.0

Remarks:

1. Emission Level(dBuV/m) = Raw Value(dBuV) + Correction Factor(dB/m).
2. Correction Factor(dB/m) = Antenna Factor(dB/m) + Cable Factor(dB) – Pre-Amplifier Factor(dB).
3. Margin value = Emission Level – Limit value.
4. The other emission levels were very low against the limit.
5. " * ": Fundamental frequency.

Below 1GHz worst-case data:

802.11b

CHANNEL	TX Channel 6	DETECTOR FUNCTION	Quasi-Peak (QP)
FREQUENCY RANGE	9kHz ~ 1GHz		

ANTENNA POLARITY & TEST DISTANCE: HORIZONTAL AT 3 M								
NO.	FREQ. (MHz)	EMISSION LEVEL (dBuV/m)	LIMIT (dBuV/m)	MARGIN (dB)	ANTENNA HEIGHT (m)	TABLE ANGLE (Degree)	RAW VALUE (dBuV)	CORRECTION FACTOR (dB/m)
1	66.84	28.0 QP	40.0	-12.0	1.99 H	223	39.1	-11.1
2	134.89	33.1 QP	43.5	-10.4	1.99 H	256	43.2	-10.1
3	171.83	35.0 QP	43.5	-8.5	1.99 H	96	44.5	-9.5
4	249.60	38.8 QP	46.0	-7.2	1.00 H	100	47.9	-9.1
5	339.04	32.0 QP	46.0	-14.0	1.00 H	159	38.8	-6.8
6	500.42	32.0 QP	46.0	-14.0	1.99 H	42	35.6	-3.6

Remarks:

1. Emission Level(dBuV/m) = Raw Value(dBuV) + Correction Factor(dB/m).
2. Correction Factor(dB/m) = Antenna Factor(dB/m) + Cable Factor(dB) – Pre-Amplifier Factor(dB).
3. The other emission levels were very low against the limit of frequency range 30MHz ~ 1000MHz.
4. Margin value = Emission Level – Limit value.
5. The emission levels were very low against the limit of frequency range 9kHz ~ 30MHz: the amplitude of spurious emissions attenuated more than 20 dB below the permissible value to be report.

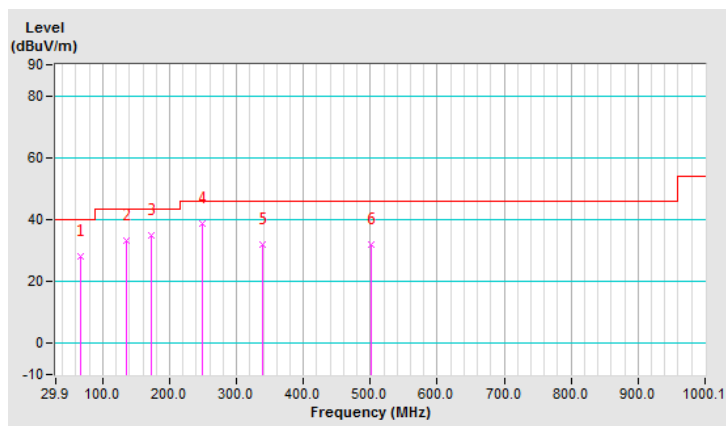

CHANNEL	TX Channel 6	DETECTOR FUNCTION	Quasi-Peak (QP)
FREQUENCY RANGE	9kHz ~ 1GHz		

ANTENNA POLARITY & TEST DISTANCE: VERTICAL AT 3 M								
NO.	FREQ. (MHz)	EMISSION LEVEL (dBuV/m)	LIMIT (dBuV/m)	MARGIN (dB)	ANTENNA HEIGHT (m)	TABLE ANGLE (Degree)	RAW VALUE (dBuV)	CORRECTION FACTOR (dB/m)
1	49.71	34.8 QP	40.0	-5.2	1.00 V	0	44.5	-9.7
2	68.79	36.5 QP	40.0	-3.5	1.00 V	340	48.3	-11.8
3	125.17	35.8 QP	43.5	-7.7	1.00 V	16	46.8	-11.0
4	249.60	33.2 QP	46.0	-12.8	1.50 V	185	42.3	-9.1
5	329.32	30.5 QP	46.0	-15.5	1.00 V	203	37.2	-6.7
6	500.42	31.4 QP	46.0	-14.6	1.00 V	299	35.0	-3.6

Remarks:

1. Emission Level(dBuV/m) = Raw Value(dBuV) + Correction Factor(dB/m).
2. Correction Factor(dB/m) = Antenna Factor(dB/m) + Cable Factor(dB) – Pre-Amplifier Factor(dB).
3. The other emission levels were very low against the limit of frequency range 30MHz ~ 1000MHz.
4. Margin value = Emission Level – Limit value.
5. The emission levels were very low against the limit of frequency range 9kHz ~ 30MHz: the amplitude of spurious emissions attenuated more than 20 dB below the permissible value to be report.

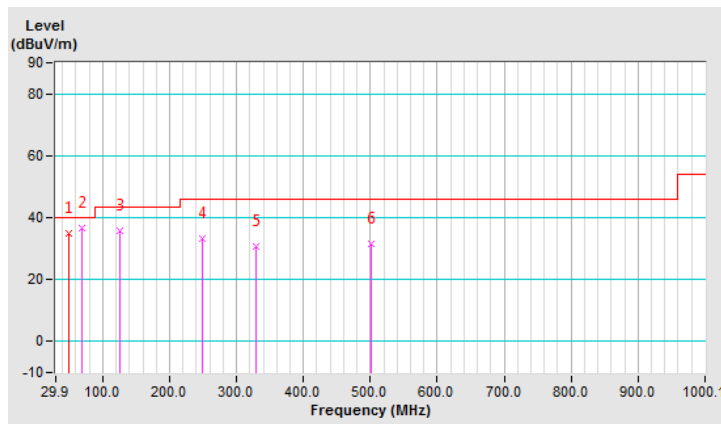

4.2 Conducted Emission Measurement

4.2.1 Limits of Conducted Emission Measurement

Frequency (MHz)	Conducted Limit (dBuV)	
	Quasi-peak	Average
0.15 - 0.5	66 - 56	56 - 46
0.50 - 5.0	56	46
5.0 - 30.0	60	50

Note: 1. The lower limit shall apply at the transition frequencies.
 2. The limit decreases in line with the logarithm of the frequency in the range of 0.15 to 0.50MHz.

4.2.2 Test Instruments

Description & Manufacturer	Model No.	Serial No.	Cal. Date	Cal. Due
Test Receiver ROHDE & SCHWARZ	ESCI	100613	Dec. 10, 2018	Dec. 09, 2019
RF signal cable Woken	5D-FB	Cable-cond1-01	Sep. 05, 2018	Sep. 04, 2019
LISN ROHDE & SCHWARZ (EUT)	ENV216	101826	Feb. 21, 2019	Feb. 20, 2020
LISN ROHDE & SCHWARZ (Peripheral)	ESH3-Z5	100311	Aug. 19, 2018	Aug. 18, 2019
Software ADT	BV ADT_Cond_ V7.3.7.4	NA	NA	NA

Note: 1. The calibration interval of the above test instruments is 12 months and the calibrations are traceable to NML/ROC and NIST/USA.
 2. The test was performed in HwaYa Shielded Room 1.
 3. The VCCI Site Registration No. is C-12040.

4.2.3 Test Procedures

- The EUT was placed 0.4 meters from the conducting wall of the shielded room with EUT being connected to the power mains through a line impedance stabilization network (LISN). Other support units were connected to the power mains through another LISN. The two LISNs provide 50 ohm/ 50uH of coupling impedance for the measuring instrument.
- Both lines of the power mains connected to the EUT were checked for maximum conducted interference.
- The frequency range from 150kHz to 30MHz was searched. Emission levels under (Limit - 20dB) was not recorded.

Note: The resolution bandwidth and video bandwidth of test receiver is 9kHz for quasi-peak detection (QP) and average detection (AV) at frequency 0.15MHz-30MHz.

4.2.4 Deviation from Test Standard

No deviation.

4.2.5 Test Setup

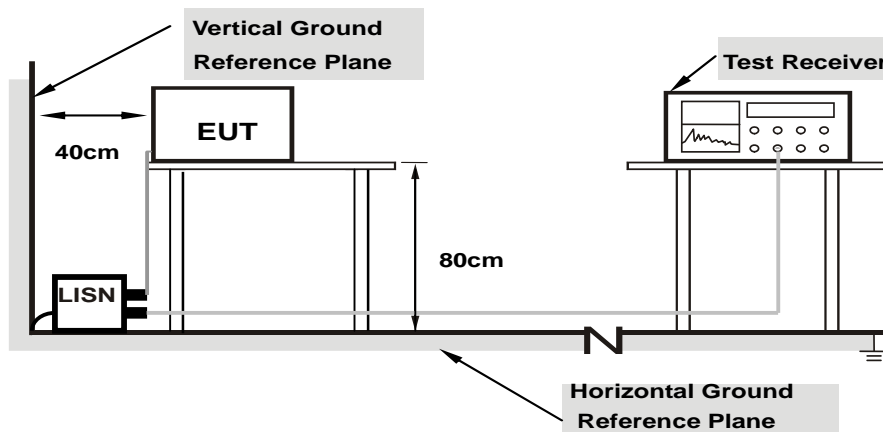

Note: 1.Support units were connected to second LISN.

For the actual test configuration, please refer to the attached file (Test Setup Photo).

4.2.6 EUT Operating Conditions

Same as 4.1.6.

4.2.7 Test Results

Worst-case data:

802.11b

Phase	Line (L)	Detector Function	Quasi-Peak (QP) / Average (AV)
-------	----------	-------------------	--------------------------------

No	Freq. [MHz]	Corr. Factor (dB)	Reading Value [dB (uV)]		Emission Level [dB (uV)]		Limit [dB (uV)]		Margin (dB)	
			Q.P.	AV.	Q.P.	AV.	Q.P.	AV.	Q.P.	AV.
			1	0.15782	9.69	42.38	25.91	52.07	35.60	65.58
2	0.29858	9.68	30.27	15.16	39.95	24.84	60.28	50.28	-20.33	-25.44
3	0.49408	9.68	30.45	19.00	40.13	28.68	56.10	46.10	-15.97	-17.42
4	0.94373	9.67	19.70	7.38	29.37	17.05	56.00	46.00	-26.63	-28.95
5	1.30345	9.68	16.19	6.47	25.87	16.15	56.00	46.00	-30.13	-29.85
6	3.96225	9.75	15.78	1.36	25.53	11.11	56.00	46.00	-30.47	-34.89

Remarks:

1. Q.P. and AV. are abbreviations of quasi-peak and average individually.
2. The emission levels of other frequencies were very low against the limit.
3. Margin value = Emission level - Limit value
4. Correction factor = Insertion loss + Cable loss
5. Emission Level = Correction Factor + Reading Value.

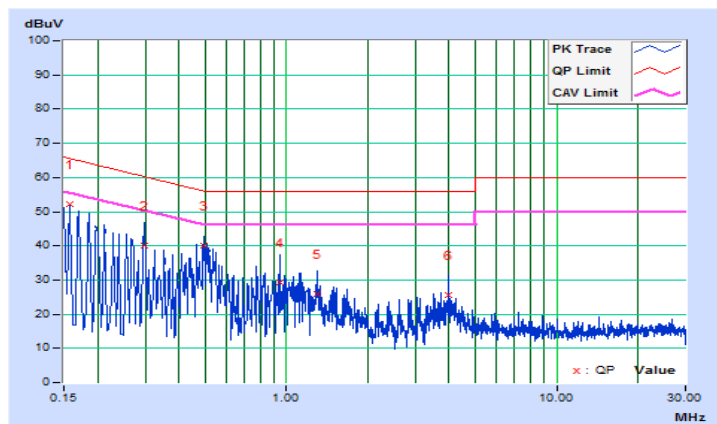

Phase	Neutral (N)	Detector Function	Quasi-Peak (QP) / Average (AV)
-------	-------------	-------------------	--------------------------------

No	Freq. [MHz]	Corr. Factor (dB)	Reading Value [dB (uV)]		Emission Level [dB (uV)]		Limit [dB (uV)]		Margin (dB)	
			Q.P.	AV.	Q.P.	AV.	Q.P.	AV.	Q.P.	AV.
			1	0.15760	9.66	43.08	25.64	52.74	35.30	65.59
2	0.21256	9.66	34.21	18.80	43.87	28.46	63.10	53.10	-19.23	-24.64
3	0.29858	9.66	29.07	13.44	38.73	23.10	60.28	50.28	-21.55	-27.18
4	0.50581	9.65	24.90	13.73	34.55	23.38	56.00	46.00	-21.45	-22.62
5	0.98674	9.64	14.88	2.80	24.52	12.44	56.00	46.00	-31.48	-33.56
6	4.06000	9.72	12.27	2.55	21.99	12.27	56.00	46.00	-34.01	-33.73

Remarks:

1. Q.P. and AV. are abbreviations of quasi-peak and average individually.
2. The emission levels of other frequencies were very low against the limit.
3. Margin value = Emission level - Limit value
4. Correction factor = Insertion loss + Cable loss
5. Emission Level = Correction Factor + Reading Value.

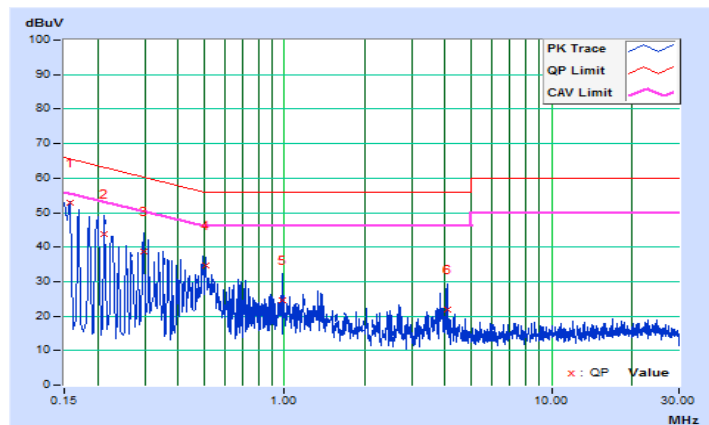

4.3 6dB Bandwidth Measurement

4.3.1 Limits of 6dB Bandwidth Measurement

The minimum of 6dB Bandwidth Measurement is 0.5 MHz.

4.3.2 Test Setup

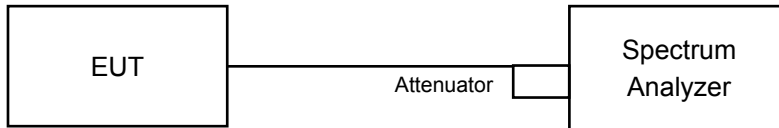

4.3.3 Test Instruments

Refer to section 4.1.2 to get information of above instrument.

4.3.4 Test Procedure

- Set resolution bandwidth (RBW) = 100kHz.
- Set the video bandwidth (VBW) $\geq 3 \times$ RBW, Detector = peak.
- Trace mode = max hold.
- Sweep = auto couple.
- Measure the maximum width of the emission that is constrained by the frequencies associated with the two amplitude points (upper and lower) that are attenuated by 6 dB relative to the maximum level measured in the fundamental emission.

4.3.5 Deviation from Test Standard

No deviation.

4.3.6 EUT Operating Conditions

The software provided by client to enable the EUT under transmission condition continuously at lowest, middle and highest channel frequencies individually.

4.3.7 Test Result

802.11b

Channel	Frequency (MHz)	6dB Bandwidth (MHz)			Minimum Limit (MHz)	Pass / Fail
		Chain 0	Chain 1	Chain 2		
1	2412	9.14	10.08	9.10	0.5	Pass
6	2437	9.12	12.06	9.15	0.5	Pass
11	2462	9.14	10.11	9.11	0.5	Pass

802.11g

Channel	Frequency (MHz)	6dB Bandwidth (MHz)			Minimum Limit (MHz)	Pass / Fail
		Chain 0	Chain 1	Chain 2		
1	2412	15.18	15.18	15.18	0.5	Pass
6	2437	15.19	15.76	15.17	0.5	Pass
11	2462	15.20	15.20	15.19	0.5	Pass

802.11n (HT20)

Channel	Frequency (MHz)	6dB Bandwidth (MHz)			Minimum Limit (MHz)	Pass / Fail
		Chain 0	Chain 1	Chain 2		
1	2412	15.17	15.74	15.17	0.5	Pass
6	2437	15.20	15.75	15.17	0.5	Pass
11	2462	15.18	15.76	15.74	0.5	Pass

802.11n (HT40)

Channel	Frequency (MHz)	6dB Bandwidth (MHz)			Minimum Limit (MHz)	Pass / Fail
		Chain 0	Chain 1	Chain 2		
3	2422	35.28	35.30	35.27	0.5	Pass
6	2437	35.28	35.28	35.25	0.5	Pass
9	2452	35.26	35.27	35.26	0.5	Pass

Spectrum Plot of Worst Value

802.11b

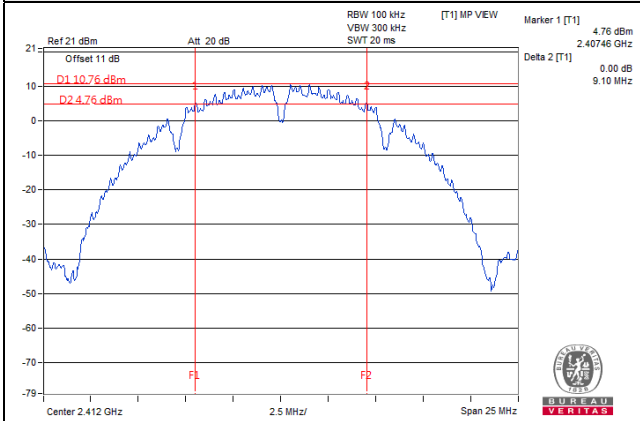

802.11g

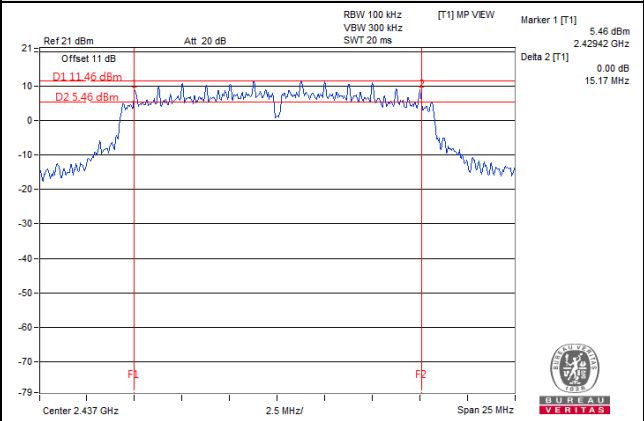

802.11n (HT20)

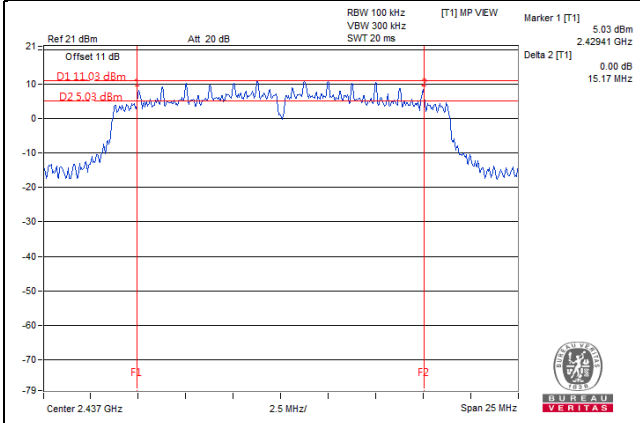

802.11n (HT40)

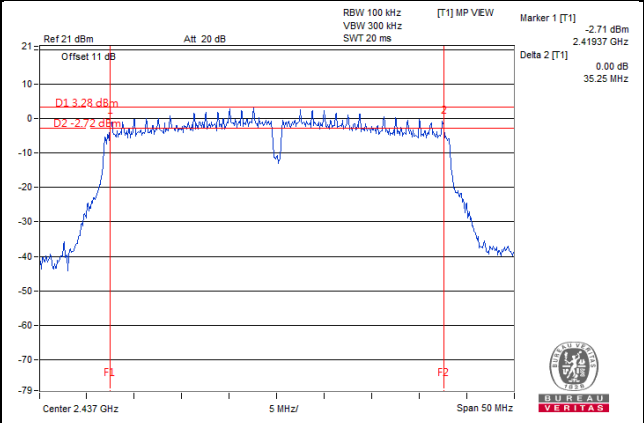

4.4 Conducted Output Power Measurement

4.4.1 Limits of Conducted Output Power Measurement

For systems using digital modulation in the 2400–2483.5 MHz bands: 1 Watt (30dBm)

Per KDB 662911 D01 Multiple Transmitter Output Method of conducted output power measurement on IEEE 802.11 devices,

Array Gain = 0 dB (i.e., no array gain) for $N_{ANT} \leq 4$;

Array Gain = 0 dB (i.e., no array gain) for channel widths ≥ 40 MHz for any N_{ANT} ;

Array Gain = $5 \log(N_{ANT}/N_{SS})$ dB or 3 dB, whichever is less for 20-MHz channel widths with $N_{ANT} \geq 5$.

For power measurements on all other devices: Array Gain = $10 \log(N_{ANT}/N_{SS})$ dB.

4.4.2 Test Setup

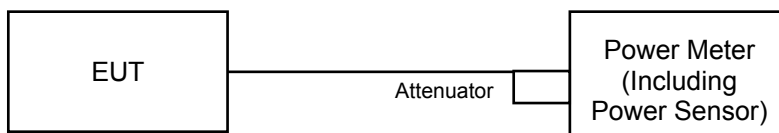

4.4.3 Test Instruments

Refer to section 4.1.2 to get information of above instrument.

4.4.4 Test Procedures

Average power sensor was used to perform output power measurement, trigger and gating function of wide band power meter is enabled to measure max output power of TX on burst. Duty factor is not added to measured value.

4.4.5 Deviation from Test Standard

No deviation.

4.4.6 EUT Operating Conditions

Same as item 4.3.6.

4.4.7 Test Results

CDD Mode

802.11b

Channel	Frequency (MHz)	Average Power (dBm)			Total Power (mW)	Total Power (dBm)	Limit (dBm)	Pass / Fail
		Chain 0	Chain 1	Chain 2				
1	2412	21.55	22.14	22.01	465.426	26.68	30.00	Pass
6	2437	23.85	24.55	24.66	820.178	29.14	30.00	Pass
11	2462	20.91	20.92	21.93	402.860	26.05	30.00	Pass

802.11g

Channel	Frequency (MHz)	Average Power (dBm)			Total Power (mW)	Total Power (dBm)	Limit (dBm)	Pass / Fail
		Chain 0	Chain 1	Chain 2				
1	2412	17.55	18.12	17.85	182.702	22.62	30.00	Pass
6	2437	22.77	23.37	23.41	625.784	27.96	30.00	Pass
11	2462	16.31	16.35	17.22	138.631	21.42	30.00	Pass

802.11n (HT20)

Channel	Frequency (MHz)	Average Power (dBm)			Total Power (mW)	Total Power (dBm)	Limit (dBm)	Pass / Fail
		Chain 0	Chain 1	Chain 2				
1	2412	17.58	18.13	17.91	184.095	22.65	30.00	Pass
6	2437	22.13	22.81	23.07	557.058	27.46	30.00	Pass
11	2462	15.66	15.88	16.88	124.292	20.94	30.00	Pass

802.11n (HT40)

Channel	Frequency (MHz)	Average Power (dBm)			Total Power (mW)	Total Power (dBm)	Limit (dBm)	Pass / Fail
		Chain 0	Chain 1	Chain 2				
3	2422	11.55	12.61	12.09	48.709	16.88	30.00	Pass
6	2437	15.10	15.76	15.97	109.566	20.40	30.00	Pass
9	2452	11.23	11.85	11.31	42.106	16.24	30.00	Pass

Beamforming Mode

802.11n (HT20)

Channel	Frequency (MHz)	Average Power (dBm)			Total Power (mW)	Total Power (dBm)	Limit (dBm)	Pass / Fail
		Chain 0	Chain 1	Chain 2				
1	2412	17.58	18.13	17.91	184.095	22.65	27.23	Pass
6	2437	21.73	22.32	22.64	503.198	27.02	27.23	Pass
11	2462	15.66	15.88	16.88	124.292	20.94	27.23	Pass

Note: Directional gain = $4\text{dBi} + 10\log(3) = 8.77\text{dBi} > 6\text{dBi}$, so the power limit shall be reduced to $30 - (8.77 - 6) = 27.23\text{dBm}$.

802.11n (HT40)

Channel	Frequency (MHz)	Average Power (dBm)			Total Power (mW)	Total Power (dBm)	Limit (dBm)	Pass / Fail
		Chain 0	Chain 1	Chain 2				
3	2422	11.55	12.61	12.09	48.709	16.88	27.23	Pass
6	2437	15.10	15.76	15.97	109.566	20.40	27.23	Pass
9	2452	11.23	11.85	11.31	42.106	16.24	27.23	Pass

Note: Directional gain = $4\text{dBi} + 10\log(3) = 8.77\text{dBi} > 6\text{dBi}$, so the power limit shall be reduced to $30 - (8.77 - 6) = 27.23\text{dBm}$.

4.5 Power Spectral Density Measurement

4.5.1 Limits of Power Spectral Density Measurement

The Maximum of Power Spectral Density Measurement is 8dBm per 3kHz.

4.5.2 Test Setup

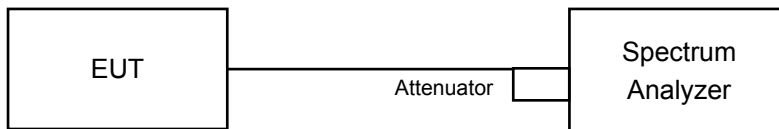

4.5.3 Test Instruments

Refer to section 4.1.2 to get information of above instrument.

4.5.4 Test Procedure

- a. Measure the duty cycle (x).
- b. Set instrument center frequency to DTS channel center frequency.
- c. Set span to at least 1.5 times the OBW.
- d. Set RBW to: $3 \text{ kHz} \leq \text{RBW} \leq 100 \text{ kHz}$.
- e. Set VBW $\geq 3 \times \text{RBW}$.
- f. Detector = power averaging (RMS) or sample detector (when RMS not available).
- g. Ensure that the number of measurement points in the sweep $\geq 2 \times \text{span}/\text{RBW}$.
- h. Sweep time = auto couple.
- i. Do not use sweep triggering. Allow sweep to "free run".
- j. Employ trace averaging (RMS) mode over a minimum of 100 traces.
- k. Use the peak marker function to determine the maximum amplitude level.
- l. Add $10 \log (1/x)$, where x is the duty cycle measured in step (a), to the measured PSD to compute the average PSD during the actual transmission time.

4.5.5 Deviation from Test Standard

No deviation.

4.5.6 EUT Operating Condition

Same as item 4.3.6

4.5.7 Test Results

802.11b

TX chain	Channel	Frequency (MHz)	PSD w/o Duty Factor (dBm/10kHz)	10 log (N=3) dB	Duty Factor (dB)	Total PSD With Duty Factor (dBm/10kHz)	Limit (dBm/3kHz)	Pass / Fail
0	1	2412	-4.75	4.77	0.11	0.13	5.23	Pass
	6	2437	-5.27	4.77	0.11	-0.39	5.23	Pass
	11	2462	-6.14	4.77	0.11	-1.26	5.23	Pass
1	1	2412	-2.58	4.77	0.11	2.30	5.23	Pass
	6	2437	-3.49	4.77	0.11	1.39	5.23	Pass
	11	2462	-4.25	4.77	0.11	0.63	5.23	Pass
2	1	2412	-8.79	4.77	0.11	-3.91	5.23	Pass
	6	2437	-4.68	4.77	0.11	0.20	5.23	Pass
	11	2462	-7.18	4.77	0.11	-2.30	5.23	Pass

Note:

- Method E) 2) c) of power density measurement of KDB 662911 is using for calculating total power density, Measure and add $10 \log(N_{ANT})$ dB.
- Directional gain = $4\text{dBi} + 10\log(3) = 8.77\text{dBi} < 6\text{dBi}$, so the power density limit shall be reduced to $8 - (8.77 - 6) = 5.23\text{dBm}$.
- Refer to section 3.3 for duty cycle spectrum plot.

802.11g

TX chain	Channel	Frequency (MHz)	PSD w/o Duty Factor (dBm/10kHz)	10 log (N=3) dB	Duty Factor (dB)	Total PSD With Duty Factor (dBm/10kHz)	Limit (dBm/3kHz)	Pass / Fail
0	1	2412	-12.34	4.77	0.64	-6.93	5.23	Pass
	6	2437	-12.82	4.77	0.64	-7.41	5.23	Pass
	11	2462	-15.52	4.77	0.64	-10.11	5.23	Pass
1	1	2412	-10.30	4.77	0.64	-4.89	5.23	Pass
	6	2437	-5.67	4.77	0.64	-0.26	5.23	Pass
	11	2462	-12.24	4.77	0.64	-6.83	5.23	Pass
2	1	2412	-12.29	4.77	0.64	-6.88	5.23	Pass
	6	2437	-7.79	4.77	0.64	-2.38	5.23	Pass
	11	2462	-13.79	4.77	0.64	-8.38	5.23	Pass

Note:

- Method E) 2) c) of power density measurement of KDB 662911 is using for calculating total power density, Measure and add $10 \log(N_{ANT})$ dB.
- Directional gain = $4\text{dBi} + 10\log(3) = 8.77\text{dBi} < 6\text{dBi}$, so the power density limit shall be reduced to $8 - (8.77 - 6) = 5.23\text{dBm}$.
- Refer to section 3.3 for duty cycle spectrum plot.

802.11n (HT20)

TX chain	Channel	Frequency (MHz)	PSD w/o Duty Factor (dBm/10kHz)	10 log (N=3) dB	Duty Factor (dB)	Total PSD With Duty Factor (dBm/10kHz)	Limit (dBm/3kHz)	Pass / Fail
0	1	2412	-13.47	4.77	0.25	-8.45	5.23	Pass
	6	2437	-8.86	4.77	0.25	-3.84	5.23	Pass
	11	2462	-15.08	4.77	0.25	-10.06	5.23	Pass
1	1	2412	-12.61	4.77	0.25	-7.59	5.23	Pass
	6	2437	-8.17	4.77	0.25	-3.15	5.23	Pass
	11	2462	-14.83	4.77	0.25	-9.81	5.23	Pass
2	1	2412	-12.19	4.77	0.25	-7.17	5.23	Pass
	6	2437	-7.94	4.77	0.25	-2.92	5.23	Pass
	11	2462	-13.97	4.77	0.25	-8.95	5.23	Pass

Note:

- Method E) 2) c) of power density measurement of KDB 662911 is using for calculating total power density, Measure and add $10 \log (N_{ANT})$ dB.
- Directional gain = $4\text{dBi} + 10\log(3) = 8.77\text{dBi} < 6\text{dBi}$, so the power density limit shall be reduced to $8 - (8.77 - 6) = 5.23\text{dBm}$.
- Refer to section 3.3 for duty cycle spectrum plot.

802.11n (HT40)

TX chain	Channel	Frequency (MHz)	PSD w/o Duty Factor (dBm/10kHz)	10 log (N=3) dB	Duty Factor (dB)	Total PSD With Duty Factor (dBm/10kHz)	Limit (dBm/3kHz)	Pass / Fail
0	3	2422	-21.19	4.77	0.45	-15.97	5.23	Pass
	6	2437	-17.59	4.77	0.45	-12.37	5.23	Pass
	9	2452	-21.96	4.77	0.45	-16.74	5.23	Pass
1	3	2422	-19.85	4.77	0.45	-14.63	5.23	Pass
	6	2437	-16.82	4.77	0.45	-11.60	5.23	Pass
	9	2452	-20.91	4.77	0.45	-15.69	5.23	Pass
2	3	2422	-20.85	4.77	0.45	-15.63	5.23	Pass
	6	2437	-16.34	4.77	0.45	-11.12	5.23	Pass
	9	2452	-20.87	4.77	0.45	-15.65	5.23	Pass

Note:

- Method E) 2) c) of power density measurement of KDB 662911 is using for calculating total power density, Measure and add $10 \log (N_{ANT})$ dB.
- Directional gain = $4\text{dBi} + 10\log(3) = 8.77\text{dBi} < 6\text{dBi}$, so the power density limit shall be reduced to $8 - (8.77 - 6) = 5.23\text{dBm}$.
- Refer to section 3.3 for duty cycle spectrum plot.

Spectrum Plot of Worst Value

802.11b

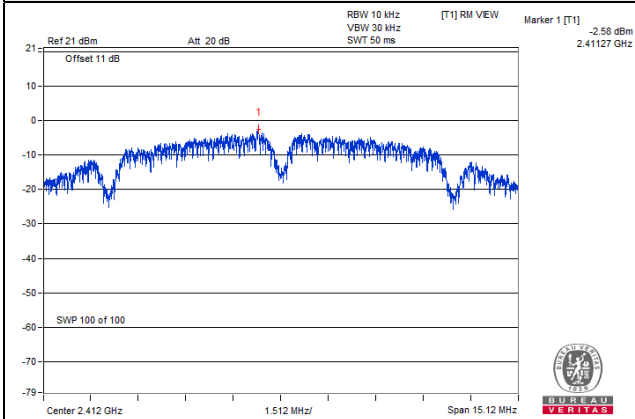

802.11g

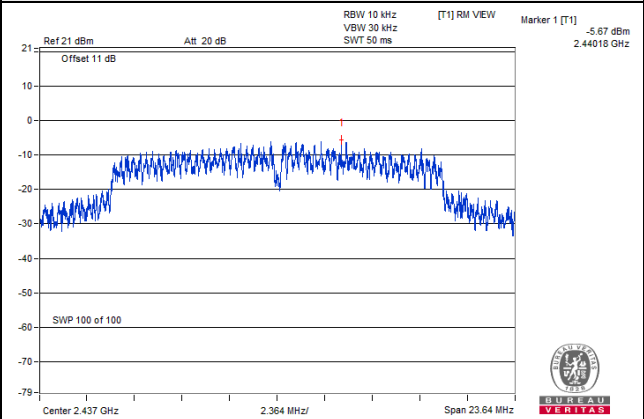

802.11n (HT20)

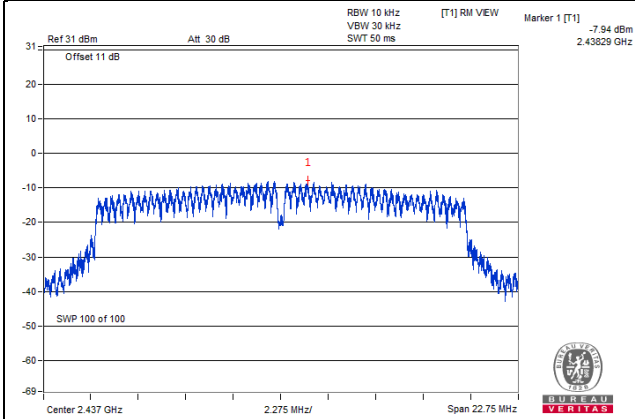

802.11n (HT40)

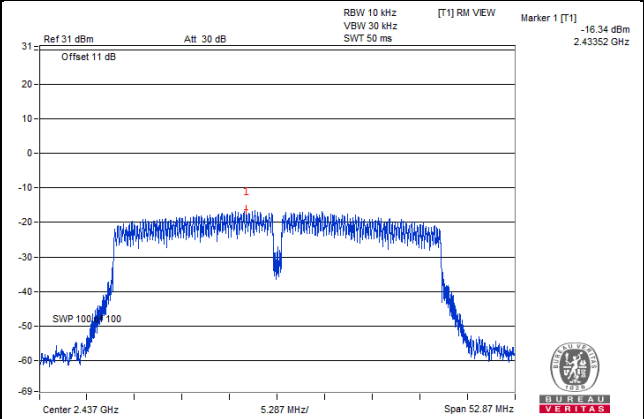

4.6 Conducted Out of Band Emission Measurement

4.6.1 Limits of Conducted Out of Band Emission Measurement

Below -30dB of the highest emission level of operating band (in 100kHz Resolution Bandwidth).

4.6.2 Test Setup

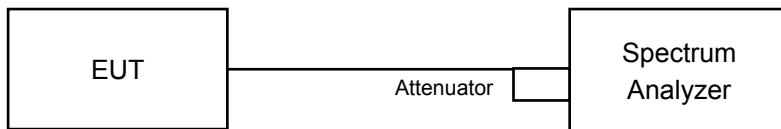

4.6.3 Test Instruments

Refer to section 4.1.2 to get information of above instrument.

4.6.4 Test Procedure

MEASUREMENT PROCEDURE REF

- Set the RBW = 100 kHz.
- Set the VBW \geq 300 kHz.
- Detector = peak.
- Sweep time = auto couple.
- Trace mode = max hold.
- Allow trace to fully stabilize.
- Use the peak marker function to determine the maximum power level in any 100 kHz band segment within the fundamental EBW.

MEASUREMENT PROCEDURE OOB

- Set RBW = 100 kHz.
- Set VBW \geq 300 kHz.
- Detector = peak.
- Sweep = auto couple.
- Trace Mode = max hold.
- Allow trace to fully stabilize.
- Use the peak marker function to determine the maximum amplitude level.

4.6.5 Deviation from Test Standard

No deviation.

4.6.6 EUT Operating Condition

Same as item 4.3.6

4.6.7 Test Results

The conducted emission test is performed on each TX port of operating mode without summing or adding 10log (N) since the limit is relative emission limit.

The spectrum plots are attached on the following pages. D1 line indicates the highest level, and D2 line indicates the 30dB offset below D1. It shows compliance with the requirement.

802.11b_Chain 0

CH 1

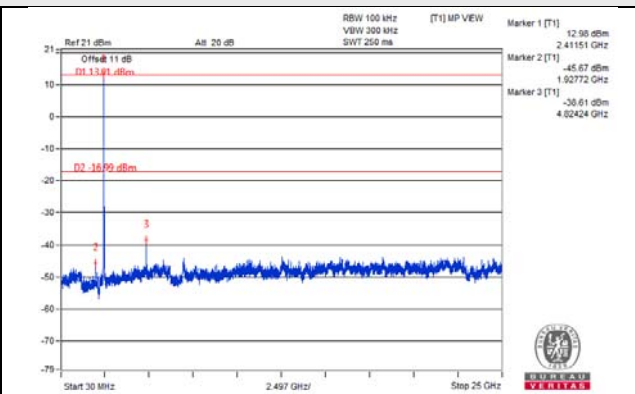
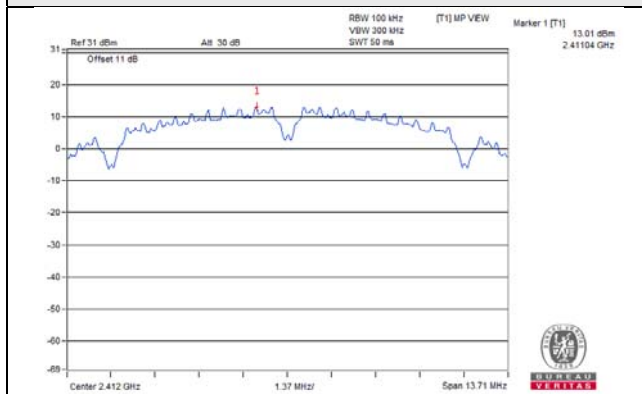

CH 6

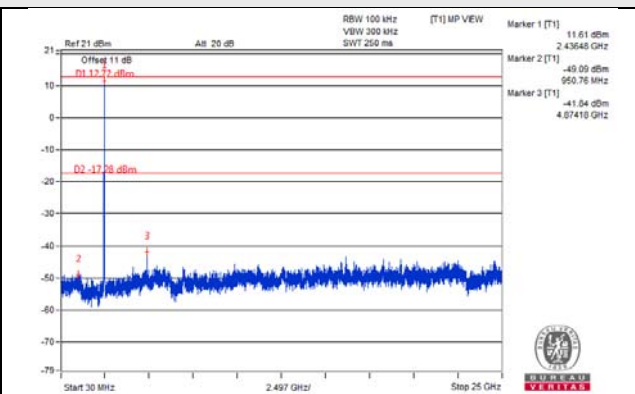
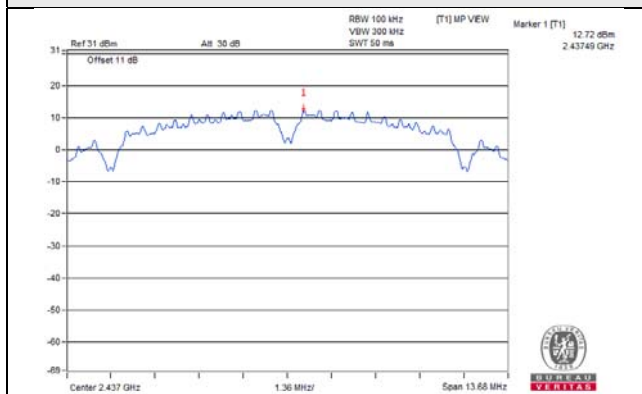

CH 11

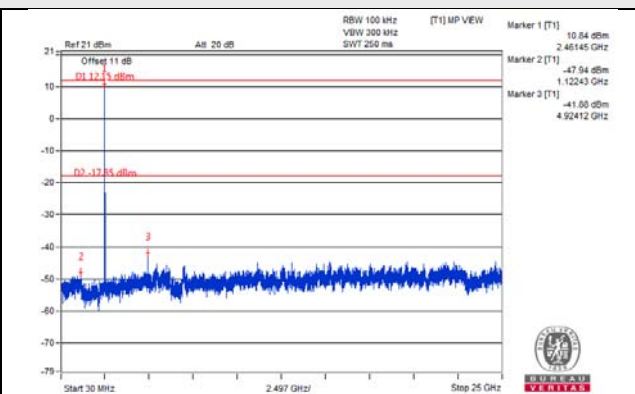
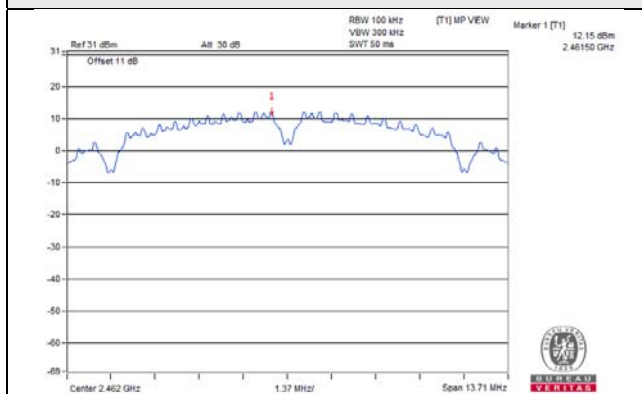

CH 1 Band edge

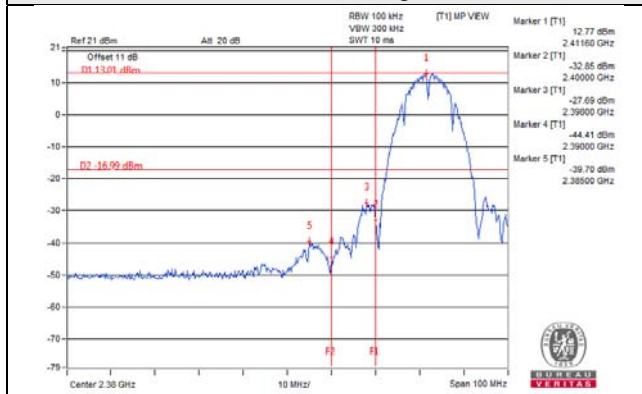

CH 11 Band edge

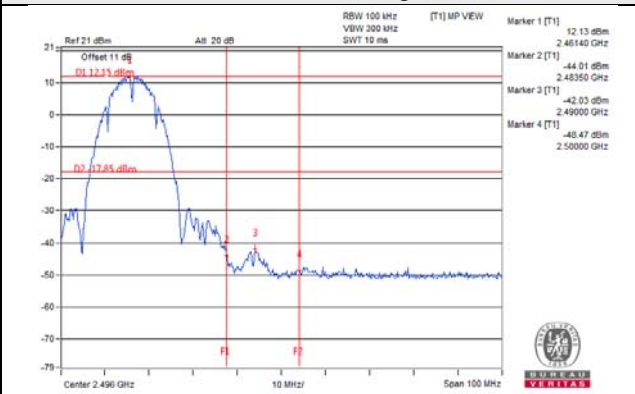

802.11b_Chain 1

CH 1

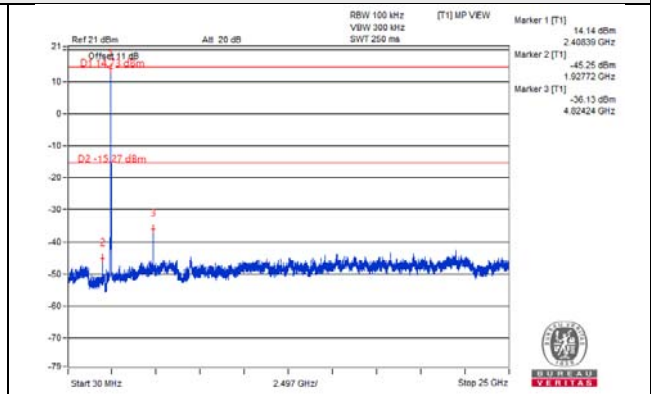
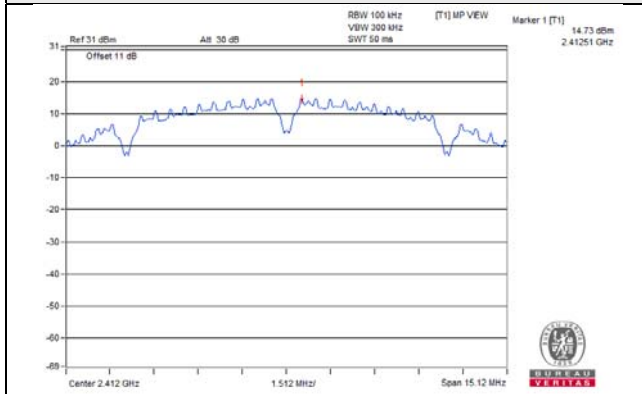

CH 6

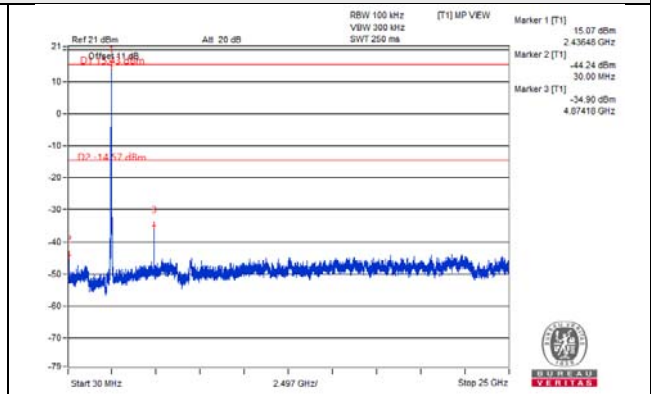
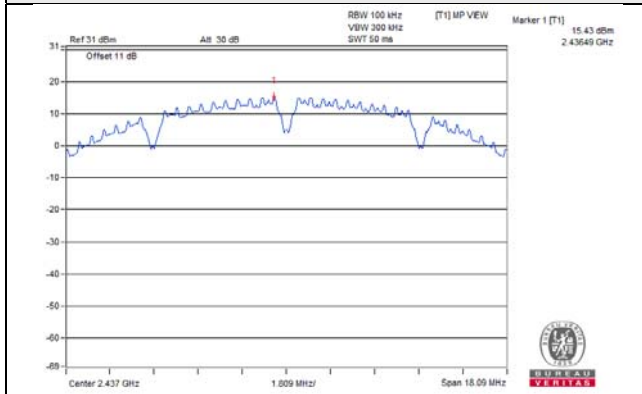

CH 11

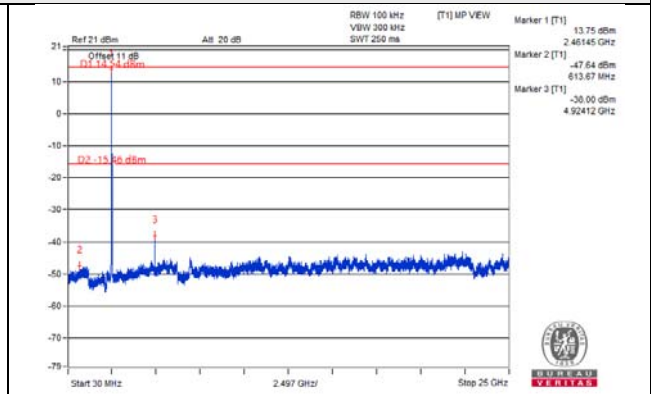
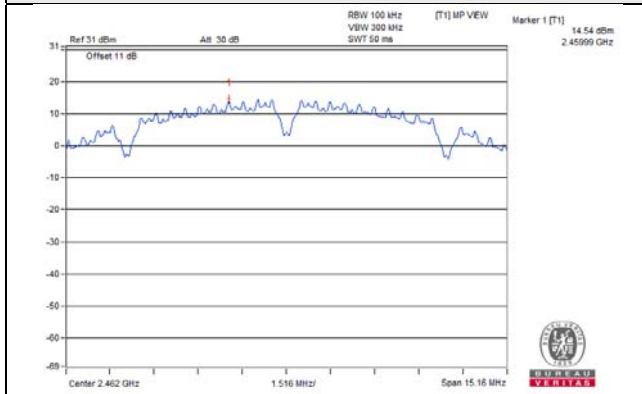

CH 1 Band edge

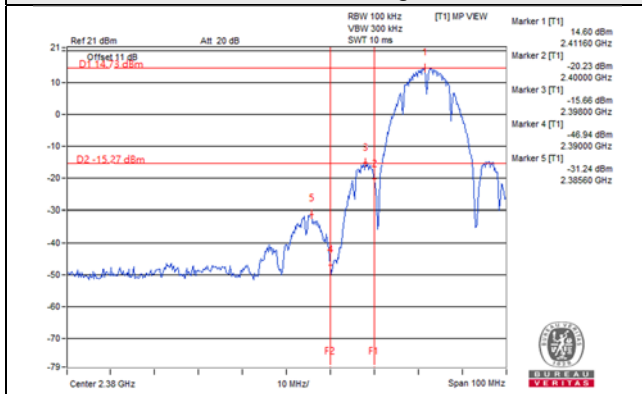

CH 11 Band edge

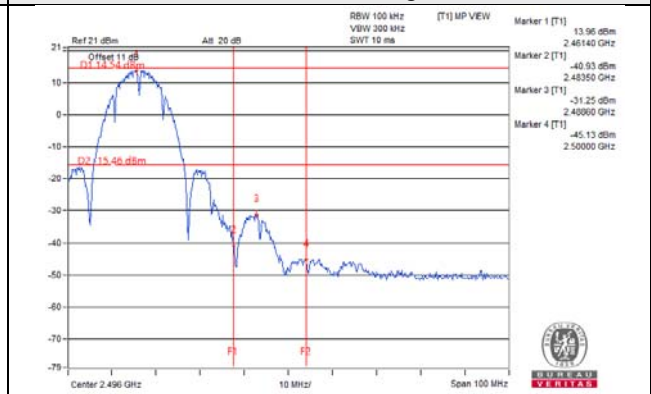

802.11b_Chain 2

CH 1

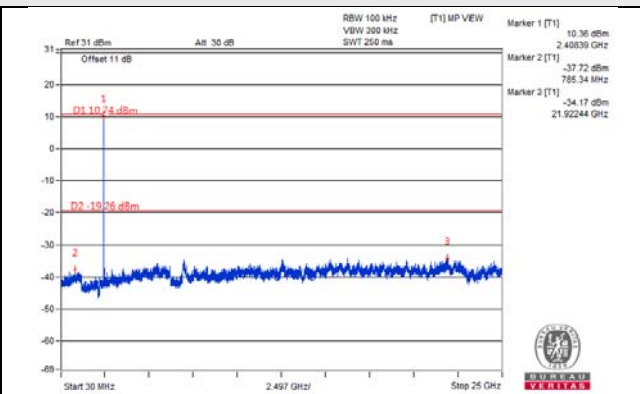
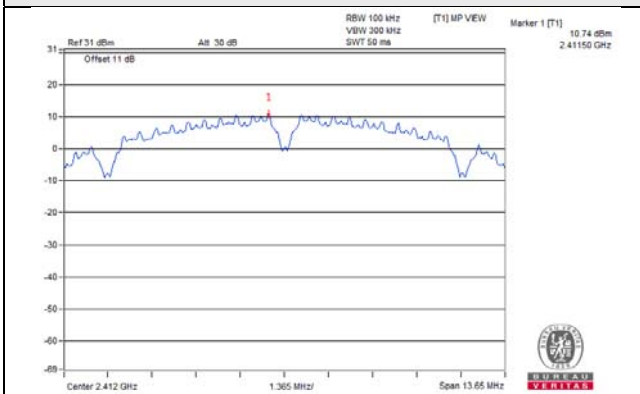

CH 6

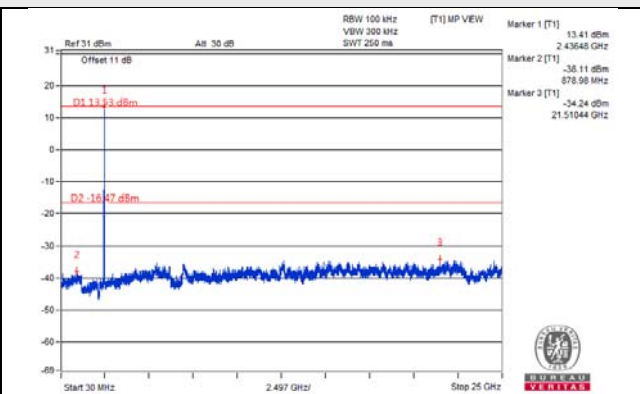
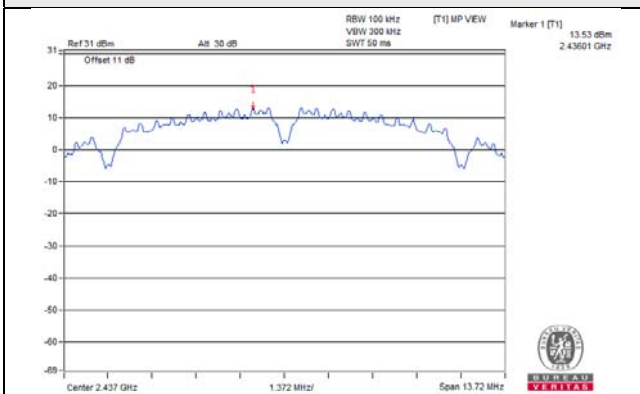

CH 11

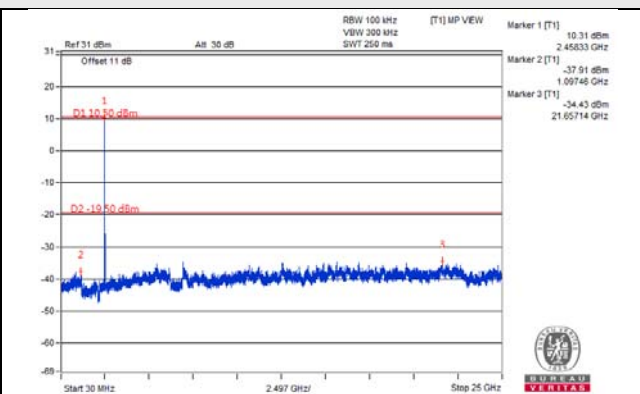
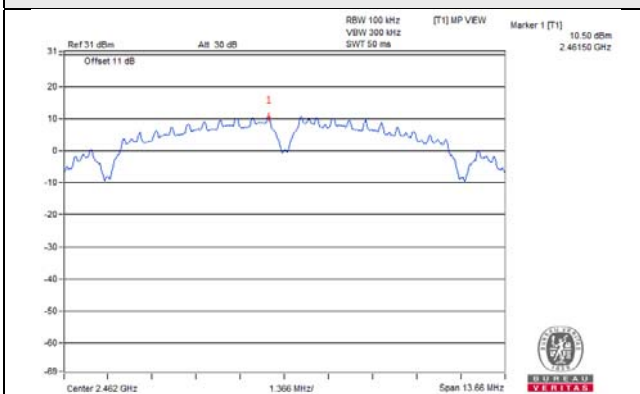

CH 1 Band edge

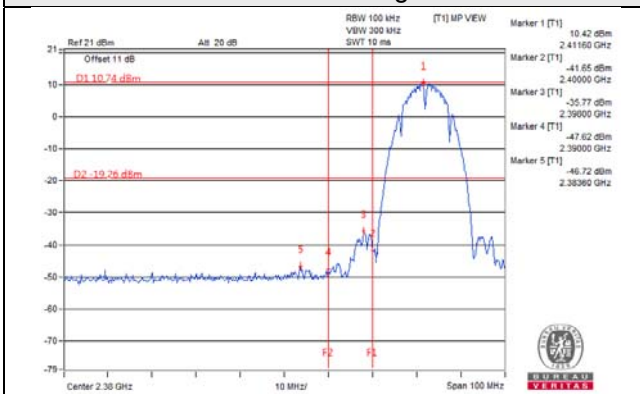

CH 11 Band edge

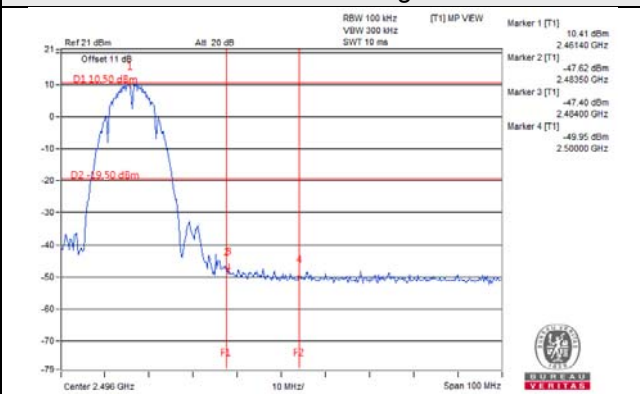

802.11g_Chain 0

CH 1

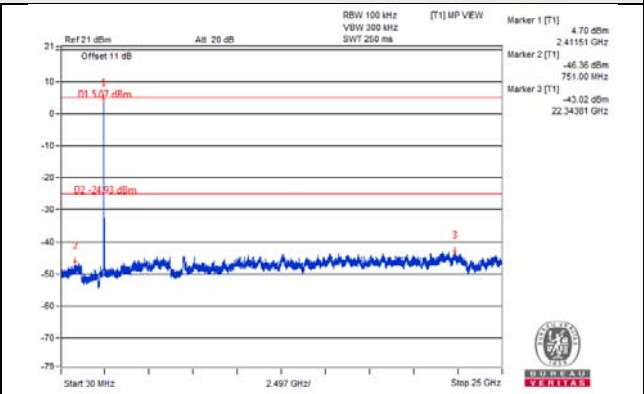
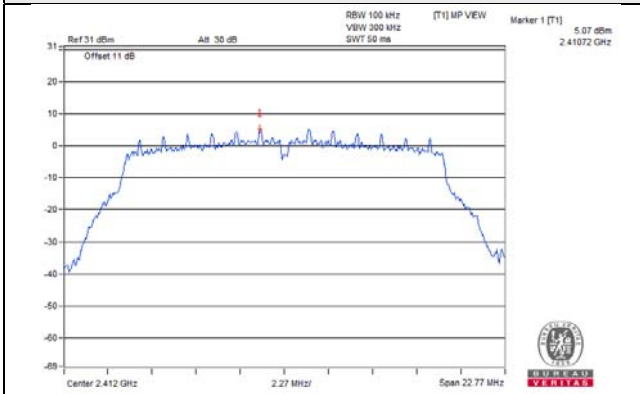

CH 6

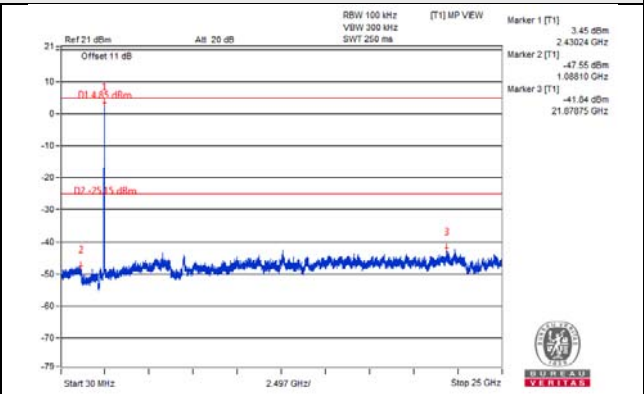
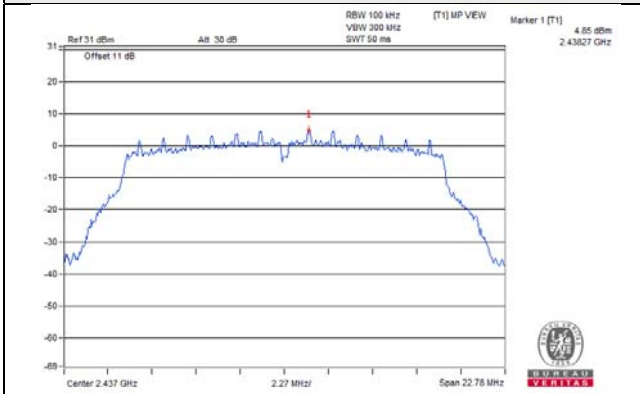

CH 11

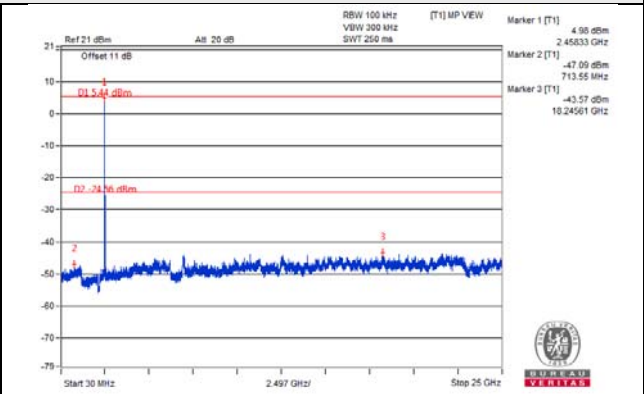
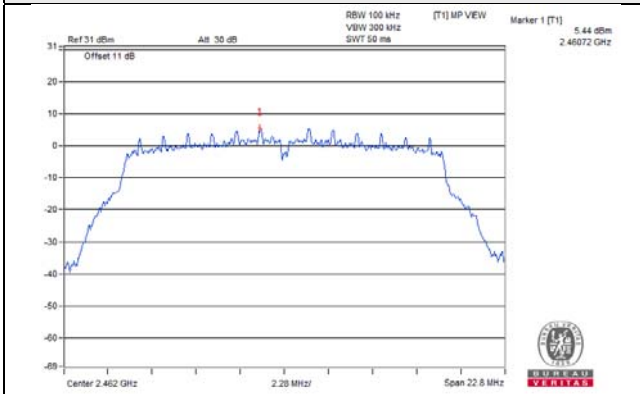

CH 1 Band edge

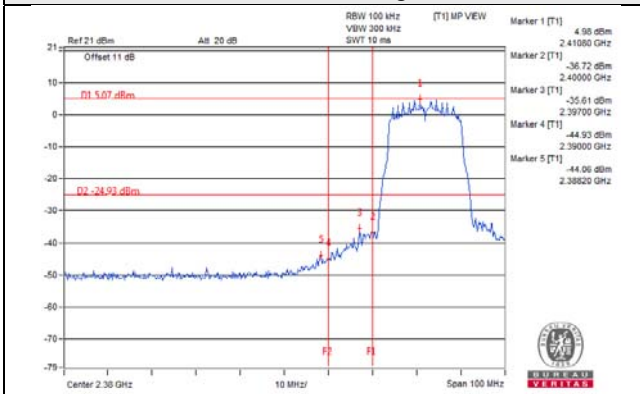

CH 11 Band edge

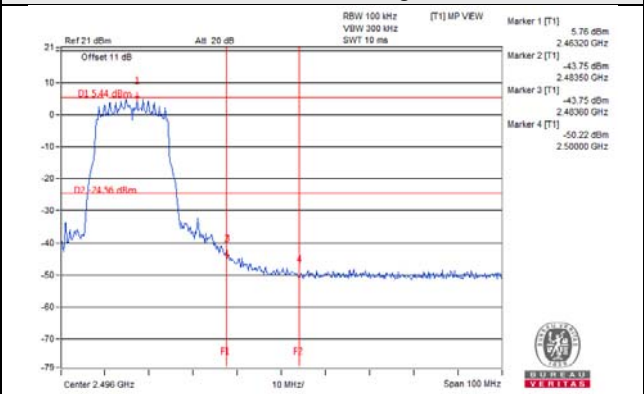

802.11g_Chain 1

CH 1

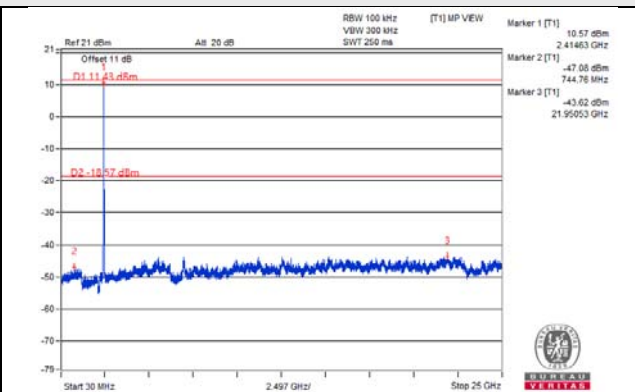
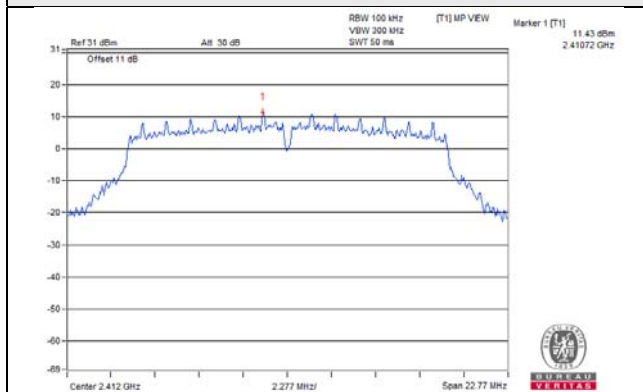

CH 6

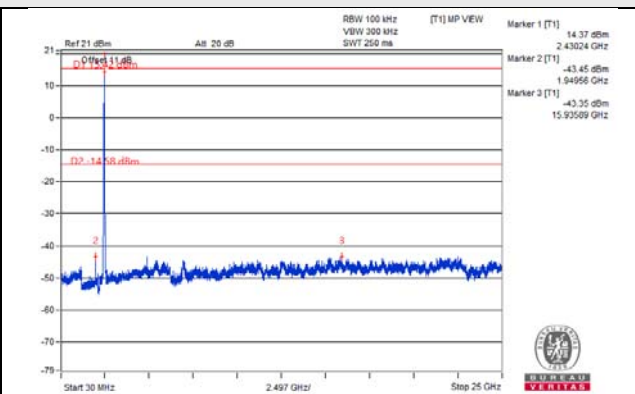
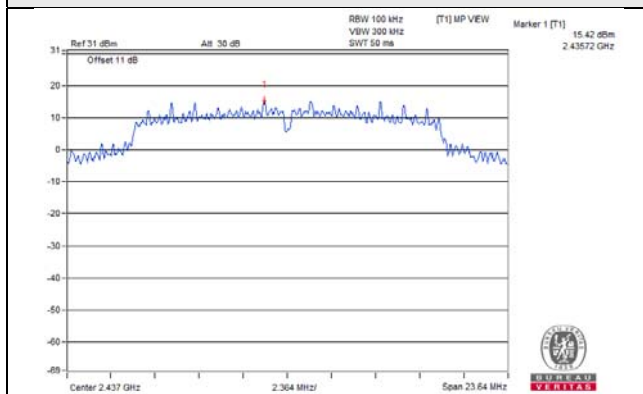

CH 11

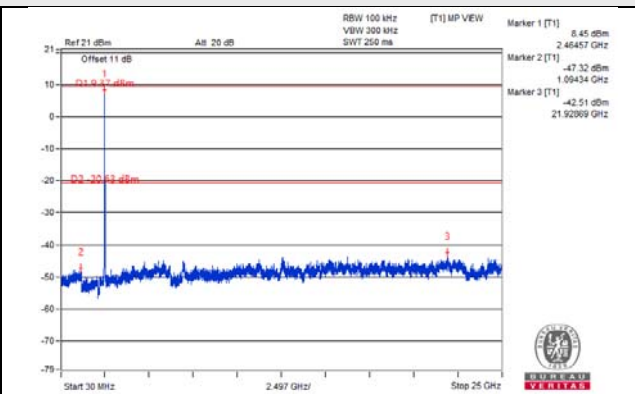
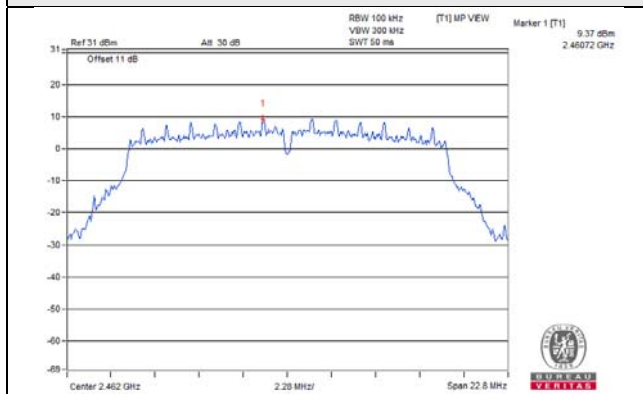

CH 1 Band edge

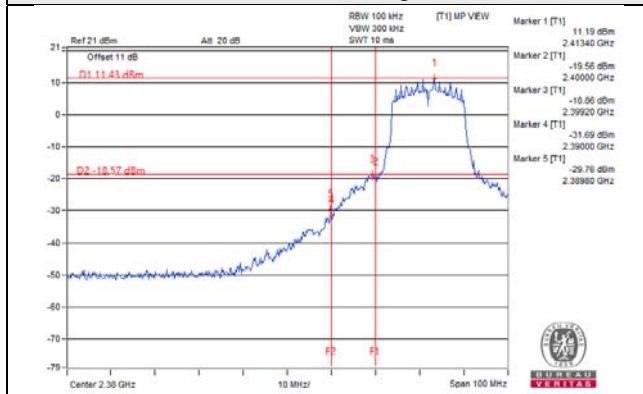

CH 11 Band edge

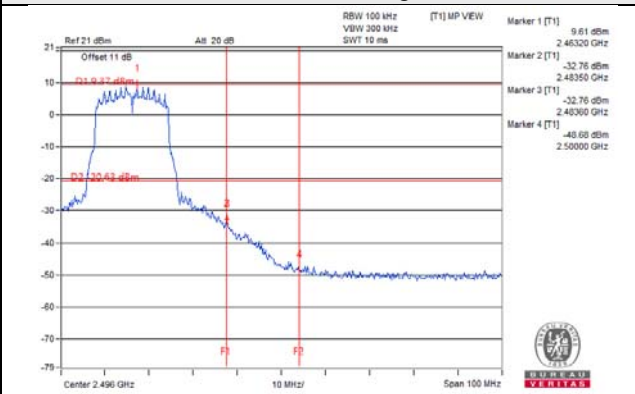

802.11g_Chain 2

CH 1

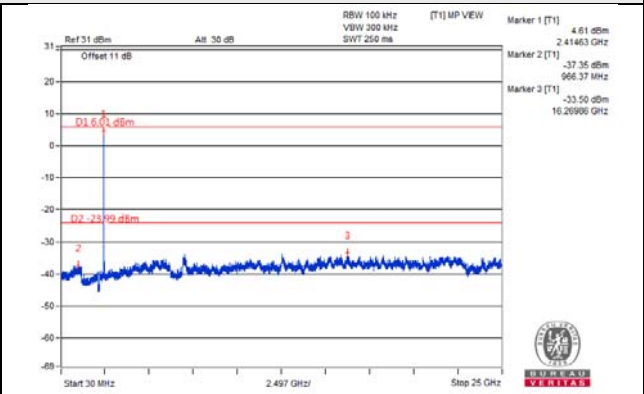
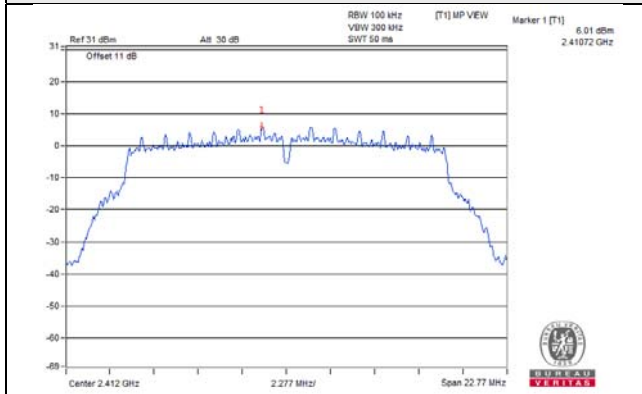

CH 6

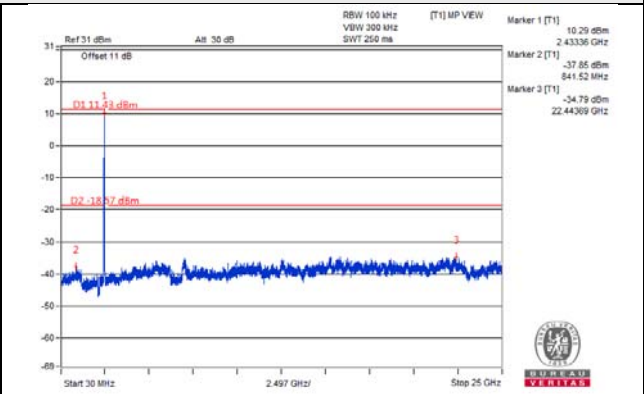
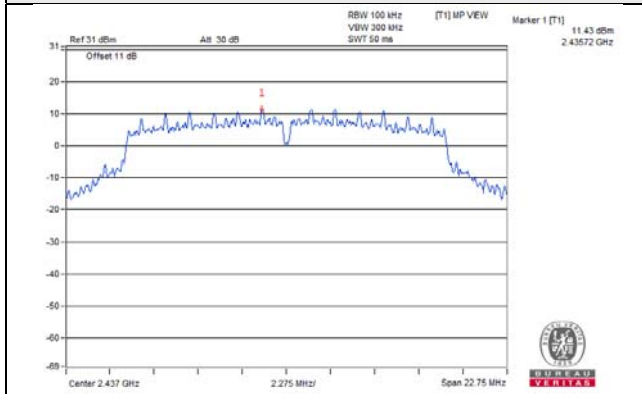

CH 11

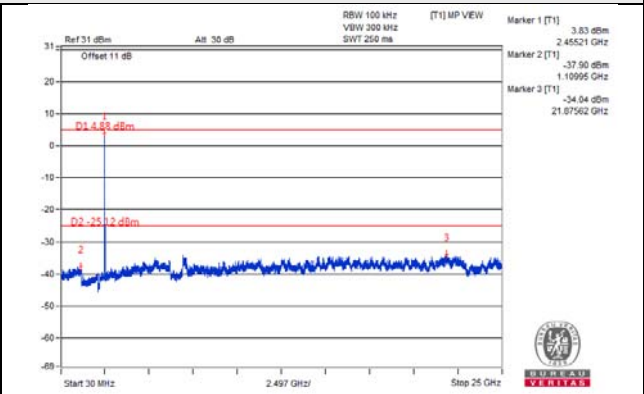
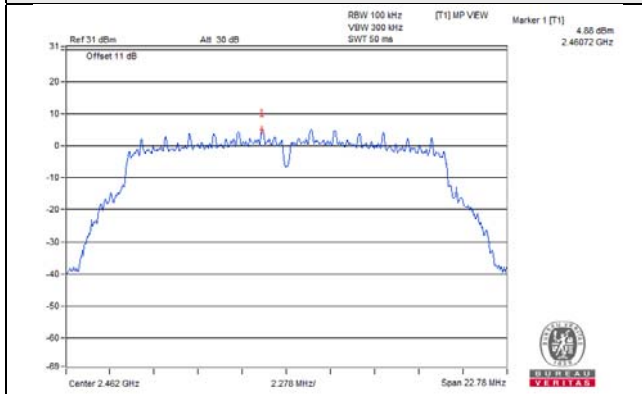

CH 1 Band edge

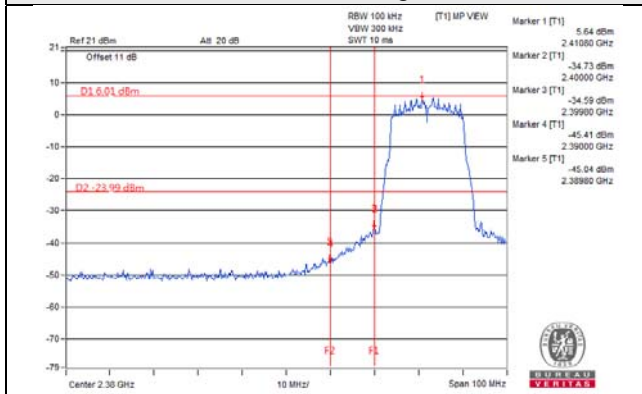

CH 11 Band edge

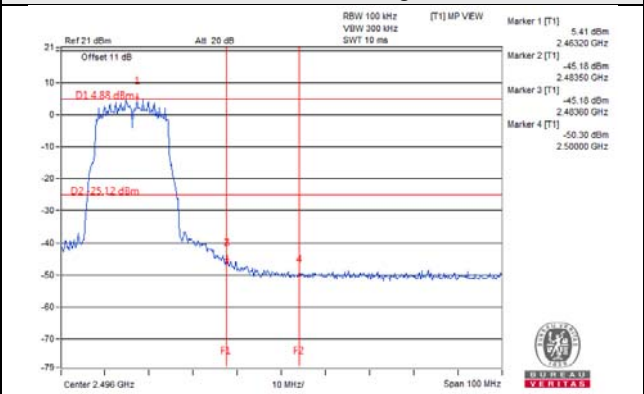

802.11n (HT20)_Chain 0

CH 1

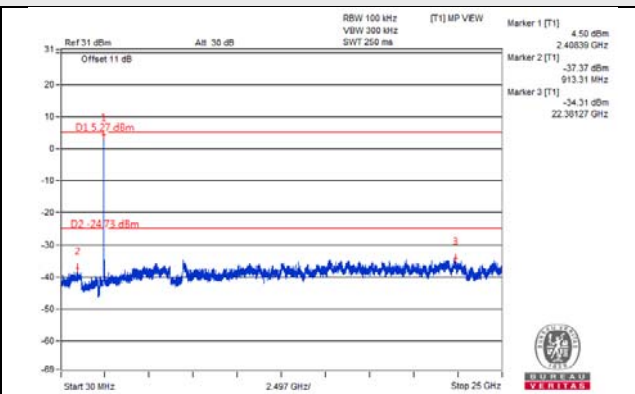
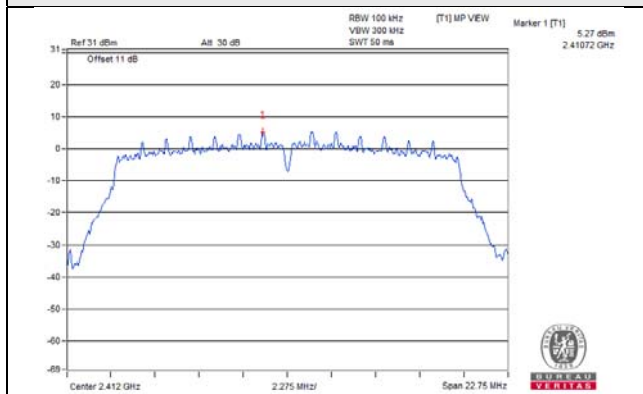

CH 6

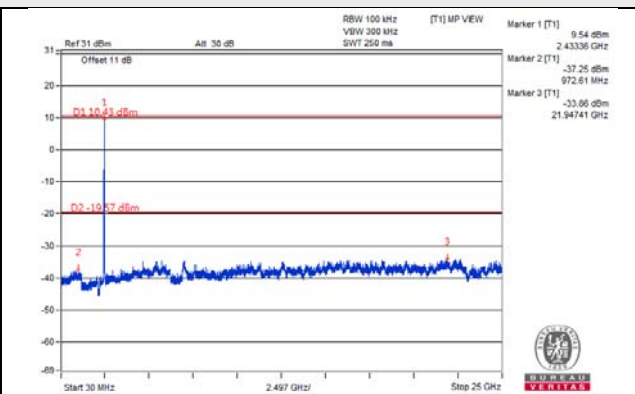
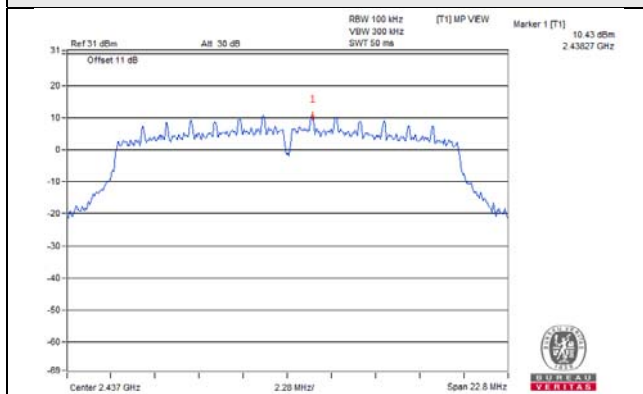

CH 11

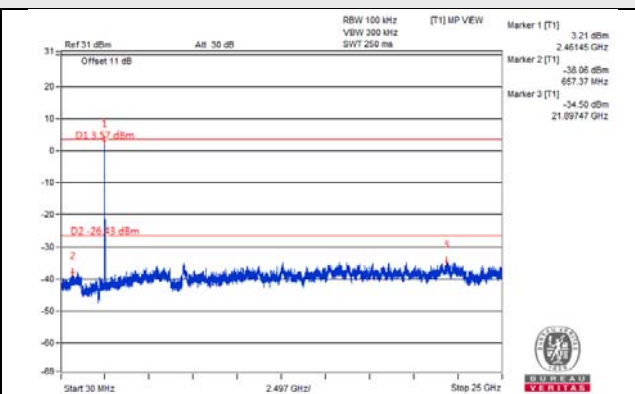
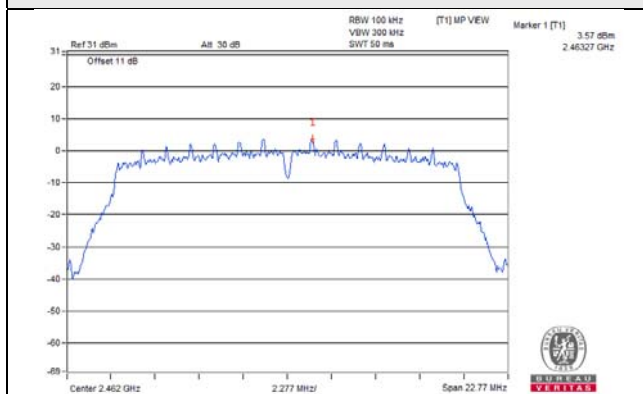

CH 1 Band edge

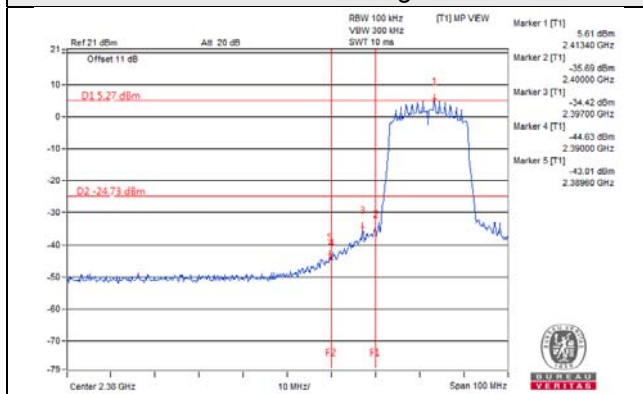

CH 11 Band edge

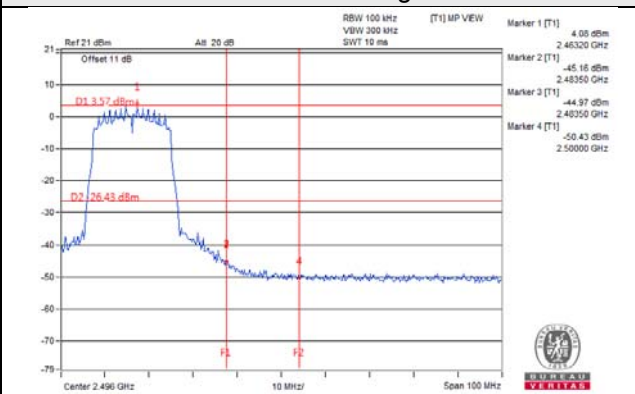

802.11n (HT20)_Chain 1

CH 1

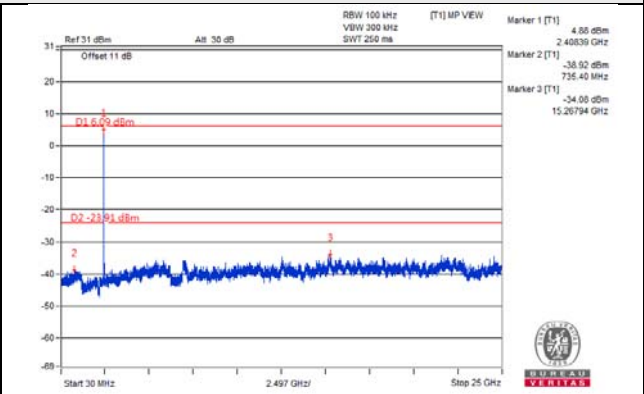
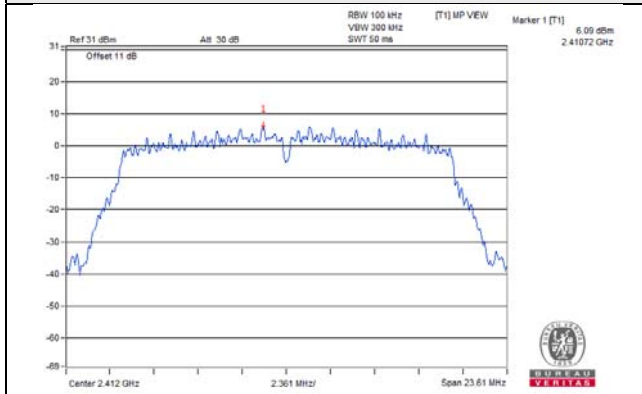

CH 6

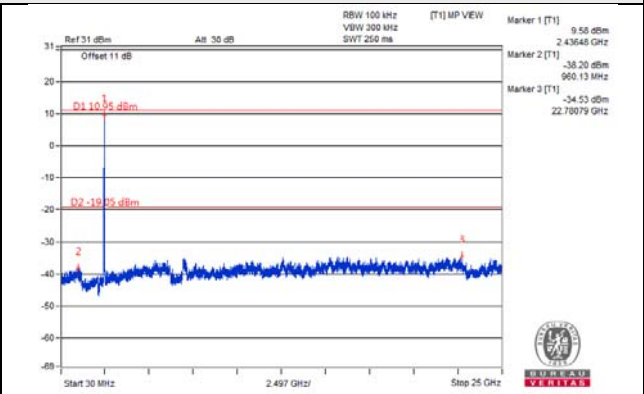
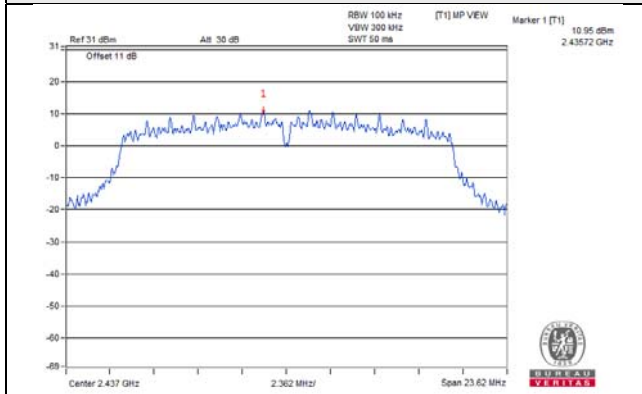

CH 11

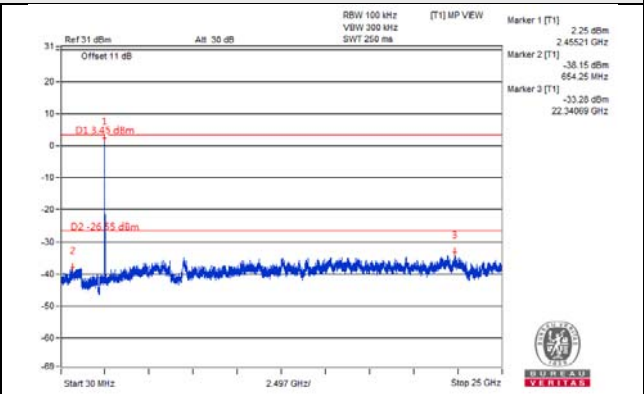
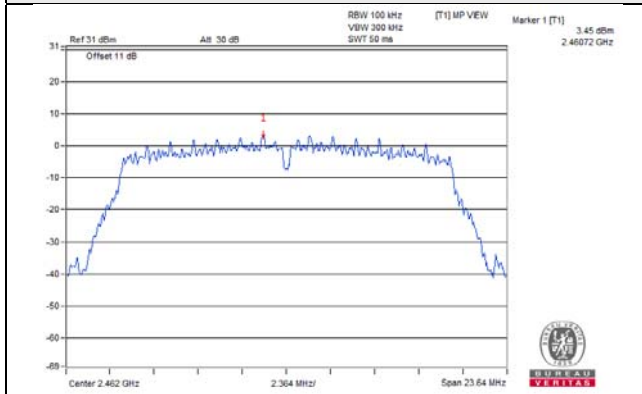

CH 1 Band edge

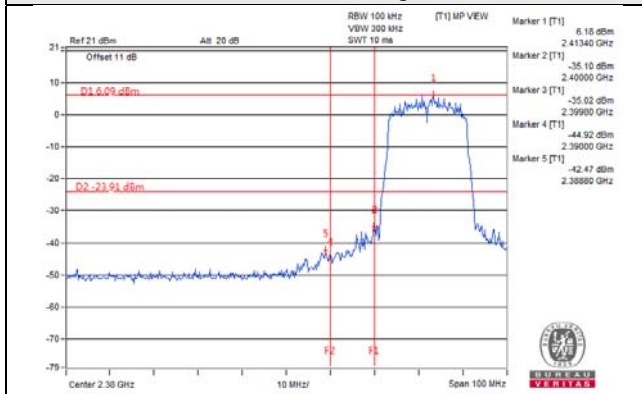

CH 11 Band edge

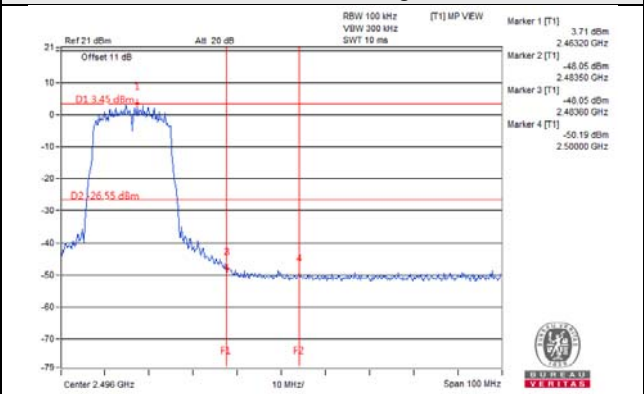

802.11n (HT20)_Chain 2

CH 1

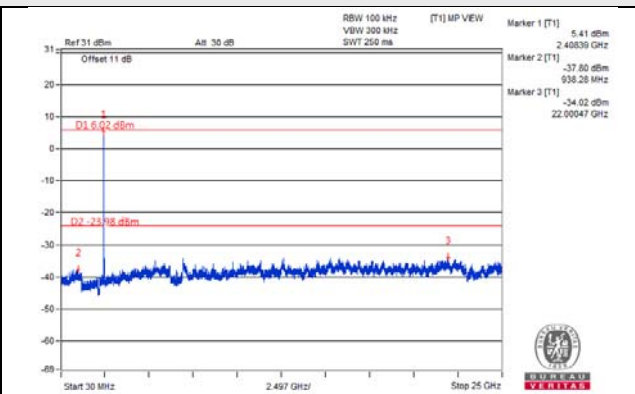
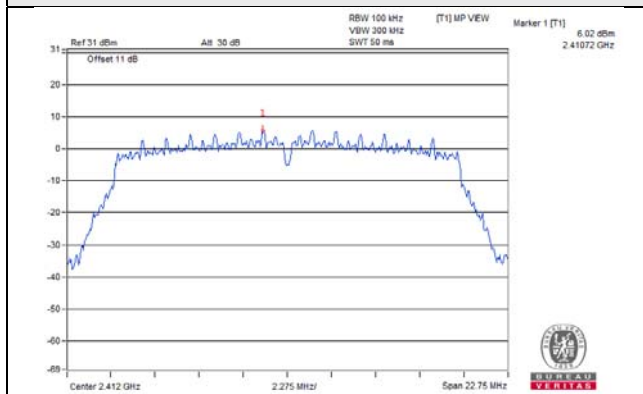

CH 6

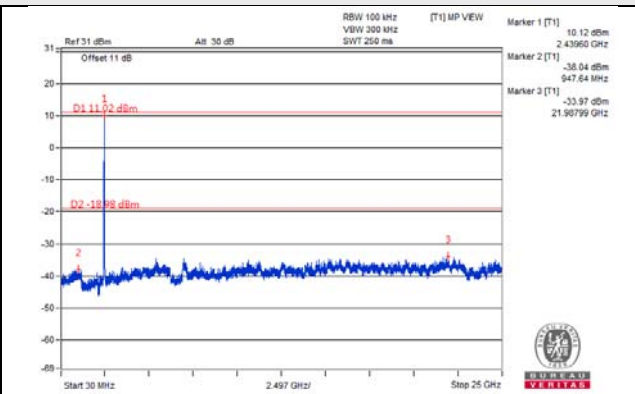
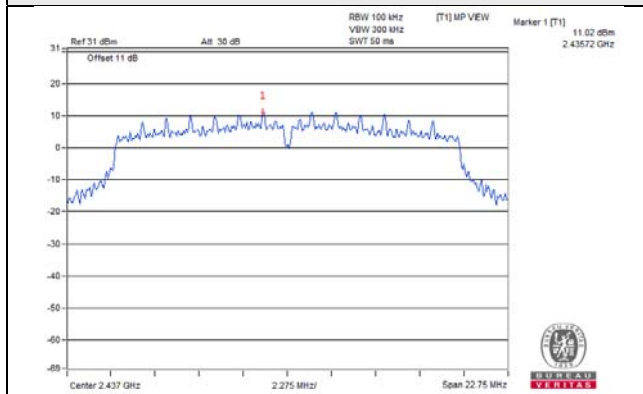

CH 11

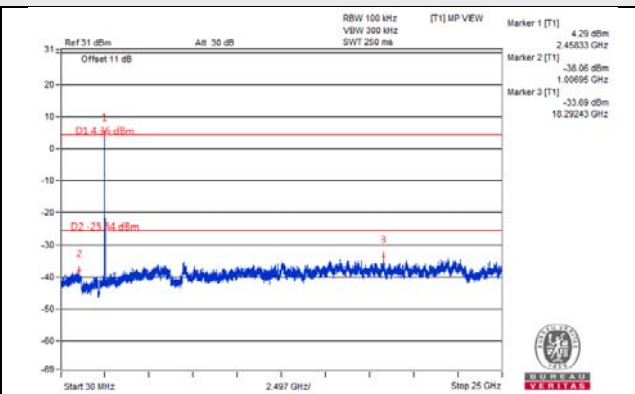
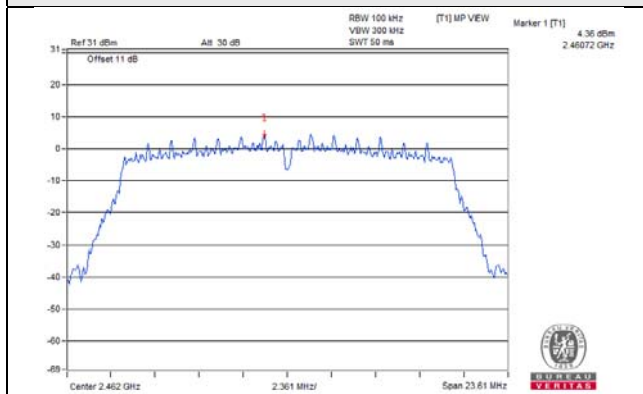

CH 1 Band edge

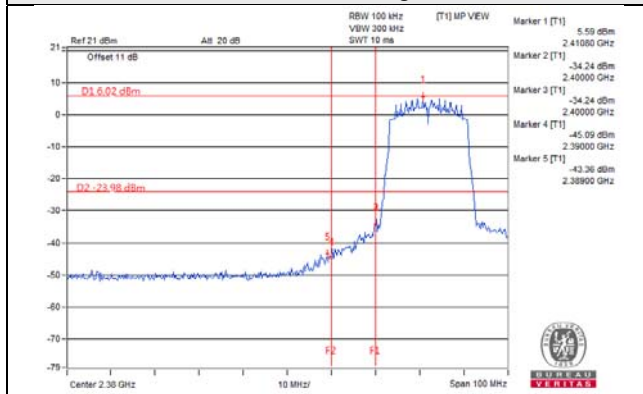

CH 11 Band edge

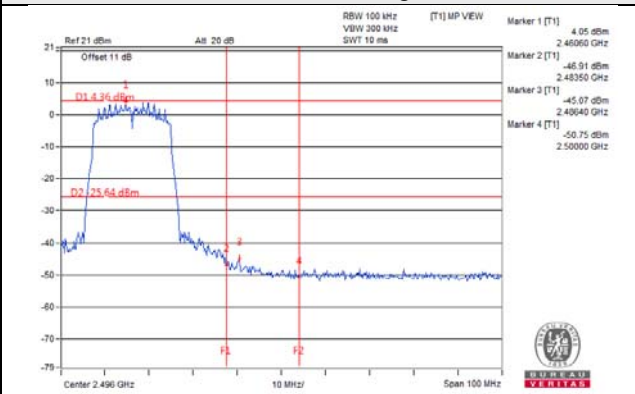

802.11n (HT40)_Chain 0

CH 3

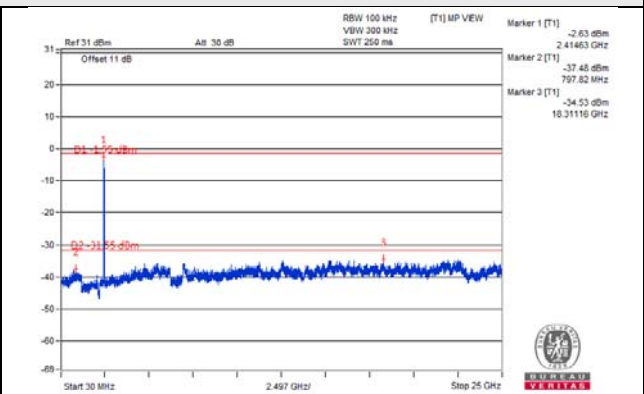
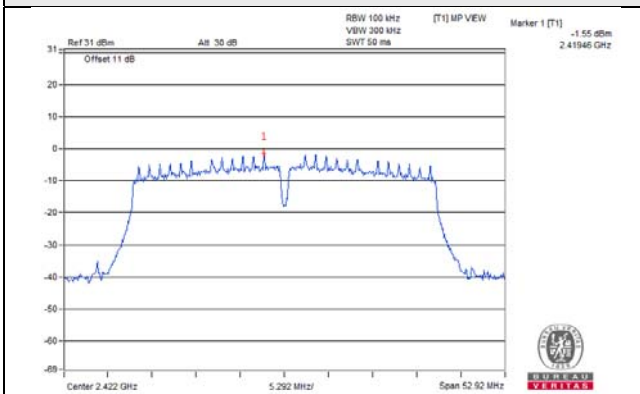

CH 6

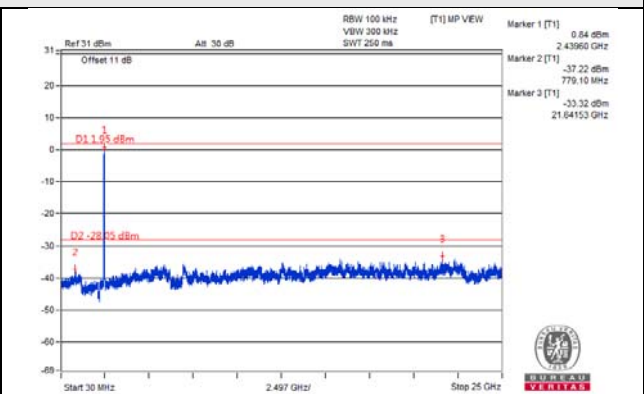
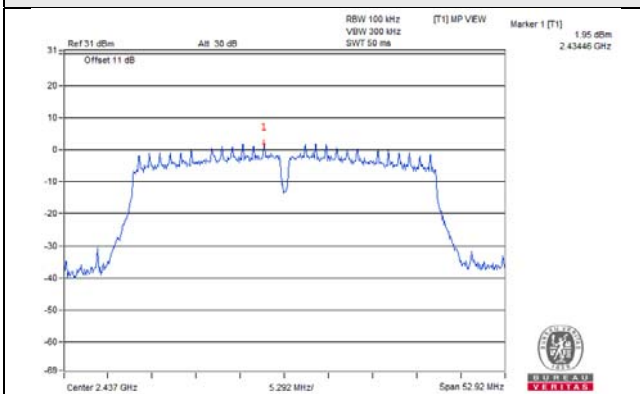

CH 9

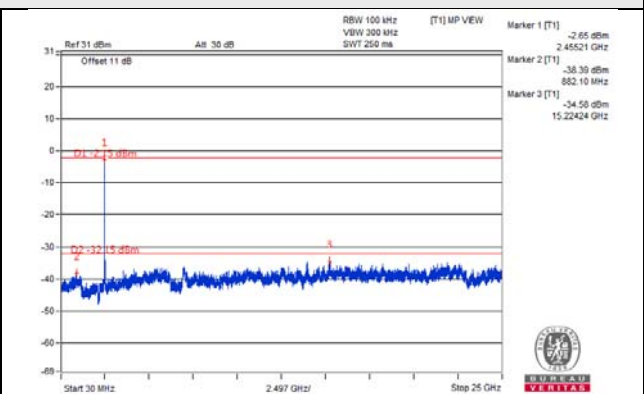
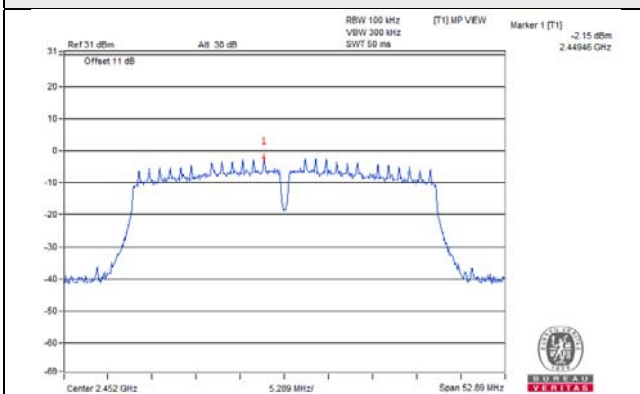

CH 3 Band edge

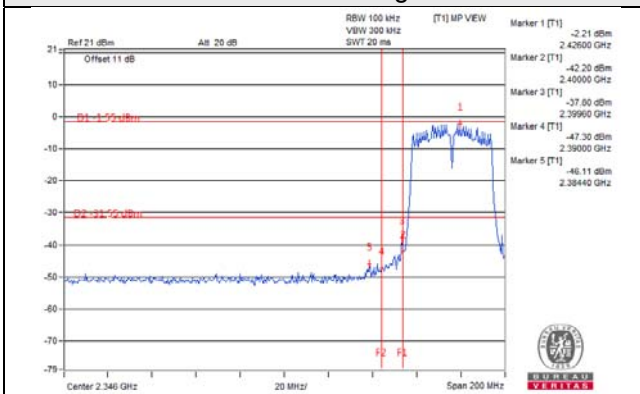

CH 9 Band edge

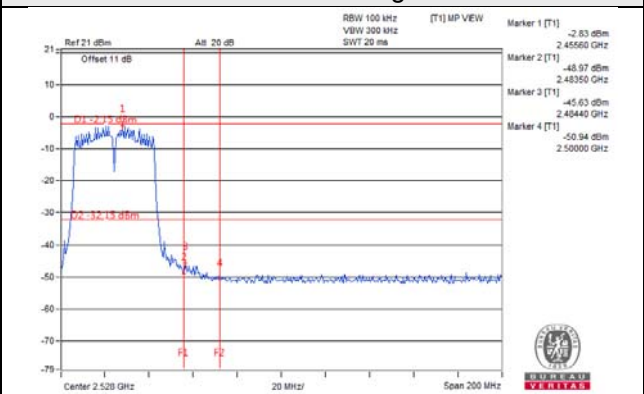

802.11n (HT40)_Chain 1

CH 3

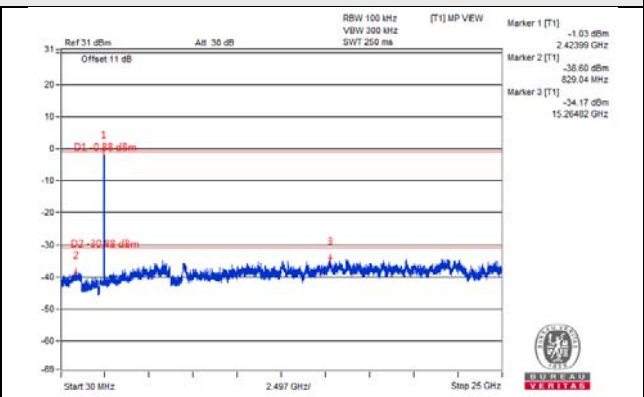
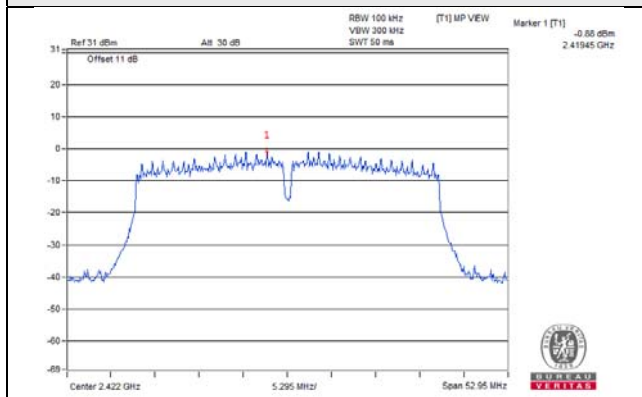

CH 6

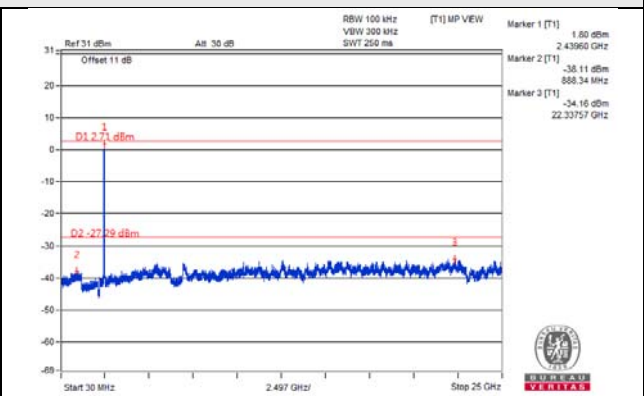
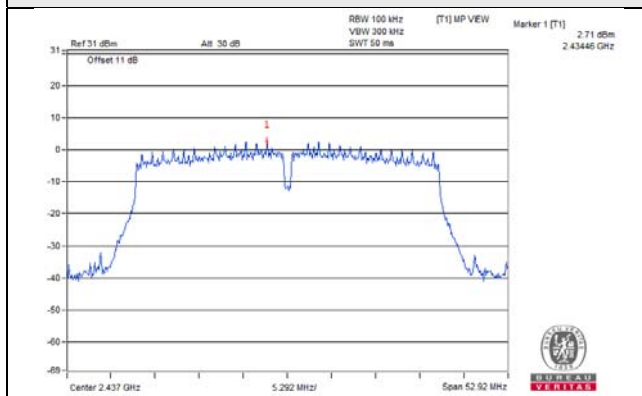

CH 9

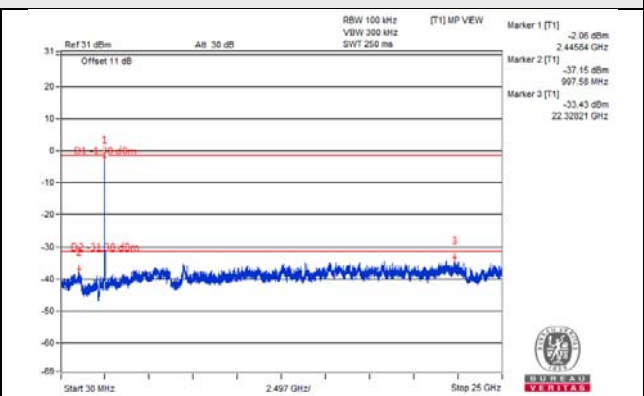
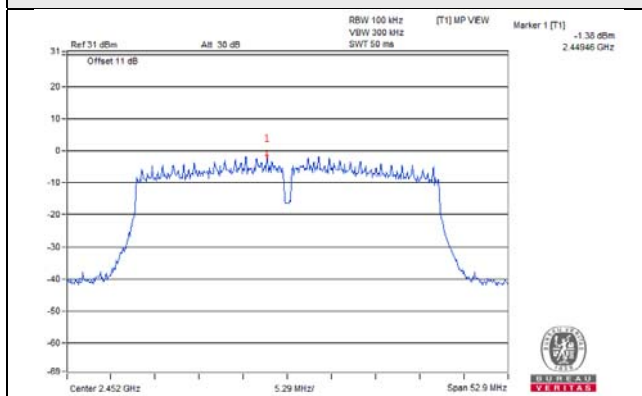

CH 3 Band edge

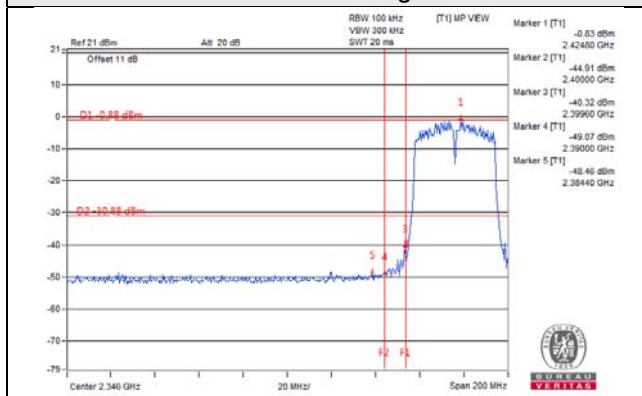

CH 9 Band edge

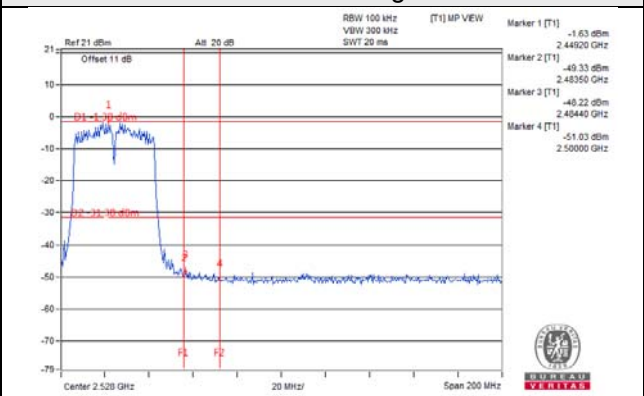

802.11n (HT40)_Chain 2

CH 3

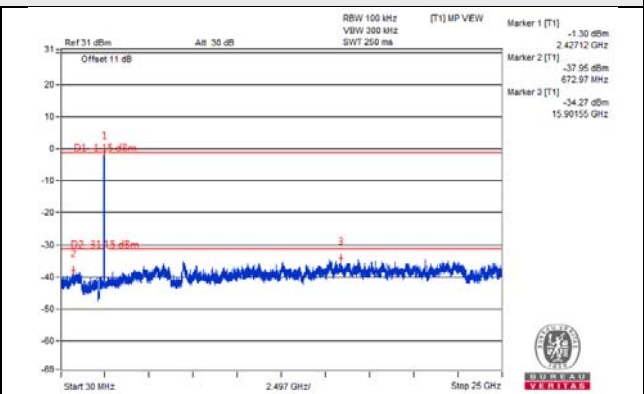
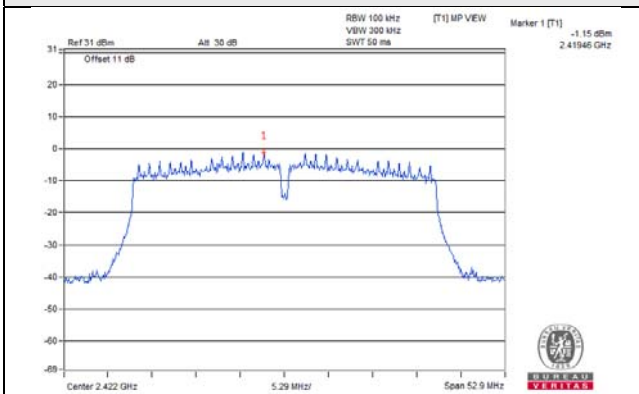

CH 6

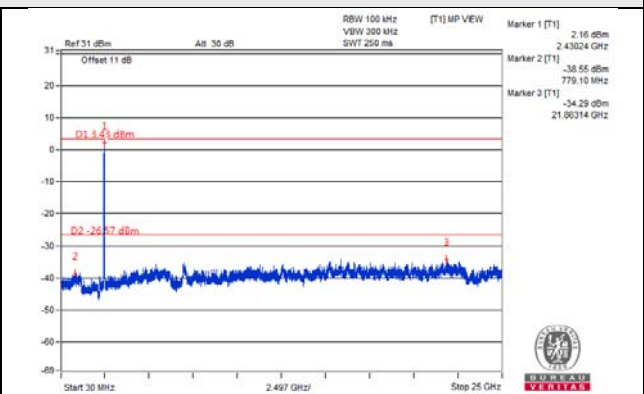
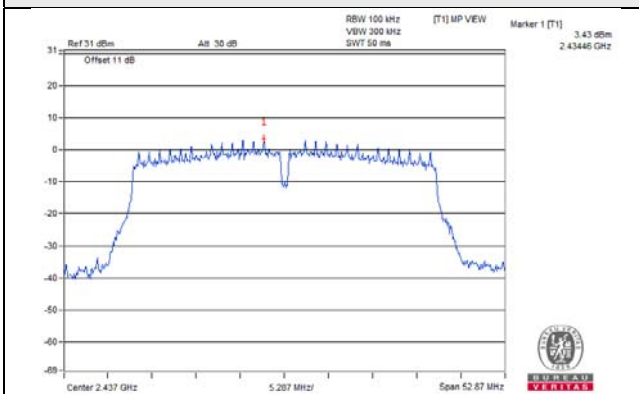

CH 9

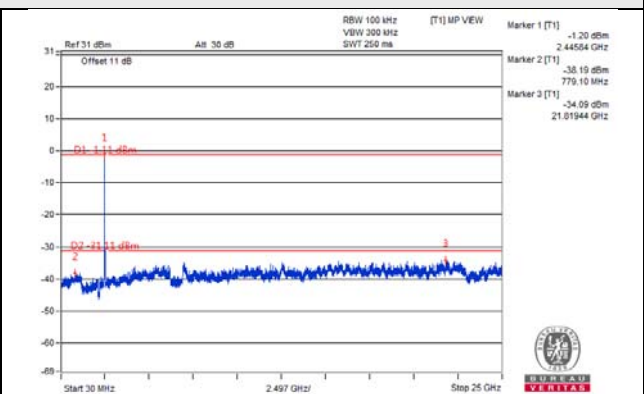
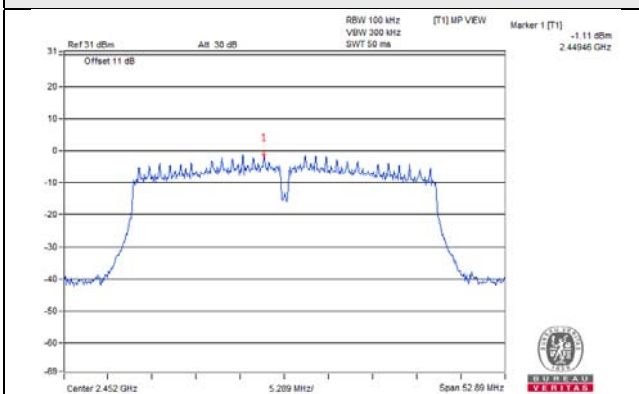

CH 3 Band edge

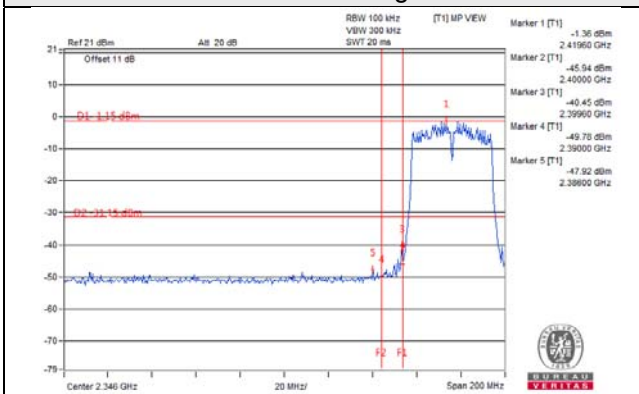

CH 9 Band edge

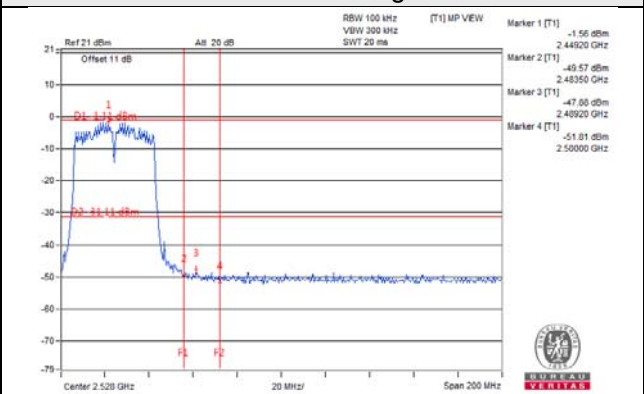

5 Pictures of Test Arrangements

Please refer to the attached file (Test Setup Photo).

Appendix – Information of the Testing Laboratories

We, Bureau Veritas Consumer Products Services (H.K.) Ltd., Taoyuan Branch, were founded in 1988 to provide our best service in EMC, Radio, Telecom and Safety consultation. Our laboratories are FCC recognized accredited test firms and accredited and approved according to ISO/IEC 17025.

If you have any comments, please feel free to contact us at the following:

Lin Kou EMC/RF Lab

Tel: 886-2-26052180

Fax: 886-2-26051924

Hsin Chu EMC/RF/Telecom Lab

Tel: 886-3-6668565

Fax: 886-3-6668323

Hwa Ya EMC/RF/Safety Lab

Tel: 886-3-3183232

Fax: 886-3-3270892

Email: service.adt@tw.bureauveritas.com

Web Site: www.bureauveritas-adt.com

The address and road map of all our labs can be found in our web site also.

--- END ---