

Test Mode	IEEE 802.11n HT20 / 5785 MHz	Temp/Hum	24.8(°C)/ 59%RH
Test Item	Harmonic	Test Date	May 10, 2023
Polarize	Horizontal	Test Engineer	Ray Li
Detector	Peak & Average		

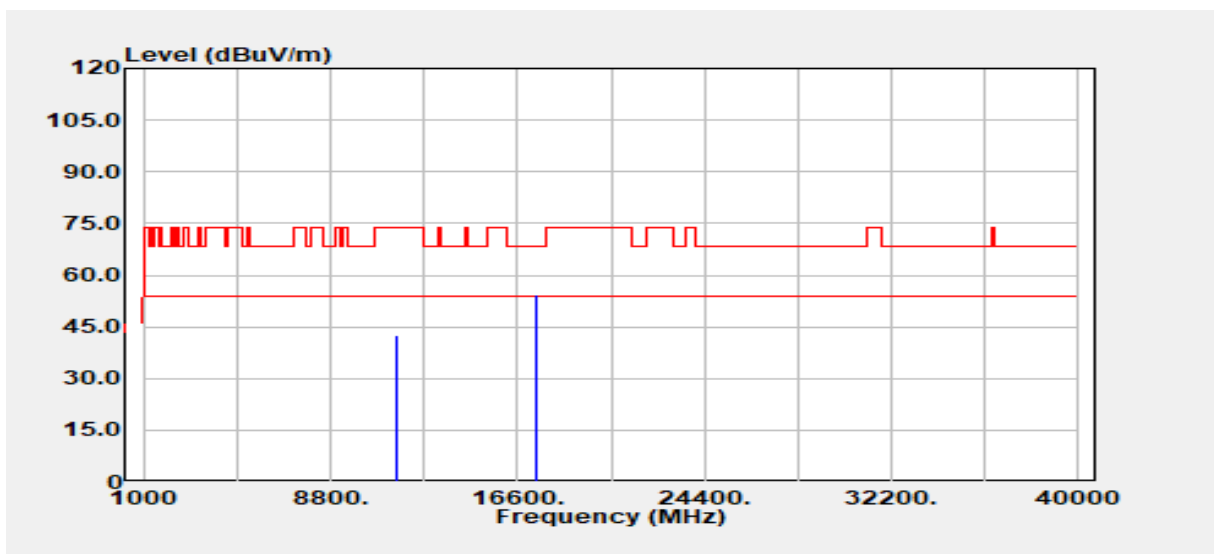

Freq. (MHz)	Detector Mode (PK/QP/AV)	Spectrum Reading Level (dBμV)	Factor (dB)	Actual FS (dBμV/m)	Limit @3m (dBμV/m)	Margin (dB)
11570.00	Peak	30.12	12.49	42.61	74.00	-31.39
11570.00	Average	24.40	12.49	36.89	54.00	-17.11
17355.00	Peak	28.84	25.47	54.31	68.20	-13.89
N/A						

Remark:

1. Measuring frequencies from 1 GHz to the 10th harmonic of highest fundamental frequency.

Test Mode	IEEE 802.11n HT20 / 5825 MHz	Temp/Hum	24.8(°C)/ 59%RH
Test Item	Harmonic	Test Date	May 10, 2023
Polarize	Vertical	Test Engineer	Ray Li
Detector	Peak & Average		

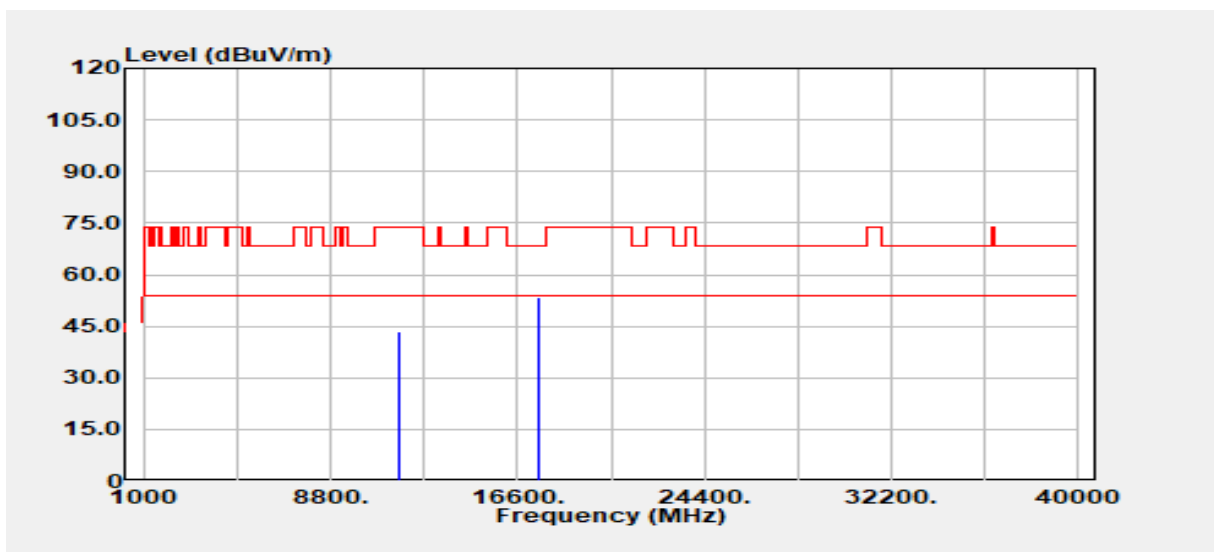

Freq. (MHz)	Detector Mode (PK/QP/AV)	Spectrum Reading Level (dBμV)	Factor (dB)	Actual FS (dBμV/m)	Limit @3m (dBμV/m)	Margin (dB)
11650.00	Peak	31.19	12.43	43.62	74.00	-30.38
11650.00	Average	24.47	12.43	36.90	54.00	-17.10
17475.00	Peak	28.34	25.06	53.40	68.20	-14.80
N/A						

Remark:

1. Measuring frequencies from 1 GHz to the 10th harmonic of highest fundamental frequency.

Test Mode	IEEE 802.11n HT20 / 5825 MHz	Temp/Hum	24.8(°C)/ 59%RH
Test Item	Harmonic	Test Date	May 10, 2023
Polarize	Horizontal	Test Engineer	Ray Li
Detector	Peak & Average		

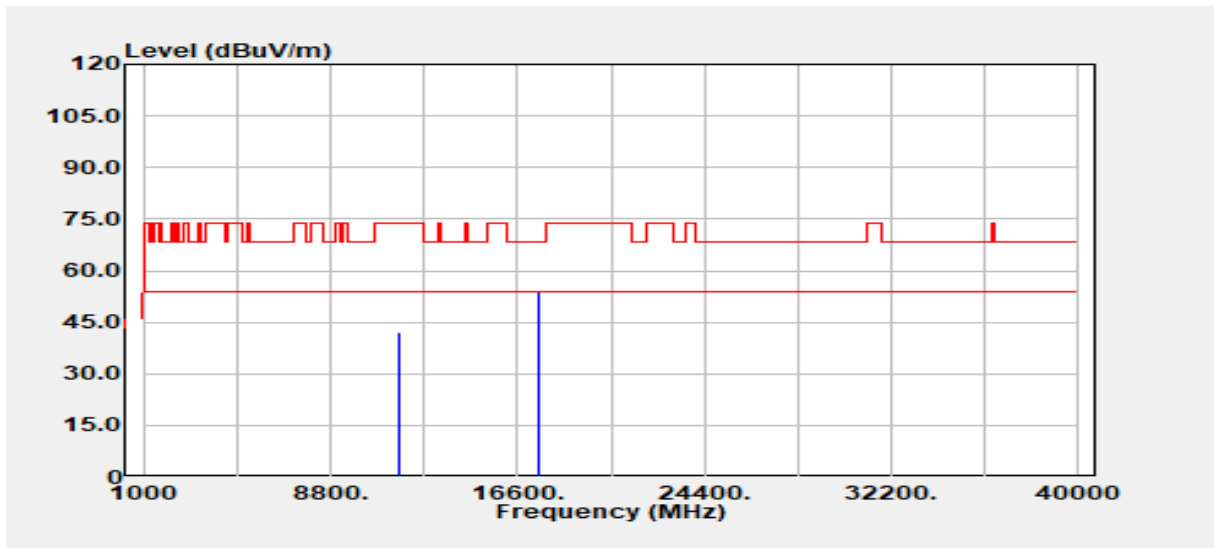

Freq. (MHz)	Detector Mode (PK/QP/AV)	Spectrum Reading Level (dBµV)	Factor (dB)	Actual FS (dBµV/m)	Limit @3m (dBµV/m)	Margin (dB)
11650.00	Peak	29.71	12.43	42.13	74.00	-31.87
11650.00	Average	24.70	12.43	37.12	54.00	-16.88
17475.00	Peak	28.69	25.06	53.75	68.20	-14.45
N/A						

Remark:

1. Measuring frequencies from 1 GHz to the 10th harmonic of highest fundamental frequency.

Test Mode	IEEE 802.11n HT40 / 5755 MHz	Temp/Hum	23.9(°C)/ 63%RH
Test Item	Harmonic	Test Date	May 19, 2023
Polarize	Vertical	Test Engineer	Ray Li
Detector	Peak & Average		

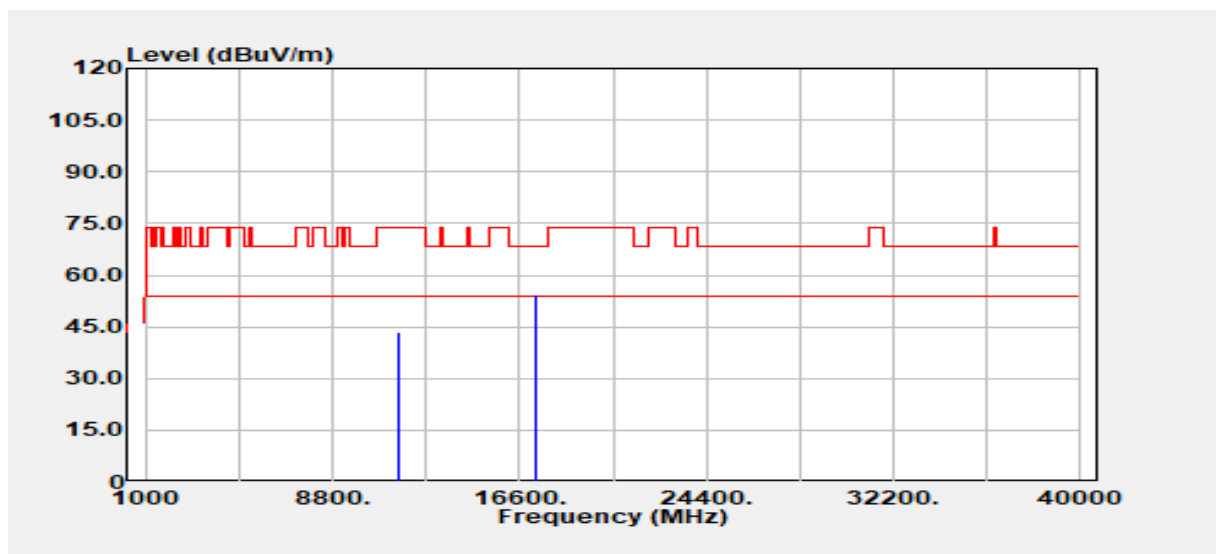

Freq. (MHz)	Detector Mode (PK/QP/AV)	Spectrum Reading Level (dBμV)	Factor (dB)	Actual FS (dBμV/m)	Limit @3m (dBμV/m)	Margin (dB)
11510.00	Peak	31.15	12.43	43.58	74.00	-30.42
11510.00	Average	23.05	12.43	35.48	54.00	-18.52
17265.00	Peak	28.34	26.14	54.48	68.20	-13.72
N/A						

Remark:

1. Measuring frequencies from 1 GHz to the 10th harmonic of highest fundamental frequency.

Test Mode	IEEE 802.11n HT40 / 5755 MHz	Temp/Hum	23.9(°C)/ 63%RH
Test Item	Harmonic	Test Date	May 19, 2023
Polarize	Horizontal	Test Engineer	Ray Li
Detector	Peak & Average		

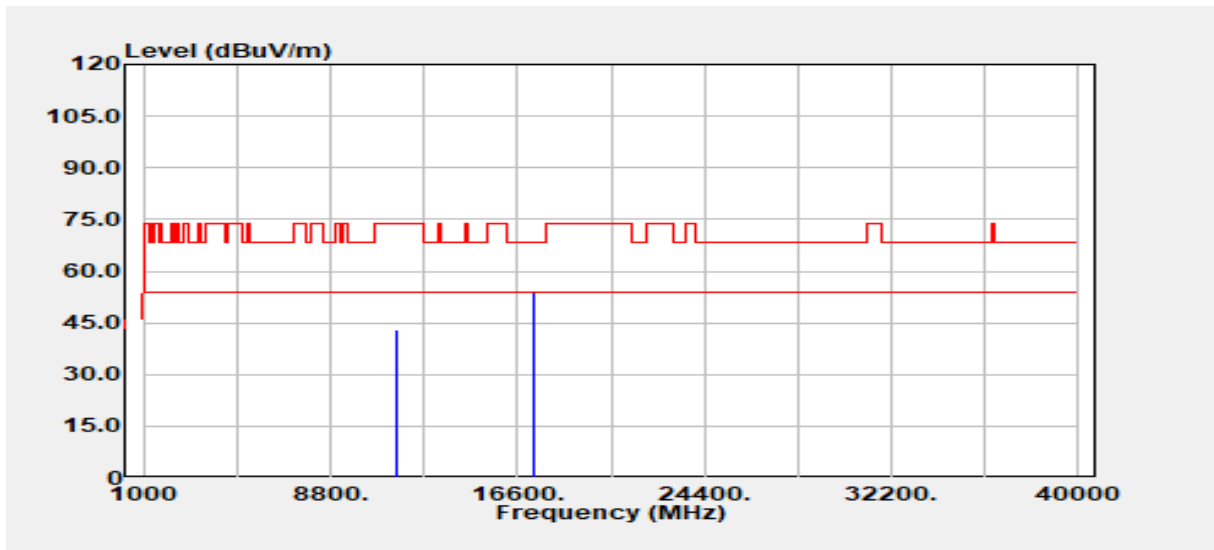

Freq. (MHz)	Detector Mode (PK/QP/AV)	Spectrum Reading Level (dBμV)	Factor (dB)	Actual FS (dBμV/m)	Limit @3m (dBμV/m)	Margin (dB)
11510.00	Peak	30.70	12.43	43.13	74.00	-30.87
11510.00	Average	23.12	12.43	35.55	54.00	-18.45
17265.00	Peak	27.71	26.14	53.85	68.20	-14.35
N/A						

Remark:

1. Measuring frequencies from 1 GHz to the 10th harmonic of highest fundamental frequency.

Test Mode	IEEE 802.11n HT40 / 5795 MHz	Temp/Hum	23.9(°C)/ 63%RH
Test Item	Harmonic	Test Date	May 19, 2023
Polarize	Vertical	Test Engineer	Ray Li
Detector	Peak & Average		

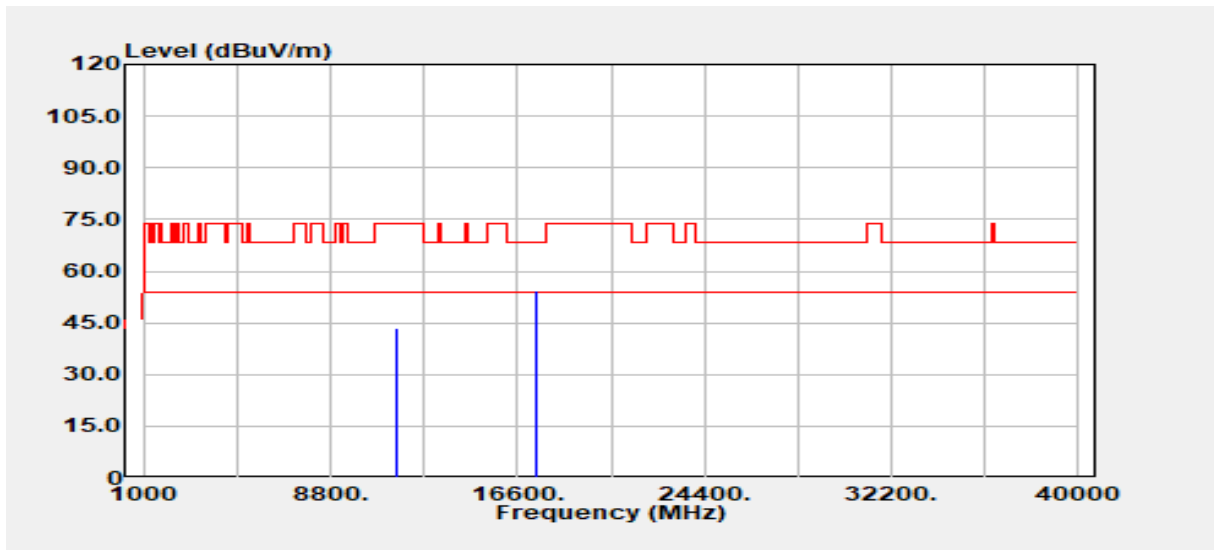

Freq. (MHz)	Detector Mode (PK/QP/AV)	Spectrum Reading Level (dBµV)	Factor (dB)	Actual FS (dBµV/m)	Limit @3m (dBµV/m)	Margin (dB)
11590.00	Peak	30.99	12.48	43.46	74.00	-30.54
11590.00	Average	22.97	12.48	35.45	54.00	-18.55
17385.00	Peak	29.17	25.27	54.44	68.20	-13.76
N/A						

Remark:

1. Measuring frequencies from 1 GHz to the 10th harmonic of highest fundamental frequency.

Test Mode	IEEE 802.11n HT40 / 5795 MHz	Temp/Hum	23.9(°C)/ 63%RH
Test Item	Harmonic	Test Date	May 19, 2023
Polarize	Horizontal	Test Engineer	Ray Li
Detector	Peak & Average		

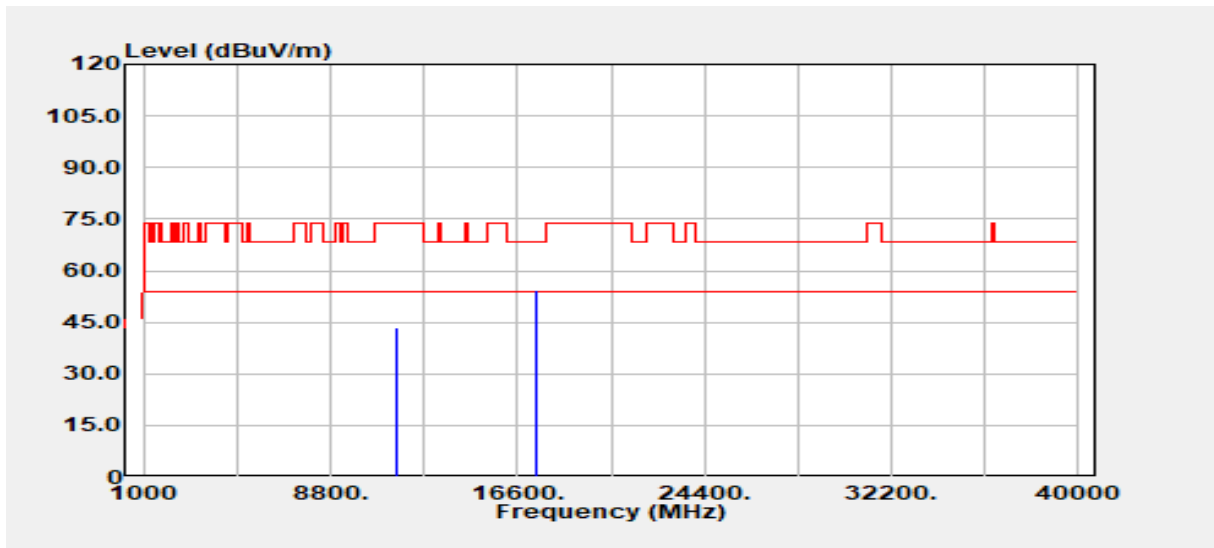

Freq. (MHz)	Detector Mode (PK/QP/AV)	Spectrum Reading Level (dBμV)	Factor (dB)	Actual FS (dBμV/m)	Limit @3m (dBμV/m)	Margin (dB)
11590.00	Peak	30.82	12.48	43.29	74.00	-30.71
11590.00	Average	23.06	12.48	35.53	54.00	-18.47
17385.00	Peak	29.29	25.27	54.56	68.20	-13.64
N/A						

Remark:

1. Measuring frequencies from 1 GHz to the 10th harmonic of highest fundamental frequency.

Test Mode	IEEE 802.11ac VHT80 / 5775 MHz	Temp/Hum	23.9(°C)/ 63%RH
Test Item	Harmonic	Test Date	May 19, 2023
Polarize	Vertical	Test Engineer	Ray Li
Detector	Peak & Average		

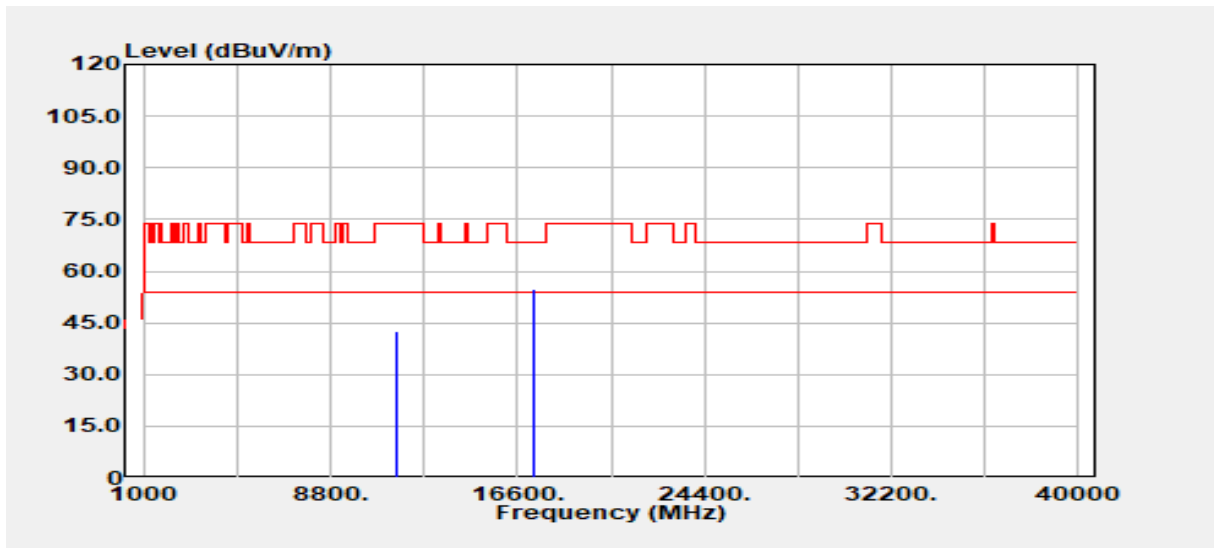

Freq. (MHz)	Detector Mode (PK/QP/AV)	Spectrum Reading Level (dBμV)	Factor (dB)	Actual FS (dBμV/m)	Limit @3m (dBμV/m)	Margin (dB)
11550.00	Peak	30.14	12.51	42.64	74.00	-31.36
11550.00	Average	23.62	12.51	36.12	54.00	-17.88
17325.00	Peak	29.10	25.79	54.89	68.20	-13.31
N/A						

Remark:

1. Measuring frequencies from 1 GHz to the 10th harmonic of highest fundamental frequency.

Test Mode	IEEE 802.11ac VHT80 / 5775 MHz	Temp/Hum	23.9(°C)/ 63%RH
Test Item	Harmonic	Test Date	May 19, 2023
Polarize	Horizontal	Test Engineer	Ray Li
Detector	Peak & Average		

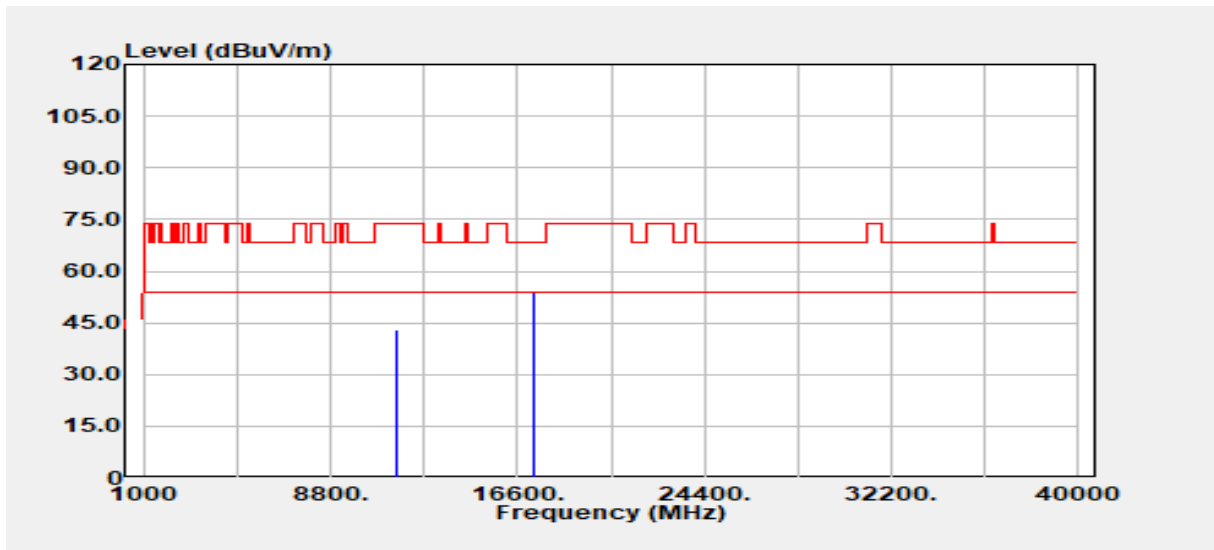

Freq. (MHz)	Detector Mode (PK/QP/AV)	Spectrum Reading Level (dBµV)	Factor (dB)	Actual FS (dBµV/m)	Limit @3m (dBµV/m)	Margin (dB)
11550.00	Peak	30.57	12.51	43.08	74.00	-30.92
11550.00	Average	23.74	12.51	36.25	54.00	-17.75
17325.00	Peak	28.27	25.79	54.06	68.20	-14.14
N/A						

Remark:

1. Measuring frequencies from 1 GHz to the 10th harmonic of highest fundamental frequency.

Test Mode	IEEE 802.11ax HE20 / 5745 MHz	Temp/Hum	23.7(°C)/ 50%RH
Test Item	Harmonic	Test Date	May 22, 2023
Polarize	Vertical	Test Engineer	Tony Chao
Detector	Peak & Average		

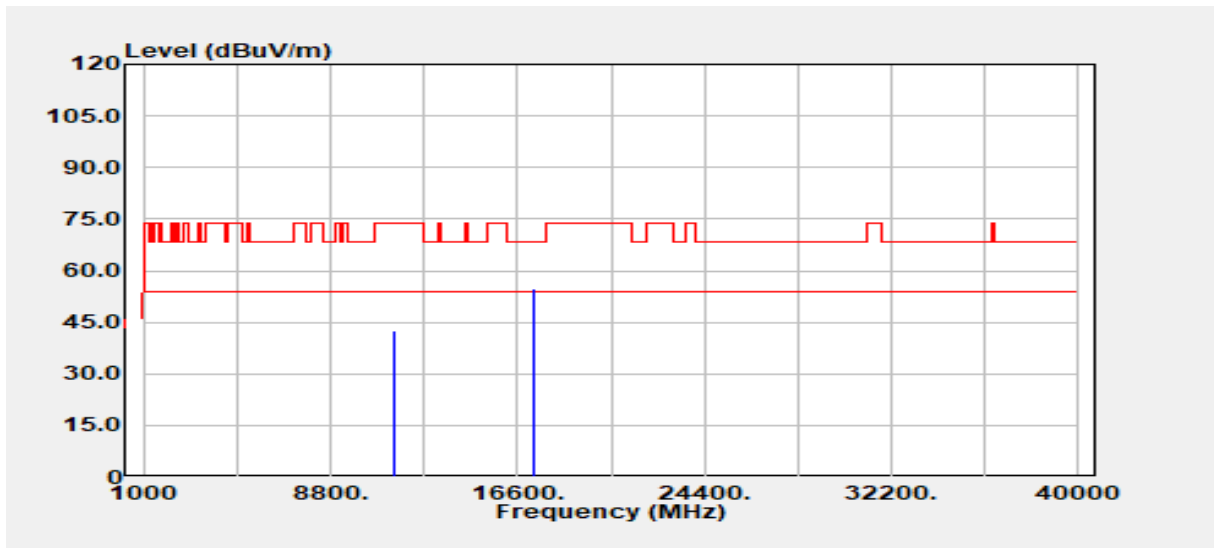

Freq. (MHz)	Detector Mode (PK/QP/AV)	Spectrum Reading Level (dBμV)	Factor (dB)	Actual FS (dBμV/m)	Limit @3m (dBμV/m)	Margin (dB)
11490.00	Peak	29.95	12.39	42.34	74.00	-31.66
11490.00	Average	23.90	12.39	36.29	54.00	-17.71
17235.00	Peak	28.83	26.10	54.93	68.20	-13.27
N/A						

Remark:

1. Measuring frequencies from 1 GHz to the 10th harmonic of highest fundamental frequency.

Test Mode	IEEE 802.11ax HE20 / 5745 MHz	Temp/Hum	23.7(°C)/ 50%RH
Test Item	Harmonic	Test Date	May 22, 2023
Polarize	Horizontal	Test Engineer	Tony Chao
Detector	Peak & Average		

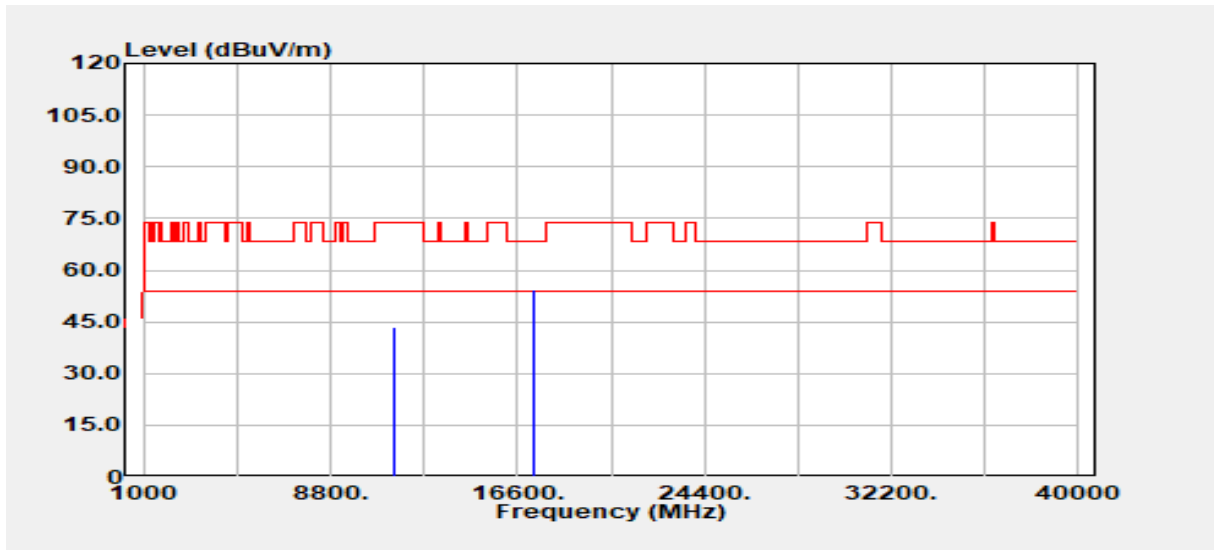

Freq. (MHz)	Detector Mode (PK/QP/AV)	Spectrum Reading Level (dBμV)	Factor (dB)	Actual FS (dBμV/m)	Limit @3m (dBμV/m)	Margin (dB)
11490.00	Peak	31.04	12.39	43.43	74.00	-30.57
11490.00	Average	24.11	12.39	36.50	54.00	-17.50
17235.00	Peak	28.24	26.10	54.35	68.20	-13.85
N/A						

Remark:

1. Measuring frequencies from 1 GHz to the 10th harmonic of highest fundamental frequency.

Test Mode	IEEE 802.11ax HE20 / 5785 MHz	Temp/Hum	23.7(°C)/ 50%RH
Test Item	Harmonic	Test Date	May 22, 2023
Polarize	Vertical	Test Engineer	Tony Chao
Detector	Peak & Average		

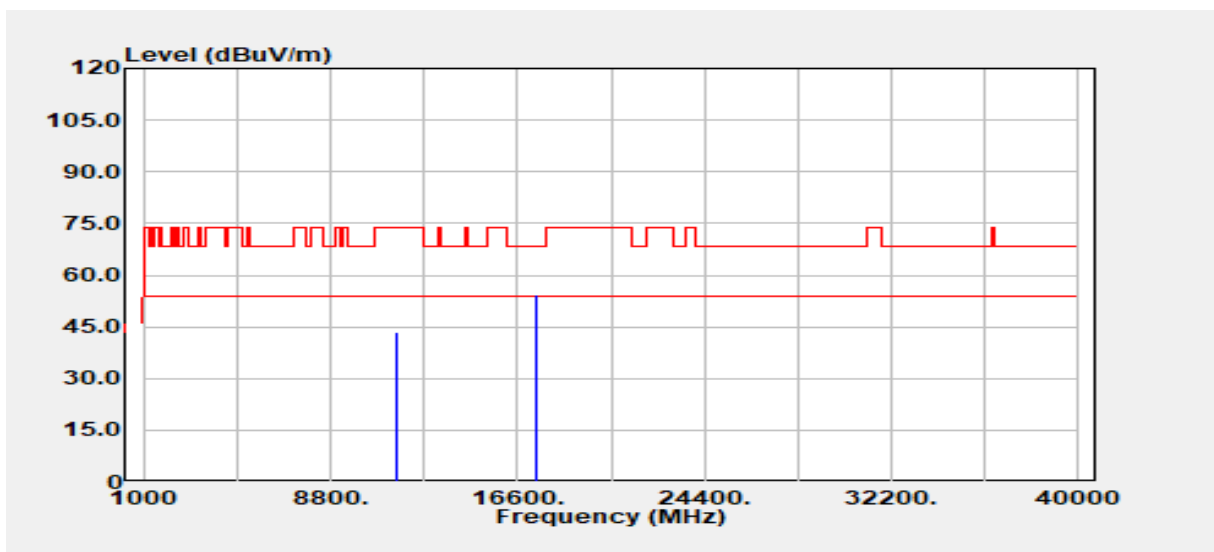

Freq. (MHz)	Detector Mode (PK/QP/AV)	Spectrum Reading Level (dB μ V)	Factor (dB)	Actual FS (dB μ V/m)	Limit @3m (dB μ V/m)	Margin (dB)
11570.00	Peak	30.79	12.49	43.28	74.00	-30.72
11570.00	Average	23.85	12.49	36.34	54.00	-17.66
17355.00	Peak	28.86	25.47	54.33	68.20	-13.87
N/A						

Remark:

1. Measuring frequencies from 1 GHz to the 10th harmonic of highest fundamental frequency.

Test Mode	IEEE 802.11ax HE20 / 5785 MHz	Temp/Hum	23.7(°C)/ 50%RH
Test Item	Harmonic	Test Date	May 22, 2023
Polarize	Horizontal	Test Engineer	Tony Chao
Detector	Peak & Average		

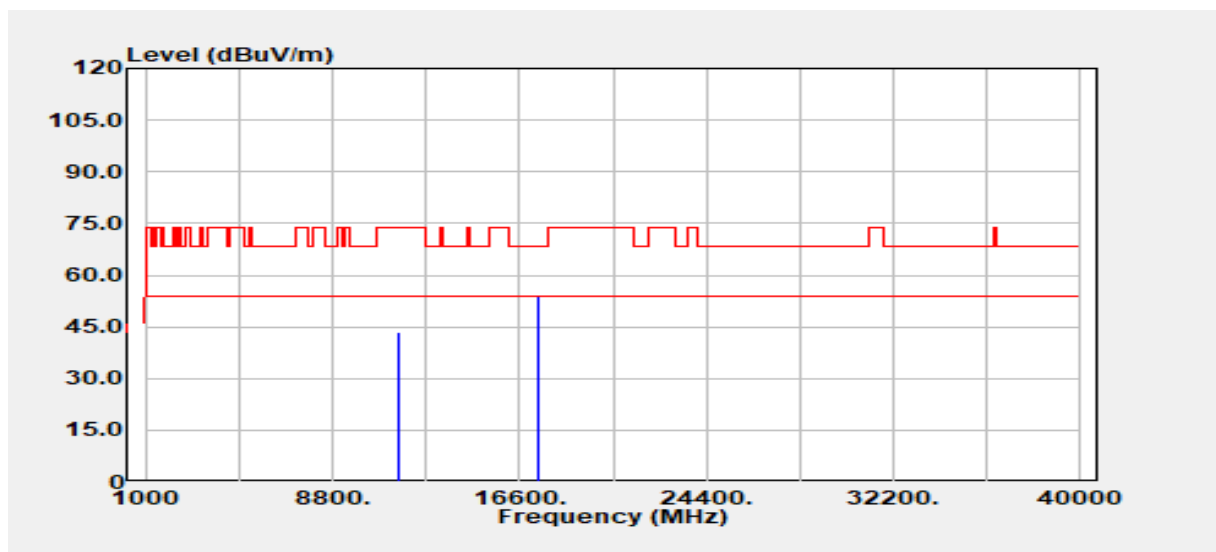

Freq. (MHz)	Detector Mode (PK/QP/AV)	Spectrum Reading Level (dBμV)	Factor (dB)	Actual FS (dBμV/m)	Limit @3m (dBμV/m)	Margin (dB)
11570.00	Peak	31.16	12.49	43.65	74.00	-30.35
11570.00	Average	24.61	12.49	37.10	54.00	-16.90
17355.00	Peak	28.43	25.47	53.90	68.20	-14.30
N/A						

Remark:

1. Measuring frequencies from 1 GHz to the 10th harmonic of highest fundamental frequency.

Test Mode	IEEE 802.11ax HE20 / 5825 MHz	Temp/Hum	23.7(°C)/ 50%RH
Test Item	Harmonic	Test Date	May 22, 2023
Polarize	Vertical	Test Engineer	Tony Chao
Detector	Peak & Average		

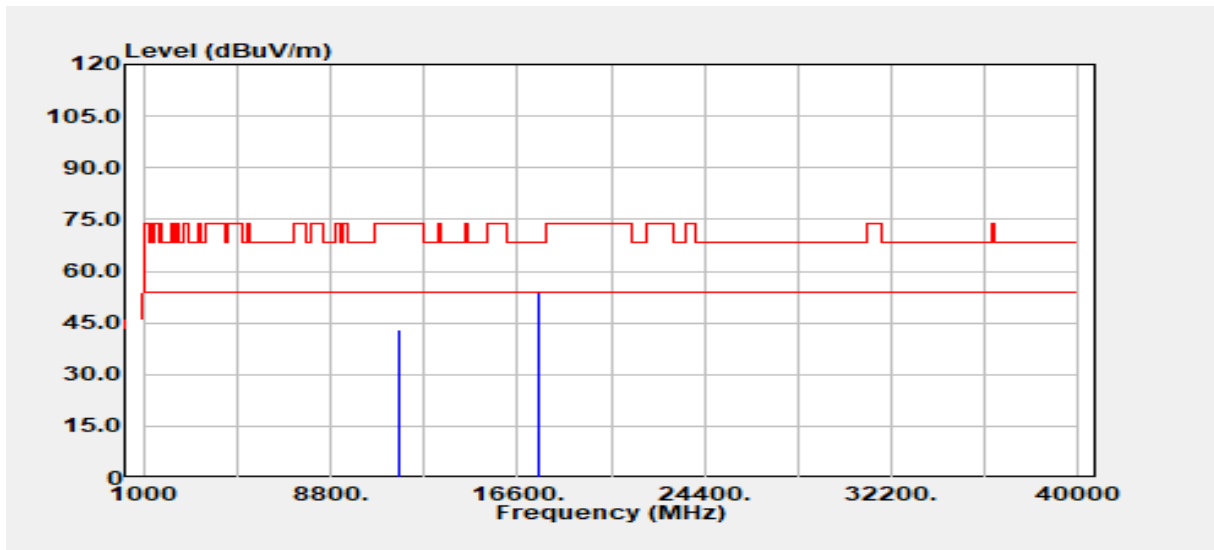

Freq. (MHz)	Detector Mode (PK/QP/AV)	Spectrum Reading Level (dBμV)	Factor (dB)	Actual FS (dBμV/m)	Limit @3m (dBμV/m)	Margin (dB)
11650.00	Peak	30.67	12.43	43.09	74.00	-30.91
11650.00	Average	23.57	12.43	36.00	54.00	-18.01
17475.00	Peak	28.83	25.06	53.89	68.20	-14.31
N/A						

Remark:

1. Measuring frequencies from 1 GHz to the 10th harmonic of highest fundamental frequency.

Test Mode	IEEE 802.11ax HE20 / 5825 MHz	Temp/Hum	23.7(°C)/ 50%RH
Test Item	Harmonic	Test Date	May 22, 2023
Polarize	Horizontal	Test Engineer	Tony Chao
Detector	Peak & Average		

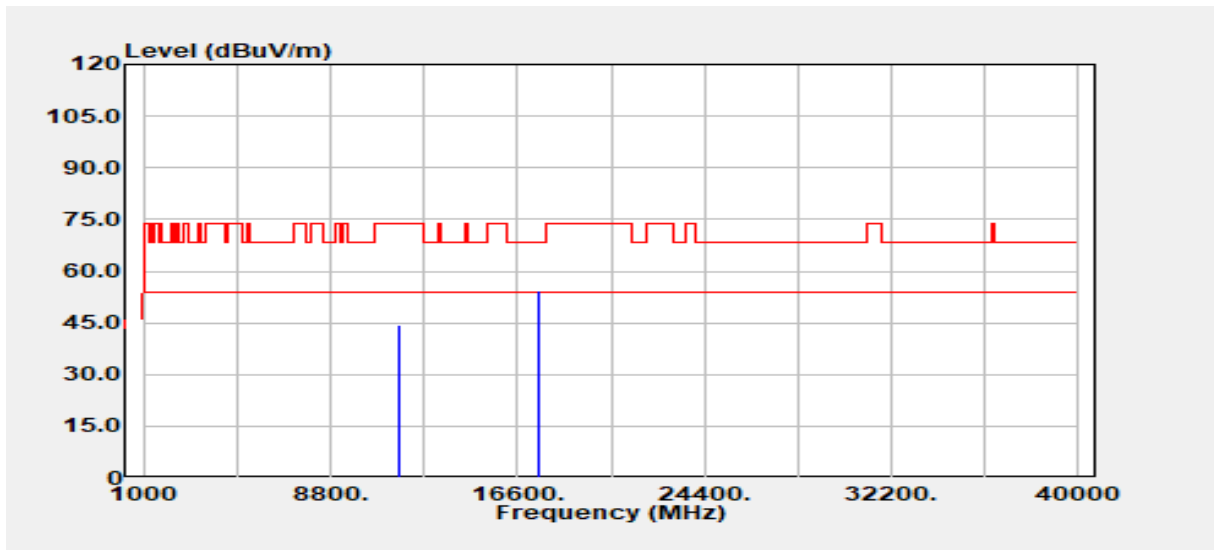

Freq. (MHz)	Detector Mode (PK/QP/AV)	Spectrum Reading Level (dBµV)	Factor (dB)	Actual FS (dBµV/m)	Limit @3m (dBµV/m)	Margin (dB)
11650.00	Peak	31.89	12.43	44.32	74.00	-29.68
11650.00	Average	24.26	12.43	36.69	54.00	-17.32
17475.00	Peak	29.33	25.06	54.39	68.20	-13.81
N/A						

Remark:

1. Measuring frequencies from 1 GHz to the 10th harmonic of highest fundamental frequency.

Test Mode	IEEE 802.11ax HE40 / 5755 MHz	Temp/Hum	23.7(°C)/ 50%RH
Test Item	Harmonic	Test Date	May 22, 2023
Polarize	Vertical	Test Engineer	Ray Li
Detector	Peak & Average		

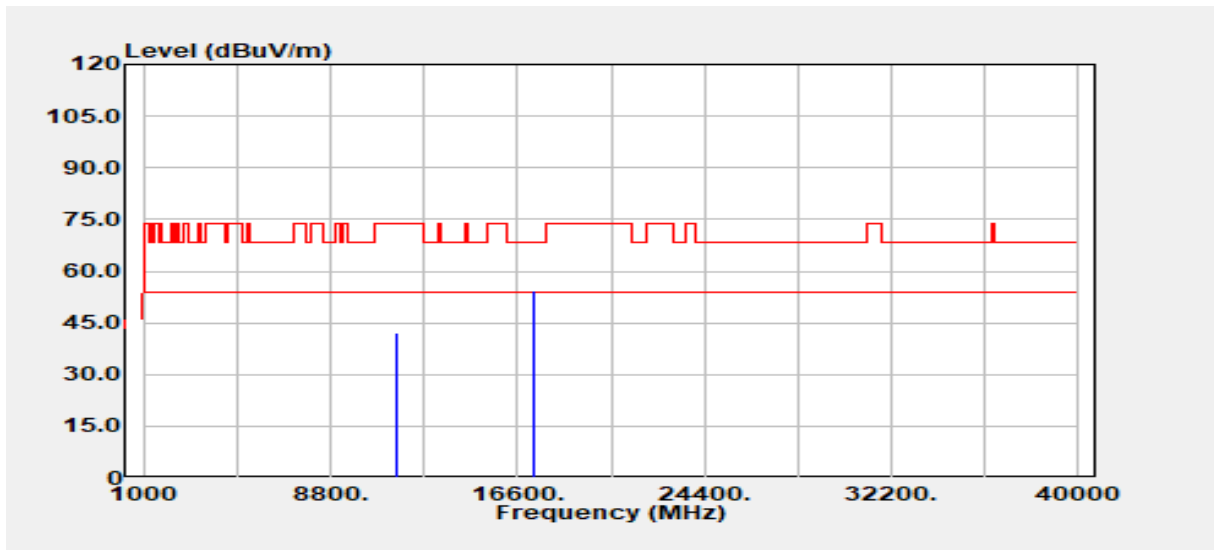

Freq. (MHz)	Detector Mode (PK/QP/AV)	Spectrum Reading Level (dBµV)	Factor (dB)	Actual FS (dBµV/m)	Limit @3m (dBµV/m)	Margin (dB)
11510.00	Peak	29.56	12.43	41.99	74.00	-32.01
11510.00	Average	23.50	12.43	35.93	54.00	-18.07
17265.00	Peak	28.19	26.14	54.33	68.20	-13.87
N/A						

Remark:

1. Measuring frequencies from 1 GHz to the 10th harmonic of highest fundamental frequency.

Test Mode	IEEE 802.11ax HE40 / 5755 MHz	Temp/Hum	23.7(°C)/ 50%RH
Test Item	Harmonic	Test Date	May 22, 2023
Polarize	Horizontal	Test Engineer	Ray Li
Detector	Peak & Average		

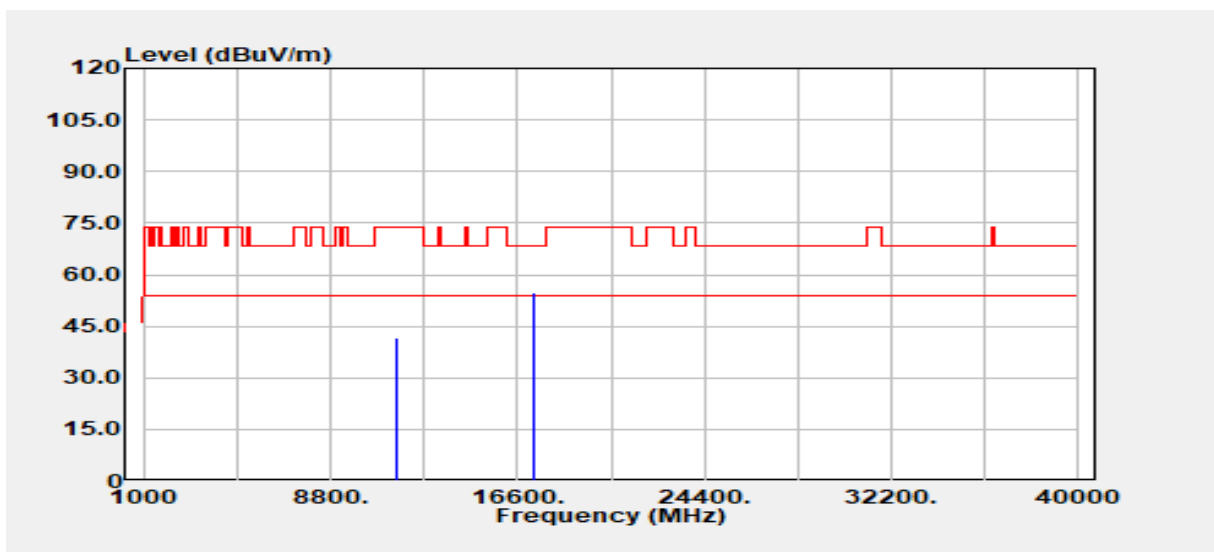

Freq. (MHz)	Detector Mode (PK/QP/AV)	Spectrum Reading Level (dBμV)	Factor (dB)	Actual FS (dBμV/m)	Limit @3m (dBμV/m)	Margin (dB)
11510.00	Peak	29.38	12.43	41.81	74.00	-32.19
11510.00	Average	23.44	12.43	35.86	54.00	-18.14
17265.00	Peak	28.47	26.14	54.61	68.20	-13.59
N/A						

Remark:

1. Measuring frequencies from 1 GHz to the 10th harmonic of highest fundamental frequency.

Test Mode	IEEE 802.11ax HE40 / 5795 MHz	Temp/Hum	23.7(°C)/ 50%RH
Test Item	Harmonic	Test Date	May 22, 2023
Polarize	Vertical	Test Engineer	Ray Li
Detector	Peak & Average		

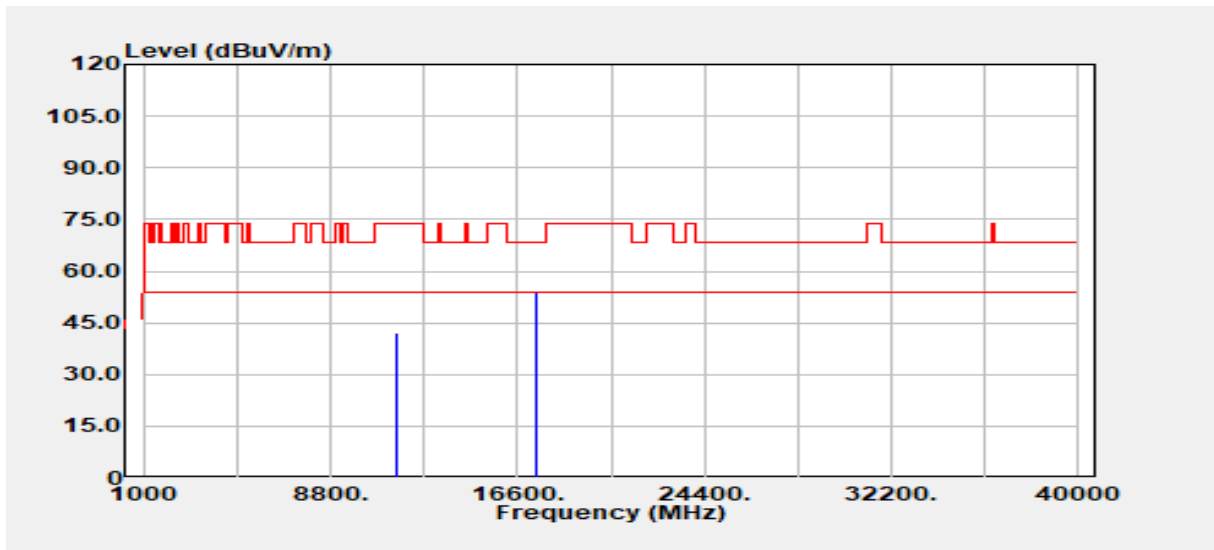

Freq. (MHz)	Detector Mode (PK/QP/AV)	Spectrum Reading Level (dBμV)	Factor (dB)	Actual FS (dBμV/m)	Limit @3m (dBμV/m)	Margin (dB)
11590.00	Peak	29.51	12.48	41.99	74.00	-32.01
11590.00	Average	23.49	12.48	35.97	54.00	-18.03
17385.00	Peak	28.53	25.27	53.79	68.20	-14.41
N/A						

Remark:

1. Measuring frequencies from 1 GHz to the 10th harmonic of highest fundamental frequency.

Test Mode	IEEE 802.11ax HE40 / 5795 MHz	Temp/Hum	23.7(°C)/ 50%RH
Test Item	Harmonic	Test Date	May 22, 2023
Polarize	Horizontal	Test Engineer	Ray Li
Detector	Peak & Average		

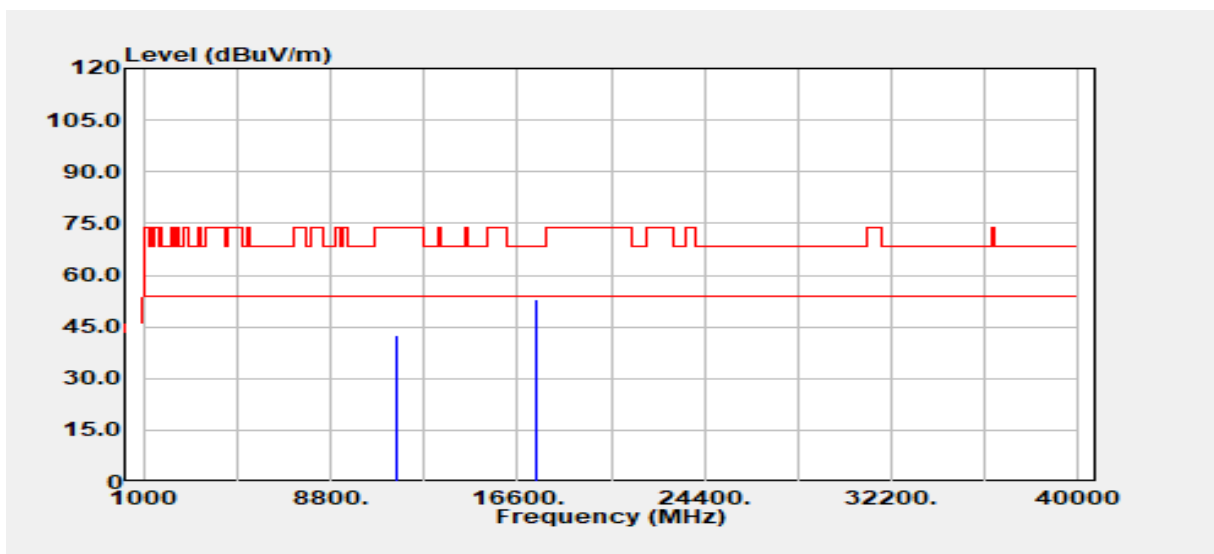

Freq. (MHz)	Detector Mode (PK/QP/AV)	Spectrum Reading Level (dBμV)	Factor (dB)	Actual FS (dBμV/m)	Limit @3m (dBμV/m)	Margin (dB)
11590.00	Peak	30.17	12.48	42.65	74.00	-31.35
11590.00	Average	23.49	12.48	35.97	54.00	-18.03
17385.00	Peak	27.90	25.27	53.17	68.20	-15.03
N/A						

Remark:

1. Measuring frequencies from 1 GHz to the 10th harmonic of highest fundamental frequency.

Test Mode	IEEE 802.11ax HE80 / 5775 MHz	Temp/Hum	23.7(°C)/ 50%RH
Test Item	Harmonic	Test Date	May 22, 2023
Polarize	Vertical	Test Engineer	Ray Li
Detector	Peak & Average		

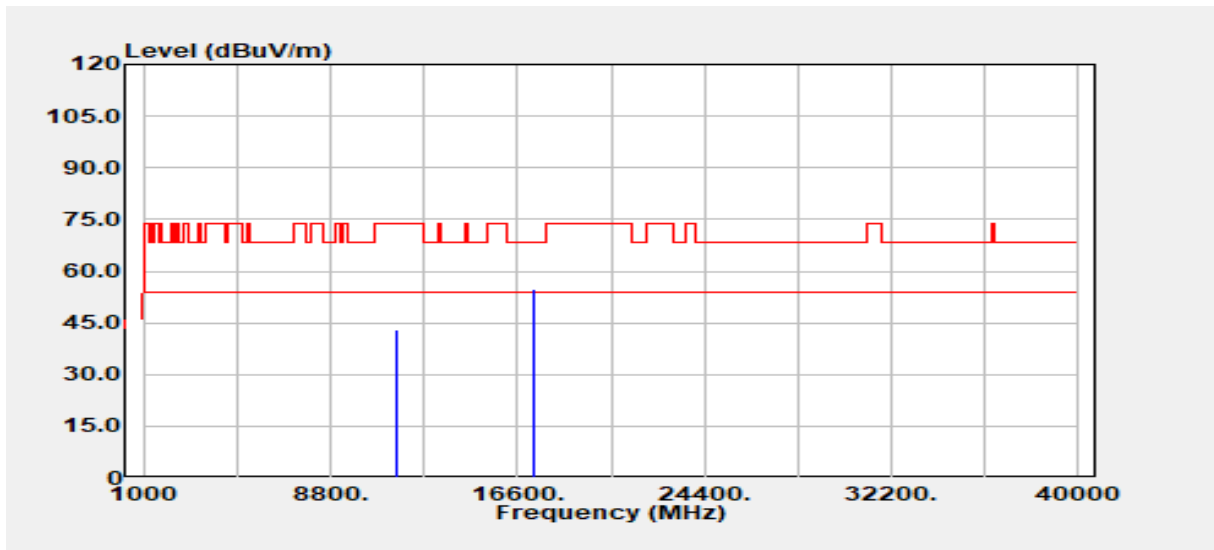

Freq. (MHz)	Detector Mode (PK/QP/AV)	Spectrum Reading Level (dBµV)	Factor (dB)	Actual FS (dBµV/m)	Limit @3m (dBµV/m)	Margin (dB)
11550.00	Peak	30.29	12.51	42.80	74.00	-31.20
11550.00	Average	23.31	12.51	35.81	54.00	-18.19
17325.00	Peak	29.11	25.79	54.90	68.20	-13.30
N/A						

Remark:

1. Measuring frequencies from 1 GHz to the 10th harmonic of highest fundamental frequency.

Test Mode	IEEE 802.11ax HE80 / 5775 MHz	Temp/Hum	23.7(°C)/ 50%RH
Test Item	Harmonic	Test Date	May 22, 2023
Polarize	Horizontal	Test Engineer	Ray Li
Detector	Peak & Average		

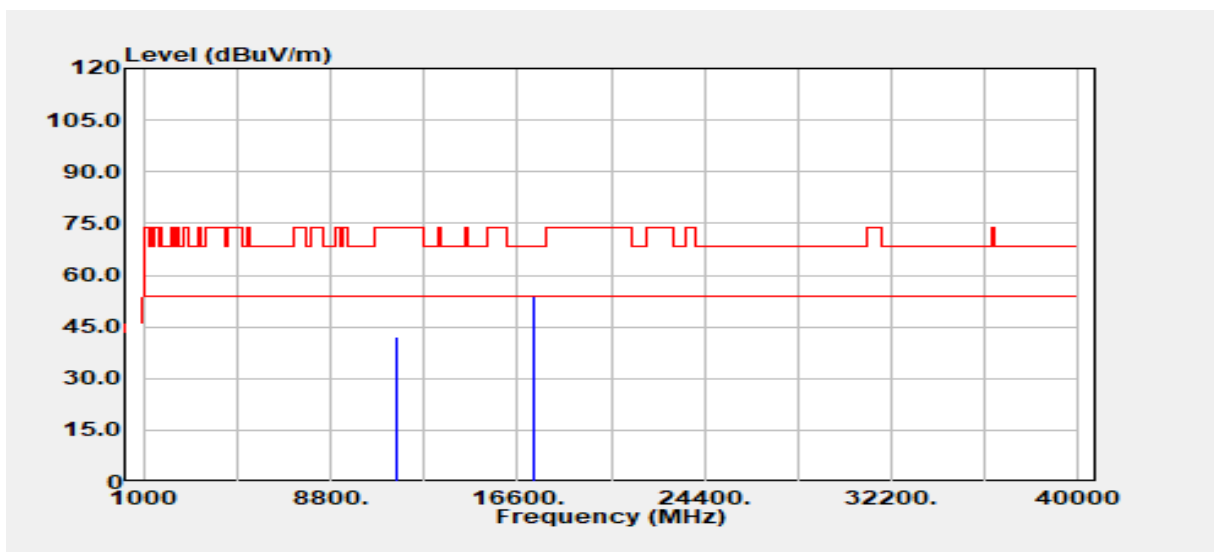

Freq. (MHz)	Detector Mode (PK/QP/AV)	Spectrum Reading Level (dBμV)	Factor (dB)	Actual FS (dBμV/m)	Limit @3m (dBμV/m)	Margin (dB)
11550.00	Peak	29.65	12.51	42.16	74.00	-31.84
11550.00	Average	23.35	12.51	35.85	54.00	-18.15
17325.00	Peak	28.31	25.79	54.10	68.20	-14.10
N/A						

Remark:

1. Measuring frequencies from 1 GHz to the 10th harmonic of highest fundamental frequency.

5. DYNAMIC FREQUENCY SELECTION FOR MASTER

TEST PROCEDURE

According to FCC 47 CFR Part 15 Subpart E (Section 15.407), KDB 905462 D02 UNII DFS Compliance Procedures New Rules v02, KDB 905462 D04 Operational Modes for DFS Testing New Rules v01 EUT is considered as a master device.

Table 1: Applicability of DFS Requirements Prior to Use of a Channel

Requirement	Operational Mode		
	Master	Client Without Radar Detection	Client With Radar Detection
Non-Occupancy Period	Yes	Not required	Yes
DFS Detection Threshold	Yes	Not required	Yes
Channel Availability Check Time	Yes	Not required	Not required
U-NII Detection Bandwidth	Yes	Not required	Yes

Table 2: Applicability of DFS requirements during normal operation

Requirement	Operational Mode	
	Master	Client Without Radar Detection
DFS Detection Threshold	Yes	Not required
Channel Closing Transmission Time	Yes	Yes
Channel Move Time	Yes	Yes
U-NII Detection Bandwidth	Yes	Not required

Additional requirements for devices with multiple bandwidth modes	Operational Mode	
	Master Device or Client With Radar Detection	Client Without Radar Detection
U-NII Detection Bandwidth and Statistical Performance Check	All BW modes must be tested	Not required
Channel Move Time and Channel Closing Transmission Time	Test using widest BW mode available	Test using the widest BW mode available for the link
All other tests	Any single BW mode	Not required

Note: Frequencies selected for statistical performance check (Section 7.8.4) should include several frequencies within the radar detection bandwidth and frequencies near the edge of the radar detection bandwidth. For 802.11 devices it is suggested to select frequencies in each of the bonded 20 MHz channels and the channel center frequency.

5.1 DFS DETECTION THRESHOLDS

Table 3 below provides the DFS Detection Thresholds for Master Devices as well as Client Devices incorporating In-Service Monitoring.

Table 3: DFS Detection Thresholds for Master Devices

Maximum Transmit Power	Value (see notes 1, 2, and 3)
EIRP \geq 200 milliwatt	-64 dBm
EIRP < 200 milliwatt and power spectral density < 10 dBm/MHz	-62 dBm
EIRP < 200 milliwatt that do not meet the power spectral density requirement	-64 dBm
<p>Note 1: This is the level at the input of the receiver assuming a 0 dBi receive antenna.</p> <p>Note 2: Throughout these test procedures an additional 1 dB has been added to the amplitude of the test transmission waveforms to account for variations in measurement equipment. This will ensure that the test signal is at or above the detection threshold level to trigger a DFS response.</p> <p>Note 3: EIRP is based on the highest antenna gain. For MIMO devices refer to KDB Publication 662911 D01.</p>	

5.2 DFS RESPONSE REQUIREMENT

Table 4 provides the response requirements for Master and Client Devices incorporating DFS.

Table 4: DFS Response Requirement Values

Parameter	Value
Non-occupancy period	Minimum 30 minutes
Channel Availability Check Time	60 seconds
Channel Move Time	10 seconds See Note 1.
Channel Closing Transmission Time	200 milliseconds + an aggregate of 60 milliseconds over remaining 10 second periods. See Notes 1 and 2.
U-NII Detection Bandwidth	Minimum 100% of the 99% power bandwidth See Note 3.
<p>Note 1: Channel Move Time and the Channel Closing Transmission Time should be performed with Radar Type 0. The measurement timing begins at the end of the Radar Type 0 burst.</p> <p>Note 2: The Channel Closing Transmission Time is comprised of 200 milliseconds starting at the beginning of the Channel Move Time plus any additional intermittent control signals required to facilitate Channel changes (an aggregate of 60 milliseconds) during the remainder of the 10 second period. The aggregate duration of control signals will not count quiet periods in between transmissions.</p> <p>Note 3: During the U-NII Detection Bandwidth detection test, radar type 0 is used and for each frequency step the minimum percentage of detection is 90%. Measurements are performed with no data traffic.</p>	

5.3 RADAR TEST WAVEFORMS

This section provides the parameters for required test waveforms, minimum percentage of successful detections, and the minimum number of trials that must be used for determining DFS conformance. Step intervals of 0.1 microsecond for Pulse Width, 1 microsecond for PRI, 1 MHz for chirp width and 1 for the number of pulses will be utilized for the random determination of specific test waveforms.

5.3.1 Short Pulse Radar Test Waveforms

Radar Type 0 was used in the evaluation of the Client device for the purpose of measuring the Channel Move Time and the Channel Closing Transmission Time.

Table 5 – Short Pulse Radar Test Waveforms

Radar Type	Pulse Width (µsec)	PRI (µsec)	Number of Pulses	Minimum Percentage of Successful Detection	Minimum Number of Trials
0	1	1428	18	See Note 1	
1	1	Test A	$Roundup\left\{\left(\frac{1}{360}\right) \cdot \left(\frac{19 \cdot 10^6}{PRI_{\mu sec}}\right)\right\}$	60%	30
		Test B			
2	1-5	150-230	23-29	60%	30
3	6-10	200-500	16-18	60%	30
4	11-20	200-500	12-16	60%	30
Aggregate (Radar Types 1-4)				80%	120

Note 1: Short Pulse Radar Type 0 should be used for the detection bandwidth test, channel move time, and channel closing time tests.

Test A: 15 unique PRI values randomly selected from the list of 23 PRI values in Table 5a

Test B: 15 unique PRI values randomly selected within the range of 518-3066 µsec, with a minimum increment of 1 µsec, excluding PRI values selected in Test A

A minimum of 30 unique waveforms are required for each of the Short Pulse Radar Types 2 through 4. If more than 30 waveforms are used for Short Pulse Radar Types 2 through 4, then each additional waveform must also be unique and not repeated from the previous waveforms.

If more than 30 waveforms are used for Short Pulse Radar Type 1, then each additional waveform is generated with Test B and must also be unique and not repeated from the previous waveforms in Tests A or B.

The aggregate is the average of the percentage of successful detections of short pulse radar types 1-4.

Table 5a - Pulse Repetition Intervals Values for Test A

Pulse Repetition Frequency Number	Pulse Repetition Frequency (Pulses Per Second)	Pulse Repetition Interval (Microseconds)
1	1930.5	518
2	1858.7	538
3	1792.1	558
4	1730.1	578
5	1672.2	598
6	1618.1	618
7	1567.4	638
8	1519.8	658
9	1474.9	678
10	1432.7	698
11	1392.8	718
12	1355	738
13	1319.3	758
14	1285.3	778
15	1253.1	798
16	1222.5	818
17	1193.3	838
18	1165.6	858
19	1139	878
20	1113.6	898
21	1089.3	918
22	1066.1	938
23	326.2	3066

5.3.2 Long Pulse Radar Test Waveform

Table 6 – Long Pulse Radar Test Waveforms

Radar Type	Pulse Width (µsec)	Chirp Width (MHz)	PRI (µsec)	Number of Pulses per Burst	Number of Bursts	Minimum Percentage of Successful Detection	Minimum Number of Trials
5	50-100	5-20	1000-2000	1-3	8-20	80%	30

The parameters for this waveform are randomly chosen. Thirty unique waveforms are required for the Long Pulse radar test signal. If more than 30 waveforms are used for the Long Pulse radar test signal, then each additional waveform must also be unique and not repeated from the previous waveforms.

Each waveform is defined as follows:

Note: The center frequency for each of the 30 trials of the Bin 5 radar shall be randomly selected within 80% of the Occupied Bandwidth.

- (1) The transmission period for the Long Pulse Radar test signal is 12 seconds.
- (2) There are a total of 8 to 20 Bursts in the 12 second period, with the number of Bursts being randomly chosen. This number is Burst_Count.
- (3) Each Burst consists of 1 to 3 pulses, with the number of pulses being randomly chosen. Each Burst within the 12 second sequence may have a different number of pulses.
- (4) The pulse width is between 50 and 100 microseconds, with the pulse width being randomly chosen. Each pulse within a Burst will have the same pulse width. Pulses in different Bursts may have different pulse widths.
- (5) Each pulse has a linear frequency modulated chirp between 5 and 20 MHz, with the chirp width being randomly chosen. Each pulse within a **transmission period** will have the same chirp width. The chirp is centered on the pulse. For example, with a radar frequency of 5300 MHz and a 20 MHz chirped signal, the chirp starts at 5290 MHz and ends at 5310 MHz
- (6) If more than one pulse is present in a Burst, the time between the pulses will be between 1000 and 2000 microseconds, with the time being randomly chosen. If three pulses are present in a Burst, the time between the first and second pulses is chosen independently of the time between the second and third pulses.
- (7) The 12 second transmission period is divided into even intervals. The number of intervals is equal to Burst_Count. Each interval is of length $(12,000,000 / \text{Burst_Count})$ microseconds. Each interval contains one Burst. The start time for the Burst, relative to the beginning of the interval, is between 1 and $[(12,000,000 / \text{Burst_Count}) - (\text{Total Burst Length}) + (\text{One Random PRI Interval})]$ microseconds, with the start time being randomly chosen. The step interval for the start time is 1 microsecond. The start time for each Burst is chosen independently.

A representative example of a Long Pulse radar test waveform:

- (1) The total test signal length is 12 seconds.
- (2) 8 Bursts are randomly generated for the Burst_Count.
- (3) Burst 1 has 2 randomly generated pulses.
- (4) The pulse width (for both pulses) is randomly selected to be 75 microseconds.
- (5) The PRI is randomly selected to be at 1213 microseconds.
- (6) Bursts 2 through 8 are generated using steps 3 – 5.
- (7) Each Burst is contained in even intervals of 1,500,000 microseconds. The starting location for Pulse 1, Burst 1 is randomly generated (1 to 1,500,000 minus the total Burst 1 length + 1 random PRI interval) at the 325,001 microsecond step. Bursts 2 through 8 randomly fall in successive 1,500,000 microsecond intervals (i.e. Burst 2 falls in the 1,500,001 – 3,000,000 microsecond range).

5.3.3 Frequency Hopping Radar Test Waveform

Table 7 – Frequency Hopping Radar Test Signal

Radar Type	Pulse Width (μsec)	PRI (μsec)	Pulses per Hop	Hopping Rate (kHz)	Hopping Sequence Length (msec)	Minimum Percentage of Successful Detection	Minimum Number of Trials
6	1	333	9	0.333	300	70%	30

For the Frequency Hopping Radar Type, the same Burst parameters are used for each waveform. The hopping sequence is different for each waveform and a 100-length segment is selected from the hopping sequence defined by the following algorithm:

The first frequency in a hopping sequence is selected randomly from the group of 475 integer frequencies from 5250 – 5724 MHz. Next, the frequency that was just chosen is removed from the group and a frequency is randomly selected from the remaining 474 frequencies in the group. This process continues until all 475 frequencies are chosen for the set. For selection of a random frequency, the frequencies remaining within the group are always treated as equally likely.

5.4 CALIBRATION SETUP AND DFS TEST SETUP CONFIGURATION

5.4.1 Radiated Test Setup Configuration

Radiated test setup up

The EUT is a U-NII Device operating in Master mode. The radar test signals are injected into the Master Device.

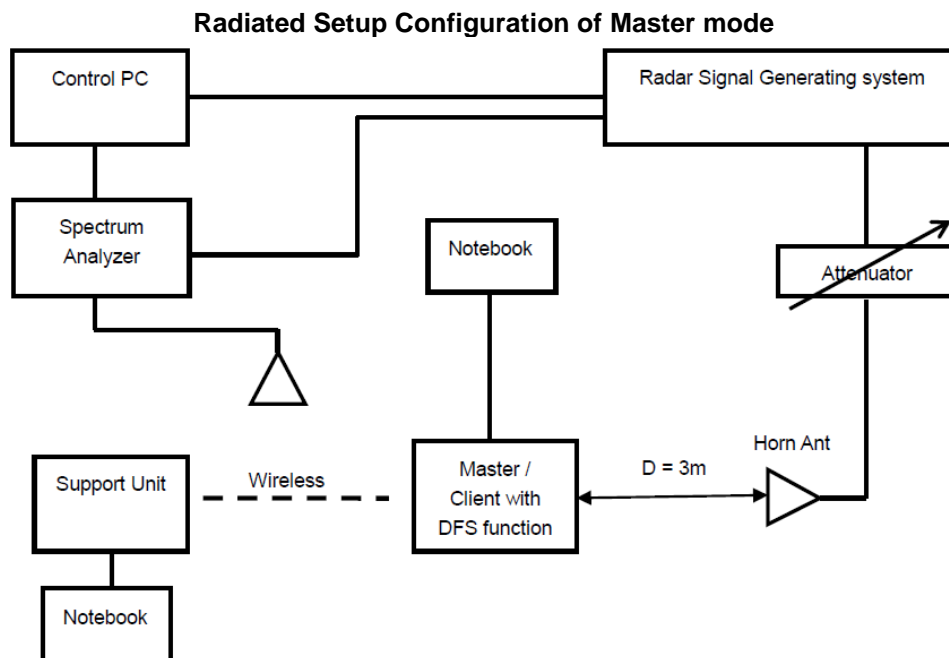

Conducted test setup up

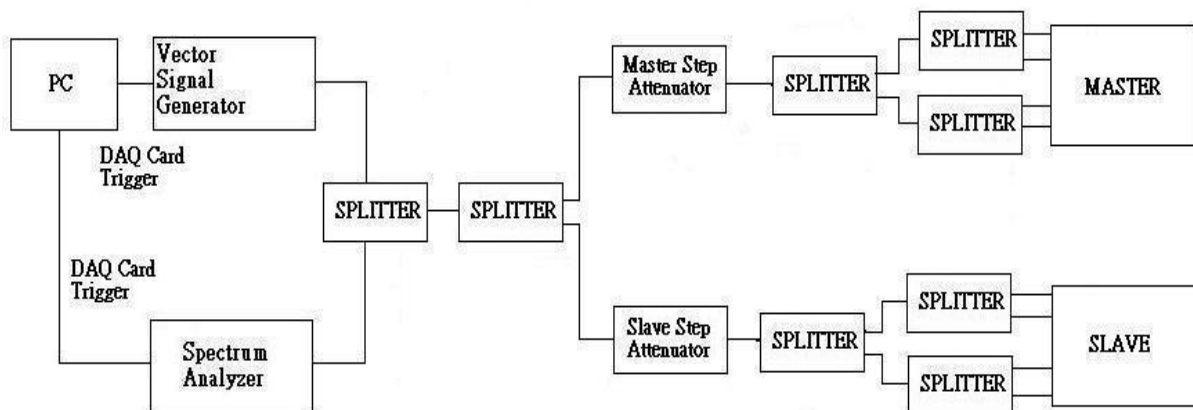

Channel Loading

System testing will be performed with channel-loading using means appropriate to the data types that are used by the unlicensed device. The following requirements apply:

<input type="checkbox"/>	(a) The data file must be of a type that is typical for the device (i.e., MPEG-2, MPEG-4, WAV, MP3, MP4, AVI, etc.) and must generally be transmitting in a streaming mode.
<input type="checkbox"/>	(b) Software to ping the client is permitted to simulate data transfer but must have random ping intervals.
<input checked="" type="checkbox"/>	(c) Timing plots are required with calculations demonstrating a minimum channel loading of approximately 17% or greater. For example, channel loading can be estimated by setting the spectrum analyzer for zero span and approximate the Time On/ (Time On + Off Time). This can be done with any appropriate channel BW and modulation type.
<input type="checkbox"/>	(d) Unicast or Multicast protocols are preferable but other protocols may be used. The appropriate protocol used must be described in the test procedures.

5.4.2 Calibration of Radar Waveform

The radar signal was the same as transmitted channels, and injected into the antenna of AP (master) or Client Device with Radar Detection, measured the channel closing transmission time and channel move time.

Radiated setup configuration of Calibration of DFS Detection Threshold Level

The calibrated conducted detection threshold level is set to -64dBm for radiation configuration or -64dBm + antenna gain for conducted configuration. The tested level is lower than required level hence it provides margin to the limit.

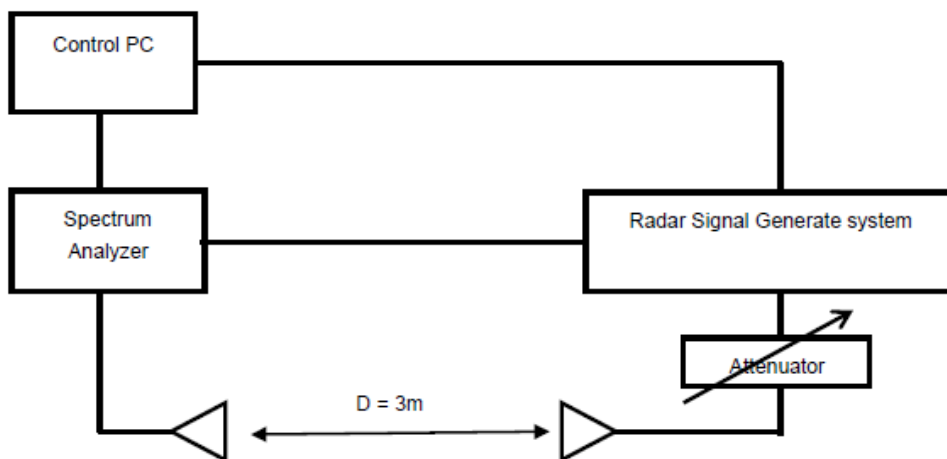

Report No.: TMWK2304001001KR

5.4.3 Radar Waveform Calibration Result

Temperature: 24~25.2°C

Test date: May 4~25, 2023

Humidity: 47~51% RH

Tested by: Jerry Chang

< Channel Bandwidth 20MHz / 5300MHz >

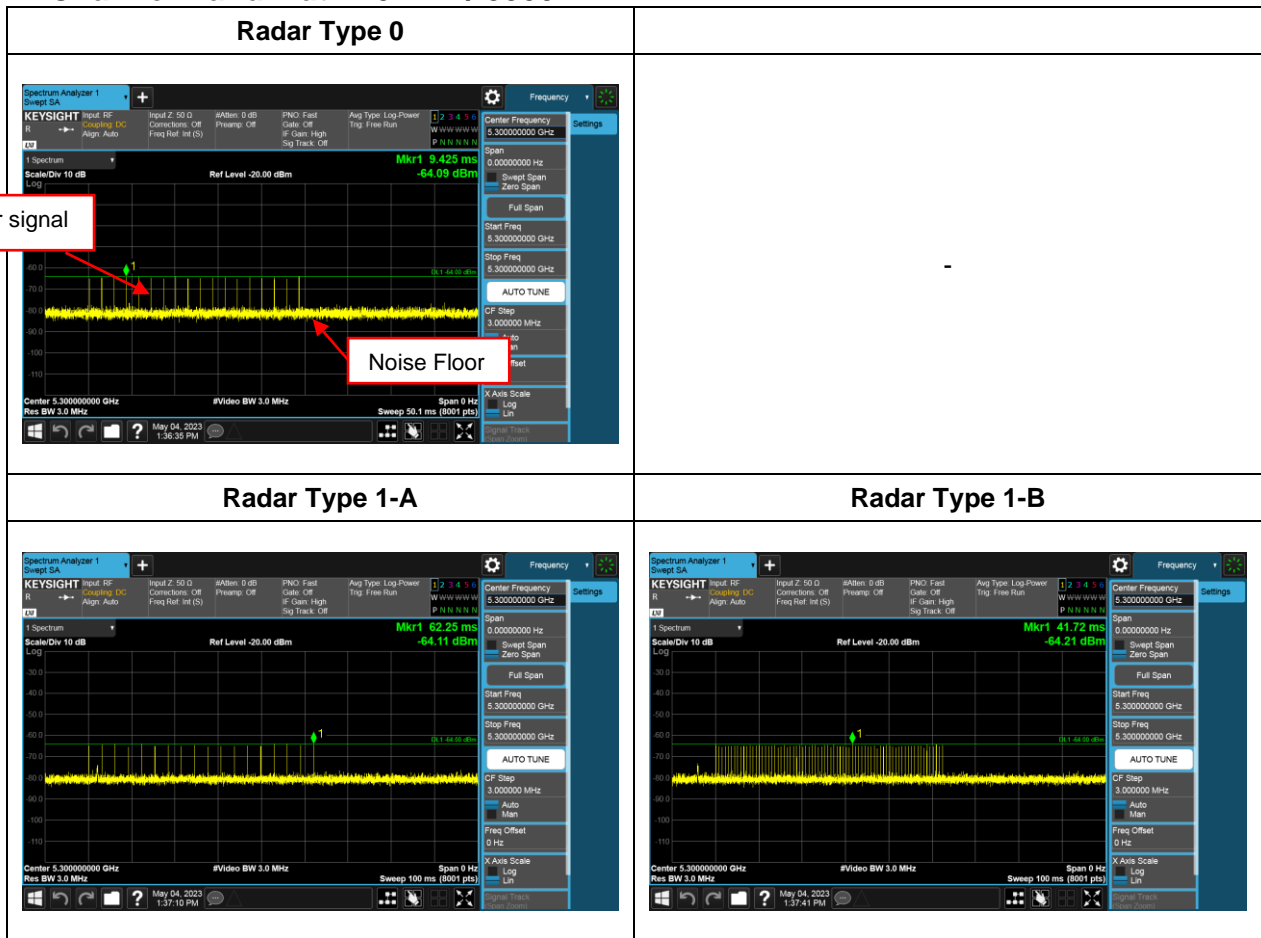

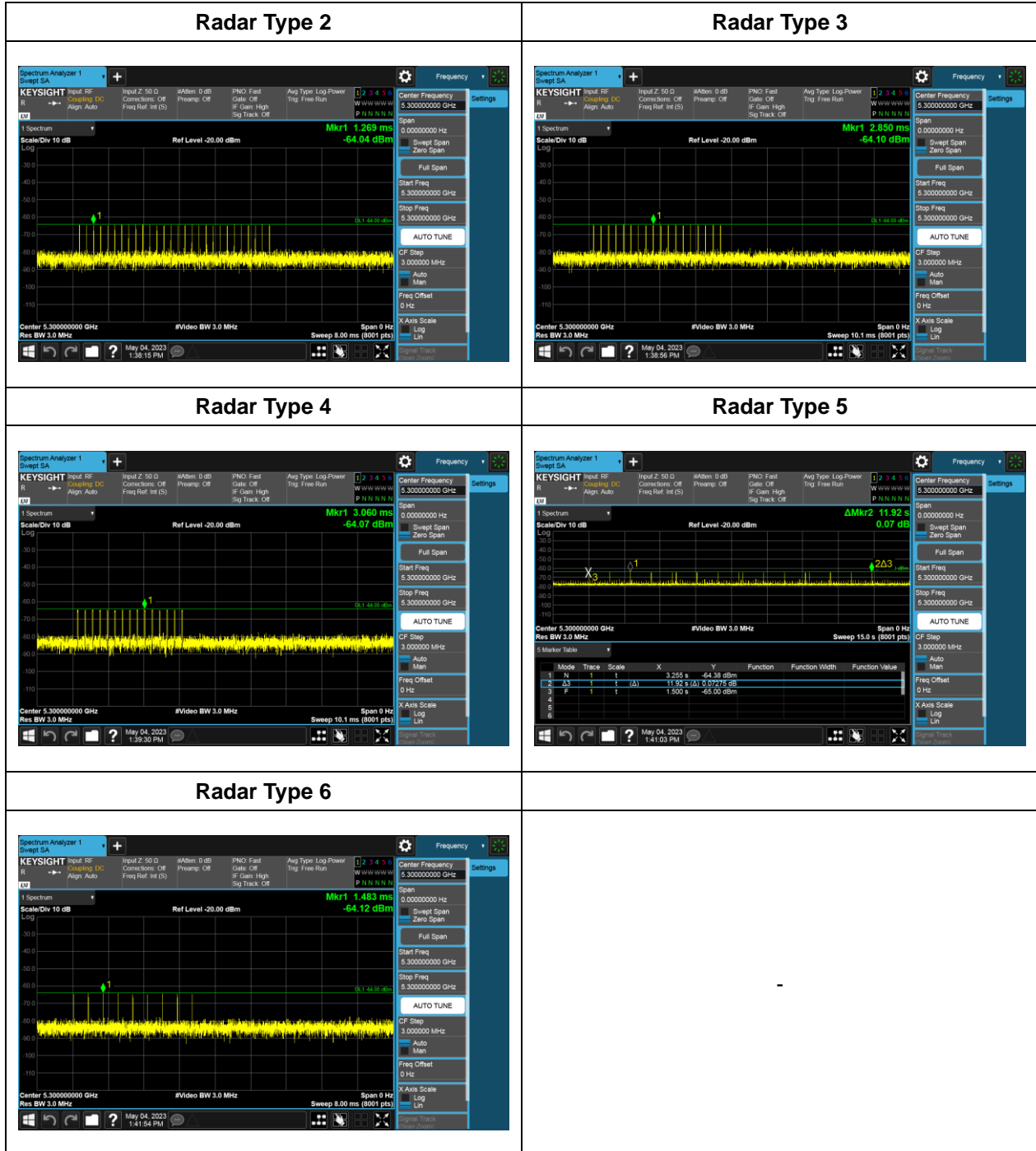

< Channel Bandwidth 40MHz / 5310MHz >

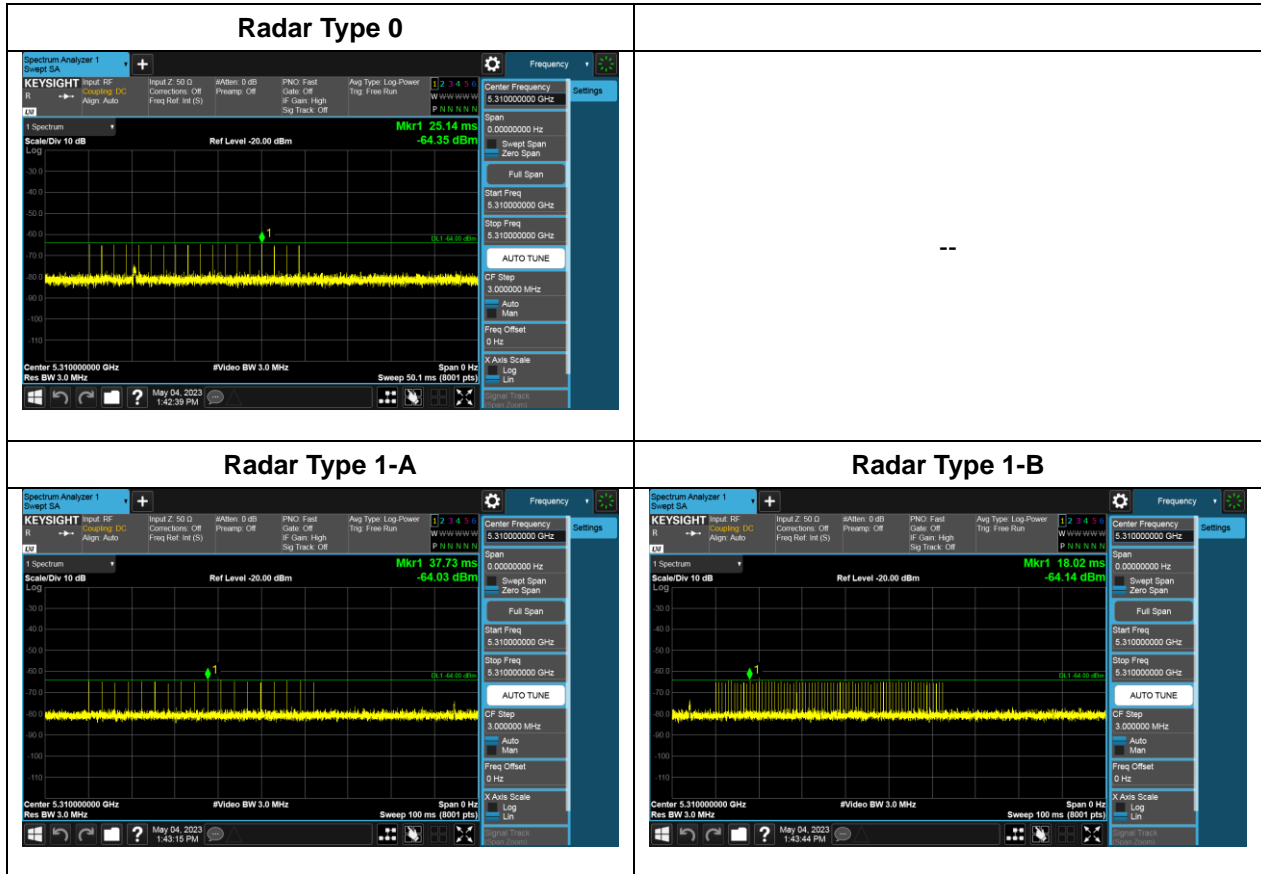

Report No.: TMWK2304001001KR

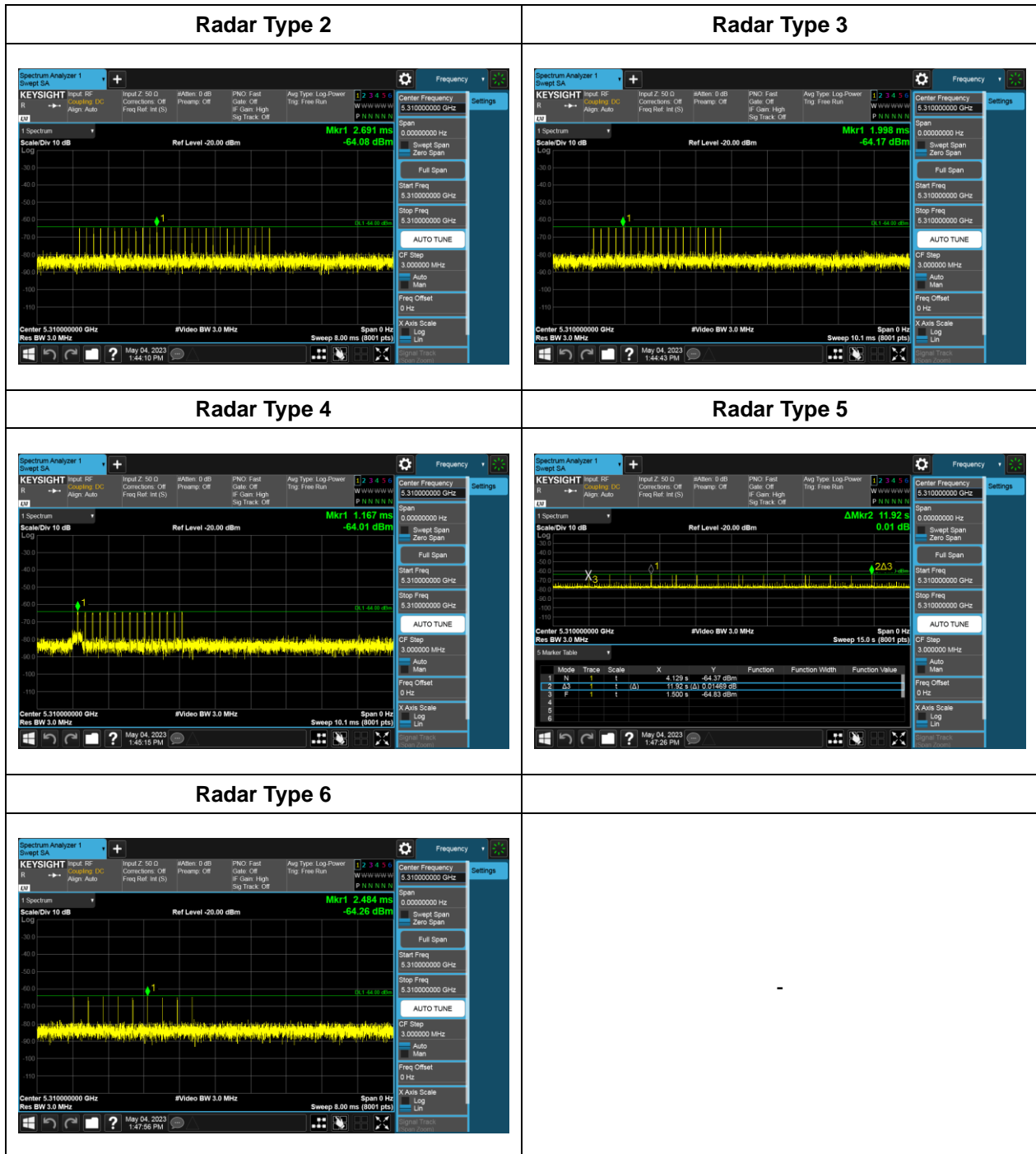

< Channel Bandwidth 80MHz / 5290MHz >

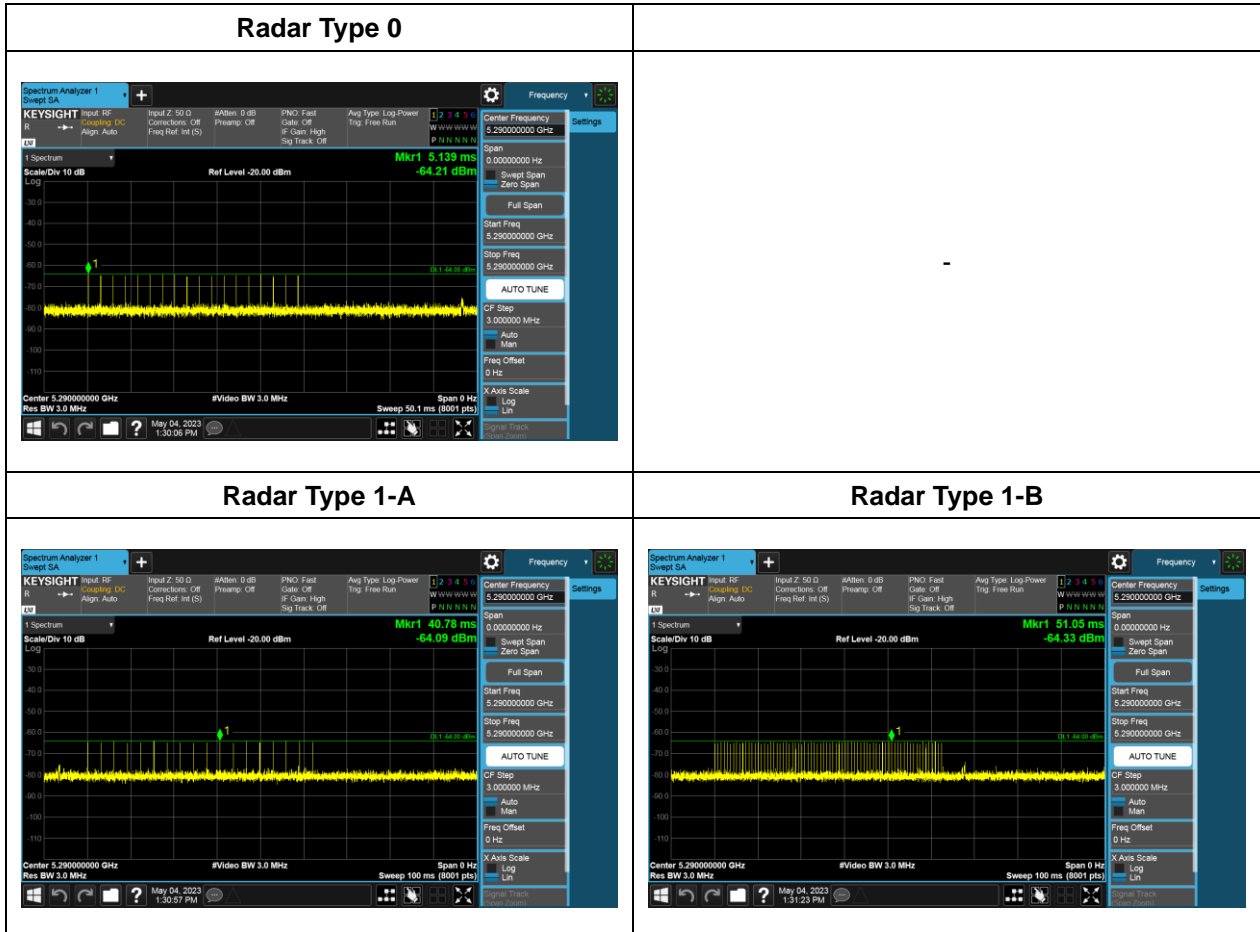

Radar Type 2

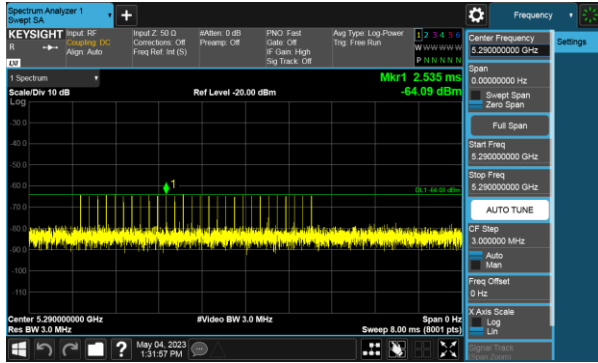

Radar Type 3

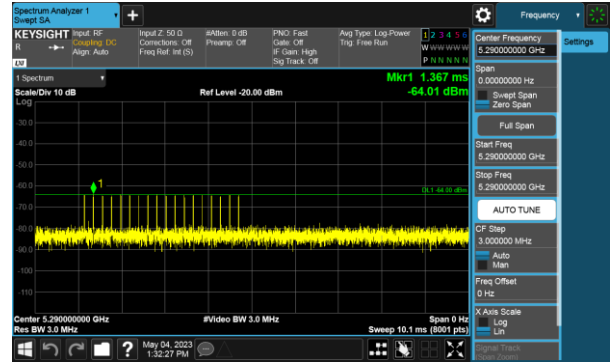

Radar Type 4

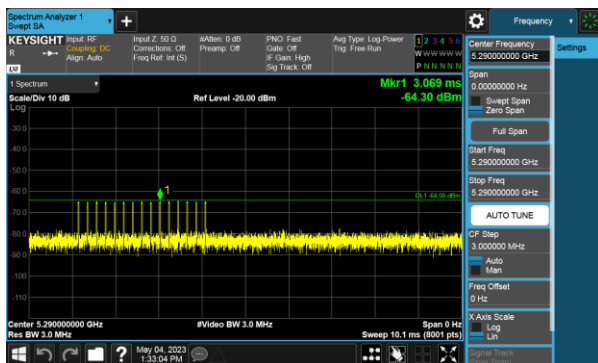

Radar Type 5

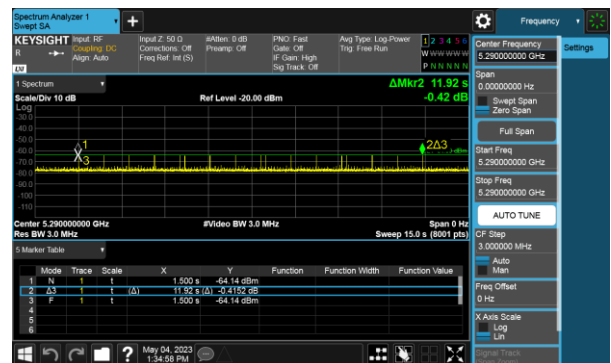

Radar Type 6

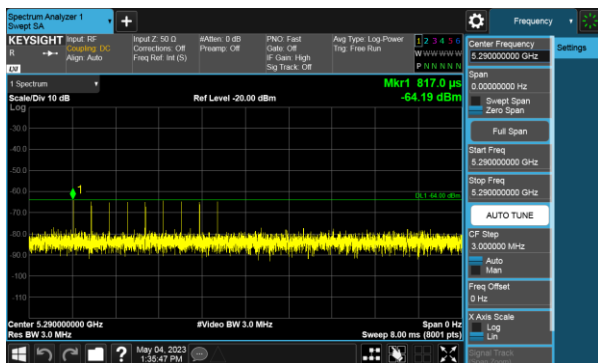

< Channel Bandwidth 20MHz / 5500MHz >

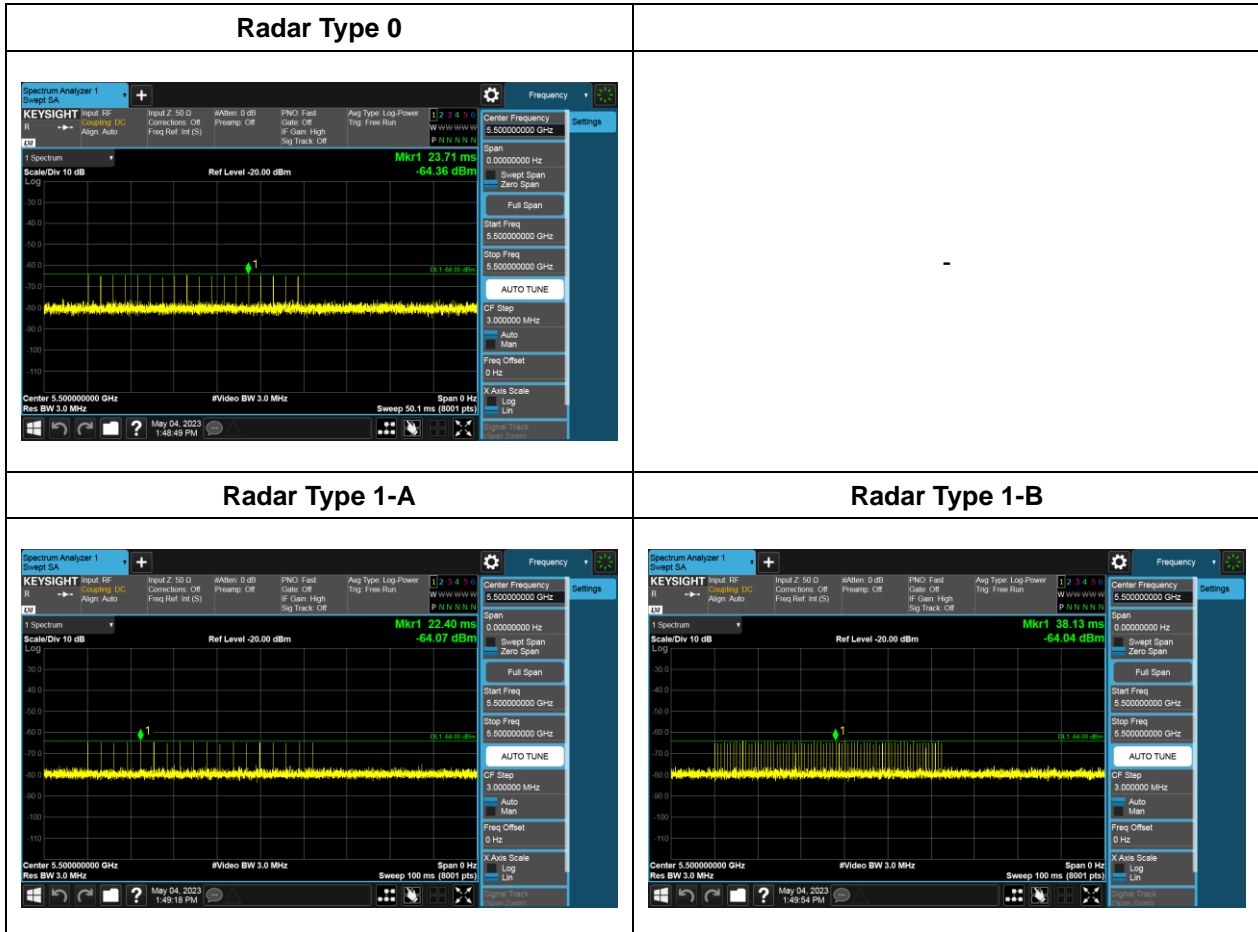

Radar Type 2

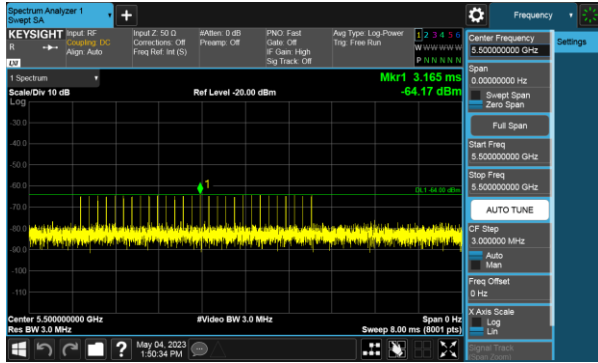

Radar Type 3

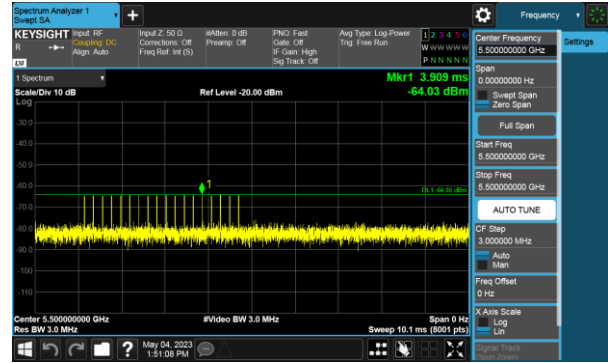

Radar Type 4

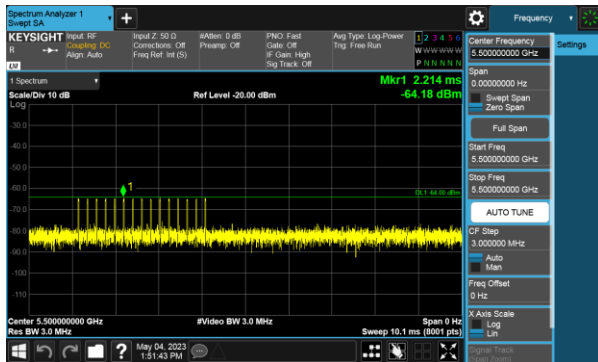

Radar Type 5



Radar Type 6

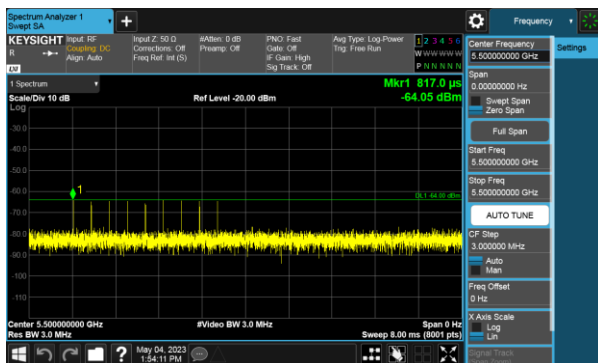

< Channel Bandwidth 40MHz / 5510MHz >

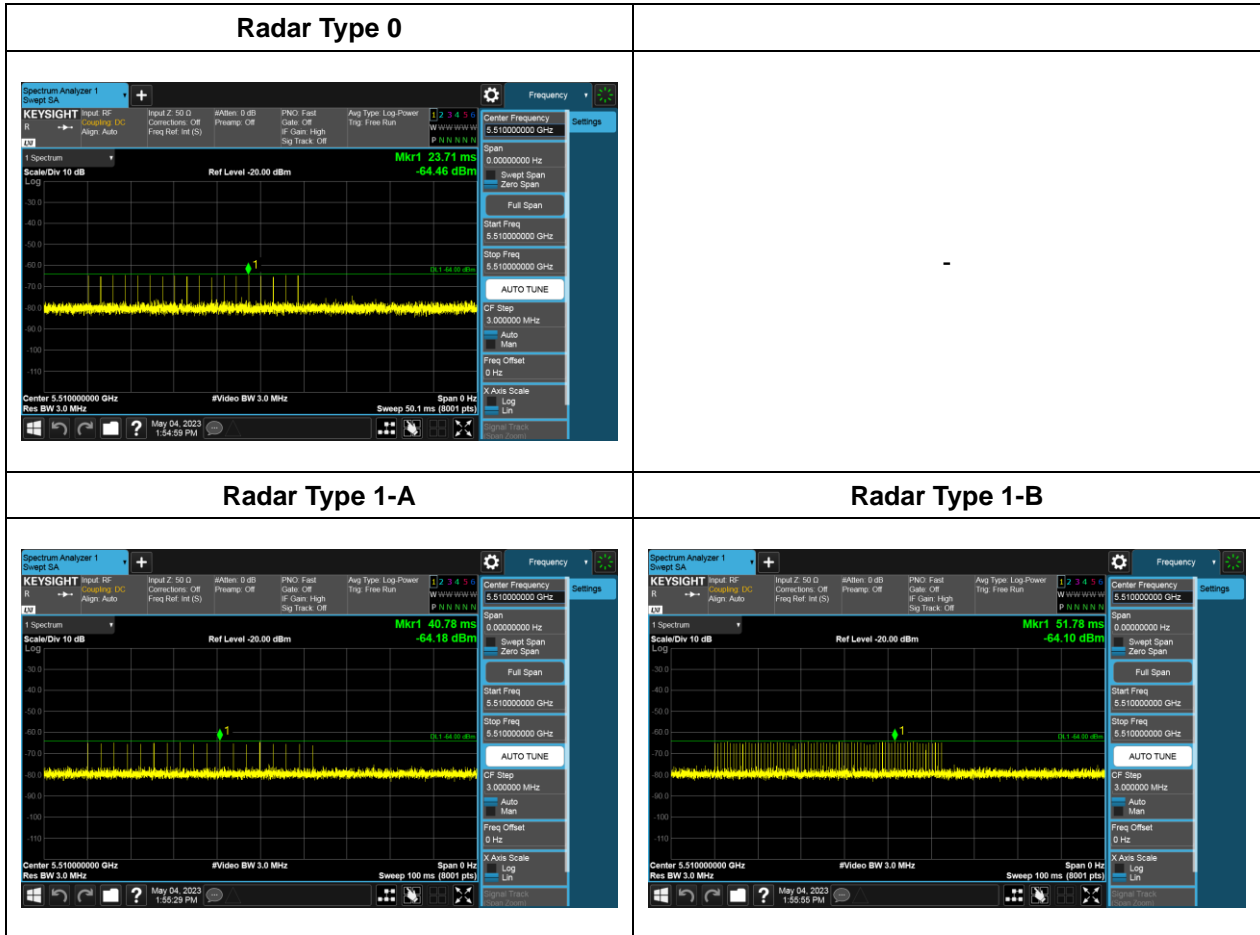

Report No.: TMWK2304001001KR

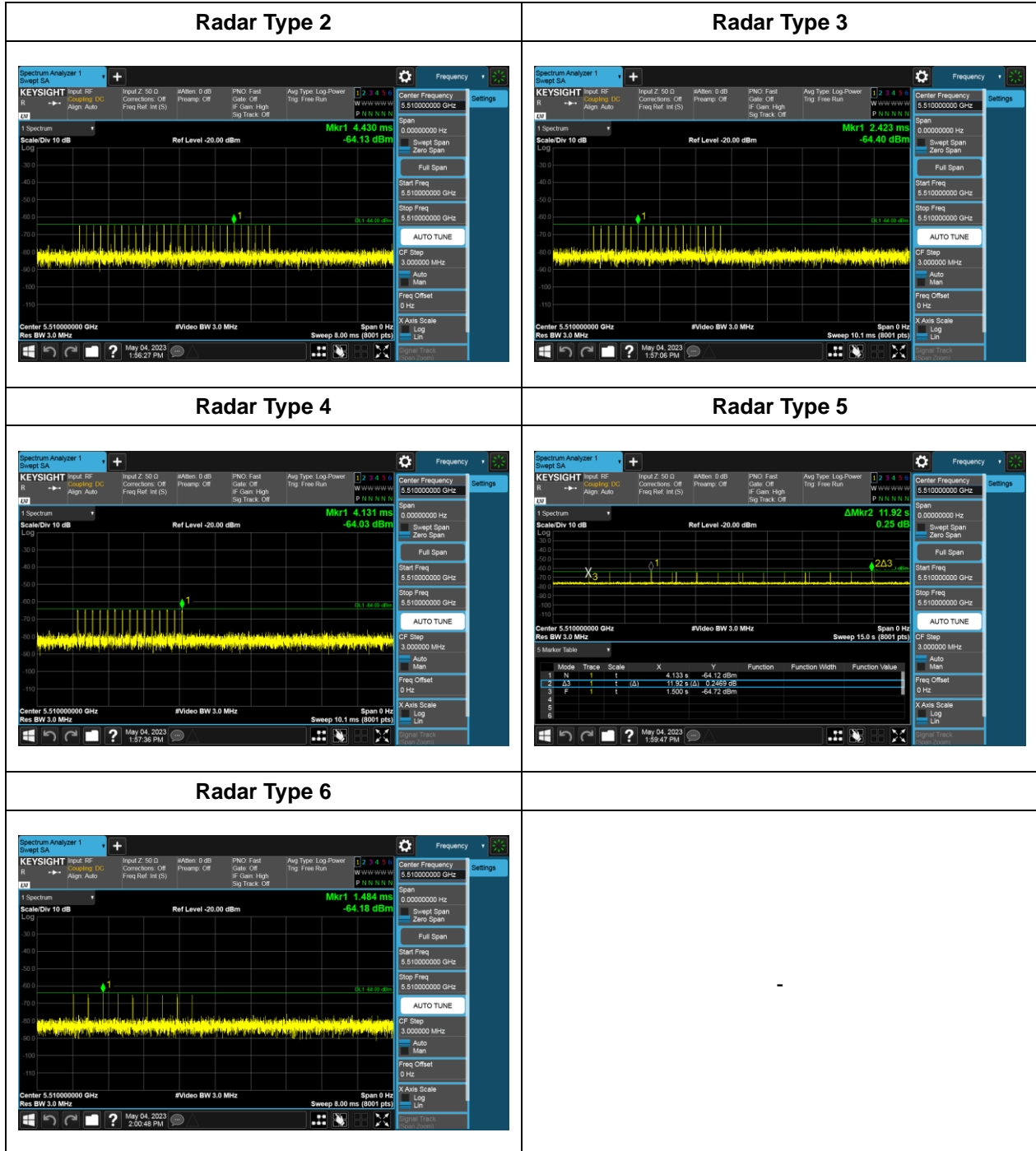

< Channel Bandwidth 80MHz / 5530MHz >

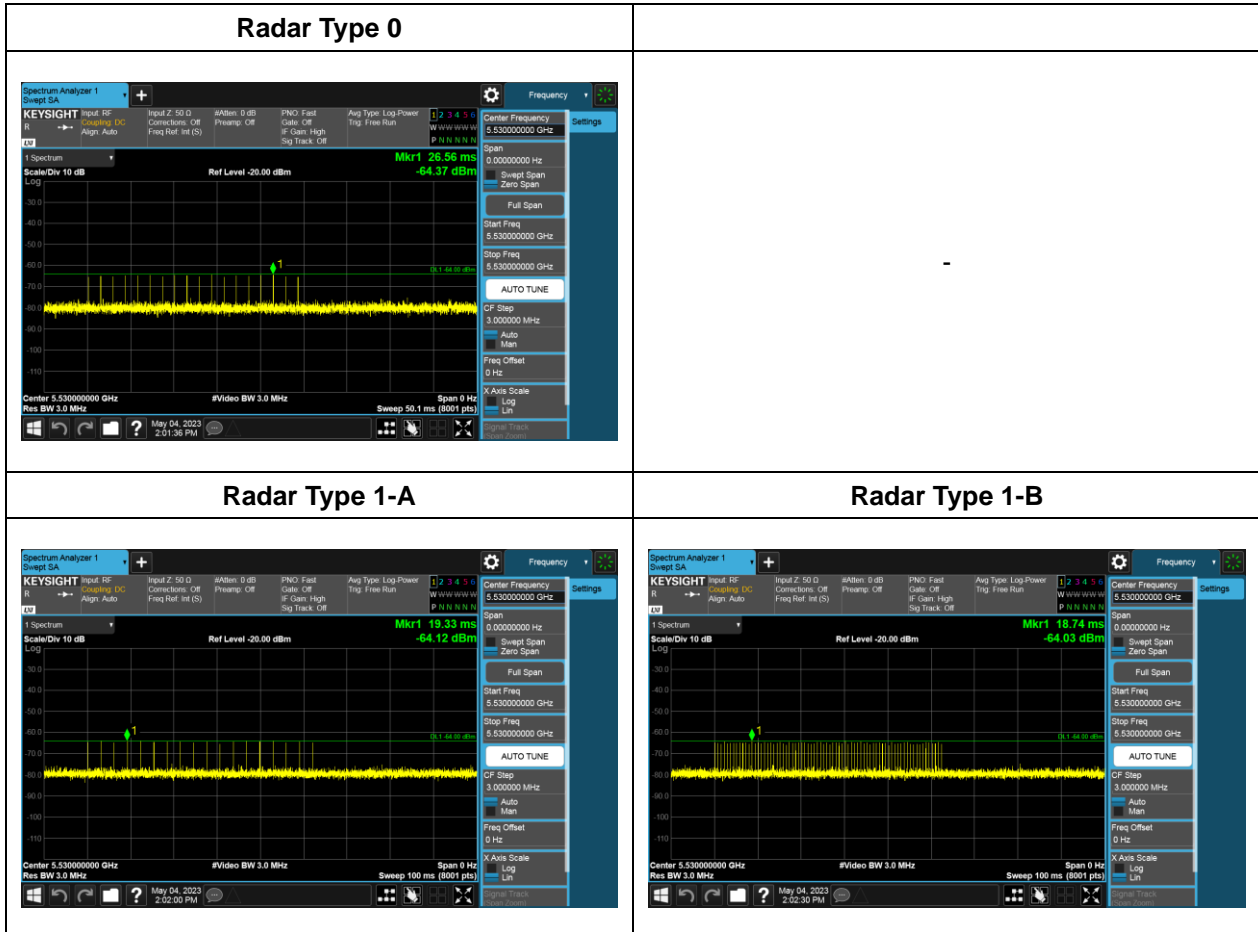

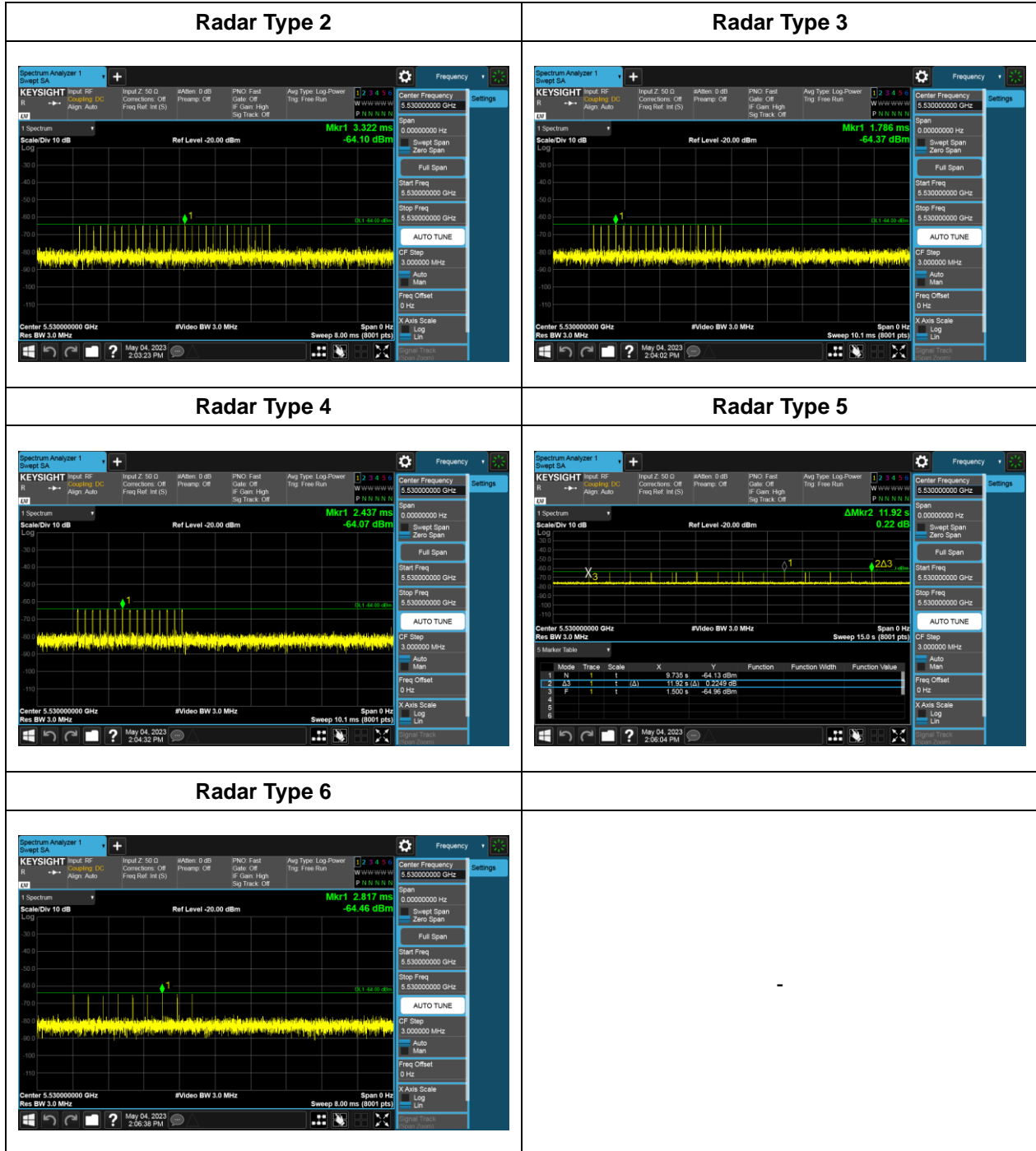

< Channel Bandwidth 160MHz / 5250MHz >

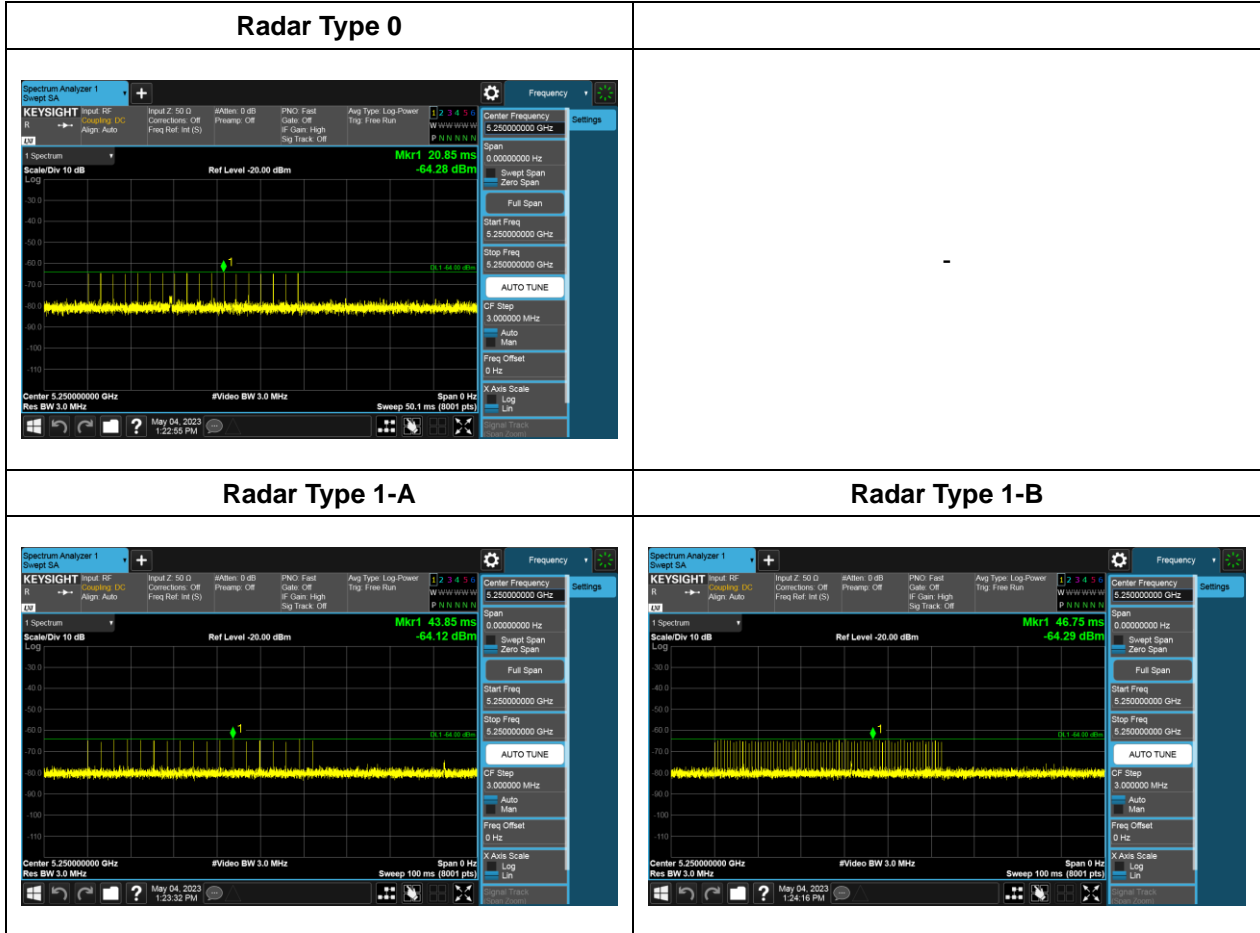

Report No.: TMWK2304001001KR

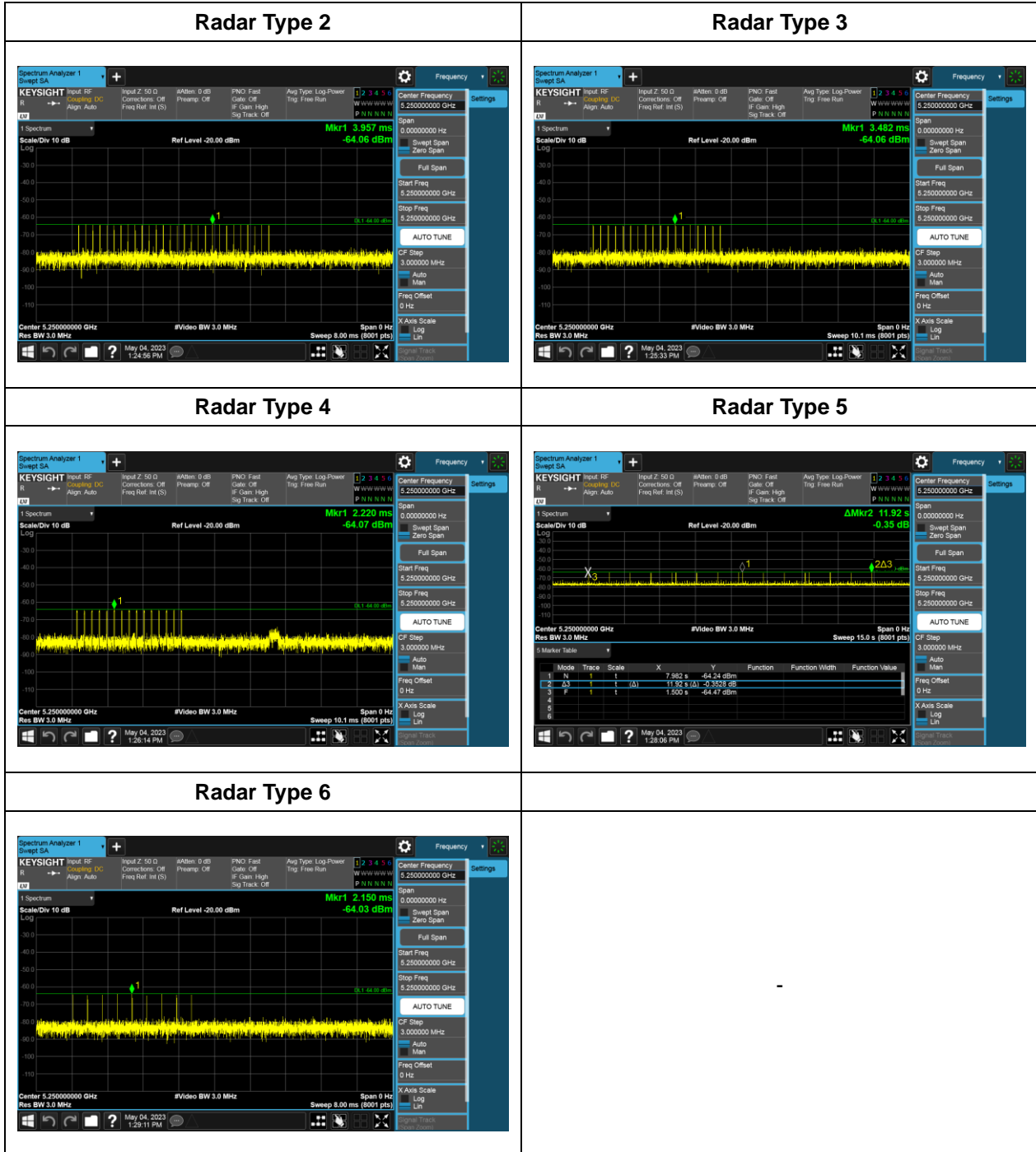

< Channel Bandwidth 160MHz / 5570MHz >

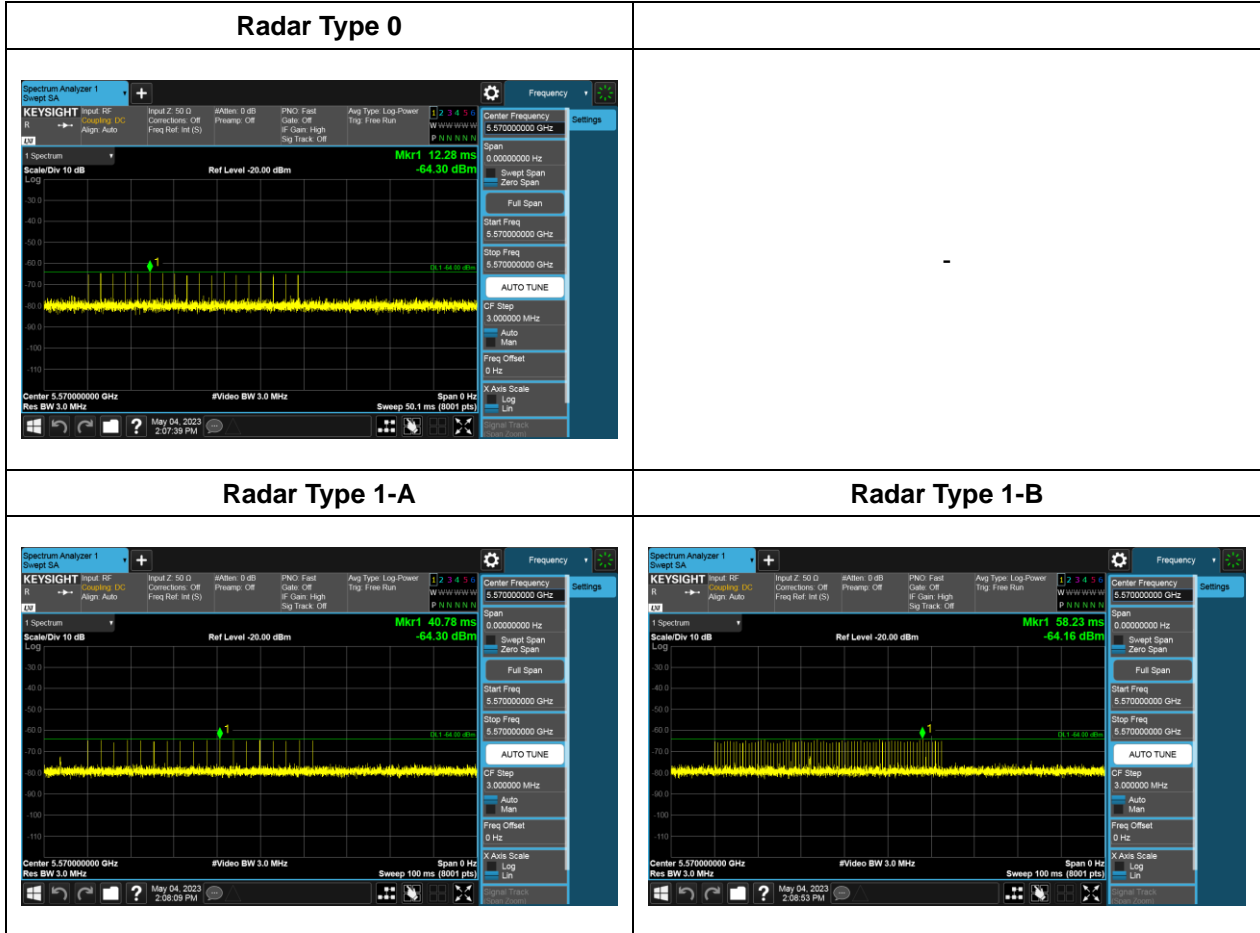

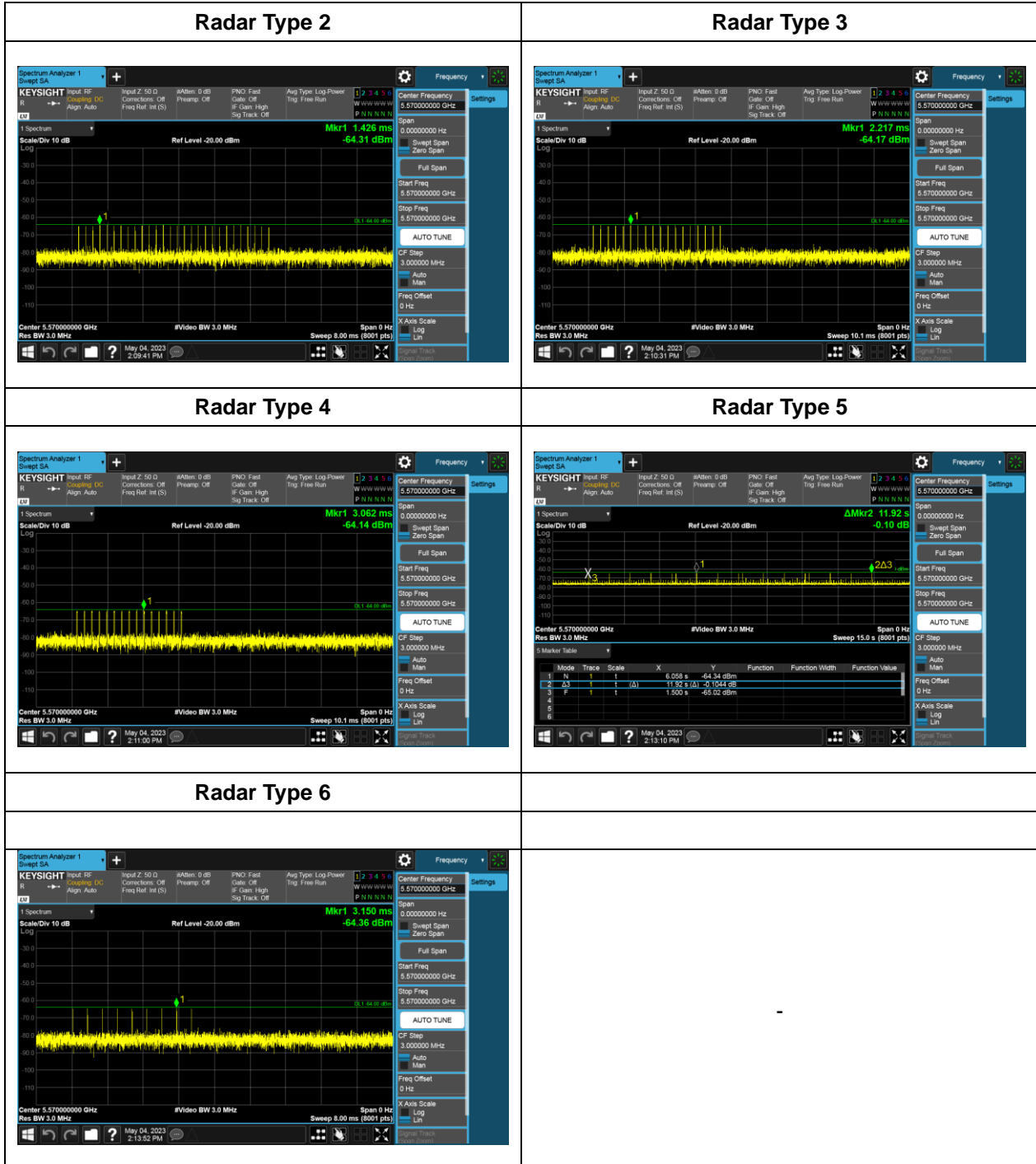

5.5 U-NII DETECTION BANDWIDTH (7.8.1)

5.5.1 Limit of U-NII Detection Bandwidth

The U-NII Detection Bandwidth shall contain minimum 100% of the 99% power bandwidth. During the U-NII Detection Bandwidth detection test, radar type 0 is used and for each frequency step the minimum percentage of detection is 90%. Measurements are performed with no data traffic.

5.5.2 Test Procedure

1. Adjust the equipment to produce a single burst of the Short Pulse Radar Type 0 at the center frequency of the EUT Operating Channel at the specified DFS Detection Threshold level.
2. Set the EUT up as a standalone device (no associated Client or Master, as appropriate) and no traffic. Frame based systems will be set to a talk/listen ratio reflecting the worst case (maximum) that is user configurable during this test.
3. Generate a single radar burst, and note the response of the EUT. Repeat for a minimum of 10 trials. The EUT must detect the Radar Waveform using the specified U-NII Detection Bandwidth criterion.
4. Starting at the center frequency of the EUT operating Channel, increase the radar frequency in 5 MHz steps, repeating the above test sequence, until the detection rate falls below the U-NII Detection Bandwidth criterion specified in report Table 4. Repeat this measurement in 1MHz steps at frequencies 5 MHz below where the detection rate begins to fall. Record the highest frequency (denote as F_H) at which detection is greater than or equal to the U-NII Detection Bandwidth criterion. Recording the detection rate at frequencies above F_H is not required to demonstrate compliance.
5. Starting at the center frequency of the EUT operating Channel, decrease the radar frequency in 5 MHz steps, repeating the above test sequence, until the detection rate falls below the U-NII Detection Bandwidth criterion specified in report Table 4. Repeat this measurement in 1MHz steps at frequencies 5 MHz above where the detection rate begins to fall. Record the lowest frequency (denote as F_L) at which detection is greater than or equal to the U-NII Detection Bandwidth criterion. Recording the detection rate at frequencies below F_L is not required to demonstrate compliance.
6. The U-NII Detection Bandwidth is calculated as follows:
U-NII Detection Bandwidth = $F_H - F_L$

5.5.3 Result of U-NII Detection Bandwidth

Channel Bandwidth 20MHz / 5300 MHz

EUT operating Frequency(MHz)	: 5300	EUT 99% Bandwidth(MHz)	: 19.099								
Radar Type	: Radar Type 0	Detction BW(MHz)	: 20								
Test Result	: Pass	※ FH: 5310	FL: 5290								
Radio Frequency (MHz)	DFS Detection Trials (1=Detection, 0= No Detection)										Detection Rate (%)
	1	2	3	4	5	6	7	8	9	10	
5290	1	1	1	1	1	1	1	1	1	1	100
5295	1	1	1	1	1	1	1	1	1	1	100
5300	1	1	1	1	1	1	1	1	1	1	100
5305	1	1	1	1	1	1	1	1	1	1	100
5310	1	1	1	1	1	1	1	1	1	1	100

Channel Bandwidth 20MHz / 5500 MHz

EUT operating Frequency(MHz)	: 5500	EUT 99% Bandwidth(MHz)	: 18.938								
Radar Type	: Type 0	Detction BW(MHz)	: 20								
Test Result	: Pass	※ FH: 5510	FL: 5490								
Radio Frequency (MHz)	DFS Detection Trials (1=Detection, 0= No Detection)										Detection Rate (%)
	1	2	3	4	5	6	7	8	9	10	
5490	1	1	1	1	1	1	1	1	1	1	100
5495	1	1	1	1	1	1	1	1	1	1	100
5500	1	1	1	1	1	1	1	1	1	1	100
5505	1	1	1	1	1	1	1	1	1	1	100
5510	1	1	1	1	1	1	1	1	1	1	100

Channel Bandwidth 40MHz / 5310 MHz

EUT operating Frequency(MHz)	: 5310	EUT 99% Bandwidth(MHz)	: 37.289								
Radar Type	: Radar Type 0	Detction BW(MHz)	: 40								
Test Result	: Pass	※ FH: 5330	FL: 5290								
Radio Frequency (MHz)	DFS Detection Trials (1=Detection, 0= No Detection)										Detection Rate (%)
	1	2	3	4	5	6	7	8	9	10	
5290	1	1	1	1	1	1	1	1	1	1	100
5295	1	1	1	1	1	1	1	1	1	1	100
5300	1	1	1	1	1	1	1	1	1	1	100
5305	1	1	1	1	1	1	1	1	1	1	100
5310	1	1	1	1	1	1	1	1	1	1	100
5315	1	1	1	1	1	1	1	1	1	1	100
5320	1	1	1	1	1	1	1	1	1	1	100
5325	1	1	1	1	1	1	1	1	1	1	100
5330	1	1	1	1	1	1	1	1	1	1	100

Channel Bandwidth 40MHz / 5510 MHz

EUT operating Frequency(MHz)	: 5510	EUT 99% Bandwidth(MHz)	: 37.341								
Radar Type	: Radar Type 0	Detction BW(MHz)	: 40								
Test Result	: Pass	※ FH: 5530	FL: 5490								
Radio Frequency (MHz)	DFS Detection Trials (1=Detection, 0= No Detection)										Detection Rate (%)
	1	2	3	4	5	6	7	8	9	10	
5490	1	1	1	1	1	1	1	1	1	1	100
5495	1	1	1	1	1	1	1	1	1	1	100
5500	1	1	1	1	1	1	1	1	1	1	100
5505	1	1	1	1	1	1	1	1	1	1	100
5510	1	1	1	1	1	1	1	1	1	1	100
5515	1	1	1	1	1	1	1	1	1	1	100
5520	1	1	1	1	1	1	1	1	1	1	100
5525	1	1	1	1	1	1	1	1	1	1	100
5530	1	1	1	1	1	1	1	1	1	1	100

Report No.: TMWK2304001001KR

Channel Bandwidth 80MHz / 5290 MHz

EUT operating Frequency(MHz)	: 5290	EUT 99% Bandwidth(MHz)	: 77.033								
Radar Type	: Radar Type 0	Detction BW(MHz)	: 80								
Test Result	: Pass	※ FH: 5330	FL: 5250								
Radio Frequency (MHz)	DFS Detection Trials (1=Detection, 0= No Detection)										Detection Rate (%)
	1	2	3	4	5	6	7	8	9	10	
5250	1	1	1	1	1	1	1	1	1	1	100
5255	1	1	1	1	1	1	1	1	1	1	100
5260	1	1	1	1	1	1	1	1	1	1	100
5265	1	1	1	1	1	1	1	1	1	1	100
5270	1	1	1	1	1	1	1	1	1	1	100
5275	1	1	1	1	1	1	1	1	1	1	100
5280	1	1	1	1	1	1	1	1	1	1	100
5285	1	1	1	1	1	1	1	1	1	1	100
5290	1	1	1	1	1	1	1	1	1	1	100
5295	1	1	1	1	1	1	1	1	1	1	100
5300	1	1	1	1	1	1	1	1	1	1	100
5305	1	1	1	1	1	1	1	1	1	1	100
5310	1	1	1	1	1	1	1	1	1	1	100
5315	1	1	1	1	1	1	1	1	1	1	100
5320	1	1	1	1	1	1	1	1	1	1	100
5325	1	1	1	1	1	1	1	1	1	1	100
5330	1	1	1	1	1	1	1	1	1	1	100

Channel Bandwidth 80MHz / 5530 MHz

EUT operating Frequency(MHz)	: 5530	EUT 99% Bandwidth(MHz)	: 77.648								
Radar Type	: Radar Type 0	Detction BW(MHz)	: 80								
Test Result	: Pass	※ FH: 5570	FL: 5490								
Radio Frequency (MHz)	DFS Detection Trials (1=Detection, 0= No Detection)										Detection Rate (%)
	1	2	3	4	5	6	7	8	9	10	
5490	1	1	1	1	1	1	1	1	1	1	100
5495	1	1	1	1	1	1	1	1	1	1	100
5500	1	1	1	1	1	1	1	1	1	1	100
5505	1	1	1	1	1	1	1	1	1	1	100
5510	1	1	1	1	1	1	1	1	1	1	100
5515	1	1	1	1	1	1	1	1	1	1	100
5520	1	1	1	1	1	1	1	1	1	1	100
5525	1	1	1	1	1	1	1	1	1	1	100
5530	1	1	1	1	1	1	1	1	1	1	100
5535	1	1	1	1	1	1	1	1	1	1	100
5540	1	1	1	1	1	1	1	1	1	1	100
5545	1	1	1	1	1	1	1	1	1	1	100
5550	1	1	1	1	1	1	1	1	1	1	100
5555	1	1	1	1	1	1	1	1	1	1	100
5560	1	1	1	1	1	1	1	1	1	1	100
5565	1	1	1	1	1	1	1	1	1	1	100
5570	1	1	1	1	1	1	1	1	1	1	100

Channel Bandwidth 160MHz / 5250 MHz

EUT operating Frequency(MHz)	: 5250	U-NII 2	: 78.161
Radar Type	: Radar Type 0	EUT 99% Bandwidth(MHz)	: 78.161
Test Result	: Pass	Detction BW(MHz)	: 80
		※ FH: 5330	FL: 5250

Radio Frequency (MHz)	DFS Detection Trials (1=Detection, 0= No Detection)										Detection Rate (%)
	1	2	3	4	5	6	7	8	9	10	
5250	1	1	1	1	1	1	1	1	1	1	100
5255	1	1	1	1	1	1	1	1	1	1	100
5260	1	1	1	1	1	1	1	1	1	1	100
5265	1	1	1	1	1	1	1	1	1	1	100
5270	1	1	1	1	1	1	1	1	1	1	100
5275	1	1	1	1	1	1	1	1	1	1	100
5280	1	1	1	1	1	1	1	1	1	1	100
5285	1	1	1	1	1	1	1	1	1	1	100
5290	1	1	1	1	1	1	1	1	1	1	100
5295	1	1	1	1	1	1	1	1	1	1	100
5300	1	1	1	1	1	1	1	1	1	1	100
5305	1	1	1	1	1	1	1	1	1	1	100
5310	1	1	1	1	1	1	1	1	1	1	100
5315	1	1	1	1	1	1	1	1	1	1	100
5320	1	1	1	1	1	1	1	1	1	1	100
5325	1	1	1	1	1	1	1	1	1	1	100
5330	1	1	1	1	1	1	1	1	1	1	100

Note:

(160MHz channel (5250MHz) straddle between 5150~5250 and 5250~5350MHz, the DFS ability is necessary in 5250~5350MHz, therefore DFS detection bandwidth start from 5250MHz for Channel Bandwidth 160 MHz mode.)

Channel Bandwidth 160MHz / 5570 MHz

EUT operating Frequency(MHz)	:	5570	EUT 99% Bandwidth(MHz)	:	154.701						
Radar Type	:	Radar Type 0	Detction BW(MHz)	:	160						
Test Result	:	Pass	※ FH: 5650	FL: 5490							
Radio Frequency (MHz)	DFS Detection Trials (1=Detection, 0= No Detection)										Detection Rate (%)
	1	2	3	4	5	6	7	8	9	10	
5490	1	1	1	1	1	1	1	1	1	1	100
5495	1	1	1	1	1	1	1	1	1	1	100
5500	1	1	1	1	1	1	1	1	1	1	100
5505	1	1	1	1	1	1	1	1	1	1	100
5510	1	1	1	1	1	1	1	1	1	1	100
5515	1	1	1	1	1	1	1	1	1	1	100
5520	1	1	1	1	1	1	1	1	1	1	100
5525	1	1	1	1	1	1	1	1	1	1	100
5530	1	1	1	1	1	1	1	1	1	1	100
5535	1	1	1	1	1	1	1	1	1	1	100
5540	1	1	1	1	1	1	1	1	1	1	100
5545	1	1	1	1	1	1	1	1	1	1	100
5550	1	1	1	1	1	1	1	1	1	1	100
5555	1	1	1	1	1	1	1	1	1	1	100
5560	1	1	1	1	1	1	1	1	1	1	100
5565	1	1	1	1	1	1	1	1	1	1	100
5570	1	1	1	1	1	1	1	1	1	1	100
5575	1	1	1	1	1	1	1	1	1	1	100
5580	1	1	1	1	1	1	1	1	1	1	100
5585	1	1	1	1	1	1	1	1	1	1	100
5590	1	1	1	1	1	1	1	1	1	1	100
5595	1	1	1	1	1	1	1	1	1	1	100
5600	1	1	1	1	1	1	1	1	1	1	100
5605	1	1	1	1	1	1	1	1	1	1	100
5610	1	1	1	1	1	1	1	1	1	1	100
5615	1	1	1	1	1	1	1	1	1	1	100
5620	1	1	1	1	1	1	1	1	1	1	100
5625	1	1	1	1	1	1	1	1	1	1	100
5630	1	1	1	1	1	1	1	1	1	1	100
5635	1	1	1	1	1	1	1	1	1	1	100
5640	1	1	1	1	1	1	1	1	1	1	100
5645	1	1	1	1	1	1	1	1	1	1	100
5650	1	1	1	1	1	1	1	1	1	1	100

5.6 CHANNEL AVAILABILITY CHECK (7.8.2)

5.6.1 Limit of Channel Availability Check

The Initial Channel Availability Check Time tests that the EUT does not emit beacon, control, or data signals on the test Channel until the power-up sequence has been completed and the U-NII device checks for Radar Waveforms for **one minute** on the test Channel.

5.6.2 Test Procedure

5.6.2.1 Initial Channel Availability Check Time

This test does not use any radar waveforms and only needs to be performed one time.

1. The U-NII devices will be powered on and be instructed to operate on the appropriate U-NII Channel that must incorporate DFS functions. At the same time the EUT is powered on, the spectrum analyzer will be set to zero span modes with a 3 MHz RBW and 3 MHz VBW on the Channel occupied by the radar (Ch_r) with a 2.5 minute sweep time. The spectrum analyzer's sweep will be started at the same time power is applied to the U-NII device.
2. The EUT should not transmit any beacon or data transmissions until at least 1 minute after the completion of the power-on cycle

5.6.2.2 Radar Burst at the Beginning of the Channel Availability Check Time

The steps below define the procedure to verify successful radar detection on the test Channel during a period equal to the Channel Availability Check Time and avoidance of operation on that Channel when a radar Burst with a level equal to the DFS Detection Threshold + 1 dB occurs at the beginning of the Channel Availability Check Time. This is illustrated in Figure 15.

1. The Radar Waveform generator and EUT are connected using the applicable test setup and the power of the EUT is switched off.
2. The EUT is powered on at T_0 . T_1 denotes the instant when the EUT has completed its power-up sequence (T_{power_up}). The Channel Availability Check Time commences on Ch_r at instant T_1 and will end no sooner than $T_1 + Tch_avail_check$.
3. A single Burst of one of the Short Pulse Radar Types 0-4 will commence within a 6 second window starting at T_1 . An additional 1 dB is added to the radar test signal to ensure it is at or above the DFS Detection Threshold, accounting for equipment variations/errors.
4. Visual indication or measured results on the EUT of successful detection of the radar Burst will be recorded and reported. Observation of Ch_r for EUT emissions will continue for 2.5 minutes after the radar Burst has been generated.
5. Verify that during the 2.5 minute measurement window no EUT transmissions occurred on Ch_r . The Channel Availability Check results will be recorded.

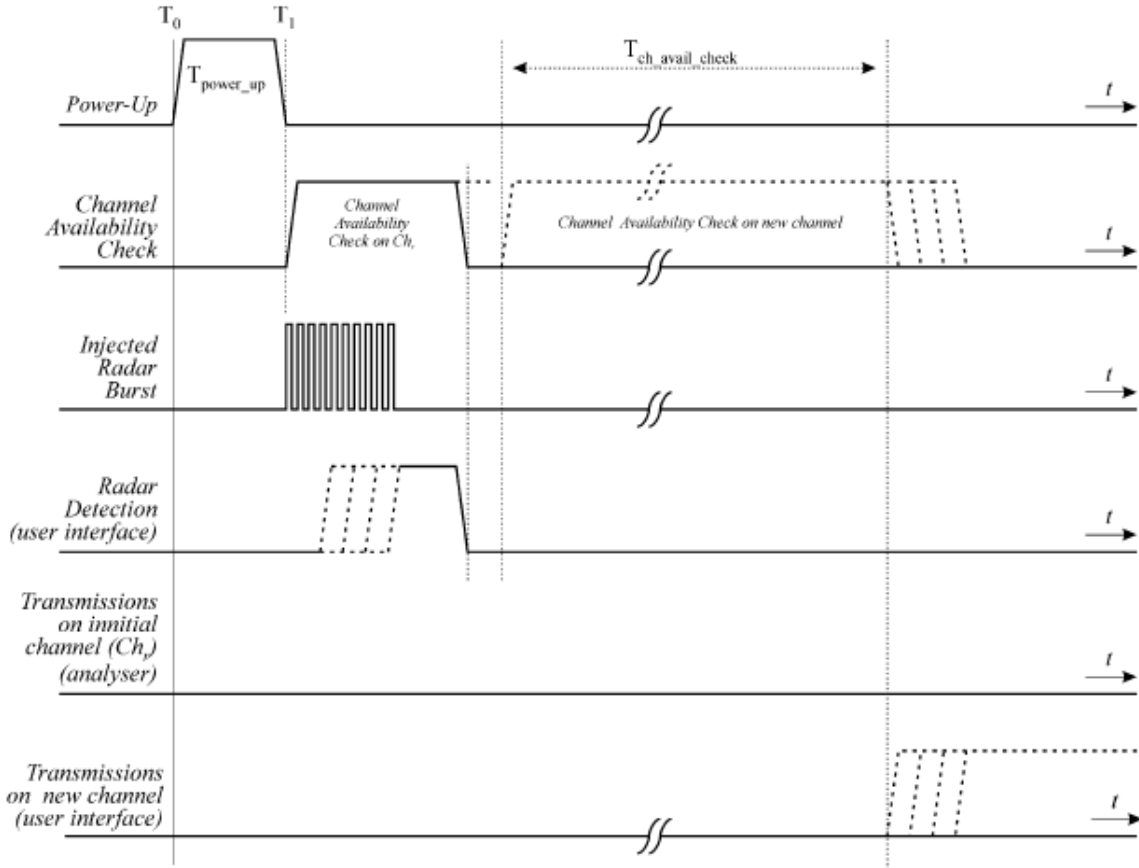

Figure 15: Example of timing for radar testing at the beginning of the Channel Availability Check Time

5.6.2.3 Radar Burst at the End of the Channel Availability Check Time

The steps below define the procedure to verify successful radar detection on the test Channel during a period equal to the Channel Availability Check Time and avoidance of operation on that Channel when a radar Burst with a level equal to the DFS Detection Threshold + 1dB occurs at the end of the Channel Availability Check Time. This is illustrated in Figure 16.

1. The Radar Waveform generator and EUT are connected using the applicable test setup and the power of the EUT is switched off.
2. The EUT is powered on at T_0 . T_1 denotes the instant when the EUT has completed its power-up sequence (T_{power_up}). The Channel Availability Check Time commences on Chr at instant T_1 and will end no sooner than $T_1 + T_{ch_avail_check}$.
3. A single Burst of one of the Short Pulse Radar Types 1-4 will commence within a 6 second window starting at $T_1 + 54$ seconds. An additional 1 dB is added to the radar test signal to ensure it is at or above the DFS Detection Threshold, accounting for equipment variations/errors.
4. Visual indication or measured results on the EUT of successful detection of the radar Burst will be recorded and reported. Observation of Chr for EUT emissions will continue for 2.5 minutes after the radar Burst has been generated.
5. Verify that during the 2.5 minute measurement window no EUT transmissions occurred on Chr. The Channel Availability Check results will be recorded.

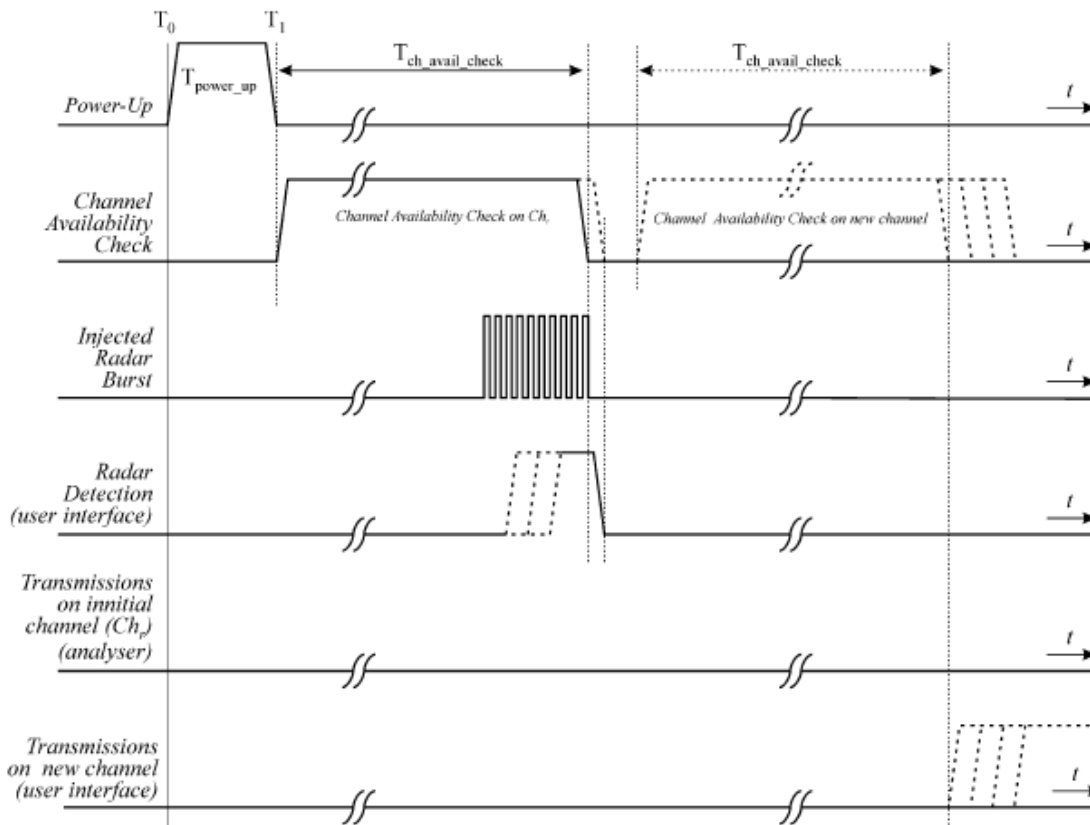

Figure 16: Example of timing for radar testing towards the end of the Channel Availability Check Time

5.6.3 Result of Channel Availability Check

Channel Bandwidth 160MHz / 5250 MHz

EUT Power up and Initial Channel Availability Check Time



Radar Type 0 Radar Burst at the Beginning

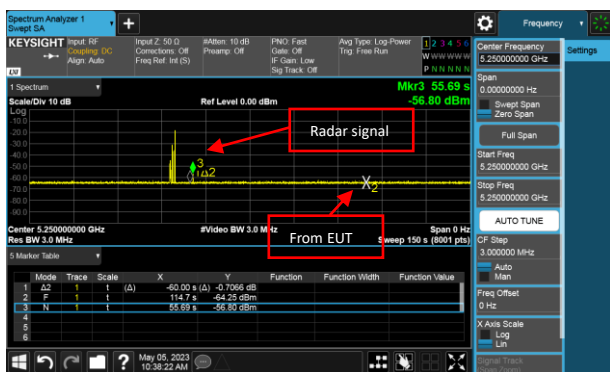

Radar Type 0 Radar Burst at the End



Channel Bandwidth 160MHz / 5570 MHz

EUT Power up and Initial Channel Availability Check Time



Radar Type 0 Radar Burst at the Beginning

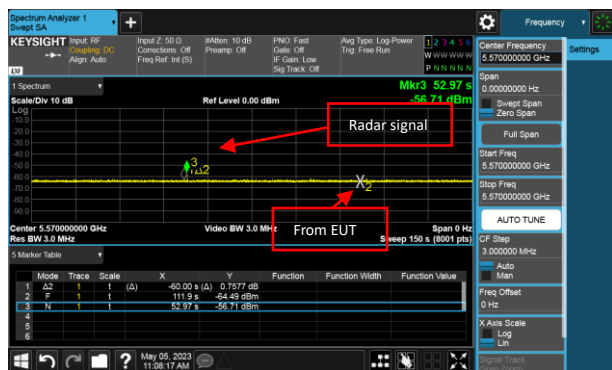

Radar Type 0 Radar Burst at the End

