

UNII-2c Chain 1

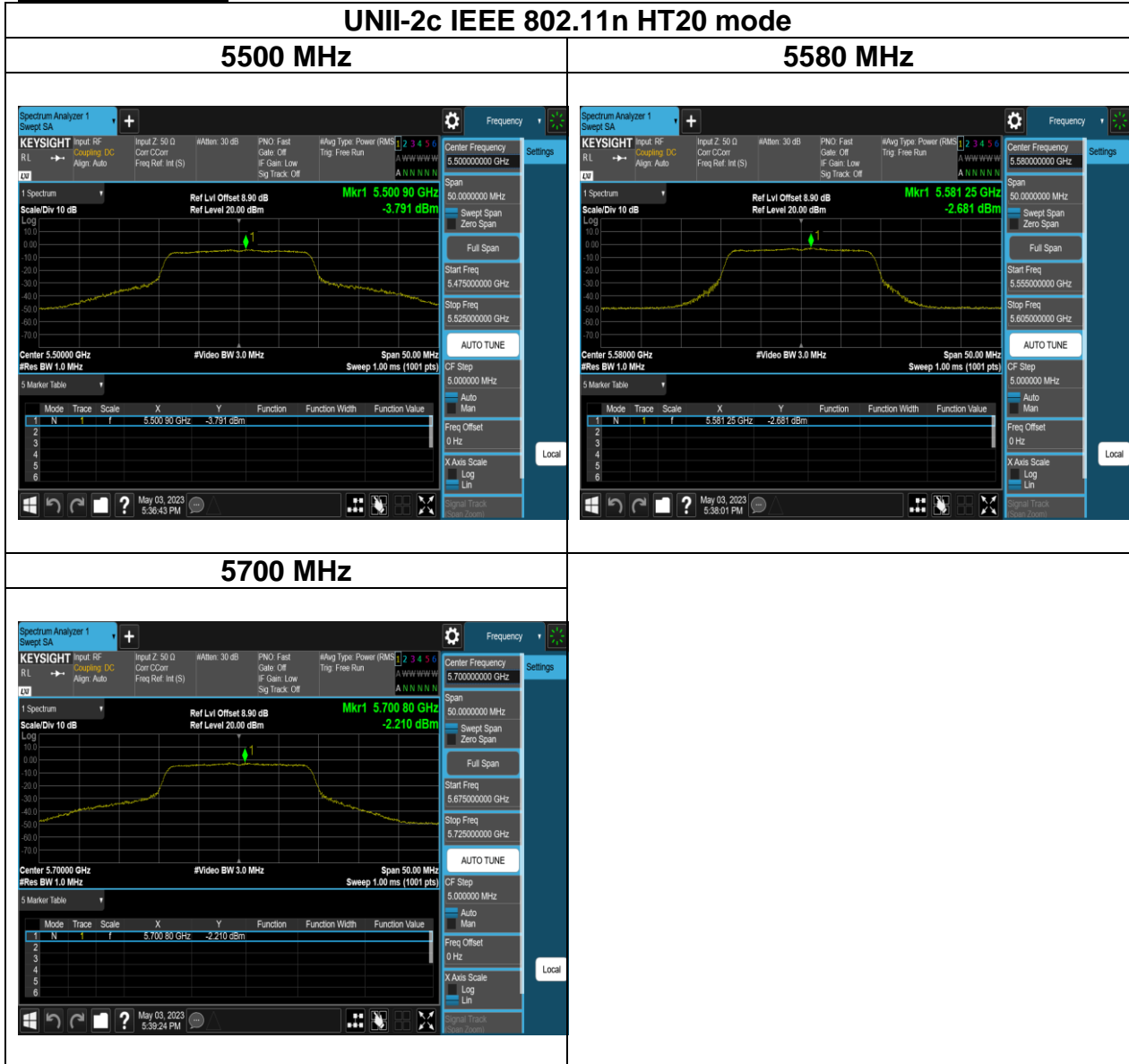

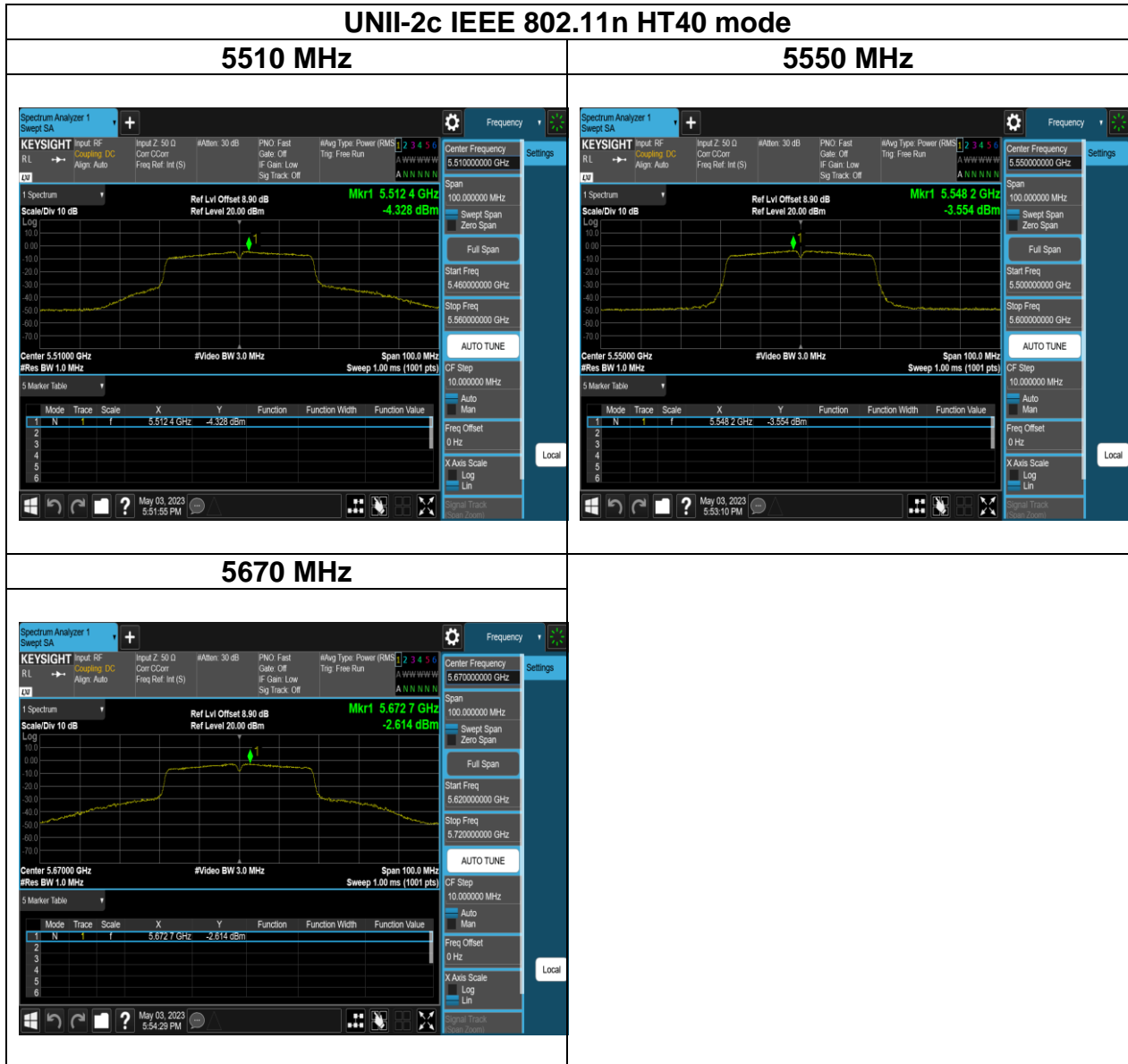

Report No.: TMWK2304001001KR

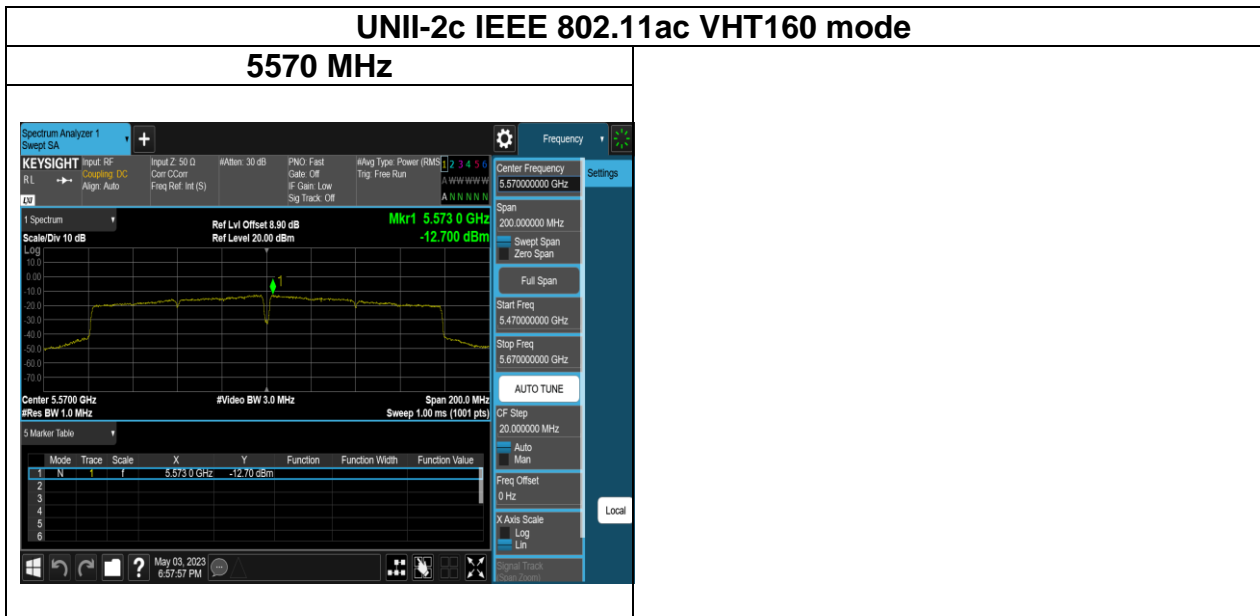
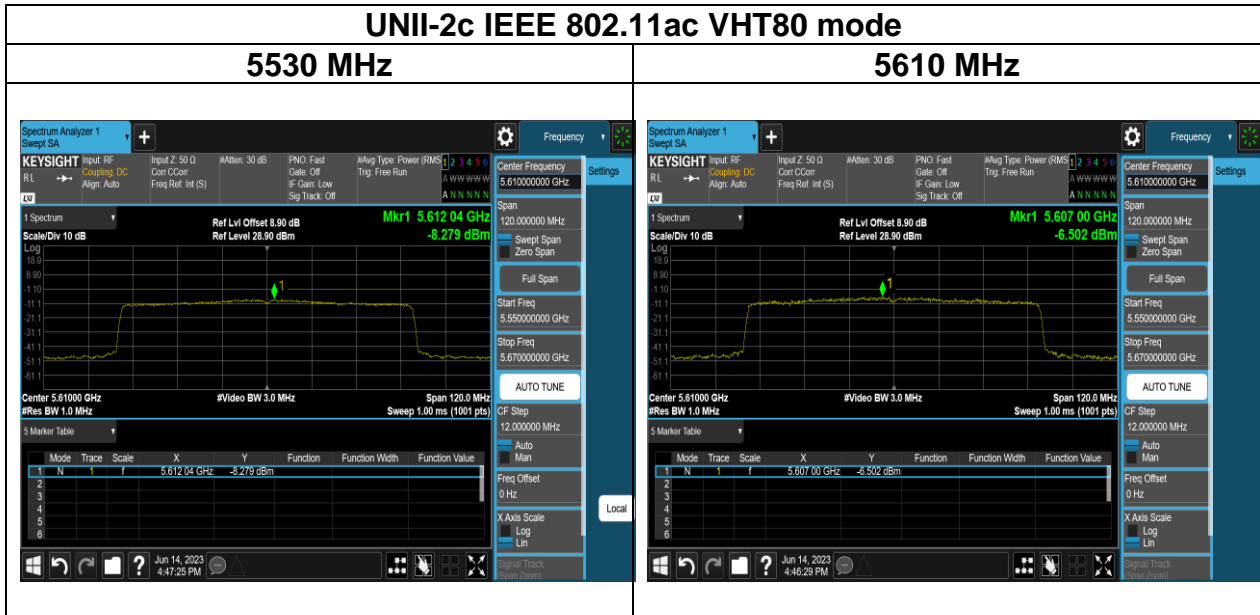

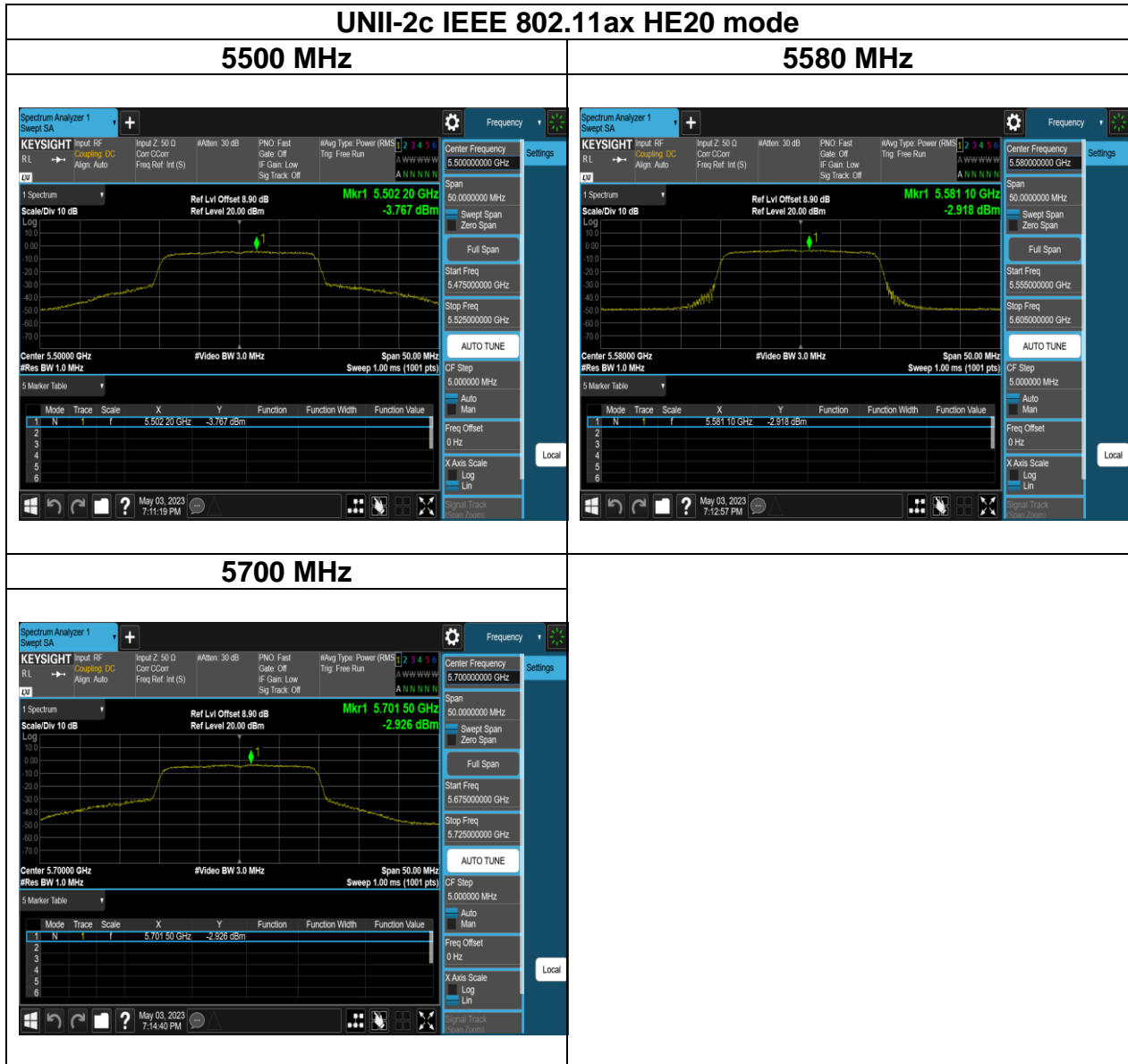

Report No.: TMWK2304001001KR



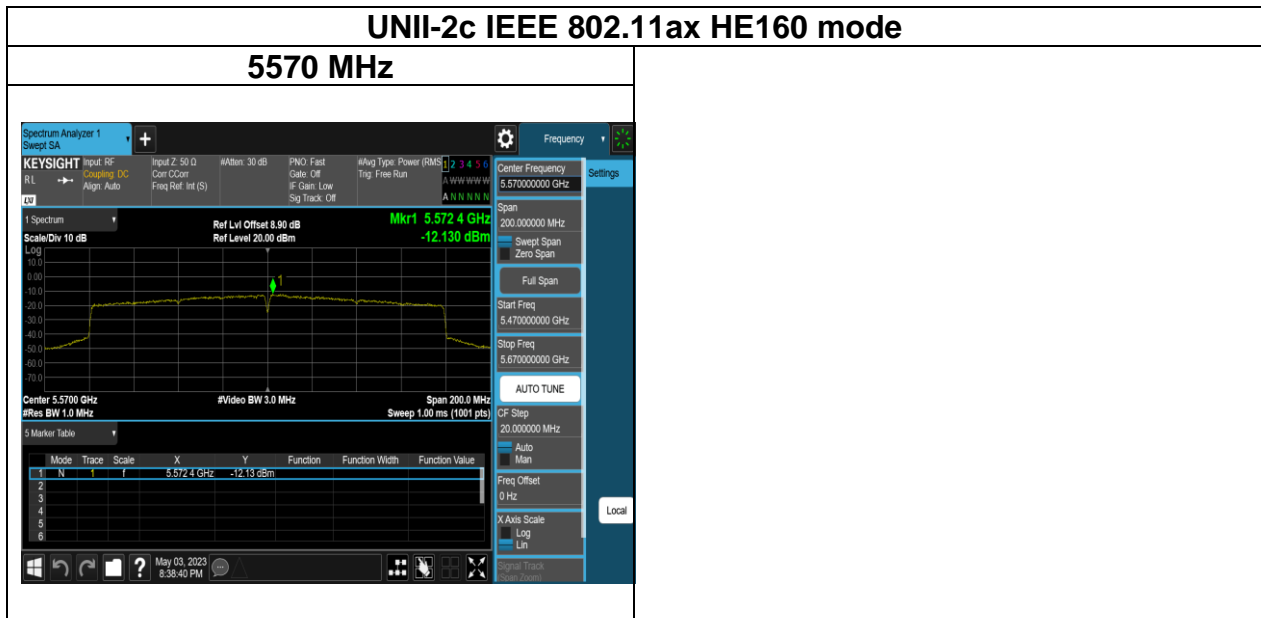
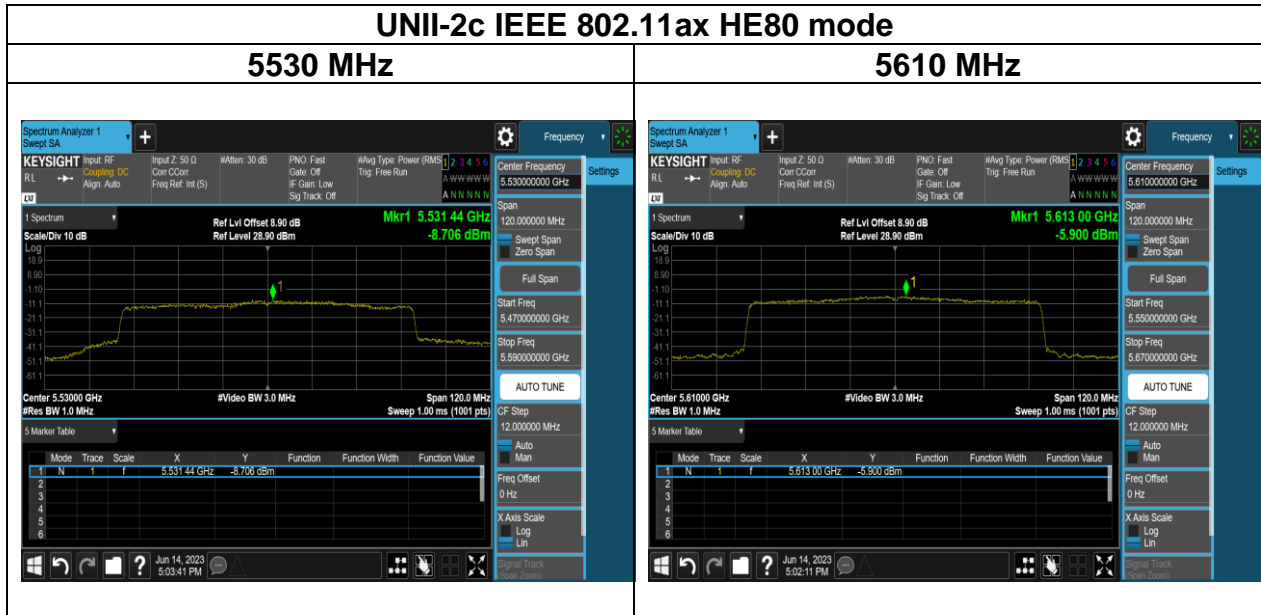

Report No.: TMWK2304001001KR

UNII-2c Chain 2

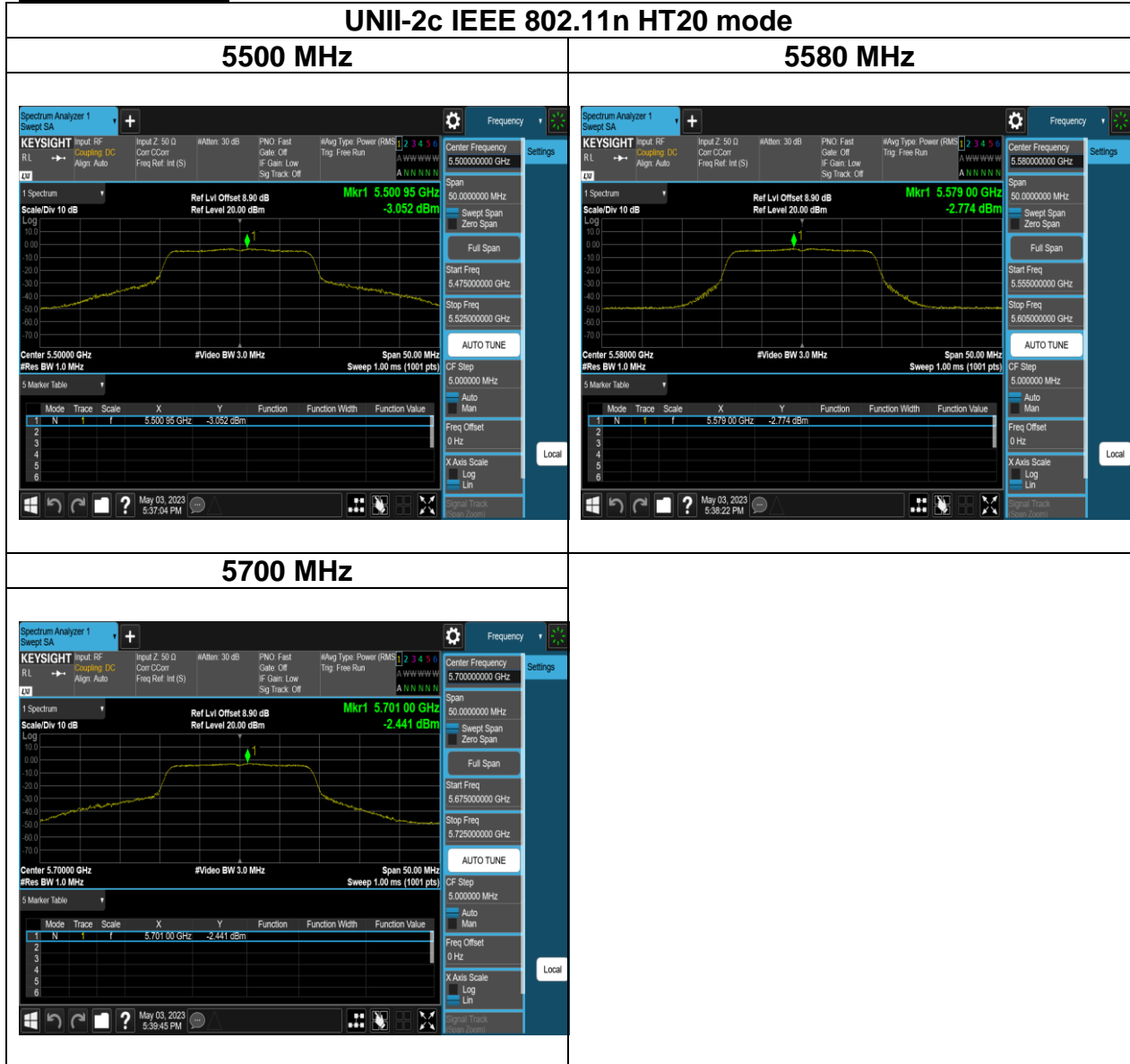



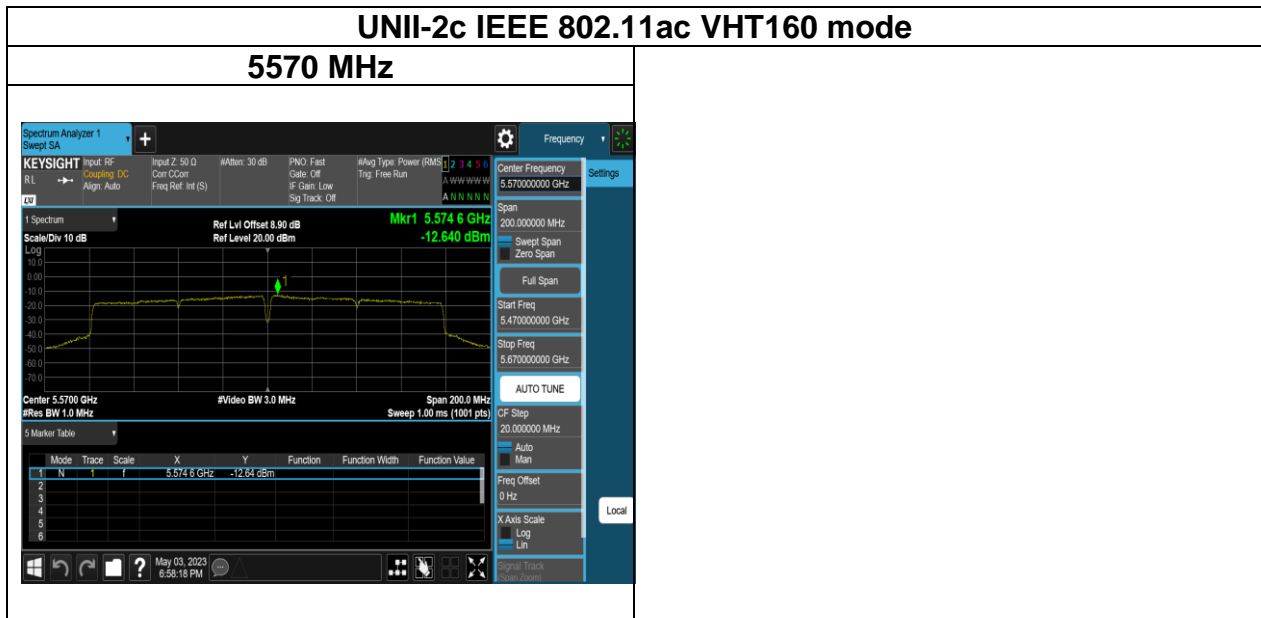
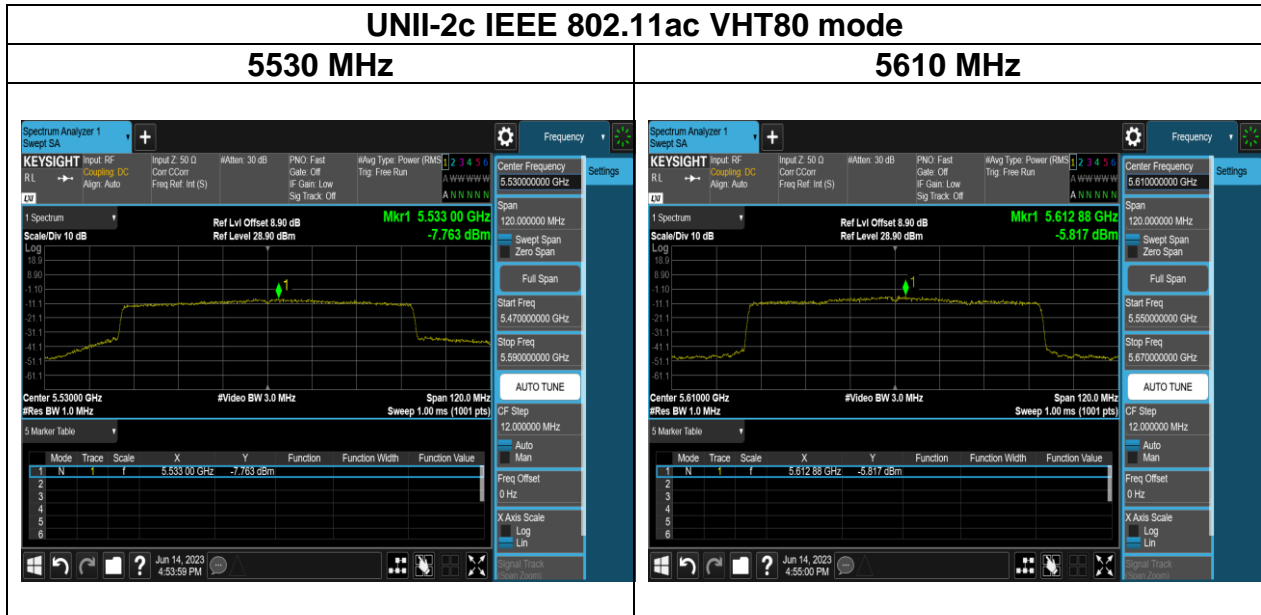

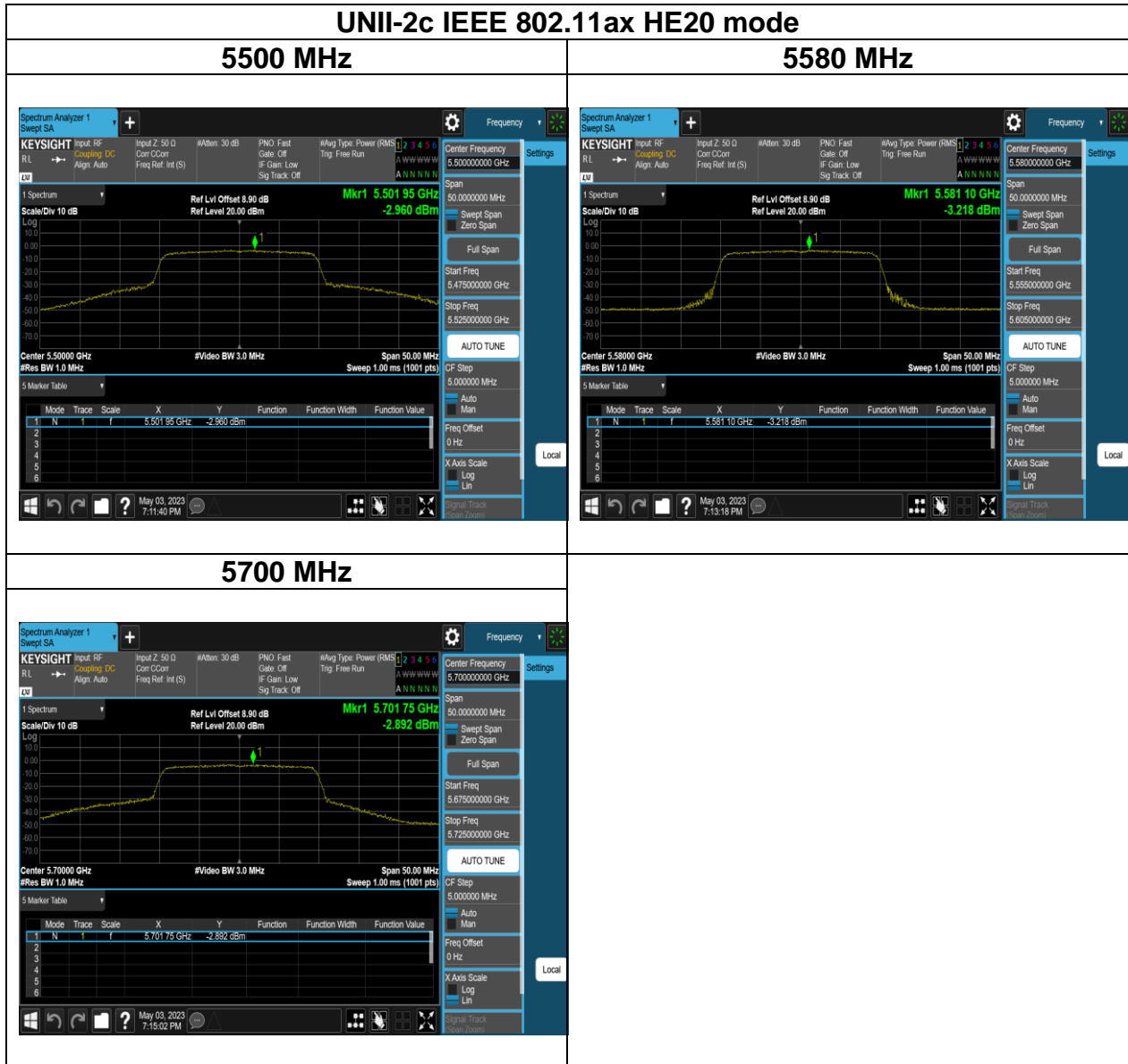

Report No.: TMWK2304001001KR



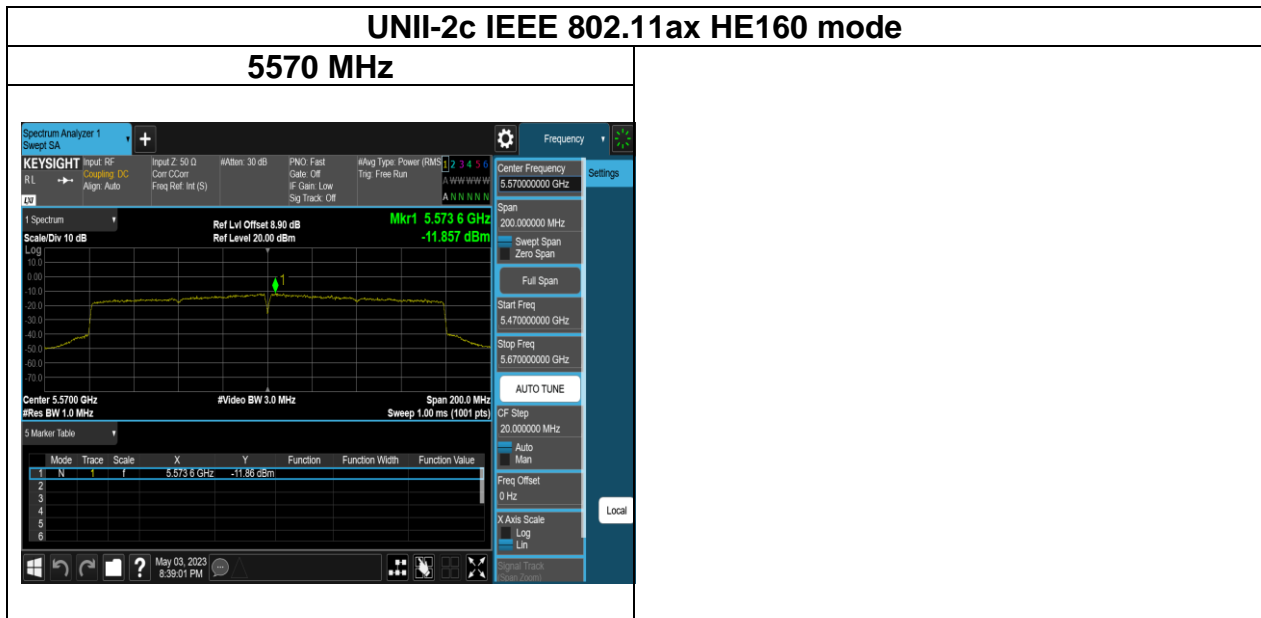
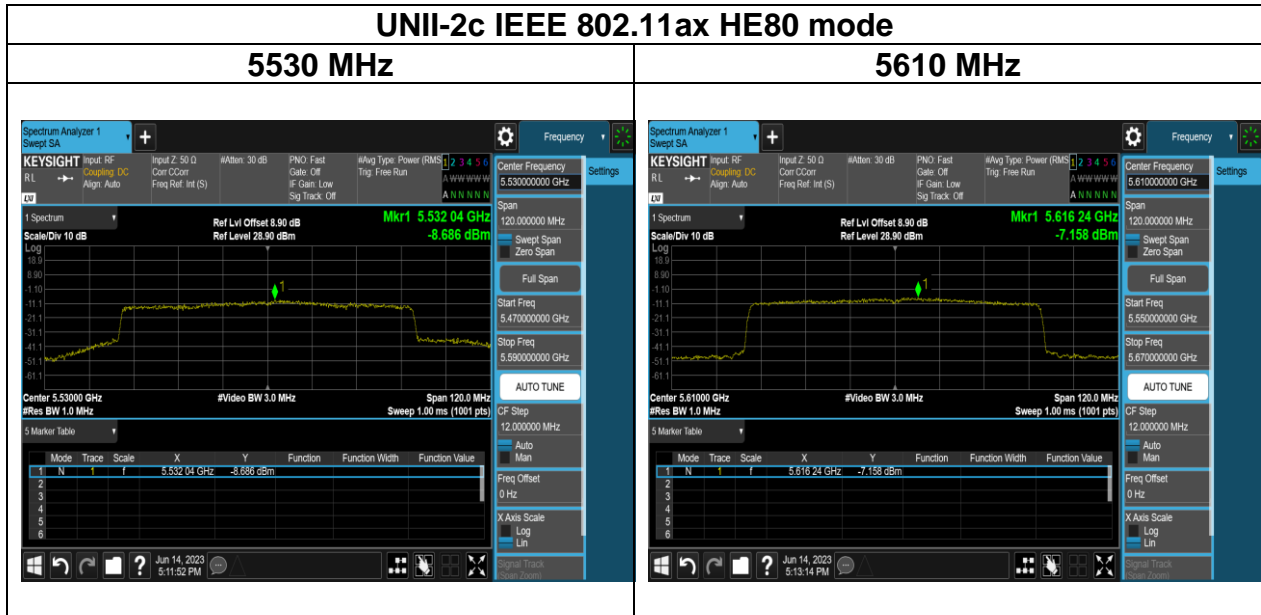

Report No.: TMWK2304001001KR

Test Plots:-Beamforming

UNII-3 Chain 0



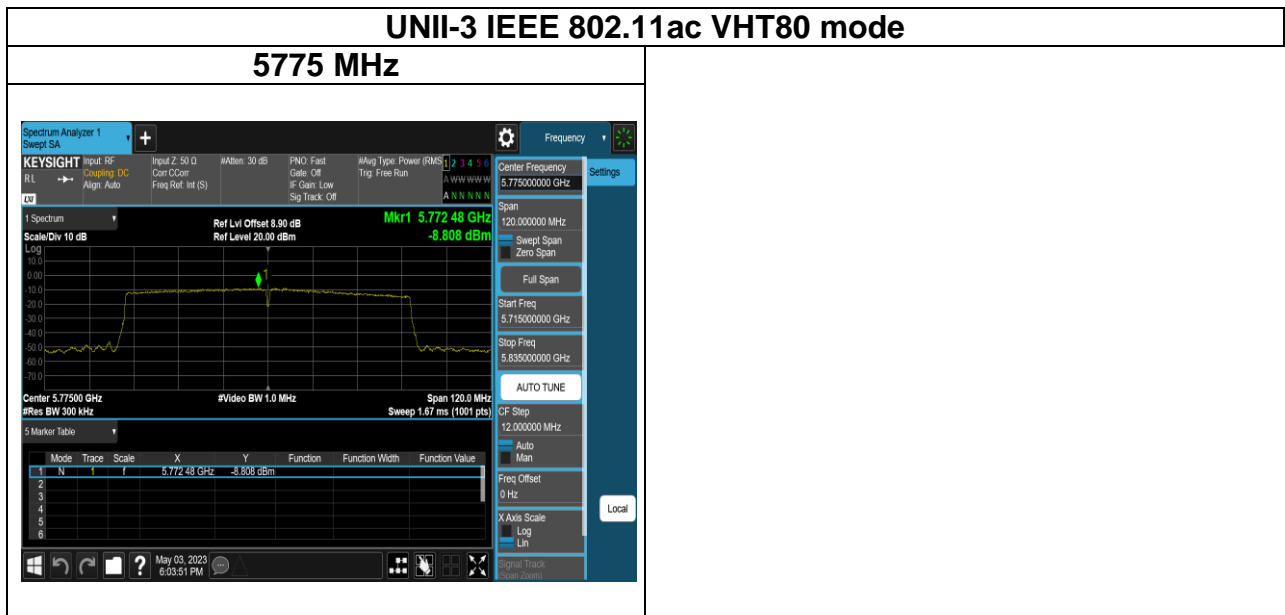
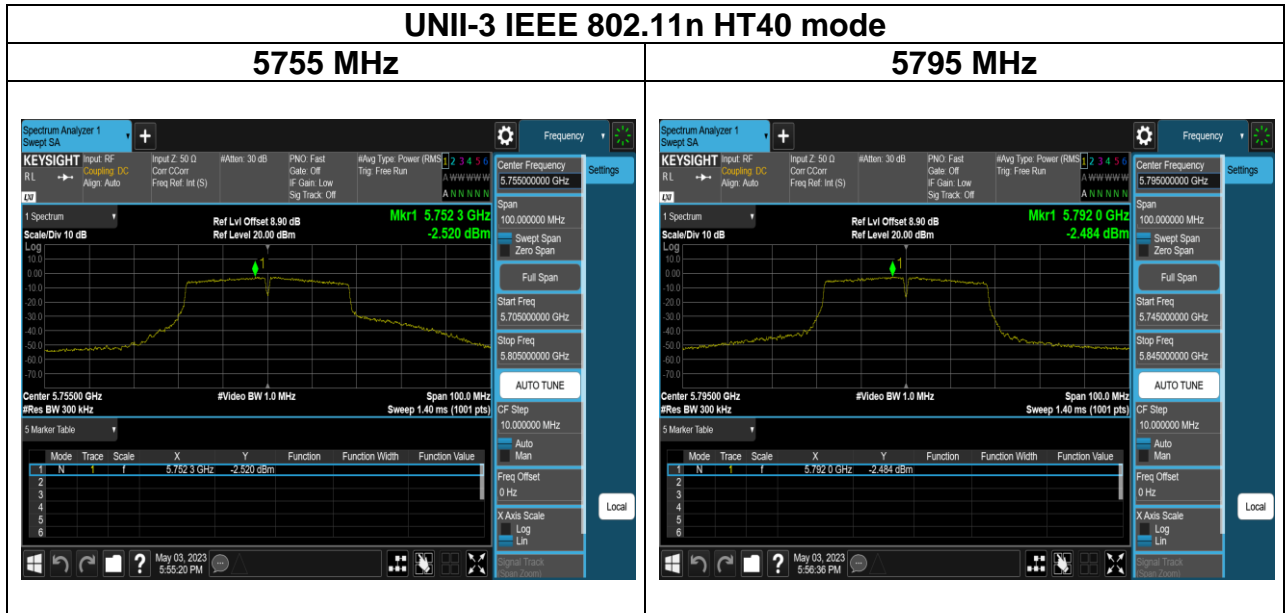



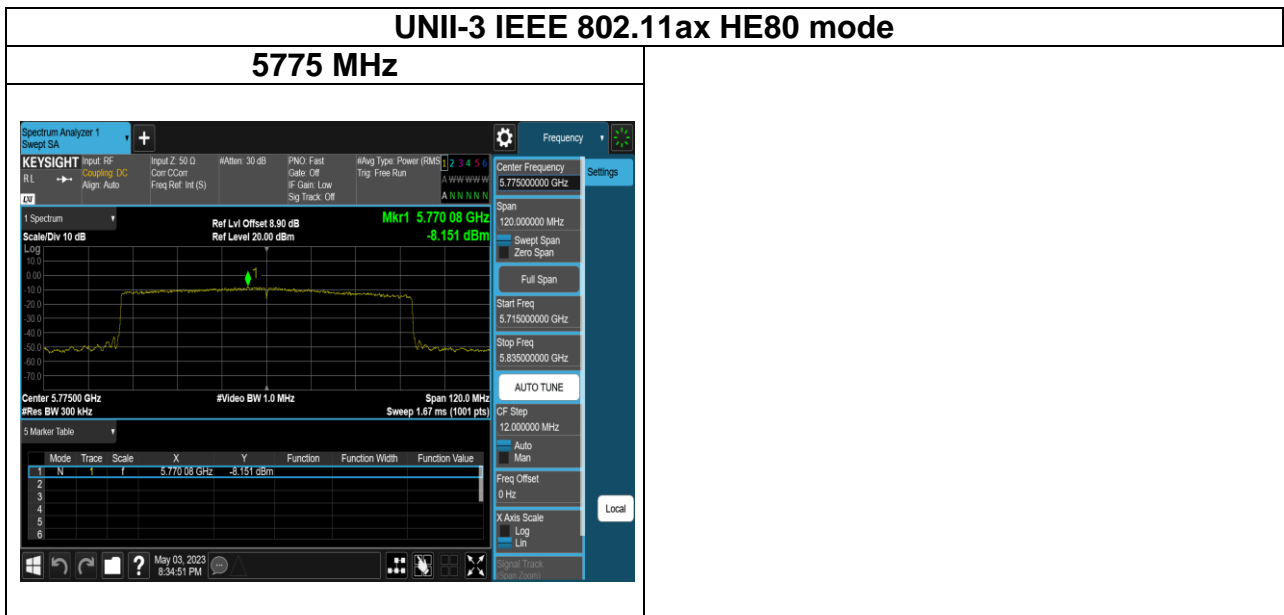
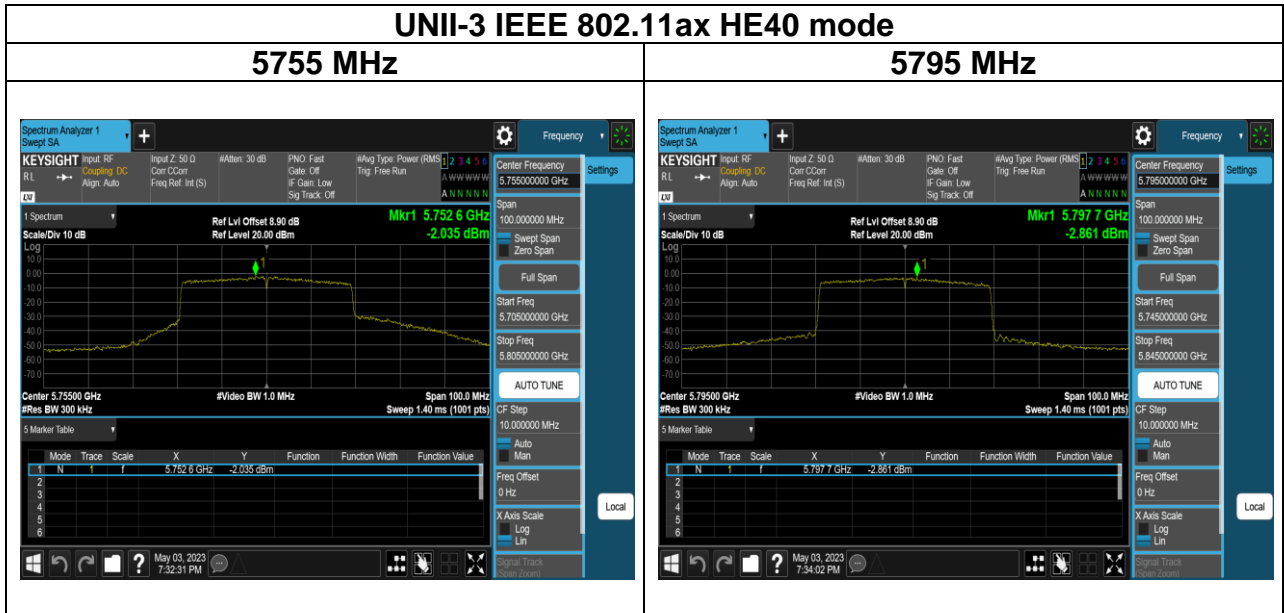

UNII-3 Chain 1



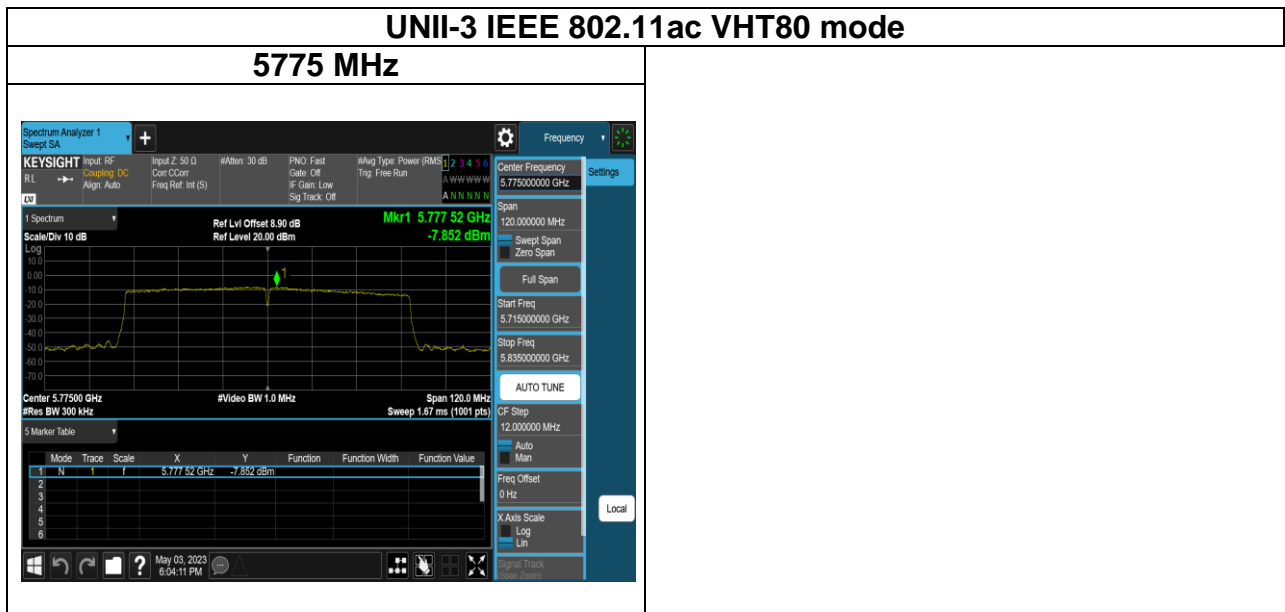
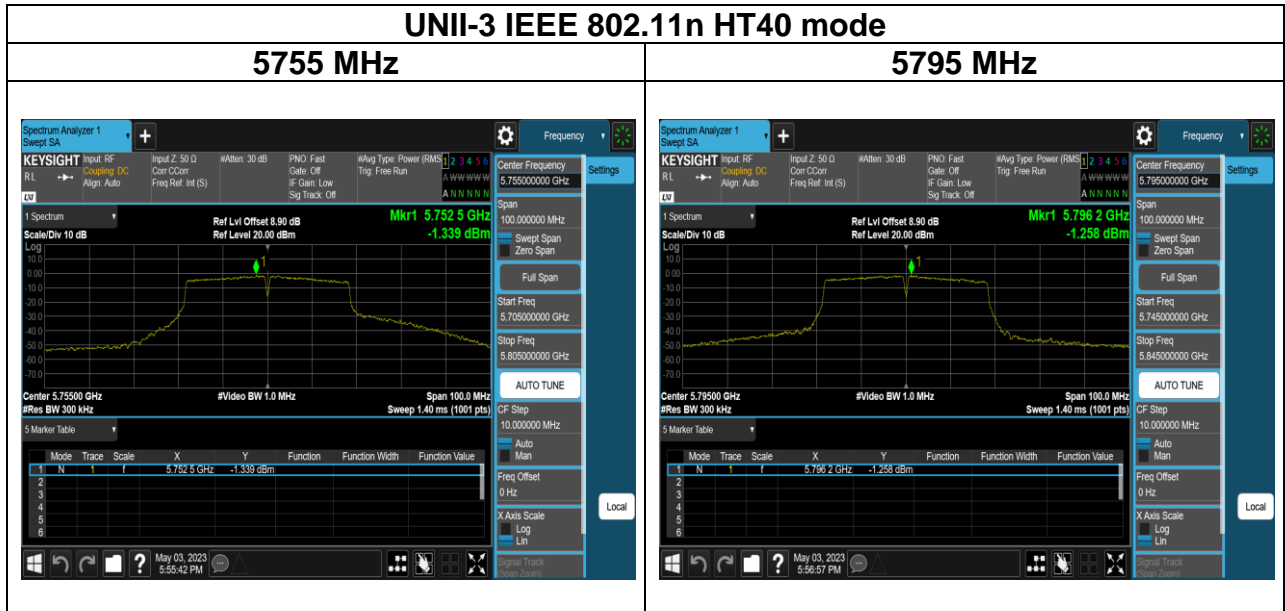

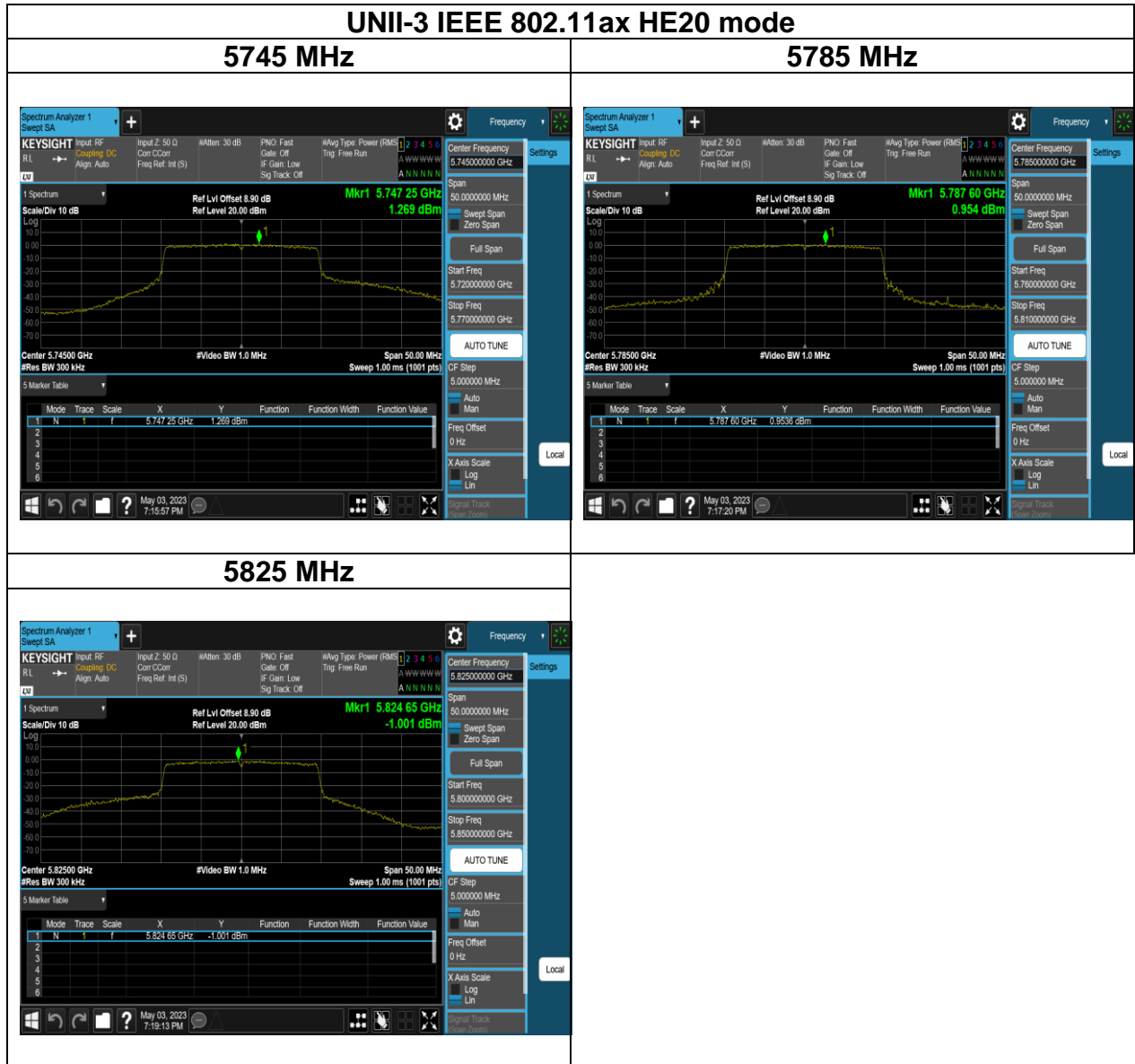

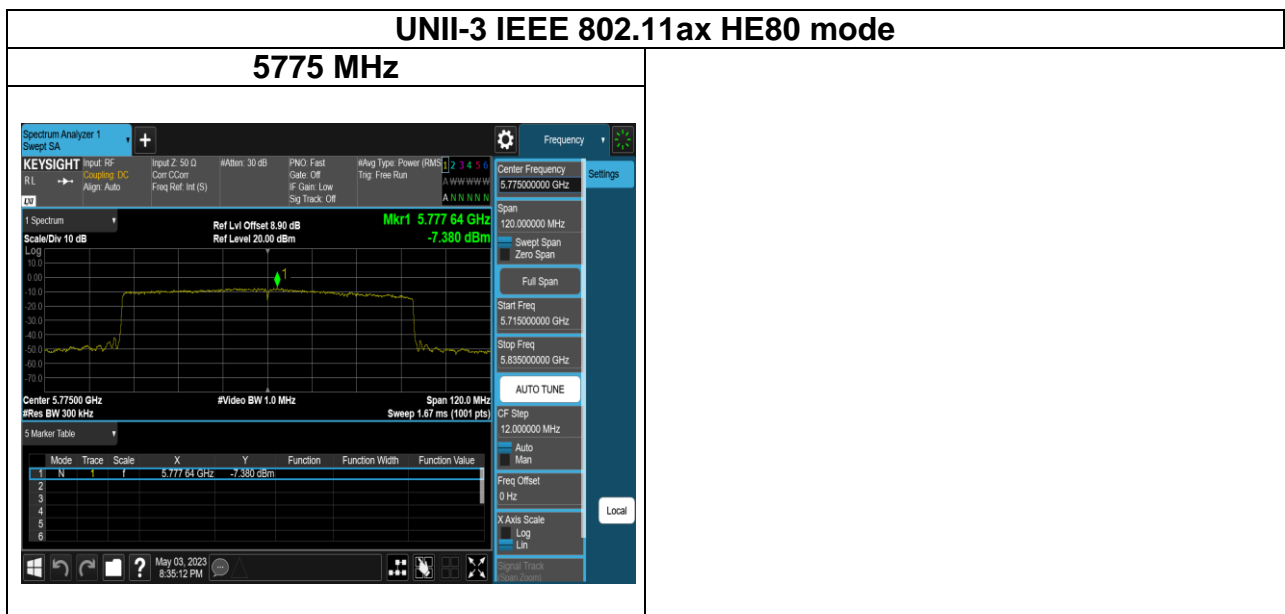
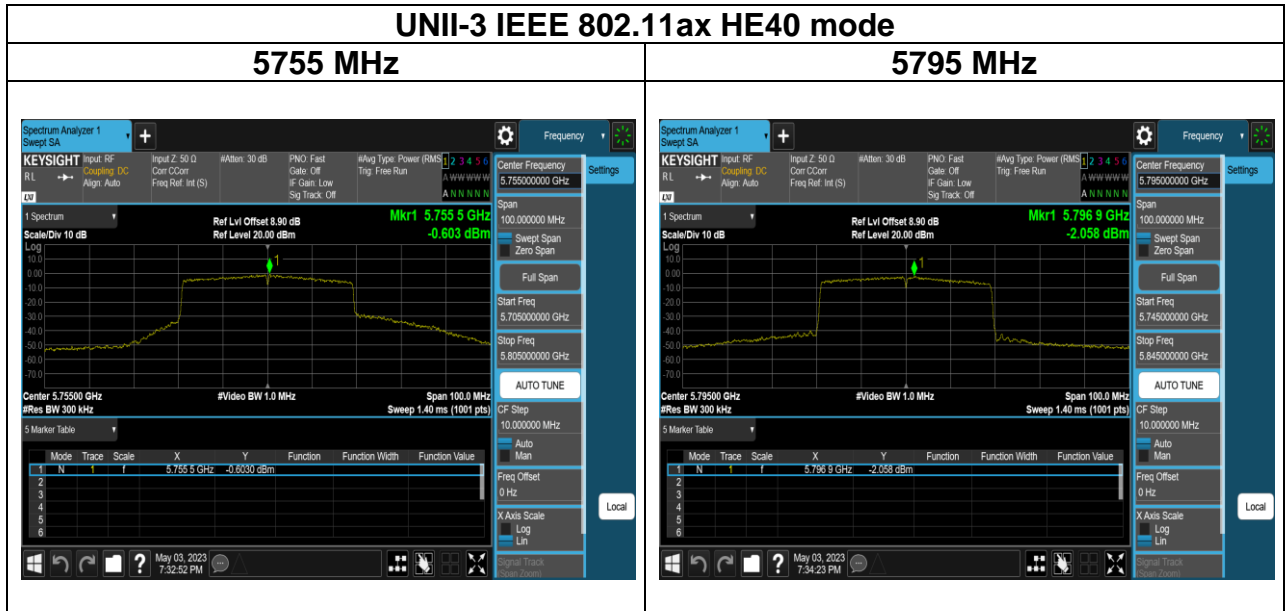

UNII-3 Chain 2

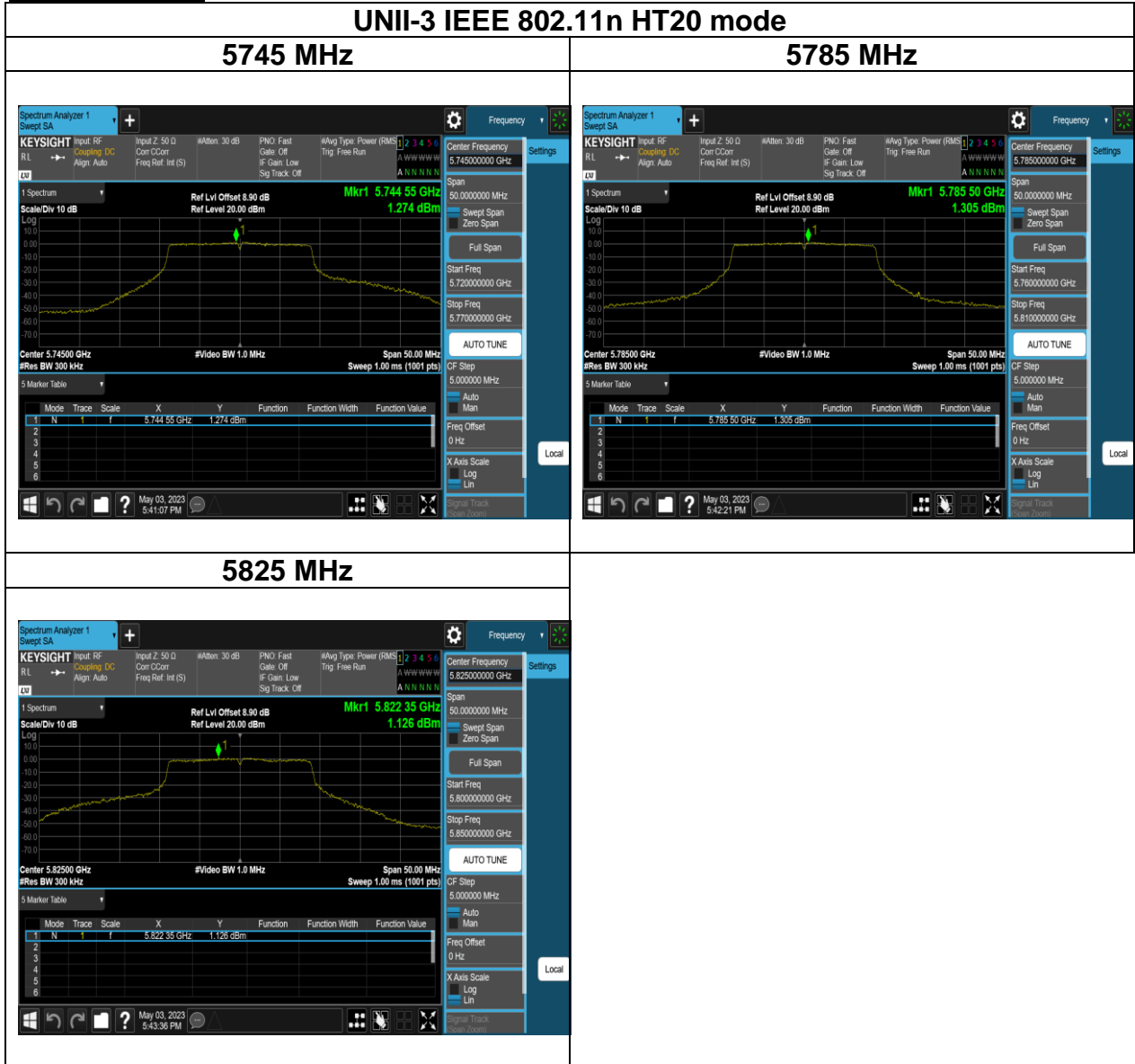

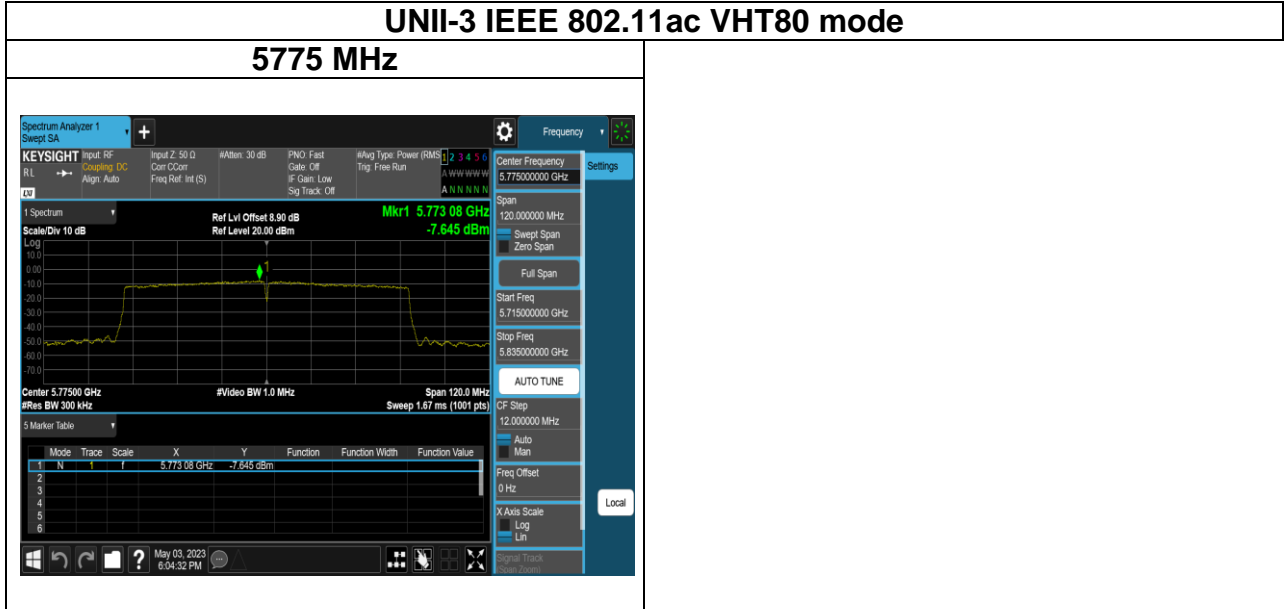
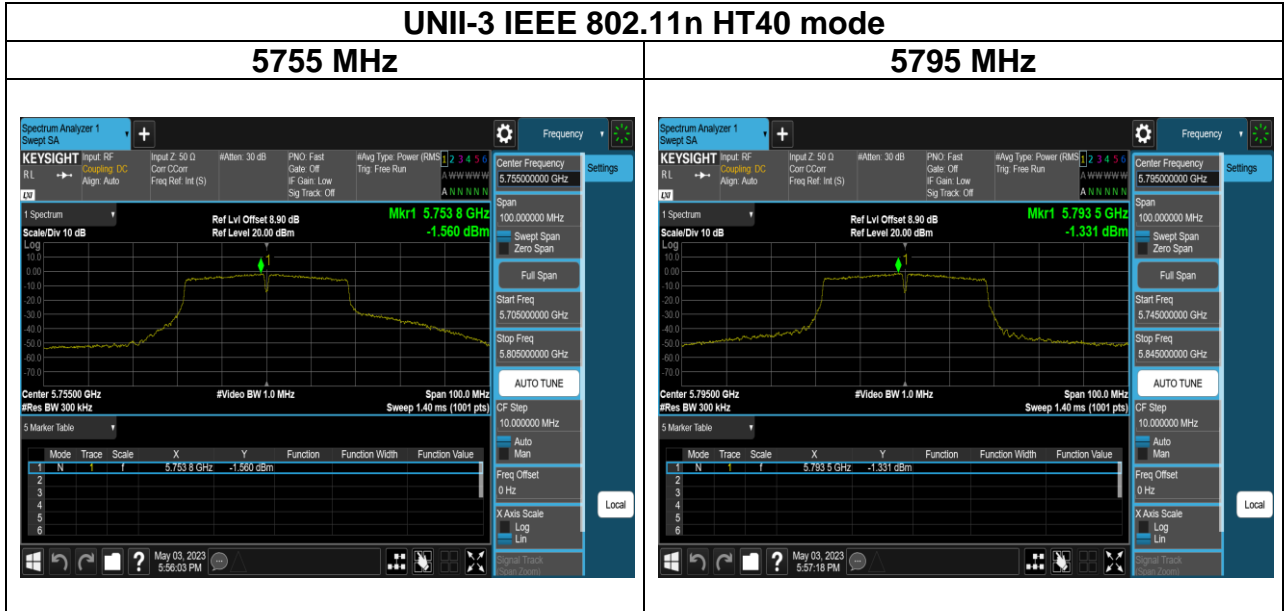



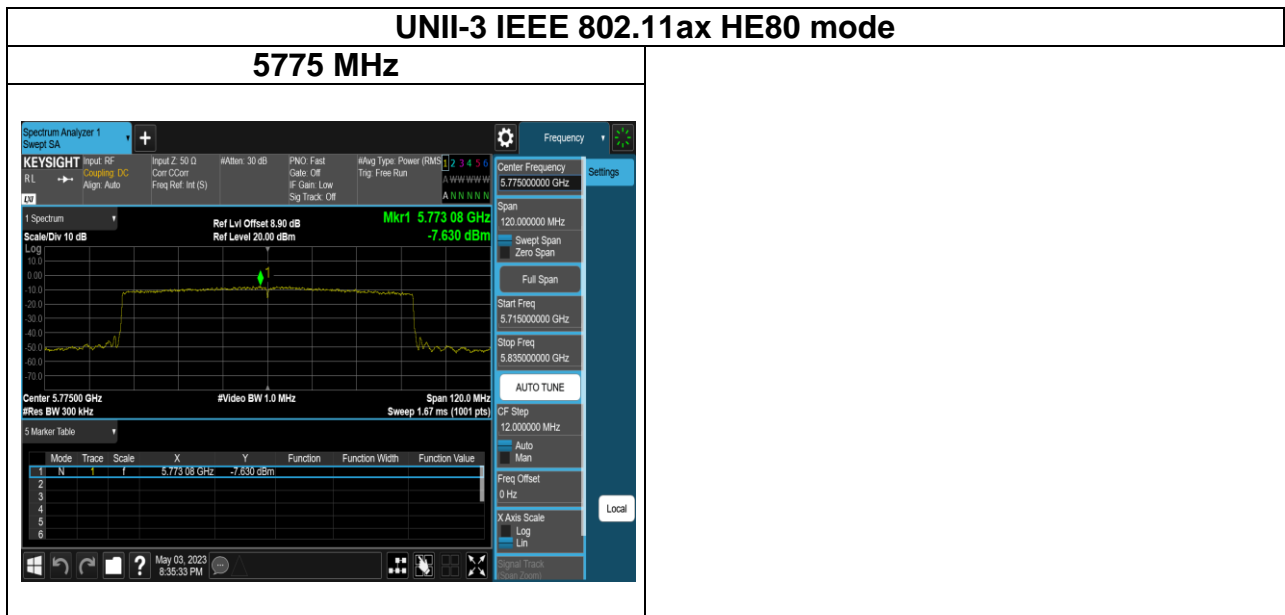
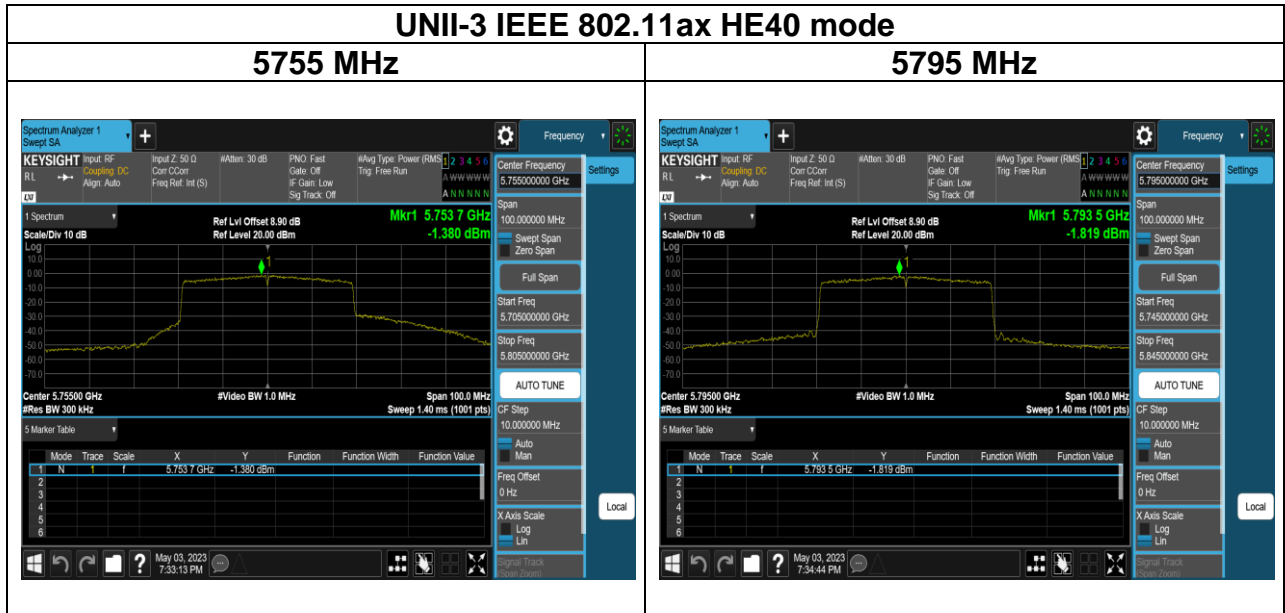

4.5 RADIATION BANDEDGE AND SPURIOUS EMISSION

4.5.1 Test Limit

FCC according to §15.407, §15.209 and §15.205,

Below 30 MHz

Frequency	Field Strength (microvolts/m)	Magnetic H-Field (microamperes/m)	Measurement Distance (metres)
9-490 kHz	2,400/F (F in kHz)	2,400/F (F in kHz)	300
490-1,705 kHz	24,000/F (F in kHz)	24,000/F (F in kHz)	30
1.705-30 MHz	30	N/A	30

Above 30 MHz

Frequency (MHz)	Field Strength microvolts/m at 3 metres (watts, e.i.r.p.)	
	Transmitters	Receivers
30-88	100 (3 nW)	100 (3 nW)
88-216	150 (6.8 nW)	150 (6.8 nW)
216-960	200 (12 nW)	200 (12 nW)
Above 960	500 (75 nW)	500 (75 nW)

UNII-1 :

For transmitters operating in the band 5150-5250 MHz, all emissions outside the band 5150-5350 MHz shall not exceed -27 dBm/MHz e.i.r.p. However, any unwanted emissions that fall into the band 5250-5350 MHz must be 26 dBc, when measured using a resolution bandwidth between 1 and 5% of the occupied bandwidth, above 5.25 GHz. Otherwise, the transmission is considered as intentional and the devices shall implement dynamic frequency selection (DFS) and transmitter power control (TPC) as per the requirements for the band 5250-5350 MHz

UNII-3:

All emissions shall be limited to a level of -27 dBm/MHz at 75 MHz or more above or below the band edge increasing linearly to 10 dBm/MHz at 25 MHz above or below the band edge, and from 25 MHz above or below the band edge increasing linearly to a level of 15.6 dBm/MHz at 5 MHz above or below the band edge, and from 5 MHz above or below the band edge increasing linearly to a level of 27 dBm/MHz at the band edge.

4.5.2 Test Procedure

Test method Refer as KDB 789033 D02.

1. The EUT is placed on a turntable, Above 1 GHz is 1.5m and below 1 GHz is 0.8m above ground plane. The EUT Configured un accordance with ANSI C63.10: 2013, and the EUT set in a continuous mode.
2. The turntable shall be rotated for 360 degrees to determine the position of maximum emission level. And EUT is set 3m away from the receiving antenna, which is scanned from 1m to 4m above the ground plane to find out the highest emissions. Measurement are made polarized in both the vertical and the horizontal positions with antenna.
3. Span shall wide enough to full capture the emission measured. The SA from 9kHz to 40GHz set to the low, Mid and High channels with the EUT transmit.
4. No emission found between lowest internal used/generated frequency to 30MHz (9KHz~30MHz)
5. The SA setting following :
 - (1) Below 1G : RBW = 100kHz, VBW \geq 3*RBW, Sweep = Auto, Detector = Peak, Trace = Max hold.
 - (2) Above 1G :
 - (2.1) For Peak measurement : RBW = 1MHz, VBW \geq 3 RBW, Sweep = Auto, Detector = Peak, Trace = Max hold.
 - (2.2) For Average measurement : RBW = 1MHz, VBW
 - 'If Duty Cycle \geq 98%, VBW=10Hz.
 - 'If Duty Cycle < 98%, VBW=1/T.
 - (3) Data result :
 - Actual FS=Spectrum Reading Level + Factor
 - Margin=Actual FS- Limit

4.5.3 Test Setup

9kHz ~ 30MHz

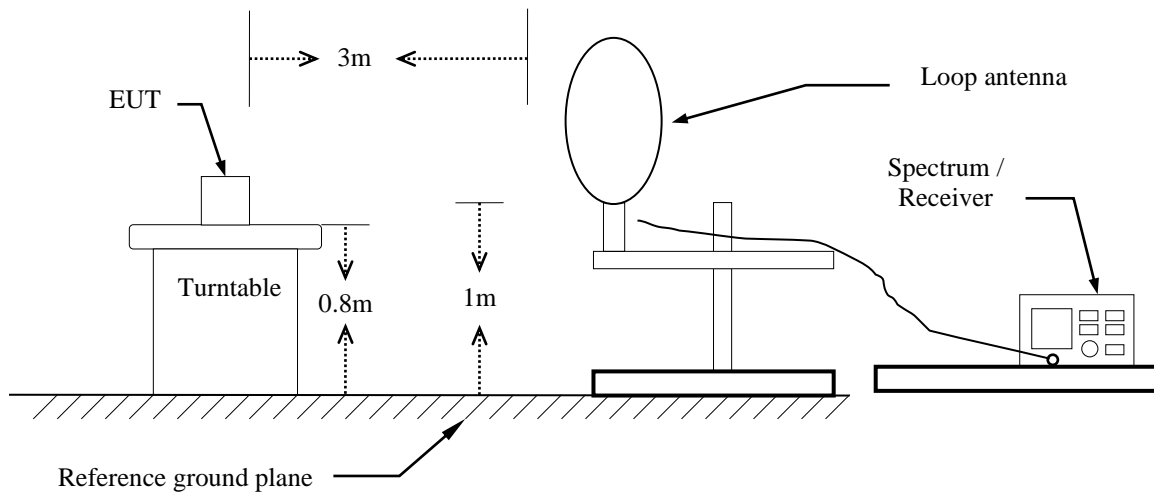

30MHz ~ 1GHz

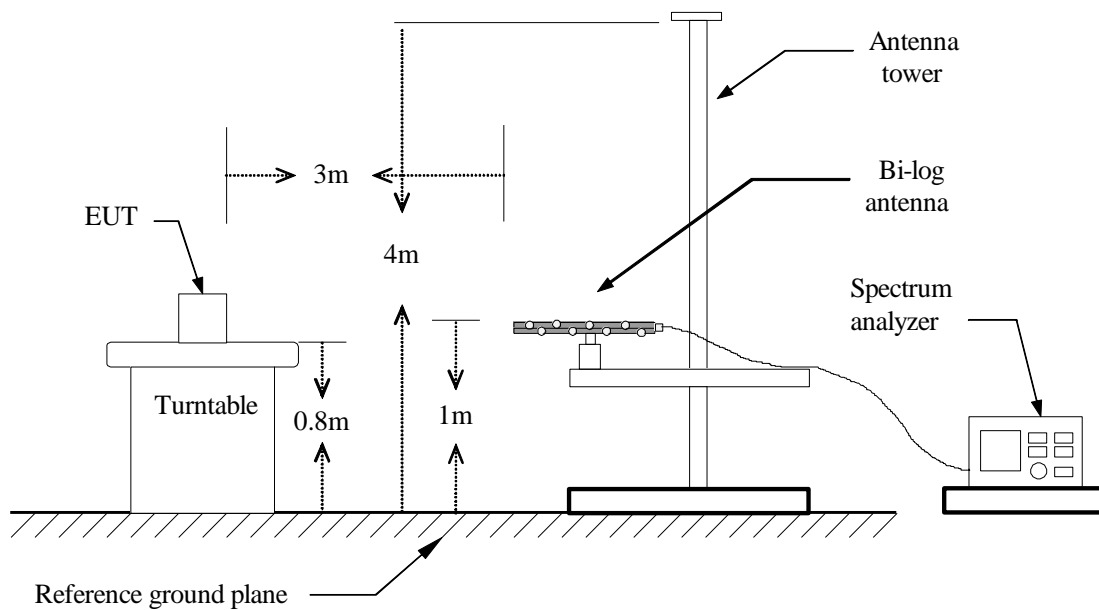

Above 1 GHz

