

CG-

REV	DATE	DESCRIPTION
X1	11/24-2022	New Issue

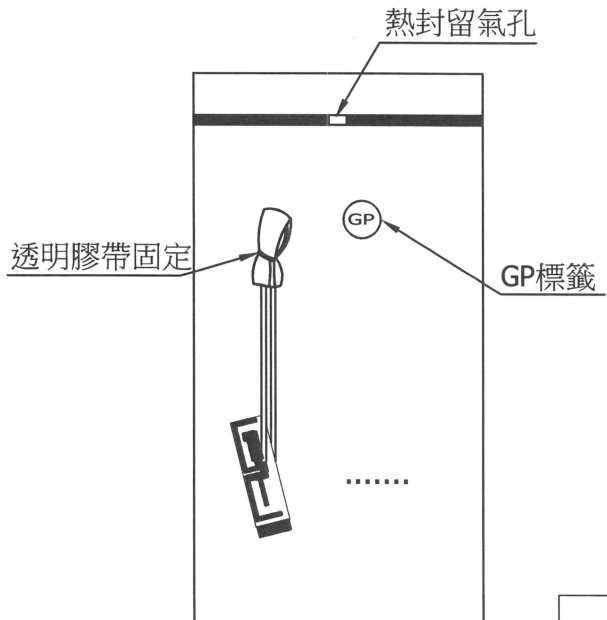
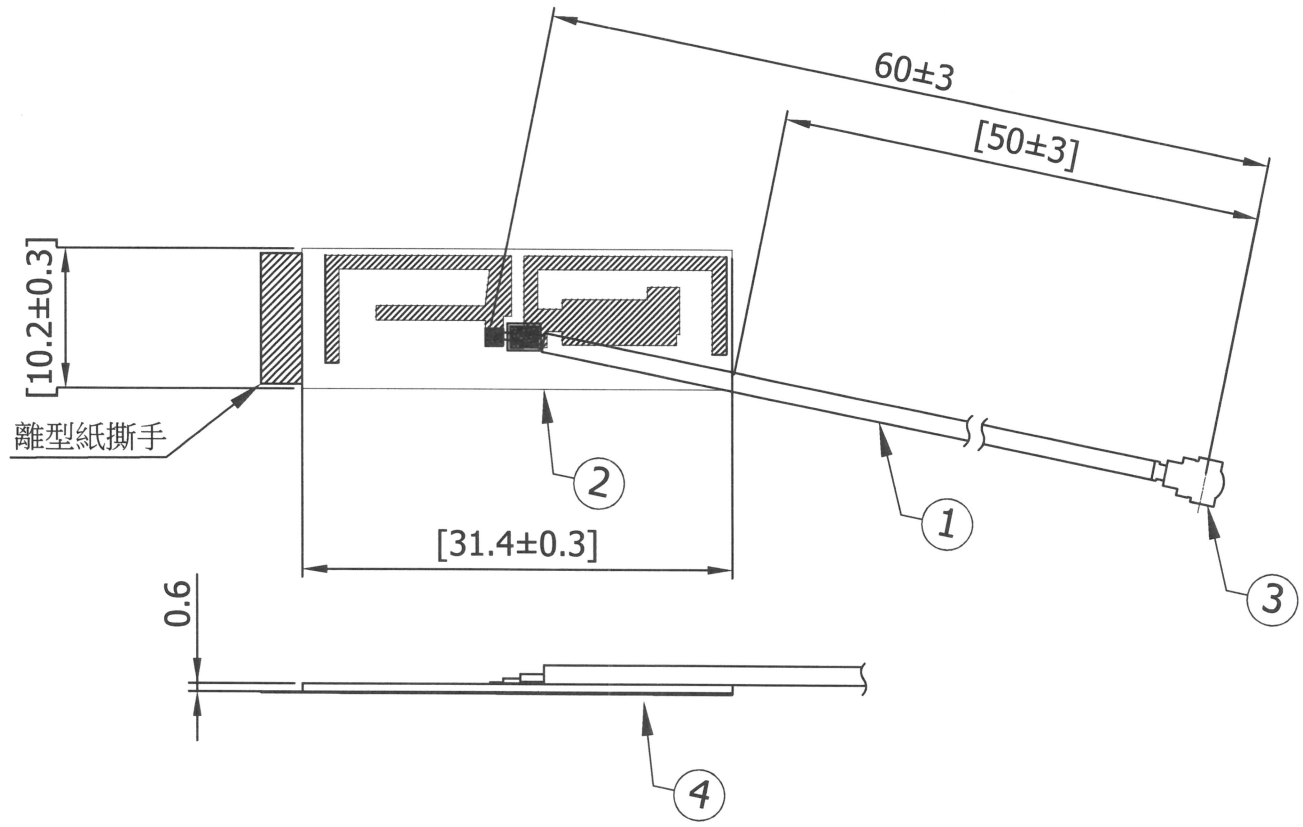

NO	DESCRIPTION	Q'TY	REMARK
4	雙面背膠 G9000;(L)30.4mm(W)9.5mm(T)0.15mm	1	
3	Connector MHF Plug for Ø1.37 Coaxial Cable	1	
2	PCB FR4 ; 24mil ; 1/2 Oz	1	Black Plated
1	Cable Ø1.37mm Normal Coaxial cable ; Color:Black	1	

XXX. ±5.0 XX. ±3.0 X.X ±1.0 .X ±0.5 .XX ±0.2 ⊕ ⊖	APPROVED	CUSTOMER: 易通展
	CHECKED	PART NO :
	DRAWING	PART NAME: RF PCB Antenna Assembly
		W.Y P/NO : C1958-510030-A
		REV UNIT FILE : SRF20221965
		SHEET : 1/1

**M.gear** Wha Yu Group

THIS DRAWING, AND ITS INHERANT DESIGN CONCEPTS, ARE THE PROPERTY OF WHA YU AND AS SUCH MAY NOT BE COPIED, REPRODUCED, OR GIVEN TO THIRD PARTIES WITHOUT THE WRITTEN CONSENT OF WHA YU.

CUSTOMER'S SINGATURE

Packing : 25 pcs/bag

# RF Antenna Assembly

## Specification

### 1. Electrical Properties With housing/With Cable loss(ANT3)

- 1.1 Frequency Range..... 2.4~2.5GHz / 5.15~5.85 GHz
- 1.2 Impedance ..... 50Ω Nominal
- 1.3 VSWR ..... 1.92 : 1 Max.
- 1.4 Return Loss..... 18 dB Min.
- 1.5 Radiation ..... Omni-directional
- 1.6 Peak Gain..... 2.4~2.5GHz <2.7dBi  
5.15~5.85GHz <5.4dBi
- 1.7 Cable Loss..... 0.27 dB Max.
- 1.8 Polarization..... Linear
- 1.9 Cable..... 1.37 Coaxial Cable
- 1.10 Connector..... I-PEX MHF Connector

### 2. Physical Properties :

- 2.1 Operating Temp. .... -10°C ~ +60°C
- 2.2 Storage Temp. .... -10°C ~ +70°C

***NE3-22046***  
***E30***  
***Antenna 2/5Gx2 2Gx1 5Gx1***

*Version: V 2.05*

*Released Date: 2022/11/23*

*Prepared By: Leo*

*Reviewed By: Cathy*

# Contents

- Revised History
- Conclusion & Comments
- Specification
- Antenna Placement & Solution
- Test Setup for S-parameter Measurement
- Return Loss Results
- Isolation Results
- Test Setup for Radiation Pattern Measurement
- 2D Radiation Pattern Results
- Results Summary (return loss, isolation, peak gain, efficiency )

# Revision History

Released Date	Version	Record
2022/06/28	1.0	Antenna simulation report
2022/07/13	2.0	New Housing E30-3D-0708
2022/08/04	2.01	Antennas are designed in the 3D printed environment simulated
2022/08/19	2.02	變更線徑
2022/09/28	2.03A	實際主板驗證 (有含5G ANT)
2022/10/26	2.04A	An1-2G 更換成1.13 Low loss Cable
2022/11/23	2.05	ANT2 背膠改 1.0泡棉貼在上殼 ANT1 移除

# Specification

## Requirements of Antenna Design

RF Function	Number of ANT	Frequency Band	Remark
WiFi 5G	1	5150 – 5850MHz	
WiFi 2-5 G	2	2400 – 2500/5150 – 5850MHz	

## Requirements of Measurement

Test Item	Specification	Remark
Return Loss	10 dB Min	
Isolation	> 15dB	
Peak gain	>2/6dBi	
Efficiency	> 65%	
Radiation pattern	Scale: +10 ~ 40dBi, Angle step size: 15 degree	

# Antenna Placement & Solution

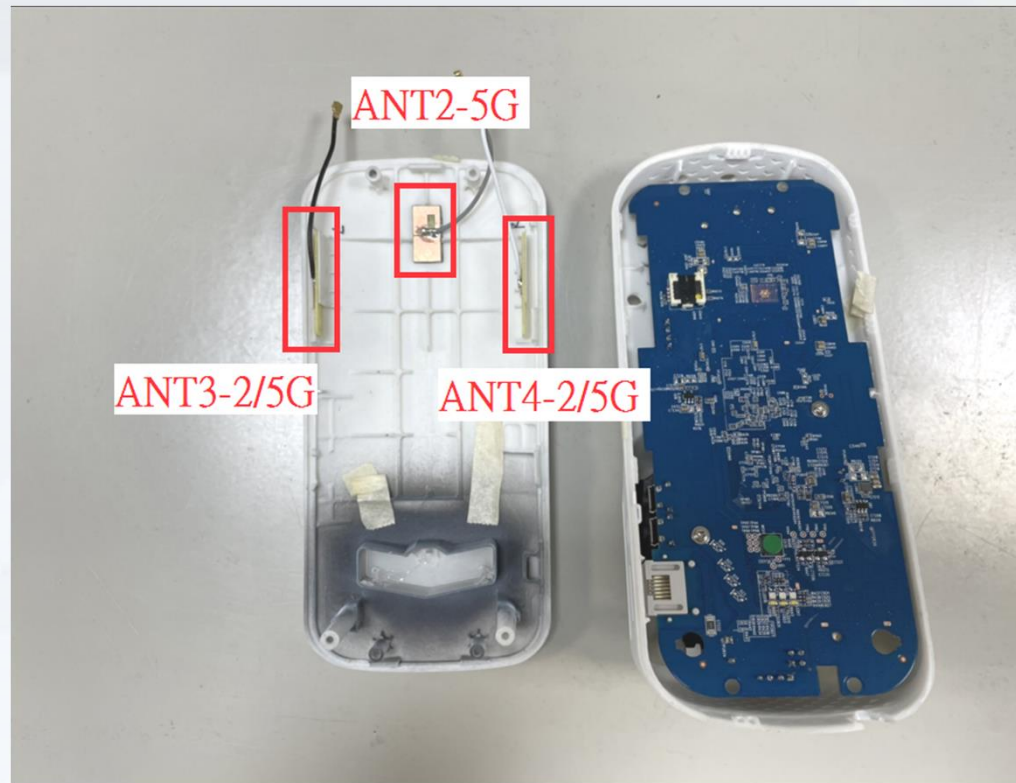

ANT	ANT Type	Size (L * W * H)	Cable Length (mm)		Cable Type	Connector
			總長	外露		
ANT2-5G	Dipole ANT	18.0mm*9.0mm*0.6mm	60mm	55	Φ=1.37 (Normal)灰	IPEX
ANT3-2/5G	Dipole ANT	31.5mm*10.0mm*0.6mm	60mm	50	Φ=1.37 (Normal)黑	IPEX
ANT4-25G	Dipole ANT	31.5mm*10.0mm*0.6mm	60mm	50	Φ=1.37 (Normal)白	IPEX

# Antenna Placement & Solution



ANT3改貼到外側



# Antenna Placement & Solution

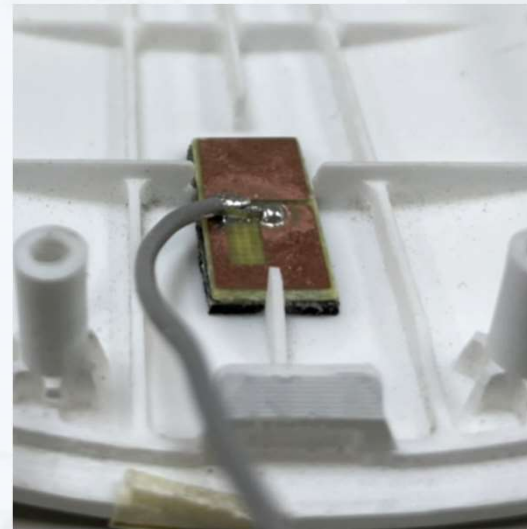
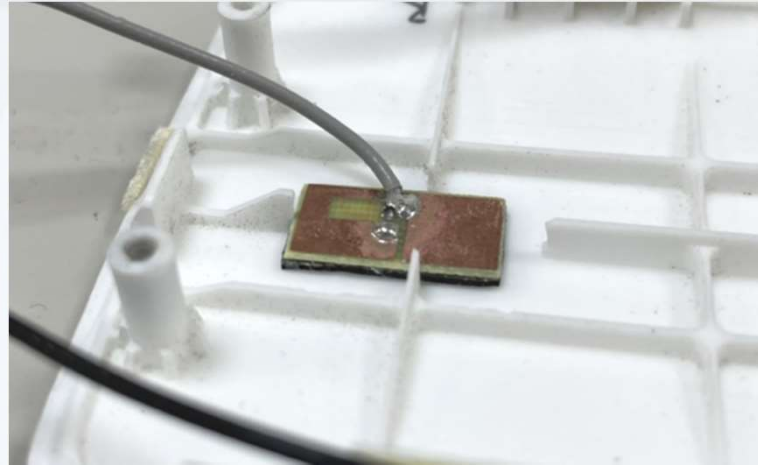
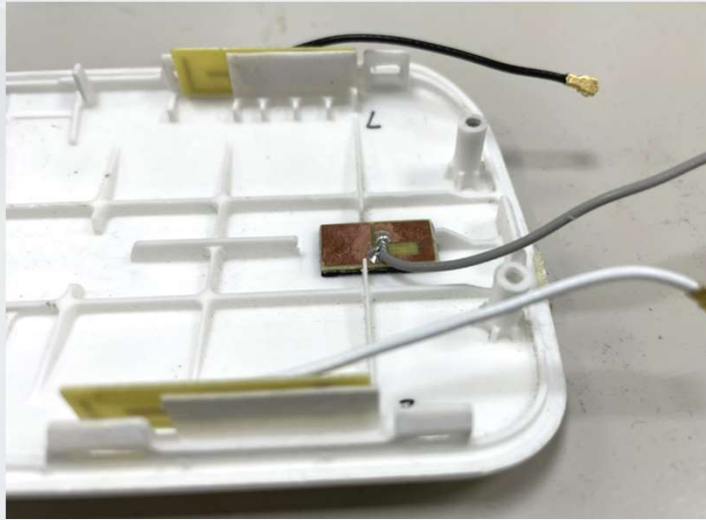

# Antenna Placement & Solution

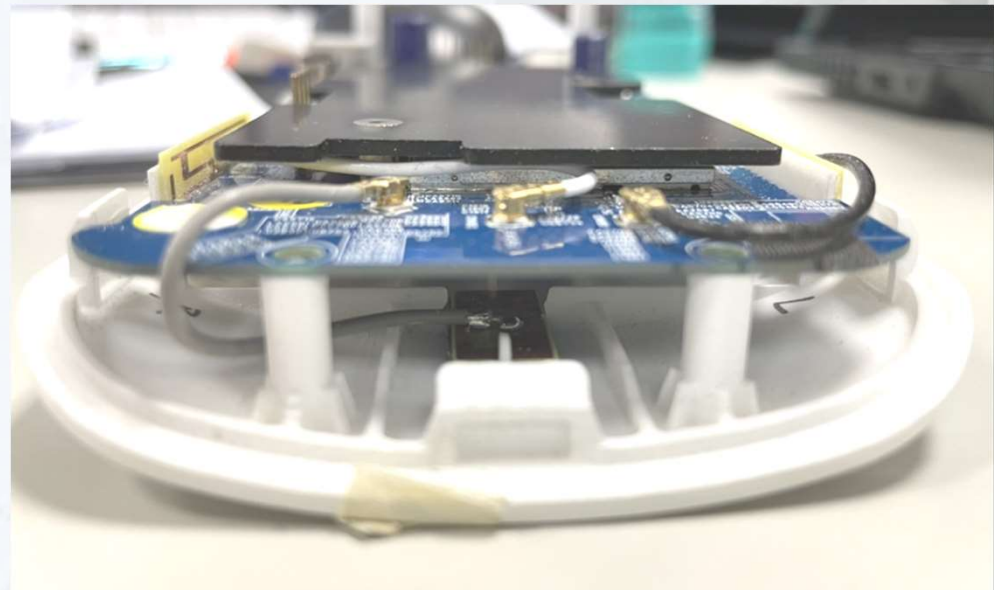

# Return Loss Results

ANT2(5150MHz – 5850MHz )

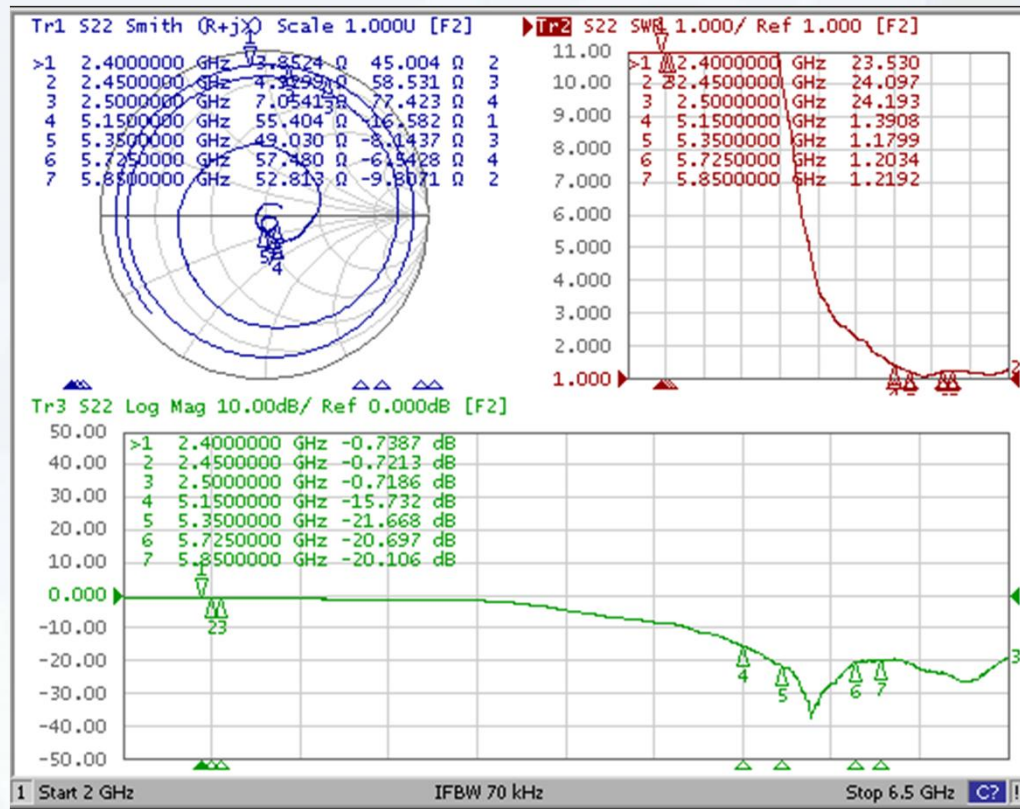

# Return Loss Results

ANT3(2400MHz – 2500MHz/5150MHz – 5850MHz)

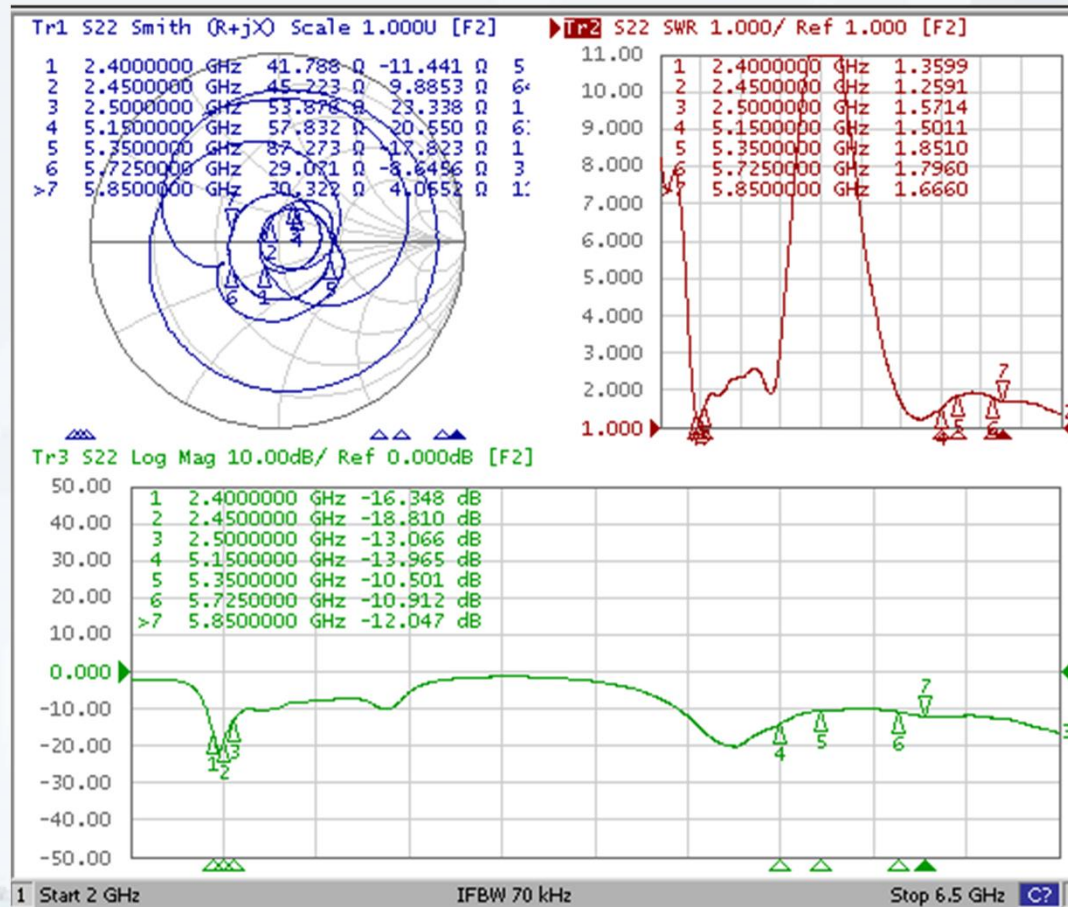

# Return Loss Results

ANT4(2400MHz – 2500MHz/5150MHz – 5850MHz)

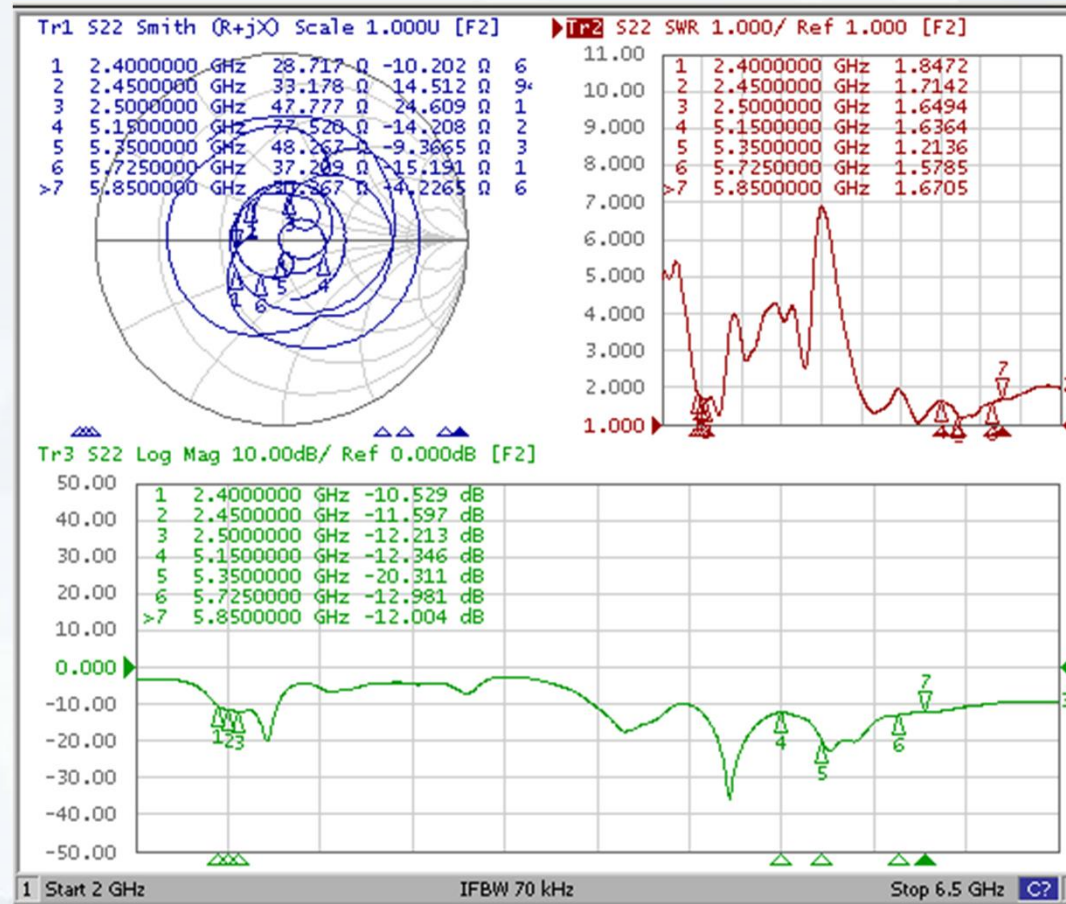

# Isolation Results

ANT2~ANT3(Criterion:>15 dB)

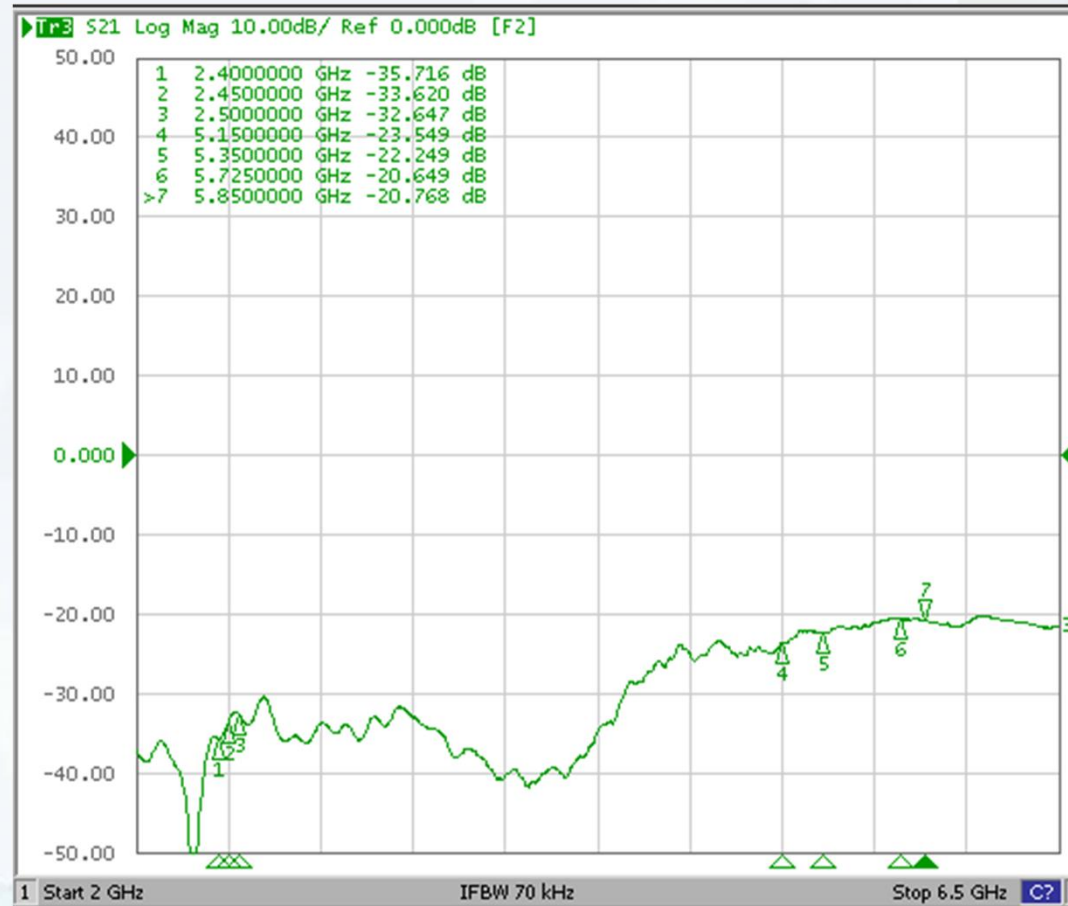

# Isolation Results

ANT2~ANT4(Criterion:>15 dB)

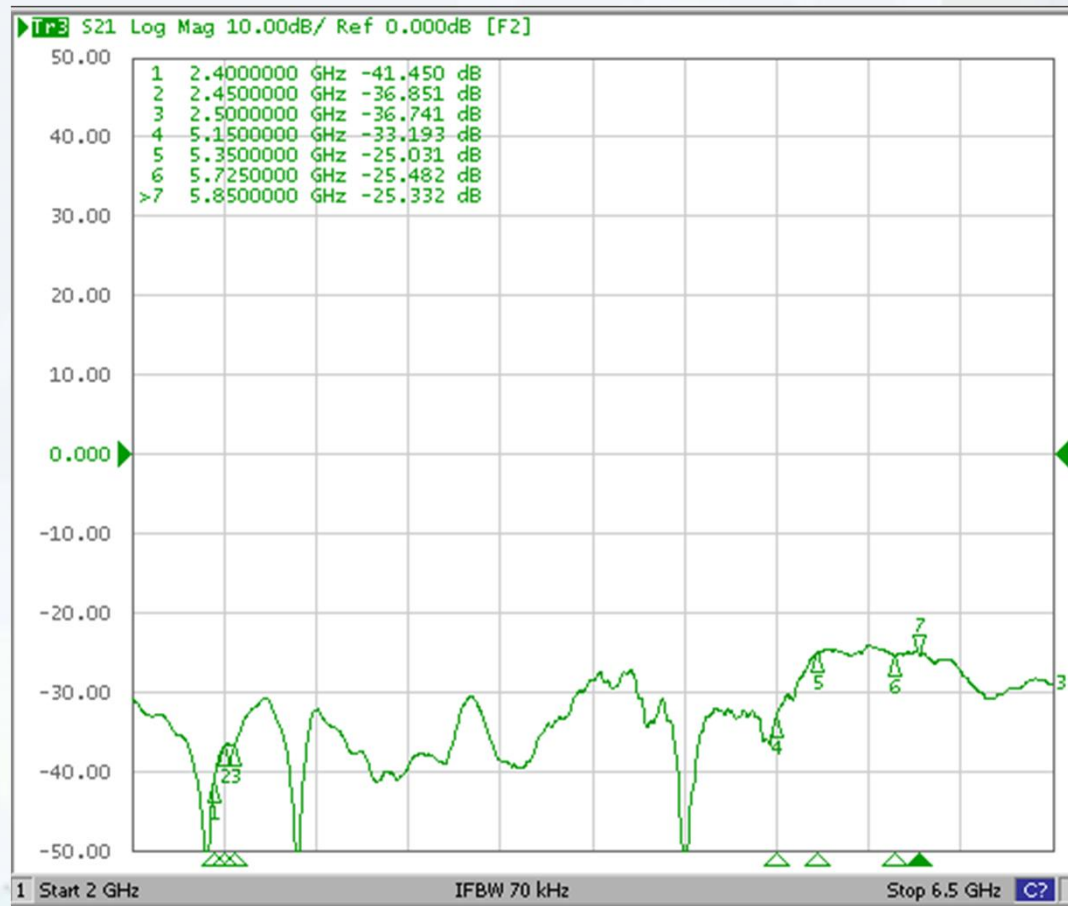

# Isolation Results

ANT3~ANT4(Criterion:>15 dB)

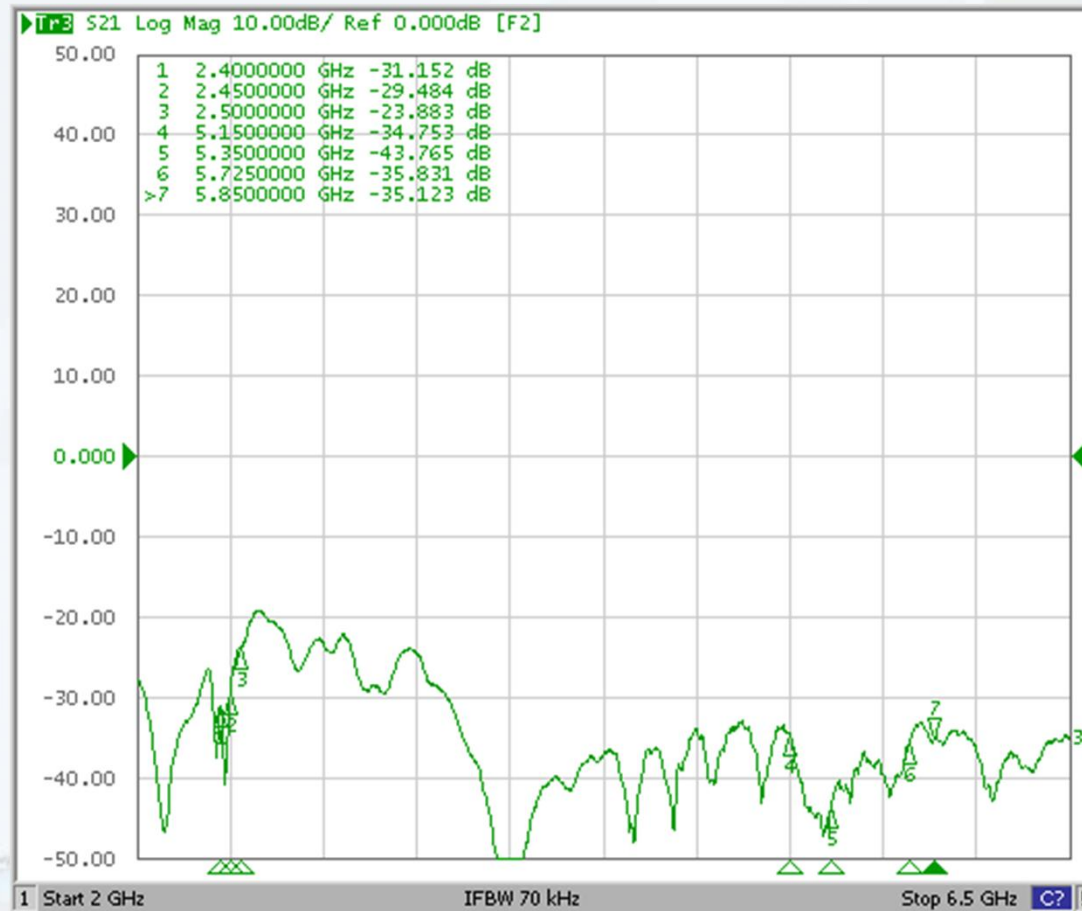



# Test Setup for Radiation Pattern Measurement

## Chamber Information

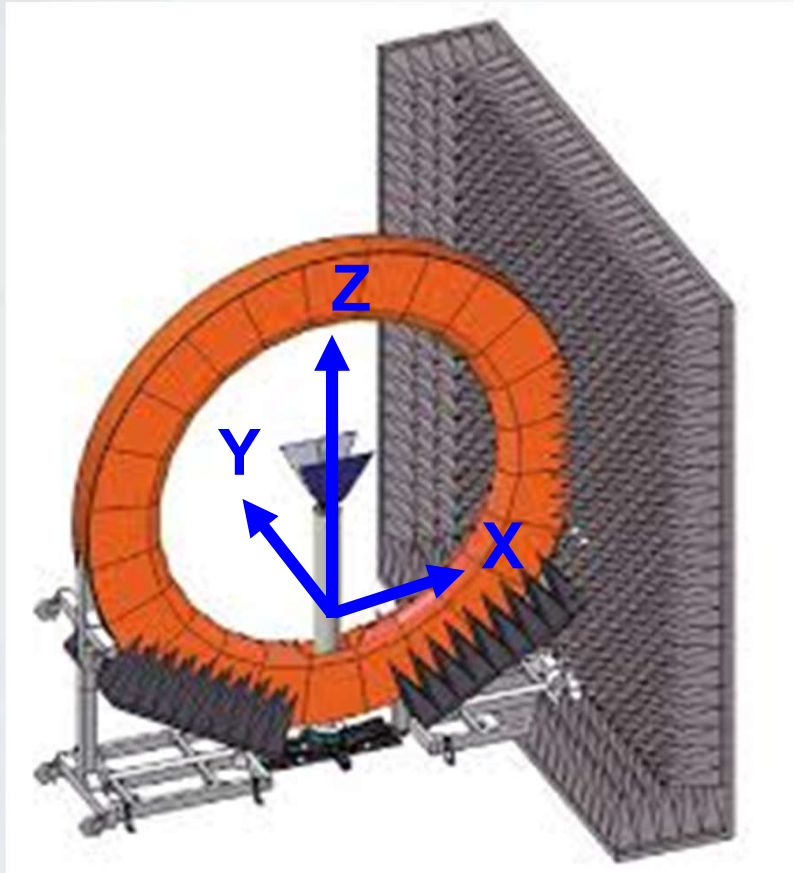

- **SATIMO SG-24L Multi-Probe Antenna Measurement System**

- Angle between probes: 15°
- Frequency range: 400 MHz – 8.5 GHz
- Chamber Room Size: 5m L x 5m W x 5m H

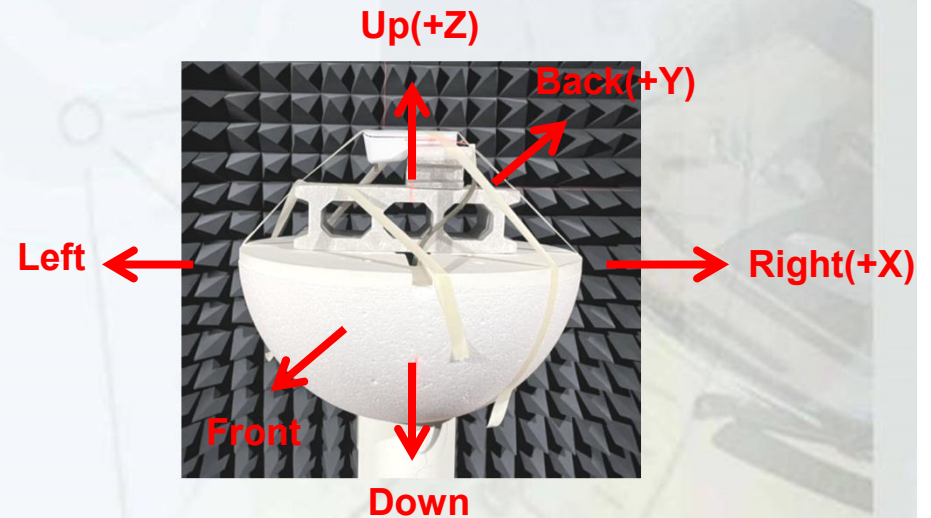

# 2D Radiation Pattern Results

ANT2 – 5G

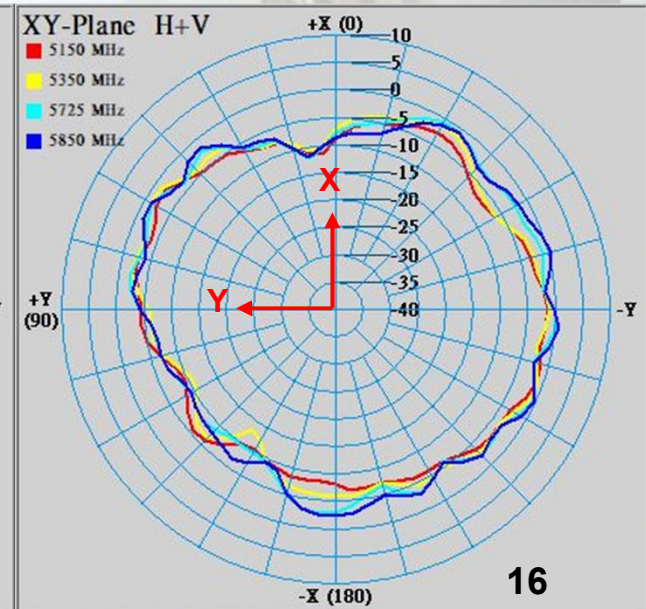
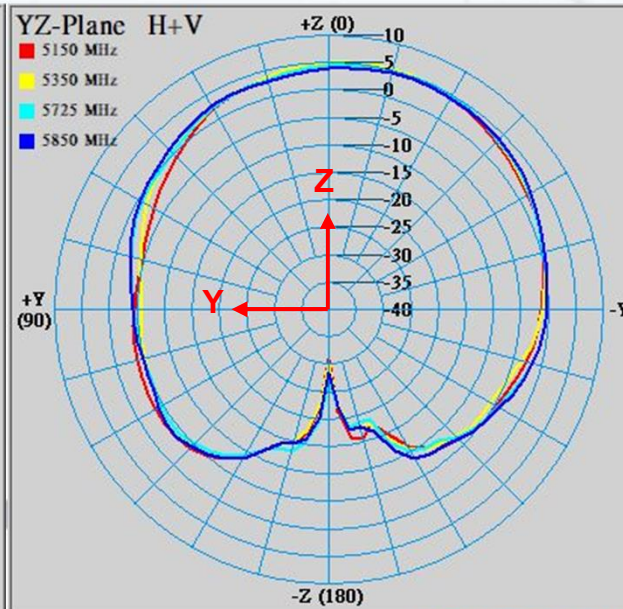
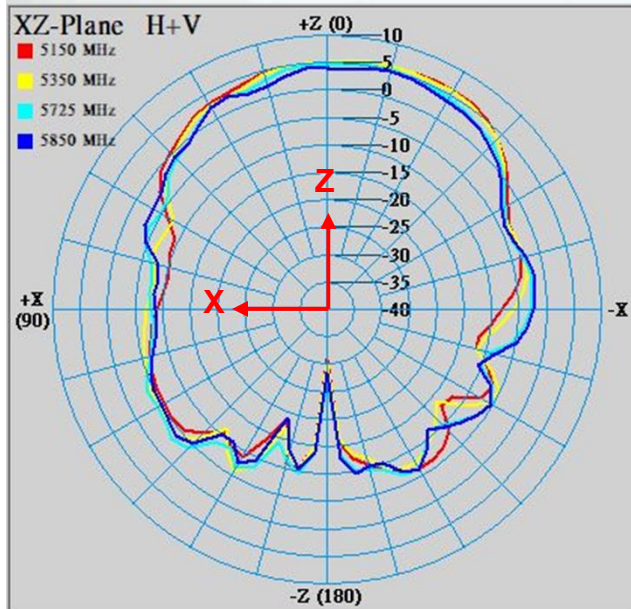
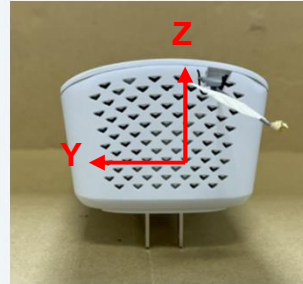

# 2D Radiation Pattern Results

ANT3 – 2G

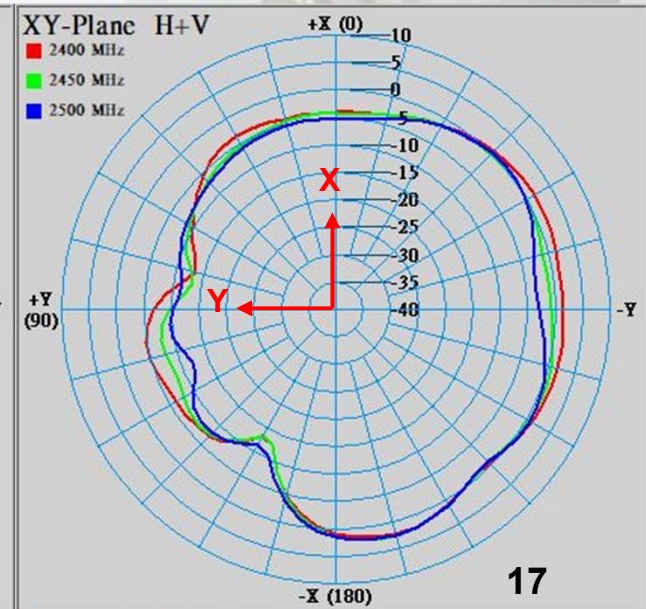
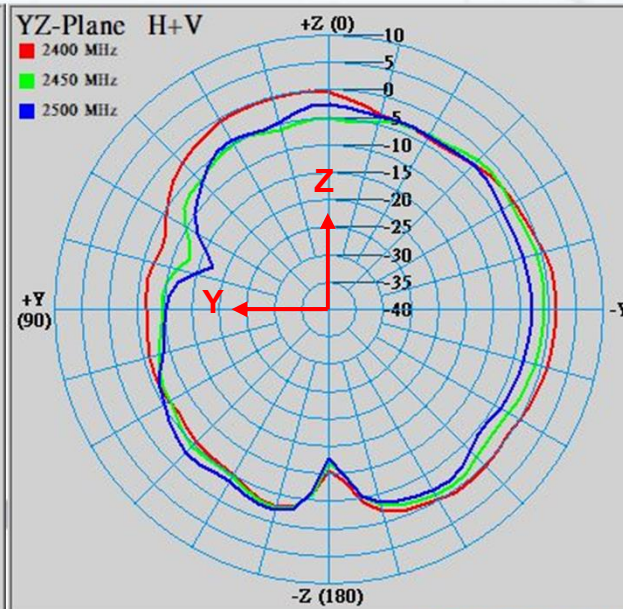
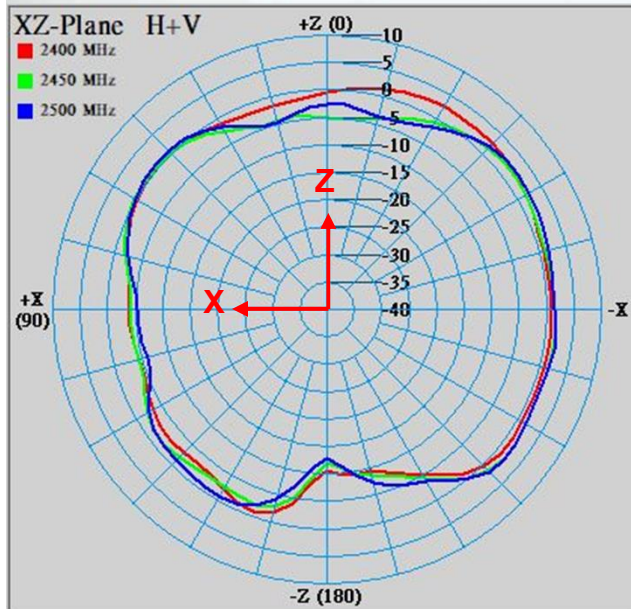
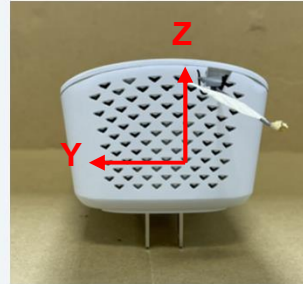

# 2D Radiation Pattern Results

ANT3 – 5G

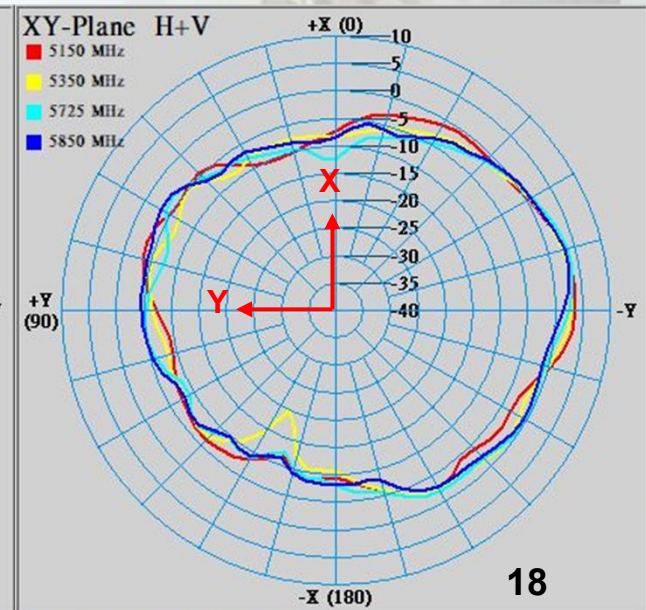
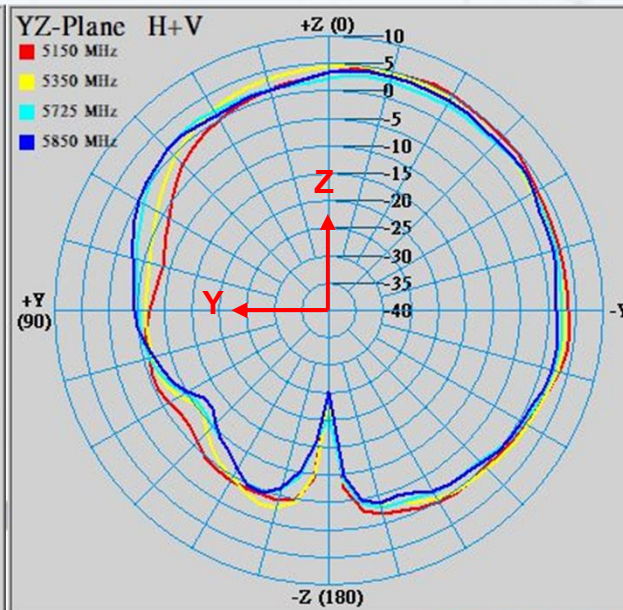
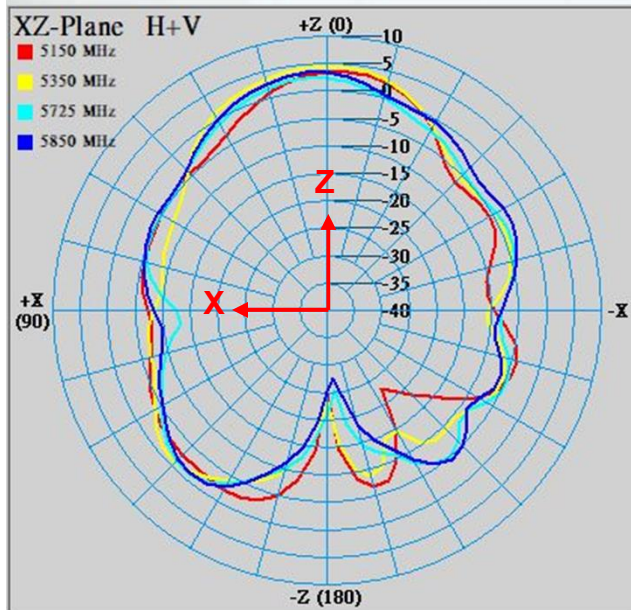
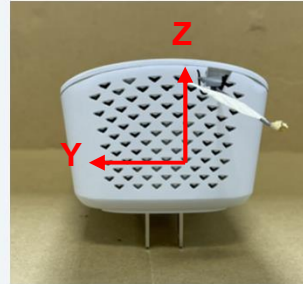

# 2D Radiation Pattern Results

ANT4 - 2G

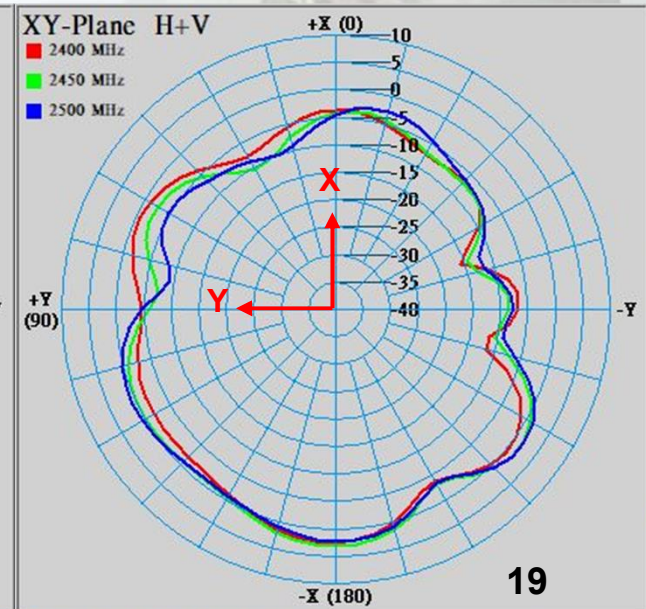
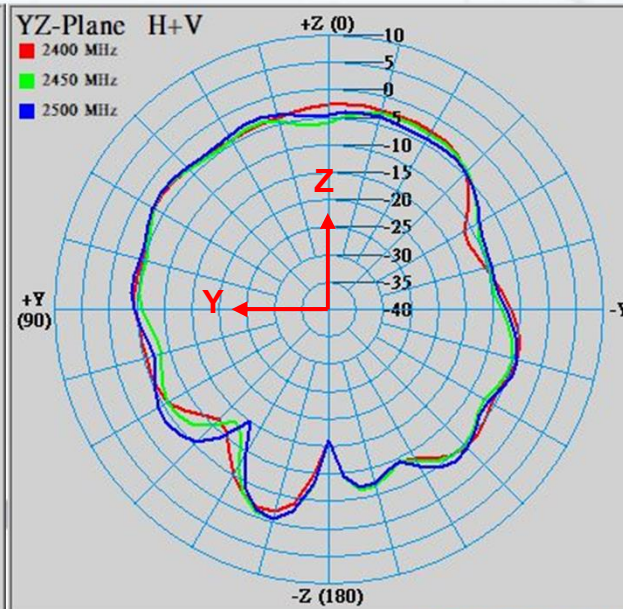
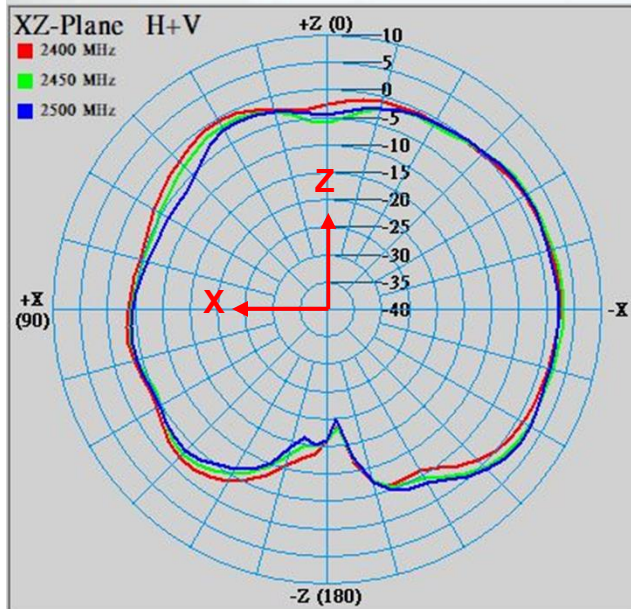
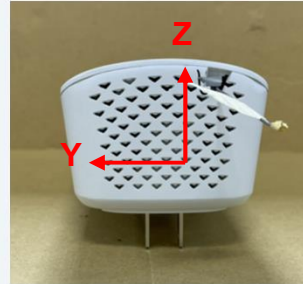

# 2D Radiation Pattern Results

ANT4 – 5G

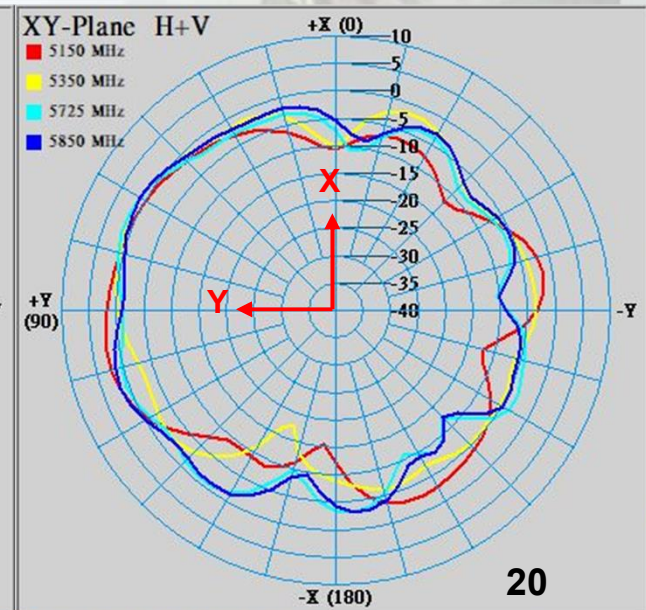
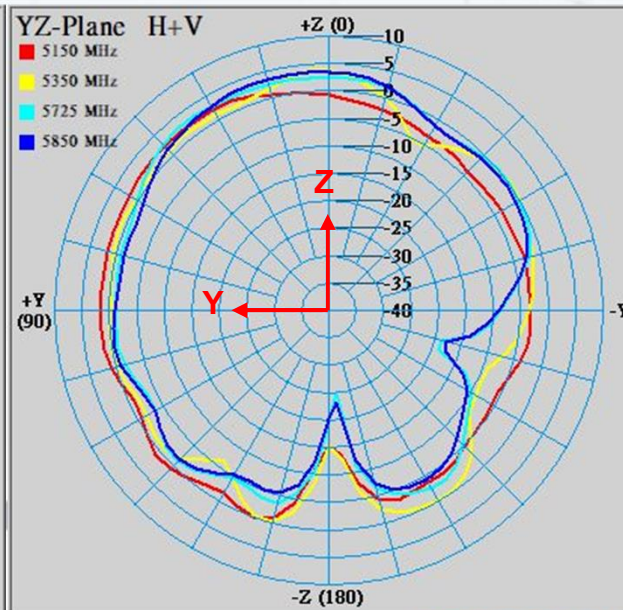
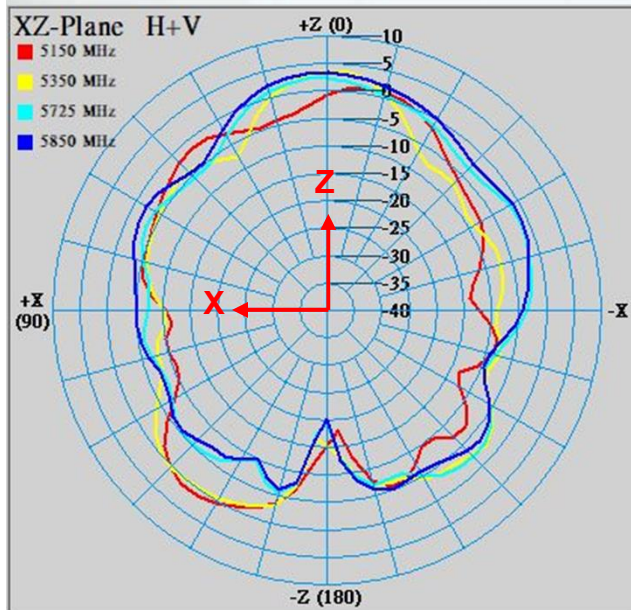
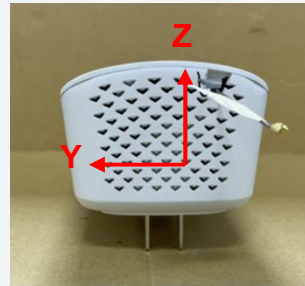

# Results Summary

## Return Loss

Frequency (MHz)	ANT2	ANT3	ANT4
2400 MHz	-	16	10
2450 MHz	-	18	11
2500 MHz	-	13	12
5150 MHz	15	13	12
5350 MHz	21	10	20
5725 MHz	20	10	12
5850 MHz	20	12	12

# Results Summary

## Isolation

	Ant2 to Ant3	Ant2 to Ant4	Ant3 to Ant4
2400 MHz	35	41	31
2450 MHz	35	36	29
2500 MHz	32	36	23
5150MHz	23	33	34
5350 MHz	22	25	43
5725 MHz	20	25	35
5850 MHz	20	25	35



# Results Summary

## Peak gain & Efficiency – Ant2 – 5G

Frequency (MHz)	Peak Gain (dBi)	Efficiency (%)
5150 MHz	6.08	75.74
5350 MHz	6.07	76.23
5725 MHz	5.80	76.50
5850 MHz	5.39	75.88

# Results Summary

## Peak gain & Efficiency – Ant3 – 2/5G

Frequency (MHz)	Peak Gain (dBi)	Efficiency (%)
2400 MHz	2.78	68.92
2450 MHz	2.77	68.97
2500 MHz	2.66	67.96
5150 MHz	5.34	68.42
5350 MHz	5.21	67.29
5725 MHz	4.49	68.53
5850 MHz	5.44	66.04

# Results Summary

## Peak gain & Efficiency – Ant4 – 2/5G

Frequency (MHz)	Peak Gain (dBi)	Efficiency (%)
2400 MHz	2.60	66.58
2450 MHz	3.18	68.46
2500 MHz	2.87	67.26
5150 MHz	3.25	65.73
5350 MHz	3.73	66.99
5725 MHz	3.70	67.77
5850 MHz	3.73	66.55